

FCC SAR EVALUATION REPORT

In accordance with the requirements of
FCC 47 CFR Part 2(2.1093), ANSI/IEEE C95.1-1992 and
IEEE Std 1528-2013

Product Name : Mobile Phone

Trademark : AZUMI

Model Name : V5

Family Model : N/A

Report No. : S19040400601001

FCC ID : QRP-SP-007

Prepared for

Azumi S.A

Avenida Aquilino de la Guardia con Calle 47, PH Ocean Plaza, Piso 16 of. 16-01,
Marbella, Ciudad de Panama, Panama

Prepared by

Shenzhen NTEK Testing Technology Co., Ltd.

1/F, Building E, Fenda Science Park Sanwei, Xixiang, Bao'an District,
Shenzhen, Guangdong, China

Tel.: +86-755-6115 6588 Fax.: +86-755-6115 6599

Website: <http://www.ntek.org.cn>

TEST RESULT CERTIFICATION

Applicant's name.....: Azumi S.A
 Address.....: Avenida Aquilino de la Guardia con Calle 47, PH Ocean Plaza, Piso 16 of. 16-01, Marbella, Ciudad de Panama, Panama
Manufacturer's Name.....: AZUMI HK LTD
 Address.....: FLAT/RM 18 BLK 1 14/F GOLDEN INDUSTRIAL BUILDING 16-26 KWAI TAK STREET KWAI CHUNG,HK

Product description

Product name.....: Mobile Phone
 Trademark: AZUMI
 Model Name: V5
 Family Model.....: N/A
 FCC 47 CFR Part 2(2.1093)

Standards.....: ANSI/IEEE C95.1-1992
 IEEE Std 1528-2013
 Published RF exposure KDB procedures

This device described above has been tested by Shenzhen NTEK. In accordance with the measurement methods and procedures specified in IEEE Std 1528-2013 and KDB 865664 D01. Testing has shown that this device is capable of compliance with localized specific absorption rate (SAR) specified in FCC 47 CFR Part 2(2.1093) and ANSI/IEEE C95.1-1992. The test results in this report apply only to the tested sample of the stated device/equipment. Other similar device/equipment will not necessarily produce the same results due to production tolerance and measurement uncertainties.

This report shall not be reproduced except in full, without the written approval of Shenzhen NTEK, this document may be altered or revised by Shenzhen NTEK, personal only, and shall be noted in the revision of the document.

Date of Test

Date (s) of performance of tests..... : Apr. 10, 2019 ~ Apr. 17, 2019
 Date of Issue : May 06, 2019
 Test Result : **Pass**

Prepared By : Cheng Jiawen
 (Test Engineer) :
 (Cheng Jiawen)

Approved By : Sam. Chen
 (Lab Manager) :
 (Sam Chen)

※ ※ Revision History ※ ※

REV.	DESCRIPTION	ISSUED DATE	REMARK
Rev.1.0	Initial Test Report Release	May 06, 2019	Cheng Jiawen

TABLE OF CONTENTS

1. General Information	6
1.1. RF exposure limits.....	6
1.2. Statement of Compliance	7
1.3. EUT Description	7
1.4. Test specification(s)	9
1.5. Ambient Condition.....	9
2. SAR Measurement System	10
2.1. SATIMO SAR Measurement Set-up Diagram	10
2.2. Robot	11
2.3. E-Field Probe.....	12
2.3.1. E-Field Probe Calibration	12
2.4. SAM phantoms	13
2.4.1. Technical Data	14
2.5. Device Holder	15
2.6. Test Equipment List	16
3. SAR Measurement Procedures	18
3.1. Power Reference	18
3.2. Area scan & Zoom scan.....	18
3.3. Description of interpolation/extrapolation scheme	20
3.4. Volumetric Scan	20
3.5. Power Drift	20
4. System Verification Procedure	21
4.1. Tissue Verification	21
4.1.1. Tissue Dielectric Parameter Check Results	22
4.2. System Verification Procedure	23
4.2.1. System Verification Results.....	24
5. SAR Measurement variability and uncertainty	25
5.1. SAR measurement variability.....	25
5.2. SAR measurement uncertainty	25
6. RF Exposure Positions.....	26
6.1. Ear and handset reference point	26
6.2. Definition of the cheek position	26
6.3. Definition of the tilt position	28
6.4. Body Worn Accessory	28
6.5. Wireless Router Devices	29
7. RF Output Power	30
7.1. GSM Conducted Power	30
7.2. WCDMA Conducted Power	30
7.3. LTE Conducted Power	31

7.4. WLAN & Bluetooth Output Power	41
7.4.1. Output Power Results Of WLAN	41
7.4.2. Output Power Results Of Bluetooth.....	41
8. Antenna Location.....	42
9. Stand-alone SAR test exclusion.....	43
10. SAR Results	44
10.1. SAR measurement results	44
10.1.1. SAR measurement Result of GSM850.....	44
10.1.2. SAR measurement Result of GSM1900.....	44
10.1.3. SAR measurement Result of WCDMA Band V.....	45
10.1.4. SAR measurement Result of WCDMA Band II.....	46
10.1.5. SAR measurement Result of LTE Band V	47
10.1.6. SAR measurement Result of LTE Band IV	49
10.1.7. SAR measurement Result of LTE Band II	51
10.1.8. SAR measurement Result of LTE Band VII	53
10.1.9. SAR measurement Result of WLAN 2.4G	55
10.2. SAR Summation Scenario.....	56
11. Appendix A. Photo documentation	63
12. Appendix B. System Check Plots	64
13. Appendix C. Plots of High SAR Measurement.....	85
14. Appendix D. Calibration Certificate	122

1. General Information

1.1. RF exposure limits

(A).Limits for Occupational/Controlled Exposure (W/kg)

Whole-Body	Partial-Body	Hands, Wrists, Feet and Ankles
0.4	8.0	20.0

(B).Limits for General Population/Uncontrolled Exposure (W/kg)

Whole-Body	Partial-Body	Hands, Wrists, Feet and Ankles
0.08	1.6	4.0

NOTE: **Whole-Body SAR** is averaged over the entire body, **partial-body SAR** is averaged over any 1 gram of tissue defined as a tissue volume in the shape of a cube. **SAR for hands, wrists, feet and ankles** is averaged over any 10 grams of tissue defined as a tissue volume in the shape of a cube.

Occupational/Controlled Environments:

Are defined as locations where there is exposure that may be incurred by people who are aware of the potential for exposure, (i.e. as a result of employment or occupation).

General Population/Uncontrolled Environments:

Are defined as locations where there is the exposure of individuals who have no knowledge or control of their exposure.

NOTE
 HEAD AND TRUNK LIMIT
 1.6 W/kg
 APPLIED TO THIS EUT

1.2. Statement of Compliance

The maximum results of Specific Absorption Rate (SAR) found during testing for V5 are as follows.

Band	Max Reported SAR Value(W/kg)			Max Simultaneous Tx
	1-g Head	1-g Body-Worn (Separation distance of 10mm)	1-g Hotspot (Separation distance of 10mm)	
GSM 850	0.404	0.445	0.445	1.524
GSM 1900	0.324	0.679	0.679	
WCDMA Band V	0.371	0.388	0.388	
WCDMA Band II	0.579	1.096	1.096	
LTE Band V	0.462	0.518	0.518	
LTE Band IV	0.640	1.214	1.214	
LTE Band II	0.720	1.284	1.284	
LTE Band VII	0.146	0.448	0.742	
WLAN 2.4G	0.221	0.252	0.252	

Note: The Max Simultaneous Tx is calculated based on the same configuration and test position. This device is in compliance with Specific Absorption Rate (SAR) for general population/uncontrolled exposure limits (1.6 W/kg) specified in FCC 47 CFR Part 2(2.1093) and ANSI/IEEE C95.1-1992, and had been tested in accordance with the measurement methods and procedures specified in IEEE Std 1528-2013 & KDB 865664 D01.

1.3. EUT Description

Device Information	
Product Name	Mobile Phone
Trade Name	AZUMI
Model Name	V5
Family Model	N/A
FCC ID	QRP-SP-007
Device Phase	Identical Prototype
Exposure Category	General population / Uncontrolled environment
Antenna	PIFA Antenna
Battery Information	DC 3.8V, 2000mAh
Device Operating Configurations	
Supporting Mode(s)	GSM 850/1900, WCDMA Band V/II, LTE Band V/IV/III/VII, WLAN 2.4G, Bluetooth
Test Modulation	GSM(GMSK/8PSK), WCDMA(QPSK), LTE(QPSK/16QAM), WLAN(DSSS/OFDM), Bluetooth(GFSK, π/4-DQPSK, 8DPSK)
Device Class	B

Operating Frequency Range(s)	Band	Tx (MHz)	Rx (MHz)
	GSM 850	824-849	869-894
	GSM 1900	1850-1910	1930-1990
	WCDMA Band V	824-849	869-894
	WCDMA Band II	1850-1910	1930-1990
	LTE Band V	824-849	869-894
	LTE Band IV	1710-1755	2110-2155
	LTE Band II	1850-1910	1930-1990
	LTE Band VII	2500-2570	2620-2690
	WLAN 2.4G	2412-2462	
	Bluetooth	2402-2480	
GPRS Multislot Class(12)	Max Number of Timeslots in Uplink		4
	Max Number of Timeslots in Downlink		4
	Max Total Timeslot		5
EDGE Multislot Class(12)	Max Number of Timeslots in Uplink		4
	Max Number of Timeslots in Downlink		4
	Max Total Timeslot		5
Power Class	4, tested with power level 5(GSM 850)		
	1, tested with power level 0(GSM 1900)		
	3, tested with power control "all 1"(WCDMA Band V)		
	3, tested with power control "all 1"(WCDMA Band II)		
	3, tested with power control all Max.(LTE Band V)		
	3, tested with power control all Max.(LTE Band IV)		
	3, tested with power control all Max.(LTE Band II)		
	3, tested with power control all Max.(LTE Band VII)		
Test Channels (low-mid-high)	128-189-251(GSM 850)		
	512-661-810(GSM 1900)		
	4132-4182-4233(WCDMA Band V)		
	9262-9400-9538(WCDMA Band II)		
	20407-20525-20643(LTE Band V BW=1.4MHz)		
	20415-20525-20635(LTE Band V BW=3MHz)		
	20425-20525-20625(LTE Band V BW=5MHz)		
	20450-20525-20600(LTE Band V BW=10MHz)		
	19957-20175-20393(LTE Band IV BW=1.4MHz)		
	19965-20175-20385(LTE Band IV BW=3MHz)		
	19975-20175-20375(LTE Band IV BW=5MHz)		
	20000-20175-20350(LTE Band IV BW=10MHz)		
	20025-20175-20325(LTE Band IV BW=15MHz)		
	20050-20175-20300(LTE Band IV BW=20MHz)		
18607-18900-19193(LTE Band II BW=1.4MHz)			

	18615-18900-19185(LTE Band II BW=3MHz)
	18625-18900-19175(LTE Band II BW=5MHz)
	18650-18900-19150(LTE Band II BW=10MHz)
	18675-18900-19125(LTE Band II BW=15MHz)
	18700-18900-19100(LTE Band II BW=20MHz)
	20775-21100-21425(LTE Band VII BW=5MHz)
	20800-21100-21400(LTE Band VII BW=10MHz)
	20825-21100-21375(LTE Band VII BW=15MHz)
	20850-21100-21350(LTE Band VII BW=20MHz)
	1-6-11(WLAN 2.4G)

1.4. Test specification(s)

FCC 47 CFR Part 2(2.1093)
ANSI/IEEE C95.1-1992
IEEE Std 1528-2013
KDB 865664 D01 SAR measurement 100 MHz to 6 GHz
KDB 865664 D02 RF Exposure Reporting
KDB 447498 D01 General RF Exposure Guidance
KDB 248227 D01 802.11 Wi-Fi SAR
KDB 941225 D01 3G SAR Procedures
KDB 941225 D05 SAR for LTE Devices
KDB 941225 D06 Hotspot SAR
KDB 648474 D04 Handset SAR

1.5. Ambient Condition

Ambient temperature	20°C – 24°C
Relative Humidity	30% – 70%

2. SAR Measurement System

2.1. SATIMO SAR Measurement Set-up Diagram

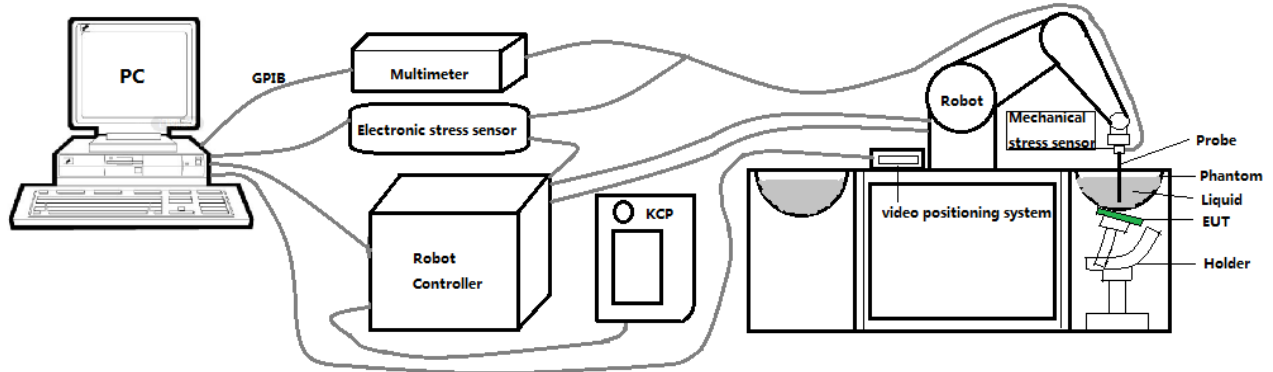

These measurements were performed with the automated near-field scanning system OPENSAR from SATIMO. The system is based on a high precision robot (working range: 901 mm), which positions the probes with a positional repeatability of better than ± 0.03 mm. The SAR measurements were conducted with dosimetric probe (manufactured by SATIMO), designed in the classical triangular configuration and optimized for dosimetric evaluation.

The first step of the field measurement is the evaluation of the voltages induced on the probe by the device under test. Probe diode detectors are nonlinear. Below the diode compression point, the output voltage is proportional to the square of the applied E-field; above the diode compression point, it is linear to the applied E-field. The compression point depends on the diode, and a calibration procedure is necessary for each sensor of the probe.

The Keithley multimeter reads the voltage of each sensor and send these three values to the PC. The corresponding E field value is calculated using the probe calibration factors, which are stored in the working directory. This evaluation includes linearization of the diode characteristics. The field calculation is done separately for each sensor. Each component of the E field is displayed on the "Dipole Area Scan Interface" and the total E field is displayed on the "3D Interface"

2.2. Robot

The SATIMO SAR system uses the high precision robots from KUKA. For the 6-axis controller system, the robot controller version (KUKA) from KUKA is used. The KUKA robot series have many features that are important for our application:



- High precision (repeatability ± 0.03 mm)
- High reliability (industrial design)
- Jerk-free straight movements
- Low ELF interference (the closed metallic construction shields against motor control fields)

2.3. E-Field Probe

This E-field detection probe is composed of three orthogonal dipoles linked to special Schottky diodes with low detection thresholds. The probe allows the measurement of electric fields in liquids such as the one defined in the IEEE and CENELEC standards.

For the measurements the Specific Dosimetric E-Field Probe SN 08/16 EPGO287 with following specifications is used



- Dynamic range: 0.01-100 W/kg
 - Tip Diameter: 2.5 mm
 - Distance between probe tip and sensor center: 1 mm
 - Distance between sensor center and the inner phantom surface: 2 mm (repeatability better than ± 1 mm).
 - Probe linearity: ± 0.08 dB
 - Axial isotropy: 0.06 dB
 - Hemispherical Isotropy: 0.08 dB
 - Calibration range: 650MHz to 5900MHz for head & body simulating liquid.
 - Lower detection limit: 7mW/kg
- Angle between probe axis (evaluation axis) and surface normal line: less than 30° .

2.3.1. E-Field Probe Calibration

Each probe needs to be calibrated according to a dosimetric assessment procedure with accuracy better than $\pm 10\%$. The spherical isotropy shall be evaluated and within ± 0.25 dB. The sensitivity parameters (Norm X, Norm Y, and Norm Z), the diode compression parameter (DCP) and the conversion factor (Conv F) of the probe are tested. The calibration data can be referred to appendix D of this report.

2.4. SAM phantoms

Photo of SAM phantom SN 16/15 SAM119



The SAM phantom is used to measure the SAR relative to people exposed to electro-magnetic field radiated by mobile phones.

2.4.1. Technical Data

Serial Number	Shell thickness	Filling volume	Dimensions	Positionner Material	Permittivity	Loss Tangent
SN 16/15 SAM119	2 mm ±0.2 mm	27 liters	Length:1000 mm Width:500 mm Height:200 mm	Gelcoat with fiberglass	3.4	0.02

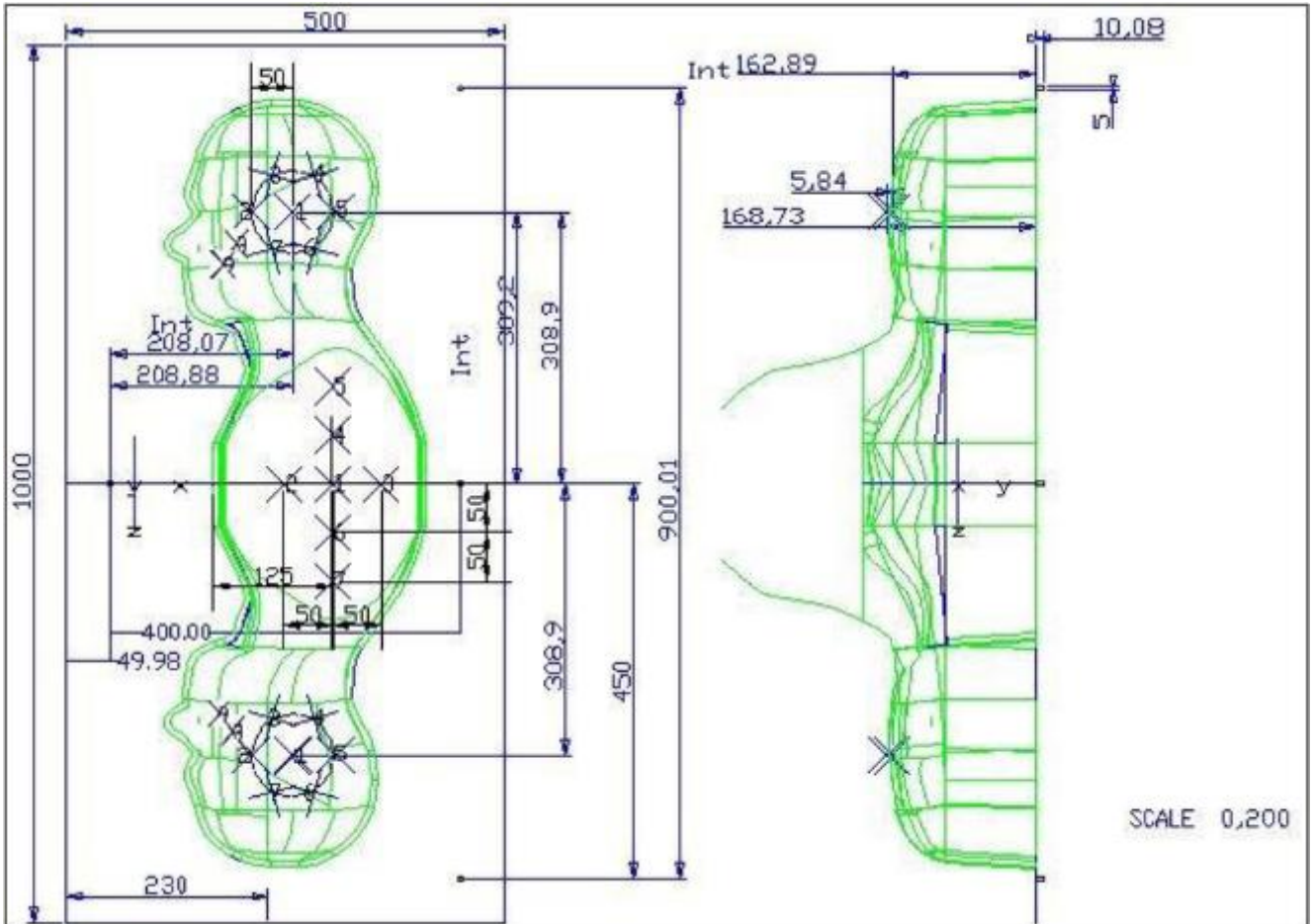

Serial Number	Left Head(mm)		Right Head(mm)		Flat Part(mm)	
	1	2	1	2	1	2
SN 16/15 SAM119	2	2.02	2	2.08	1	2.09
	3	2.05	3	2.06	2	2.06
	4	2.07	4	2.07	3	2.08
	5	2.08	5	2.08	4	2.10
	6	2.05	6	2.07	5	2.10
	7	2.05	7	2.05	6	2.07
	8	2.07	8	2.06	7	2.07
	9	2.08	9	2.06	-	-

The test, based on ultrasonic system, allows measuring the thickness with an accuracy of 10 µm.

2.5. Device Holder

The positioning system allows obtaining cheek and tilting position with a very good accuracy. In compliance with CENELEC, the tilt angle uncertainty is lower than 1 degree.

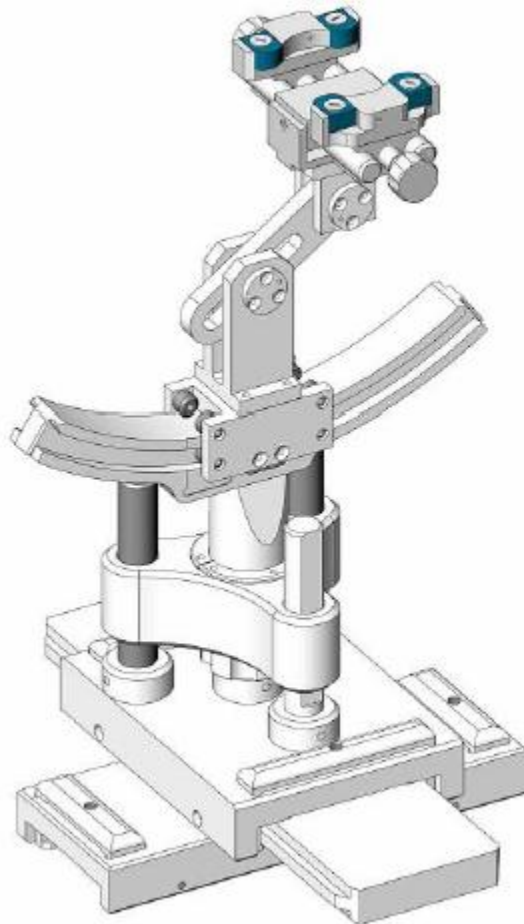

Serial Number	Holder Material	Permittivity	Loss Tangent
SN 16/15 MSH100	Delrin	3.7	0.005

2.6. Test Equipment List

This table gives a complete overview of the SAR measurement equipment.

Devices used during the test described are marked

	Manufacturer	Name of Equipment	Type/Model	Serial Number	Calibration	
					Last Cal.	Due Date
<input checked="" type="checkbox"/>	MVG	E FIELD PROBE	SSE2	SN 08/16 EPGO287	Sep. 17, 2018	Sep. 16, 2019
<input type="checkbox"/>	MVG	750 MHz Dipole	SID750	SN 03/15 DIP 0G750-355	Apr. 19, 2018	Apr. 18, 2021
<input checked="" type="checkbox"/>	MVG	835 MHz Dipole	SID835	SN 03/15 DIP 0G835-347	Apr. 19, 2018	Apr. 18, 2021
<input type="checkbox"/>	MVG	900 MHz Dipole	SID900	SN 03/15 DIP 0G900-348	Apr. 19, 2018	Apr. 18, 2021
<input checked="" type="checkbox"/>	MVG	1800 MHz Dipole	SID1800	SN 03/15 DIP 1G800-349	Apr. 19, 2018	Apr. 18, 2021
<input checked="" type="checkbox"/>	MVG	1900 MHz Dipole	SID1900	SN 03/15 DIP 1G900-350	Apr. 19, 2018	Apr. 18, 2021
<input type="checkbox"/>	MVG	2000 MHz Dipole	SID2000	SN 03/15 DIP 2G000-351	Apr. 19, 2018	Apr. 18, 2021
<input checked="" type="checkbox"/>	MVG	2450 MHz Dipole	SID2450	SN 03/15 DIP 2G450-352	Apr. 19, 2018	Apr. 18, 2021
<input checked="" type="checkbox"/>	MVG	2600 MHz Dipole	SID2600	SN 03/15 DIP 2G600-356	Apr. 19, 2018	Apr. 18, 2021
<input type="checkbox"/>	MVG	5000 MHz Dipole	SWG5500	SN 13/14 WGA 33	Apr. 19, 2018	Apr. 18, 2021
<input checked="" type="checkbox"/>	MVG	Liquid measurement Kit	SCLMP	SN 21/15 OCPG 72	NCR	NCR
<input checked="" type="checkbox"/>	MVG	Power Amplifier	N.A	AMPLISAR_28/14_003	NCR	NCR
<input checked="" type="checkbox"/>	KEITHLEY	Millivoltmeter	2000	4072790	NCR	NCR
<input checked="" type="checkbox"/>	R&S	Universal radio communication tester	CMU200	117858	Aug. 05, 2018	Aug. 04, 2019
<input checked="" type="checkbox"/>	R&S	Wideband radio communication tester	CMW500	103917	Oct. 08, 2018	Oct. 07, 2019
<input checked="" type="checkbox"/>	HP	Network Analyzer	8753D	3410J01136	Aug. 05, 2018	Aug. 04, 2019
<input checked="" type="checkbox"/>	Agilent	PSG Analog Signal Generator	E8257D	MY51110112	Aug. 05, 2018	Aug. 04, 2019

<input checked="" type="checkbox"/>	Agilent	Power meter	E4419B	MY45102538	Aug. 05, 2018	Aug. 04, 2019
<input checked="" type="checkbox"/>	Agilent	Power sensor	E9301A	MY41495644	Aug. 05, 2018	Aug. 04, 2019
<input checked="" type="checkbox"/>	Agilent	Power sensor	E9301A	US39212148	Aug. 05, 2018	Aug. 04, 2019
<input checked="" type="checkbox"/>	MCLI/USA	Directional Coupler	CB11-20	0D2L51502	Aug. 05, 2018	Aug. 04, 2019

3. SAR Measurement Procedures

The measurement procedures are as follows:

<Conducted power measurement>

- (a) For WWAN power measurement, use base station simulator to configure EUT WWAN transmission in conducted connection with RF cable, at maximum power in each supported wireless interface and frequency band.
- (b) Read the WWAN RF power level from the base station simulator.
- (c) For WLAN/Bluetooth power measurement, use engineering software to configure EUT WLAN/Bluetooth continuously transmission, at maximum RF power in each supported wireless interface and frequency band.
- (d) Connect EUT RF port through RF cable to the power meter, and measure WLAN/Bluetooth output power.

<SAR measurement>

- (a) Use base station simulator to configure EUT WWAN transmission in radiated connection, and engineering software to configure EUT WLAN/Bluetooth continuously transmission, at maximum RF power, in the highest power channel.
- (b) Place the EUT in the positions as Appendix A demonstrates.
- (c) Set scan area, grid size and other setting on the OPENSAR software.
- (d) Measure SAR results for the highest power channel on each testing position.
- (e) Find out the largest SAR result on these testing positions of each band.
- (f) Measure SAR results for other channels in worst SAR testing position if the reported SAR of highest power channel is larger than 0.8 W/kg.

According to the test standard, the recommended procedure for assessing the peak spatial-average SAR value consists of the following steps:

- (a) Power reference measurement
- (b) Area scan
- (c) Zoom scan
- (d) Power drift measurement

3.1. Power Reference

The Power Reference Measurement and Power Drift Measurements are for monitoring the power drift of the device under test in the batch process. The minimum distance of probe sensors to surface determines the closest measurement point to phantom surface. This distance cannot be smaller than the distance of sensor calibration points to probe tip as defined in the probe properties.

3.2. Area scan & Zoom scan

The area scan is a 2D scan to find the hot spot location on the DUT. The zoom scan is a 3D scan above the hot spot to calculate the 1g and 10g SAR value.

Measurement of the SAR distribution with a grid of 8 to 16 mm * 8 to 16 mm and a constant distance to the inner surface of the phantom. Since the sensors cannot directly measure at the inner phantom surface, the values between the sensors and the inner phantom surface are extrapolated. With these values the area of the maximum SAR is calculated by an interpolation scheme. Around this point, a cube of 30 * 30 * 30 mm or 32 * 32 * 32 mm is assessed by measuring 5 or 8 * 5 or 8 * 4 or 5 mm. With these data, the peak spatial-average SAR value can be calculated.

From the scanned SAR distribution, identify the position of the maximum SAR value, in addition identify the positions of any local maxima with SAR values within 2 dB of the maximum value that will not be within the zoom scan of other peaks; additional peaks shall be measured only when the primary peak is within 2 dB of the SAR compliance limit (e.g., 1 W/kg for 1,6 W/kg 1 g limit, or 1,26 W/kg for 2 W/kg, 10 g limit).

Area scan & Zoom scan scan parameters extracted from FCC KDB 865664 D01 SAR measurement 100 MHz to 6 GHz.

		≤ 3 GHz	> 3 GHz
Maximum distance from closest measurement point (geometric center of probe sensors) to phantom surface		5 ± 1 mm	$\frac{1}{2} \cdot \delta \cdot \ln(2) \pm 0.5$ mm
Maximum probe angle from probe axis to phantom surface normal at the measurement location		$30^\circ \pm 1^\circ$	$20^\circ \pm 1^\circ$
Maximum area scan spatial resolution: Δx_{Area} , Δy_{Area}		≤ 2 GHz: ≤ 15 mm 2 – 3 GHz: ≤ 12 mm	3 – 4 GHz: ≤ 12 mm 4 – 6 GHz: ≤ 10 mm
		When the x or y dimension of the test device, in the measurement plane orientation, is smaller than the above, the measurement resolution must be \leq the corresponding x or y dimension of the test device with at least one measurement point on the test device.	
Maximum zoom scan spatial resolution: Δx_{Zoom} , Δy_{Zoom}		≤ 2 GHz: ≤ 8 mm 2 – 3 GHz: ≤ 5 mm*	3 – 4 GHz: ≤ 5 mm* 4 – 6 GHz: ≤ 4 mm*
Maximum zoom scan spatial resolution, normal to phantom surface	uniform grid: $\Delta z_{Zoom}(n)$	≤ 5 mm	3 – 4 GHz: ≤ 4 mm 4 – 5 GHz: ≤ 3 mm 5 – 6 GHz: ≤ 2 mm
	graded grid	$\Delta z_{Zoom}(1)$: between 1 st two points closest to phantom surface	≤ 4 mm
		$\Delta z_{Zoom}(n>1)$: between subsequent points	$\leq 1.5 \cdot \Delta z_{Zoom}(n-1)$
Minimum zoom scan volume	x, y, z	≥ 30 mm	3 – 4 GHz: ≥ 28 mm 4 – 5 GHz: ≥ 25 mm 5 – 6 GHz: ≥ 22 mm

Note: δ is the penetration depth of a plane-wave at normal incidence to the tissue medium; see draft standard IEEE P1528-2011 for details.

* When zoom scan is required and the *reported* SAR from the *area scan based 1-g SAR estimation* procedures of KDB 447498 is ≤ 1.4 W/kg, ≤ 8 mm, ≤ 7 mm and ≤ 5 mm zoom scan resolution may be applied, respectively, for 2 GHz to 3 GHz, 3 GHz to 4 GHz and 4 GHz to 6 GHz.

3.3. Description of interpolation/extrapolation scheme

The local SAR inside the phantom is measured using small dipole sensing elements inside a probe body. The probe tip must not be in contact with the phantom surface in order to minimise measurements errors, but the highest local SAR will occur at the surface of the phantom.

An extrapolation is used to determine these highest local SAR values. The extrapolation is based on a fourth-order least-square polynomial fit of measured data. The local SAR value is then extrapolated from the liquid surface with a 1 mm step.

The measurements have to be performed over a limited time (due to the duration of the battery) so the step of measurement is high. It could vary between 5 and 8 mm. To obtain an accurate assessment of the maximum SAR averaged over 10 grams and 1 gram requires a very fine resolution in the three dimensional scanned data array.

3.4. Volumetric Scan

The volumetric scan consists of a full 3D scan over a specific area. This 3D scan is useful for multi Tx SAR measurement. Indeed, it is possible with OpenSAR to add, point by point, several volumetric scans to calculate the SAR value of the combined measurement as it is defined in the standard IEEE1528 and IEC62209.

3.5. Power Drift

All SAR testing is under the EUT installed with a full charged battery and transmit maximum output power. In OpenSAR measurement software, the power reference measurement and power drift measurement procedures are used for monitoring the power drift of EUT during SAR test. Both these procedures measure the field at a specified reference position before and after the SAR testing. The software will calculate the field difference in V/m. If the power drifts more than $\pm 5\%$, the SAR will be retested.

4. System Verification Procedure

4.1. Tissue Verification

The following tissue formulations are provided for reference only as some of the parameters have not been thoroughly verified. The composition of ingredients may be modified accordingly to achieve the desired target tissue parameters required for routine SAR evaluation.

Ingredients (% of weight)	Head Tissue									
	750	835	900	1800	1900	2000	2450	2600	5200	5800
Frequency Band (MHz)										
Water	34.40	34.40	34.40	55.36	55.36	57.87	57.87	57.87	65.53	65.53
NaCl	0.79	0.79	0.79	0.35	0.35	0.16	0.16	0.16	0.00	0.00
1,2-Propanediol	64.81	64.81	64.81	0.00	0.00	0.00	0.00	0.00	0.00	0.00
Triton X-100	0.00	0.00	0.00	30.45	30.45	19.97	19.97	19.97	24.24	24.24
DGBE	0.00	0.00	0.00	13.84	13.84	22.00	22.00	22.00	10.23	10.23
Ingredients (% of weight)	Body Tissue									
	750	835	900	1800	1900	2000	2450	2600	5200	5800
Frequency Band (MHz)										
Water	50.30	50.30	50.30	69.91	69.91	71.88	71.88	71.88	79.54	79.54
NaCl	0.60	0.60	0.60	0.13	0.13	0.16	0.16	0.16	0.00	0.00
1,2-Propanediol	49.10	49.10	49.10	0.00	0.00	0.00	0.00	0.00	0.00	0.00
Triton X-100	0.00	0.00	0.00	9.99	9.99	19.97	19.97	19.97	11.24	11.24
DGBE	0.00	0.00	0.00	19.97	19.97	7.99	7.99	7.99	9.22	9.22

For SAR measurement of the field distribution inside the phantom, the phantom must be filled with homogeneous tissue simulating liquid to a depth of at least 15 cm. For head SAR testing, the liquid depth from the ear reference point (ERP) of the phantom to the liquid top surface is larger than 15 cm.

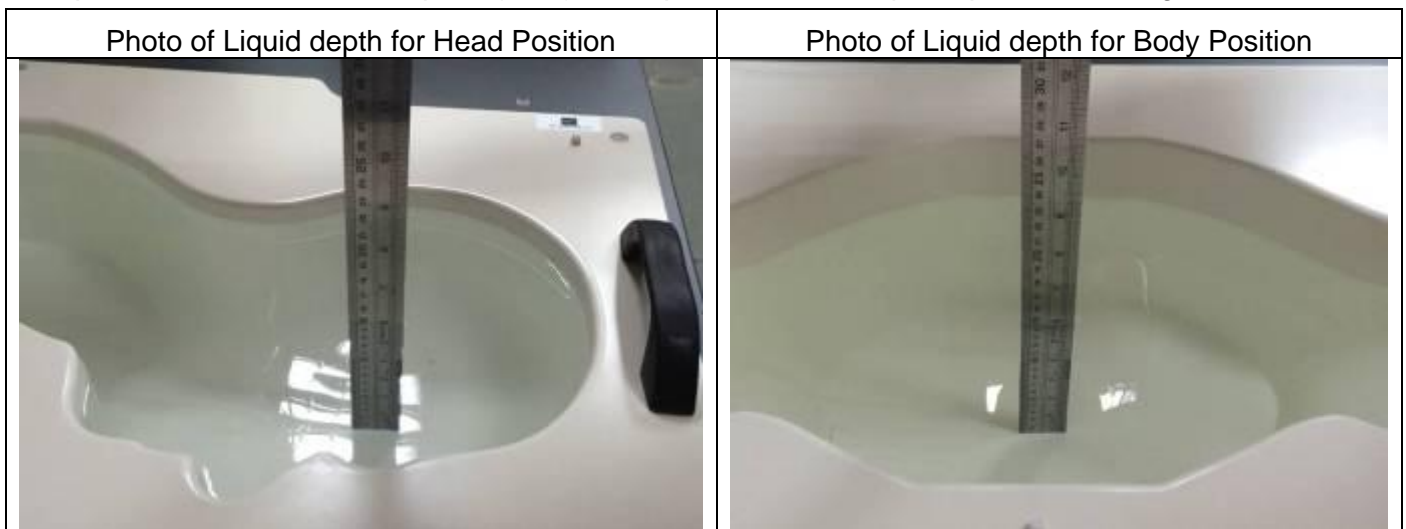

4.1.1. Tissue Dielectric Parameter Check Results

The simulating liquids should be checked at the beginning of a series of SAR measurements to determine if the dielectric parameters are within the tolerances of the specified target values. The measured conductivity and relative permittivity should be within $\pm 5\%$ of the target values.

Tissue Type	Measured Frequency (MHz)	Target Tissue		Measured Tissue		Liquid Temp.	Test Date
		ϵ_r ($\pm 5\%$)	σ (S/m) ($\pm 5\%$)	ϵ_r	σ (S/m)		
Head 850	835	41.50 (39.43~43.57)	0.90 (0.86~0.94)	41.35	0.92	21.4 °C	Apr. 12, 2019
Body 850	835	55.20 (52.44~57.96)	0.97 (0.92~1.01)	54.82	1.00	21.3 °C	Apr. 10, 2019
Head 1800	1800	40.00 (38.00~42.00)	1.40 (1.33~1.47)	39.52	1.40	21.7 °C	Apr. 11, 2019
Body 1800	1800	53.30 (50.64~55.96)	1.52 (1.44~1.59)	53.72	1.53	21.5 °C	Apr. 11, 2019
Head 1900	1900	40.00 (38.00~42.00)	1.40 (1.33~1.47)	41.41	1.44	21.6 °C	Apr. 16, 2019
Body 1900	1900	53.30 (50.64~55.96)	1.52 (1.44~1.59)	53.06	1.55	21.4 °C	Apr. 16, 2019
Head 2450	2450	39.20 (37.24~41.16)	1.80 (1.71~1.89)	39.71	1.83	21.4 °C	Apr. 15, 2019
Body 2450	2450	52.70 (50.07~55.33)	1.95 (1.85~2.04)	52.56	1.99	21.5 °C	Apr. 17, 2019
Head 2600	2600	39.00 (37.05~40.95)	1.96 (1.86~2.05)	38.82	1.99	21.5 °C	Apr. 13, 2019
Body 2600	2600	52.50 (49.88~55.13)	2.16 (2.05~2.27)	52.97	2.18	21.6 °C	Apr. 17, 2019

NOTE: The dielectric parameters of the tissue-equivalent liquid should be measured under similar ambient conditions and within 2 °C of the conditions expected during the SAR evaluation to satisfy protocol requirements.

4.2. System Verification Procedure

The system verification is performed for verifying the accuracy of the complete measurement system and performance of the software. The dipole is connected to the signal source consisting of signal generator and amplifier via a directional coupler, N-connector cable and adaption to SMA. It is fed with a power of 100mW (below 5GHz) or 100mW (above 5GHz). To adjust this power a power meter is used. The power sensor is connected to the cable before the system verification to measure the power at this point and do adjustments at the signal generator. At the outputs of the directional coupler both return loss as well as forward power are controlled during the system verification to make sure that emitted power at the dipole is kept constant. This can also be checked by the power drift measurement after the test (result on plot).

The system verification is shown as below picture:

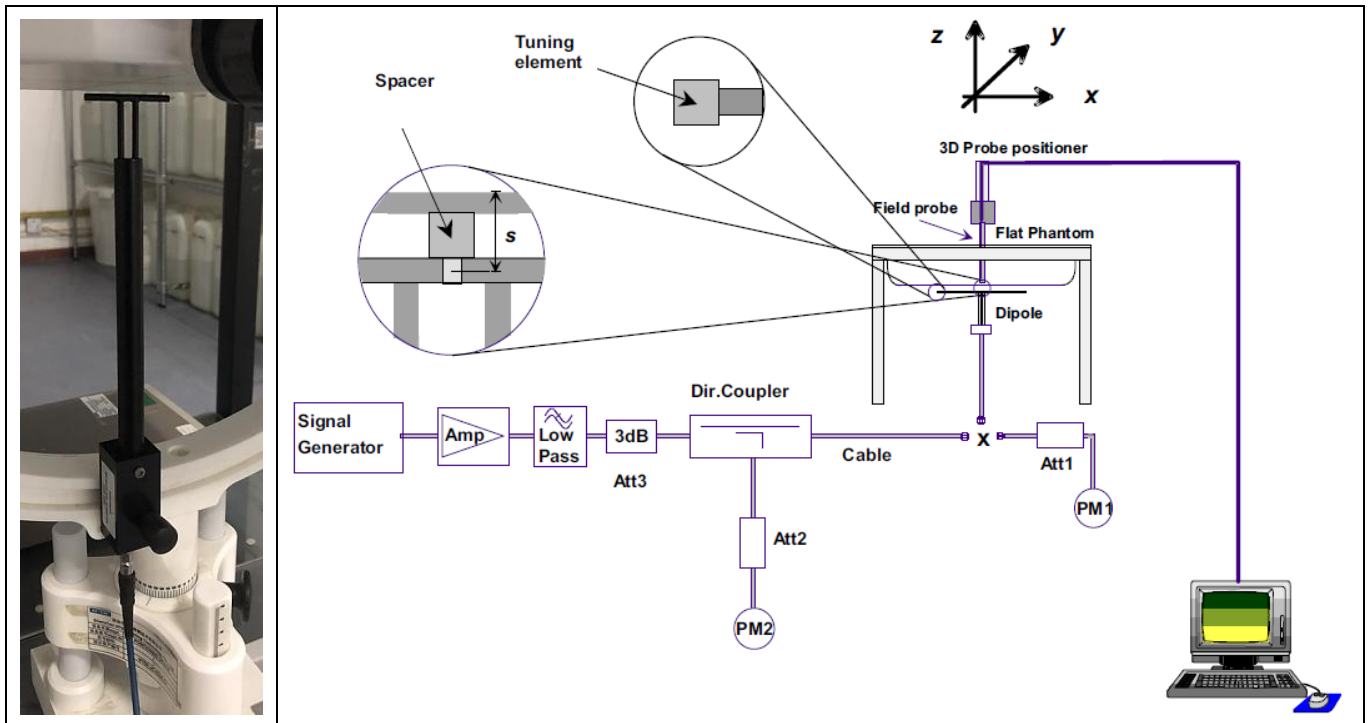

4.2.1. System Verification Results

Comparing to the original SAR value provided by SATIMO, the verification data should be within its specification of $\pm 10\%$. Below table shows the target SAR and measured SAR after normalized to 1W input power. The table below indicates the system performance verification can meet the variation criterion and the plots can be referred to Appendix B of this report.

System Verification	Target SAR (1W) ($\pm 10\%$)		Measured SAR (Normalized to 1W)		Liquid Temp.	Test Date
	1-g (W/Kg)	10-g (W/Kg)	1-g (W/Kg)	10-g (W/Kg)		
835MHz Head	9.56 (8.60~10.51)	6.22 (5.60~6.84)	9.72	6.11	21.4 °C	Apr. 12, 2019
835MHz Body	9.48 (8.53~10.42)	6.29 (5.66~6.91)	9.71	6.45	21.3 °C	Apr. 10, 2019
1800MHz Head	38.40 (34.56~42.24)	20.10 (18.09~22.11)	39.10	20.72	21.7 °C	Apr. 11, 2019
1800MHz Body	37.04 (33.34~40.74)	20.26 (18.23~22.29)	36.79	19.23	21.5 °C	Apr. 11, 2019
1900MHz Head	39.70 (35.73~43.67)	20.50 (18.45~22.55)	37.68	19.47	21.6 °C	Apr. 16, 2019
1900MHz Body	38.43 (34.59~42.27)	20.34 (18.31~22.37)	38.86	20.43	21.4 °C	Apr. 16, 2019
2450MHz Head	52.40 (47.16~57.64)	24.00 (21.60~26.40)	49.57	24.11	21.4 °C	Apr. 15, 2019
2450MHz Body	49.32 (44.39~54.25)	22.89 (20.60~25.17)	46.86	22.70	21.5 °C	Apr. 17, 2019
2600MHz Head	55.30 (49.77~60.83)	24.60 (22.14~27.06)	56.61	25.79	21.5 °C	Apr. 13, 2019
2600MHz Body	52.95 (47.66~58.25)	23.64 (21.28~26.00)	52.41	24.82	21.6 °C	Apr. 17, 2019

5. SAR Measurement variability and uncertainty

5.1. SAR measurement variability

Per KDB865664 D01 SAR measurement 100 MHz to 6 GHz, SAR measurement variability must be assessed for each frequency band, which is determined by the SAR probe calibration point and tissue-equivalent medium used for the device measurements. The additional measurements are repeated after the completion of all measurements requiring the same head or body tissue-equivalent medium in a frequency band. The test device should be returned to ambient conditions (normal room temperature) with the battery fully charged before it is re-mounted on the device holder for the repeated measurement(s) to minimize any unexpected variations in the repeated results.

- 1) Repeated measurement is not required when the original highest measured SAR is < 0.80 W/kg; steps 2) through 4) do not apply.
- 2) When the original highest measured SAR is ≥ 0.80 W/kg, repeat that measurement once.
- 3) Perform a second repeated measurement only if the ratio of largest to smallest SAR for the original and first repeated measurements is > 1.20 or when the original or repeated measurement is ≥ 1.45 W/kg (~ 10% from the 1-g SAR limit).
- 4) Perform a third repeated measurement only if the original, first or second repeated measurement is ≥ 1.5 W/kg and the ratio of largest to smallest SAR for the original, first and second repeated measurements is > 1.20 .

5.2. SAR measurement uncertainty

Per KDB865664 D01 SAR Measurement 100 MHz to 6 GHz, when the highest measured 1-g SAR within a frequency band is < 1.5 W/kg, the extensive SAR measurement uncertainty analysis described in IEEE Std 1528-2013 is not required in SAR reports submitted for equipment approval. The equivalent ratio (1.5/1.6) is applied to extremity and occupational exposure conditions.

6. RF Exposure Positions

6.1. Ear and handset reference point

Figure 6.1.1 shows the front, back, and side views of the SAM phantom. The center-of-mouth reference point is labeled “M”, the left ear reference point (ERP) is marked “LE”, and the right ERP is marked “RE”.



Fig 6.1.1 Front, back, and side views of SAM phantom

6.2. Definition of the cheek position

1. Define two imaginary lines on the handset, the vertical centerline and the horizontal line. The vertical centerline passes through two points on the front side of the handset: the midpoint of the width w_t of the handset at the level of the acoustic output (point A in Figure 6.2.1 and Figure 6.2.2), and the midpoint of the width w_b of the bottom of the handset (point B). The horizontal line is perpendicular to the vertical centerline and passes through the center of the acoustic output (see Figure 6.2.1). The two lines intersect at point A. Note that for many handsets, point A coincides with the center of the acoustic output; however, the acoustic output may be located elsewhere on the horizontal line. Also note that the vertical centerline is not necessarily parallel to the front face of the handset (see Figure 6.2.2), especially for clamshell handsets, handsets with flip covers, and other irregularly-shaped handsets.
2. Position the handset close to the surface of the phantom such that point A is on the (virtual) extension of the line passing through points RE and LE on the phantom (see Figure 6.2.3), such that the plane defined by the vertical centerline and the horizontal line of the handset is approximately parallel to the sagittal plane of the phantom.
3. Translate the handset towards the phantom along the line passing through RE and LE until handset point A touches the pinna at the ERP
4. While maintaining the handset in this plane, rotate it around the LE-RE line until the vertical centerline is in the plane normal to the plane containing B-M and N-F lines, i.e., the Reference Plane.
5. Rotate the handset around the vertical centerline until the handset (horizontal line) is parallel to the N-F line.

6. While maintaining the vertical centerline in the Reference Plane, keeping point A on the line passing through RE and LE, and maintaining the handset contact with the pinna, rotate the handset about the N-F line until any point on the handset is in contact with a phantom point below the pinna on the cheek. See Figure 6.2.3. The actual rotation angles should be documented in the test report.

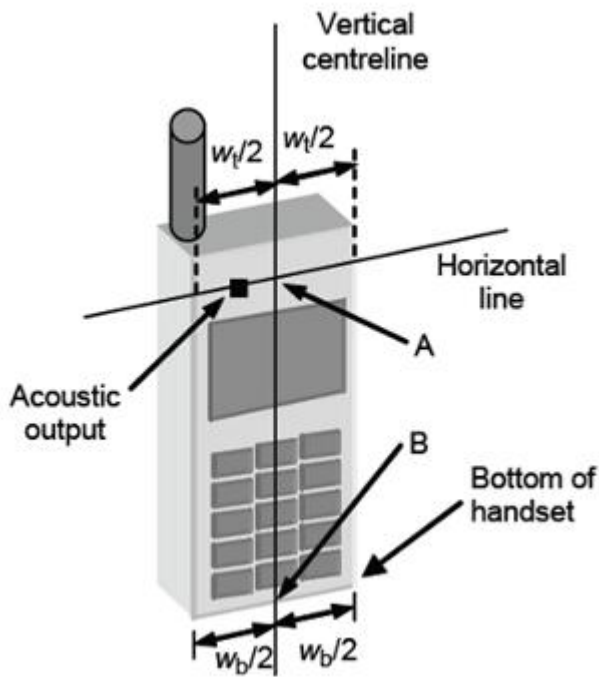

Fig 6.2.1 Handset vertical and horizontal reference lines—“fixed case”

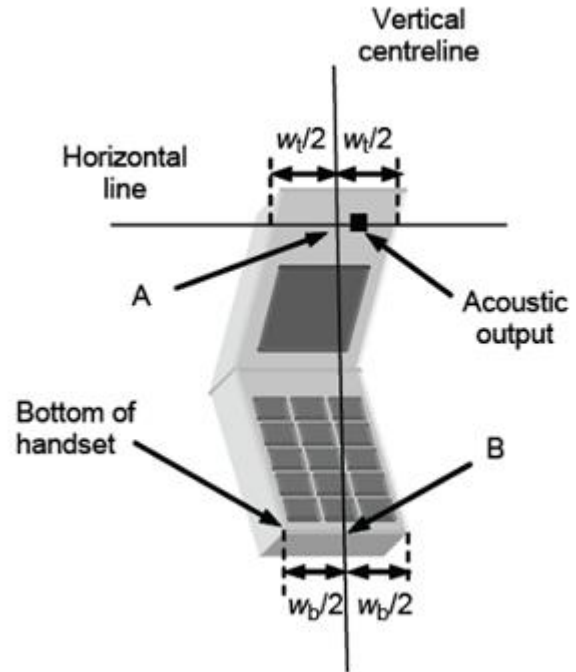

Fig 6.2.2 Handset vertical and horizontal reference lines—“clam-shell case”

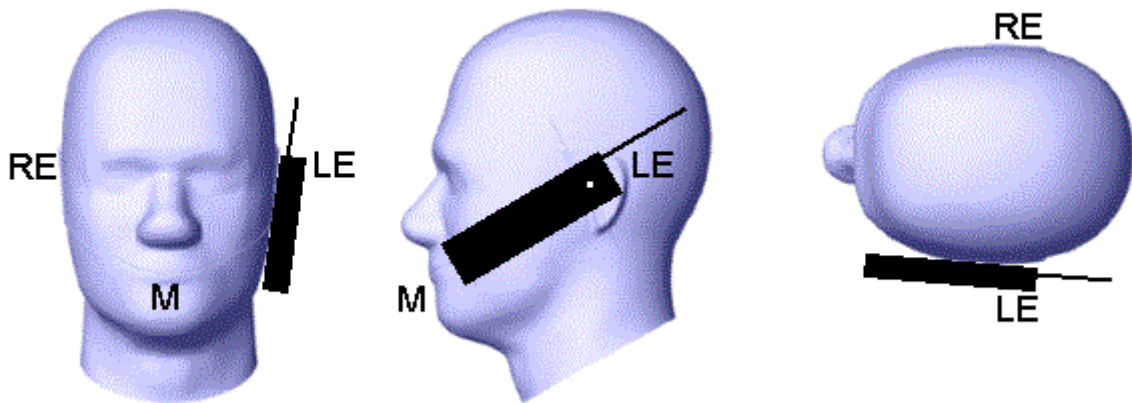

Fig 6.2.3 cheek or touch position. The reference points for the right ear (RE), left ear (LE), and mouth (M), which establish the Reference Plane for handset positioning, are indicated.

6.3. Definition of the tilt position

1. While maintaining the orientation of the handset, retract the handset parallel to the reference plane far enough away from the phantom to enable a rotation of the device by 15 degree.
2. Rotate the Handset around the horizontal line by 15 degree (see Figure 6.3.1).
3. While maintaining the orientation of the handset, move the handset towards the phantom on a line passing through RE and LE until any part of the handset touches the ear. The tilt position is obtained when the contact is on the pinna. If the contact is at any location other than the pinna, e.g., the antenna with the back of the phantom head, the angle of the handset shall be reduced. In this case, the tilt position is obtained if any part of the handset is in contact with the pinna as well as a second part of the handset is in contact with the phantom, e.g., the antenna with the back of the head.

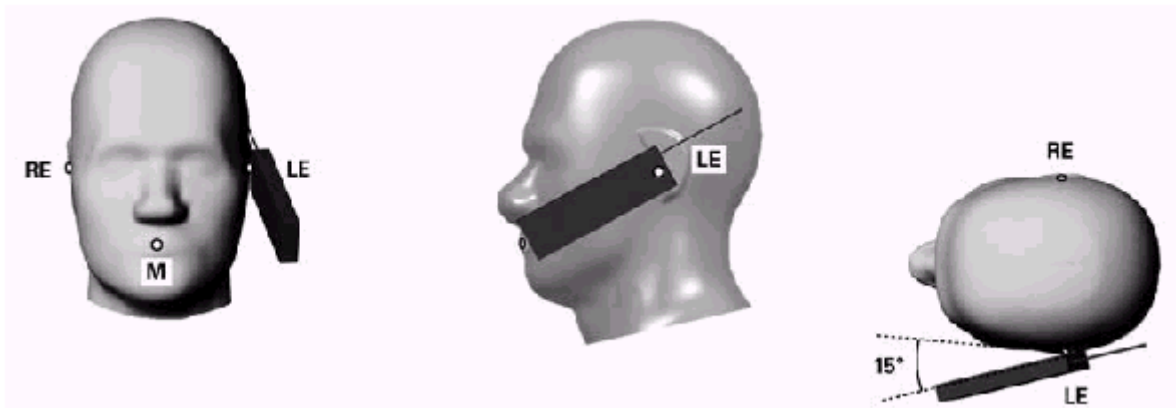

Figure 6.3.1 – Tilt position of the wireless device on the left side of SAM

6.4. Body Worn Accessory

1. Body-worn operating configurations are tested with the belt-clips and holsters attached to the device and positioned against a flat phantom in a normal use configuration (see Figure 6.4.1). Per KDB 648474 D04, body-worn accessory exposure is typically related to voice mode operations when handsets are carried in body-worn accessories. The body-worn accessory procedures in FCC KDB 447498 D01 should be used to test for body-worn accessory SAR compliance, without a headset connected to it. This enables the test results for such configuration to be compatible with that required for hotspot mode when the body-worn accessory test separation distance is greater than or equal to that required for hotspot mode, when applicable. When the reported SAR for body-worn accessory, measured without a headset connected to the handset is $< 1.2 \text{ W/kg}$, the highest reported SAR configuration for that wireless mode and frequency band should be repeated for that body-worn accessory with a handset attached to the handset.
2. Accessories for body-worn operation configurations are divided into two categories: those that do not contain metallic components and those that do contain metallic components and those that do contain metallic components. When multiple accessories that do not contain metallic components are supplied with the device, the device is tested with only the accessory that dictates the closest

spacing to the body. Then multiple accessories that contain metallic components are test with the device with each accessory. If multiple accessories share an identical metallic component (i.e. the same metallic belt-clip used with different holsters with no other metallic components) only the accessory that dictates the closest spacing to the body is tested.

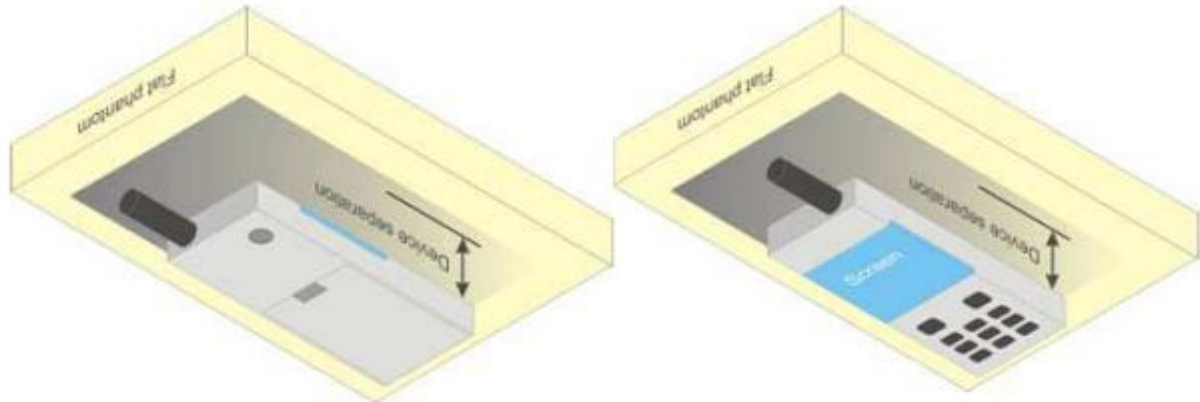

Figure 6.4.1 – Test positions for body-worn devices

6.5. Wireless Router Devices

Some battery-operated handsets have the capability to transmit and receive user through simultaneous transmission of WLAN simultaneously with a separate licensed transmitter. The FCC has provided guidance in FCC KDB Publication 941225 D06 where SAR test considerations for handsets ($L \times W \geq 9 \text{ cm} \times 5 \text{ cm}$) are based on a composite test separation distance of 10mm from the front, back and edges of the device containing transmitting antennas within 2.5cm of their edges, determined from general mixed use conditions for this type of devices. Since the hotspot SAR results may overlap with the body-worn accessory SAR requirements, the more conservative configurations can be considered, thus excluding some body-worn accessory SAR tests.

When the user enables the personal wireless router functions for the handset, actual operations include simultaneous transmission of both the WLAN transmitter and another licensed transmitter. Both transmitters often do not transmit at the same transmitting frequency and thus cannot be evaluated for SAR under actual use conditions due to the limitations of the SAR assessment probes. Therefore, SAR must be evaluated for each frequency transmission and mode separately and spatially summed with the WLAN transmitter according to FCC KDB Publication 447498 D01 publication procedures. The “Portable Hotspot” feature on the handset was NOT activated during SAR assessments, to ensure the SAR measurements were evaluated for a single transmission frequency RF signal at a time.

7. RF Output Power

7.1. GSM Conducted Power

Band GSM850		Burst-Averaged output Power (dBm)			Frame-Averaged output Power (dBm)			
Tx Channel	Tune-up (dBm)	128	189	251	Tune-up	128	189	251
Frequency (MHz)		824.2	836.4	848.8	(dBm)	824.2	836.4	848.8
GSM (GMSK)	34.00	33.67	33.80	33.95	24.97	24.64	24.77	24.92
GPRS(GMSK, 1 TS)	34.00	33.64	33.73	33.92	24.97	24.61	24.70	24.89
GPRS(GMSK, 2 TS)	32.00	31.25	31.30	31.34	25.98	25.23	25.28	25.32
GPRS(GMSK, 3 TS)	30.00	29.70	29.71	29.67	25.74	25.44	25.45	25.41
GPRS(GMSK, 4 TS)	29.00	28.89	28.96	28.97	25.99	25.88	25.95	25.96
EDGE(GMSK, 1 TS)	26.00	25.47	25.64	25.91	16.97	16.44	16.61	16.88
EDGE(GMSK, 2 TS)	25.00	24.71	24.90	24.99	18.98	18.69	18.88	18.97
EDGE(GMSK, 3 TS)	24.00	23.93	23.97	23.85	19.74	19.67	19.71	19.59
EDGE(GMSK, 4 TS)	22.00	21.74	21.65	21.62	18.99	18.73	18.64	18.61
Band GSM1900		Burst-Averaged output Power (dBm)			Frame-Averaged output Power (dBm)			
Tx Channel	Tune-up (dBm)	512	661	810	Tune-up	512	661	810
Frequency (MHz)		1850.2	1880.0	1909.8	(dBm)	1850.2	1880.0	1909.8
GSM (GMSK)	31.00	30.54	30.56	30.61	21.97	21.51	21.53	21.58
GPRS(GMSK, 1 TS)	31.00	30.50	30.65	30.45	21.97	21.47	21.62	21.42
GPRS(GMSK, 2 TS)	28.00	27.76	27.75	27.65	21.98	21.74	21.73	21.63
GPRS(GMSK, 3 TS)	26.00	25.20	25.12	25.03	21.74	20.94	20.86	20.77
GPRS(GMSK, 4 TS)	25.00	24.98	24.95	24.85	21.99	21.97	21.94	21.84
EDGE(GMSK, 1 TS)	26.00	25.99	25.89	25.92	16.97	16.96	16.86	16.89
EDGE(GMSK, 2 TS)	26.00	25.74	25.87	25.81	19.98	19.72	19.85	19.79
EDGE(GMSK, 3 TS)	26.00	25.36	25.37	25.21	21.74	21.10	21.11	20.95
EDGE(GMSK, 4 TS)	24.00	23.54	23.65	23.71	20.99	20.53	20.64	20.70

Note: The frame-averaged power is linearly scaled the maximum burst averaged power over 8 time slots.

The calculated method are shown as below:

Frame-averaged power = Maximum burst averaged power (1 TS) - 9.03 dB

Frame-averaged power = Maximum burst averaged power (2 TS) - 6.02 dB

Frame-averaged power = Maximum burst averaged power (3 TS) - 4.26 dB

Frame-averaged power = Maximum burst averaged power (4 TS) - 3.01 dB

7.2. WCDMA Conducted Power

Band	WCDMA Band V			
Tx Channel	Tune-up	4132	4182	4233
Frequency (MHz)		826.4	836.4	846.6

RMC 12.2Kbps	24.00	23.73	23.98	23.65
HSDPA Subtest-1	22.00	21.87	21.79	21.78
HSDPA Subtest-2	22.00	21.30	21.40	21.34
HSDPA Subtest-3	22.00	21.25	21.33	21.50
HSDPA Subtest-4	22.00	21.32	21.40	21.28
HSUPA Subtest-1	22.00	21.28	21.37	21.36
HSUPA Subtest-2	22.00	21.19	21.32	21.39
HSUPA Subtest-3	22.00	21.42	21.24	21.44
HSUPA Subtest-4	22.00	21.31	21.51	21.41
HSUPA Subtest-5	22.00	21.95	21.79	21.80
Band	WCDMA Band II			
Tx Channel	Tune-up	9262	9400	9538
Frequency (MHz)		1852.4	1880	1907.6
RMC 12.2Kbps	24.00	23.85	23.93	23.84
HSDPA Subtest-1	23.00	22.54	22.75	22.68
HSDPA Subtest-2	23.00	22.15	22.21	22.31
HSDPA Subtest-3	23.00	22.19	22.18	22.32
HSDPA Subtest-4	23.00	22.20	22.23	22.08
HSUPA Subtest-1	23.00	22.31	22.24	22.19
HSUPA Subtest-2	23.00	22.10	22.19	22.16
HSUPA Subtest-3	23.00	22.25	22.32	22.30
HSUPA Subtest-4	23.00	22.32	22.22	22.31
HSUPA Subtest-5	23.00	22.63	22.81	22.70

7.3. LTE Conducted Power

Band	Band Width	Modulation	RB Configuration		Tune-up	Channel/Frequency(MHz)		
			RB Size	RB Offset		18607/1850.7	18900/1880	19193/1909.3
LTE Band II	1.4MHz	QPSK	1	0	24.00	23.35	23.43	23.54
			1	2	24.00	23.42	23.33	23.52
			1	5	24.00	23.35	23.40	23.49
			3	0	24.00	23.43	23.54	23.67
			3	1	24.00	23.41	23.52	23.59
			3	2	24.00	23.38	23.53	23.61
		16QAM	6	0	23.00	21.73	21.90	22.12
			1	0	23.00	21.85	21.65	22.81
			1	2	23.00	21.92	21.72	22.83
			1	5	23.00	21.95	21.55	22.81

Band	Band Width	Modulation	RB Configuration		Tune-up	Channel/Frequency(MHz)		
			RB Size	RB Offset		18615/1851.5	18900/1880	19185/1908.5
			3	0	23.00	21.77	22.15	22.07
			3	1	23.00	21.73	22.08	22.04
			3	2	23.00	21.75	22.03	22.06
			6	0	22.00	21.85	21.69	21.28
LTE Band II	3MHz	QPSK	1	0	24.00	23.27	23.40	23.50
			1	7	24.00	23.25	23.44	23.52
			1	14	24.00	23.26	23.40	23.52
			8	0	23.00	21.83	21.97	21.99
			8	4	23.00	21.81	21.94	21.97
			8	7	23.00	21.72	21.96	21.99
			15	0	23.00	21.81	21.98	22.21
		16QAM	1	0	23.00	22.11	21.64	22.81
			1	7	23.00	22.15	21.69	22.83
			1	14	23.00	22.09	21.58	22.77
			8	0	22.00	21.98	21.96	21.65
			8	4	22.00	21.97	21.92	21.59
			8	7	22.00	21.87	21.93	21.30
			15	0	22.00	21.85	21.89	21.48
Band	Band Width	Modulation	RB Configuration		Tune-up	Channel/Frequency(MHz)		
			RB Size	RB Offset		18625/1852.5	18900/1880	19175/1907.5
LTE Band II	5MHz	QPSK	1	0	24.00	23.20	23.42	23.59
			1	12	24.00	23.23	23.37	23.66
			1	24	24.00	23.25	23.38	23.73
			12	0	23.00	22.01	22.03	21.93
			12	6	23.00	21.89	21.91	22.09
			12	11	23.00	21.76	21.96	22.10
			25	0	23.00	21.92	22.04	22.12
		16QAM	1	0	23.00	21.25	21.60	22.08
			1	12	23.00	21.25	21.53	22.09
			1	24	23.00	21.30	21.61	22.13
			12	0	22.00	21.71	21.71	21.91
			12	6	22.00	21.68	21.66	21.83
			12	11	22.00	21.45	21.64	21.48
			25	0	22.00	21.65	21.75	21.70

Band	Band Width	Modulation	RB Configuration		Tune-up	Channel/Frequency(MHz)		
			RB Size	RB Offset		18650/1855	18900/1880	19150/1905
LTE Band II	10MHz	QPSK	1	0	24.00	23.28	23.66	23.57
			1	24	24.00	23.33	23.62	23.59
			1	49	24.00	23.31	23.61	23.61
			25	0	23.00	22.01	21.87	21.90
			25	12	23.00	21.93	21.91	21.95
			25	24	23.00	21.88	21.96	22.10
			50	0	23.00	21.96	21.95	22.02
		16QAM	1	0	23.00	22.28	21.54	22.30
			1	24	23.00	22.23	21.62	22.36
			1	49	23.00	22.35	21.59	22.34
			25	0	23.00	22.39	21.93	21.88
			25	12	23.00	22.29	21.95	21.93
			25	24	23.00	22.25	22.01	22.06
			50	0	23.00	22.28	21.91	21.87
Band	Band Width	Modulation	RB Configuration		Tune-up	Channel/Frequency(MHz)		
			RB Size	RB Offset		18675/1857.5	18900/1880	19125/1902.5
LTE Band II	15MHz	QPSK	1	0	24.00	23.30	23.47	23.56
			1	37	24.00	23.30	23.49	23.55
			1	74	24.00	23.35	23.52	23.63
			36	0	23.00	21.95	22.06	22.08
			36	18	23.00	21.91	22.03	22.12
			36	37	23.00	21.66	21.81	22.16
			75	0	23.00	21.92	21.97	22.05
		16QAM	1	0	23.00	22.31	22.33	22.25
			1	37	23.00	22.33	22.28	22.25
			1	74	23.00	22.32	22.35	22.33
			36	0	23.00	22.29	21.89	21.71
			36	18	23.00	22.13	21.75	21.68
			36	37	23.00	21.98	21.63	21.97
			75	0	23.00	22.11	21.77	21.87
Band	Band Width	Modulation	RB Configuration		Tune-up	Channel/Frequency(MHz)		
			RB Size	RB Offset		18700/1860	18900/1880	19100/1900

LTE Band II	20MHz	QPSK	1	0	24.00	23.46	23.61	23.56
			1	49	24.00	23.42	23.62	23.49
			1	99	24.00	23.41	23.64	23.65
			50	0	23.00	21.77	21.99	22.04
			50	24	23.00	21.94	21.91	22.03
			50	49	23.00	22.03	21.96	22.02
			100	0	23.00	21.85	21.99	21.96
		16QAM	1	0	23.00	22.56	21.96	22.08
			1	49	23.00	22.56	21.89	22.08
			1	99	23.00	22.60	21.91	22.21
			50	0	23.00	22.07	21.72	21.68
			50	24	23.00	22.05	21.61	21.53
			50	49	23.00	22.33	21.68	22.20
			100	0	23.00	22.17	21.71	21.96

Band	Band Width	Modulation	RB Configuration		Tune-up	Channel/Frequency(MHz)		
			RB Size	RB Offset		19957/1710.7	20175/1732.5	20393/1754.3
LTE Band IV	1.4MHz	QPSK	1	0	24.00	23.49	23.49	23.36
			1	2	24.00	23.56	23.62	23.39
			1	5	24.00	23.51	23.64	23.34
			3	0	24.00	23.55	23.62	23.60
			3	1	24.00	23.52	23.61	23.58
			3	2	24.00	23.56	23.62	23.59
			6	0	23.00	22.00	22.09	22.06
		16QAM	1	0	23.00	22.60	21.91	22.72
			1	2	23.00	22.58	21.92	22.64
			1	5	23.00	22.55	21.98	22.65
			3	0	23.00	22.16	22.15	22.05
			3	1	23.00	22.15	22.13	22.03
			3	2	23.00	22.18	22.16	22.00
			6	0	22.00	21.20	20.69	20.74
Band	Band Width	Modulation	RB Configuration		Tune-up	Channel/Frequency(MHz)		
			RB Size	RB Offset		19965/1711.5	20175/1732.5	20385/1753.5
LTE Band IV	3MHz	QPSK	1	0	24.00	23.47	23.55	23.38
			1	7	24.00	23.45	23.57	23.44
			1	14	24.00	23.46	23.63	23.36

			8	0	23.00	22.14	21.88	22.04
			8	4	23.00	22.11	21.92	22.01
			8	7	23.00	22.14	21.94	21.89
			15	0	23.00	22.17	21.92	21.90
		16QAM	1	0	23.00	22.43	22.02	22.76
			1	7	23.00	22.43	21.88	22.71
			1	14	23.00	22.40	21.89	22.67
			8	0	22.00	21.37	20.75	20.92
			8	4	22.00	21.33	20.71	20.89
			8	7	22.00	21.38	20.83	20.69
		15	0	22.00	21.30	20.83	20.76	
Band	Band Width	Modulation	RB Configuration		Tune-up	Channel/Frequency(MHz)		
			RB Size	RB Offset		19975/1712.5	20175/1732.5	20375/1752.5
LTE Band IV	5MHz	QPSK	1	0	24.00	23.66	23.44	23.43
			1	12	24.00	23.66	23.50	23.38
			1	24	24.00	23.68	23.51	23.33
			12	0	23.00	22.13	21.89	22.09
			12	6	23.00	22.07	21.77	22.02
			12	11	23.00	21.99	22.13	22.11
			25	0	23.00	22.19	22.07	22.03
		16QAM	1	0	23.00	22.05	21.27	21.71
			1	12	23.00	22.03	21.28	21.68
			1	24	23.00	22.08	21.24	21.66
			12	0	22.00	21.23	20.59	21.19
			12	6	22.00	21.21	20.61	20.97
			12	11	22.00	21.10	20.70	20.84
			25	0	22.00	21.10	20.72	21.10
Band	Band Width	Modulation	RB Configuration		Tune-up	Channel/Frequency(MHz)		
			RB Size	RB Offset		20000/1715	20175/1732.5	20350/1750
LTE Band IV	10MHz	QPSK	1	0	24.00	23.48	23.46	23.51
			1	24	24.00	23.47	23.51	23.47
			1	49	24.00	23.44	23.52	23.58
			25	0	23.00	22.08	21.99	21.83
			25	12	23.00	22.07	21.97	21.89
			25	24	23.00	22.09	22.04	22.07
			50	0	23.00	22.25	21.93	21.96

Band	Band Width	Modulation	RB Configuration		Tune-up	Channel/Frequency(MHz)		
			RB Size	RB Offset		20025/1717.5	20175/1732.5	20325/1747.5
		16QAM	1	0	23.00	22.44	21.56	22.49
			1	24	23.00	22.46	21.66	22.41
			1	49	23.00	22.48	21.64	22.49
			25	0	22.00	21.41	20.75	21.87
			25	12	22.00	21.45	20.93	21.79
			25	24	22.00	21.48	21.28	21.48
			50	0	22.00	21.43	20.98	21.68
LTE Band IV	15MHz	QPSK	1	0	24.00	23.47	23.42	23.53
			1	37	24.00	23.48	23.53	23.44
			1	74	24.00	23.41	23.54	23.50
			36	0	23.00	22.10	21.97	22.10
			36	18	23.00	22.06	22.07	22.07
			36	37	23.00	22.01	22.13	22.09
			75	0	23.00	22.20	21.95	22.00
		16QAM	1	0	23.00	22.44	22.40	22.34
			1	37	23.00	22.49	22.36	22.39
			1	74	23.00	22.42	22.28	22.41
			36	0	22.00	21.31	20.81	21.59
			36	18	22.00	21.28	21.97	21.53
			36	37	22.00	20.97	21.20	20.77
			75	0	22.00	21.17	21.01	21.21
Band	Band Width	Modulation	RB Configuration		Tune-up	Channel/Frequency(MHz)		
			RB Size	RB Offset		20050/1720	20175/1732.5	20300/1745
LTE Band IV	20MHz	QPSK	1	0	24.00	23.66	23.58	23.70
			1	49	24.00	23.65	23.57	23.79
			1	99	24.00	23.64	23.59	23.75
			50	0	23.00	22.02	21.93	22.14
			50	24	23.00	22.09	21.89	22.07
			50	49	23.00	22.16	21.92	21.98
			100	0	23.00	22.20	22.00	22.03
		16QAM	1	0	23.00	22.00	22.55	21.84
			1	49	23.00	21.96	22.55	21.88
			1	99	23.00	21.96	22.56	21.89
50	0		22.00	21.29	20.70	21.50		

			50	24	22.00	21.22	21.39	21.43
			50	49	22.00	21.18	21.47	21.25
			100	0	22.00	21.26	21.11	21.38

Band	Band Width	Modulation	RB Configuration		Tune-up	Channel/Frequency(MHz)		
			RB Size	RB Offset		20407/824.7	20525/836.5	20643/848.3
LTE Band V	1.4MHz	QPSK	1	0	23.50	23.44	23.28	23.01
			1	2	23.50	23.41	23.35	22.87
			1	5	23.50	23.41	23.37	22.95
			3	0	23.50	23.41	23.22	23.13
			3	1	23.50	23.49	23.18	23.09
			3	2	23.50	23.43	23.24	23.03
		16QAM	6	0	22.50	21.96	21.70	21.53
			1	0	22.50	21.95	21.24	22.14
			1	2	22.50	21.91	21.28	22.05
			1	5	22.50	21.90	21.28	22.06
			3	0	22.50	21.74	21.64	21.36
			3	1	22.50	21.67	21.59	21.29
			3	2	22.50	21.74	21.63	21.32
6	0	21.50	21.30	21.30	20.59			

Band	Band Width	Modulation	RB Configuration		Tune-up	Channel/Frequency(MHz)		
			RB Size	RB Offset		20415/825.5	20525/836.5	20635/847.5

LTE Band V	3MHz	QPSK	1	0	23.50	23.47	23.32	23.02
			1	7	23.50	23.47	23.34	23.01
			1	14	23.50	23.38	23.33	22.89
			8	0	22.50	21.70	21.60	21.39
			8	4	22.50	21.73	21.62	21.47
			8	7	22.50	21.80	21.64	21.55
			15	0	22.50	21.80	21.63	21.34
		16QAM	1	0	22.50	22.12	21.30	22.10
			1	7	22.50	22.09	21.35	22.16
			1	14	22.50	21.99	21.28	22.02
			8	0	22.50	21.49	21.38	20.69
			8	4	22.50	21.52	21.41	20.63
			8	7	22.50	21.57	21.45	20.60
15	0	21.50	21.45	21.45	20.64			

Band	Band Width	Modulation	RB Configuration		Tune-up	Channel/Frequency(MHz)		
			RB Size	RB Offset		20425/826.5	20525/836.5	20625/846.5
LTE Band V	5MHz	QPSK	1	0	23.50	23.40	23.20	23.08
			1	12	23.50	23.40	23.19	23.12
			1	24	23.50	23.29	23.33	23.05
			12	0	22.50	21.92	21.77	21.61
			12	6	22.50	21.89	21.69	21.57
			12	11	22.50	21.90	21.77	21.26
			25	0	22.50	21.86	21.80	21.43
		16QAM	1	0	22.50	21.10	21.34	21.45
			1	12	22.50	20.95	21.28	21.37
			1	24	22.50	20.92	21.27	21.37
			12	0	22.50	21.24	21.22	20.88
			12	6	22.50	21.31	21.19	20.76
			12	11	22.50	21.37	21.22	20.65
			25	0	21.50	21.38	21.29	20.77

Band	Band Width	Modulation	RB Configuration		Tune-up	Channel/Frequency(MHz)		
			RB Size	RB Offset		20450/829	20525/836.5	20600/844
LTE Band V	10MHz	QPSK	1	0	23.50	23.34	23.28	23.34
			1	24	23.50	23.23	23.17	23.13
			1	49	23.50	23.27	23.17	23.07
			25	0	22.50	21.76	21.63	21.60
			25	12	22.50	21.69	21.59	21.49
			25	24	22.50	21.79	21.78	21.36
			50	0	22.50	21.58	21.73	21.52
		16QAM	1	0	22.50	22.14	21.26	21.82
			1	24	22.50	21.99	21.21	21.80
			1	49	22.50	21.87	21.23	21.62
			25	0	22.50	20.77	21.36	21.30
			25	12	22.50	20.68	21.41	21.23
			25	24	22.50	21.24	21.48	21.06
			50	0	21.50	20.97	21.36	21.19

Band	Band Width	Modulation	RB Configuration		Tune-up	Channel/Frequency(MHz)		
			RB	RB		20775/2502.5	21100/2535	21425/2567.5

Band	Band Width	Modulation	RB Configuration		Tune-up	Channel/Frequency(MHz)		
			RB Size	RB Offset		20800/2505	21100/2535	21400/2565
LTE Band VII	5MHz	QPSK	1	0	23.50	22.92	23.02	22.84
			1	12	23.50	22.93	23.02	22.85
			1	24	23.50	22.94	23.14	22.88
			12	0	22.50	21.95	22.02	22.13
			12	6	22.50	21.93	22.05	22.09
			12	11	22.50	21.92	22.08	21.99
		16QAM	25	0	22.50	21.90	22.08	22.11
			1	0	22.50	22.08	21.21	21.63
			1	12	22.50	22.09	21.33	21.65
			1	24	22.50	22.16	21.24	21.69
			12	0	21.50	21.08	21.18	20.92
			12	6	21.50	21.01	21.13	20.87
			12	11	21.50	21.07	21.08	20.71
			25	0	21.50	21.10	21.01	20.83
LTE Band VII	10MHz	QPSK	1	0	23.50	22.86	23.13	22.95
			1	24	23.50	22.86	23.17	22.95
			1	49	23.50	22.79	23.23	23.01
			25	0	22.50	21.91	22.12	22.06
			25	12	22.50	21.88	22.07	22.04
			25	24	22.50	21.99	22.02	22.01
			50	0	22.50	22.08	22.09	22.14
		16QAM	1	0	22.50	22.41	21.70	22.33
			1	24	22.50	22.42	21.67	22.43
			1	49	22.50	22.41	21.60	22.39
			25	0	21.50	21.15	21.35	21.16
			25	12	21.50	21.22	21.38	21.14
			25	24	21.50	21.14	21.48	21.10
			50	0	21.50	21.33	21.23	21.14
Band	Band Width	Modulation	RB Configuration		Tune-up	Channel/Frequency(MHz)		
			RB Size	RB Offset		20825/2507.5	21100/2535	21375/2562.5
LTE Band VII	15MHz	QPSK	1	0	23.50	22.93	23.20	23.00
			1	37	23.50	22.90	23.15	22.99
			1	74	23.50	22.90	23.17	23.02

			36	0	22.50	22.08	22.11	22.05			
			36	18	22.50	22.04	22.13	22.04			
			36	37	22.50	21.91	22.17	22.02			
			75	0	22.50	22.01	22.01	22.02			
		16QAM	1	0	22.50	22.38	22.47	22.47			
			1	37	22.50	22.32	22.49	22.44			
			1	74	22.50	22.42	22.42	22.44			
			36	0	21.50	21.11	21.37	21.25			
			36	18	21.50	21.13	21.41	21.13			
			36	37	21.50	21.43	21.21	20.97			
			75	0	21.50	21.35	21.34	21.16			
			Band	Band Width	Modulation	RB Configuration		Tune-up	Channel/Frequency(MHz)		
						RB Size	RB Offset		20850/2510	21100/2535	21350/2560
LTE Band VII	20MHz	QPSK	1	0	23.50	23.14	23.06	23.15			
			1	49	23.50	23.12	22.99	23.15			
			1	99	23.50	23.20	23.07	23.17			
			50	0	22.50	21.90	22.02	22.12			
			50	24	22.50	21.95	22.06	22.15			
			50	49	22.50	21.98	22.08	22.18			
			100	0	22.50	21.92	22.02	22.06			
		16QAM	1	0	22.50	21.81	22.43	22.36			
			1	49	22.50	21.87	22.44	22.26			
			1	99	22.50	21.95	22.46	22.45			
			50	0	21.50	20.99	21.38	21.10			
			50	24	21.50	21.31	21.42	21.15			
			50	49	21.50	21.48	21.46	21.19			
			100	0	21.50	21.41	21.30	21.19			

7.4. WLAN & Bluetooth Output Power

7.4.1. Output Power Results Of WLAN

Mode	Channel	Frequency (MHz)	Tune-up	Output Power (dBm)
802.11b	1	2412	12.0	11.8
	6	2437	12.0	11.2
	11	2462	12.0	11.9
802.11g	1	2412	12.0	11.7
	6	2437	12.0	11.4
	11	2462	12.0	10.1
802.11n HT20	1	2412	12.0	10.8
	6	2437	12.0	10.3
	11	2462	12.0	10.9

7.4.2. Output Power Results Of Bluetooth

BR+EDR	Output Power (dBm)				
	Channel	Tune-up	Data Rates		
			1M	2M	3M
	0CH	5.00	4.08	4.37	4.71
	39CH	3.00	2.25	2.63	2.87
	78CH	3.00	1.72	2.15	2.43

BLE	Channel	Tune-up	Output Power (dBm)
	0CH	3.00	1.98
	19CH	3.00	2.37
	39CH	3.00	1.95

8. Antenna Location

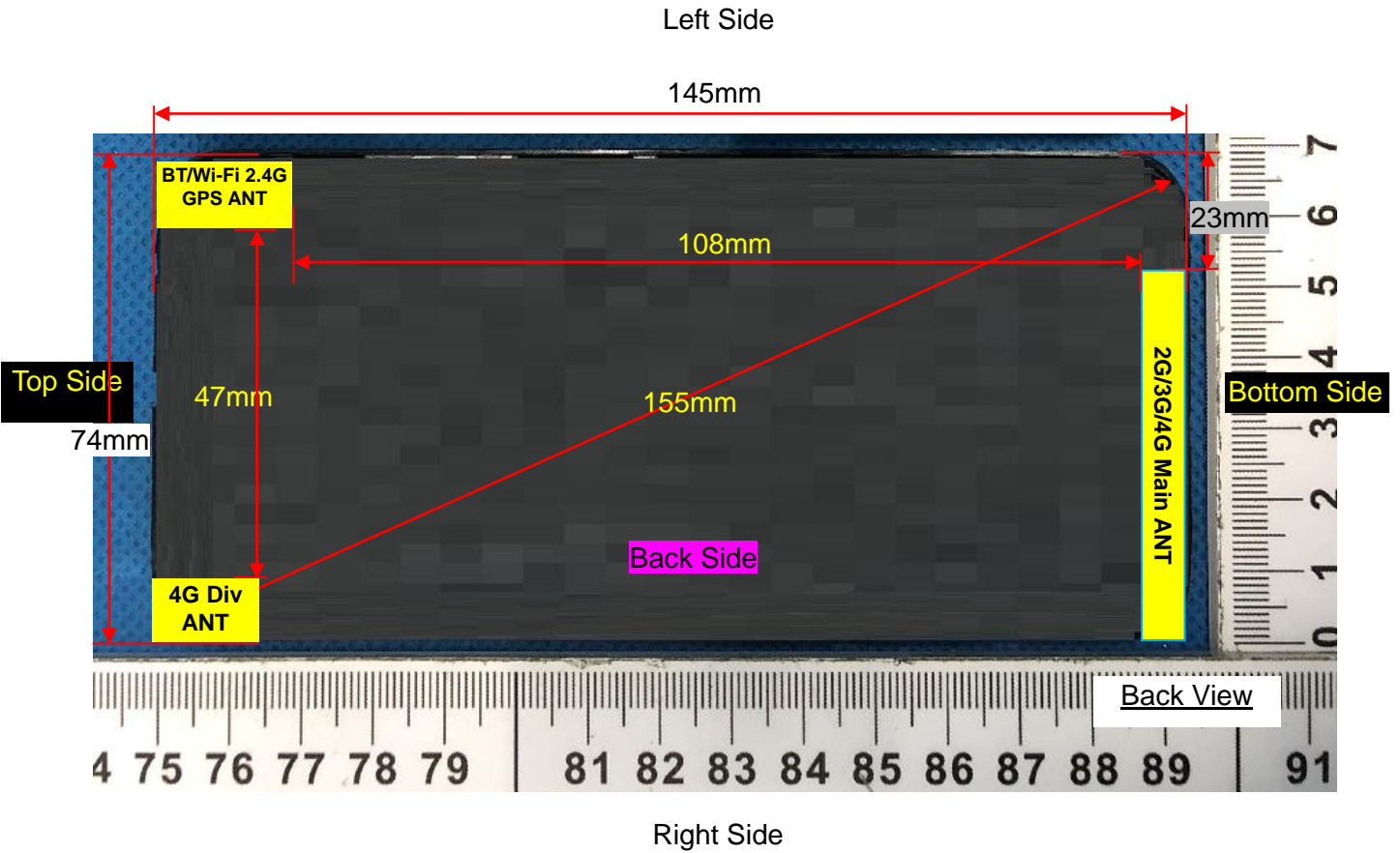

Distance of the Antenna to the EUT surface/edge						
Antennas	Front Side	Back Side	Left Side	Right Side	Top Side	Bottom Side
WWAN Main	≤ 25mm	≤ 25mm	≤ 25mm	≤ 25mm	>25mm	≤ 25mm
WLAN & Bluetooth	≤ 25mm	≤ 25mm	≤ 25mm	>25mm	≤ 25mm	>25mm
Positions for SAR tests						
Antennas	Front Side	Back Side	Left Side	Right Side	Top Side	Bottom Side
WWAN Main	Yes	Yes	Yes	Yes	NO	Yes
WLAN & Bluetooth	Yes	Yes	Yes	NO	Yes	NO

9. Stand-alone SAR test exclusion

Refer to FCC KDB 447498D01, the 1-g SAR and 10-g SAR test exclusion thresholds for 100 MHz to 6 GHz at test separation distances ≤ 50 mm are determined by:

$[(\text{max. power of channel, including tune-up tolerance, mW}) / (\text{min. test separation distance, mm})] \cdot [\sqrt{f_{(\text{GHz})}}] \leq 3.0$ for 1-g SAR and ≤ 7.5 for 10-g extremity SAR, where:

- $f_{(\text{GHz})}$ is the RF channel transmit frequency in GHz
- Power and distance are rounded to the nearest mW and mm before calculation
- The result is rounded to one decimal place for comparison

When the minimum test separation distance is < 5 mm, a distance of 5 mm is applied to determine SAR test exclusion.

Mode	P_{max} (dBm)	P_{max} (mW)	Distance (mm)	f (GHz)	Calculation Result	SAR Exclusion threshold	SAR test exclusion
Bluetooth	5.00	3.16	5	2.480	1.00	3.0	Yes

NOTE: Standalone SAR test exclusion for Bluetooth

When standalone SAR test exclusion applies to an antenna that transmits simultaneously with other antennas, the standalone SAR must be estimated according to following to determine simultaneous transmission SAR test exclusion:

$[(\text{max. power of channel, including tune-up tolerance, mW}) / (\text{min. test separation distance, mm})] \cdot [\sqrt{f_{(\text{GHz})} / x}] \text{ W/kg}$ for test separation distances $\leq 50\text{mm}$, where $x = 7.5$ for 1-g SAR and $x = 18.75$ for 10-g SAR.

When the minimum test separation distance is < 5 mm, a distance of 5 mm is applied to determine SAR test exclusion.

Mode	Position	P_{max} (dBm)	P_{max} (mW)	Distance (mm)	f (GHz)	x	Estimated SAR (W/Kg)
Bluetooth	Head	5.00	3.16	5	2.480	7.5	0.133
Bluetooth	Body	5.00	3.16	10	2.480	7.5	0.066
Bluetooth	Hotspot	5.00	3.16	10	2.480	7.5	0.066

NOTE: Estimated SAR calculation for Bluetooth

10. SAR Results

10.1. SAR measurement results

10.1.1. SAR measurement Result of GSM850

Test Position of Head	Test channel /Freq.	Test Mode	SAR Value (W/kg)		Power Drift (±5%)	Conducted power (dBm)	Tune-up power (dBm)	Scaled SAR 1g (W/Kg)
			1g	10g				
Left Cheek	189/836.4	GPRS(GMSK 4TS)	0.400	0.308	-1.12	28.96	29.00	0.404
Left Tilt 15 Degree	189/836.4	GPRS(GMSK 4TS)	0.287	0.230	0.32	28.96	29.00	0.290
Right Cheek	189/836.4	GPRS(GMSK 4TS)	0.385	0.285	1.02	28.96	29.00	0.389
Right Tilt 15 Degree	189/836.4	GPRS(GMSK 4TS)	0.270	0.223	0.31	28.96	29.00	0.272

NOTE: Head SAR test results of GSM850.

Test Position of Body-Worn with 10mm	Test channel /Freq.	Test Mode	SAR Value (W/kg)		Power Drift (±5%)	Conducted power (dBm)	Tune-up power (dBm)	Scaled SAR 1g (W/Kg)
			1g	10g				
Front Side	189/836.4	GPRS(GMSK 4TS)	0.423	0.321	-0.14	28.96	29.00	0.427
Back Side	189/836.4	GPRS(GMSK 4TS)	0.441	0.329	2.40	28.96	29.00	0.445

NOTE: Body-Worn SAR test results of GSM850

Test Position of Hotspot with 10mm	Test channel /Freq.	Test Mode	SAR Value (W/kg)		Power Drift (±5%)	Conducted power (dBm)	Tune-up power (dBm)	Scaled SAR 1g (W/Kg)
			1g	10g				
Front Side	189/836.4	GPRS(GMSK 4TS)	0.423	0.321	-0.14	28.96	29.00	0.427
Back Side	189/836.4	GPRS(GMSK 4TS)	0.441	0.329	2.40	28.96	29.00	0.445
Left Side	189/836.4	GPRS(GMSK 4TS)	0.212	0.157	0.02	28.96	29.00	0.214
Right Side	189/836.4	GPRS(GMSK 4TS)	0.223	0.168	0.24	28.96	29.00	0.225
Bottom Side	189/836.4	GPRS(GMSK 4TS)	0.206	0.153	1.65	28.96	29.00	0.208

NOTE: Hotspot SAR test results of GSM850

10.1.2. SAR measurement Result of GSM1900

Test Position of Head	Test channel /Freq.	Test Mode	SAR Value (W/kg)		Power Drift (±5%)	Conducted power (dBm)	Tune-up power (dBm)	Scaled SAR 1g (W/Kg)
			1g	10g				
Left Cheek	661/1880	GPRS(GMSK 4TS)	0.320	0.195	-1.71	24.95	25.00	0.324

Left Tilt 15 Degree	661/1880	GPRS(GMSK 4TS)	0.142	0.085	0.21	24.95	25.00	0.144
Right Cheek	661/1880	GPRS(GMSK 4TS)	0.303	0.184	1.41	24.95	25.00	0.307
Right Tilt 15 Degree	661/1880	GPRS(GMSK 4TS)	0.135	0.081	0.20	24.95	25.00	0.137

NOTE: Head SAR test results of GSM1900

Test Position of Body-Worn with 10mm	Test channel /Freq.	Test Mode	SAR Value (W/kg)		Power Drift (±5%)	Conducted power (dBm)	Tune-up power (dBm)	Scaled SAR 1g (W/Kg)
			1g	10g				
Front Side	661/1880	GPRS(GMSK 4TS)	0.476	0.284	-0.46	24.95	25.00	0.482
Back Side	661/1880	GPRS(GMSK 4TS)	0.671	0.381	-0.72	24.95	25.00	0.679

NOTE: Body-Worn SAR test results of GSM1900

Test Position of Hotspot with 10mm	Test channel /Freq.	Test Mode	SAR Value (W/kg)		Power Drift (±5%)	Conducted power (dBm)	Tune-up power (dBm)	Scaled SAR 1g (W/Kg)
			1g	10g				
Front Side	661/1880	GPRS(GMSK 4TS)	0.476	0.284	-0.46	24.95	25.00	0.482
Back Side	661/1880	GPRS(GMSK 4TS)	0.671	0.381	-0.72	24.95	25.00	0.679
Left Side	661/1880	GPRS(GMSK 4TS)	0.214	0.142	0.03	24.95	25.00	0.216
Right Side	661/1880	GPRS(GMSK 4TS)	0.278	0.156	0.27	24.95	25.00	0.281
Bottom Side	661/1880	GPRS(GMSK 4TS)	0.357	0.196	-1.87	24.95	25.00	0.361

NOTE: Hotspot SAR test results of GSM1900

10.1.3. SAR measurement Result of WCDMA Band V

Test Position of Head	Test channel /Freq.	Test Mode	SAR Value (W/kg)		Power Drift (±5%)	Conducted power (dBm)	Tune-up power (dBm)	Scaled SAR 1g (W/Kg)
			1g	10g				
Left Cheek	4182/836.4	RMC12.2K	0.369	0.287	0.21	23.98	24.00	0.371
Left Tilt 15 Degree	4182/836.4	RMC12.2K	0.274	0.200	0.65	23.98	24.00	0.275
Right Cheek	4182/836.4	RMC12.2K	0.305	0.239	0.01	23.98	24.00	0.306
Right Tilt 15 Degree	4182/836.4	RMC12.2K	0.254	0.187	1.28	23.98	24.00	0.255

NOTE: Head SAR test results of WCDMA Band V

Test Position of Body-Worn with 10mm	Test channel /Freq.	Test Mode	SAR Value (W/kg)		Power Drift (±5%)	Conducted power (dBm)	Tune-up power (dBm)	Scaled SAR 1g (W/Kg)
			1g	10g				

Front Side	4182/836.4	RMC12.2K	0.386	0.300	0.08	23.98	24.00	0.388
Back Side	4182/836.4	RMC12.2K	0.383	0.295	1.25	23.98	24.00	0.385

NOTE: Body-Worn SAR test results of WCDMA Band V

Test Position of Hotspot with 10mm	Test channel /Freq.	Test Mode	SAR Value (W/kg)		Power Drift (±5%)	Conducted power (dBm)	Tune-up power (dBm)	Scaled SAR 1g (W/Kg)
			1g	10g				
Front Side	4182/836.4	RMC12.2K	0.386	0.300	0.08	23.98	24.00	0.388
Back Side	4182/836.4	RMC12.2K	0.383	0.295	1.25	23.98	24.00	0.385
Left Side	4182/836.4	RMC12.2K	0.202	0.143	0.07	23.98	24.00	0.203
Right Side	4182/836.4	RMC12.2K	0.235	0.174	0.25	23.98	24.00	0.236
Bottom Side	4182/836.4	RMC12.2K	0.210	0.153	0.31	23.98	24.00	0.211

NOTE: Hotspot SAR test results of WCDMA Band V

10.1.4. SAR measurement Result of WCDMA Band II

Test Position of Head	Test channel /Freq.	Test Mode	SAR Value (W/kg)		Power Drift (±5%)	Conducted power (dBm)	Tune-up power (dBm)	Scaled SAR 1g (W/Kg)
			1g	10g				
Left Cheek	9400/1880	RMC12.2K	0.570	0.348	-0.11	23.93	24.00	0.579
Left Tilt 15 Degree	9400/1880	RMC12.2K	0.265	0.175	0.54	23.93	24.00	0.269
Right Cheek	9400/1880	RMC12.2K	0.552	0.319	1.26	23.93	24.00	0.561
Right Tilt 15 Degree	9400/1880	RMC12.2K	0.254	0.168	3.01	23.93	24.00	0.258

NOTE: Head SAR test results of WCDMA Band II

Test Position of Body-Worn with 10mm	Test channel /Freq.	Test Mode	SAR Value (W/kg)		Power Drift (±5%)	Conducted power (dBm)	Tune-up power (dBm)	Scaled SAR 1g (W/Kg)
			1g	10g				
Front Side	9400/1880	RMC12.2K	0.736	0.450	-0.56	23.93	24.00	0.748
Back Side	9400/1880	RMC12.2K	1.010	0.597	-0.28	23.93	24.00	1.026
Back Side	9262/1852.4	RMC12.2K	1.059	0.630	0.11	23.85	24.00	1.096
Back Side - Repeated	9262/1852.4	RMC12.2K	1.042	0.623	1.36	23.85	24.00	1.079
Back Side	9538/1907.6	RMC12.2K	1.030	0.589	0.03	23.84	24.00	1.069

NOTE: Body-Worn SAR test results of WCDMA Band II

Test Position of Hotspot with 10mm	Test channel /Freq.	Test Mode	SAR Value (W/kg)		Power Drift (±5%)	Conducted power (dBm)	Tune-up power (dBm)	Scaled SAR 1g (W/Kg)
			1g	10g				

Front Side	9400/1880	RMC12.2K	0.736	0.450	-0.56	23.93	24.00	0.748
Back Side	9400/1880	RMC12.2K	1.010	0.597	-0.28	23.93	24.00	1.026
Left Side	9400/1880	RMC12.2K	0.427	0.276	-0.11	23.93	24.00	0.434
Right Side	9400/1880	RMC12.2K	0.562	0.310	0.25	23.93	24.00	0.571
Bottom Side	9400/1880	RMC12.2K	0.549	0.301	-0.20	23.93	24.00	0.558
Back Side	9262/1852.4	RMC12.2K	1.059	0.630	0.11	23.85	24.00	1.096
Back Side - Repeated	9262/1852.4	RMC12.2K	1.042	0.623	1.36	23.85	24.00	1.079
Back Side	9538/1907.6	RMC12.2K	1.030	0.589	0.03	23.84	24.00	1.069

NOTE: Hotspot SAR test results of WCDMA Band II

10.1.5. SAR measurement Result of LTE Band V

Test Position of Head	Test channel /Freq.	Test Mode	SAR Value (W/kg)		Power Drift (±5%)	Conducted power (dBm)	Tune-up power (dBm)	Scaled SAR 1g (W/Kg)
			1g	10g				
1RB								
Left Cheek	20525/836.5	10M QPSK(1,0)	0.439	0.342	-1.34	23.28	23.50	0.462
Left Tilt 15 Degree	20525/836.5	10M QPSK(1,0)	0.265	0.187	1.41	23.28	23.50	0.279
Right Cheek	20525/836.5	10M QPSK(1,0)	0.421	0.330	0.32	23.28	23.50	0.443
Right Tilt 15 Degree	20525/836.5	10M QPSK(1,0)	0.254	0.178	0.21	23.28	23.50	0.267
50%RB								
Left Cheek	20525/836.5	1.4M QPSK(3,1)	0.420	0.335	-0.49	23.18	23.50	0.452
Left Tilt 15 Degree	20525/836.5	1.4M QPSK(3,1)	0.241	0.175	1.04	23.18	23.50	0.259
Right Cheek	20525/836.5	1.4M QPSK(3,1)	0.410	0.321	1.26	23.18	23.50	0.441
Right Tilt 15 Degree	20525/836.5	1.4M QPSK(3,1)	0.230	0.162	0.26	23.18	23.50	0.248

NOTE: Head SAR test results of LTE Band V

Test Position of Body-Worn with 10mm	Test channel /Freq.	Test Mode	SAR Value (W/kg)		Power Drift (±5%)	Conducted power (dBm)	Tune-up power (dBm)	Scaled SAR 1g (W/Kg)
			1g	10g				
1RB								
Front Side	20525/836.5	10M QPSK(1,0)	0.470	0.363	0.27	23.28	23.50	0.494
Back Side	20525/836.5	10M QPSK(1,0)	0.492	0.378	-1.21	23.28	23.50	0.518
50%RB								
Front Side	20525/836.5	1.4M QPSK(3,1)	0.452	0.355	1.61	23.18	23.50	0.487
Back Side	20525/836.5	1.4M QPSK(3,1)	0.472	0.371	0.32	23.18	23.50	0.508

NOTE: Body-Worn SAR test results of LTE Band V

Test Position of Hotspot with 10mm	Test channel /Freq.	Test Mode	SAR Value (W/kg)		Power Drift (±5%)	Conducted power (dBm)	Tune-up power (dBm)	Scaled SAR 1g (W/Kg)
			1g	10g				
1RB								
Front Side	20525/836.5	10M QPSK(1,0)	0.470	0.363	0.27	23.28	23.50	0.494
Back Side	20525/836.5	10M QPSK(1,0)	0.492	0.378	-1.21	23.28	23.50	0.518
Left Side	20525/836.5	10M QPSK(1,0)	0.185	0.117	0.23	23.28	23.50	0.195
Right Side	20525/836.5	10M QPSK(1,0)	0.203	0.135	1.40	23.28	23.50	0.214
Bottom Side	20525/836.5	10M QPSK(1,0)	0.211	0.139	0.25	23.28	23.50	0.222
50%RB								
Front Side	20525/836.5	1.4M QPSK(3,1)	0.452	0.355	1.61	23.18	23.50	0.487
Back Side	20525/836.5	1.4M QPSK(3,1)	0.472	0.371	0.32	23.18	23.50	0.508
Left Side	20525/836.5	1.4M QPSK(3,1)	0.173	0.108	0.13	23.18	23.50	0.186
Right Side	20525/836.5	1.4M QPSK(3,1)	0.195	0.123	2.51	23.18	23.50	0.210
Bottom Side	20525/836.5	1.4M QPSK(3,1)	0.198	0.128	3.04	23.18	23.50	0.213

NOTE: Hotspot SAR test results of LTE Band V

10.1.6. SAR measurement Result of LTE Band IV

Test Position of Head	Test channel /Freq.	Test Mode	SAR Value (W/kg)		Power Drift (±5%)	Conducted power (dBm)	Tune-up power (dBm)	Scaled SAR 1g (W/Kg)
			1g	10g				
1RB								
Left Cheek	20175/1732.5	20M QPSK(1,49)	0.580	0.370	-1.32	23.57	24.00	0.640
Left Tilt 15 Degree	20175/1732.5	20M QPSK(1,49)	0.236	0.165	0.32	23.57	24.00	0.261
Right Cheek	20175/1732.5	20M QPSK(1,49)	0.562	0.354	1.25	23.57	24.00	0.620
Right Tilt 15 Degree	20175/1732.5	20M QPSK(1,49)	0.223	0.152	1.04	23.57	24.00	0.246
50%RB								
Left Cheek	20175/1732.5	1.4M QPSK(3,0)	0.570	0.356	0.25	23.62	24.00	0.622
Left Tilt 15 Degree	20175/1732.5	1.4M QPSK(3,0)	0.214	0.152	1.26	23.62	24.00	0.234
Right Cheek	20175/1732.5	1.4M QPSK(3,0)	0.552	0.331	3.24	23.62	24.00	0.602
Right Tilt 15 Degree	20175/1732.5	1.4M QPSK(3,0)	0.201	0.138	2.54	23.62	24.00	0.219

NOTE: Head SAR test results of LTE Band IV

Test Position of Body-Worn with 10mm	Test channel /Freq.	Test Mode	SAR Value (W/kg)		Power Drift (±5%)	Conducted power (dBm)	Tune-up power (dBm)	Scaled SAR 1g (W/Kg)
			1g	10g				
1RB								
Front Side	20175/1732.5	20M QPSK(1,49)	0.712	0.520	3.20	23.57	24.00	0.786
Back Side	20175/1732.5	20M QPSK(1,49)	1.100	0.786	-0.03	23.57	24.00	1.214
Back Side	20050/1720	20M QPSK(1,49)	1.112	0.789	-0.39	23.65	24.00	1.205
Back Side	20050/1720	20M QPSK(1,49)	1.108	0.785	2.32	23.65	24.00	1.201

- Repeated								
Back Side	20300/1745	20M QPSK(1,49)	1.105	0.773	0.38	23.79	24.00	1.160
50%RB								
Front Side	20175/1732. 5	1.4M QPSK(3,0)	0.685	0.503	0.21	23.62	24.00	0.748
Back Side	20175/1732. 5	1.4M QPSK(3,0)	1.079	0.756	1.20	23.62	24.00	1.178
Back Side	20050/1720	1.4M QPSK(3,0)	1.084	0.771	1.47	23.55	24.00	1.202
Back Side - Repeated	20050/1720	1.4M QPSK(3,0)	1.080	0.763	1.25	23.55	24.00	1.198
Back Side	20300/1745	1.4M QPSK(3,0)	1.078	0.750	0.32	23.60	24.00	1.182
100%RB								
Back Side	20175/1732. 5	20M QPSK(100,0)	0.678	0.437	0.27	22.00	23.00	0.854

NOTE: Body-Worn SAR test results of LTE Band IV

Test Position of Hotspot with 10mm	Test channel /Freq.	Test Mode	SAR Value (W/kg)		Power Drift (±5%)	Conducted power (dBm)	Tune-up power (dBm)	Scaled SAR 1g (W/Kg)
			1g	10g				
1RB								
Front Side	20175/1732. 5	20M QPSK(1,49)	0.712	0.520	3.20	23.57	24.00	0.786
Back Side	20175/1732. 5	20M QPSK(1,49)	1.100	0.786	-0.03	23.57	24.00	1.214
Left Side	20175/1732. 5	20M QPSK(1,49)	0.337	0.219	0.13	23.57	24.00	0.372
Right Side	20175/1732. 5	20M QPSK(1,49)	0.452	0.263	0.25	23.57	24.00	0.499
Bottom Side	20175/1732. 5	20M QPSK(1,49)	0.453	0.266	-0.71	23.57	24.00	0.500
Back Side	20050/1720	20M QPSK(1,49)	1.112	0.789	-0.39	23.65	24.00	1.205
Back Side - Repeated	20050/1720	20M QPSK(1,49)	1.108	0.785	2.32	23.65	24.00	1.201
Back Side	20300/1745	20M QPSK(1,49)	1.105	0.773	0.38	23.79	24.00	1.160
50%RB								
Front Side	20175/1732. 5	1.4M QPSK(3,0)	0.685	0.503	0.21	23.62	24.00	0.748
Back Side	20175/1732.	1.4M QPSK(3,0)	1.079	0.756	1.20	23.62	24.00	1.178

	5							
Left Side	20175/1732. 5	1.4M QPSK(3,0)	0.373	0.213	0.09	23.62	24.00	0.407
Right Side	20175/1732. 5	1.4M QPSK(3,0)	0.421	0.246	3.21	23.62	24.00	0.459
Bottom Side	20175/1732. 5	1.4M QPSK(3,0)	0.416	0.231	0.18	23.62	24.00	0.454
Back Side	20050/1720	1.4M QPSK(3,0)	1.084	0.771	1.47	23.55	24.00	1.202
Back Side - Repeated	20050/1720	1.4M QPSK(3,0)	1.080	0.763	1.25	23.55	24.00	1.198
Back Side	20300/1745	1.4M QPSK(3,0)	1.078	0.750	0.32	23.60	24.00	1.182
100%RB								
Back Side	20175/1732. 5	20M QPSK(100,0)	0.678	0.437	0.27	22.00	23.00	0.854

NOTE: Hotspot SAR test results of LTE Band IV

10.1.7. SAR measurement Result of LTE Band II

Test Position of Head	Test channel /Freq.	Test Mode	SAR Value (W/kg)		Power Drift (±5%)	Conducted power (dBm)	Tune-up power (dBm)	Scaled SAR 1g (W/Kg)
			1g	10g				
1RB								
Left Cheek	18900/1880	20M QPSK(1,99)	0.663	0.403	-1.27	23.64	24.00	0.720
Left Tilt 15 Degree	18900/1880	20M QPSK(1,99)	0.398	0.256	3.24	23.64	24.00	0.432
Right Cheek	18900/1880	20M QPSK(1,99)	0.642	0.387	1.26	23.64	24.00	0.697
Right Tilt 15 Degree	18900/1880	20M QPSK(1,99)	0.384	0.248	0.74	23.64	24.00	0.417
50%RB								
Left Cheek	18900/1880	1.4M QPSK(3,0)	0.640	0.387	1.47	23.54	24.00	0.712
Left Tilt 15 Degree	18900/1880	1.4M QPSK(3,0)	0.374	0.241	2.61	23.54	24.00	0.416
Right Cheek	18900/1880	1.4M QPSK(3,0)	0.622	0.371	0.37	23.54	24.00	0.691

Right Tilt 15 Degree	18900/1880	1.4M QPSK(3,0)	0.365	0.233	1.54	23.54	24.00	0.406
----------------------	------------	----------------	-------	-------	------	-------	-------	-------

NOTE: Head SAR test results of LTE Band II

Test Position of Body-Worn with 10mm	Test channel /Freq.	Test Mode	SAR Value (W/kg)		Power Drift (±5%)	Conducted power (dBm)	Tune-up power (dBm)	Scaled SAR 1g (W/Kg)
			1g	10g				
1RB								
Front Side	18900/1880	20M QPSK(1,99)	0.734	0.458	-0.42	23.64	24.00	0.797
Back Side	18900/1880	20M QPSK(1,99)	1.106	0.758	1.68	23.64	24.00	1.202
Back Side	18700/1860	20M QPSK(1,99)	1.121	0.806	-2.54	23.41	24.00	1.284
Back Side - Repeated	18700/1860	20M QPSK(1,99)	1.114	0.795	2.51	23.41	24.00	1.276
Back Side	19100/1900	20M QPSK(1,99)	1.109	0.729	-0.02	23.65	24.00	1.202
50%RB								
Front Side	18900/1880	1.4M QPSK(3,0)	0.702	0.451	3.21	23.54	24.00	0.780
Back Side	18900/1880	1.4M QPSK(3,0)	1.081	0.732	2.54	23.54	24.00	1.202
Back Side	18700/1860	1.4M QPSK(3,0)	1.115	0.786	-0.14	23.43	24.00	1.271
Back Side - Repeated	18700/1860	1.4M QPSK(3,0)	1.110	0.781	-2.17	23.43	24.00	1.266
Back Side	19100/1900	1.4M QPSK(3,0)	1.106	0.750	3.28	23.67	24.00	1.193
100%RB								
Back Side	18900/1880	20M QPSK(100,0)	0.617	0.399	-0.15	21.99	23.00	0.779

NOTE: Body-Worn SAR test results of LTE Band II

Test Position of Hotspot with 10mm	Test channel /Freq.	Test Mode	SAR Value (W/kg)		Power Drift (±5%)	Conducted power (dBm)	Tune-up power (dBm)	Scaled SAR 1g (W/Kg)
			1g	10g				
1RB								
Front Side	18900/1880	20M QPSK(1,99)	0.734	0.458	-0.42	23.64	24.00	0.797
Back Side	18900/1880	20M QPSK(1,99)	1.106	0.758	1.68	23.64	24.00	1.202
Left Side	18900/1880	20M QPSK(1,99)	0.593	0.347	-0.12	23.64	24.00	0.644
Right Side	18900/1880	20M QPSK(1,99)	0.681	0.394	-0.41	23.64	24.00	0.740

Bottom Side	18900/1880	20M QPSK(1,99)	0.649	0.354	-0.26	23.64	24.00	0.705
Back Side	18700/1860	20M QPSK(1,99)	1.121	0.806	-2.54	23.41	24.00	1.284
Back Side - Repeated	18700/1860	20M QPSK(1,99)	1.114	0.795	2.51	23.41	24.00	1.276
Back Side	19100/1900	20M QPSK(1,99)	1.109	0.729	-0.02	23.65	24.00	1.202
50%RB								
Front Side	18900/1880	1.4M QPSK(3,0)	0.702	0.451	3.21	23.54	24.00	0.780
Back Side	18900/1880	1.4M QPSK(3,0)	1.081	0.732	2.54	23.54	24.00	1.202
Left Side	18900/1880	1.4M QPSK(3,0)	0.533	0.327	0.03	23.54	24.00	0.593
Right Side	18900/1880	1.4M QPSK(3,0)	0.652	0.375	1.02	23.54	24.00	0.725
Bottom Side	18900/1880	1.4M QPSK(3,0)	0.631	0.336	0.62	23.54	24.00	0.702
Back Side	18700/1860	1.4M QPSK(3,0)	1.115	0.786	-0.14	23.43	24.00	1.271
Back Side - Repeated	18700/1860	1.4M QPSK(3,0)	1.110	0.781	-2.17	23.43	24.00	1.266
Back Side	19100/1900	1.4M QPSK(3,0)	1.106	0.750	3.28	23.67	24.00	1.193
100%RB								
Back Side	18900/1880	20M QPSK(100,0)	0.617	0.399	-0.15	21.99	23.00	0.779

NOTE: Hotspot SAR test results of LTE Band II

10.1.8. SAR measurement Result of LTE Band VII

Test Position of Head	Test channel /Freq.	Test Mode	SAR Value (W/kg)		Power Drift (±5%)	Conducted power (dBm)	Tune-up power (dBm)	Scaled SAR 1g (W/Kg)
			1g	10g				
1RB								
Left Cheek	21100/2535	20M QPSK(1,99)	0.132	0.082	-0.04	23.07	23.50	0.146
Left Tilt 15 Degree	21100/2535	20M QPSK(1,99)	0.061	0.041	0.25	23.07	23.50	0.067
Right Cheek	21100/2535	20M QPSK(1,99)	0.113	0.074	1.47	23.07	23.50	0.125
Right Tilt 15 Degree	21100/2535	20M QPSK(1,99)	0.058	0.037	-3.25	23.07	23.50	0.064

50%RB								
Left Cheek	21100/2535	20M QPSK(50,49)	0.120	0.075	2.65	22.08	22.50	0.132
Left Tilt 15 Degree	21100/2535	20M QPSK(50,49)	0.054	0.036	-1.47	22.08	22.50	0.059
Right Cheek	21100/2535	20M QPSK(50,49)	0.106	0.068	0.27	22.08	22.50	0.117
Right Tilt 15 Degree	21100/2535	20M QPSK(50,49)	0.051	0.032	3.61	22.08	22.50	0.056

NOTE: Head SAR test results of LTE Band VII

Test Position of Body-Worn with 10mm	Test channel /Freq.	Test Mode	SAR Value (W/kg)		Power Drift ($\pm 5\%$)	Conducted power (dBm)	Tune-up power (dBm)	Scaled SAR 1g (W/Kg)
			1g	10g				
1RB								
Front Side	21100/2535	20M QPSK(1,99)	0.312	0.160	1.04	23.07	23.50	0.344
Back Side	21100/2535	20M QPSK(1,99)	0.406	0.215	-0.19	23.07	23.50	0.448
50%RB								
Front Side	21100/2535	20M QPSK(50,49)	0.304	0.152	1.51	22.08	22.50	0.335
Back Side	21100/2535	20M QPSK(50,49)	0.387	0.198	0.36	22.08	22.50	0.426

NOTE: Body-Worn SAR test results of LTE Band VII

Test Position of Hotspot with 10mm	Test channel /Freq.	Test Mode	SAR Value (W/kg)		Power Drift ($\pm 5\%$)	Conducted power (dBm)	Tune-up power (dBm)	Scaled SAR 1g (W/Kg)
			1g	10g				
1RB								
Front Side	21100/2535	20M QPSK(1,99)	0.312	0.160	1.04	23.07	23.50	0.344
Back Side	21100/2535	20M QPSK(1,99)	0.406	0.215	-0.19	23.07	23.50	0.448
Left Side	21100/2535	20M QPSK(1,99)	0.487	0.227	0.13	23.07	23.50	0.538
Right Side	21100/2535	20M QPSK(1,99)	0.521	0.252	1.75	23.07	23.50	0.575
Bottom	21100/2535	20M	0.672	0.338	-0.40	23.07	23.50	0.742

Side		QPSK(1,99)						
50%RB								
Front Side	21100/2535	20M QPSK(50,49)	0.304	0.152	1.51	22.08	22.50	0.335
Back Side	21100/2535	20M QPSK(50,49)	0.387	0.198	0.36	22.08	22.50	0.426
Left Side	21100/2535	20M QPSK(50,49)	0.483	0.207	0.02	22.08	22.50	0.532
Right Side	21100/2535	20M QPSK(50,49)	0.511	0.241	1.40	22.08	22.50	0.563
Bottom Side	21100/2535	20M QPSK(50,49)	0.653	0.312	1.41	22.08	22.50	0.719

NOTE: Hotspot SAR test results of LTE Band VII

10.1.9. SAR measurement Result of WLAN 2.4G

Test Position of Head	Test channel /Freq.	Test Mode	SAR Value (W/kg)		Power Drift (±5%)	Conducted power (dBm)	Tune-up power (dBm)	Scaled SAR 1g (W/Kg)
			1g	10g				
Left Cheek	6/2437	802.11 b	0.184	0.119	-2.27	11.20	12.00	0.221
Left Tilt 15 Degree	6/2437	802.11 b	0.098	0.051	1.25	11.20	12.00	0.118
Right Cheek	6/2437	802.11 b	0.170	0.111	3.14	11.20	12.00	0.204
Right Tilt 15 Degree	6/2437	802.11 b	0.087	0.046	2.51	11.20	12.00	0.105

NOTE: Head SAR test results of WLAN 2.4G

Test Position of Body-Worn with 10mm	Test channel /Freq.	Test Mode	SAR Value (W/kg)		Power Drift (±5%)	Conducted power (dBm)	Tune-up power (dBm)	Scaled SAR 1g (W/Kg)
			1g	10g				
Front Side	6/2437	802.11 b	0.210	0.128	1.09	11.20	12.00	0.252
Back Side	6/2437	802.11 b	0.195	0.108	-2.36	11.20	12.00	0.234

NOTE: Body-Worn SAR test results of WLAN 2.4G

Test Position of Hotspot with 10mm	Test channel /Freq.	Test Mode	SAR Value (W/kg)		Power Drift (±5%)	Conducted power (dBm)	Tune-up power (dBm)	Scaled SAR 1g (W/Kg)
			1g	10g				
Front Side	6/2437	802.11 b	0.210	0.128	1.09	11.20	12.00	0.252

Back Side	6/2437	802.11 b	0.195	0.108	-2.36	11.20	12.00	0.234
Left Side	6/2437	802.11 b	0.101	0.067	-3.55	11.20	12.00	0.121
Top Side	6/2437	802.11 b	0.199	0.111	-3.31	11.20	12.00	0.239

NOTE: Hotspot SAR test results of WLAN 2.4G

10.2. SAR Summation Scenario

Per KDB 447498 D01, simultaneous transmission SAR is compliant if,

- 1) Scalar SAR summation < 1.6W/kg.
- 2) SPLSR = $(SAR_1 + SAR_2)^{1.5} / (\text{min. separation distance, mm})$, and the peak separation distance is determined from the square root of $[(x_1-x_2)^2 + (y_1-y_2)^2 + (z_1-z_2)^2]$, where (x_1, y_1, z_1) and (x_2, y_2, z_2) are the coordinates of the extrapolated peak SAR locations in the zoom scan. If $SPLSR \leq 0.04$, simultaneously transmission SAR measurement is not necessary.

Test Position		Scaled SAR _{MAX}		Σ 1-g SAR (W/Kg)	SPLSR	Remark
		GSM 850	WLAN 2.4G			
Head	Left Cheek	0.404	0.221	0.625	N/A	N/A
	Left Tilt 15 Degree	0.290	0.118	0.407	N/A	N/A
	Right Cheek	0.389	0.204	0.593	N/A	N/A
	Right Tilt 15 Degree	0.272	0.105	0.377	N/A	N/A
Body-Worn	Front Side	0.427	0.252	0.679	N/A	N/A
	Back Side	0.445	0.234	0.680	N/A	N/A
Hotspot	Front Side	0.427	0.252	0.679	N/A	N/A
	Back Side	0.445	0.234	0.680	N/A	N/A
	Left Side	0.214	0.121	0.335	N/A	N/A
	Right Side	0.225	N/A	0.225	N/A	N/A
	Top Side	N/A	0.239	0.239	N/A	N/A
	Bottom Side	0.208	N/A	0.208	N/A	N/A

NOTE: 1-g SAR Simultaneous Tx Combination of GSM850 and WLAN 2.4G.

Test Position		Scaled SAR _{MAX}		Σ 1-g SAR (W/Kg)	SPLSR	Remark
		GSM 1900	WLAN 2.4G			
Head	Left Cheek	0.324	0.221	0.545	N/A	N/A
	Left Tilt 15 Degree	0.144	0.118	0.261	N/A	N/A
	Right Cheek	0.307	0.204	0.511	N/A	N/A
	Right Tilt 15 Degree	0.137	0.105	0.241	N/A	N/A
Body-Worn	Front Side	0.482	0.252	0.734	N/A	N/A
	Back Side	0.679	0.234	0.913	N/A	N/A
Hotspot	Front Side	0.482	0.252	0.734	N/A	N/A
	Back Side	0.679	0.234	0.913	N/A	N/A

	Left Side	0.216	0.121	0.338	N/A	N/A
	Right Side	0.281	N/A	0.281	N/A	N/A
	Top Side	N/A	0.239	0.239	N/A	N/A
	Bottom Side	0.361	N/A	0.361	N/A	N/A

NOTE: 1-g SAR Simultaneous Tx Combination of GSM1900 and WLAN 2.4G.

Test Position		Scaled SAR _{MAX}		Σ 1-g SAR (W/Kg)	SPLSR	Remark
		WCDMA Band V	WLAN 2.4G			
Head	Left Cheek	0.371	0.221	0.592	N/A	N/A
	Left Tilt 15 Degree	0.275	0.118	0.393	N/A	N/A
	Right Cheek	0.306	0.204	0.511	N/A	N/A
	Right Tilt 15 Degree	0.255	0.105	0.360	N/A	N/A
Body-Worn	Front Side	0.388	0.252	0.640	N/A	N/A
	Back Side	0.385	0.234	0.619	N/A	N/A
Hotspot	Front Side	0.388	0.252	0.640	N/A	N/A
	Back Side	0.385	0.234	0.619	N/A	N/A
	Left Side	0.203	0.121	0.324	N/A	N/A
	Right Side	0.236	N/A	0.236	N/A	N/A
	Top Side	N/A	0.239	0.239	N/A	N/A
	Bottom Side	0.211	N/A	0.211	N/A	N/A

NOTE: 1-g SAR Simultaneous Tx Combination of WCDMA Band V and WLAN 2.4G.

Test Position		Scaled SAR _{MAX}		Σ 1-g SAR (W/Kg)	SPLSR	Remark
		WCDMA Band II	WLAN 2.4G			
Head	Left Cheek	0.579	0.221	0.800	N/A	N/A
	Left Tilt 15 Degree	0.269	0.118	0.387	N/A	N/A
	Right Cheek	0.561	0.204	0.765	N/A	N/A
	Right Tilt 15 Degree	0.258	0.105	0.363	N/A	N/A
Body-Worn	Front Side	0.748	0.252	1.000	N/A	N/A
	Back Side	1.096	0.234	1.331	N/A	N/A
Hotspot	Front Side	0.748	0.252	1.000	N/A	N/A
	Back Side	1.096	0.234	1.331	N/A	N/A
	Left Side	0.434	0.121	0.555	N/A	N/A
	Right Side	0.571	N/A	0.571	N/A	N/A
	Top Side	N/A	0.239	0.239	N/A	N/A
	Bottom Side	0.558	N/A	0.558	N/A	N/A

NOTE: 1-g SAR Simultaneous Tx Combination of WCDMA Band II and WLAN 2.4G.

Test Position		Scaled SAR _{MAX}		Σ 1-g SAR (W/Kg)	SPLSR	Remark
		LTE Band V	WLAN 2.4G			
Head	Left Cheek	0.462	0.221	0.683	N/A	N/A
	Left Tilt 15 Degree	0.279	0.118	0.397	N/A	N/A
	Right Cheek	0.443	0.204	0.647	N/A	N/A
	Right Tilt 15 Degree	0.267	0.105	0.372	N/A	N/A
Body-Worn	Front Side	0.494	0.252	0.747	N/A	N/A
	Back Side	0.518	0.234	0.752	N/A	N/A
Hotspot	Front Side	0.494	0.252	0.747	N/A	N/A
	Back Side	0.518	0.234	0.752	N/A	N/A
	Left Side	0.195	0.121	0.316	N/A	N/A
	Right Side	0.214	N/A	0.214	N/A	N/A
	Top Side	N/A	0.239	0.239	N/A	N/A
	Bottom Side	0.222	N/A	0.222	N/A	N/A

NOTE: 1-g SAR Simultaneous Tx Combination of LTE Band V and WLAN 2.4G.

Test Position		Scaled SAR _{MAX}		Σ 1-g SAR (W/Kg)	SPLSR	Remark
		LTE Band IV	WLAN 2.4G			
Head	Left Cheek	0.640	0.221	0.862	N/A	N/A
	Left Tilt 15 Degree	0.261	0.118	0.378	N/A	N/A
	Right Cheek	0.620	0.204	0.825	N/A	N/A
	Right Tilt 15 Degree	0.246	0.105	0.351	N/A	N/A
Body-Worn	Front Side	0.786	0.252	1.039	N/A	N/A
	Back Side	1.214	0.234	1.449	N/A	N/A
Hotspot	Front Side	0.786	0.252	1.039	N/A	N/A
	Back Side	1.214	0.234	1.449	N/A	N/A
	Left Side	0.372	0.121	0.494	N/A	N/A
	Right Side	0.499	N/A	0.499	N/A	N/A
	Top Side	N/A	0.239	0.239	N/A	N/A
	Bottom Side	0.500	N/A	0.500	N/A	N/A

NOTE: 1-g SAR Simultaneous Tx Combination of LTE Band IV and WLAN 2.4G.

Test Position		Scaled SAR _{MAX}		Σ 1-g SAR (W/Kg)	SPLSR	Remark
		LTE Band II	WLAN 2.4G			
Head	Left Cheek	0.720	0.221	0.942	N/A	N/A
	Left Tilt 15 Degree	0.432	0.118	0.550	N/A	N/A
	Right Cheek	0.697	0.204	0.902	N/A	N/A
	Right Tilt 15 Degree	0.417	0.105	0.522	N/A	N/A

Body-Worn	Front Side	0.797	0.252	1.050	N/A	N/A
	Back Side	1.284	0.234	1.518	N/A	N/A
Hotspot	Front Side	0.797	0.252	1.050	N/A	N/A
	Back Side	1.284	0.234	1.518	N/A	N/A
	Left Side	0.644	0.121	0.766	N/A	N/A
	Right Side	0.740	N/A	0.740	N/A	N/A
	Top Side	N/A	0.239	0.239	N/A	N/A
	Bottom Side	0.705	N/A	0.705	N/A	N/A

NOTE: 1-g SAR Simultaneous Tx Combination of LTE Band II and WLAN 2.4G.

Test Position		Scaled SAR _{MAX}		Σ 1-g SAR (W/Kg)	SPLSR	Remark
		LTE Band VII	WLAN 2.4G			
Head	Left Cheek	0.146	0.221	0.367	N/A	N/A
	Left Tilt 15 Degree	0.067	0.118	0.185	N/A	N/A
	Right Cheek	0.125	0.204	0.329	N/A	N/A
	Right Tilt 15 Degree	0.064	0.105	0.169	N/A	N/A
Body-Worn	Front Side	0.344	0.252	0.597	N/A	N/A
	Back Side	0.448	0.234	0.683	N/A	N/A
Hotspot	Front Side	0.344	0.252	0.597	N/A	N/A
	Back Side	0.448	0.234	0.683	N/A	N/A
	Left Side	0.538	0.121	0.659	N/A	N/A
	Right Side	0.575	N/A	0.575	N/A	N/A
	Top Side	N/A	0.239	0.239	N/A	N/A
	Bottom Side	0.742	N/A	0.742	N/A	N/A

NOTE: 1-g SAR Simultaneous Tx Combination of LTE Band VII and WLAN 2.4G.

Test Position		Scaled SAR _{MAX}		Σ 1-g SAR (W/Kg)	SPLSR	Remark
		GSM 850	Bluetooth			
Head	Left Cheek	0.404	0.133	0.537	N/A	N/A
	Left Tilt 15 Degree	0.290	0.133	0.423	N/A	N/A
	Right Cheek	0.389	0.133	0.522	N/A	N/A
	Right Tilt 15 Degree	0.272	0.133	0.405	N/A	N/A
Body-Worn	Front Side	0.427	0.066	0.493	N/A	N/A
	Back Side	0.445	0.066	0.511	N/A	N/A
Hotspot	Front Side	0.427	0.066	0.493	N/A	N/A
	Back Side	0.445	0.066	0.511	N/A	N/A
	Left Side	0.214	0.066	0.280	N/A	N/A

	Right Side	0.225	N/A	0.225	N/A	N/A
	Top Side	N/A	0.066	0.066	N/A	N/A
	Bottom Side	0.208	N/A	0.208	N/A	N/A

NOTE: 1-g SAR Simultaneous Tx Combination of GSM850 and Bluetooth.

Test Position		Scaled SAR _{MAX}		Σ 1-g SAR (W/Kg)	SPLSR	Remark
		GSM 1900	Bluetooth			
Head	Left Cheek	0.324	0.133	0.457	N/A	N/A
	Left Tilt 15 Degree	0.144	0.133	0.277	N/A	N/A
	Right Cheek	0.307	0.133	0.440	N/A	N/A
	Right Tilt 15 Degree	0.137	0.133	0.270	N/A	N/A
Body-Worn	Front Side	0.482	0.066	0.548	N/A	N/A
	Back Side	0.679	0.066	0.745	N/A	N/A
Hotspot	Front Side	0.482	0.066	0.548	N/A	N/A
	Back Side	0.679	0.066	0.745	N/A	N/A
	Left Side	0.216	0.066	0.282	N/A	N/A
	Right Side	0.281	N/A	0.281	N/A	N/A
	Top Side	N/A	0.066	0.066	N/A	N/A
	Bottom Side	0.361	N/A	0.361	N/A	N/A

NOTE: 1-g SAR Simultaneous Tx Combination of GSM1900 and Bluetooth.

Test Position		Scaled SAR _{MAX}		Σ 1-g SAR (W/Kg)	SPLSR	Remark
		WCDMA Band V	Bluetooth			
Head	Left Cheek	0.371	0.133	0.504	N/A	N/A
	Left Tilt 15 Degree	0.275	0.133	0.408	N/A	N/A
	Right Cheek	0.306	0.133	0.439	N/A	N/A
	Right Tilt 15 Degree	0.255	0.133	0.388	N/A	N/A
Body-Worn	Front Side	0.388	0.066	0.454	N/A	N/A
	Back Side	0.385	0.066	0.451	N/A	N/A
Hotspot	Front Side	0.388	0.066	0.454	N/A	N/A
	Back Side	0.385	0.066	0.451	N/A	N/A
	Left Side	0.203	0.066	0.269	N/A	N/A
	Right Side	0.236	N/A	0.236	N/A	N/A
	Top Side	N/A	0.066	0.066	N/A	N/A
	Bottom Side	0.211	N/A	0.211	N/A	N/A

NOTE: 1-g SAR Simultaneous Tx Combination of WCDMA Band V and Bluetooth.

Test Position		Scaled SAR _{MAX}		Σ 1-g SAR (W/Kg)	SPLSR	Remark
		WCDMA	Bluetooth			

		Band II				
Head	Left Cheek	0.579	0.133	0.712	N/A	N/A
	Left Tilt 15 Degree	0.269	0.133	0.402	N/A	N/A
	Right Cheek	0.561	0.133	0.694	N/A	N/A
	Right Tilt 15 Degree	0.258	0.133	0.391	N/A	N/A
Body-Worn	Front Side	0.748	0.066	0.814	N/A	N/A
	Back Side	1.096	0.066	1.162	N/A	N/A
Hotspot	Front Side	0.748	0.066	0.814	N/A	N/A
	Back Side	1.096	0.066	1.162	N/A	N/A
	Left Side	0.434	0.066	0.500	N/A	N/A
	Right Side	0.571	N/A	0.571	N/A	N/A
	Top Side	N/A	0.066	0.066	N/A	N/A
	Bottom Side	0.558	N/A	0.558	N/A	N/A

NOTE: 1-g SAR Simultaneous Tx Combination of WCDMA Band II and Bluetooth.

Test Position		Scaled SAR _{MAX}		Σ 1-g SAR (W/Kg)	SPLSR	Remark
		LTE Band V	Bluetooth			
Head	Left Cheek	0.462	0.133	0.595	N/A	N/A
	Left Tilt 15 Degree	0.279	0.133	0.412	N/A	N/A
	Right Cheek	0.443	0.133	0.576	N/A	N/A
	Right Tilt 15 Degree	0.267	0.133	0.400	N/A	N/A
Body-Worn	Front Side	0.494	0.066	0.560	N/A	N/A
	Back Side	0.518	0.066	0.584	N/A	N/A
Hotspot	Front Side	0.494	0.066	0.560	N/A	N/A
	Back Side	0.518	0.066	0.584	N/A	N/A
	Left Side	0.195	0.066	0.261	N/A	N/A
	Right Side	0.214	N/A	0.214	N/A	N/A
	Top Side	N/A	0.066	0.066	N/A	N/A
	Bottom Side	0.222	N/A	0.222	N/A	N/A

NOTE: 1-g SAR Simultaneous Tx Combination of LTE Band V and Bluetooth.

Test Position		Scaled SAR _{MAX}		Σ 1-g SAR (W/Kg)	SPLSR	Remark
		LTE Band IV	Bluetooth			
Head	Left Cheek	0.640	0.133	0.773	N/A	N/A
	Left Tilt 15 Degree	0.261	0.133	0.394	N/A	N/A
	Right Cheek	0.620	0.133	0.753	N/A	N/A
	Right Tilt 15 Degree	0.246	0.133	0.379	N/A	N/A
Body-Worn	Front Side	0.786	0.066	0.852	N/A	N/A

	Back Side	1.214	0.066	1.280	N/A	N/A
Hotspot	Front Side	0.786	0.066	0.852	N/A	N/A
	Back Side	1.214	0.066	1.280	N/A	N/A
	Left Side	0.372	0.066	0.438	N/A	N/A
	Right Side	0.499	N/A	0.499	N/A	N/A
	Top Side	N/A	0.066	0.066	N/A	N/A
	Bottom Side	0.500	N/A	0.500	N/A	N/A

NOTE: 1-g SAR Simultaneous Tx Combination of LTE Band IV and Bluetooth.

Test Position		Scaled SAR _{MAX}		Σ 1-g SAR (W/Kg)	SPLSR	Remark
		LTE Band II	Bluetooth			
Head	Left Cheek	0.720	0.133	0.853	N/A	N/A
	Left Tilt 15 Degree	0.432	0.133	0.565	N/A	N/A
	Right Cheek	0.697	0.133	0.830	N/A	N/A
	Right Tilt 15 Degree	0.417	0.133	0.550	N/A	N/A
Body-Worn	Front Side	0.797	0.066	0.863	N/A	N/A
	Back Side	1.284	0.066	1.350	N/A	N/A
Hotspot	Front Side	0.797	0.066	0.863	N/A	N/A
	Back Side	1.284	0.066	1.350	N/A	N/A
	Left Side	0.644	0.066	0.710	N/A	N/A
	Right Side	0.740	N/A	0.740	N/A	N/A
	Top Side	N/A	0.066	0.066	N/A	N/A
	Bottom Side	0.705	N/A	0.705	N/A	N/A

NOTE: 1-g SAR Simultaneous Tx Combination of LTE Band II and Bluetooth.

Test Position		Scaled SAR _{MAX}		Σ 1-g SAR (W/Kg)	SPLSR	Remark
		LTE Band VII	Bluetooth			
Head	Left Cheek	0.146	0.133	0.279	N/A	N/A
	Left Tilt 15 Degree	0.067	0.133	0.200	N/A	N/A
	Right Cheek	0.125	0.133	0.258	N/A	N/A
	Right Tilt 15 Degree	0.064	0.133	0.197	N/A	N/A
Body-Worn	Front Side	0.344	0.066	0.410	N/A	N/A
	Back Side	0.448	0.066	0.514	N/A	N/A
Hotspot	Front Side	0.344	0.066	0.410	N/A	N/A
	Back Side	0.448	0.066	0.514	N/A	N/A
	Left Side	0.538	0.066	0.604	N/A	N/A
	Right Side	0.575	N/A	0.575	N/A	N/A
	Top Side	N/A	0.066	0.066	N/A	N/A

	Bottom Side	0.742	N/A	0.742	N/A	N/A
--	-------------	-------	-----	-------	-----	-----

NOTE: 1-g SAR Simultaneous Tx Combination of LTE Band VII and Bluetooth.

11. Appendix A. Photo documentation

Refer to appendix Test Setup photo---SAR

12. Appendix B. System Check Plots

Table of contents
MEASUREMENT 1 System Performance Check - SID835 - Head
MEASUREMENT 2 System Performance Check - SID835 - Body
MEASUREMENT 3 System Performance Check - SID1800 - Head
MEASUREMENT 4 System Performance Check - SID1800 - Body
MEASUREMENT 5 System Performance Check - SID1900 - Head
MEASUREMENT 6 System Performance Check - SID1900 - Body
MEASUREMENT 7 System Performance Check - SID2450 - Head
MEASUREMENT 8 System Performance Check - SID2450 - Body
MEASUREMENT 9 System Performance Check - SID2600 - Head
MEASUREMENT 10 System Performance Check - SID2600 - Body

MEASUREMENT 1

A. Experimental conditions.

Area Scan	<u>dx=15mm dy=15mm, h= 5.00 mm</u>
ZoomScan	<u>5x5x7,dx=8mm dy=8mm dz=5mm</u>
Phantom	<u>Validation plane</u>
Device Position	<u>Dipole</u>
Band	<u>CW835</u>
Channels	<u>Middle</u>
Signal	<u>CW (Crest factor: 1.0)</u>

B. SAR Measurement Results

Frequency (MHz)	835.000000
Relative permittivity (real part)	41.350587
Relative permittivity (imaginary part)	19.742612
Conductivity (S/m)	0.920065
Variation (%)	0.010000

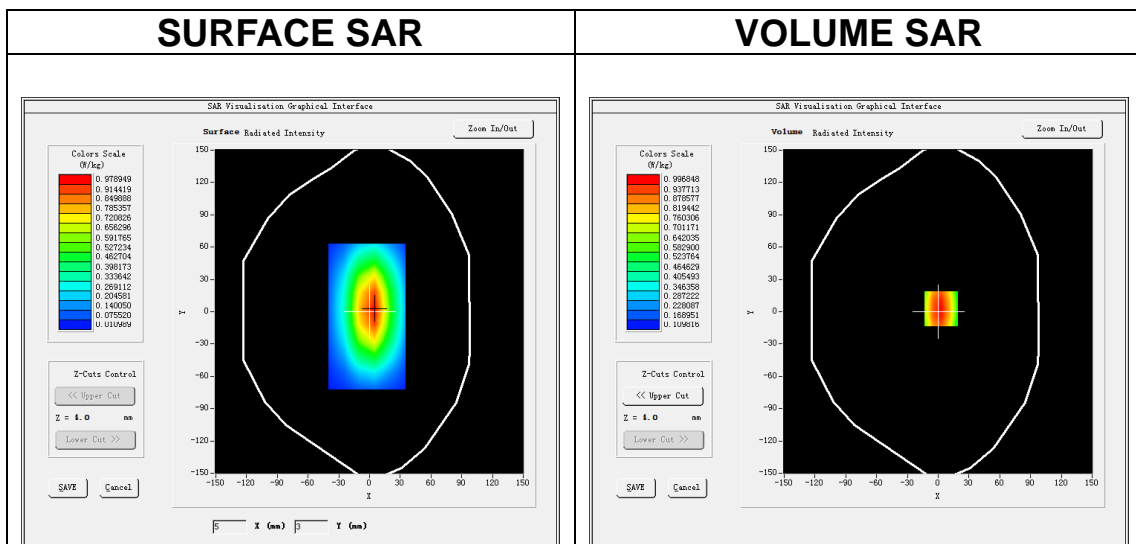

Maximum location: X=3.00, Y=3.00

SAR Peak: 1.34 W/kg

SAR 10g (W/Kg)	0.610925
SAR 1g (W/Kg)	0.971668

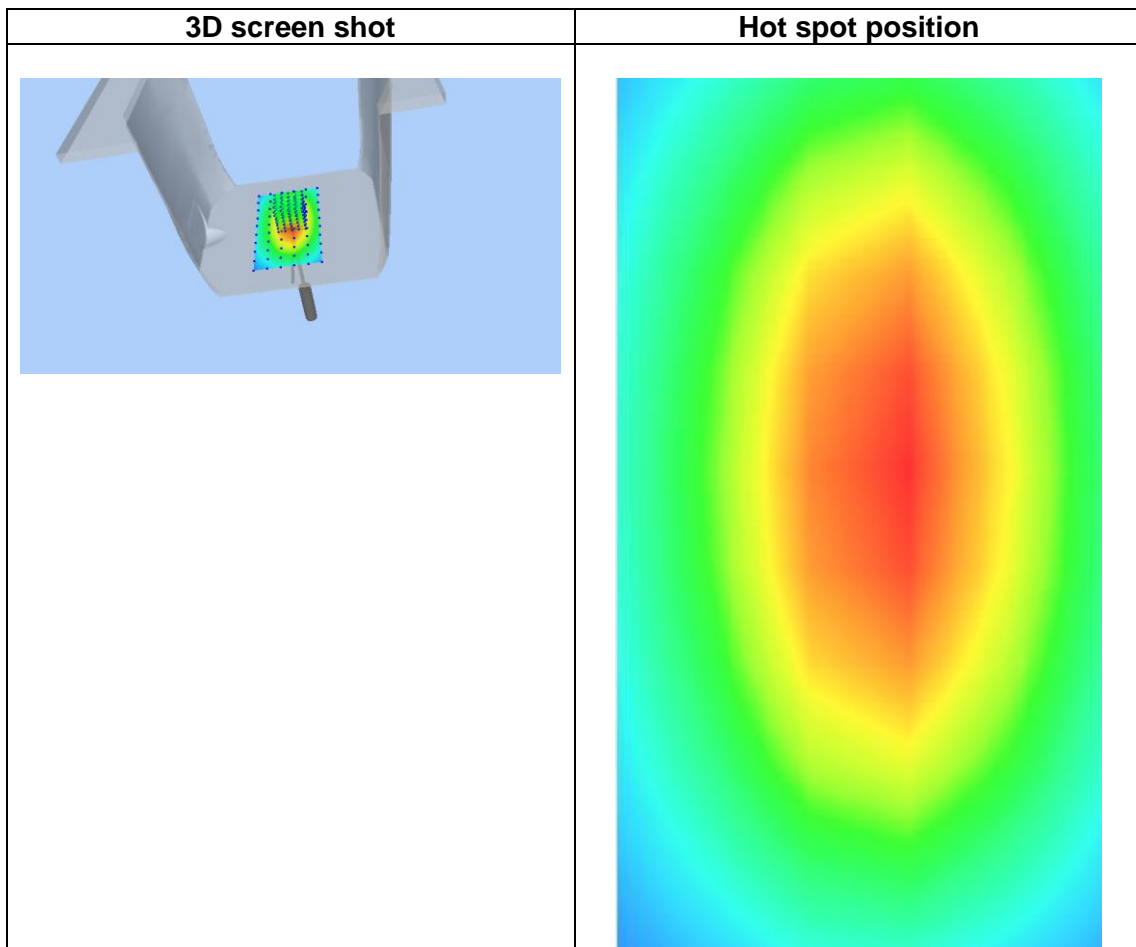
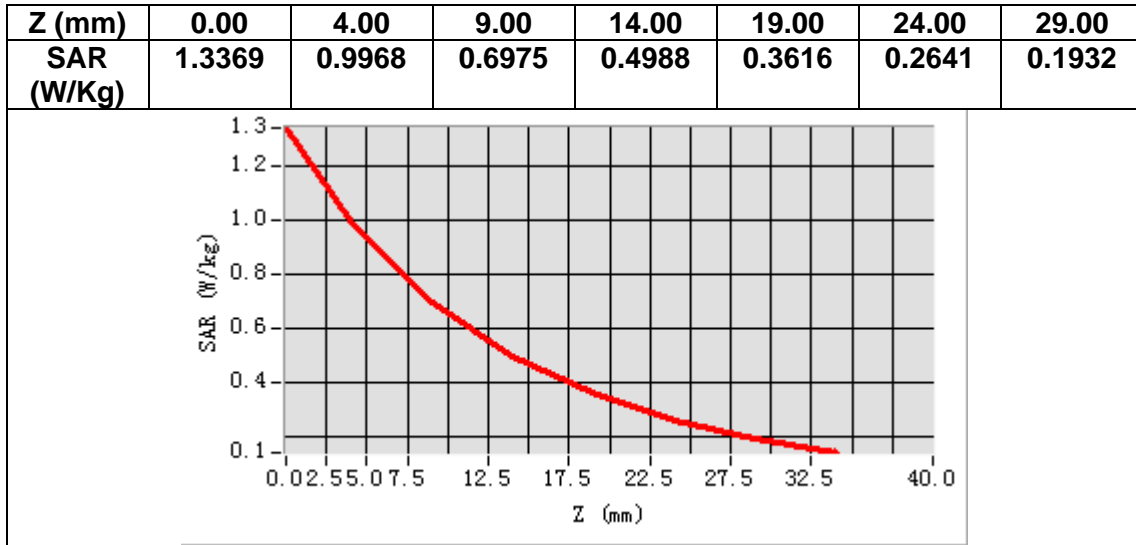

MEASUREMENT 2

A. Experimental conditions.

Area Scan	<u>dx=15mm dy=15mm, h= 5.00 mm</u>
ZoomScan	<u>5x5x7,dx=8mm dy=8mm dz=5mm</u>
Phantom	<u>Validation plane</u>
Device Position	<u>Dipole</u>
Band	<u>CW835</u>
Channels	<u>Middle</u>
Signal	<u>CW (Crest factor: 1.0)</u>

B. SAR Measurement Results

Frequency (MHz)	835.000000
Relative permittivity (real part)	54.820000
Relative permittivity (imaginary part)	21.580000
Conductivity (S/m)	1.000944
Variation (%)	0.080000

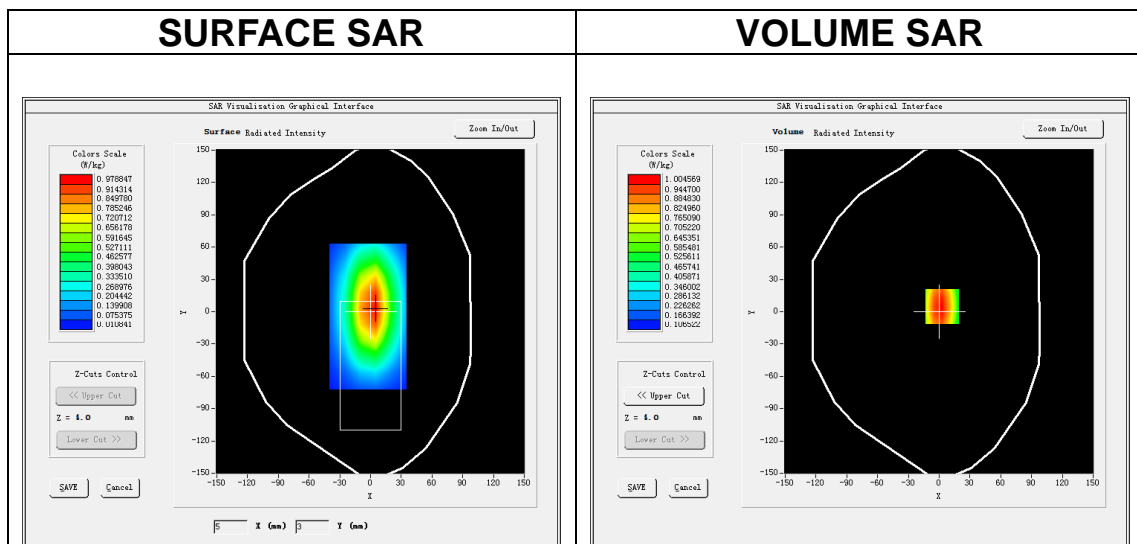

Maximum location: X=3.00, Y=5.00

SAR Peak: 1.36 W/kg

SAR 10g (W/Kg)	0.644534
SAR 1g (W/Kg)	0.970746

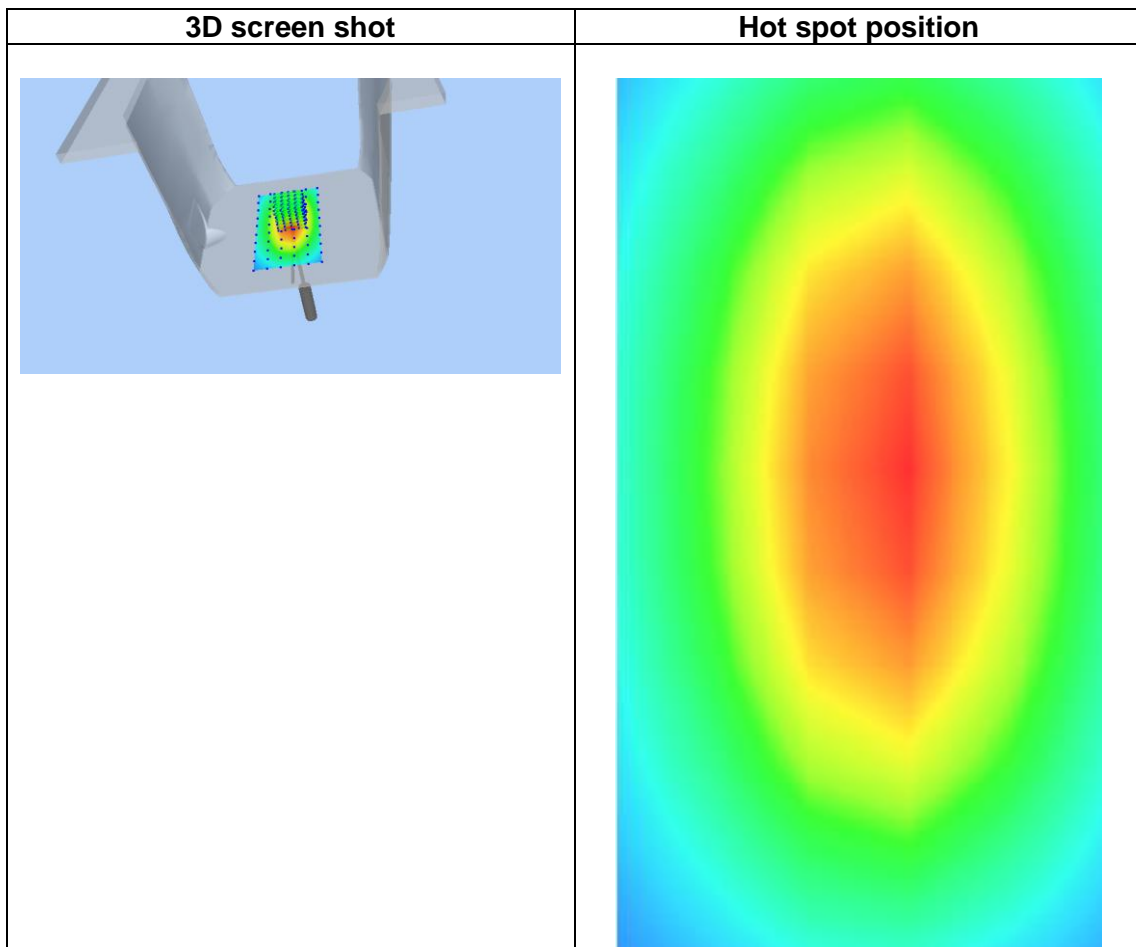
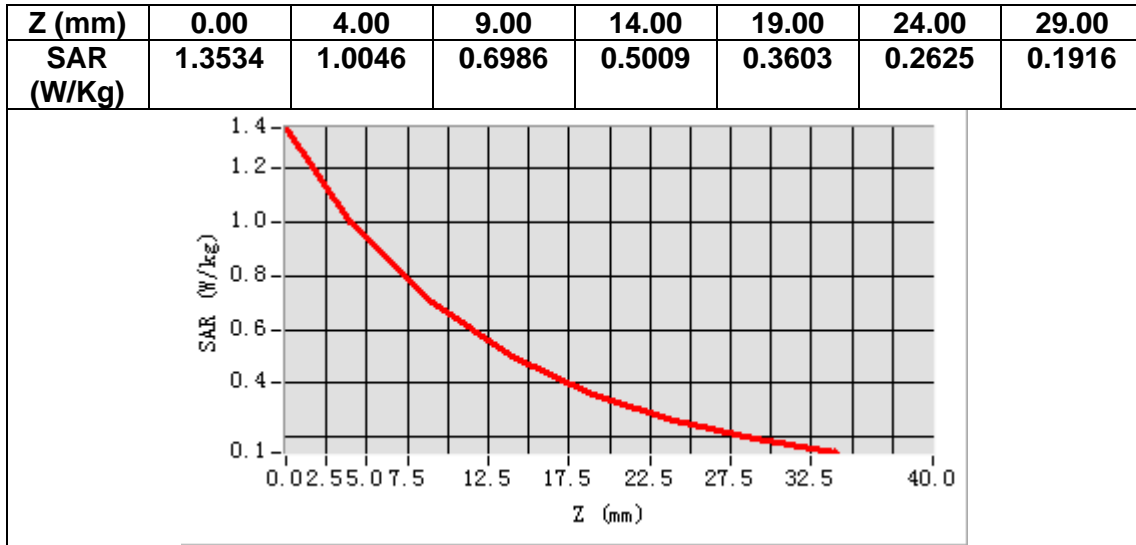

MEASUREMENT 3

A. Experimental conditions.

Area Scan	<u>dx=15mm dy=15mm, h= 5.00 mm</u>
ZoomScan	<u>5x5x7,dx=8mm dy=8mm dz=5mm</u>
Phantom	<u>Validation plane</u>
Device Position	<u>Dipole</u>
Band	<u>CW1800</u>
Channels	<u>Middle</u>
Signal	<u>CW (Crest factor: 1.0)</u>

B. SAR Measurement Results

Frequency (MHz)	1800.000000
Relative permittivity (real part)	39.522161
Relative permittivity (imaginary part)	14.003402
Conductivity (S/m)	1.400315
Variation (%)	-0.510000

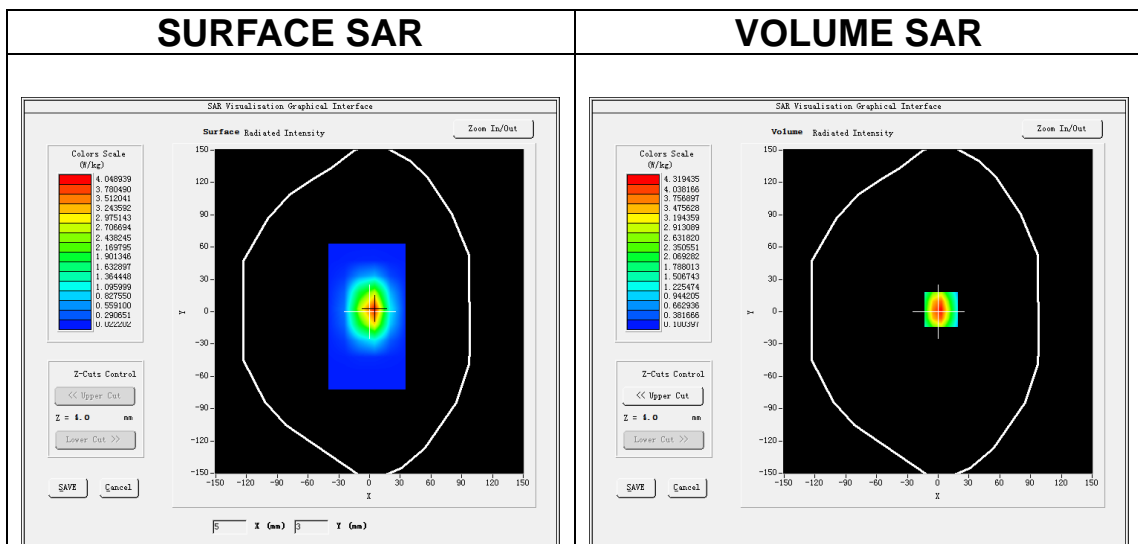

Maximum location: X=3.00, Y=2.00

SAR Peak: 6.82 W/kg

SAR 10g (W/Kg)	2.072403
SAR 1g (W/Kg)	3.910112

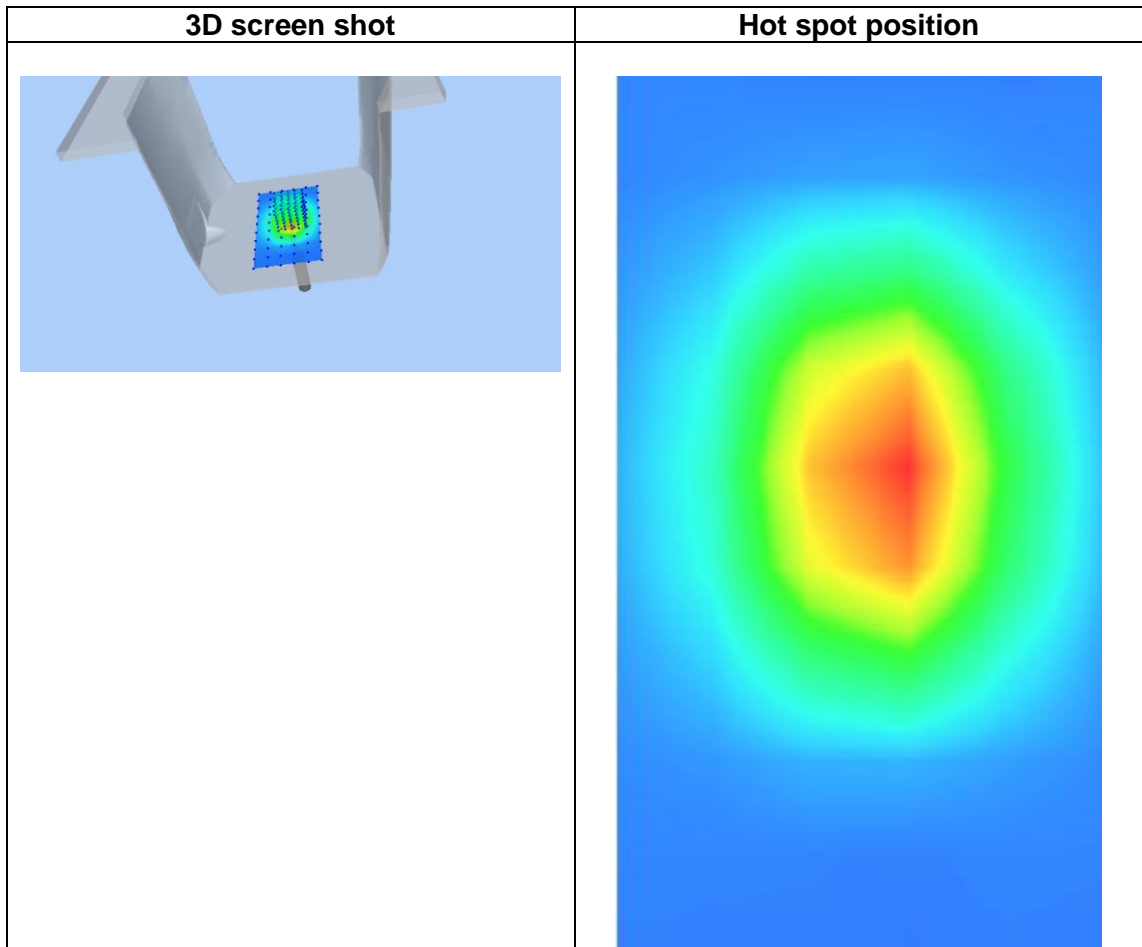
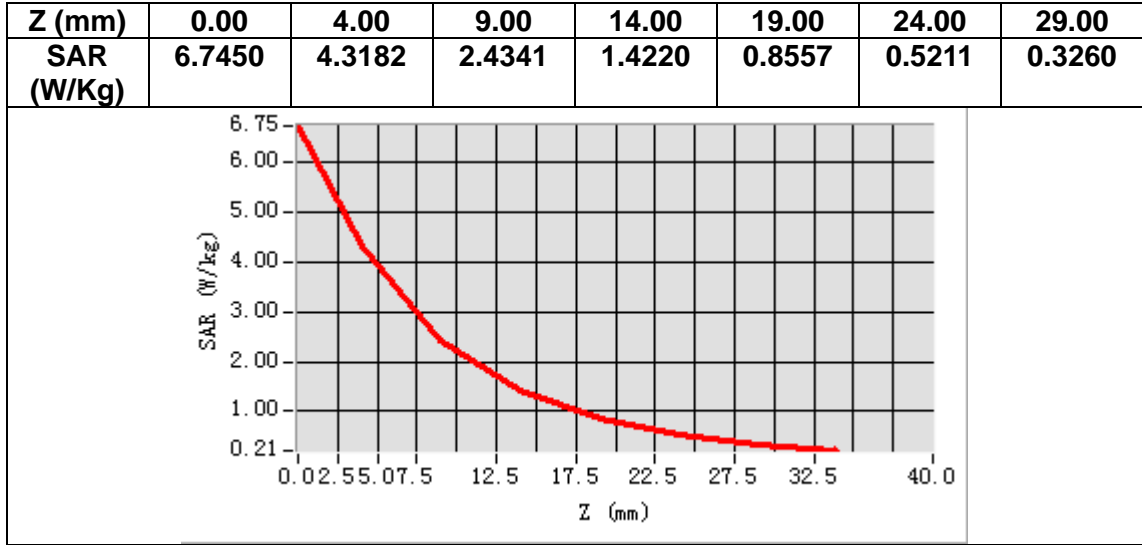

MEASUREMENT 4

A. Experimental conditions.

Area Scan	<u>dx=15mm dy=15mm, h= 5.00 mm</u>
ZoomScan	<u>5x5x7,dx=8mm dy=8mm dz=5mm</u>
Phantom	<u>Validation plane</u>
Device Position	<u>Dipole</u>
Band	<u>CW1800</u>
Channels	<u>Middle</u>
Signal	<u>CW (Crest factor: 1.0)</u>

B. SAR Measurement Results

Frequency (MHz)	1800.000000
Relative permittivity (real part)	53.721254
Relative permittivity (imaginary part)	15.352900
Conductivity (S/m)	1.530214
Variation (%)	-0.170000

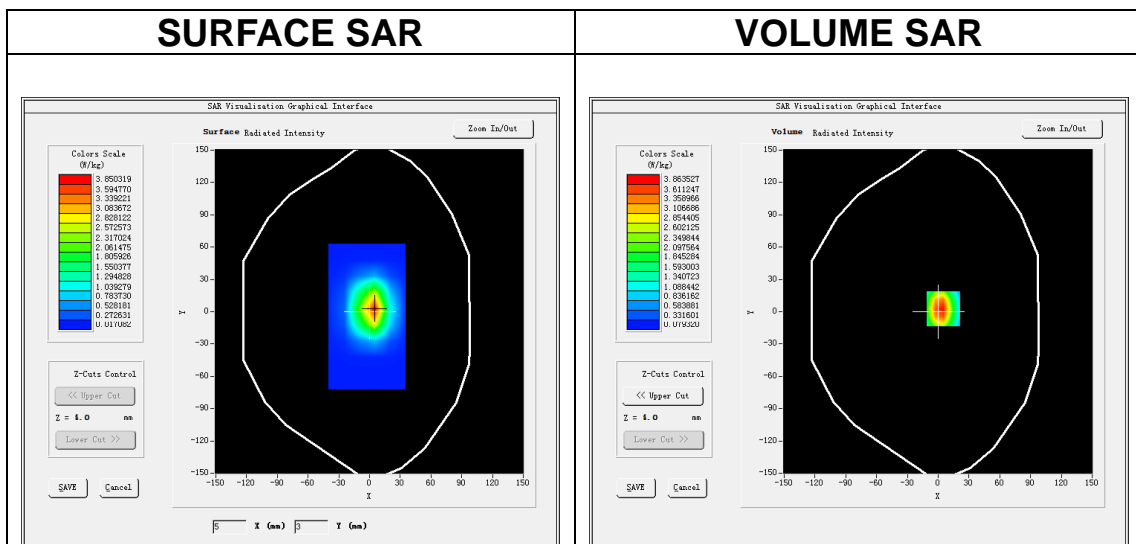

Maximum location: X=5.00, Y=3.00

SAR Peak: 6.21 W/kg

SAR 10g (W/Kg)	1.922830
SAR 1g (W/Kg)	3.679015

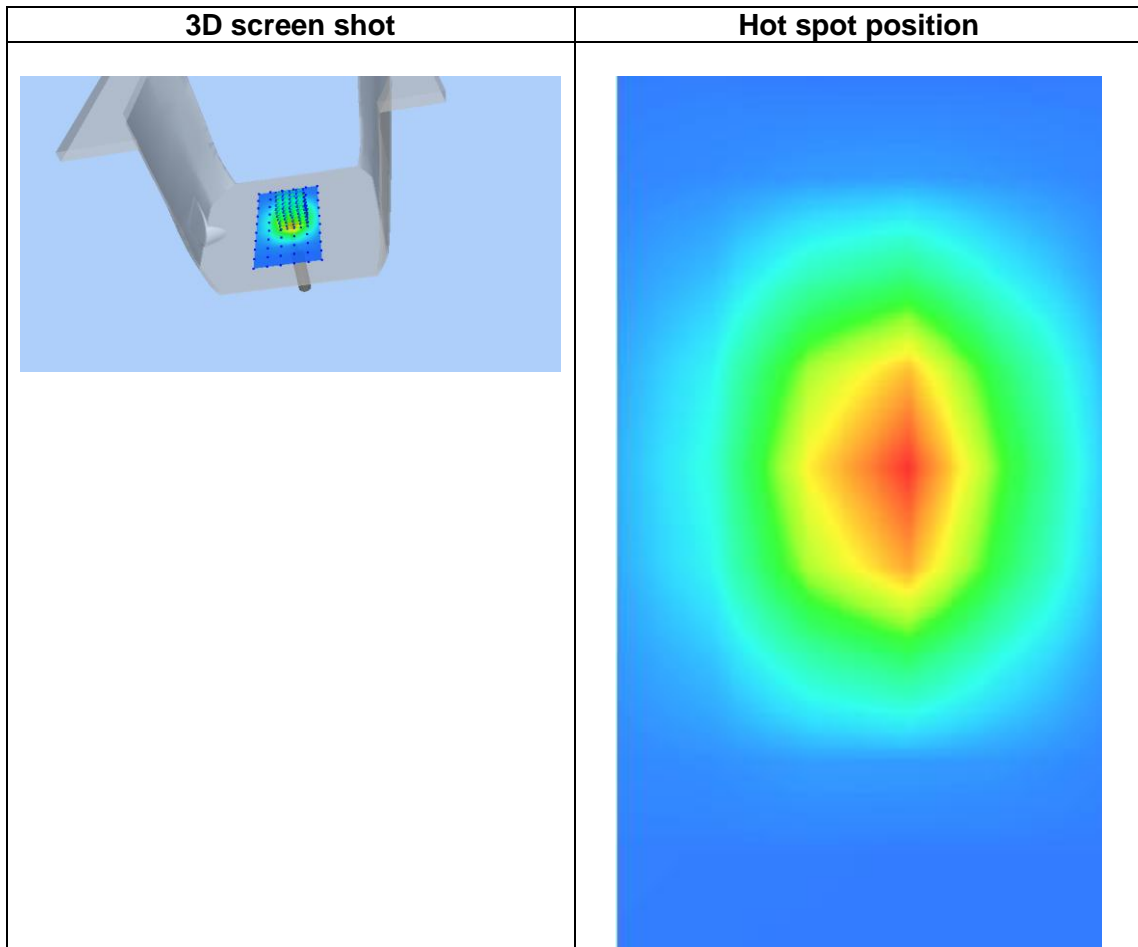
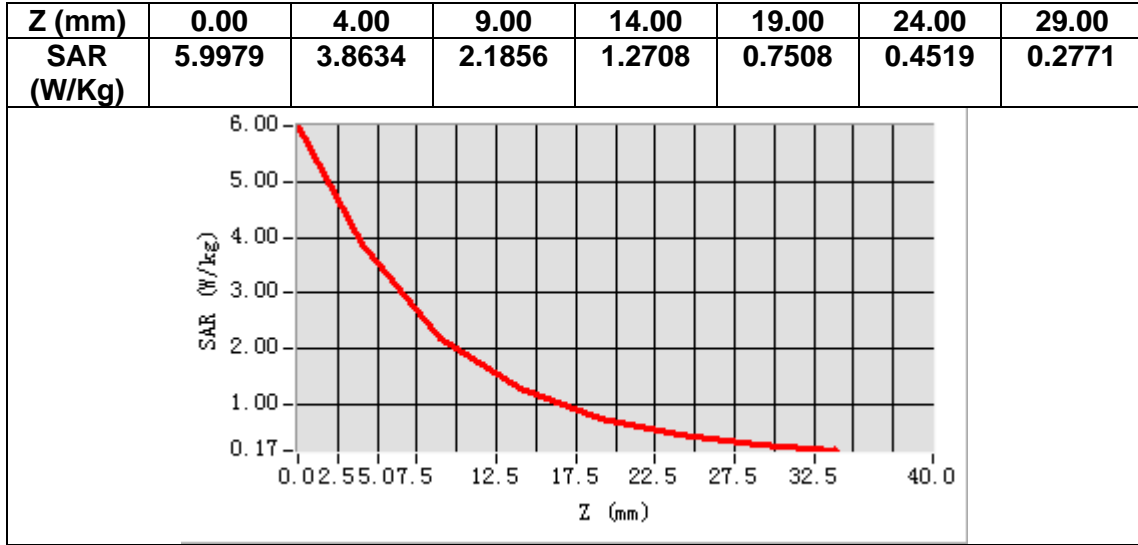

MEASUREMENT 5

A. Experimental conditions.

Area Scan	<u>dx=15mm dy=15mm, h= 5.00 mm</u>
ZoomScan	<u>5x5x7,dx=8mm dy=8mm dz=5mm</u>
Phantom	<u>Validation plane</u>
Device Position	<u>Dipole</u>
Band	<u>CW1900</u>
Channels	<u>Middle</u>
Signal	<u>CW (Crest factor: 1.0)</u>

B. SAR Measurement Results

Frequency (MHz)	1900.000000
Relative permittivity (real part)	41.412098
Relative permittivity (imaginary part)	13.661900
Conductivity (S/m)	1.440656
Variation (%)	-0.310000

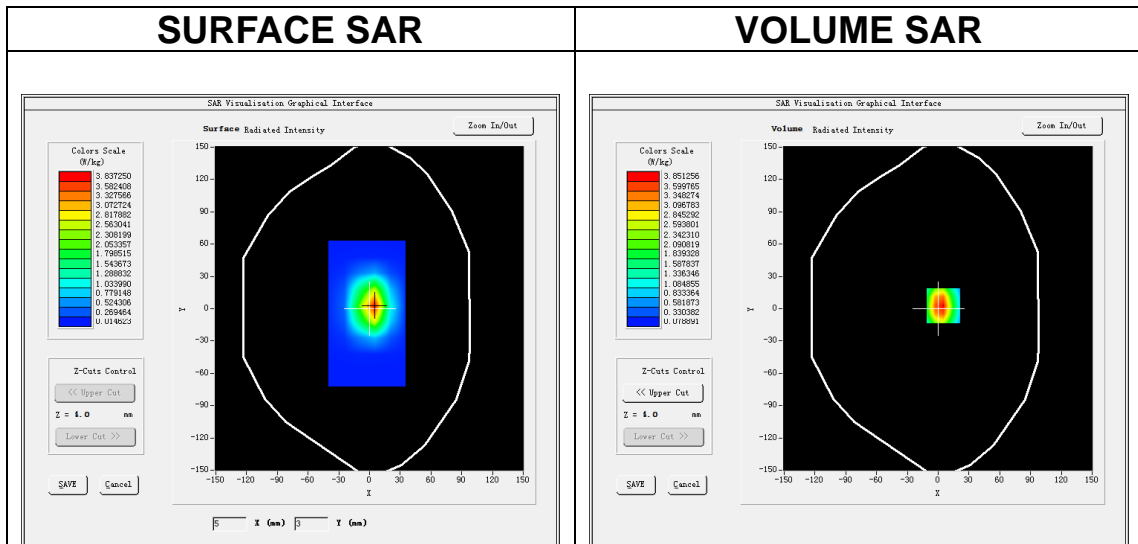

Maximum location: X=5.00, Y=3.00

SAR Peak: 6.19 W/kg

SAR 10g (W/Kg)	1.947324
SAR 1g (W/Kg)	3.768405

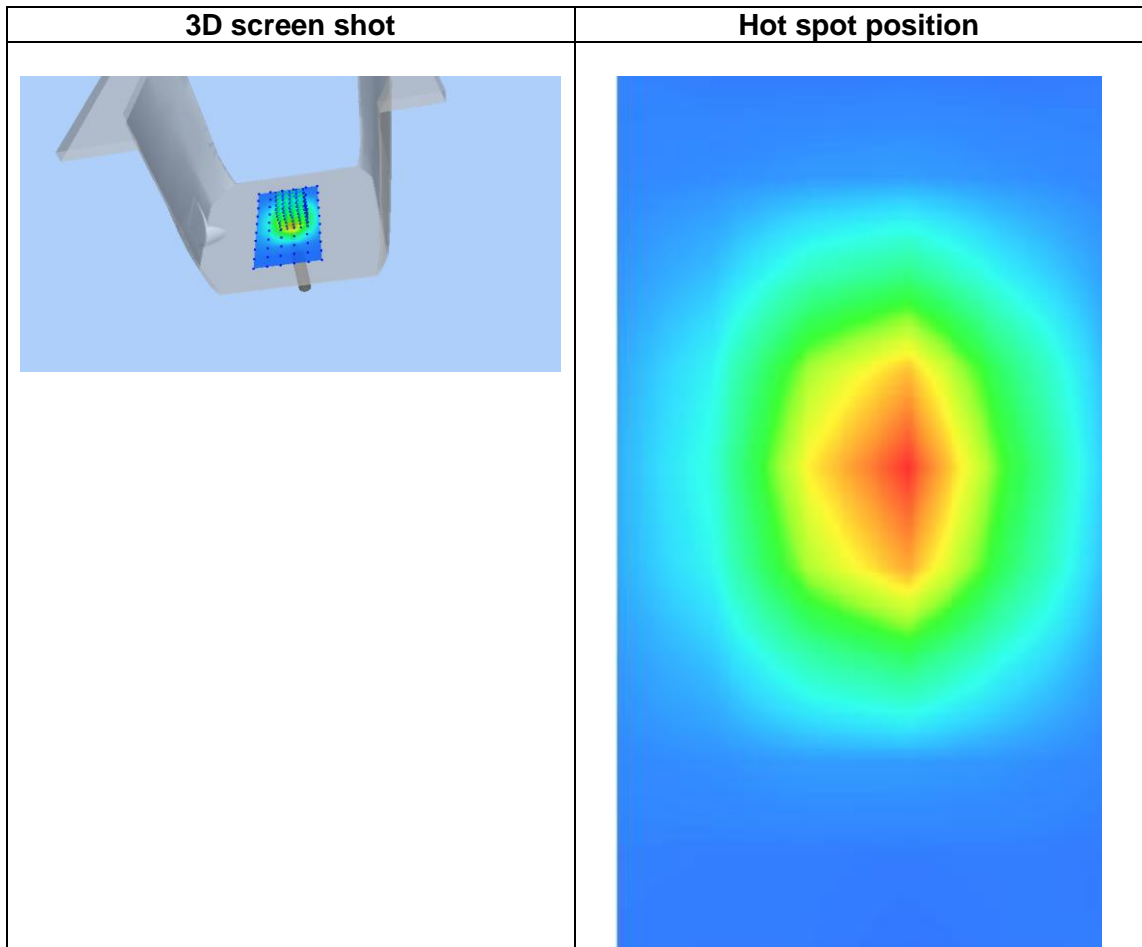
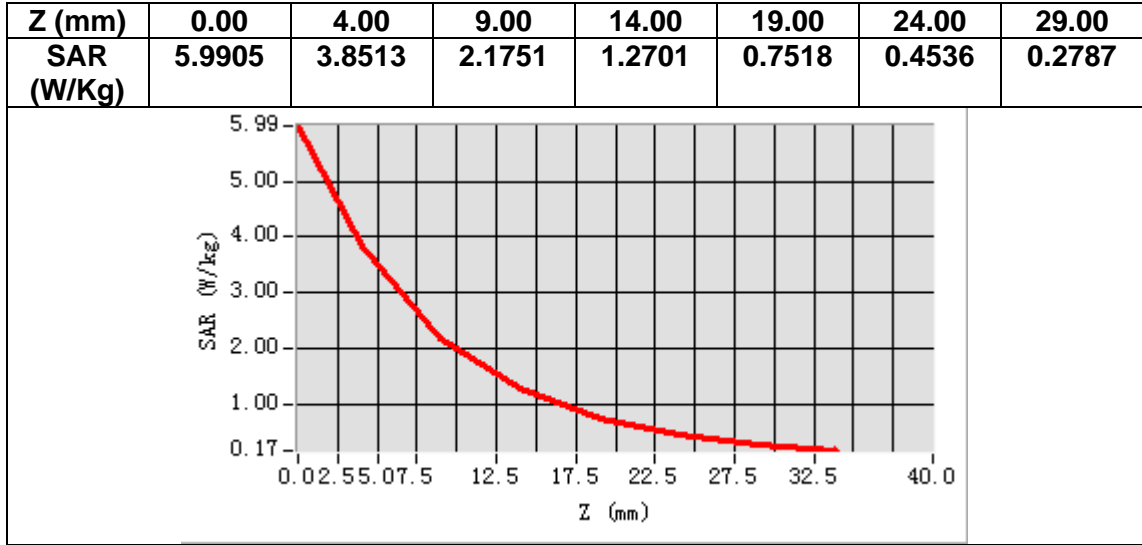

MEASUREMENT 6

A. Experimental conditions.

Area Scan	<u>dx=15mm dy=15mm, h= 5.00 mm</u>
ZoomScan	<u>5x5x7, dx=8mm dy=8mm dz=5mm</u>
Phantom	<u>Validation plane</u>
Device Position	<u>Dipole</u>
Band	<u>CW1900</u>
Channels	<u>Middle</u>
Signal	<u>CW (Crest factor: 1.0)</u>

B. SAR Measurement Results

Frequency (MHz)	1900.000000
Relative permittivity (real part)	53.063782
Relative permittivity (imaginary part)	14.720210
Conductivity (S/m)	1.550217
Variation (%)	-0.100000

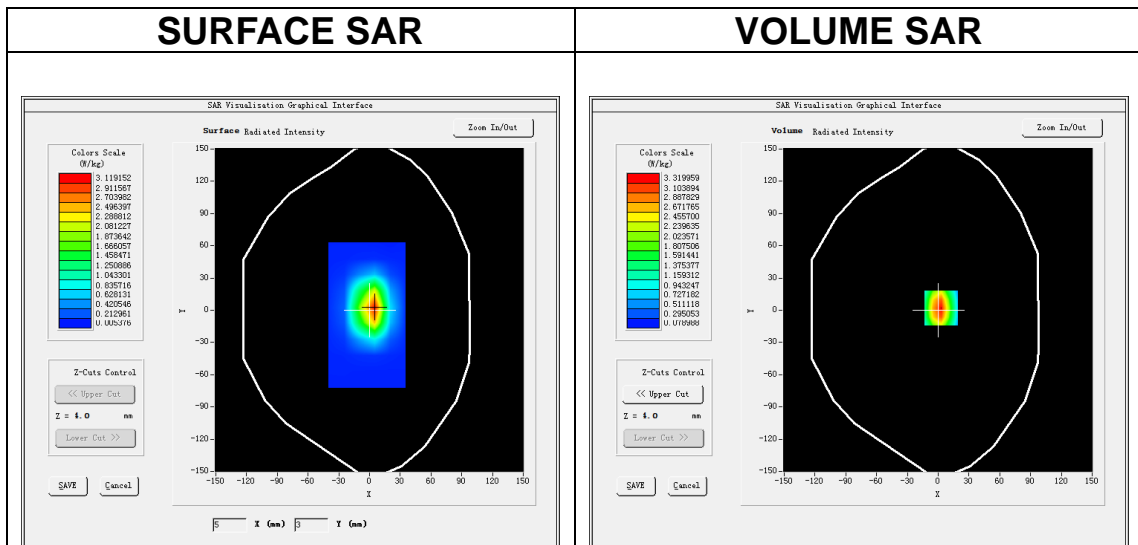

Maximum location: X=3.00, Y=2.00

SAR Peak: 5.24 W/kg

SAR 10g (W/Kg)	2.043256
SAR 1g (W/Kg)	3.886145

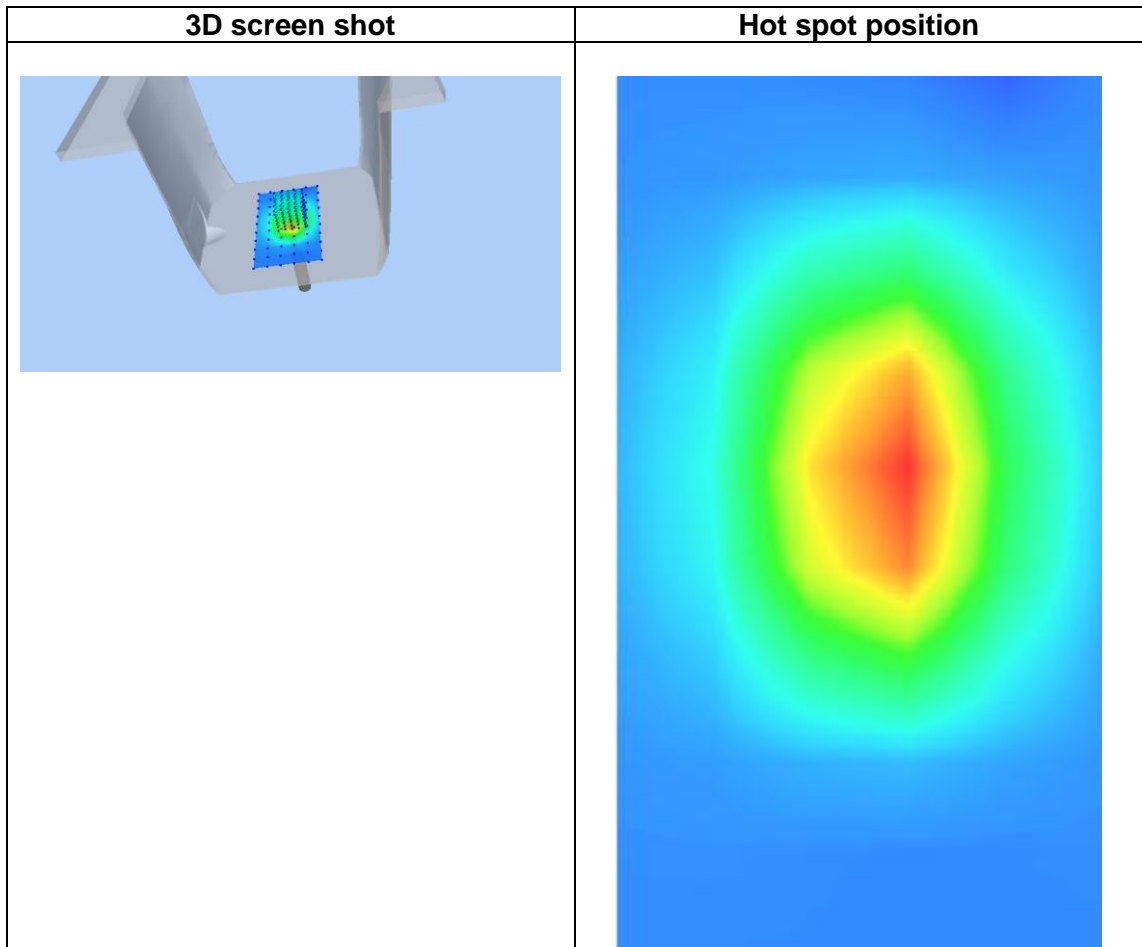
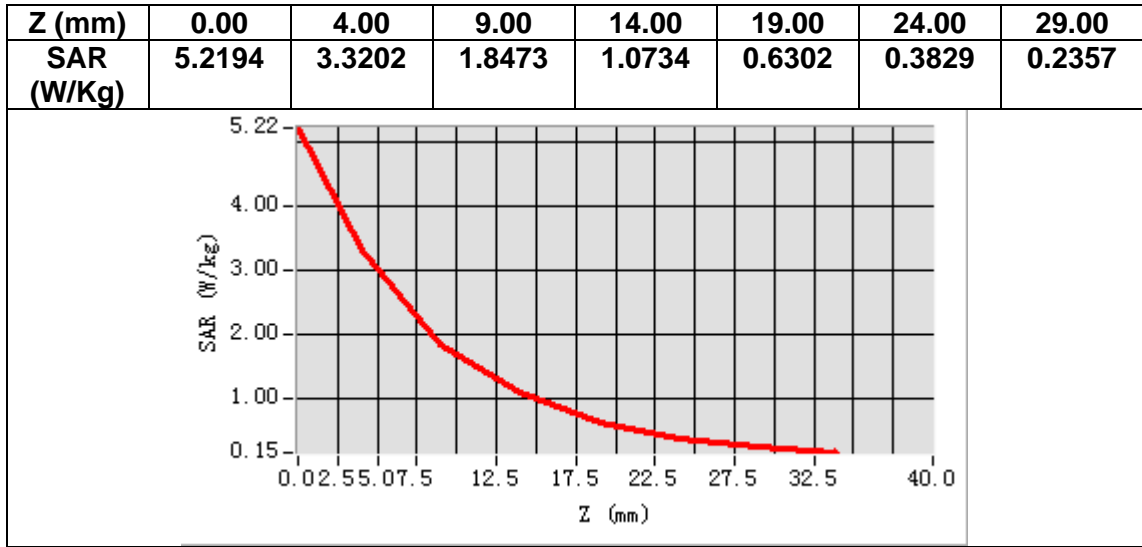

MEASUREMENT 7

A. Experimental conditions.

Area Scan	<u>dx=12mm dy=12mm, h= 5.00 mm</u>
ZoomScan	<u>7x7x7,dx=5mm dy=5mm dz=5mm</u>
Phantom	<u>Validation plane</u>
Device Position	<u>Dipole</u>
Band	<u>CW2450</u>
Channels	<u>Middle</u>
Signal	<u>CW (Crest factor: 1.0)</u>

B. SAR Measurement Results

Frequency (MHz)	2450.000000
Relative permittivity (real part)	39.712801
Relative permittivity (imaginary part)	13.430800
Conductivity (S/m)	1.831834
Variation (%)	0.140000

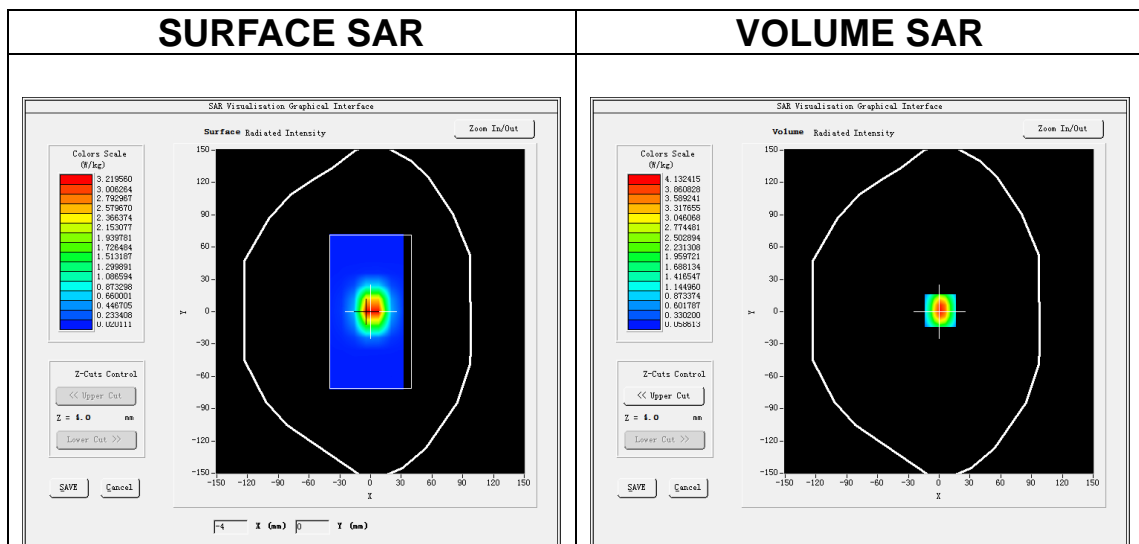

Maximum location: X=1.00, Y=1.00

SAR Peak: 6.60 W/kg

SAR 10g (W/Kg)	2.410733
SAR 1g (W/Kg)	4.957086

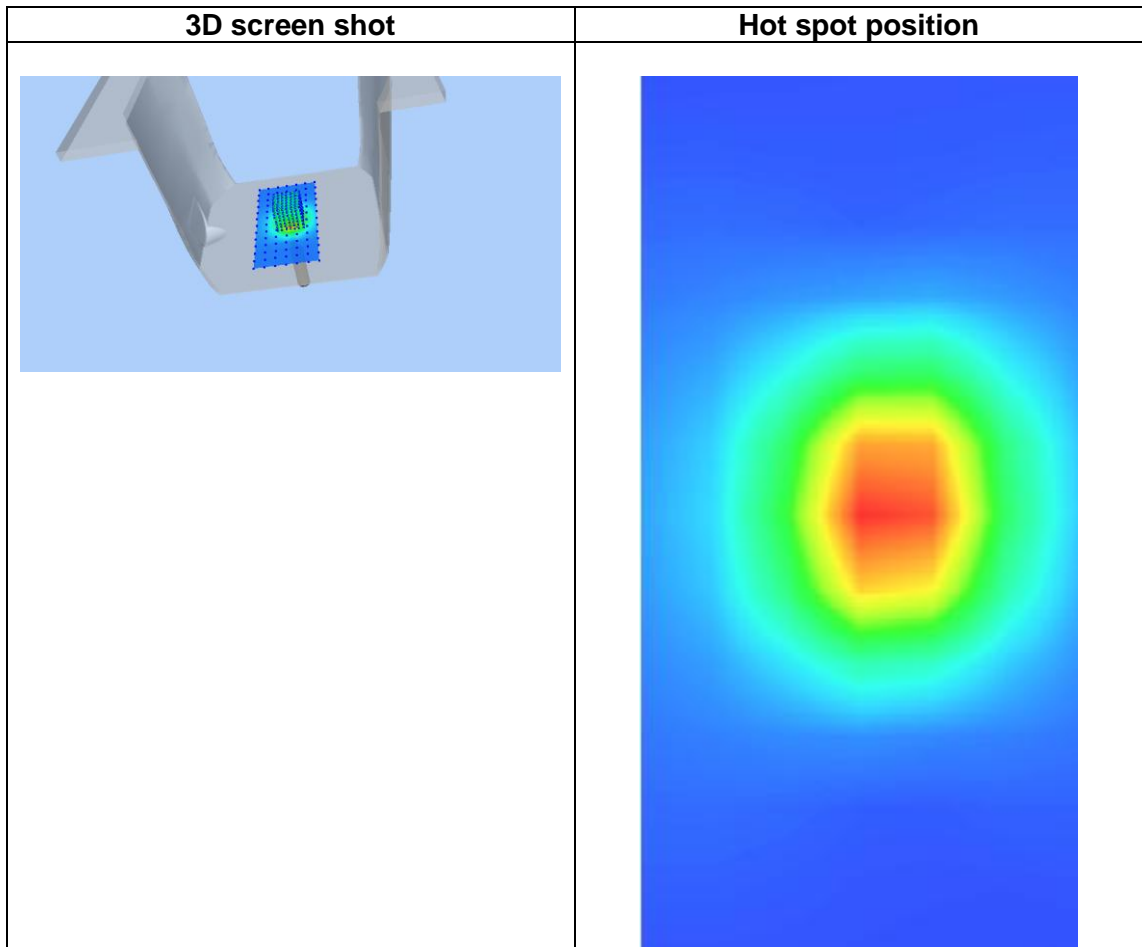
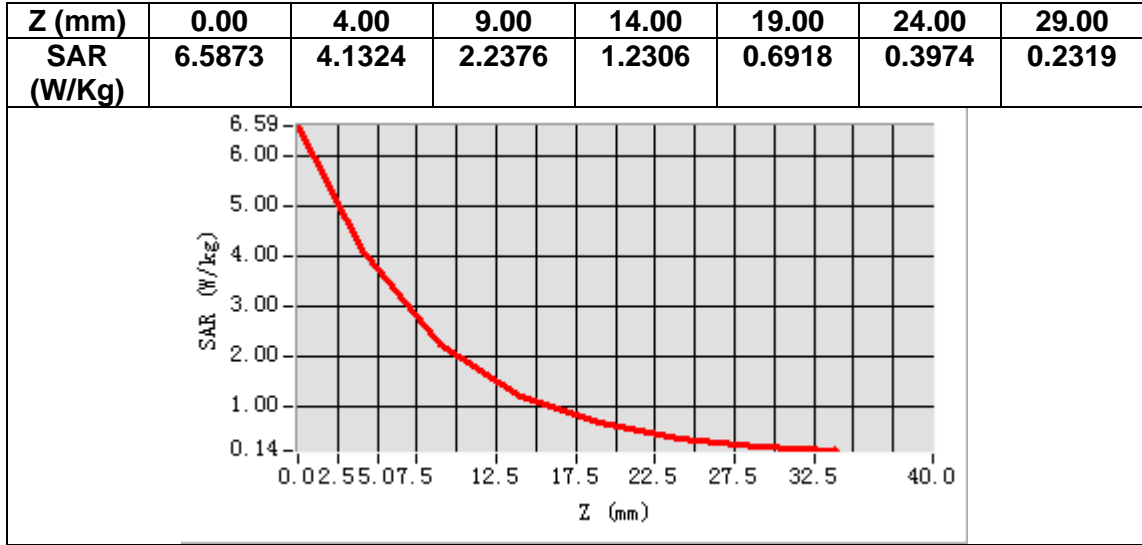

MEASUREMENT 8

A. Experimental conditions.

Area Scan	<u>dx=12mm dy=12mm, h= 5.00 mm</u>
ZoomScan	<u>7x7x7,dx=5mm dy=5mm dz=5mm</u>
Phantom	<u>Validation plane</u>
Device Position	<u>Dipole</u>
Band	<u>CW2450</u>
Channels	<u>Middle</u>
Signal	<u>CW (Crest factor: 1.0)</u>

B. SAR Measurement Results

Frequency (MHz)	2450.000000
Relative permittivity (real part)	52.562801
Relative permittivity (imaginary part)	14.640800
Conductivity (S/m)	1.991834
Variation (%)	-0.080000

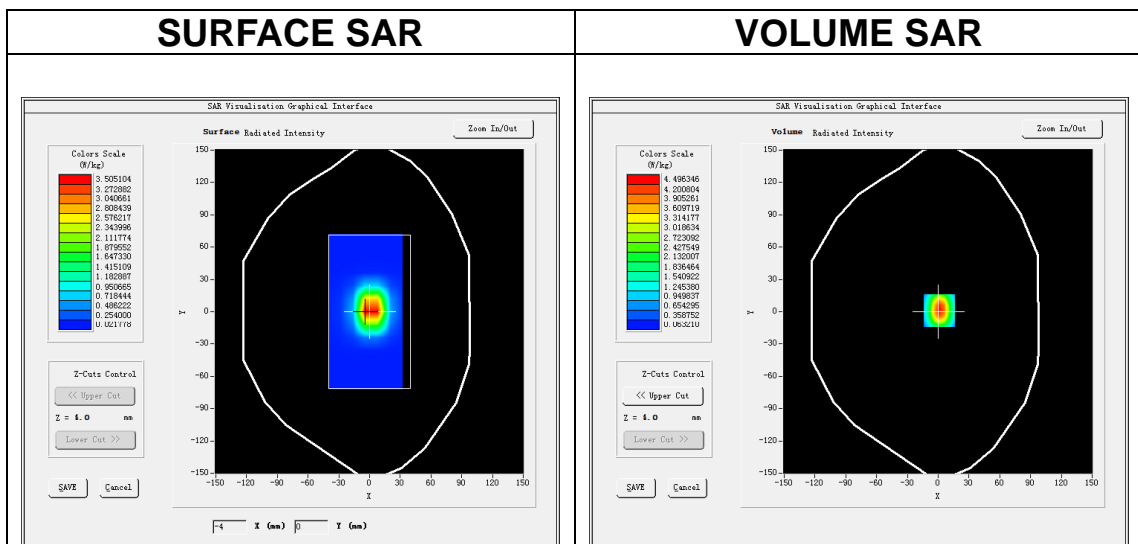

Maximum location: X=1.00, Y=1.00

SAR Peak: 7.17 W/kg

SAR 10g (W/Kg)	2.269865
SAR 1g (W/Kg)	4.685776

Z (mm)	0.00	4.00	9.00	14.00	19.00	24.00	29.00
SAR (W/Kg)	7.1697	4.4963	2.4366	1.3381	0.7556	0.4323	0.2502

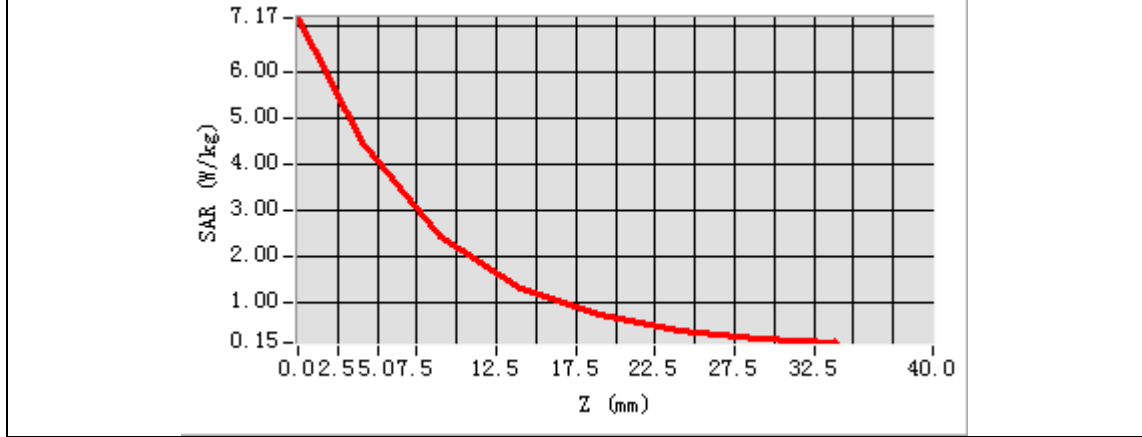

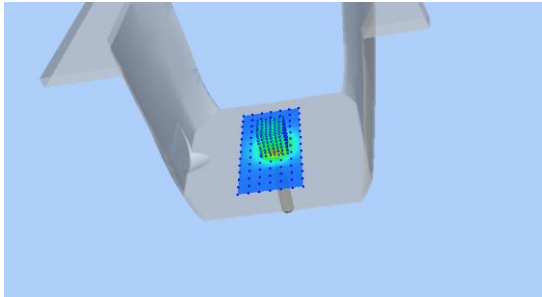
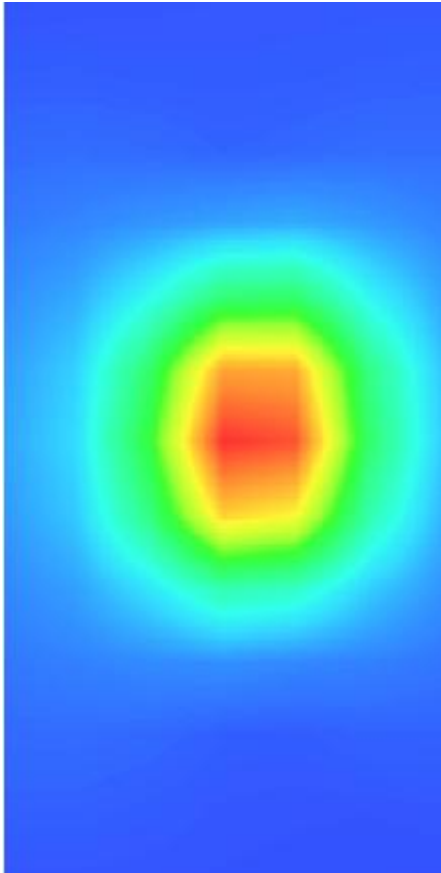
3D screen shot	Hot spot position
	

MEASUREMENT 9

A. Experimental conditions.

Area Scan	<u>dx=12mm dy=12mm, h= 5.00 mm</u>
ZoomScan	<u>7x7x7,dx=5mm dy=5mm dz=5mm</u>
Phantom	<u>Validation plane</u>
Device Position	<u>Dipole</u>
Band	<u>CW2600</u>
Channels	<u>Middle</u>
Signal	<u>CW (Crest factor: 1.0)</u>

B. SAR Measurement Results

Frequency (MHz)	2600.000000
Relative permittivity (real part)	38.821646
Relative permittivity (imaginary part)	13.771940
Conductivity (S/m)	1.992325
Variation (%)	-0.080000

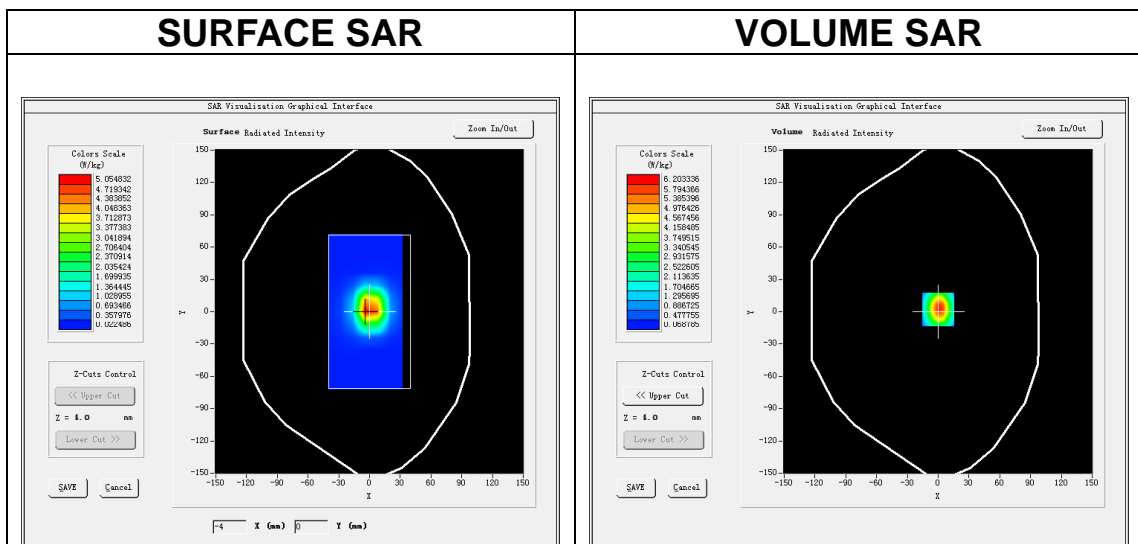

Maximum location: X=0.00, Y=2.00

SAR Peak: 10.01 W/kg

SAR 10g (W/Kg)	2.579285
SAR 1g (W/Kg)	5.661299

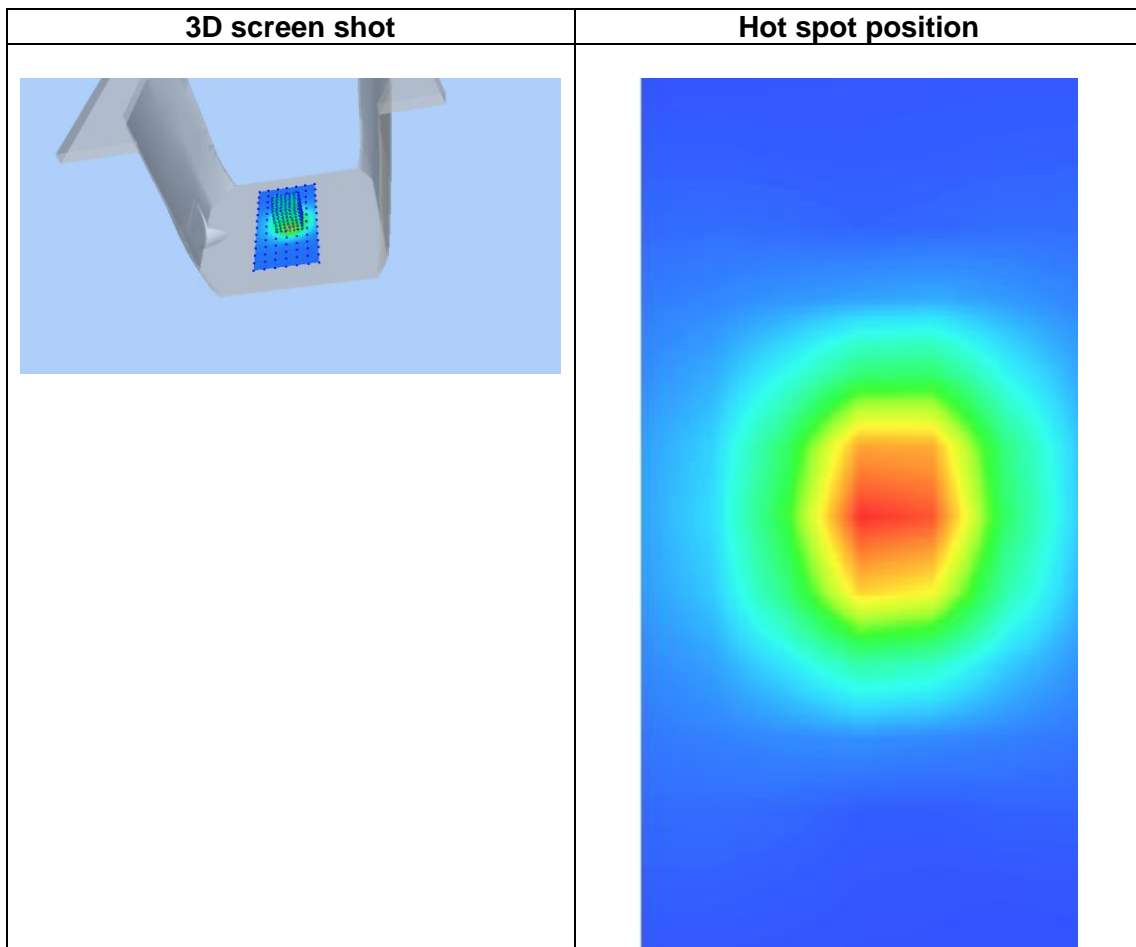
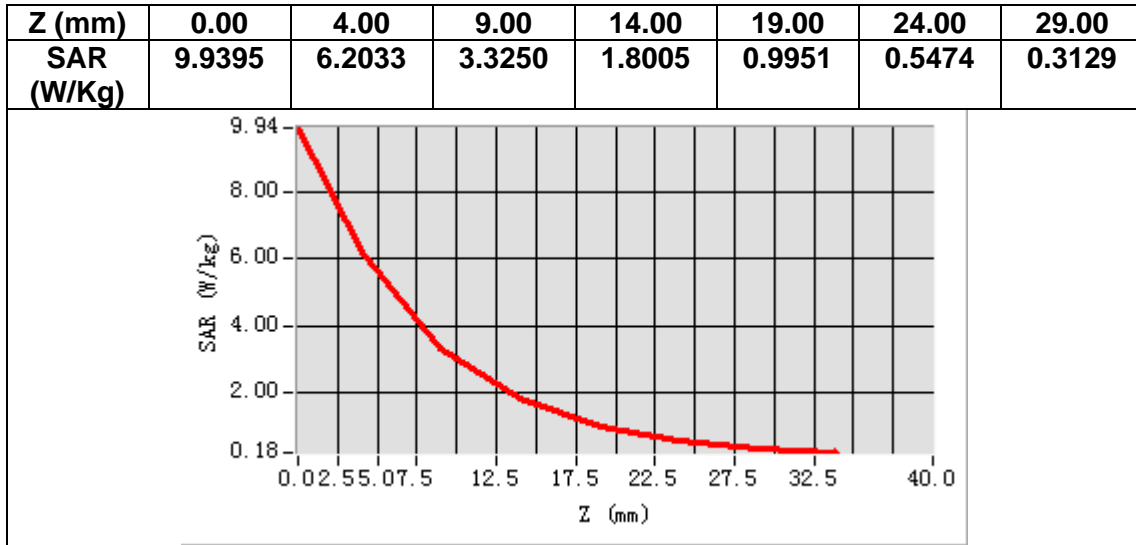

MEASUREMENT 10

A. Experimental conditions.

Area Scan	<u>dx=12mm dy=12mm, h= 5.00 mm</u>
ZoomScan	<u>7x7x7,dx=5mm dy=5mm dz=5mm</u>
Phantom	<u>Validation plane</u>
Device Position	<u>Dipole</u>
Band	<u>CW2600</u>
Channels	<u>Middle</u>
Signal	<u>CW (Crest factor: 1.0)</u>

B. SAR Measurement Results

Frequency (MHz)	2600.000000
Relative permittivity (real part)	52.971646
Relative permittivity (imaginary part)	15.110940
Conductivity (S/m)	2.182325
Variation (%)	0.010000

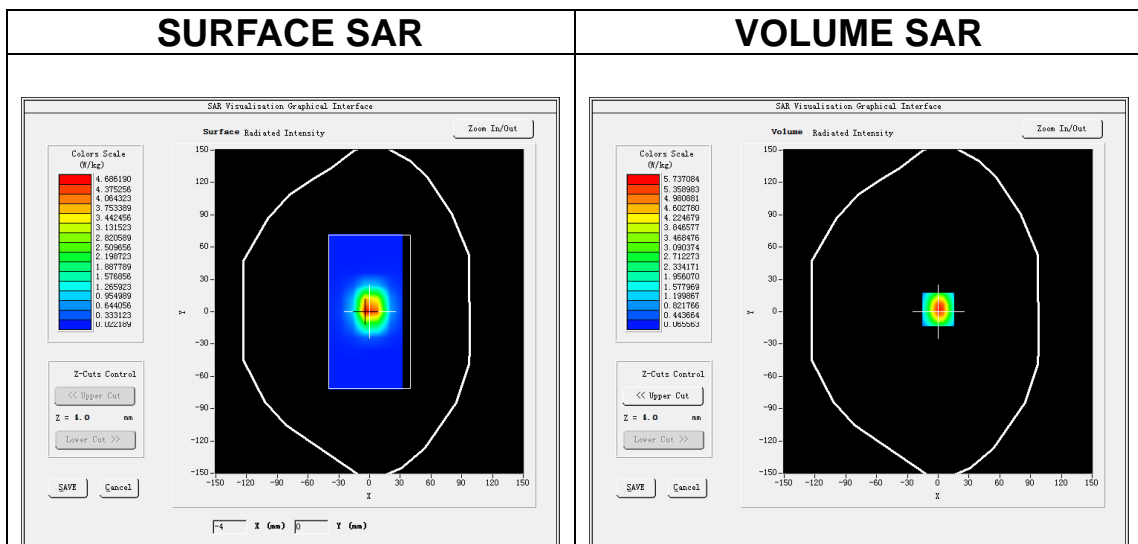

Maximum location: X=0.00, Y=2.00

SAR Peak: 9.25 W/kg

SAR 10g (W/Kg)	2.481944
SAR 1g (W/Kg)	5.240684

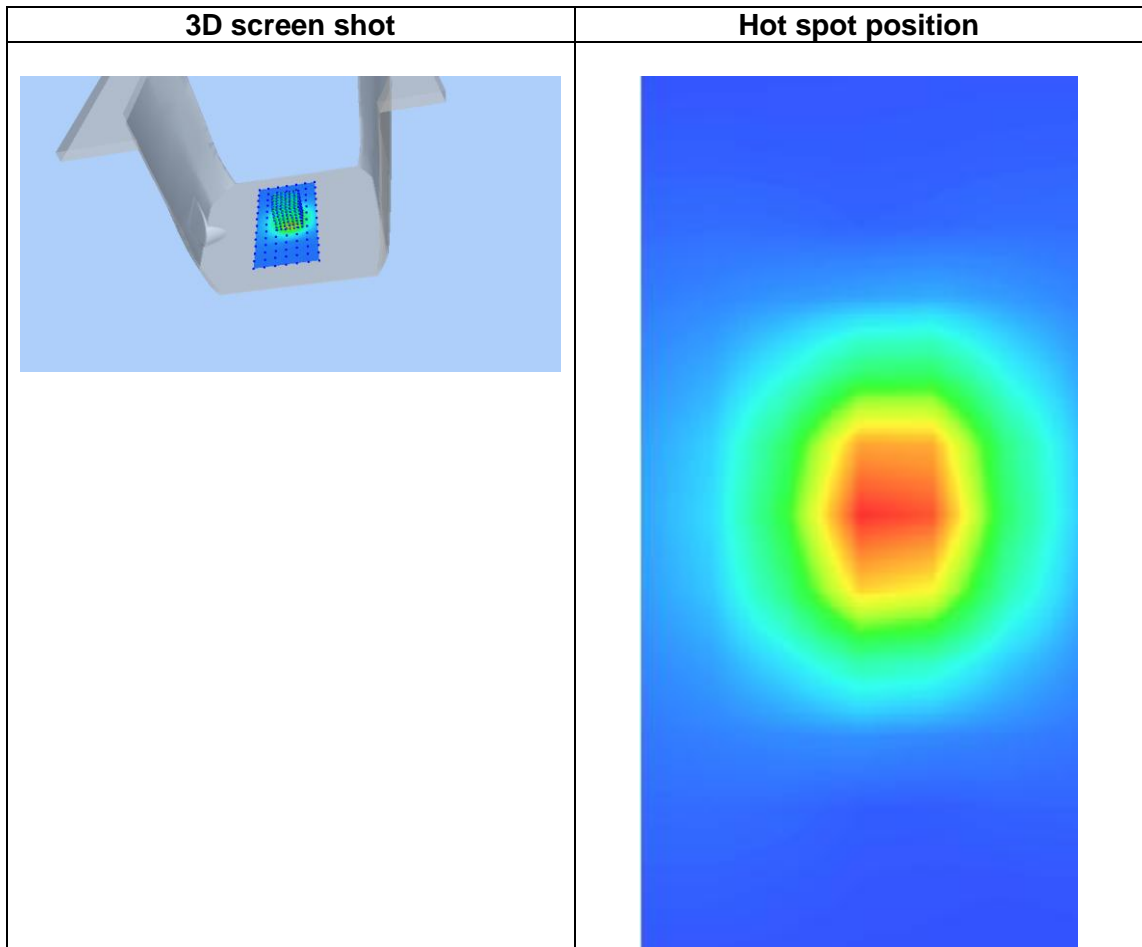
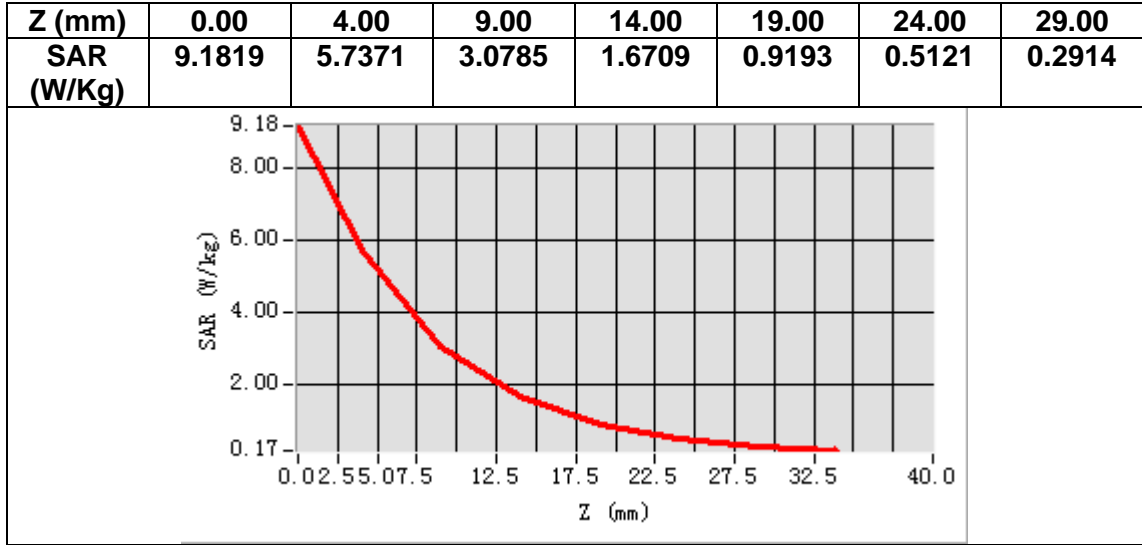

13. Appendix C. Plots of High SAR Measurement

Table of contents
MEASUREMENT 1 GSM 850 Head
MEASUREMENT 2 GSM 850 Body
MEASUREMENT 3 GSM 1900 Head
MEASUREMENT 4 GSM 1900 Body
MEASUREMENT 5 WCDMA Band II Head
MEASUREMENT 6 WCDMA Band II Body
MEASUREMENT 7 WCDMA Band V Head
MEASUREMENT 8 WCDMA Band V Body
MEASUREMENT 9 WLAN 2.4G Head
MEASUREMENT 10 WLAN 2.4G Body
MEASUREMENT 11 LTE Band II Head
MEASUREMENT 12 LTE Band II Body
MEASUREMENT 13 LTE Band IV Head
MEASUREMENT 14 LTE Band IV Body
MEASUREMENT 15 LTE Band V Head
MEASUREMENT 16 LTE Band V Body
MEASUREMENT 17 LTE Band VII Head
MEASUREMENT 18 LTE Band VII Body

MEASUREMENT 1

A. Experimental conditions.

Area Scan	<u>dx=15mm dy=15mm, h= 5.00 mm</u>
ZoomScan	<u>5x5x7,dx=8mm dy=8mm dz=5mm</u>
Phantom	<u>Left head</u>
Device Position	<u>Cheek</u>
Band	<u>GSM850</u>
Channels	<u>Middle</u>
Signal	<u>TDMA (Crest factor: 2.0)</u>

B. SAR Measurement Results

Frequency (MHz)	836.400000
Relative permittivity (real part)	41.260960
Relative permittivity (imaginary part)	19.761539
Conductivity (S/m)	0.918253
Variation (%)	-1.120000

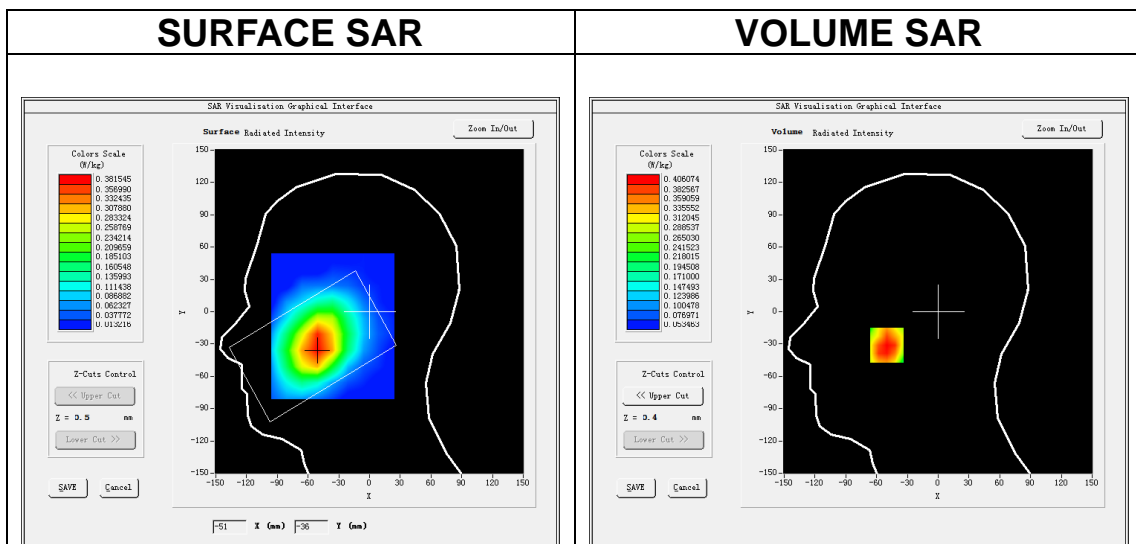

Maximum location: X=-50.00, Y=-31.00

SAR Peak: 0.47 W/kg

SAR 10g (W/Kg)	0.308424
SAR 1g (W/Kg)	0.400319

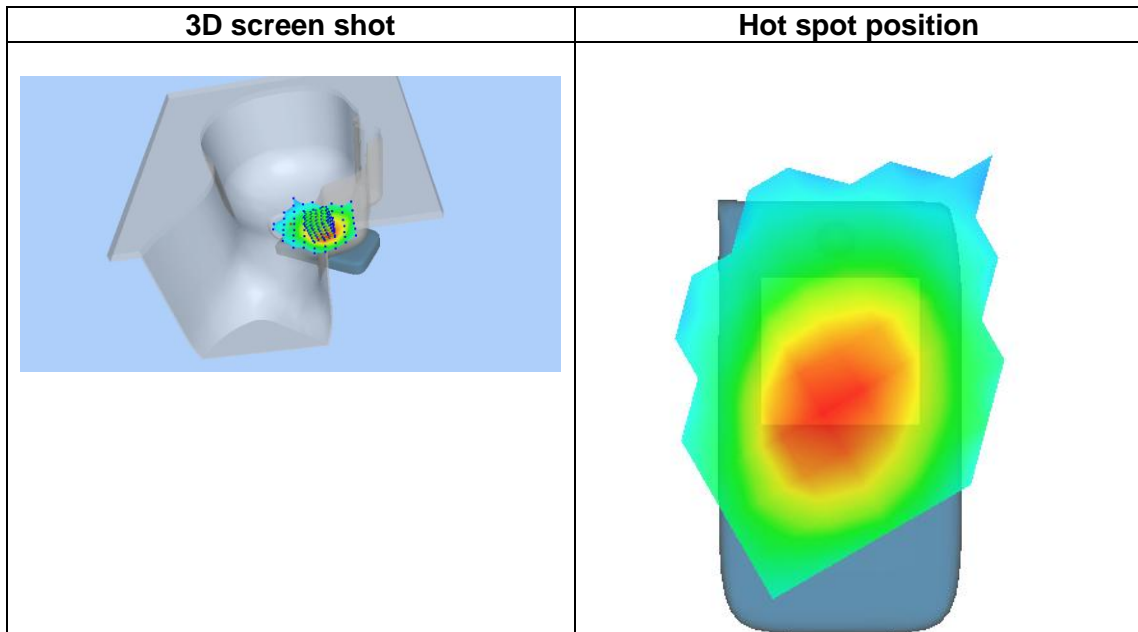
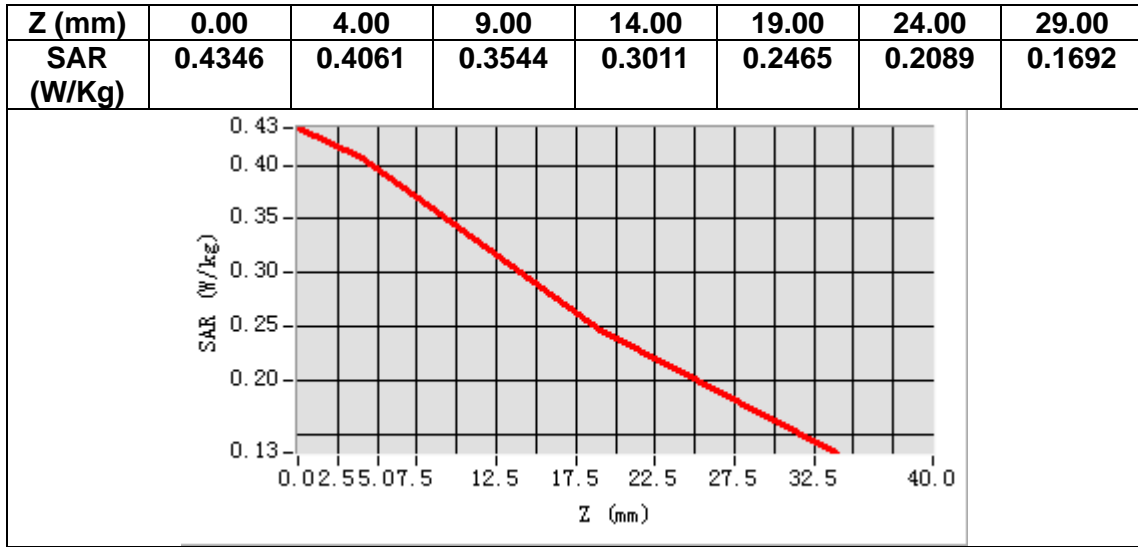

MEASUREMENT 2

A. Experimental conditions.

Area Scan	<u>dx=15mm dy=15mm, h= 5.00 mm</u>
ZoomScan	<u>5x5x7,dx=8mm dy=8mm dz=5mm</u>
Phantom	<u>Validation plane</u>
Device Position	<u>Body</u>
Band	<u>GSM850</u>
Channels	<u>Middle</u>
Signal	<u>TDMA (Crest factor: 2.0)</u>

B. SAR Measurement Results

Frequency (MHz)	836.400000
Relative permittivity (real part)	54.829578
Relative permittivity (imaginary part)	21.562740
Conductivity (S/m)	1.001949
Variation (%)	2.400000

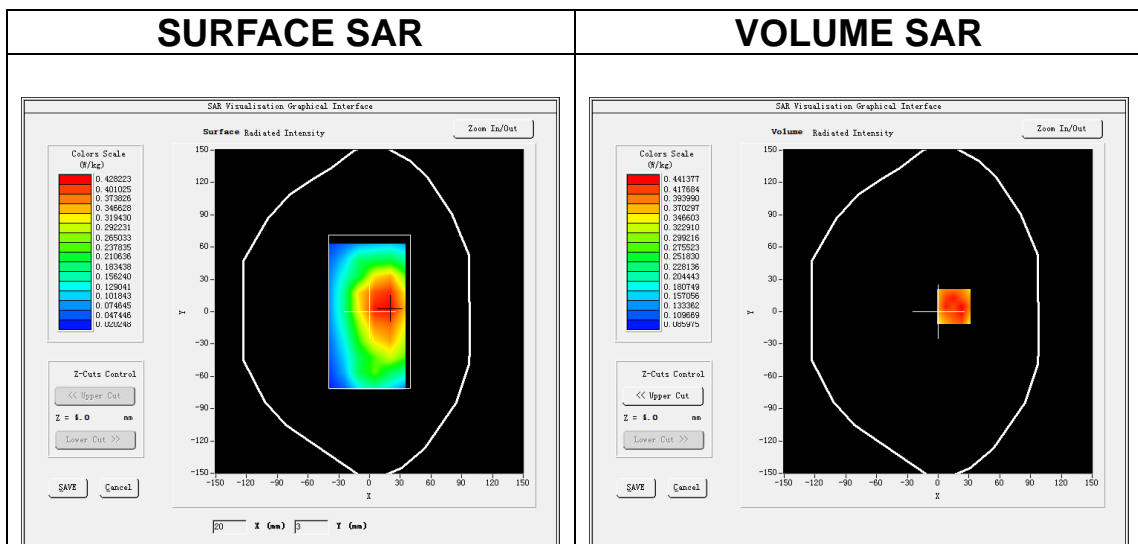

Maximum location: X=15.00, Y=5.00

SAR Peak: 0.60 W/kg

SAR 10g (W/Kg)	0.328512
SAR 1g (W/Kg)	0.441065

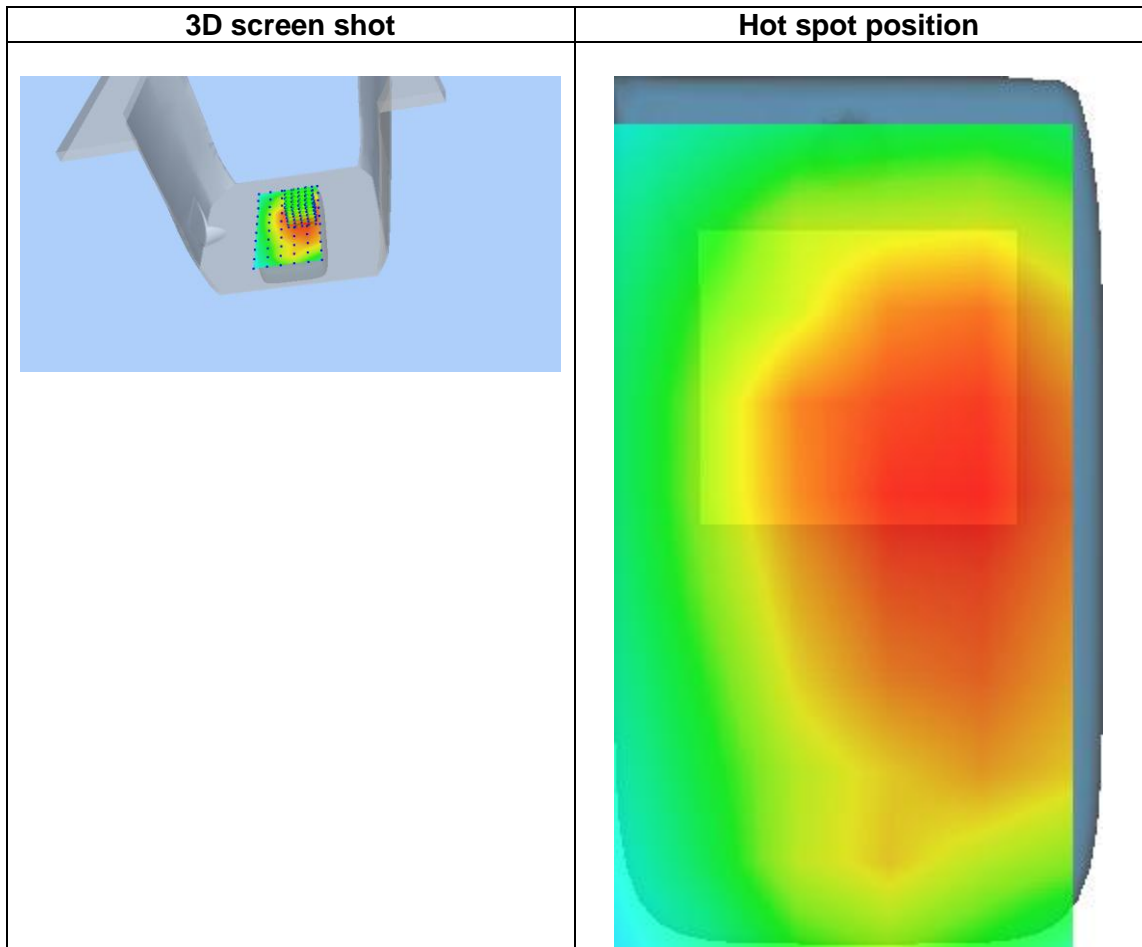
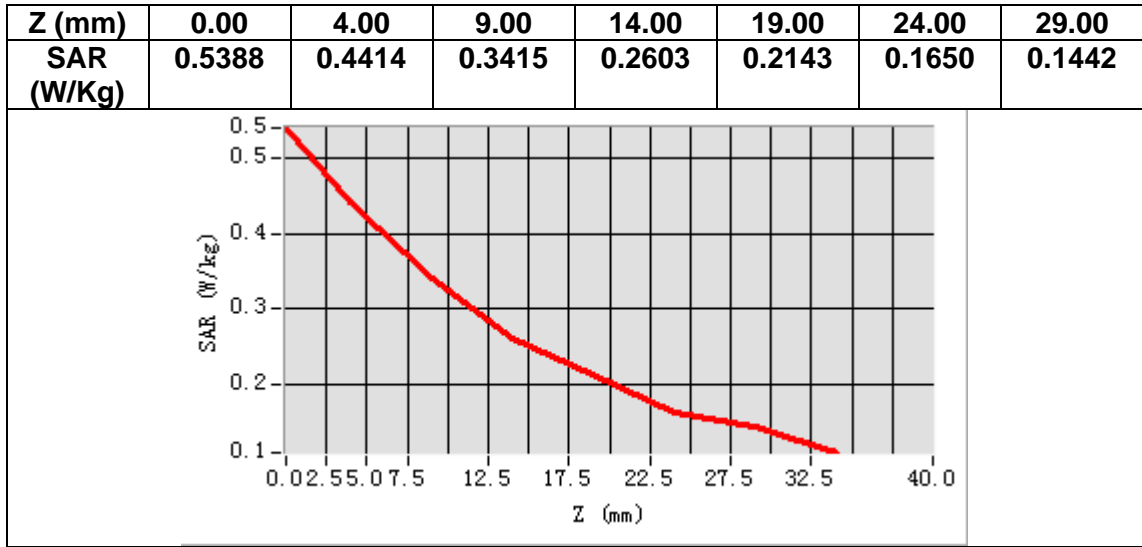

MEASUREMENT 3

A. Experimental conditions.

Area Scan	<u>dx=15mm dy=15mm, h= 5.00 mm</u>
ZoomScan	<u>5x5x7,dx=8mm dy=8mm dz=5mm</u>
Phantom	<u>Left head</u>
Device Position	<u>Cheek</u>
Band	<u>GSM1900</u>
Channels	<u>Middle</u>
Signal	<u>TDMA (Crest factor: 2.0)</u>

B. SAR Measurement Results

Frequency (MHz)	1880.000000
Relative permittivity (real part)	41.448200
Relative permittivity (imaginary part)	13.604300
Conductivity (S/m)	1.420894
Variation (%)	-1.710000

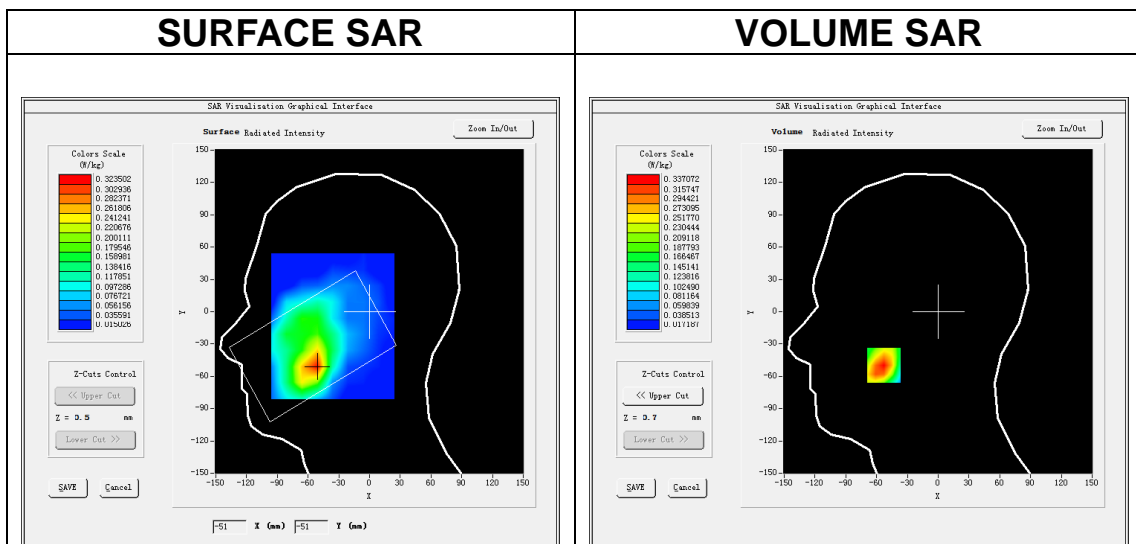

Maximum location: X=-53.00, Y=-50.00

SAR Peak: 0.46 W/kg

SAR 10g (W/Kg)	0.195329
SAR 1g (W/Kg)	0.320106

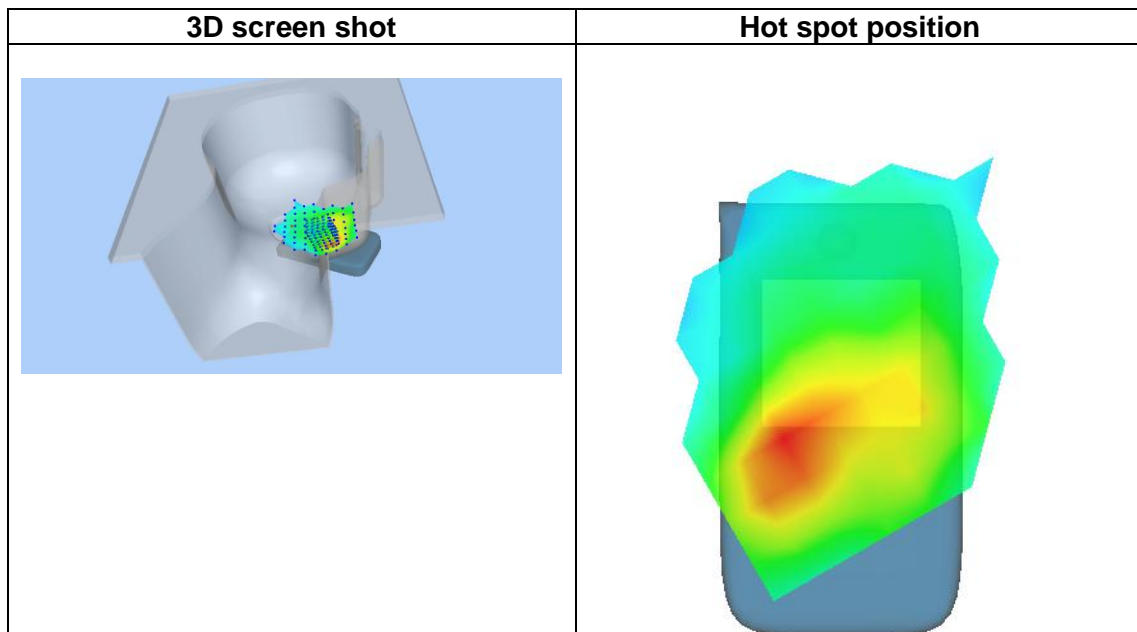
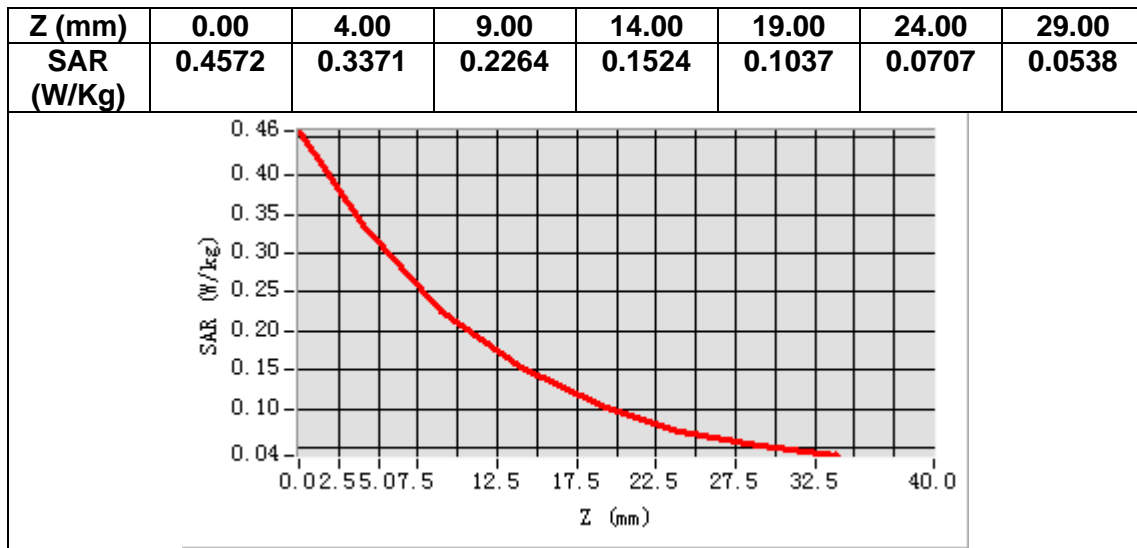

MEASUREMENT 4

A. Experimental conditions.

Area Scan	<u>dx=15mm dy=15mm, h= 5.00 mm</u>
ZoomScan	<u>5x5x7,dx=8mm dy=8mm dz=5mm</u>
Phantom	<u>Validation plane</u>
Device Position	<u>Body</u>
Band	<u>GSM1900</u>
Channels	<u>Middle</u>
Signal	<u>TDMA (Crest factor: 2.0)</u>

B. SAR Measurement Results

Frequency (MHz)	1880.000000
Relative permittivity (real part)	53.138901
Relative permittivity (imaginary part)	14.807700
Conductivity (S/m)	1.546582
Variation (%)	-0.720000

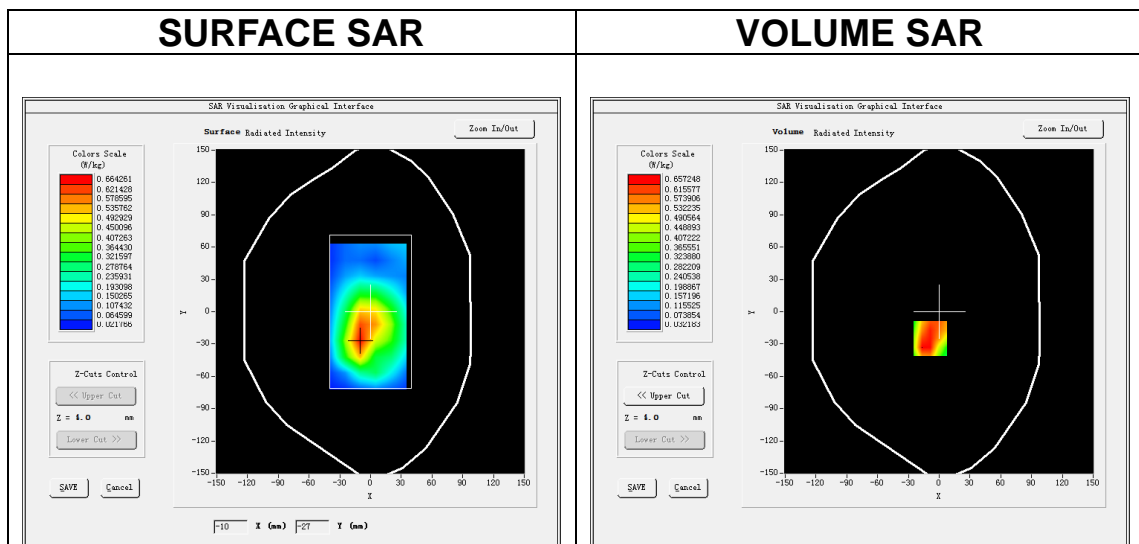

Maximum location: X=-9.00, Y=-25.00

SAR Peak: 1.13 W/kg

SAR 10g (W/Kg)	0.381479
SAR 1g (W/Kg)	0.670521

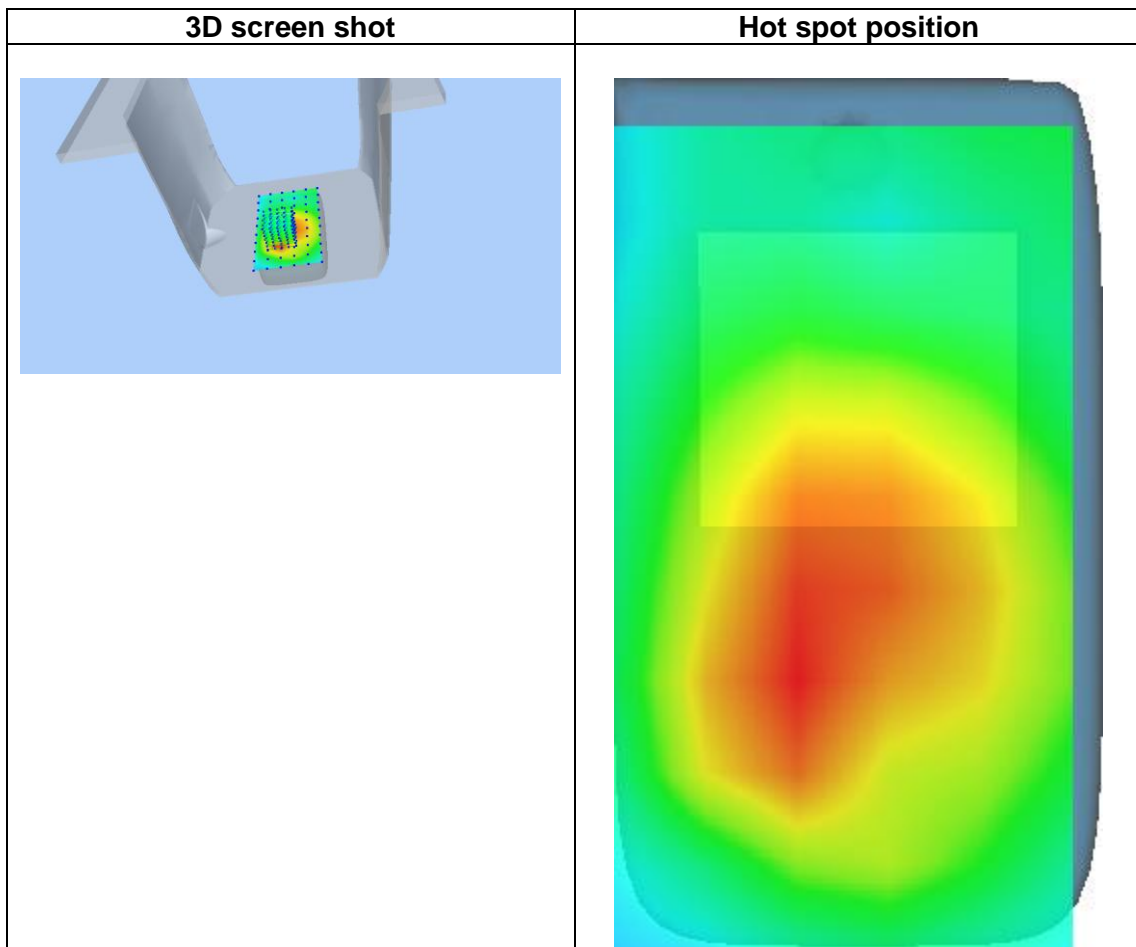
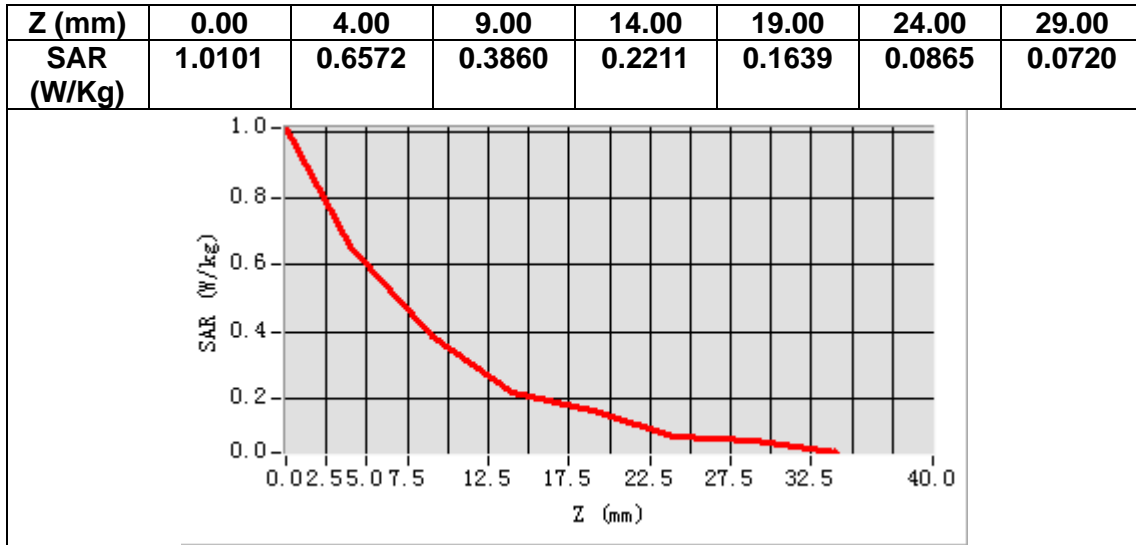

MEASUREMENT 5

A. Experimental conditions.

Area Scan	<u>dx=15mm dy=15mm, h= 5.00 mm</u>
ZoomScan	<u>5x5x7,dx=8mm dy=8mm dz=5mm</u>
Phantom	<u>Left head</u>
Device Position	<u>Cheek</u>
Band	<u>Band2 WCDMA1900</u>
Channels	<u>Middle</u>
Signal	<u>WCDMA (Crest factor: 1.0)</u>

B. SAR Measurement Results

Frequency (MHz)	1880.000000
Relative permittivity (real part)	41.448200
Relative permittivity (imaginary part)	13.604300
Conductivity (S/m)	1.420894
Variation (%)	-0.110000

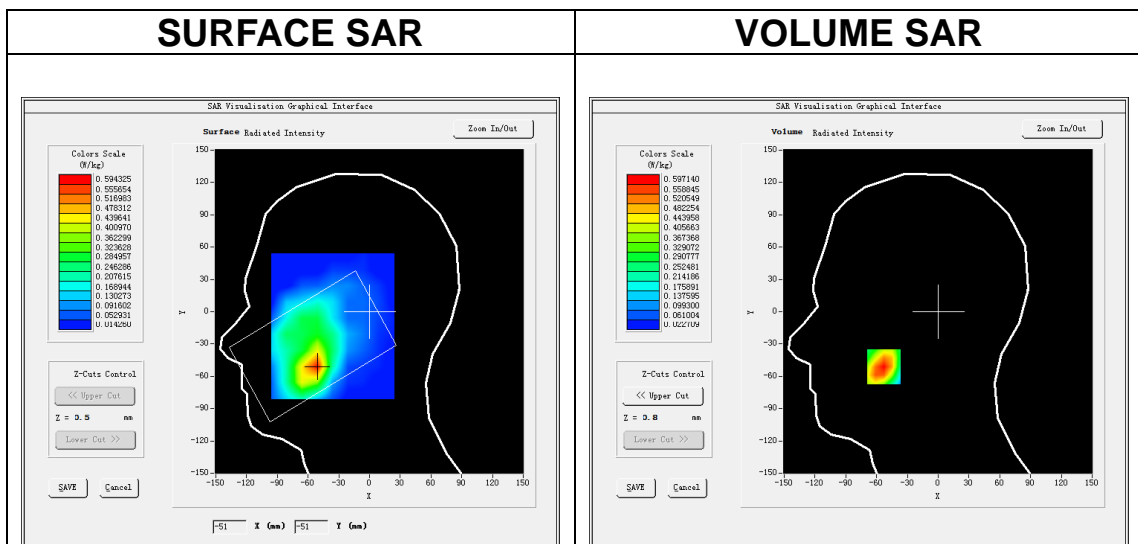

Maximum location: X=-53.00, Y=-51.00

SAR Peak: 0.83 W/kg

SAR 10g (W/Kg)	0.347719
SAR 1g (W/Kg)	0.570438

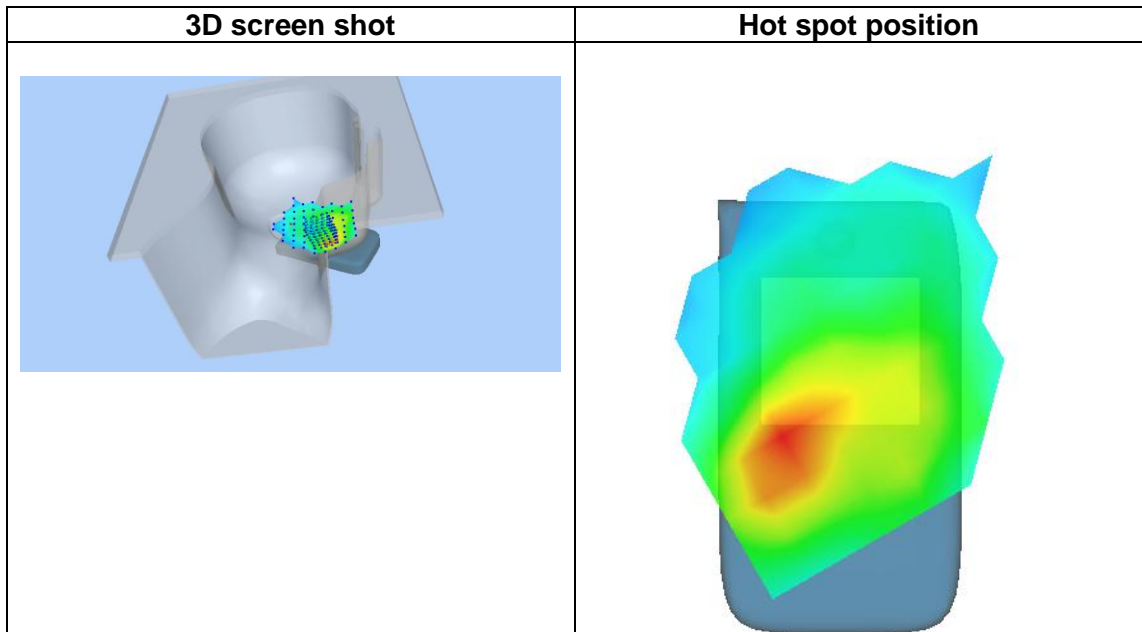
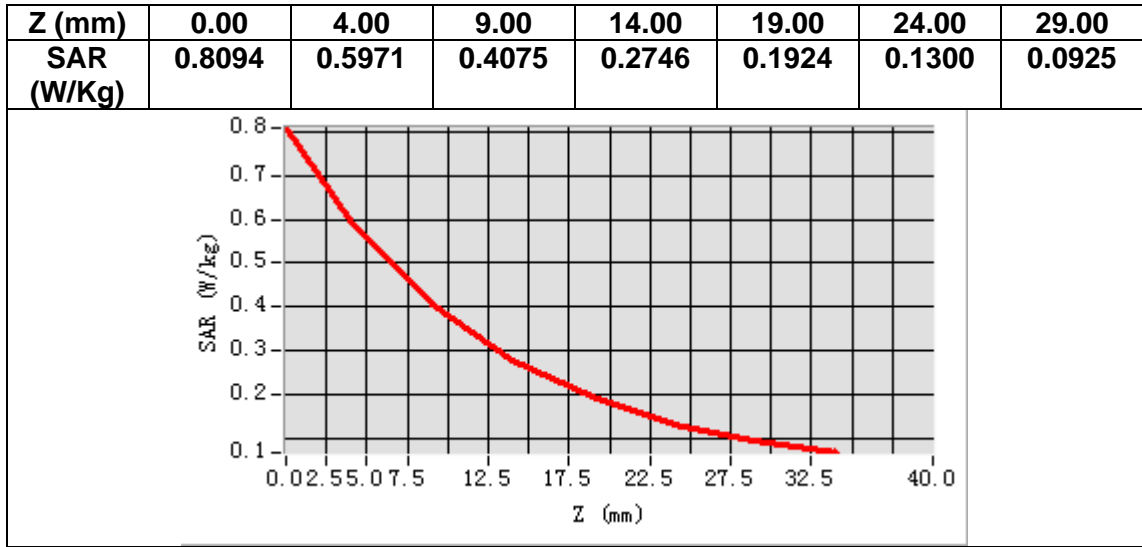

MEASUREMENT 6

A. Experimental conditions.

Area Scan	<u>dx=15mm dy=15mm, h= 5.00 mm</u>
ZoomScan	<u>5x5x7,dx=8mm dy=8mm dz=5mm</u>
Phantom	<u>Validation plane</u>
Device Position	<u>Body</u>
Band	<u>Band2 WCDMA1900</u>
Channels	<u>Low</u>
Signal	<u>WCDMA (Crest factor: 1.0)</u>

B. SAR Measurement Results

Frequency (MHz)	1852.400000
Relative permittivity (real part)	53.254059
Relative permittivity (imaginary part)	14.859240
Conductivity (S/m)	1.529181
Variation (%)	0.110000

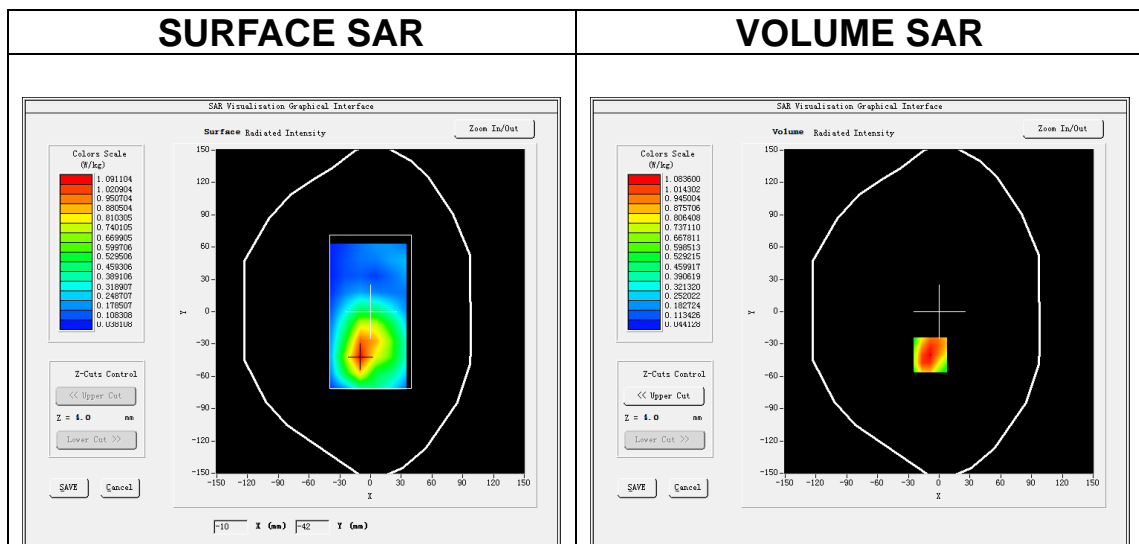

Maximum location: X=-9.00, Y=-40.00

SAR Peak: 1.66 W/kg

SAR 10g (W/Kg)	0.629878
SAR 1g (W/Kg)	1.059490

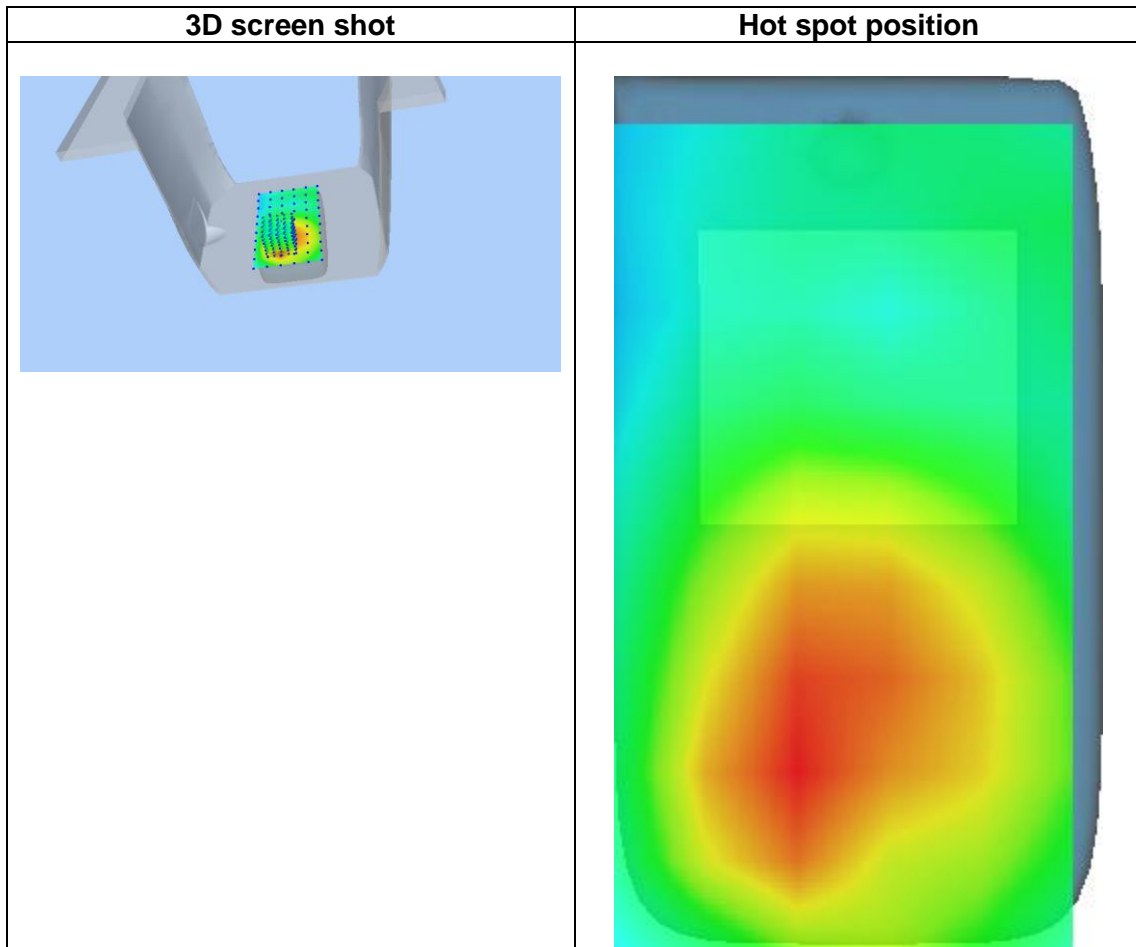
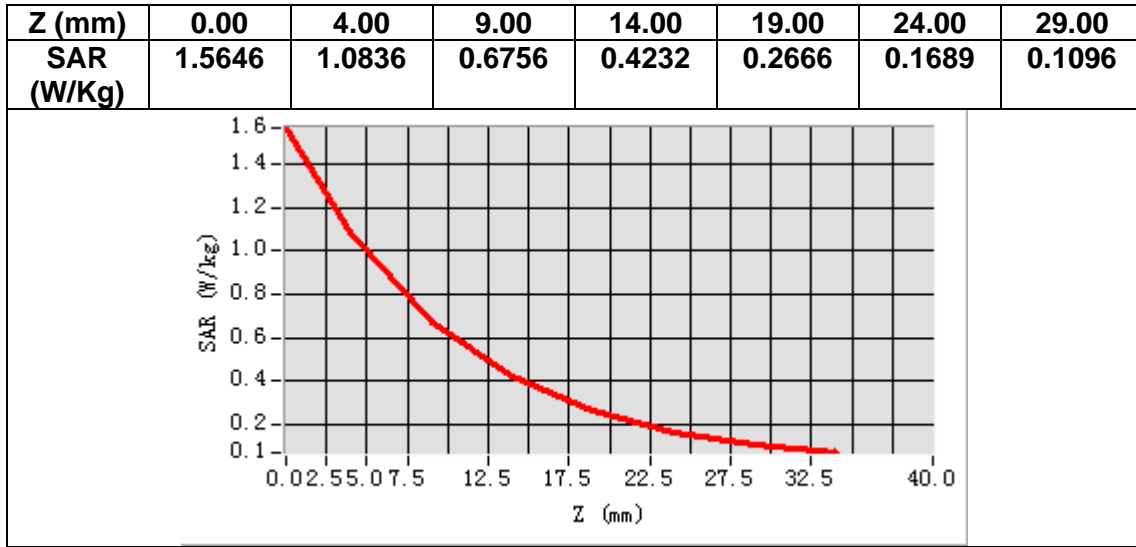

MEASUREMENT 7

A. Experimental conditions.

Area Scan	<u>dx=15mm dy=15mm, h= 5.00 mm</u>
ZoomScan	<u>5x5x7,dx=8mm dy=8mm dz=5mm</u>
Phantom	<u>Left head</u>
Device Position	<u>Cheek</u>
Band	<u>Band5_WCDMA850</u>
Channels	<u>Middle</u>
Signal	<u>WCDMA (Crest factor: 1.0)</u>

B. SAR Measurement Results

Frequency (MHz)	836.400000
Relative permittivity (real part)	41.260960
Relative permittivity (imaginary part)	19.761539
Conductivity (S/m)	0.918253
Variation (%)	0.210000

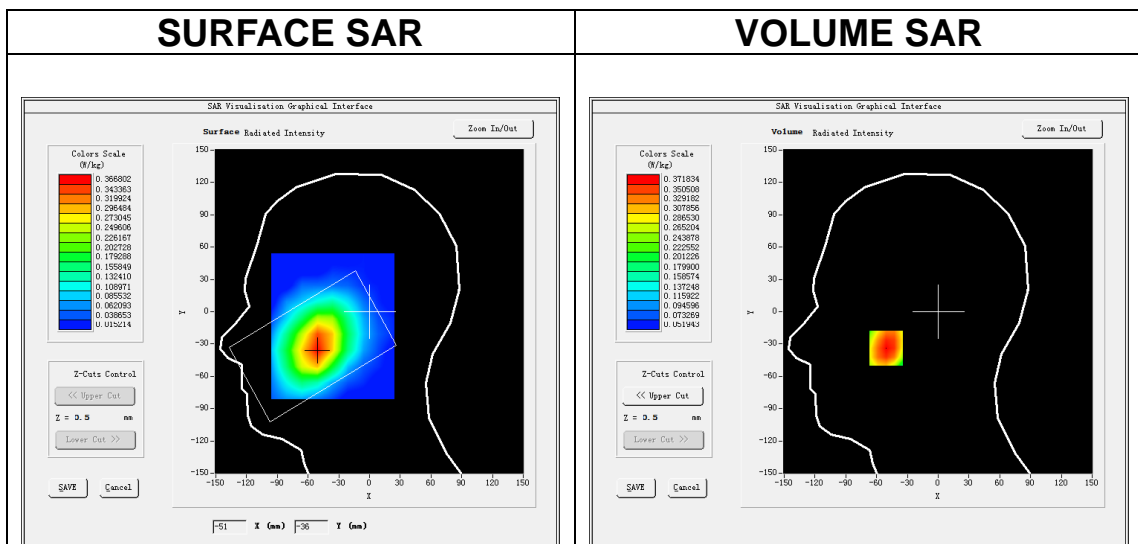

Maximum location: X=-51.00, Y=-34.00

SAR Peak: 0.45 W/kg

SAR 10g (W/Kg)	0.286941
SAR 1g (W/Kg)	0.369060

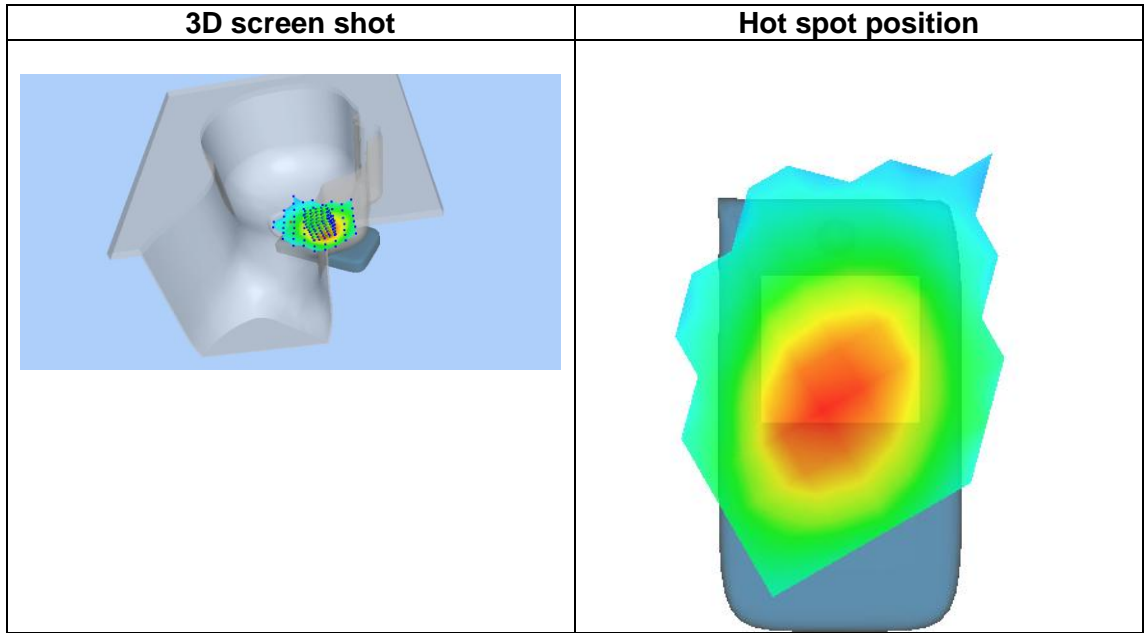
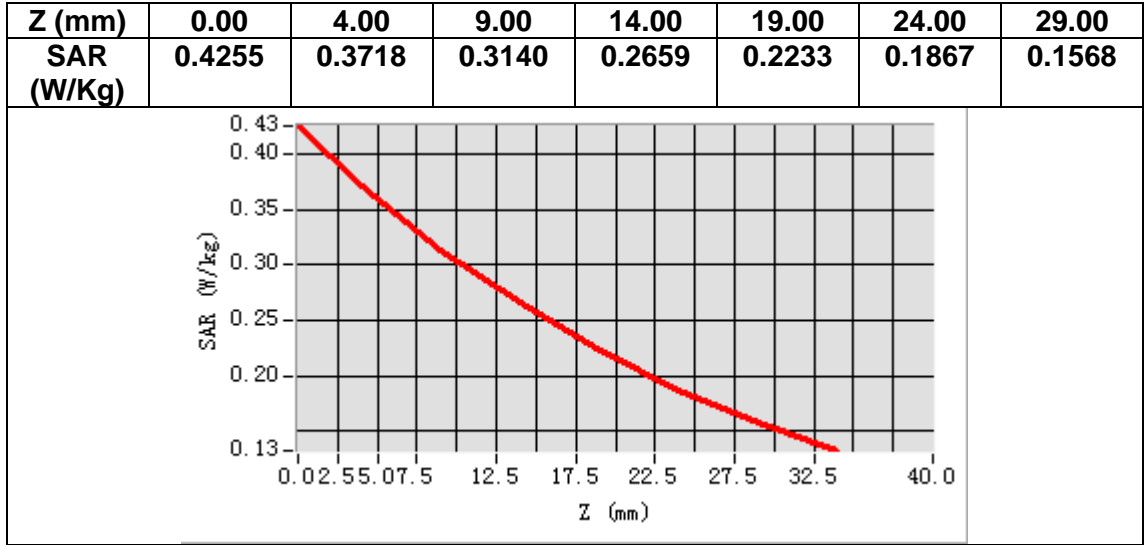

MEASUREMENT 8

A. Experimental conditions.

Area Scan	<u>dx=15mm dy=15mm, h= 5.00 mm</u>
ZoomScan	<u>5x5x7,dx=8mm dy=8mm dz=5mm</u>
Phantom	<u>Validation plane</u>
Device Position	<u>Body</u>
Band	<u>Band5_WCDMA850</u>
Channels	<u>Middle</u>
Signal	<u>WCDMA (Crest factor: 1.0)</u>

B. SAR Measurement Results

Frequency (MHz)	836.400000
Relative permittivity (real part)	54.829578
Relative permittivity (imaginary part)	21.562740
Conductivity (S/m)	1.001949
Variation (%)	0.080000

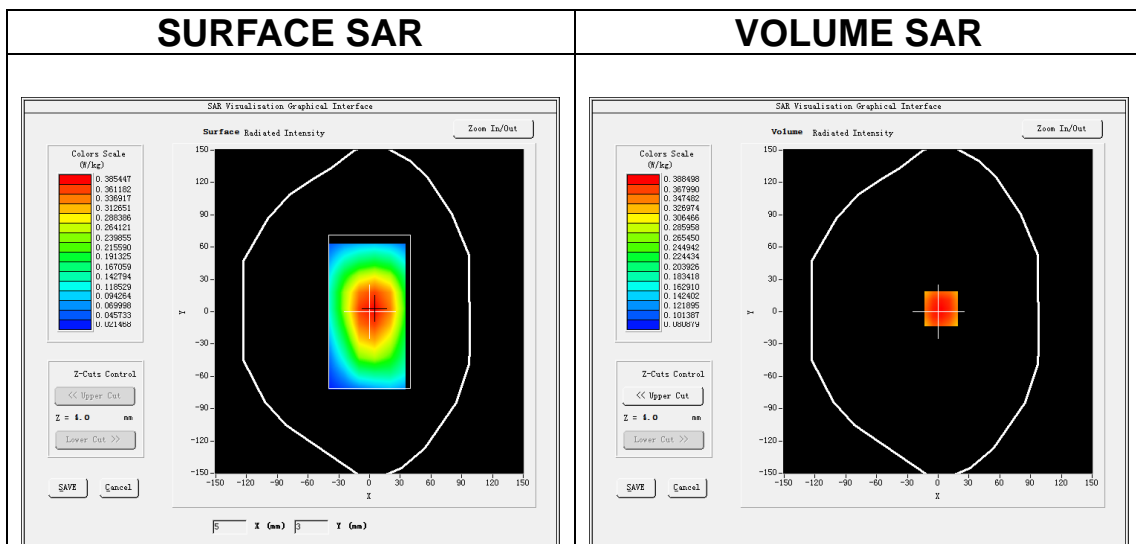

Maximum location: X=3.00, Y=3.00

SAR Peak: 0.46 W/kg

SAR 10g (W/Kg)	0.300258
SAR 1g (W/Kg)	0.386437

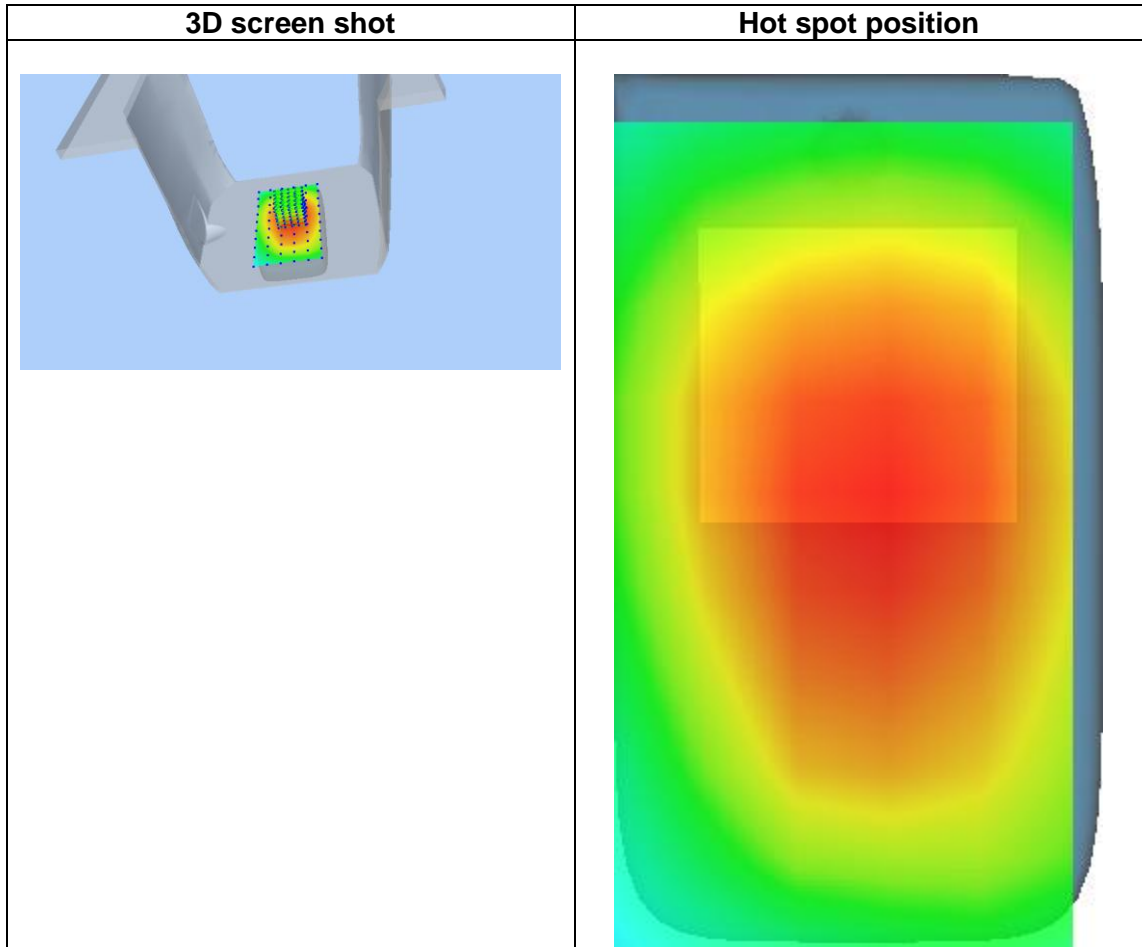
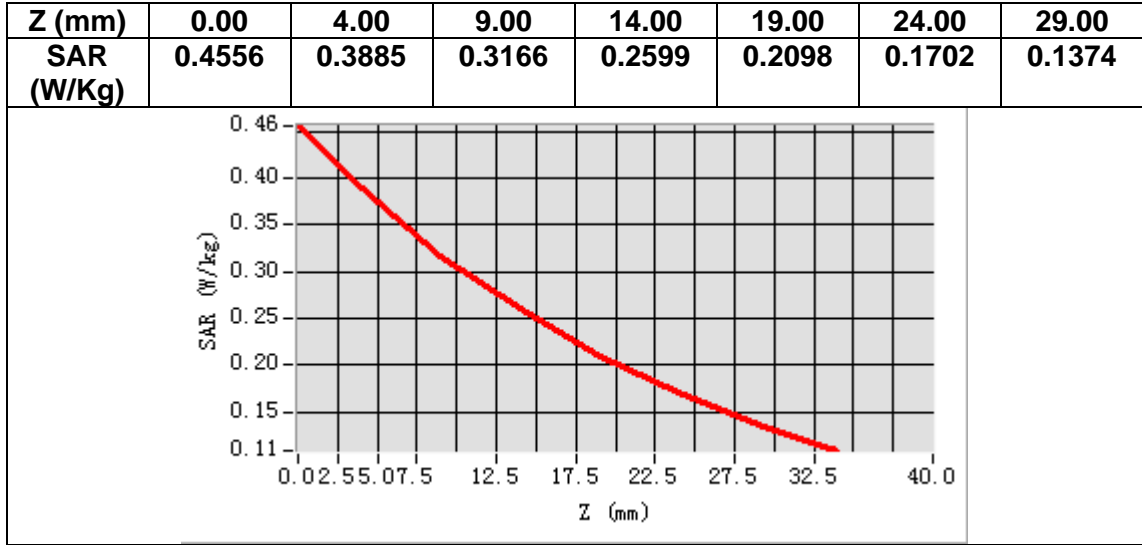

MEASUREMENT 9

A. Experimental conditions.

Area Scan	<u>dx=12mm dy=12mm, h= 5.00 mm</u>
ZoomScan	<u>7x7x7,dx=5mm dy=5mm dz=5mm</u>
Phantom	<u>Left head</u>
Device Position	<u>Cheek</u>
Band	<u>IEEE 802.11b ISM</u>
Channels	<u>Middle</u>
Signal	<u>IEEE802.11b (Crest factor: 1.0)</u>

B. SAR Measurement Results

Frequency (MHz)	2437.000000
Relative permittivity (real part)	39.761002
Relative permittivity (imaginary part)	13.350300
Conductivity (S/m)	1.807482
Variation (%)	-2.270000

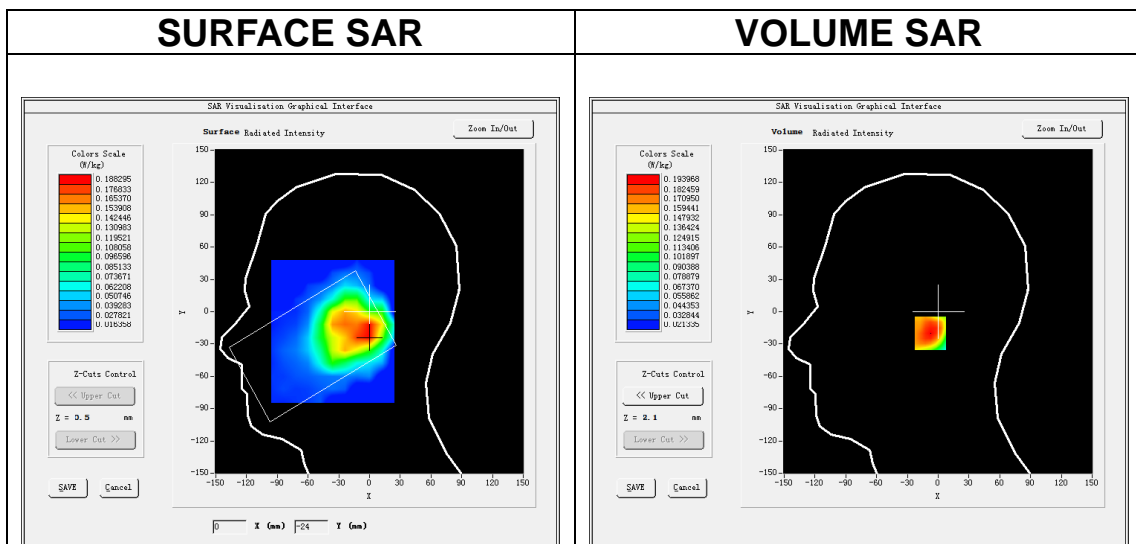

Maximum location: X=-2.00, Y=-20.00

SAR Peak: 0.27 W/kg

SAR 10g (W/Kg)	0.118661
SAR 1g (W/Kg)	0.184206

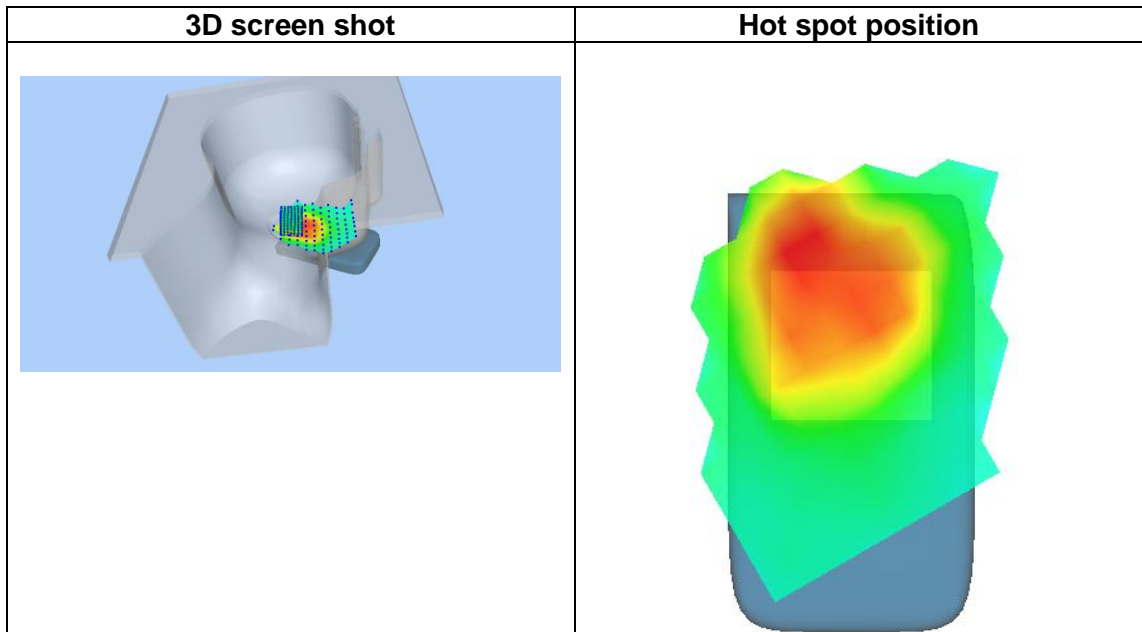
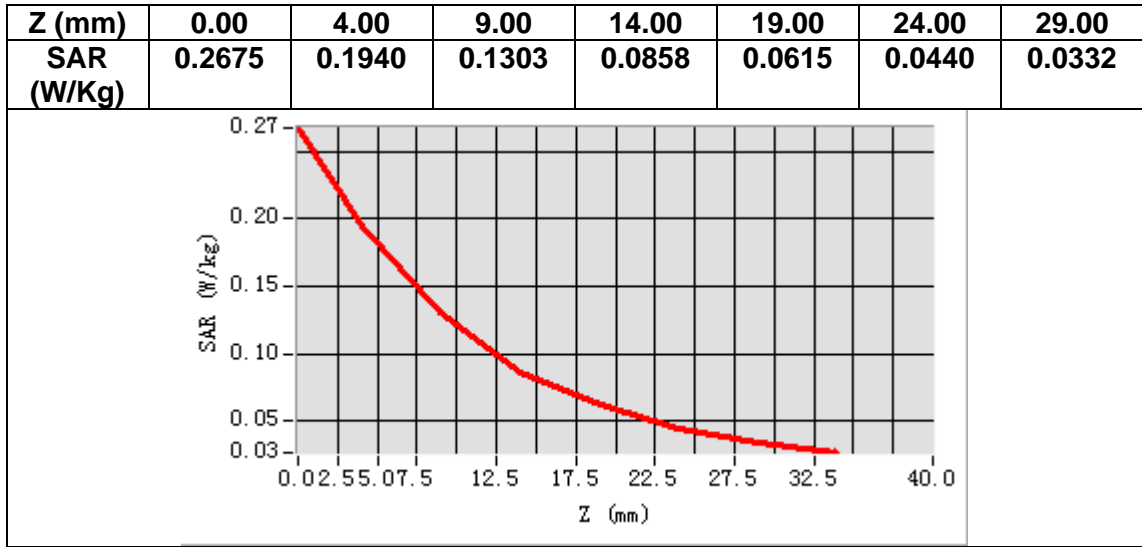

MEASUREMENT 10

A. Experimental conditions.

Area Scan	<u>dx=12mm dy=12mm, h= 5.00 mm</u>
ZoomScan	<u>7x7x7,dx=5mm dy=5mm dz=5mm</u>
Phantom	<u>Validation plane</u>
Device Position	<u>Body</u>
Band	<u>IEEE 802.11b ISM</u>
Channels	<u>Middle</u>
Signal	<u>IEEE802.11b (Crest factor: 1.0)</u>

B. SAR Measurement Results

Frequency (MHz)	2437.000000
Relative permittivity (real part)	52.621601
Relative permittivity (imaginary part)	14.595620
Conductivity (S/m)	1.976085
Variation (%)	1.090000

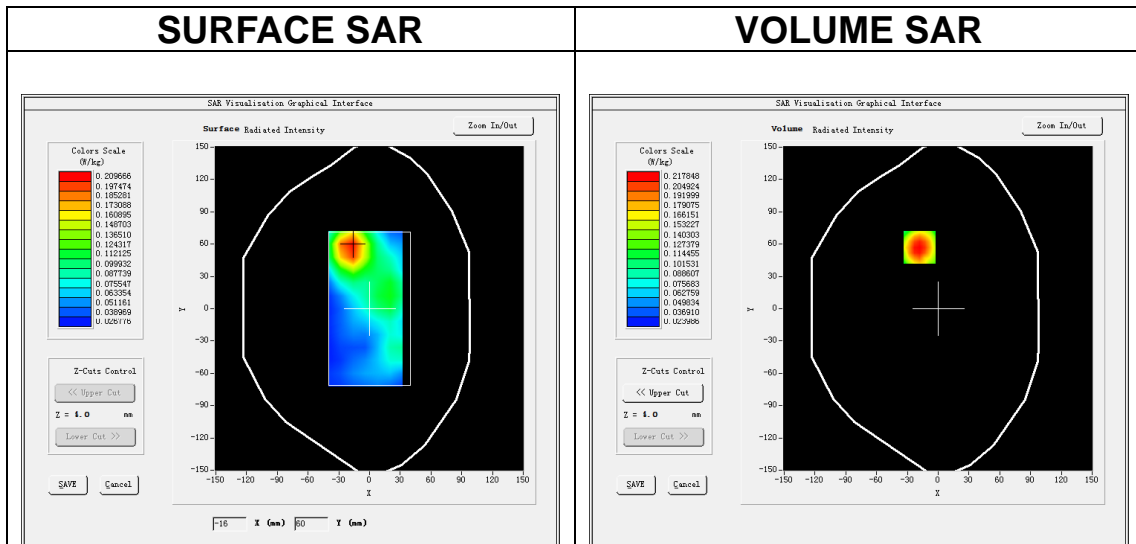

Maximum location: X=-18.00, Y=57.00

SAR Peak: 0.32 W/kg

SAR 10g (W/Kg)	0.127615
SAR 1g (W/Kg)	0.209672

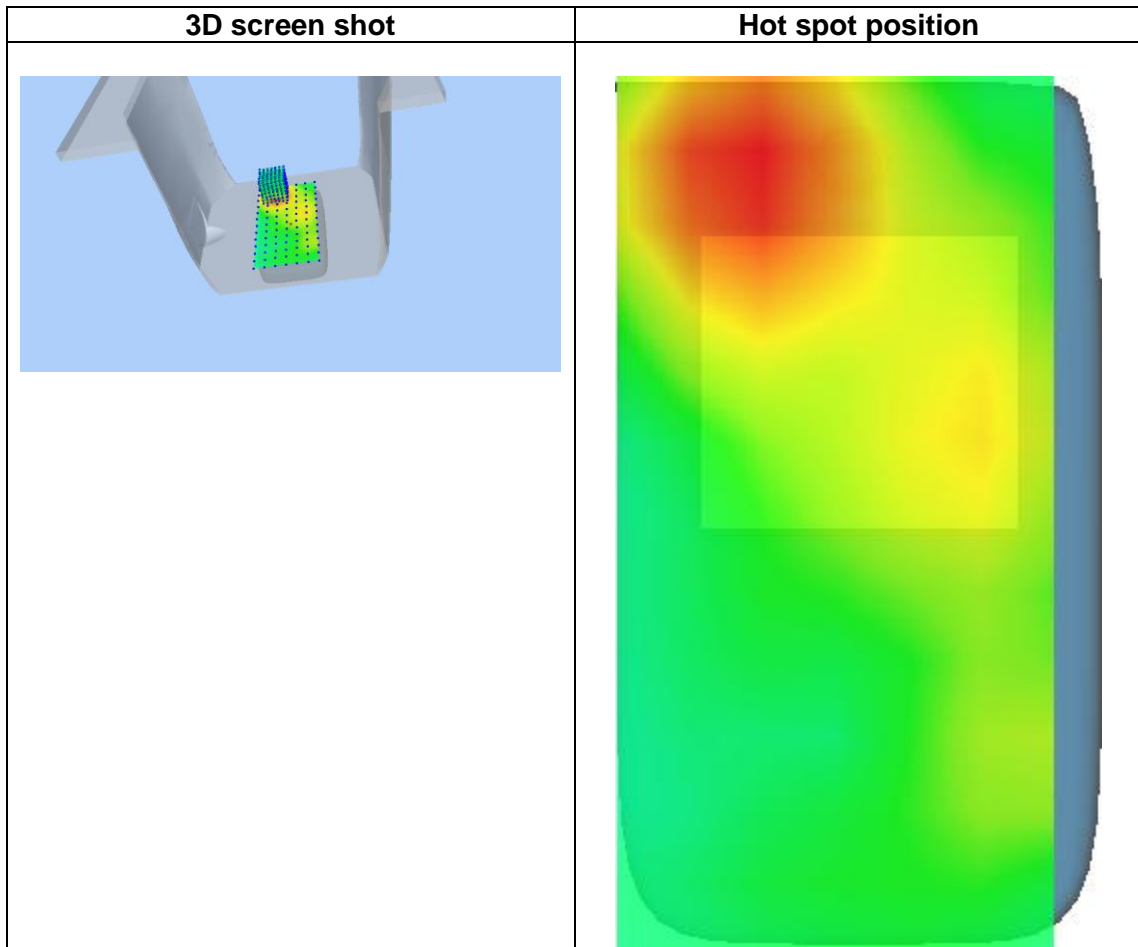
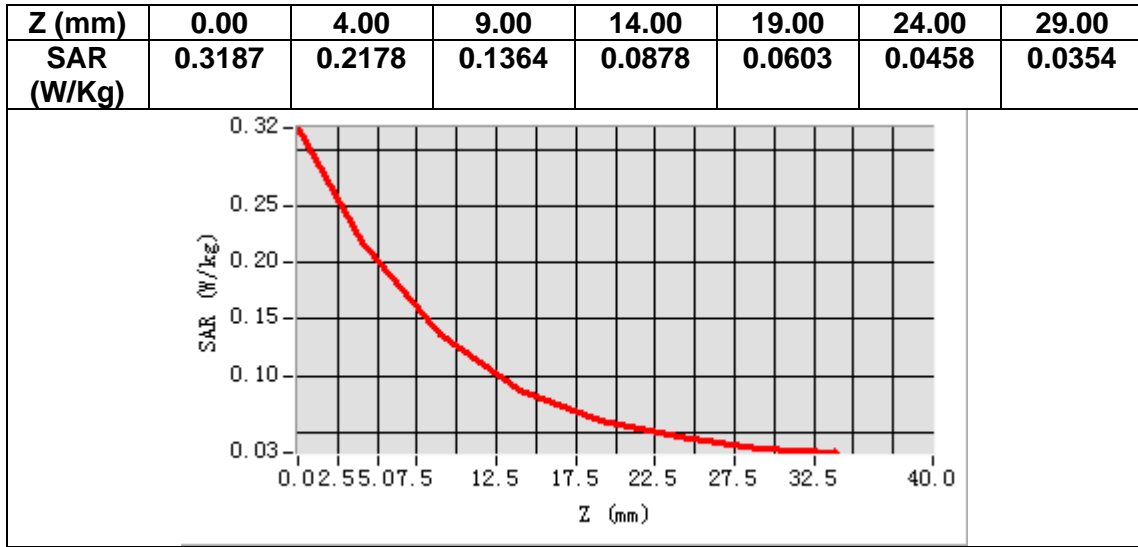

MEASUREMENT 11

A. Experimental conditions.

Area Scan	<u>dx=15mm dy=15mm, h= 5.00 mm</u>
ZoomScan	<u>5x5x7,dx=8mm dy=8mm dz=5mm</u>
Phantom	<u>Left head</u>
Device Position	<u>Cheek</u>
Band	<u>LTE band 2</u>
Channels	<u>Middle</u>
Signal	<u>LTE (Crest factor: 1.0)</u>

B. SAR Measurement Results

Frequency (MHz)	1880.000000
Relative permittivity (real part)	41.493801
Relative permittivity (imaginary part)	13.598100
Conductivity (S/m)	1.419868
Variation (%)	-1.270000

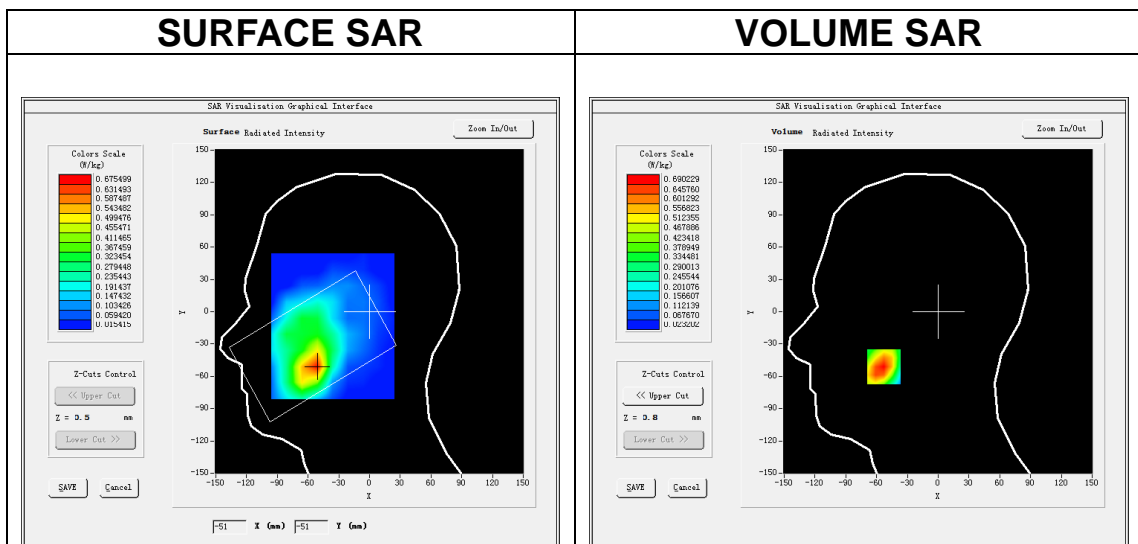

Maximum location: X=-53.00, Y=-51.00

SAR Peak: 0.97 W/kg

SAR 10g (W/Kg)	0.403342
SAR 1g (W/Kg)	0.662744

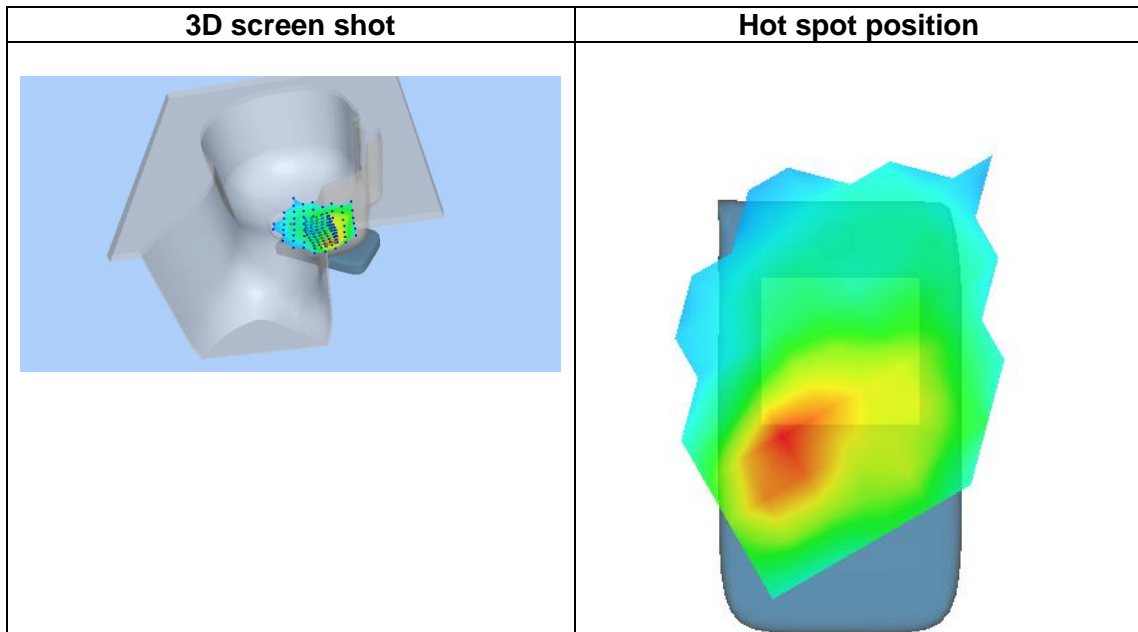
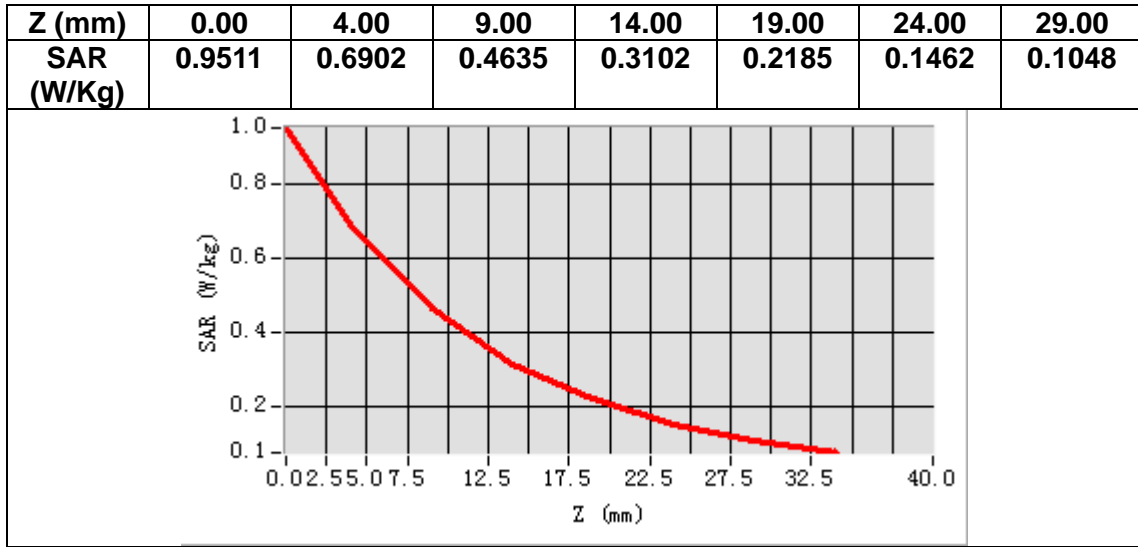

MEASUREMENT 12

A. Experimental conditions.

Area Scan	<u>dx=15mm dy=15mm, h= 5.00 mm</u>
ZoomScan	<u>5x5x7,dx=8mm dy=8mm dz=5mm</u>
Phantom	<u>Validation plane</u>
Device Position	<u>Body</u>
Band	<u>LTE band 2</u>
Channels	<u>Low</u>
Signal	<u>LTE (Crest factor: 1.0)</u>

B. SAR Measurement Results

Frequency (MHz)	1860.000000
Relative permittivity (real part)	53.194248
Relative permittivity (imaginary part)	14.845600
Conductivity (S/m)	1.533633
Variation (%)	-2.540000

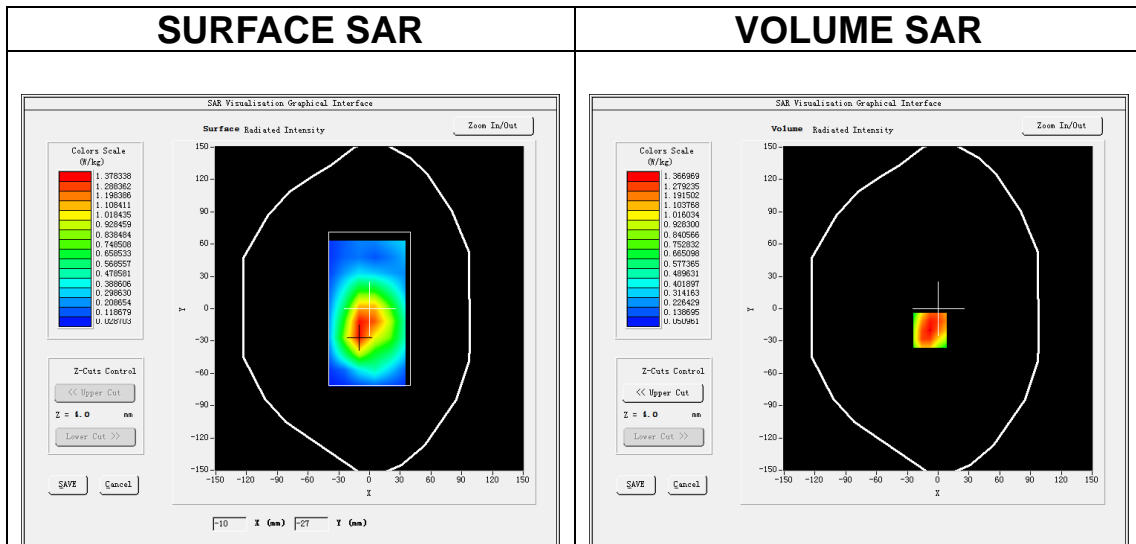

Maximum location: X=-8.00, Y=-20.00

SAR Peak: 2.07 W/kg

SAR 10g (W/Kg)	0.805720
SAR 1g (W/Kg)	1.121016

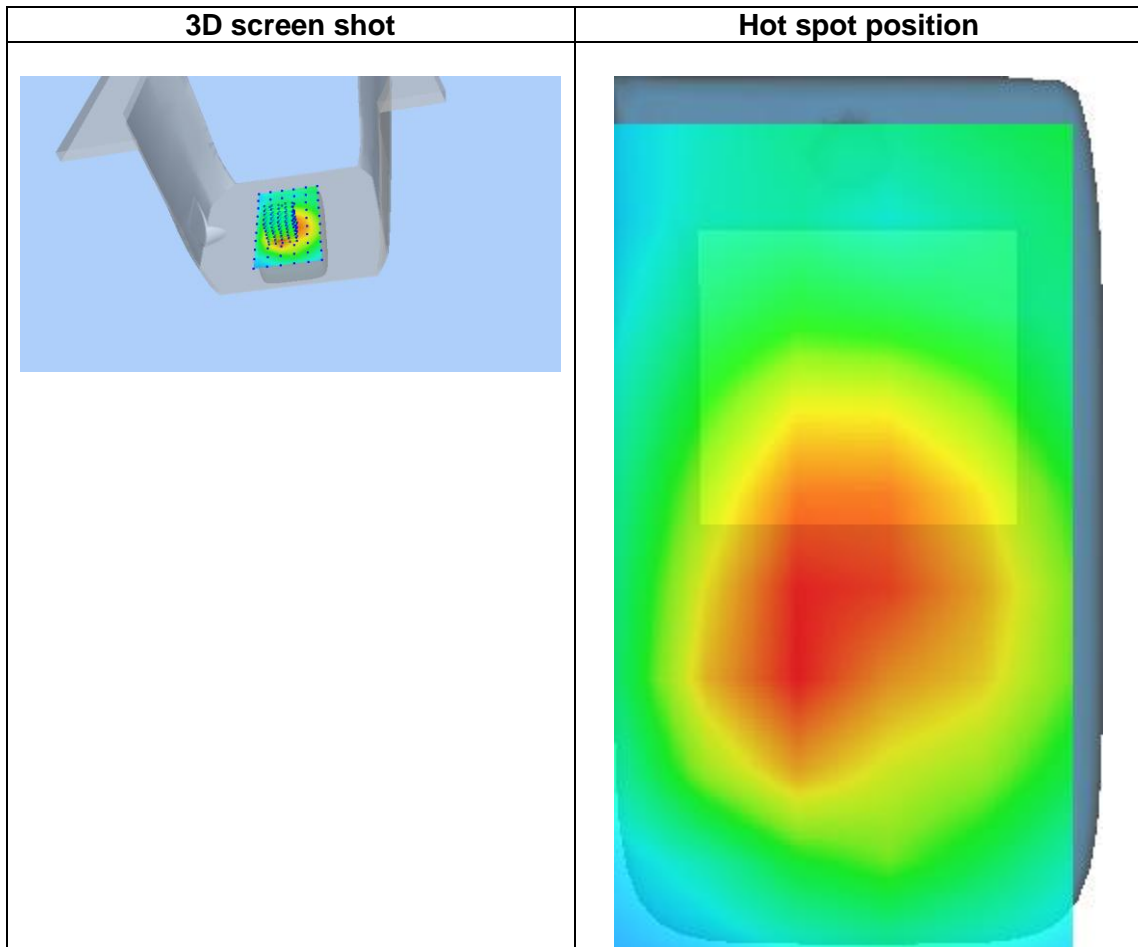
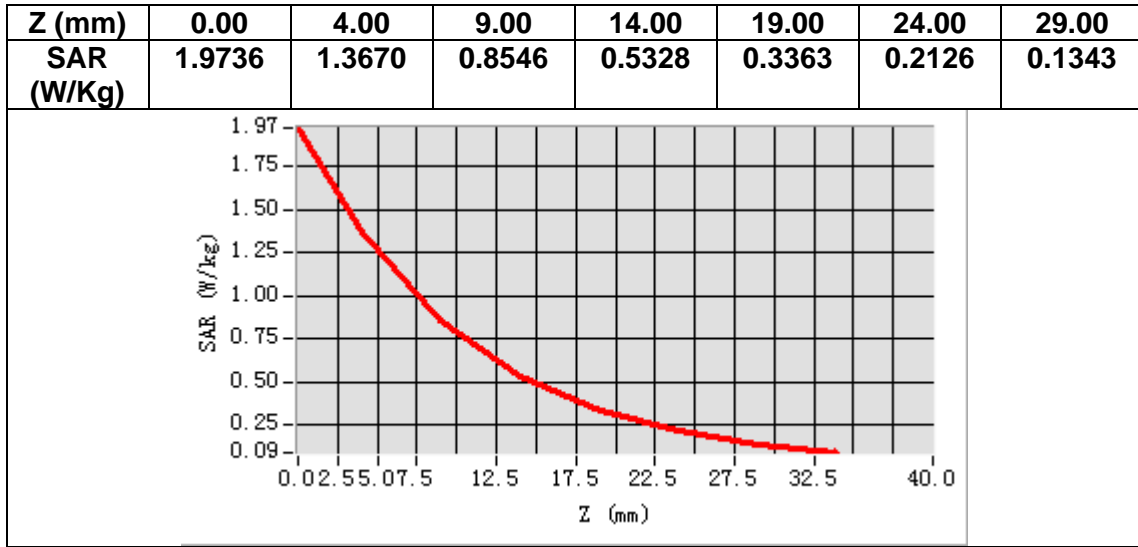

MEASUREMENT 13

A. Experimental conditions.

Area Scan	<u>dx=15mm dy=15mm, h= 5.00 mm</u>
ZoomScan	<u>5x5x7,dx=8mm dy=8mm dz=5mm</u>
Phantom	<u>Left head</u>
Device Position	<u>Cheek</u>
Band	<u>LTE band 4</u>
Channels	<u>Middle</u>
Signal	<u>LTE (Crest factor: 1.0)</u>

B. SAR Measurement Results

Frequency (MHz)	1732.500000
Relative permittivity (real part)	39.985291
Relative permittivity (imaginary part)	13.940592
Conductivity (S/m)	1.341782
Variation (%)	-1.320000

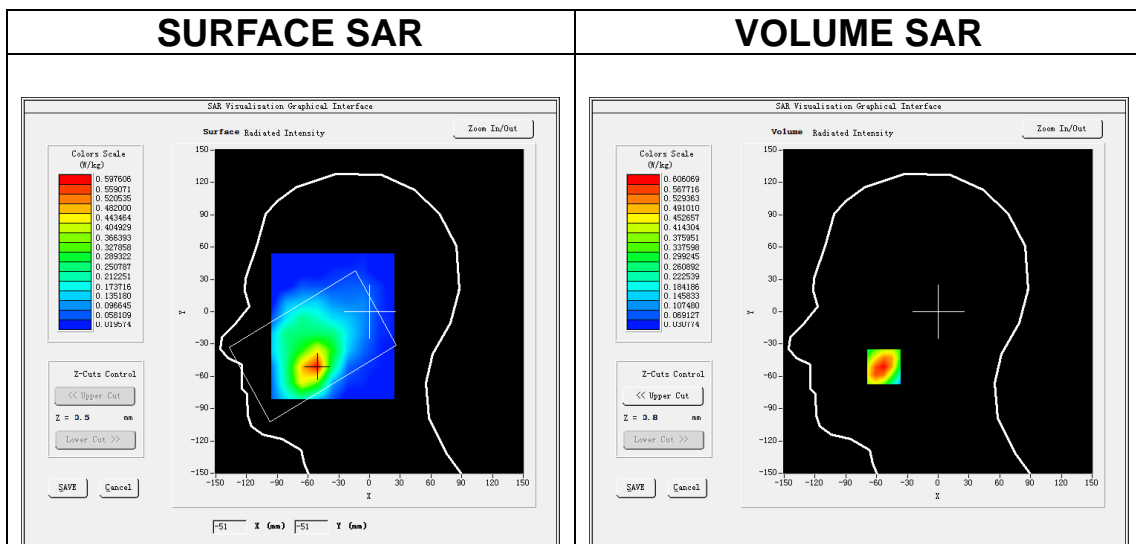

Maximum location: X=-53.00, Y=-51.00

SAR Peak: 0.82 W/kg

SAR 10g (W/Kg)	0.369822
SAR 1g (W/Kg)	0.580256

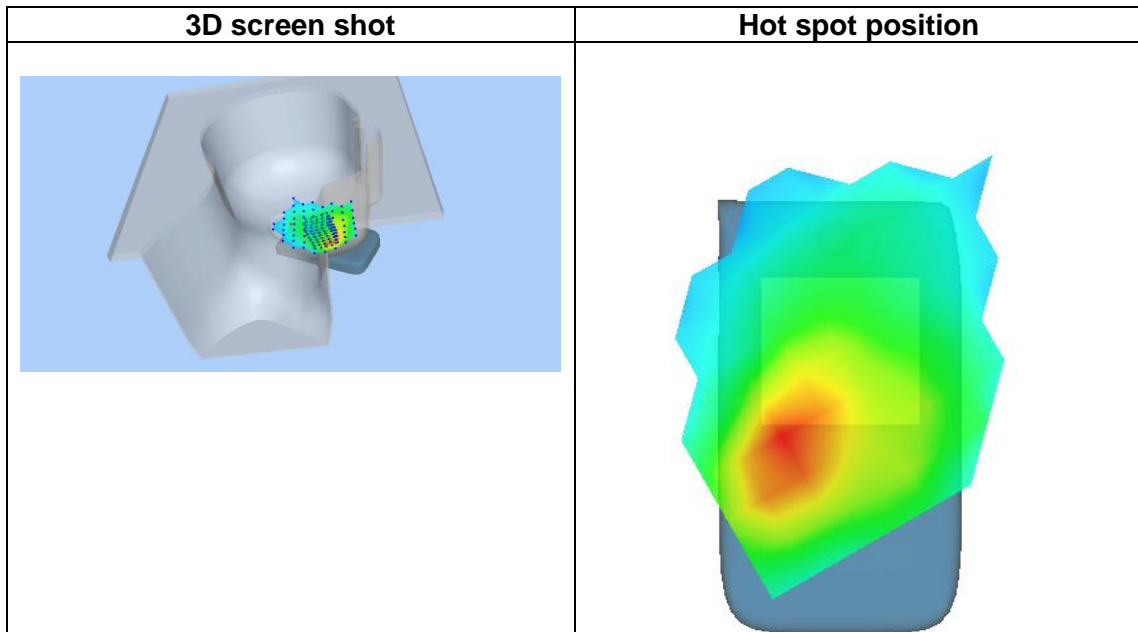
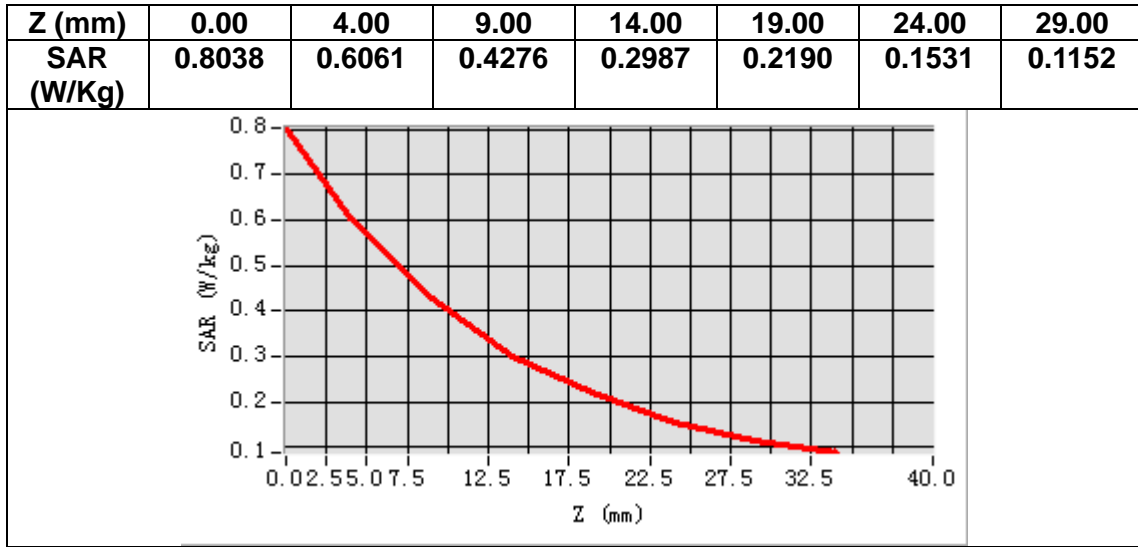

MEASUREMENT 14

A. Experimental conditions.

Area Scan	<u>dx=15mm dy=15mm, h= 5.00 mm</u>
ZoomScan	<u>5x5x7,dx=8mm dy=8mm dz=5mm</u>
Phantom	<u>Validation plane</u>
Device Position	<u>Body</u>
Band	<u>LTE band 4</u>
Channels	<u>Low</u>
Signal	<u>LTE (Crest factor: 1.0)</u>

B. SAR Measurement Results

Frequency (MHz)	1720.000000
Relative permittivity (real part)	54.216667
Relative permittivity (imaginary part)	15.367870
Conductivity (S/m)	1.468058
Variation (%)	-0.390000

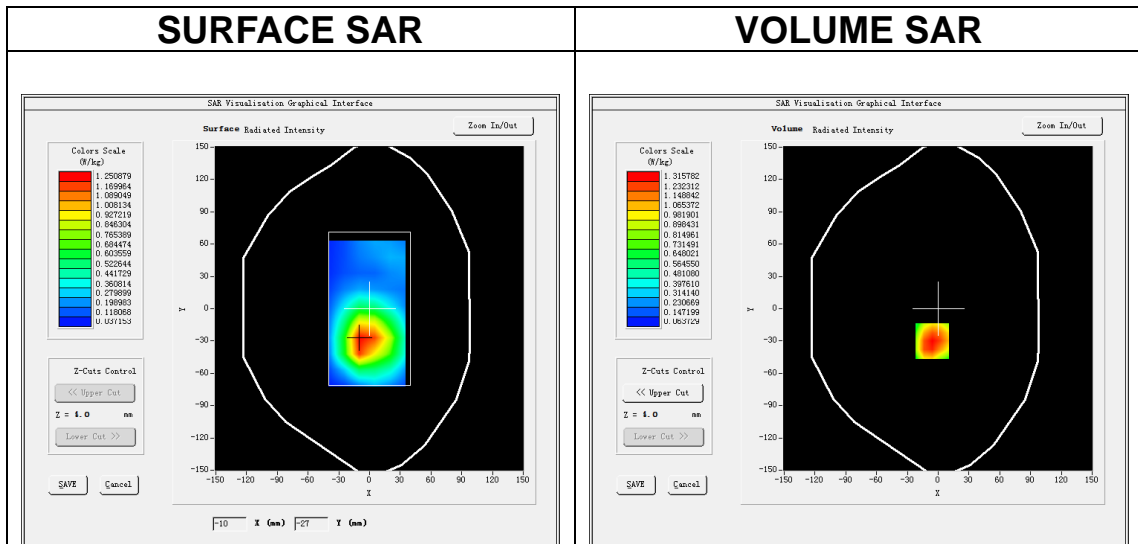

Maximum location: X=-6.00, Y=-30.00

SAR Peak: 1.88 W/kg

SAR 10g (W/Kg)	0.788960
SAR 1g (W/Kg)	1.112285

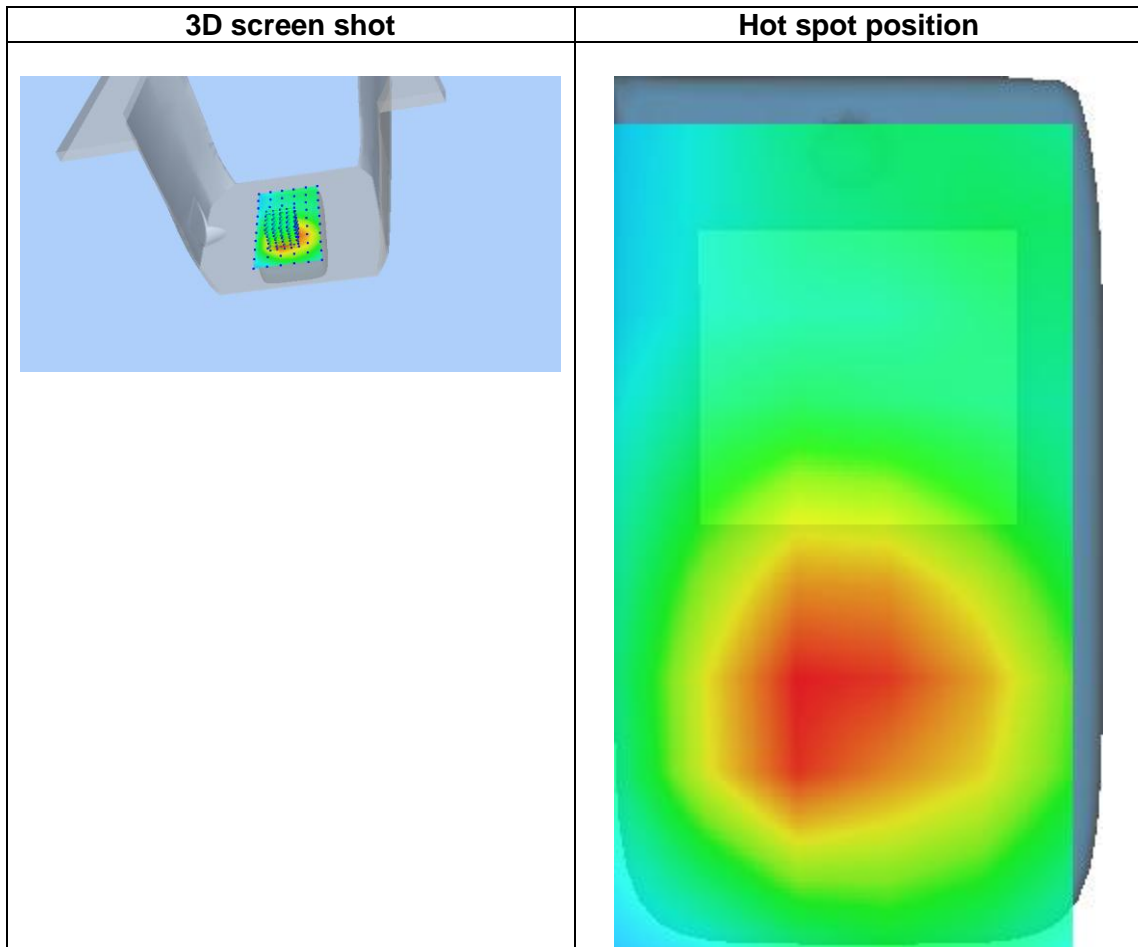
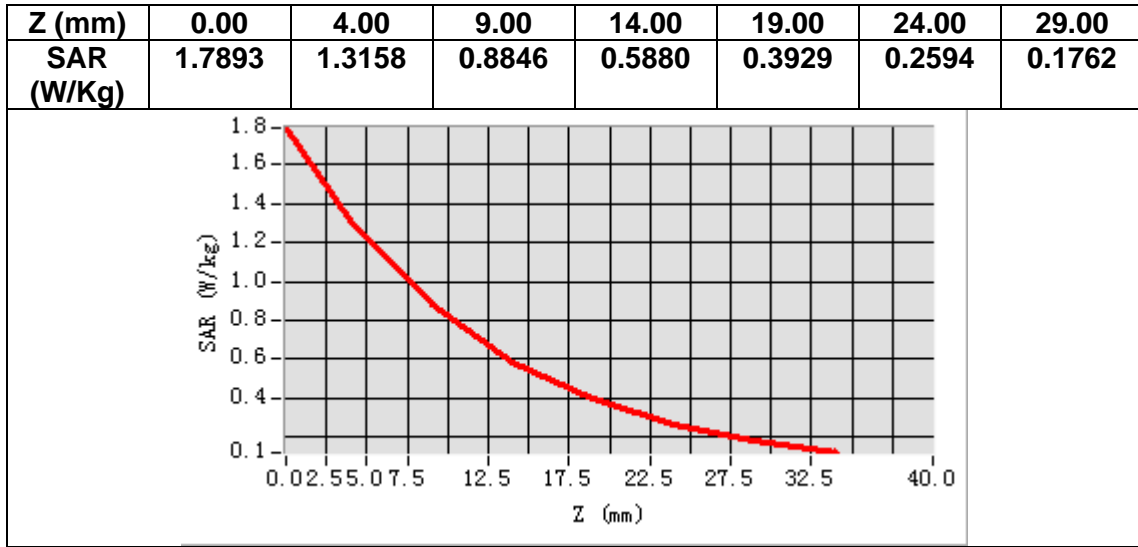

MEASUREMENT 15

A. Experimental conditions.

Area Scan	<u>dx=15mm dy=15mm, h= 5.00 mm</u>
ZoomScan	<u>5x5x7,dx=8mm dy=8mm dz=5mm</u>
Phantom	<u>Left head</u>
Device Position	<u>Cheek</u>
Band	<u>LTE band 5</u>
Channels	<u>Middle</u>
Signal	<u>LTE (Crest factor: 1.0)</u>

B. SAR Measurement Results

Frequency (MHz)	836.500000
Relative permittivity (real part)	41.263550
Relative permittivity (imaginary part)	19.760201
Conductivity (S/m)	0.918300
Variation (%)	-1.340000

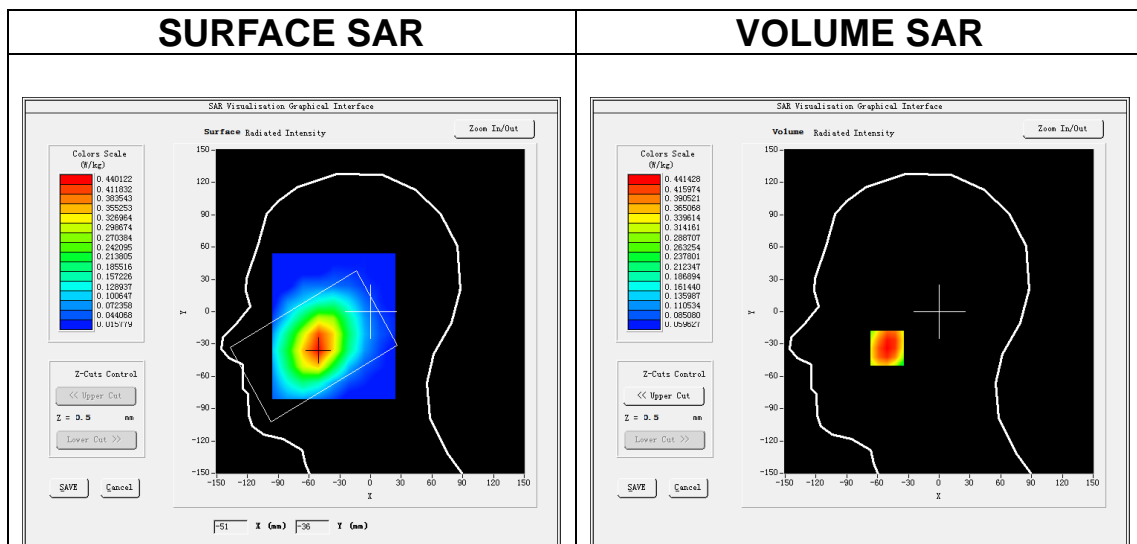

Maximum location: X=-51.00, Y=-34.00

SAR Peak: 0.53 W/kg

SAR 10g (W/Kg)	0.341967
SAR 1g (W/Kg)	0.439356

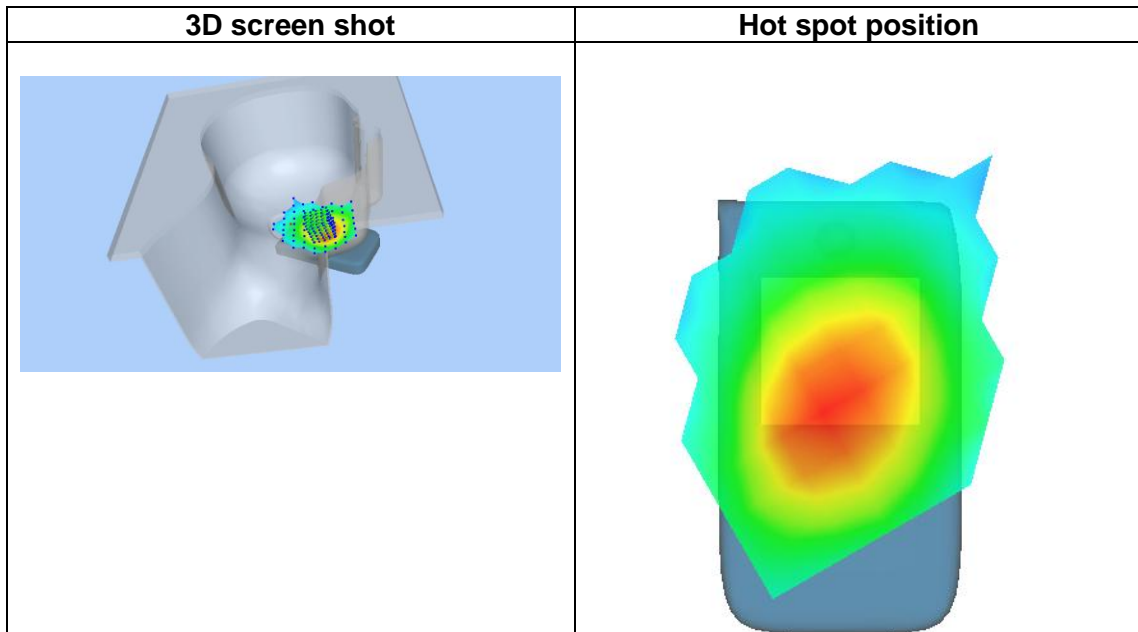
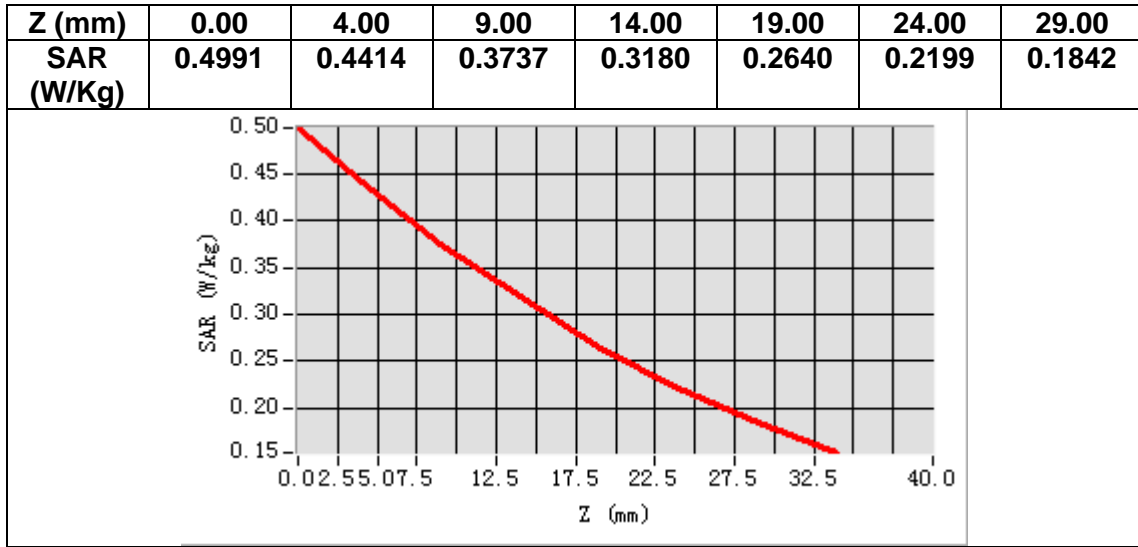

MEASUREMENT 16

A. Experimental conditions.

Area Scan	<u>dx=15mm dy=15mm, h= 5.00 mm</u>
ZoomScan	<u>5x5x7,dx=8mm dy=8mm dz=5mm</u>
Phantom	<u>Validation plane</u>
Device Position	<u>Body</u>
Band	<u>LTE band 5</u>
Channels	<u>Middle</u>
Signal	<u>LTE (Crest factor: 1.0)</u>

B. SAR Measurement Results

Frequency (MHz)	836.500000
Relative permittivity (real part)	54.833500
Relative permittivity (imaginary part)	21.556999
Conductivity (S/m)	1.001802
Variation (%)	-1.210000

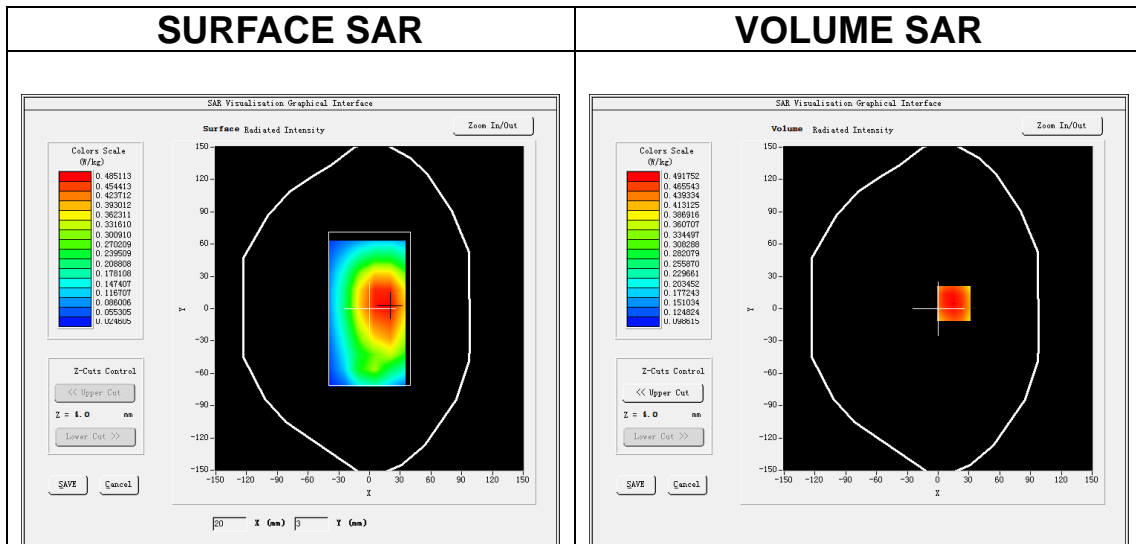

Maximum location: X=15.00, Y=5.00

SAR Peak: 0.59 W/kg

SAR 10g (W/Kg)	0.378069
SAR 1g (W/Kg)	0.491992

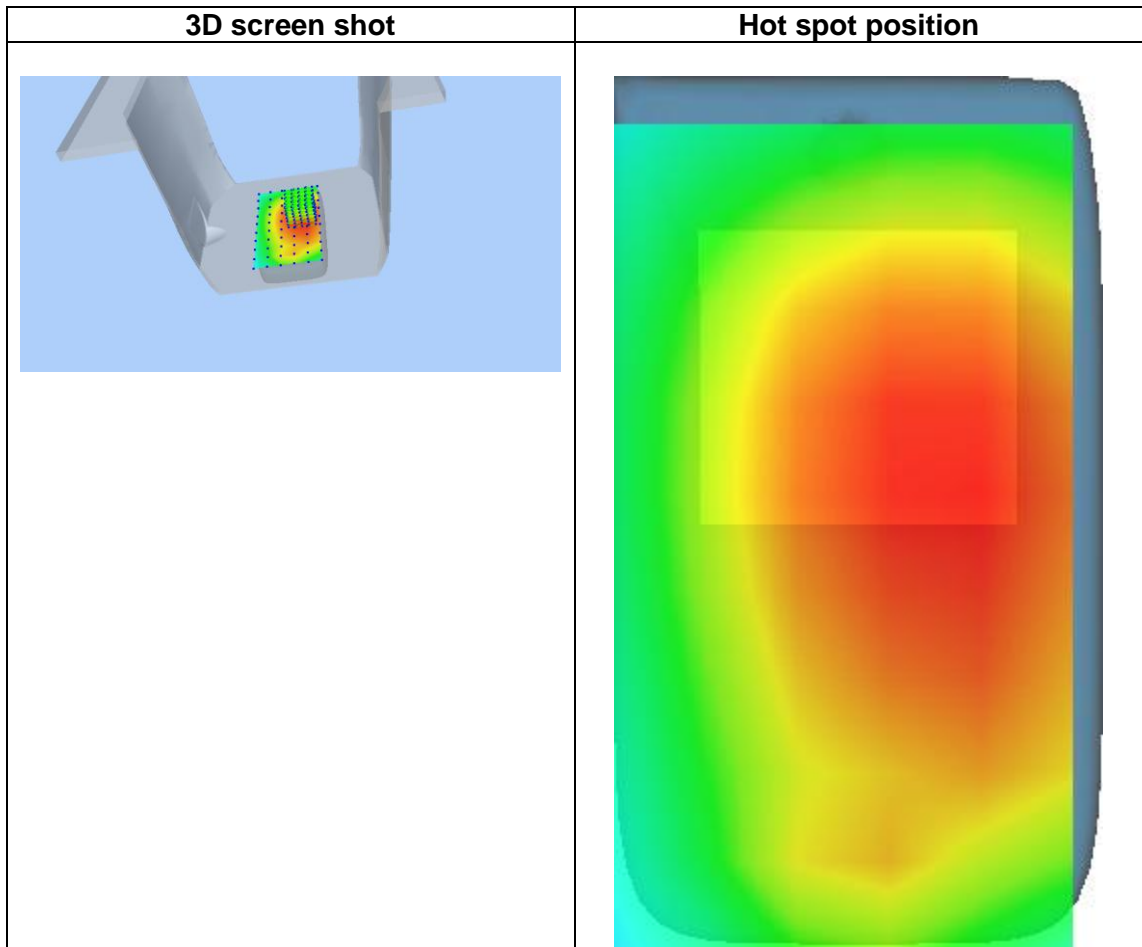
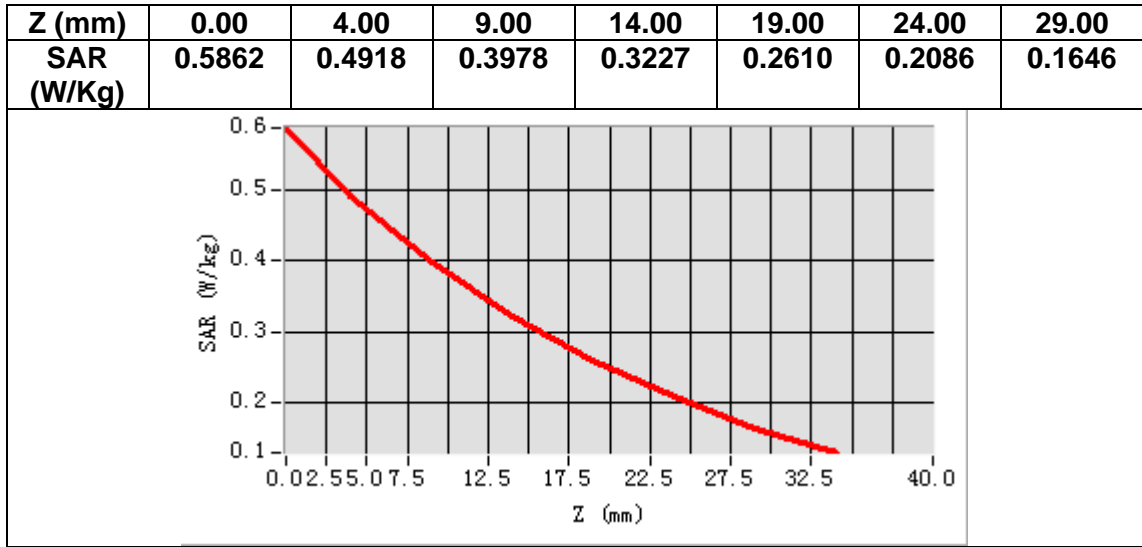

MEASUREMENT 17

A. Experimental conditions.

Area Scan	<u>dx=12mm dy=12mm, h= 5.00 mm</u>
ZoomScan	<u>7x7x7,dx=5mm dy=5mm dz=5mm</u>
Phantom	<u>Left head</u>
Device Position	<u>Cheek</u>
Band	<u>LTE band 7</u>
Channels	<u>Middle</u>
Signal	<u>LTE (Crest factor: 1.0)</u>

B. SAR Measurement Results

Frequency (MHz)	2535.000000
Relative permittivity (real part)	39.155487
Relative permittivity (imaginary part)	13.641160
Conductivity (S/m)	1.921130
Variation (%)	-0.040000

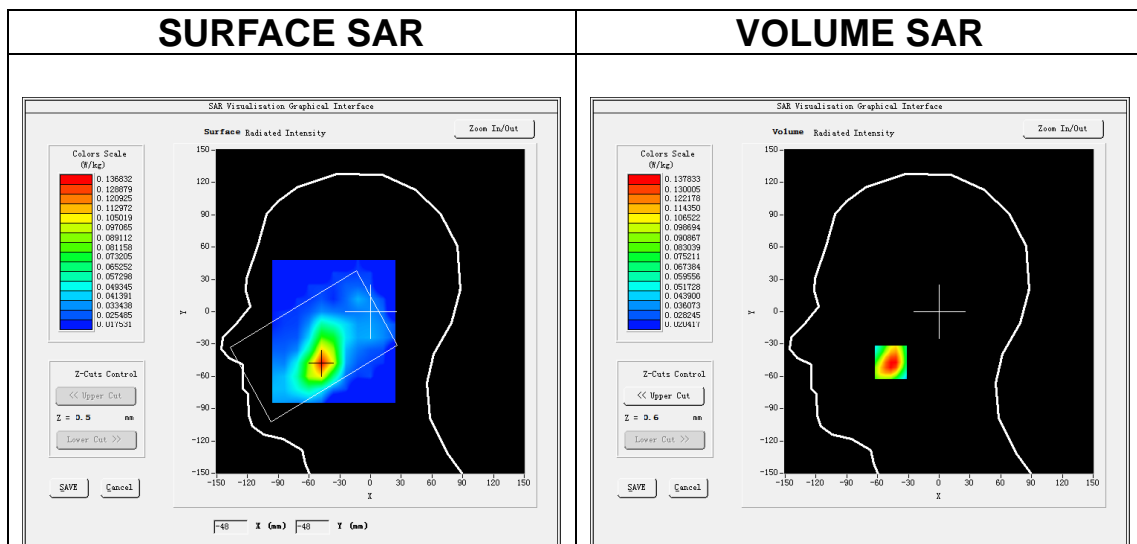

Maximum location: X=-47.00, Y=-47.00

SAR Peak: 0.19 W/kg

SAR 10g (W/Kg)	0.081768
SAR 1g (W/Kg)	0.132122

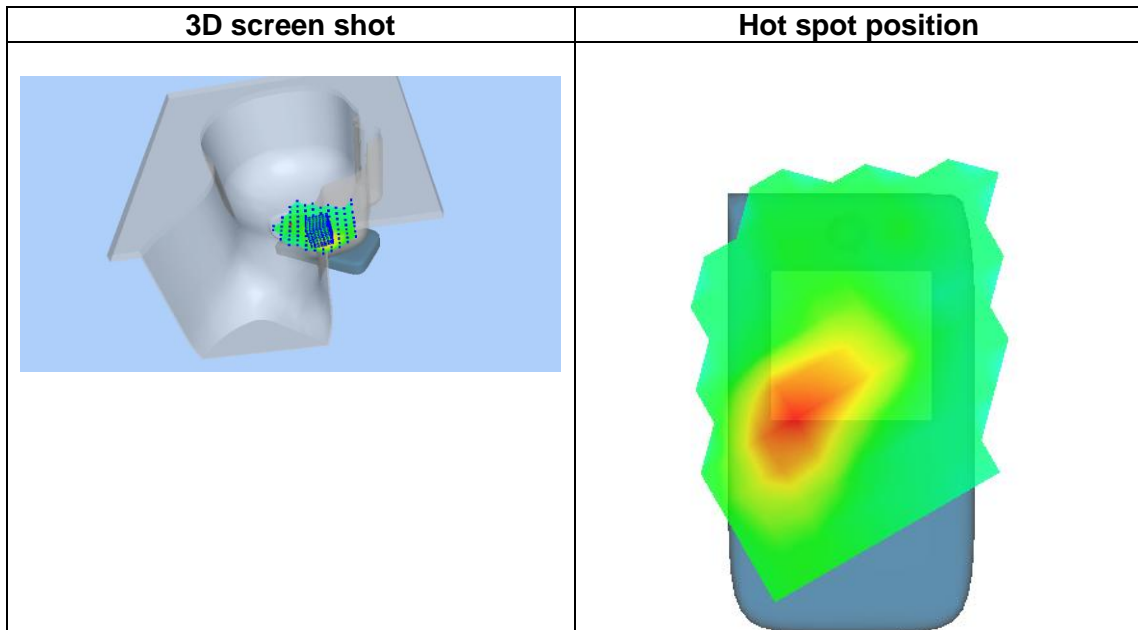
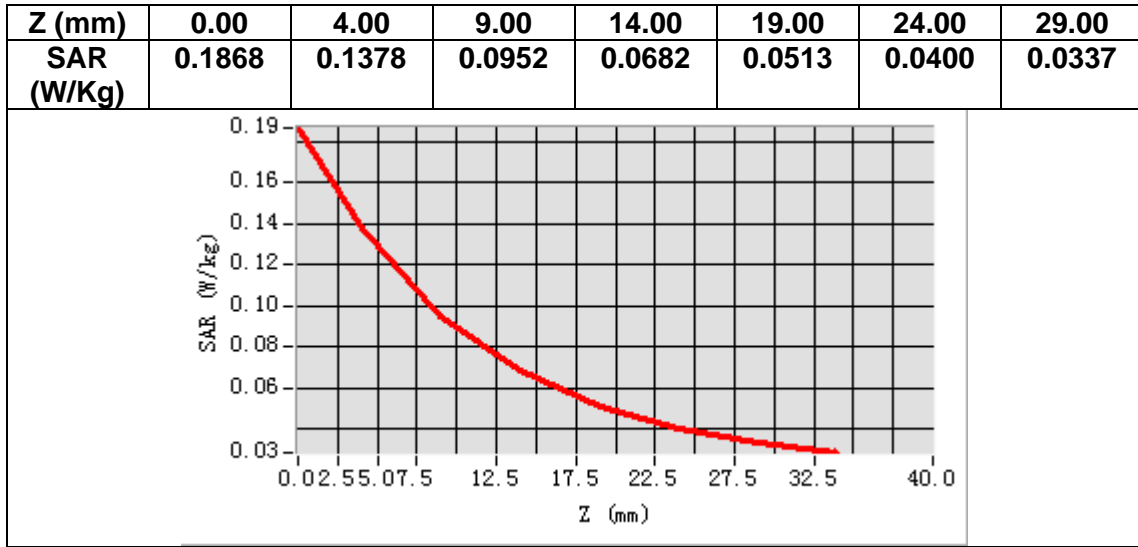

MEASUREMENT 18

A. Experimental conditions.

Area Scan	<u>dx=12mm dy=12mm, h= 5.00 mm</u>
ZoomScan	<u>7x7x7,dx=5mm dy=5mm dz=5mm</u>
Phantom	<u>Validation plane</u>
Device Position	<u>Body</u>
Band	<u>LTE band 7</u>
Channels	<u>Middle</u>
Signal	<u>LTE (Crest factor: 1.0)</u>

B. SAR Measurement Results

Frequency (MHz)	2535.000000
Relative permittivity (real part)	53.306946
Relative permittivity (imaginary part)	14.977840
Conductivity (S/m)	2.109379
Variation (%)	-0.400000

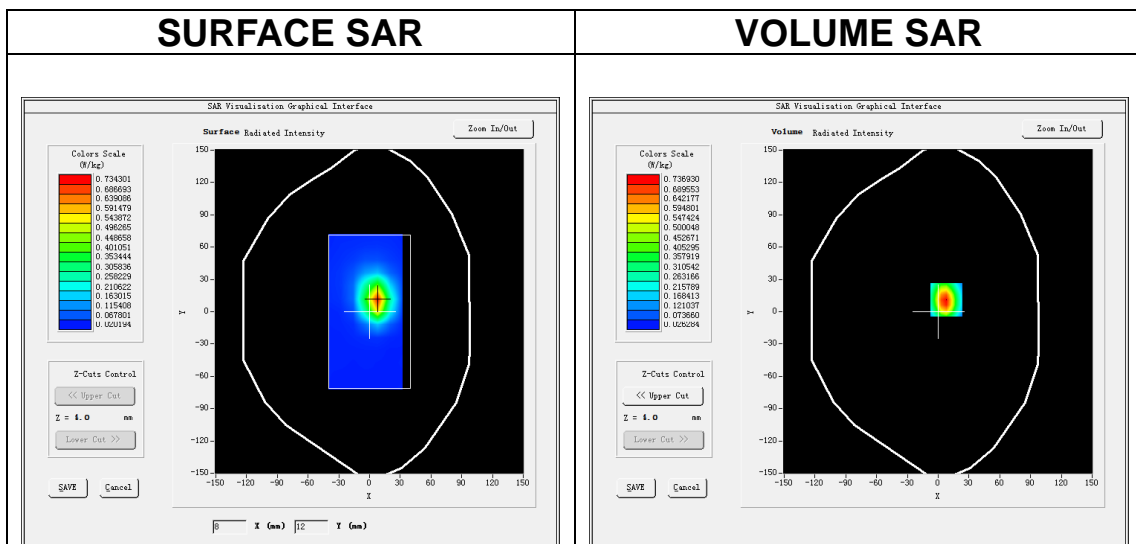

Maximum location: X=8.00, Y=11.00

SAR Peak: 1.14 W/kg

SAR 10g (W/Kg)	0.338012
SAR 1g (W/Kg)	0.671851