



# FCC REPORT

**Report Reference No.**..... : **TRE1807022901** R/C.....: 78604  
**FCC ID**..... : **QRP-SP-001**  
**Applicant's name**..... : **Azumi S.A**  
 Address.....: Avenida Aquilino de la Guardia con Calle 47, PH Ocean Plaza, Piso 16 of. 16-01, Marbella, Ciudad de Panama City, Rep. Panama  
 Manufacturer.....: AZUMI HK LTD  
 Address.....: FLAT/RM 18 BLK 1 14/F GOLDEN INDUSTRIAL BUILDING 16-26 KWAI TAK STREET KWAI CHUNG,HK  
**Test item description** ..... : **Mobile Phone**  
 Trade Mark .....: AZUMI  
 Model/Type reference.....: NOBU A55  
 Listed Model(s) .....: -  
**Standard** ..... : **FCC CFR Title 47 Part 2**  
**FCC CFR Title 47 Part 22**  
**FCC CFR Title 47 Part 24**  
 Date of receipt of test sample.....: Jul 31,2018  
 Date of testing.....: Aug 01,2018- Aug 17,2018  
 Date of issue.....: Aug 20,2018  
**Result**.....: **Pass**

Compiled by  
 ( position+printedname+signature)....: File administrators Silvia Li  
 Supervised by  
 (position+printedname+signature)....: Project Engineer Aaron Fang  
 Approved by  
 (position+printedname+signature)....: Manager Hans Hu

*Silvia Li*  

---

*Aaron.Fang*  

---

*HansHu*  

---

**Testing Laboratory Name** ..... : **Shenzhen Huatongwei International Inspection Co., Ltd.**  
 Address.....: 1/F, Bldg 3, Hongfa Hi-tech Industrial Park, Genyu Road, Tianliao, Gongming, Shenzhen, China

**Shenzhen Huatongwei International Inspection Co., Ltd. All rights reserved.**  
 This publication may be reproduced in whole or in part for non-commercial purposes as long as the Shenzhen Huatongwei International Inspection Co., Ltd. is acknowledged as copyright owner and source of the material. Shenzhen Huatongwei International Inspection Co., Ltd. takes no responsibility for and will not assume liability for damages resulting from the reader's interpretation of the reproduced material due to its placement and context.  
*The test report merely correspond to the test sample.*

## Contents

|           |   |           |
|-----------|---|-----------|
| <b>1.</b> | <b><u>TEST STANDARDS AND REPORT VERSION</u></b> | <b>3</b>  |
| 1.1.      | Applicable Standards                            | 3         |
| 1.2.      | Report version information                      | 3         |
| <b>2.</b> | <b><u>TEST DESCRIPTION</u></b>                  | <b>4</b>  |
| <b>3.</b> | <b><u>SUMMARY</u></b>                           | <b>5</b>  |
| 3.1.      | Client Information                              | 5         |
| 3.2.      | Product Description                             | 5         |
| 3.3.      | Operation state                                 | 6         |
| 3.4.      | EUT configuration                               | 6         |
| 3.5.      | Modifications                                   | 6         |
| <b>4.</b> | <b><u>TEST ENVIRONMENT</u></b>                  | <b>7</b>  |
| 4.1.      | Address of the test laboratory                  | 7         |
| 4.2.      | Test Facility                                   | 7         |
| 4.3.      | Equipments Used during the Test                 | 8         |
| 4.4.      | Environmental conditions                        | 9         |
| 4.5.      | Statement of the measurement uncertainty        | 9         |
| <b>5.</b> | <b><u>TEST CONDITIONS AND RESULTS</u></b>       | <b>10</b> |
| 5.1.      | Conducted Output Power                          | 10        |
| 5.2.      | Peak-to-Average Ratio                           | 11        |
| 5.3.      | 99% Occupied Bandwidth & 26 dB Bandwidth        | 12        |
| 5.4.      | Band Edge                                       | 13        |
| 5.5.      | Conducted Spurious Emissions                    | 14        |
| 5.6.      | Frequency stability VS Temperature measurement  | 15        |
| 5.7.      | Frequency stability VS Voltage measurement      | 16        |
| 5.8.      | ERP and EIRP                                    | 17        |
| 5.9.      | Radiated Spurious Emission                      | 20        |
| <b>6.</b> | <b><u>TEST SETUP PHOTOS</u></b>                 | <b>24</b> |
| <b>7.</b> | <b><u>EXTERNAL AND INTERNAL PHOTOS</u></b>      | <b>25</b> |
| <b>8.</b> | <b><u>APPENDIX REPORT</u></b>                   | <b>31</b> |

# **1. TEST STANDARDS AND REPORT VERSION**

## **1.1. Applicable Standards**

The tests were performed according to following standards:

[FCC Rules Part 2](#):FREQUENCY ALLOCA-TIONS AND RADIO TREATY MAT-TERS; GENERAL RULES AND REG-ULATIONS

[FCC Rules Part 22](#):PRIVATE LAND MOBILE RADIO SERVICES.

[FCC Rules Part 24](#):PUBLIC MOBILE SERVICES

[TIA/EIA 603 E March 2016](#):Land Mobile FM or PM Communications Equipment Measurement and Performance Standards.

[ANSI C63.26-2015](#): American National Standard for Compliance Testing of Transmitters Used in Licensed Radio Services

[KDB 971168 D01 Power Meas License Digital Systems v03](#): MEASUREMENT GUIDANCE FOR CERTIFICATION OF LICENSED DIGITAL TRANSMITTERS

## **1.2. Report version information**

| Revision No. | Date of issue | Description |
|--------------|---------------|-------------|
| N/A          | 2018-08-20    | Original    |
|              |               |             |
|              |               |             |
|              |               |             |
|              |               |             |

## 2. Test Description

| Test Item                                | Section in CFR 47                                  | Result | Test Engineer |
|--|--|--------|---------------|
| Conducted Output Power                   | Part 2.1046<br>Part 22.913(a)<br>Part 24.232(c)    | Pass   | Baozhu Hu     |
| Peak-to-Average Ratio                    | Part 24.232  | Pass   | Baozhu Hu     |
| 99% Occupied Bandwidth & 26 dB Bandwidth | Part 2.1049<br>Part 22.917(b)<br>Part 24.238(b)    | Pass   | Baozhu Hu     |
| Band Edge                                | Part 2.1051<br>Part 22.917<br>Part 24.238          | Pass   | Baozhu Hu     |
| Conducted Spurious Emissions             | Part 2.1051<br>Part 22.917<br>Part 24.238          | Pass   | Baozhu Hu     |
| Frequency stability VS Temperature       | Part 2.1055(a)(1)(b)<br>Part 22.355<br>Part 24.235 | Pass   | Baozhu Hu     |
| Frequency stability VS Voltage           | Part 2.1055(d)(1)(2)<br>Part 22.355<br>Part 24.235 | Pass   | Baozhu Hu     |
| ERP and EIRP                             | Part 22.913(a)<br>Part 24.232(b)                   | Pass   | Jiuru Pan     |
| Radiated Spurious Emissions              | Part 2.1053<br>Part 22.917<br>Part 24.238          | Pass   | Jiuru Pan     |

Note: The measurement uncertainty is not included in the test result.

### 3. SUMMARY

#### 3.1. Client Information

|               |  |
|---------------|--|
| Applicant:    | Azumi S.A  |
| Address:      | Avenida Aquilino de la Guardia con Calle 47, PH Ocean Plaza, Piso 16 of. 16-01, Marbella, Ciudad de Panama City, Rep. Panama |
| Manufacturer: | AZUMI HK LTD   |
| Address:      | FLAT/RM 18 BLK 1 14/F GOLDEN INDUSTRIAL BUILDING 16-26 KWAI TAK STREET KWAI CHUNG,HK   |

#### 3.2. Product Description

|                      |  |
|----------------------|--|
| Name of EUT:         | Mobile Phone   |
| Trade Mark:          | AZUMI  |
| Model No.:           | NOBU A55   |
| Listed Model(s):     | -  |
| IMEI Code:           | Conducted: 358650655020444<br>Radiated: 358650655020345        |
| SIM Information:     | Support One SIM Card   |
| Hardware version:    | W48A_V1.0K   |
| Software version:    | AZUMI_NOBU_A55_SW_V01  |
| Power supply:        | DC 3.8V  |
| Adapter information: | Input: 100-240Va.c., 50/60Hz, 0.2A<br>Output: 5.0Vd.c., 1000mA |
| <b>2G:</b>           |  |
| Support Network:     | GSM, GPRS  |
| Support Band:        | GSM850, PCS1900  |
| Modulation:          | GSM/GPRS: GMSK   |
| Transmit Frequency:  | GSM850: 824.20MHz-848.80MHz<br>PCS1900: 1850.20MHz-1909.80MHz  |
| Receive Frequency:   | GSM850: 869.20MHz-893.80MHz<br>PCS1900: 1930.20MHz-1989.80MHz  |
| GPRS Class:          | 12   |
| EGPRS Class:         | -  |
| Antenna type:        | Monopole Antenna   |
| Antenna gain:        | GSM850: -2.86dBi<br>PCS1900: -2.86dBi                          |

### 3.3. Operation state

➤ **Test frequency list**

| GSM850  |                 | PCS1900 |                 |
|---------|-----------------|---------|-----------------|
| Channel | Frequency (MHz) | Channel | Frequency (MHz) |
| 128     | 824.20          | 512     | 1850.20         |
| 190     | 836.60          | 661     | 1880.00         |
| 251     | 848.80          | 810     | 1909.80         |

➤ **Test mode**

Antenna port conducted and radiated test items were performed according to KDB 971168 D01 Power Meas. License Digital Systems v03 and ANSI C63.26-2015 with maximum output power.

Radiated measurements were performed with rotating EUT in different three orthogonal test planes to find the maximum emission.

Radiated emissions were investigated as following frequency range:  
30 MHz to 10th harmonic for GSM850, PCS1900.

All modes and data rates and positions were investigated.

Test modes are chosen to be reported as the worst case configuration below:

| Test modes |   |   |
|------------|---|---|
| Band       | Radiated  | Conducted   |
| GSM 850    | <ul style="list-style-type: none"> <li>■ GSM link</li> <li>■ GPRS Class 8 link</li> </ul> | <ul style="list-style-type: none"> <li>■ GSM link</li> <li>■ GPRS Class 8 link</li> </ul> |
| PCS 1900   | <ul style="list-style-type: none"> <li>■ GSM link</li> <li>■ GPRS Class 8 link</li> </ul> | <ul style="list-style-type: none"> <li>■ GSM link</li> <li>■ GPRS Class 8 link</li> </ul> |

### 3.4. EUT configuration

The following peripheral devices and interface cables were connected during the measurement:

- - supplied by the manufacturer
- - supplied by the lab

|     |               |   |
|-----|---------------|---|
| ○ / | Manufacturer: | / |
|     | Model No.:    | / |
| ○ / | Manufacturer: | / |
|     | Model No.:    | / |

### 3.5. Modifications

No modifications were implemented to meet testing criteria.

## **4. TEST ENVIRONMENT**

### **4.1. Address of the test laboratory**

Laboratory: Shenzhen Huatongwei International Inspection Co., Ltd.

Address: 1/F, Bldg 3, Hongfa Hi-tech Industrial Park, Genyu Road, Tianliao, Gongming, Shenzhen, China

### **4.2. Test Facility**

#### **CNAS-Lab Code: L1225**

Shenzhen Huatongwei International Inspection Co., Ltd. has been assessed and proved to be in compliance with CNAS-CL01 Accreditation Criteria for Testing and Calibration Laboratories (identical to ISO/IEC17025: 2005 General Requirements) for the Competence of Testing and Calibration Laboratories.

#### **A2LA-Lab Cert. No.: 3902.01**

Shenzhen Huatongwei International Inspection Co., Ltd. EMC Laboratory has been accredited by A2LA for technical competence in the field of electrical testing, and proved to be in compliance with ISO/IEC 17025: 2005 General Requirements for the Competence of Testing and Calibration Laboratories and any additional program requirements in the identified field of testing.

#### **FCC-Registration No.: 762235**

Shenzhen Huatongwei International Inspection Co., Ltd. EMC Laboratory has been registered and fully described in a report filed with the FCC (Federal Communications Commission). The acceptance letter from the FCC is maintained in our files.

#### **IC-Registration No.:5377B-1**

Two 3m Alternate Test Site of Shenzhen Huatongwei International Inspection Co., Ltd. has been registered by Certification and Engineering Bureau of Industry Canada for the performance of radiated measurements with Registration No.: 5377B-1.

#### **ACA**

Shenzhen Huatongwei International Inspection Co., Ltd. EMC Laboratory can also perform testing for the Australian C-Tick mark as a result of our A2LA accreditation.

### 4.3. Equipments Used during the Test

| RF Conducted Test |                                 |               |           |            |                      |                      |
|-------------------|---------------------------------|---------------|-----------|------------|----------------------|----------------------|
| Item              | Equipment                       | Manufacturer  | Model No. | Serial No. | Last Cal. (mm-dd-yy) | Next Cal. (mm-dd-yy) |
| 1                 | Universal Radio Communication   | Rohde&Schwarz | CMU200    | 112012     | 11/11/2017           | 11/11/2018           |
| 2                 | Wide Radio communication tester | Rohde&Schwarz | CMW500    | 137688     | 10/26/2017           | 10/25/2018           |
| 3                 | Spectrum Analyzer               | Rohde&Schwarz | FSW26     | 103440     | 11/11/2017           | 11/10/2018           |
| 4                 | MXA Signal Analyzer             | Agilent       | N9020A    | MY5050187  | 11/10/2017           | 11/09/2018           |
| 5                 | Splitter                        | Mini-Circuit  | ZAPD-4    | 400059     | 03/19/2018           | 03/18/2019           |
| 6                 | Climate Chamber                 | ESPEC         | EL-10KA   | 05107008   | 11/10/2017           | 11/09/2018           |

| Radiated Emissions |                                 |                              |           |            |                      |                      |
|--------------------|---------------------------------|------------------------------|-----------|------------|----------------------|----------------------|
| Item               | Equipment                       | Manufacturer                 | Model No. | Serial No. | Last Cal. (mm-dd-yy) | Next Cal. (mm-dd-yy) |
| 1                  | EMI Test Receiver               | R&S                          | ESCI      | 101247     | 11/11/2017           | 11/10/2018           |
| 2                  | Loop Antenna                    | R&S                          | HFH2-Z2   | 100020     | 11/20/2017           | 11/19/2018           |
| 3                  | Ultra-Broadband Antenna         | SCHWARZBECK                  | VULB9163  | 538        | 04/05/2017           | 04/04/2020           |
| 4                  | Preamplifier                    | SCHWARZBECK                  | BBV 9743  | 9743-0022  | 10/18/2017           | 10/17/2018           |
| 5                  | RF Connection Cable             | HUBER+SUHNER                 | RE-7-FL   | N/A        | 11/21/2017           | 11/20/2018           |
| 6                  | EMI Test Software               | R&S                          | ESK1      | N/A        | N/A                  | N/A                  |
| 7                  | Spectrum Analyzer               | R&S                          | FSP40     | 100597     | 11/11/2017           | 11/10/2018           |
| 8                  | Horn Antenna                    | SCHWARZBECK                  | 9120D     | 1011       | 03/27/2017           | 03/26/2020           |
| 9                  | Horn Antenna                    | SCHWARZBECK                  | BBHA9170  | 25841      | 03/27/2017           | 03/26/2020           |
| 10                 | Broadband Preamplifier          | SCHWARZBECK                  | BBV 9718  | 9718-248   | 10/18/2017           | 10/17/2018           |
| 11                 | High pass filter                | Compliance Direction systems | BSU-6     | 34202      | 11/11/2017           | 11/10/2018           |
| 12                 | RF Connection Cable             | HUBER+SUHNER                 | RE-7-FH   | N/A        | 11/21/2017           | 11/20/2018           |
| 13                 | Signal Generator                | Rohde&Schwarz                | SMB100A   | 114360     | 06/12/2018           | 06/11/2019           |
| 14                 | Universal Radio Communication   | Rohde&Schwarz                | CMU200    | 112012     | 11/11/2017           | 11/11/2018           |
| 15                 | Wide Radio communication tester | Rohde&Schwarz                | CMW500    | 137688     | 10/26/2017           | 10/25/2018           |
| 16                 | EMI Test Software               | Audix                        | E3        | N/A        | N/A                  | N/A                  |
| 17                 | Turntable                       | MATURO                       | TT2.0     | N/A        | N/A                  | N/A                  |
| 18                 | Antenna Mast                    | MATURO                       | TAM-4.0-P | N/A        | N/A                  | N/A                  |



#### 4.4. Environmental conditions

During the measurement the environmental conditions were within the listed ranges:

|              |                       |                               |
|--------------|-----------------------|-------------------------------|
| Voltage      | VN=Nominal Voltage    | DC 3.80V                      |
|              | VL=Lower Voltage      | DC 3.60V                      |
|              | VH=Higher Voltage     | DC 4.20V                      |
| Temperature  | TN=Normal Temperature | 25 °C                         |
|              | Extreme Temperature   | From -30° to + 50° centigrade |
| Humidity     | 30~60 %               |                               |
| Air Pressure | 950-1050 hPa          |                               |

#### 4.5. Statement of the measurement uncertainty

The data and results referenced in this document are true and accurate. The reader is cautioned that there may be errors within the calibration limits of the equipment and facilities. The measurement uncertainty was calculated for all measurements listed in this test report acc. to TR-100028-01 "Electromagnetic compatibility and Radio spectrum Matters (ERM); Uncertainties in the measurement of mobile radio equipment characteristics; Part 1" and TR-100028-02 "Electromagnetic compatibility and Radio spectrum Matters (ERM); Uncertainties in the measurement of mobile radio equipment characteristics; Part 2" and is documented in the Shenzhen Huatongwei International Inspection Co., Ltd quality system acc. to DIN EN ISO/IEC 17025. Furthermore, component and process variability of devices similar to that tested may result in additional deviation. The manufacturer has the sole responsibility of continued compliance of the device.

Hereafter the best measurement capability for Shenzhen Huatongwei laboratory is reported:

| Test Items                                 | Measurement Uncertainty | Notes |
|--|-------------------------|-------|
| Frequency stability                        | 25 Hz                   | (1)   |
| Transmitter power conducted                | 0.57 dB                 | (1)   |
| Transmitter power Radiated                 | 2.20 dB                 | (1)   |
| Conducted spurious emission 9KHz-12.75 GHz | 1.60 dB                 | (1)   |
| Conducted Emission 9KHz-30MHz              | 3.39 dB                 | (1)   |
| Radiated Emission 30~1000MHz               | 4.24 dB                 | (1)   |
| Radiated Emission 1~18GHz                  | 5.16 dB                 | (1)   |
| Radiated Emission 18-40GHz                 | 5.54 dB                 | (1)   |
| Occupied Bandwidth                         | -----                   | (1)   |

(1) This uncertainty represents an expanded uncertainty expressed at approximately the 95% confidence level using a coverage factor of  $k=1.96$ .

## **5. TEST CONDITIONS AND RESULTS**

### **5.1. Conducted Output Power**

**LIMIT**

N/A

**TEST CONFIGURATION****TEST PROCEDURE**

1. The EUT output port was connected to communication tester.
2. Set EUT at maximum power through communication tester.
3. Select lowest, middle, and highest channels for each band and different modulation.
4. Measure the maximum burst average power.

**TEST MODE:**

Please refer to the clause 3.3

**TEST RESULTS** **Passed**       **Not Applicable**

Refer to appendix A on the section 8 appendix report

## 5.2. Peak-to-Average Ratio

### LIMIT

13dB

### TEST CONFIGURATION



### TEST PROCEDURE

1. The EUT was connected to the spectrum analyzer and communication tester via a power splitter
2. Set EUT in maximum power output.
3. Center Frequency = Carrier frequency, RBW > Emission bandwidth of signal
4. The signal analyzer was set to collect one million samples to generate the CCDF curve
5. The measurement interval was set depending on the type of signal analyzed.
  - i. For continuous signals (>98% duty cycle), the measurement interval was set to 1ms.
  - ii. For burst transmissions, the spectrum analyzer is set to use an internal "RF Burst" trigger that is synced with an incoming pulse and the measurement interval is set to less than the duration of the "on time" of one burst to ensure that energy is only captured during a time in which the transmitter is operating at maximum power
6. Record the maximum PAPR level associated with a probability of 0.1%.

### TEST MODE:

Please refer to the clause 3.3

### TEST RESULTS

Passed       Not Applicable

Refer to appendix B on the section 8 appendix report

### 5.3. 99% Occupied Bandwidth & 26 dB Bandwidth

**LIMIT**

N/A

**TEST CONFIGURATION****TEST PROCEDURE**

1. The EUT was connected to the spectrum analyzer and communication tester via a power splitter
2. Set EUT in maximum power output.
3. Spectrum analyzer setting as follow:  
Center Frequency= Carrier frequency, RBW=1% to 5% of anticipated OBW, VBW= 3 \* RBW,  
Detector=Peak,  
Trace maximum hold.
4. Record the value of 99% Occupied bandwidth and -26dB bandwidth.

**TEST MODE:**

Please refer to the clause 3.3

**TEST RESULTS** **Passed**       **Not Applicable**

Refer to appendix C on the section 8 appendix report

## 5.4. Band Edge

### LIMIT

Part 24.238 and Part 22.917 specify that the power of any emission outside of the authorized operating frequency ranges must be attenuated below the transmitting power (P) by a factor of at least  $43 + 10 \log(P)$  dB.

The specification that emissions shall be attenuated below the transmitter power (P) by at least  $43 + 10 \log(P)$  dB, translates in the relevant power range (1 to 0.001 W) to -13 dBm. At 1 W the specified minimum attenuation becomes 43 dB and relative to a 30 dBm (1 W) carrier becomes a limit of -13 dBm. At 0.001 W (0 dBm) the minimum attenuation is 13 dB, which again yields a limit of -13 dBm. In this way a translation of the specification from relative to absolute terms is carried out.

### TEST CONFIGURATION

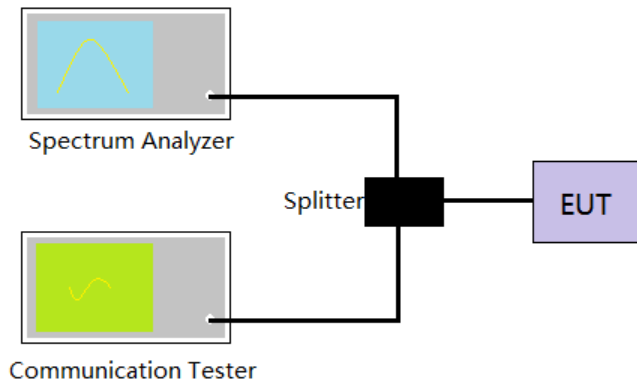

### TEST PROCEDURE

1. The EUT was connected to the spectrum analyzer and communication tester via a power splitter
2. Set EUT in maximum power output.
3. The band edges of low and high channels were measured.
4. Spectrum analyzer setting as follow:  
RBW=3KHz, VBW = 10KHz, Sweep time= Auto
5. Record the test plot.

### TEST MODE:

Please refer to the clause 3.3

### TEST RESULTS

Passed       Not Applicable

Refer to appendix D on the section 8 appendix report

## 5.5. Conducted Spurious Emissions

### LIMIT

Part 24.238 and Part 22.917 specify that the power of any emission outside of the authorized operating frequency ranges must be attenuated below the transmitting power (P) by a factor of at least  $43 + 10 \log(P)$  dB.

The specification that emissions shall be attenuated below the transmitter power (P) by at least  $43 + 10 \log(P)$  dB, translates in the relevant power range (1 to 0.001 W) to -13 dBm. At 1 W the specified minimum attenuation becomes 43 dB and relative to a 30 dBm (1 W) carrier becomes a limit of -13 dBm. At 0.001 W (0 dBm) the minimum attenuation is 13 dB, which again yields a limit of -13 dBm. In this way a translation of the specification from relative to absolute terms is carried out.

### TEST CONFIGURATION



### TEST PROCEDURE

1. The EUT was connected to the spectrum analyzer and communication tester via a power splitter
2. Set EUT in maximum power output.
3. Spectrum analyzer setting as follow:  
Below 1GHz, RBW=100KHz, VBW = 300KHz, Detector=Peak, Sweep time= Auto  
Above 1GHz, RBW=1MHz, VBW=3MHz, Detector=Peak, Sweep time= Auto  
Scan frequency range up to 10<sup>th</sup> harmonic.
4. Record the test plot.

### TEST MODE:

Please refer to the clause 3.3

### TEST RESULTS

Passed       Not Applicable

Refer to appendix E on the section 8 appendix report

## 5.6. Frequency stability VS Temperature measurement

### LIMIT

2.5ppm

### TEST CONFIGURATION



### TEST PROCEDURE

1. The equipment under test was connected to an external DC power supply and input rated voltage.
2. The EUT output port was connected to communication tester.
3. The EUT was placed inside the temperature chamber.
4. Turn EUT off and set the chamber temperature to  $-30^{\circ}\text{C}$ . After the temperature stabilized for approximately 30 minutes recorded the frequency.
5. Repeat step 4 measure with  $10^{\circ}\text{C}$  increased per stage until the highest temperature of  $+50^{\circ}\text{C}$  reached.

### TEST MODE:

Please refer to the clause 3.3

### TEST RESULTS

Passed       Not Applicable

Refer to appendix F on the section 8 appendix report

## 5.7. Frequency stability VS Voltage measurement

### LIMIT

2.5ppm

### TEST CONFIGURATION



### TEST PROCEDURE

1. The equipment under test was connected to an external DC power supply and input rated voltage.
2. The EUT output port was connected to communication tester.
3. The EUT was placed inside the temperature chamber at 25°C
4. The power supply voltage to the EUT was varied  $\pm 15\%$  of the nominal value measured at the input to the EUT
5. Record the maximum frequency change.

### TEST MODE:

Please refer to the clause 3.3

### TEST RESULTS

Passed       Not Applicable

Refer to appendix F on the section 8 appendix report



## 5.8. ERP and EIRP

### LIMIT

GSM850: 7W (38.45dBm) ERP

PCS1900: 2W (33dBm) EIRP

### TEST CONFIGURATION

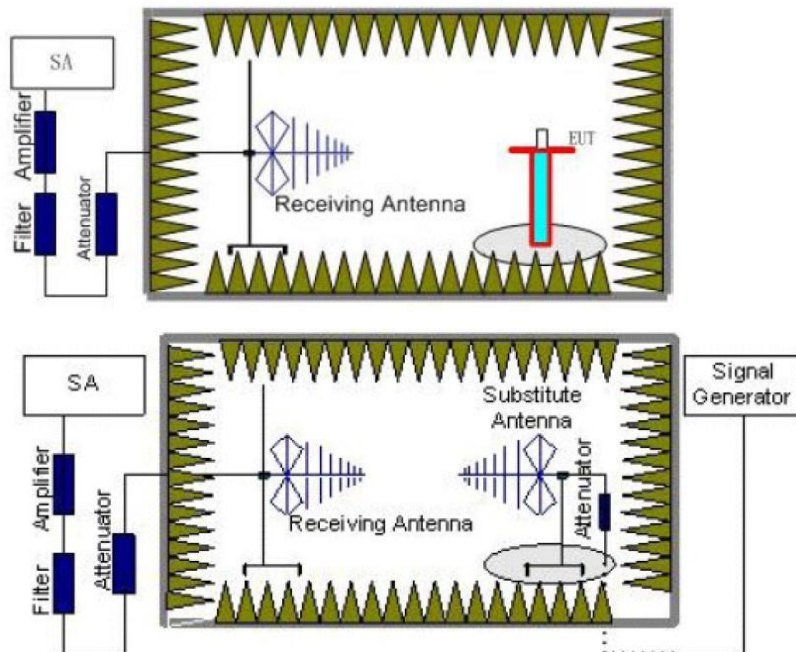

### TEST PROCEDURE

1. EUT was placed on a 0.8 meter for below 1GHz and 1.5 meter for above 1GHz high non-conductive stand at a 3 meter test distance from the receive antenna. A receiving antenna was placed on the antenna mast 3 meters from the EUT for emission measurements. The height of receiving antenna is 1.0m. Detected emissions were maximized at each frequency by rotating the EUT through 360° and adjusting the receiving antenna polarization. The radiated emission measurements of all transmit frequencies in three channels (High, Middle, Low) were measured with peak detector.
2. A log-periodic antenna or double-ridged waveguide horn antenna shall be substituted in place of the EUT. The log-periodic antenna will be driven by a signal generator and the level will be adjusted till the same power value on the spectrum analyzer or receiver. The level of the spurious emissions can be calculated through the level of the signal generator, cable loss, the gain of the substitution antenna and the reading of the spectrum analyzer or receiver.
3. The EUT is then put into continuously transmitting mode at its maximum power level during the test. Set Test Receiver or Spectrum RBW=1MHz, VBW=3MHz for above 1GHz and RBW=100kHz, VBW=300kHz for 30MHz to 1GHz, and the maximum value of the receiver should be recorded as (Pr).
4. The EUT shall be replaced by a substitution antenna. In the chamber, an substitution antenna for the frequency band of interest is placed at the reference point of the chamber. An RF Signal source for the frequency band of interest is connected to the substitution antenna with a cable that has been constructed to not interfere with the radiation pattern of the antenna. A power (PMea) is applied to the input of the substitution antenna, and adjust the level of the signal generator output until the value of the receiver reach the previously recorded (Pr). The power of signal source (PMea) is recorded. The test should be performed by rotating the test item and adjusting the receiving antenna polarization.
5. A amplifier should be connected to the Signal Source output port. And the cable should be connect between the Amplifier and the Substitution Antenna. The cable loss (Pcl), the Substitution Antenna Gain (G<sub>a</sub>) and the Amplifier Gain (P<sub>Ag</sub>) should be recorded after test.

6. The measurement results are obtained as described below:

Power(EIRP)=PMea- PAg - Pcl + Ga

We used SMF100A micowave signal generator which signal level can up to 33dBm,so we not used power Amplifier for substitution test; The measurement results are amend as described below:

Power(EIRP)=PMea- Pcl + Ga

7. This value is EIRP since the measurement is calibrated using an antenna of known gain (2.15 dBi) and known input power.

ERP can be calculated from EIRP by subtracting the gain of the dipole, ERP = EIRP-2.15dBi.

### **TEST MODE:**

Please refer to the clause 3.3

### **TEST RESULTS**

**Passed**       **Not Applicable**

| Mode    | Channel | Antenna Pol. | ERP   | Limit (dBm) | Result |
|---------|---------|--------------|-------|-------------|--------|
| GSM850  | 128     | V            | 32.83 | <38.45      | Pass   |
|         |         | H            | 25.65 |             |        |
|         | 190     | V            | 31.49 |             |        |
|         |         | H            | 25.03 |             |        |
|         | 251     | V            | 32.59 |             |        |
|         |         | H            | 23.53 |             |        |
| GPRS850 | 128     | V            | 32.74 | <38.45      | Pass   |
|         |         | H            | 25.50 |             |        |
|         | 190     | V            | 31.54 |             |        |
|         |         | H            | 25.12 |             |        |
|         | 251     | V            | 32.46 |             |        |
|         |         | H            | 23.50 |             |        |

| Mode     | Channel | Antenna Pol. | EIRP  | Limit (dBm) | Result |
|----------|---------|--------------|-------|-------------|--------|
| PCS1900  | 512     | V            | 26.91 | <33.00      | Pass   |
|          |         | H            | 30.42 |             |        |
|          | 661     | V            | 27.64 |             |        |
|          |         | H            | 30.52 |             |        |
|          | 810     | V            | 28.04 |             |        |
|          |         | H            | 30.18 |             |        |
| GPRS1900 | 512     | V            | 26.85 | <33.00      | Pass   |
|          |         | H            | 30.37 |             |        |
|          | 661     | V            | 27.71 |             |        |
|          |         | H            | 30.63 |             |        |
|          | 810     | V            | 28.10 |             |        |
|          |         | H            | 30.24 |             |        |

## 5.9. Radiated Spurious Emission

### LIMIT

-13dBm

### TEST CONFIGURATION

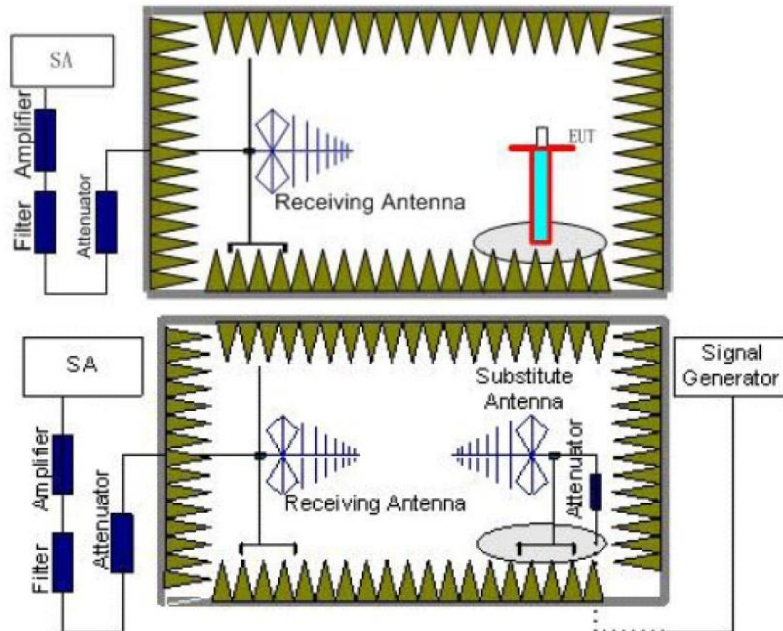

### TEST RESULTS

1. EUT was placed on a 0.8 meter for below 1GHz and 1.5 meter for above 1GHz high non-conductive stand at a 3 meter test distance from the receive antenna. A receiving antenna was placed on the antenna mast 3 meters from the EUT for emission measurements. The height of receiving antenna is 1.0m. Detected emissions were maximized at each frequency by rotating the EUT through 360° and adjusting the receiving antenna polarization. The radiated emission measurements of all transmit frequencies in three channels (High, Middle, Low) were measured with peak detector.
2. A log-periodic antenna or double-ridged waveguide horn antenna shall be substituted in place of the EUT. The log-periodic antenna will be driven by a signal generator and the level will be adjusted till the same power value on the spectrum analyzer or receiver. The level of the spurious emissions can be calculated through the level of the signal generator, cable loss, the gain of the substitution antenna and the reading of the spectrum analyzer or receiver.
3. The EUT is then put into continuously transmitting mode at its maximum power level during the test. Set Test Receiver or Spectrum RBW=1MHz, VBW=3MHz for above 1GHz and RBW=100kHz, VBW=300kHz for 30MHz to 1GHz, And the maximum value of the receiver should be recorded as (Pr).
4. The EUT shall be replaced by a substitution antenna. In the chamber, an substitution antenna for the frequency band of interest is placed at the reference point of the chamber. An RF Signal source for the frequency band of interest is connected to the substitution antenna with a cable that has been constructed to not interfere with the radiation pattern of the antenna. A power (PMea) is applied to the input of the substitution antenna, and adjust the level of the signal generator output until the value of the receiver reach the previously recorded (Pr). The power of signal source (PMea) is recorded. The test should be performed by rotating the test item and adjusting the receiving antenna polarization.
5. A amplifier should be connected to the Signal Source output port. And the cable should be connect between the Amplifier and the Substitution Antenna. The cable loss (Pcl), the Substitution Antenna Gain (Ga) and the Amplifier Gain (PAg) should be recorded after test.

6. The measurement results are obtained as described below:  
Power(EIRP)=PMea- PAg - Pcl + Ga  
We used SMF100A micowave signal generator which signal level can up to 33dBm,so we not used power Amplifier for substitution test; The measurement results are amend as described below:  
Power(EIRP)=PMea- Pcl + Ga
7. This value is EIRP since the measurement is calibrated using an antenna of known gain (2.15 dBi) and known input power.  
ERP can be calculated from EIRP by subtracting the gain of the dipole, ERP = EIRP-2.15dBi.

**TEST MODE:**

Please refer to the clause 3.3

**TEST RESULTS**

**Passed**       **Not Applicable**

Note: Worst case at GSM850/PCS1900

| GSM850  |                 |                   |             |             |        |
|---------|-----------------|-------------------|-------------|-------------|--------|
| Channel | Frequency (MHz) | Spurious Emission |             | Limit (dBm) | Result |
|         |                 | Polarization      | Level (dBm) |             |        |
| 128     | 85.85           | Vertical          | -61.64      | <-13.00     | Pass   |
|         | 319.84          | V                 | -54.73      |             |        |
|         | 1648.51         | V                 | -36.62      |             |        |
|         | 2472.57         | V                 | -40.17      |             |        |
|         | 3295.11         | V                 | -49.20      |             |        |
|         | 5767.51         | V                 | -46.98      |             |        |
|         | 319.84          | Horizontal        | -57.59      | <-13.00     | Pass   |
|         | 600.20          | H                 | -57.41      |             |        |
|         | 1648.51         | H                 | -34.54      |             |        |
|         | 2472.57         | H                 | -37.44      |             |        |
|         | 5767.51         | H                 | -49.26      |             |        |
|         | 8240.03         | H                 | -43.03      |             |        |
| 190     | 319.84          | Vertical          | -55.72      | <-13.00     | Pass   |
|         | 600.20          | V                 | -54.91      |             |        |
|         | 1672.22         | V                 | -37.94      |             |        |
|         | 2510.89         | V                 | -42.03      |             |        |
|         | 3343.25         | V                 | -46.89      |             |        |
|         | 4179.88         | V                 | -48.40      |             |        |
|         | 130.01          | Horizontal        | -59.88      | <-13.00     | Pass   |
|         | 469.24          | H                 | -60.45      |             |        |
|         | 1674.06         | H                 | -35.52      |             |        |
|         | 2510.89         | H                 | -39.28      |             |        |
|         | 3343.25         | H                 | -51.62      |             |        |
|         | 4179.88         | H                 | -52.45      |             |        |
| 251     | 85.85           | Vertical          | -62.23      | <-13.00     | Pass   |
|         | 319.84          | V                 | -55.03      |             |        |
|         | 1698.14         | V                 | -39.89      |             |        |
|         | 2547.01         | V                 | -39.22      |             |        |
|         | 3392.09         | V                 | -45.15      |             |        |
|         | 5091.22         | V                 | -44.39      |             |        |
|         | 319.84          | Horizontal        | -57.28      | <-13.00     | Pass   |
|         | 600.20          | H                 | -57.37      |             |        |
|         | 1698.14         | H                 | -39.96      |             |        |
|         | 2547.01         | H                 | -37.92      |             |        |
|         | 3392.09         | H                 | -50.11      |             |        |
|         | 5091.22         | H                 | -49.87      |             |        |

## Remark:

1. The emission behaviour belongs to narrowband spurious emission.
2. The emission levels of not record in the report are very lower than the limit and not show in test report.

| PCS1900 |                 |                   |             |             |        |
|---------|-----------------|-------------------|-------------|-------------|--------|
| Channel | Frequency (MHz) | Spurious Emission |             | Limit (dBm) | Result |
|         |                 | Polarization      | Level (dBm) |             |        |
| 512     | 200.36          | Vertical          | -61.74      | <-13.00     | Pass   |
|         | 312.06          | V                 | -57.23      |             |        |
|         | 1259.49         | V                 | -52.26      |             |        |
|         | 2595.02         | V                 | -46.79      |             |        |
|         | 3700.48         | V                 | -47.56      |             |        |
|         | 5554.08         | V                 | -41.25      |             |        |
|         | 312.06          | Horizontal        | -52.88      | <-13.00     | Pass   |
|         | 390.82          | H                 | -54.19      |             |        |
|         | 1258.11         | H                 | -50.12      |             |        |
|         | 1575.90         | H                 | -48.66      |             |        |
|         | 3700.48         | H                 | -44.36      |             |        |
|         | 5554.08         | H                 | -43.99      |             |        |
| 661     | 312.06          | Vertical          | -53.83      | <-13.00     | Pass   |
|         | 598.09          | V                 | -53.80      |             |        |
|         | 1448.07         | V                 | -49.65      |             |        |
|         | 2055.85         | V                 | -48.32      |             |        |
|         | 3759.98         | V                 | -35.05      |             |        |
|         | 5643.40         | V                 | -35.89      |             |        |
|         | 130.01          | Horizontal        | -60.33      | <-13.00     | Pass   |
|         | 312.06          | H                 | -57.06      |             |        |
|         | 1259.49         | H                 | -50.97      |             |        |
|         | 2418.83         | H                 | -48.46      |             |        |
|         | 3759.98         | H                 | -37.05      |             |        |
|         | 5643.40         | H                 | -37.89      |             |        |
| 810     | 312.06          | Vertical          | -54.24      | <-13.00     | Pass   |
|         | 598.09          | V                 | -53.38      |             |        |
|         | 1100.30         | V                 | -51.25      |             |        |
|         | 1448.07         | V                 | -49.70      |             |        |
|         | 3820.45         | V                 | -33.24      |             |        |
|         | 5725.84         | V                 | -35.67      |             |        |
|         | 319.84          | Horizontal        | -58.17      | <-13.00     | Pass   |
|         | 469.24          | H                 | -59.56      |             |        |
|         | 1194.80         | H                 | -52.08      |             |        |
|         | 1579.37         | H                 | -52.46      |             |        |
|         | 3820.45         | H                 | -31.36      |             |        |
|         | 5725.84         | H                 | -30.19      |             |        |

## Remark:

1. The emission behaviour belongs to narrowband spurious emission.
2. The emission levels of not record in the report are very lower than the limit and not show in test report.

## 6. TEST SETUP PHOTOS OF THE EUT

Radiated emission:

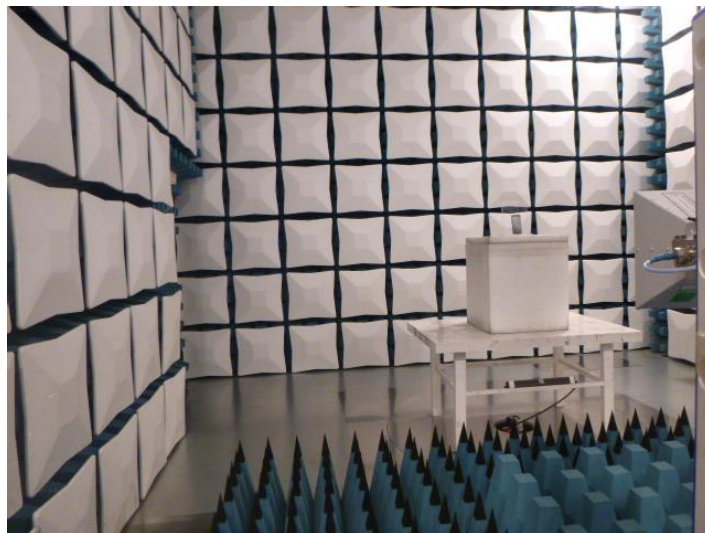
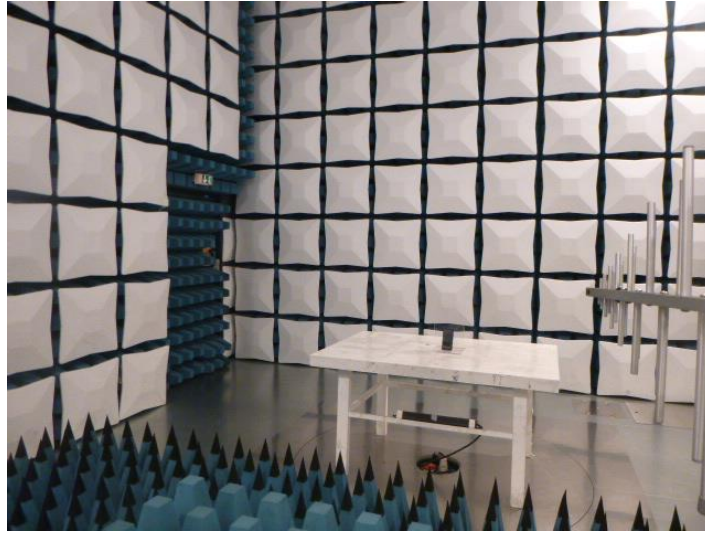



## 7. EXTERNAL AND INTERNAL PHOTOS OF THE EUT

### External photos of the EUT

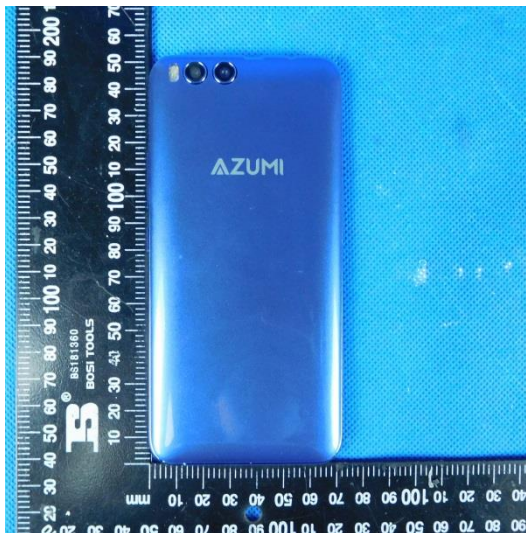

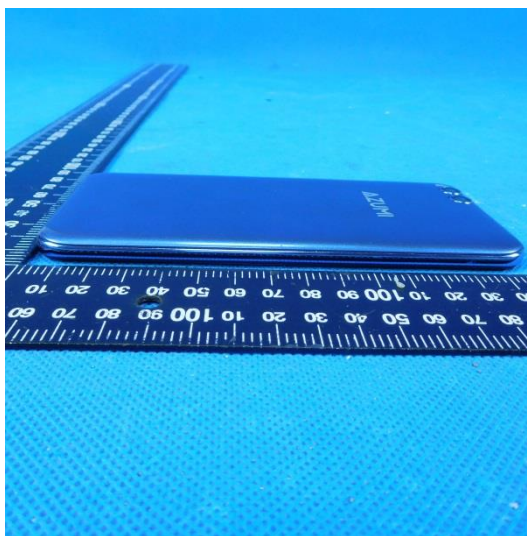
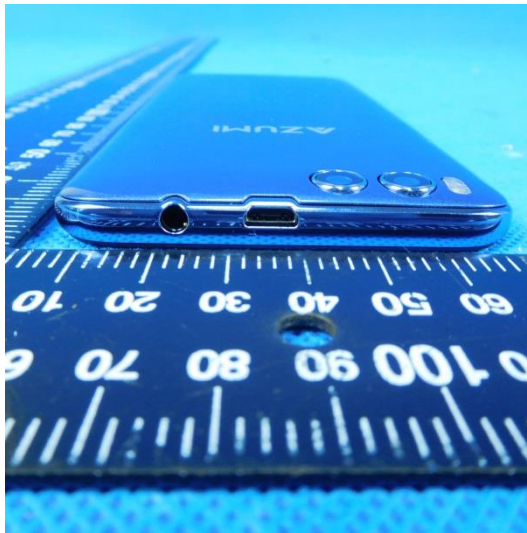
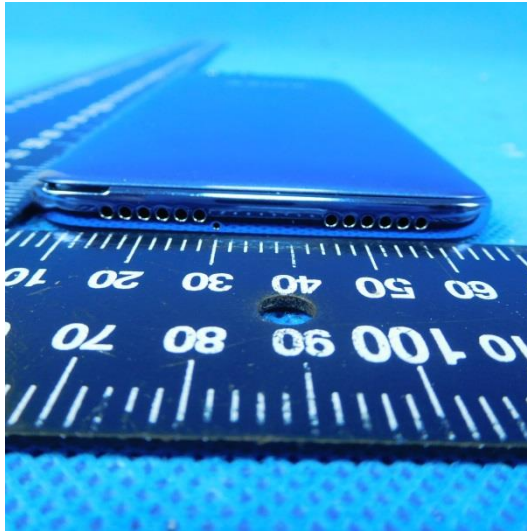

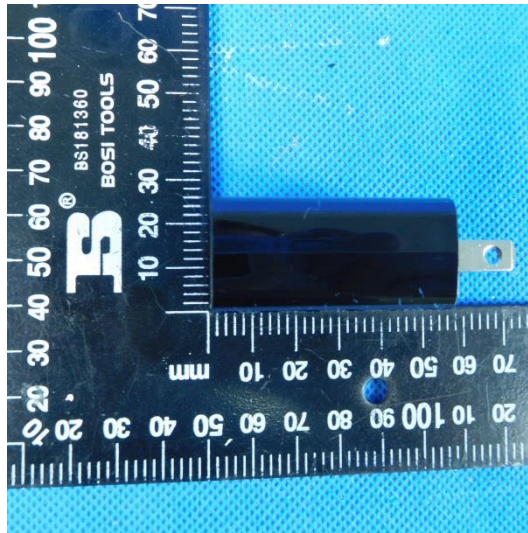
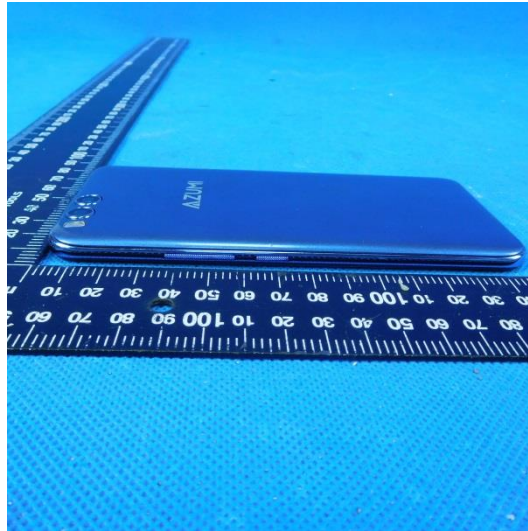







**AZUMI** TRAVEL CHARGER ICS01

Model NO.:PA-EU-5V 1A-020  
PRI: 100-240V ~ 50/60Hz 0.2A  
SEC: 5.0V= 1A

MANUFACTURER:     
HUIZHOU PUAN ELECTRONICS CO.,LTD.  
I.T.E.POWER SUPPLY

www.tuv.com  
TD1000000000

YYMMDDXXSSSSSPA MADE IN CHINA

**Internal photos of the EUT**



GSM/WCDMA Antenna

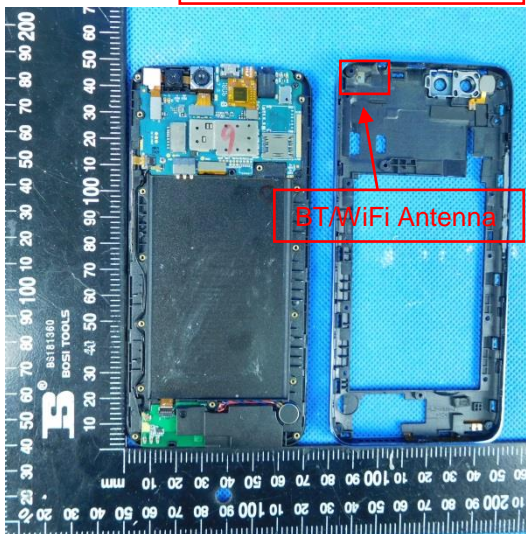

BT/WiFi Antenna

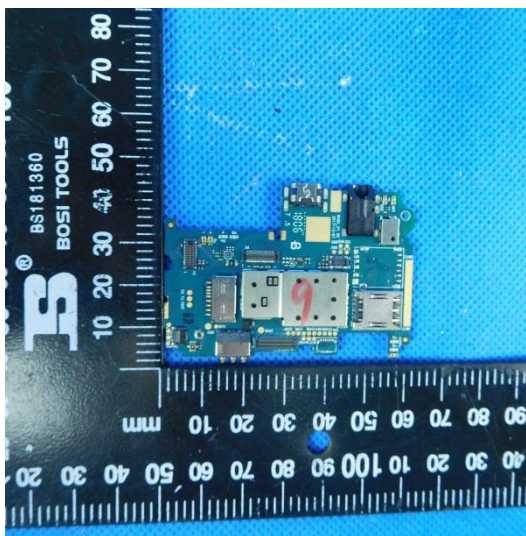
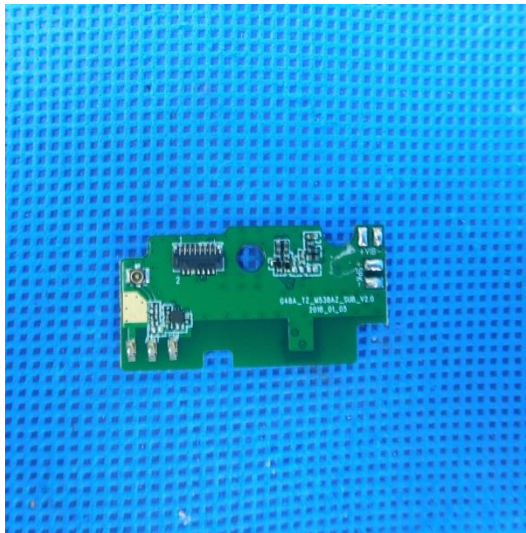
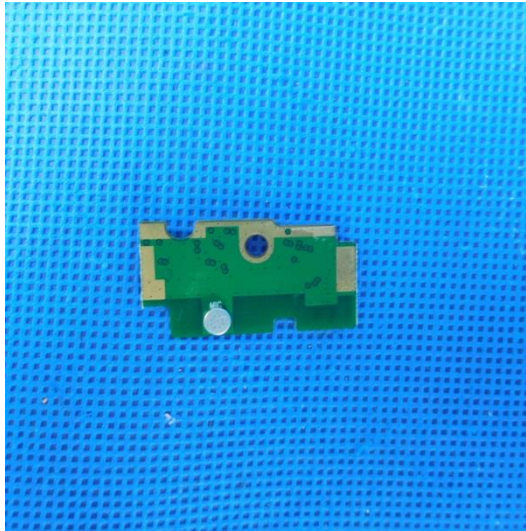

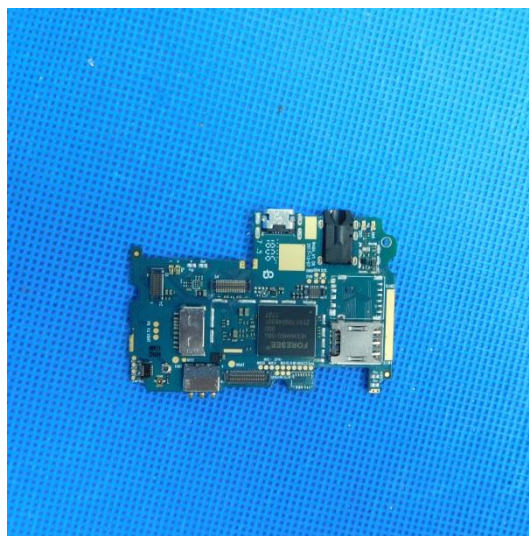
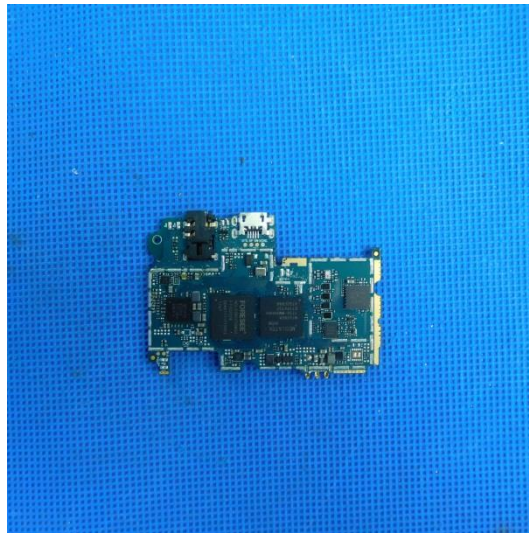
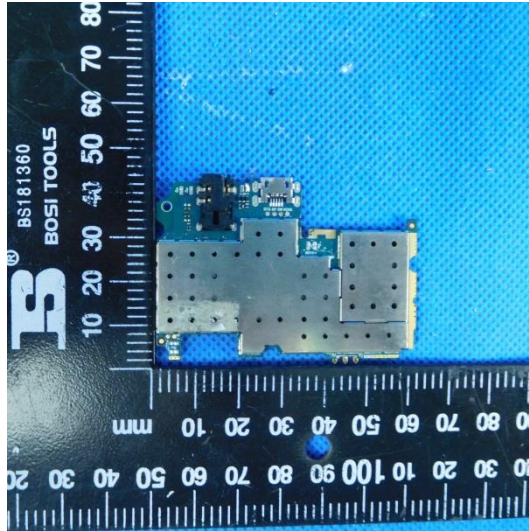

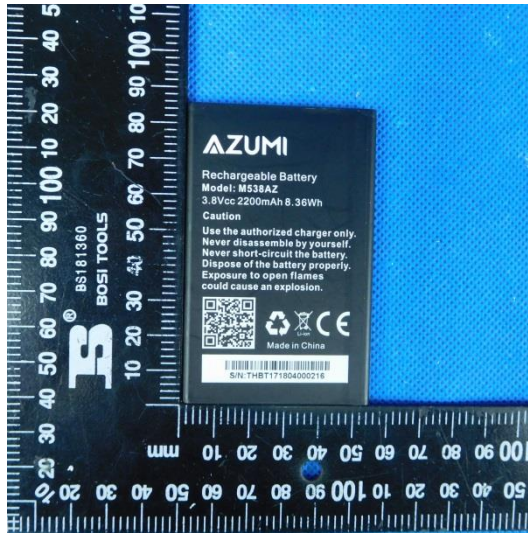

## 8. APPENDIX REPORT