



TEST REPORT

Report Reference No...... : **TRE1807004203** R/C.....: 73215

FCC ID..... : **QRP-FP-003**

Applicant's name..... : **Azumi S.A**

Address..... : Avenida Aquilino de la Guardia con Calle 47, PH Ocean Plaza,
Piso 16 of. 16-01, Marbella, Ciudad de Panama City, Rep.
Panama

Manufacturer..... : AZUMI HK LTD

Address..... : FLAT/RM 18 BLK 1 14/F GOLDEN INDUSTRIAL BUILDING 16-
26 KWAI TAK STREET KWAI CHUNG,HK

Test item description : **Mobile Phone**

Trade Mark : AZUM

Model/Type reference..... : L3GA LITE II

Listed Model(s) : -

Standard : **FCC CFR Title 47 Part 15 Subpart C Section 15.247**

Date of receipt of test sample..... : Jul.09,2018

Date of testing..... : Jul.10,2018-Jul.16,2018

Date of issue..... : Jul.17,2018

Result..... : **PASS**

Compiled by
(Position+Printed name+Signature): File administrators Silvia Li *Silvia Li*

Supervised by
(Position+Printed name+Signature): Project Engineer Aaron Fang *Aaron.Fang*

Approved by
(Position+Printed name+Signature): RF Manager Hans Hu *Hans Hu*

Testing Laboratory Name : **Shenzhen Huatongwei International Inspection Co., Ltd.**

Address..... : 1/F, Bldg 3, Hongfa Hi-tech Industrial Park, Genyu Road,
Tianliao, Gongming, Shenzhen, China

Shenzhen Huatongwei International Inspection Co., Ltd. All rights reserved.

This publication may be reproduced in whole or in part for non-commercial purposes as long as the Shenzhen Huatongwei International Inspection Co., Ltd. is acknowledged as copyright owner and source of the material. Shenzhen Huatongwei International Inspection Co., Ltd. takes no responsibility for and will not assume liability for damages resulting from the reader's interpretation of the reproduced material due to its placement and context.

The test report merely correspond to the test sample.

Contents

| | | |
|-----------|---|-----------|
| 1. | <u>TEST STANDARDS AND REPORT VERSION</u> | 3 |
| 1.1. | Test Standards | 3 |
| 1.2. | Report version | 3 |
| 2. | <u>TEST DESCRIPTION</u> | 4 |
| 3. | <u>SUMMARY</u> | 5 |
| 3.1. | Client Information | 5 |
| 3.2. | Product Description | 5 |
| 3.3. | Operation state | 6 |
| 3.4. | EUT configuration | 6 |
| 3.5. | Modifications | 6 |
| 4. | <u>TEST ENVIRONMENT</u> | 7 |
| 4.1. | Address of the test laboratory | 7 |
| 4.2. | Test Facility | 7 |
| 4.3. | Environmental conditions | 8 |
| 4.4. | Statement of the measurement uncertainty | 8 |
| 4.5. | Equipments Used during the Test | 9 |
| 5. | <u>TEST CONDITIONS AND RESULTS</u> | 11 |
| 5.1. | Antenna requirement | 11 |
| 5.2. | Conducted Emissions (AC Main) | 12 |
| 5.3. | Conducted Peak Output Power | 15 |
| 5.4. | 20 dB Bandwidth | 19 |
| 5.5. | Carrier Frequencies Separation | 23 |
| 5.6. | Hopping Channel Number | 25 |
| 5.7. | Dwell Time | 27 |
| 5.8. | Pseudorandom Frequency Hopping Sequence | 34 |
| 5.9. | Restricted band (radiated) | 35 |
| 5.10. | Band edge and Spurious Emissions (conducted) | 37 |
| 5.11. | Spurious Emissions (radiated) | 53 |
| 6. | <u>TEST SETUP PHOTOS</u> | 58 |
| 7. | <u>EXTERANAL AND INTERNAL PHOTOS</u> | 59 |

1. TEST STANDARDS AND REPORT VERSION

1.1. Test Standards

The tests were performed according to following standards:

[FCC Rules Part 15.247](#): Frequency Hopping, Direct Spread Spectrum and Hybrid Systems that are in operation within the bands of 902-928 MHz, 2400-2483.5 MHz, and 5725-5850 MHz

[ANSI C63.10-2013](#): American National Standard for Testing Unlicensed Wireless Devices

1.2. Report version

| Version No. | Date of issue | Description |
|-------------|---------------|-------------|
| N/A | 2018-07-17 | Original |
| | | |
| | | |
| | | |
| | | |

2. TEST DESCRIPTION

| Test Item | Section in CFR 47 | Result | Test Engineer |
|---|--------------------------|---------------|----------------------|
| Antenna Requirement | 15.203/15.247 (c) | PASS | Xiaokang Tan |
| AC Power Line Conducted Emissions | 15.207 | PASS | Tony Duan |
| Conducted Peak Output Power | 15.247 (b)(1) | PASS | Xiaokang Tan |
| 20 dB Bandwidth | 15.247 (a)(1) | PASS | Xiaokang Tan |
| Carrier Frequencies Separation | 15.247 (a)(1) | PASS | Xiaokang Tan |
| Hopping Channel Number | 15.247 (a)(1) | PASS | Xiaokang Tan |
| Dwell Time | 15.247 (a)(1) | PASS | Xiaokang Tan |
| Pseudorandom Frequency Hopping Sequence | 15.247(b)(4) | PASS | Xiaokang Tan |
| Restricted band | 15.247(d)/15.205 | PASS | Xiaokang Tan |
| Radiated Emissions | 15.247(d)/15.209 | PASS | Jiuru Pan |

Note: The measurement uncertainty is not included in the test result.

3. SUMMARY

3.1. Client Information

| | |
|---------------|--|
| Applicant: | Azumi S.A |
| Address: | Avenida Aquilino de la Guardia con Calle 47, PH Ocean Plaza, Piso 16 of. 16-01, Marbella, Ciudad de Panama City, Rep. Panama |
| Manufacturer: | AZUMI HK LTD |
| Address: | FLAT/RM 18 BLK 1 14/F GOLDEN INDUSTRIAL BUILDING 16-26 KWAI TAK STREET KWAI CHUNG, HK |

3.2. Product Description

| | |
|----------------------|---|
| Name of EUT: | Mobile Phone |
| Trade Mark: | AZUMI |
| Model No.: | L3GA LITE II |
| Listed Model(s): | - |
| IMEI: | Conducted: 355326060000536 Radiated: 355326060000528 |
| Power supply: | DC 3.7V |
| Adapter information: | Input: 100-240Va.c., 50/60Hz, 0.1A Output: 5.0Vd.c., 500mA |
| Hardware version: | HK321_MB_V1.0 |
| Software version: | AZUMI_L3GA_LITE_II_CO_V01 |
| Bluetooth | |
| Version: | Supported BT2.1+EDR |
| Modulation: | GFSK, $\pi/4$ DQPSK, 8DPSK |
| Operation frequency: | 2402MHz~2480MHz |
| Channel number: | 79 |
| Channel separation: | 1MHz |
| Antenna type: | Integral antenna |
| Antenna gain: | -2dBi |

3.3. Operation state

➤ **Test frequency list**

According to section 15.31(m), regards to the operating frequency range over 10 MHz, must select three channel which were tested. the Lowest frequency, the middle frequency, and the highest frequency of channel were selected to perform the test, please see the above gray bottom.

| Channel | Frequency (MHz) |
|---------|-----------------|
| 00 | 2402 |
| 01 | 2403 |
| ⋮ | ⋮ |
| 39 | 2441 |
| ⋮ | ⋮ |
| 77 | 2479 |
| 78 | 2480 |

➤ **TEST MODE**

| |
|--|
| For RF test items: |
| The engineering test program was provided and enabled to make EUT continuous transmit |
| For AC power line conducted emissions: |
| The EUT was set to connect with the Bluetooth instrument under large package sizes transmission. |
| For Radiated suprious emissions test item: |
| The engineering test program was provided and enabled to make EUT continuous transmit. The EUT in each of three orthogonal axis emissions had been tested ,but only the worst case (X axis) data recorded in the report. |

3.4. EUT configuration

The following peripheral devices and interface cables were connected during the measurement:

- - supplied by the manufacturer
- - supplied by the lab

| | | |
|---|---------------|---|
| / | Manufacturer: | / |
| | Model No.: | / |
| / | Manufacturer: | / |
| | Model No.: | / |

3.5. Modifications

No modifications were implemented to meet testing criteria.

4. TEST ENVIRONMENT

4.1. Address of the test laboratory

Laboratory: Shenzhen Huatongwei International Inspection Co., Ltd.

Address: 1/F, Bldg 3, Hongfa Hi-tech Industrial Park, Genyu Road, Tianliao, Gongming, Shenzhen, China

4.2. Test Facility

CNAS-Lab Code: L1225

Shenzhen Huatongwei International Inspection Co., Ltd. has been assessed and proved to be in compliance with CNAS-CL01 Accreditation Criteria for Testing and Calibration Laboratories (identical to ISO/IEC17025: 2005 General Requirements) for the Competence of Testing and Calibration Laboratories.

A2LA-Lab Cert. No.: 3902.01

Shenzhen Huatongwei International Inspection Co., Ltd. EMC Laboratory has been accredited by A2LA for technical competence in the field of electrical testing, and proved to be in compliance with ISO/IEC 17025: 2005 General Requirements for the Competence of Testing and Calibration Laboratories and any additional program requirements in the identified field of testing.

FCC-Registration No.: 762235

Shenzhen Huatongwei International Inspection Co., Ltd. EMC Laboratory has been registered and fully described in a report filed with the FCC (Federal Communications Commission). The acceptance letter from the FCC is maintained in our files.

IC-Registration No.:5377B-1

Two 3m Alternate Test Site of Shenzhen Huatongwei International Inspection Co., Ltd. has been registered by Certification and Engineering Bureau of Industry Canada for the performance of radiated measurements with Registration No.: 5377B-1.

ACA

Shenzhen Huatongwei International Inspection Co., Ltd. EMC Laboratory can also perform testing for the Australian C-Tick mark as a result of our A2LA accreditation.

4.3. Environmental conditions

During the measurement the environmental conditions were within the listed ranges:

| | |
|--------------------|-------------|
| Temperature: | 15~35°C |
| Relative Humidity: | 30~60 % |
| Air Pressure: | 950~1050mba |

4.4. Statement of the measurement uncertainty

The data and results referenced in this document are true and accurate. The reader is cautioned that there may be errors in calibration limits of the equipment and facilities. The measurement uncertainty was calculated for all measurements listed in this test report according to TR-100028-01 "Electromagnetic compatibility and Radio spectrum Matters (ERM); Uncertainties in the measurement of mobile radio equipment characteristics; Part 1" and TR-100028-02 "Electromagnetic compatibility and Radio spectrum Matters (ERM); Uncertainties in the measurement of mobile radio equipment characteristics; Part 2" and is documented in the Shenzhen Huatongwei International Inspection Co., Ltd. quality system according to ISO/IEC 17025. Furthermore, component and process variability of devices similar to that tested may result in additional deviation. The manufacturer has the sole responsibility of continued compliance of the device.

Here after the best measurement capability for Shenzhen Huatongwei International Inspection Co., Ltd. is reported:

| Test Items | Measurement Uncertainty | Notes |
|---|-------------------------|-------|
| Transmitter power conducted | 0.57 dB | (1) |
| Transmitter power Radiated | 2.20 dB | (1) |
| Conducted spurious emissions 9kHz~40GHz | 1.60 dB | (1) |
| Radiated spurious emissions 9kHz~40GHz | 2.20 dB | (1) |
| Conducted Emissions 9kHz~30MHz | 3.39 dB | (1) |
| Radiated Emissions 30~1000MHz | 4.24 dB | (1) |
| Radiated Emissions 1~18GHz | 5.16 dB | (1) |
| Radiated Emissions 18~40GHz | 5.54 dB | (1) |
| Occupied Bandwidth | ----- | (1) |

(1) This uncertainty represents an expanded uncertainty expressed at approximately the 95% confidence level using a coverage factor of k=1.96.

4.5. Equipments Used during the Test

| Conducted Emissions | | | | | | |
|---------------------|---------------------|--------------|-----------|------------|----------------------|----------------------|
| Item | Test Equipment | Manufacturer | Model No. | Serial No. | Last Cal. (mm-dd-yy) | Next Cal. (mm-dd-yy) |
| 1 | EMI Test Receiver | R&S | ESCI | 101247 | 11/11/2017 | 11/10/2018 |
| 2 | Artificial Mains | SCHWARZBECK | NNLK 8121 | 573 | 11/11/2017 | 11/10/2018 |
| 3 | 2-Line V-Network | R&S | ESH3-Z5 | 100049 | 11/11/2017 | 11/10/2018 |
| 4 | Pulse Limiter | R&S | ESH3-Z2 | 101488 | 11/11/2017 | 11/10/2018 |
| 5 | RF Connection Cable | HUBER+SUHNER | EF400 | N/A | 11/21/2017 | 11/20/2018 |
| 6 | Test Software | R&S | ES-K1 | N/A | N/A | N/A |

| Radiated Emissions | | | | | | |
|--------------------|-------------------------|--------------------|--------------|-----------------|----------------------|----------------------|
| Item | Test Equipment | Manufacturer | Model No. | Serial No. | Last Cal. (mm-dd-yy) | Next Cal. (mm-dd-yy) |
| 1 | Semi-Anechoic Chamber | Albatross projects | SAC-3m-01 | C11121 | 10/16/2016 | 10/15/2019 |
| 2 | EMI Test Receiver | R&S | ESCI | 100900 | 11/11/2017 | 11/10/2018 |
| 3 | Loop Antenna | R&S | HFH2-Z2 | 100020 | 11/20/2017 | 11/19/2020 |
| 4 | Ultra-Broadband Antenna | SCHWARZBECK | VULB9163 | 538 | 4/5/2017 | 4/4/2020 |
| 5 | Horn Antenna | SCHWARZBECK | 9120D | 1011 | 3/27/2017 | 3/26/2020 |
| 6 | Broadband Horn Antenna | SCHWARZBECK | BBHA9170 | BBHA9170 472 | 3/27/2017 | 3/26/2020 |
| 7 | Pre-amplifier | SCHWARZBECK | BBV 9743 | 9743-0022 | 10/18/2017 | 10/17/2018 |
| 8 | Broadband Pre-amplifier | SCHWARZBECK | BBV 9718 | 9718-248 | 10/18/2017 | 10/17/2018 |
| 9 | Spectrum Analyzer | R&S | FSP40 | 100597 | 11/11/2017 | 11/10/2018 |
| 10 | RF Connection Cable | HUBER+SUHNER | RE-7-FL | N/A | 11/21/2017 | 11/20/2018 |
| 11 | RF Connection Cable | HUBER+SUHNER | RE-7-FH | N/A | 11/21/2017 | 11/20/2018 |
| 12 | Test Software | Audix | E3 | N/A | N/A | N/A |
| 13 | Test Software | R&S | ES-K1 | N/A | N/A | N/A |
| 14 | Turntable | Maturo Germany | TT2.0-1T | N/A | N/A | N/A |
| 15 | Antenna Mast | Maturo Germany | CAM-4.0-P-12 | N/A | N/A | N/A |

| RF Conducted Test | | | | | | |
|--------------------------|---------------------|--------------|-----------|------------|-------------------------|-------------------------|
| Item | Test Equipment | Manufacturer | Model No. | Serial No. | Last Cal. (mm-dd-yy) | Next Cal. (mm-dd-yy) |
| 1 | Spectrum Analyzer | R&S | FSV40 | 100048 | 11/11/2017 | 11/10/2018 |
| 2 | EXA Signal Analyzer | Agilent | N9020A | 184247 | 9/22/2017 | 9/21/2018 |
| 3 | OSP | R&S | OSP120 | 101317 | N/A | N/A |

5. TEST CONDITIONS AND RESULTS

5.1. Antenna requirement

Requirement

FCC CFR Title 47 Part 15 Subpart C Section 15.203:

An intentional radiator shall be designed to ensure that no antenna other than that furnished by the responsible party shall be used with the device. The use of a permanently attached antenna or of an antenna that uses a unique coupling to the intentional radiator, the manufacturer may design the unit so that a broken antenna can be replaced by the user, but the use of a standard antenna jack or electrical connector is prohibited.

FCC CFR Title 47 Part 15 Subpart C Section 15.247(c) (1)(i):

(i) Systems operating in the 2400~2483.5 MHz band that is used exclusively for fixed. Point-to-point operations may employ transmitting antennas with directional gain greater than 6 dBi provided the maximum conducted output power of the intentional radiator is reduced by 1 dB for every 3 dB that the directional gain of the antenna exceeds 6 dBi.

Test Result:

Passed **Not Applicable**

The directional gain of the antenna less than 6 dBi, please refer to the below antenna photo.

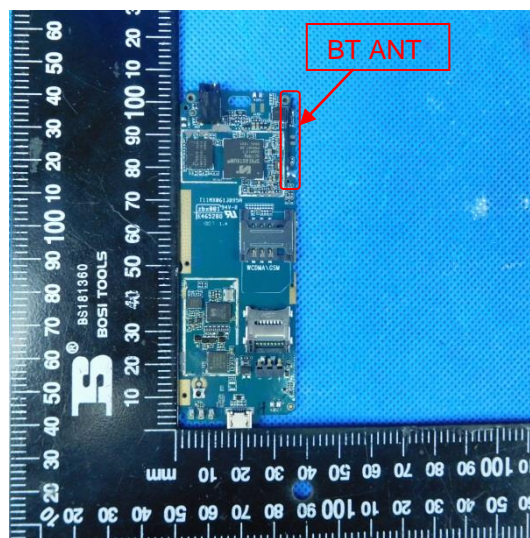

5.2. Conducted Emissions (AC Main)

LIMIT

FCC CFR Title 47 Part 15 Subpart C Section 15.207

| Frequency range (MHz) | Limit (dBuV) | |
|-----------------------|--------------|-----------|
| | Quasi-peak | Average |
| 0.15-0.5 | 66 to 56* | 56 to 46* |
| 0.5-5 | 56 | 46 |
| 5-30 | 60 | 50 |

* Decreases with the logarithm of the frequency.

TEST CONFIGURATION

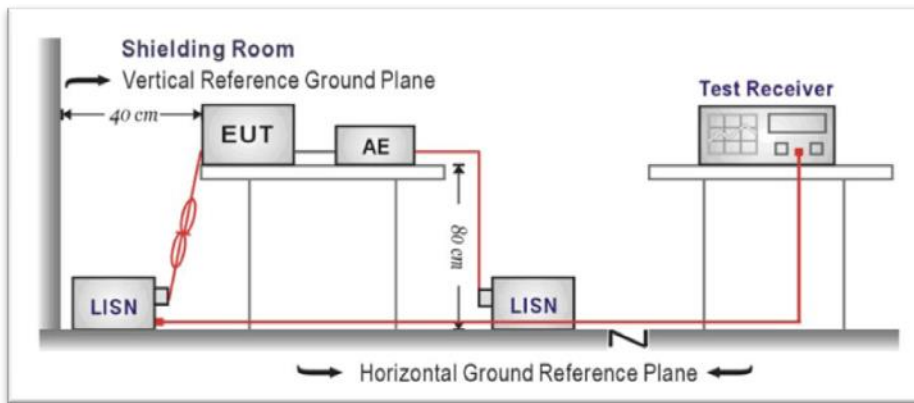

TEST PROCEDURE

1. The EUT was setup according to ANSI C63.10:2013 requirements.
2. The EUT was placed on a platform of nominal size, 1 m by 1.5 m, raised 80 cm above the conducting ground plane. The vertical conducting plane was located 40 cm to the rear of the EUT. All other surfaces of EUT were at least 80 cm from any other grounded conducting surface.
3. The EUT and simulators are connected to the main power through a line impedances stabilization network (LISN). The LISN provides a 50 ohm /50uH coupling impedance for the measuring equipment.
4. The peripheral devices are also connected to the main power through a LISN. (Please refer to the block diagram of the test setup and photographs)
5. Each current-carrying conductor of the EUT power cord, except the ground (safety) conductor, was individually connected through a LISN to the input power source.
6. The excess length of the power cord between the EUT and the LISN receptacle were folded back and forth at the center of the lead to form a bundle not exceeding 40 cm in length.
7. Conducted emissions were investigated over the frequency range from 0.15MHz to 30MHz using a receiver bandwidth of 9 kHz.
8. During the above scans, the emissions were maximized by cable manipulation.

TEST RESULTS

Passed Not Applicable

Note:

- 1) Transd= Cable lose + Pulse Limiter Factor + Artificial Mains Factor
- 2) Margin= Limit - Level

Test Line:

L

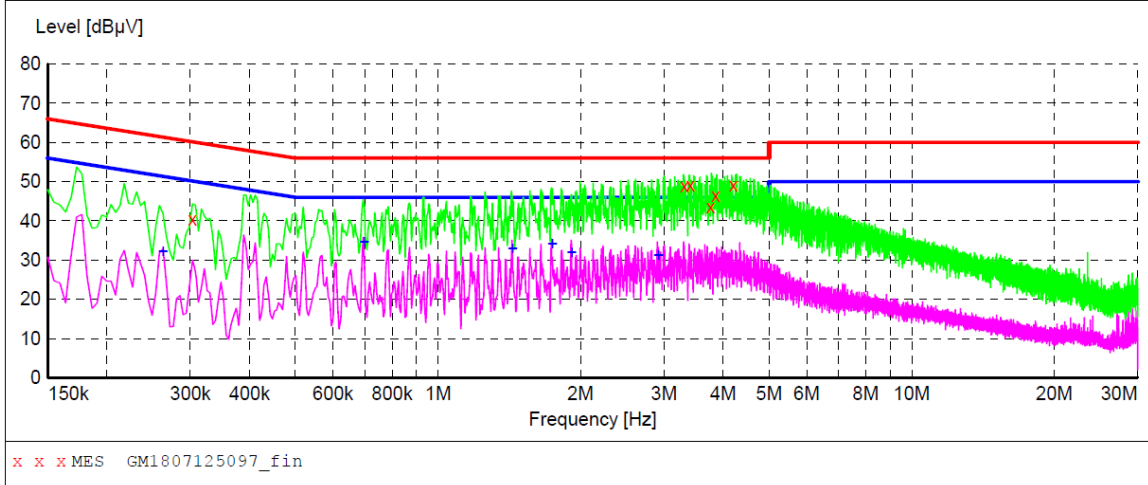

MEASUREMENT RESULT: "GM1807125097_fin"

7/12/2018 8:36PM

| Frequency MHz | Level dBµV | Transd dB | Limit dBµV | Margin dB | Detector | Line | PE |
|------------------|---------------|--------------|---------------|--------------|----------|------|-----|
| 0.303000 | 40.30 | 9.9 | 60 | 19.9 | QP | N | GND |
| 3.313500 | 48.90 | 10.1 | 56 | 7.1 | QP | N | GND |
| 3.408000 | 49.10 | 10.1 | 56 | 6.9 | QP | N | GND |
| 3.763500 | 43.50 | 10.1 | 56 | 12.5 | QP | N | GND |
| 3.853500 | 46.40 | 10.1 | 56 | 9.6 | QP | N | GND |
| 4.200000 | 49.00 | 10.1 | 56 | 7.0 | QP | N | GND |

MEASUREMENT RESULT: "GM1807125097_fin2"

7/12/2018 8:36PM

| Frequency MHz | Level dBµV | Transd dB | Limit dBµV | Margin dB | Detector | Line | PE |
|------------------|---------------|--------------|---------------|--------------|----------|------|-----|
| 0.262500 | 32.20 | 9.9 | 51 | 19.2 | AV | N | GND |
| 0.699000 | 34.50 | 10.0 | 46 | 11.5 | AV | N | GND |
| 1.437000 | 32.80 | 10.1 | 46 | 13.2 | AV | N | GND |
| 1.743000 | 34.20 | 10.1 | 46 | 11.8 | AV | N | GND |
| 1.914000 | 32.00 | 10.1 | 46 | 14.0 | AV | N | GND |
| 2.922000 | 31.30 | 10.1 | 46 | 14.7 | AV | N | GND |

Test Line:

N

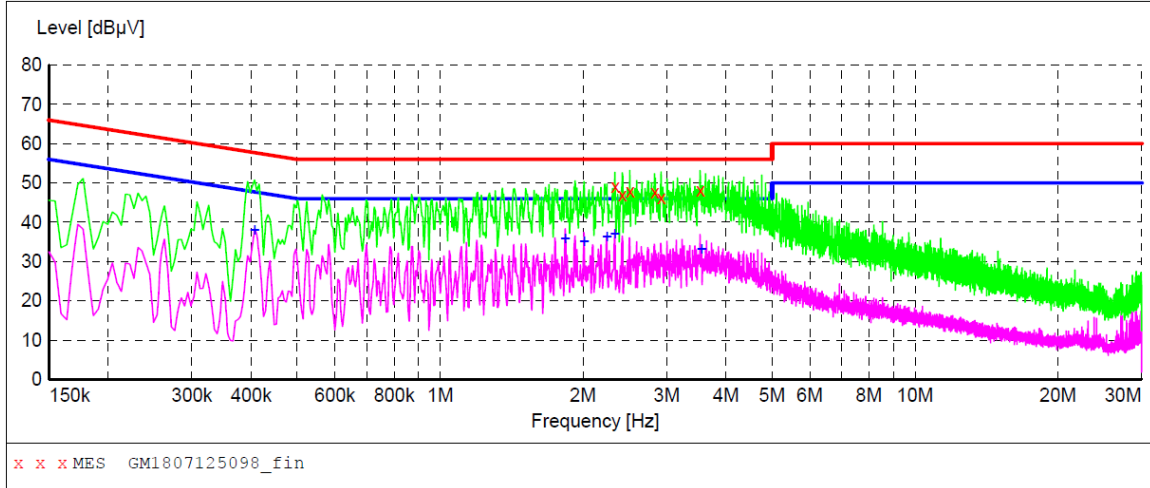

MEASUREMENT RESULT: "GM1807125098_fin"

7/12/2018 8:39PM

| Frequency MHz | Level dBµV | Transd dB | Limit dBµV | Margin dB | Detector | Line | PE |
|------------------|---------------|--------------|---------------|--------------|----------|------|-----|
| 2.337000 | 49.10 | 10.1 | 56 | 6.9 | QP | L1 | GND |
| 2.418000 | 46.90 | 10.1 | 56 | 9.1 | QP | L1 | GND |
| 2.512500 | 48.00 | 10.1 | 56 | 8.0 | QP | L1 | GND |
| 2.832000 | 47.60 | 10.1 | 56 | 8.4 | QP | L1 | GND |
| 2.917500 | 46.30 | 10.1 | 56 | 9.7 | QP | L1 | GND |
| 3.534000 | 48.10 | 10.1 | 56 | 7.9 | QP | L1 | GND |

MEASUREMENT RESULT: "GM1807125098_fin2"

7/12/2018 8:39PM

| Frequency MHz | Level dBµV | Transd dB | Limit dBµV | Margin dB | Detector | Line | PE |
|------------------|---------------|--------------|---------------|--------------|----------|------|-----|
| 0.406500 | 38.00 | 9.9 | 48 | 9.7 | AV | L1 | GND |
| 1.833000 | 35.80 | 10.1 | 46 | 10.2 | AV | L1 | GND |
| 2.013000 | 35.20 | 10.1 | 46 | 10.8 | AV | L1 | GND |
| 2.247000 | 36.40 | 10.1 | 46 | 9.6 | AV | L1 | GND |
| 2.332500 | 36.90 | 10.1 | 46 | 9.1 | AV | L1 | GND |
| 3.556500 | 33.10 | 10.1 | 46 | 12.9 | AV | L1 | GND |

5.3. Conducted Peak Output Power

LIMIT

FCC CFR Title 47 Part 15 Subpart C Section 15.247 (b)(1):

For frequency hopping systems operating in the 2400-2483.5 MHz band employing at least 75 non-overlapping hopping channels, and all frequency hopping systems in the 5725-5850 MHz band: 1 watt.
 For all other frequency hopping systems in the 2400-2483.5 MHz band: 0.125 watts.

TEST CONFIGURATION

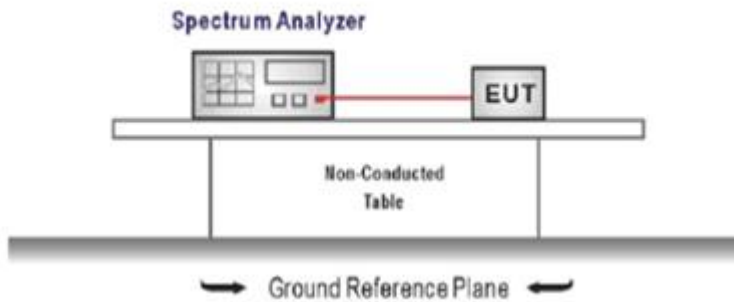

TEST PROCEDURE

1. The transmitter output was connected to the spectrum analyzer through an attenuator, the pathloss was compensated to the results for each measurement.
2. Set to the maximum power setting and enable the EUT transmit continuously
3. Use the following spectrum analyzer settings:
 Span = approximately 5 times the 20 dB bandwidth, centered on a hopping channel
 RBW ≥ the 20 dB bandwidth of the emission being measured, VBW ≥ RBW
 Sweep = auto, Detector function = peak, Trace = max hold
4. Measure and record the results in the test report.

TEST MODE:

Please refer to the clause 3.3

TEST RESULTS

Passed Not Applicable

| Modulation type | Channel | Output power (dBm) | Limit (dBm) | Result |
|-----------------|---------|--------------------|-------------|--------|
| GFSK | 00 | -1.44 | ≤ 30.00 | Pass |
| | 39 | -0.54 | | |
| | 78 | 0.13 | | |
| π/4DQPSK | 00 | -1.44 | ≤ 21.00 | Pass |
| | 39 | -0.52 | | |
| | 78 | 0.16 | | |
| 8DPSK | 00 | -1.44 | ≤ 21.00 | Pass |
| | 39 | -0.51 | | |
| | 78 | 0.17 | | |

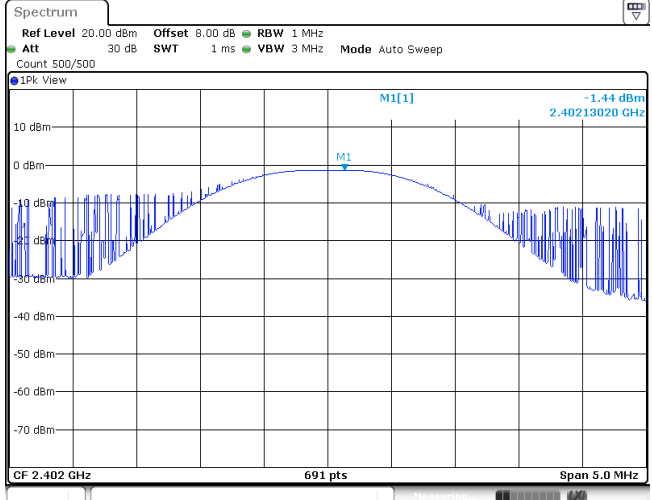
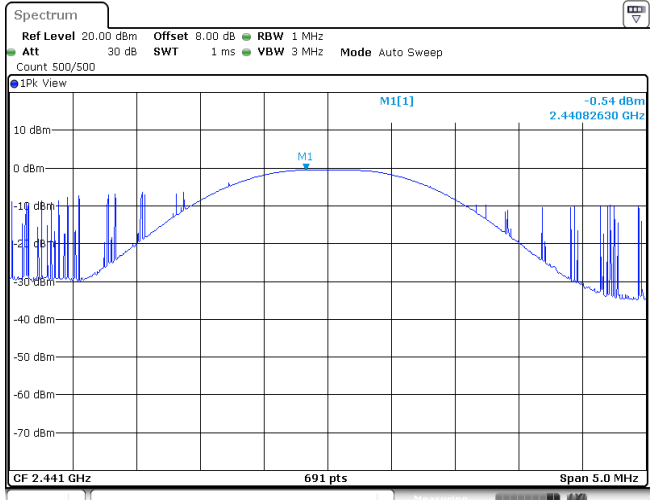
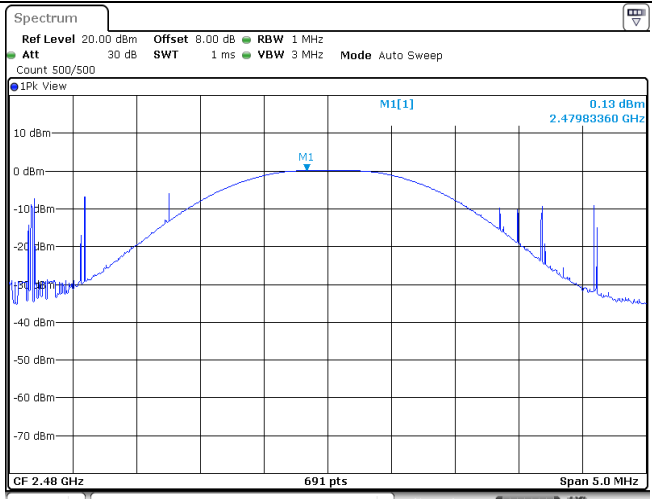
| Modulation Type: GFSK | |
|------------------------------|--|
| CH00 |  |
| CH39 |  |
| CH78 |  |

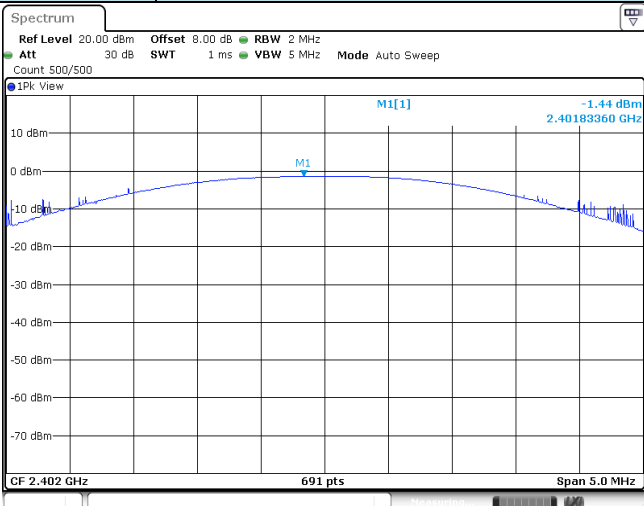
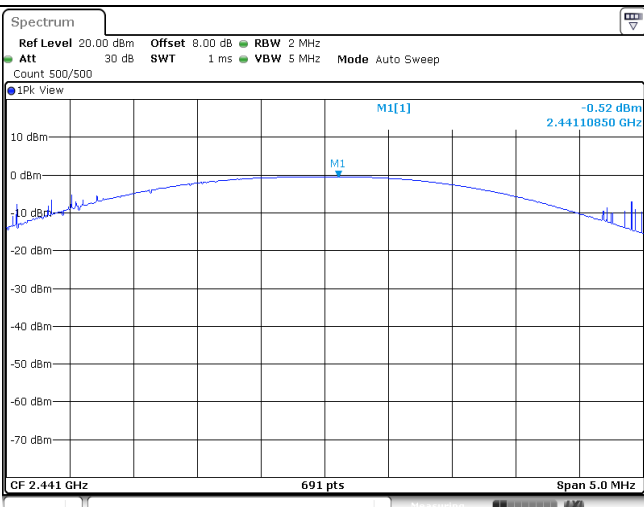
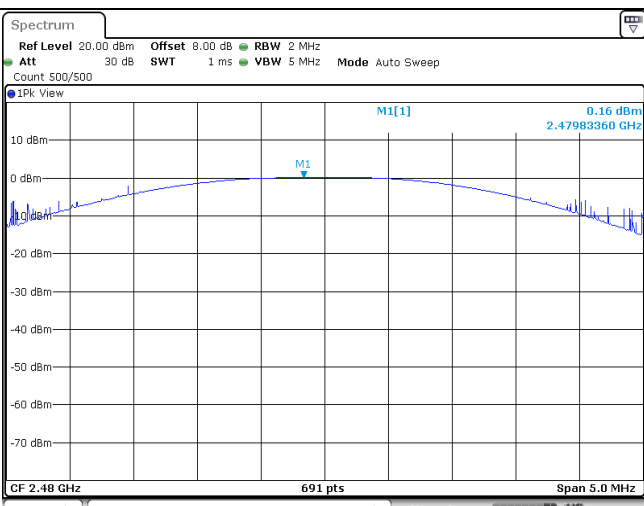
| Modulation Type: $\pi/4$ DQPSK | |
|--------------------------------|--|
| CH00 |  |
| CH39 |  |
| CH78 |  |

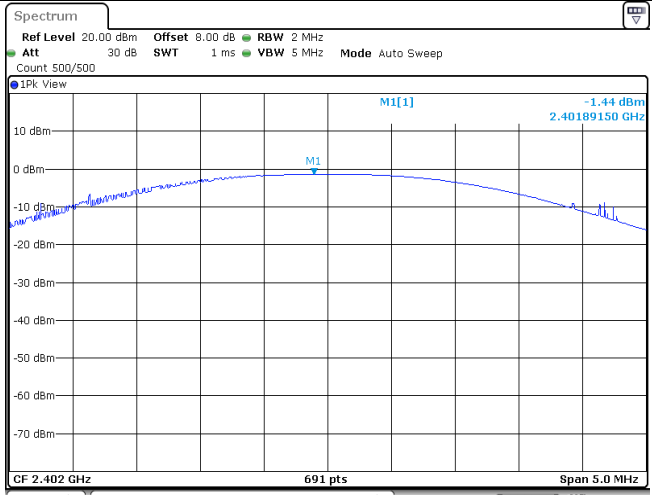
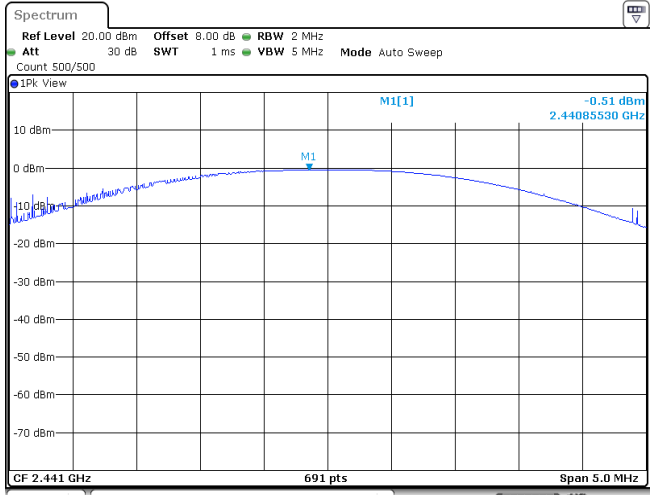
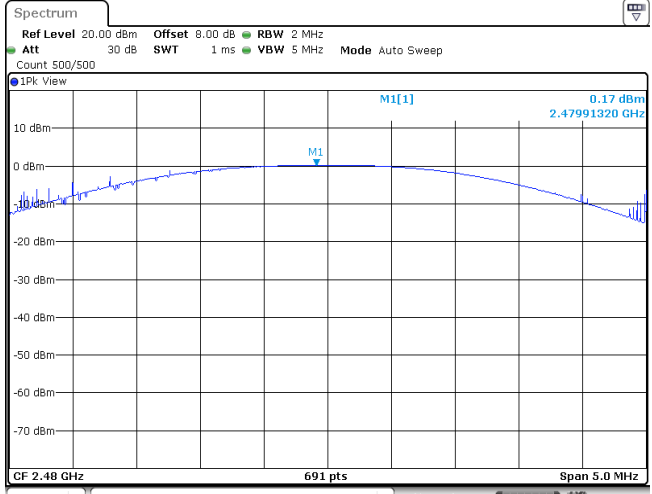
| Modulation Type: 8DPSK | |
|------------------------|--|
| CH00 |  |
| CH39 |  |
| CH78 |  |

5.4. 20 dB Bandwidth

LIMIT

N/A

TEST CONFIGURATION

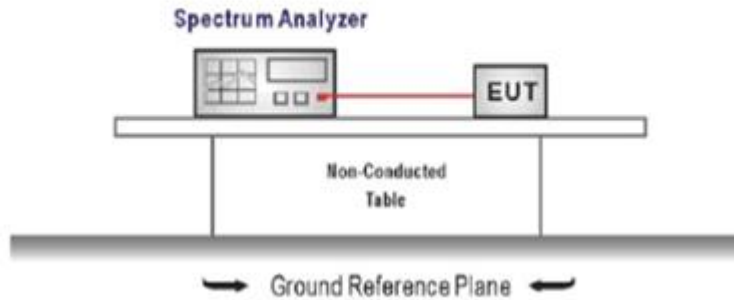

TEST PROCEDURE

1. The transmitter output was connected to the spectrum analyzer through an attenuator, the path loss was compensated to the results for each measurement.
2. Set to the maximum power setting and enable the EUT transmit continuously
3. Use the following spectrum analyzer settings:
Span = approximately 2 to 3 times the 20 dB bandwidth, centered on a hopping channel
RBW \geq 1% of the 20 dB bandwidth, VBW \geq RBW
Sweep = auto, Detector function = peak, Trace = max hold
4. Measure and record the results in the test report.

TEST MODE:

Please refer to the clause 3.3

TEST RESULTS

 Passed Not Applicable

| Modulation type | Channel | 20 dB Bandwidth (MHz) | Limit (MHz) | Result |
|-----------------|---------|-----------------------|-------------|--------|
| GFSK | 00 | 0.93 | - | Pass |
| | 39 | 0.93 | | |
| | 78 | 0.93 | | |
| $\pi/4$ DQPSK | 00 | 1.24 | - | Pass |
| | 39 | 1.23 | | |
| | 78 | 1.23 | | |
| 8DPSK | 00 | 1.25 | - | Pass |
| | 39 | 1.20 | | |
| | 78 | 1.20 | | |

| Modulation Type: | | GFSK | | | | | | | | | | | | | | | | | | | | | | | | | | | | | | | | |
|------------------|---|------|--------|---------------|------------|----------|-----------------|---------|----------|-----------------|----|--|--|---|---------------|------------|--|--|----|--|--|---|---------------|-----------|--|--|----|----|--|---|-----------|----------|--|--|
| CH00 | <table border="1"> <thead> <tr> <th>Marker</th> <th>Type</th> <th>Ref</th> <th>Trc</th> <th>X-value</th> <th>Y-value</th> <th>Function</th> <th>Function Result</th> </tr> </thead> <tbody> <tr> <td>M1</td> <td></td> <td></td> <td>1</td> <td>2.4015475 GHz</td> <td>-27.38 dBm</td> <td></td> <td></td> </tr> <tr> <td>M2</td> <td></td> <td></td> <td>1</td> <td>2.4020575 GHz</td> <td>-7.22 dBm</td> <td></td> <td></td> </tr> <tr> <td>D3</td> <td>M1</td> <td></td> <td>1</td> <td>927.5 kHz</td> <td>-0.63 dB</td> <td></td> <td></td> </tr> </tbody> </table> | | Marker | Type | Ref | Trc | X-value | Y-value | Function | Function Result | M1 | | | 1 | 2.4015475 GHz | -27.38 dBm | | | M2 | | | 1 | 2.4020575 GHz | -7.22 dBm | | | D3 | M1 | | 1 | 927.5 kHz | -0.63 dB | | |
| Marker | Type | Ref | Trc | X-value | Y-value | Function | Function Result | | | | | | | | | | | | | | | | | | | | | | | | | | | |
| M1 | | | 1 | 2.4015475 GHz | -27.38 dBm | | | | | | | | | | | | | | | | | | | | | | | | | | | | | |
| M2 | | | 1 | 2.4020575 GHz | -7.22 dBm | | | | | | | | | | | | | | | | | | | | | | | | | | | | | |
| D3 | M1 | | 1 | 927.5 kHz | -0.63 dB | | | | | | | | | | | | | | | | | | | | | | | | | | | | | |
| CH39 | <table border="1"> <thead> <tr> <th>Marker</th> <th>Type</th> <th>Ref</th> <th>Trc</th> <th>X-value</th> <th>Y-value</th> <th>Function</th> <th>Function Result</th> </tr> </thead> <tbody> <tr> <td>M1</td> <td></td> <td></td> <td>1</td> <td>2.4405475 GHz</td> <td>-26.54 dBm</td> <td></td> <td></td> </tr> <tr> <td>M2</td> <td></td> <td></td> <td>1</td> <td>2.4410575 GHz</td> <td>-6.31 dBm</td> <td></td> <td></td> </tr> <tr> <td>D3</td> <td>M1</td> <td></td> <td>1</td> <td>927.5 kHz</td> <td>-0.60 dB</td> <td></td> <td></td> </tr> </tbody> </table> | | Marker | Type | Ref | Trc | X-value | Y-value | Function | Function Result | M1 | | | 1 | 2.4405475 GHz | -26.54 dBm | | | M2 | | | 1 | 2.4410575 GHz | -6.31 dBm | | | D3 | M1 | | 1 | 927.5 kHz | -0.60 dB | | |
| Marker | Type | Ref | Trc | X-value | Y-value | Function | Function Result | | | | | | | | | | | | | | | | | | | | | | | | | | | |
| M1 | | | 1 | 2.4405475 GHz | -26.54 dBm | | | | | | | | | | | | | | | | | | | | | | | | | | | | | |
| M2 | | | 1 | 2.4410575 GHz | -6.31 dBm | | | | | | | | | | | | | | | | | | | | | | | | | | | | | |
| D3 | M1 | | 1 | 927.5 kHz | -0.60 dB | | | | | | | | | | | | | | | | | | | | | | | | | | | | | |
| CH78 | <table border="1"> <thead> <tr> <th>Marker</th> <th>Type</th> <th>Ref</th> <th>Trc</th> <th>X-value</th> <th>Y-value</th> <th>Function</th> <th>Function Result</th> </tr> </thead> <tbody> <tr> <td>M1</td> <td></td> <td></td> <td>1</td> <td>2.4795475 GHz</td> <td>-25.83 dBm</td> <td></td> <td></td> </tr> <tr> <td>M2</td> <td></td> <td></td> <td>1</td> <td>2.4800575 GHz</td> <td>-5.63 dBm</td> <td></td> <td></td> </tr> <tr> <td>D3</td> <td>M1</td> <td></td> <td>1</td> <td>927.5 kHz</td> <td>-0.60 dB</td> <td></td> <td></td> </tr> </tbody> </table> | | Marker | Type | Ref | Trc | X-value | Y-value | Function | Function Result | M1 | | | 1 | 2.4795475 GHz | -25.83 dBm | | | M2 | | | 1 | 2.4800575 GHz | -5.63 dBm | | | D3 | M1 | | 1 | 927.5 kHz | -0.60 dB | | |
| Marker | Type | Ref | Trc | X-value | Y-value | Function | Function Result | | | | | | | | | | | | | | | | | | | | | | | | | | | |
| M1 | | | 1 | 2.4795475 GHz | -25.83 dBm | | | | | | | | | | | | | | | | | | | | | | | | | | | | | |
| M2 | | | 1 | 2.4800575 GHz | -5.63 dBm | | | | | | | | | | | | | | | | | | | | | | | | | | | | | |
| D3 | M1 | | 1 | 927.5 kHz | -0.60 dB | | | | | | | | | | | | | | | | | | | | | | | | | | | | | |

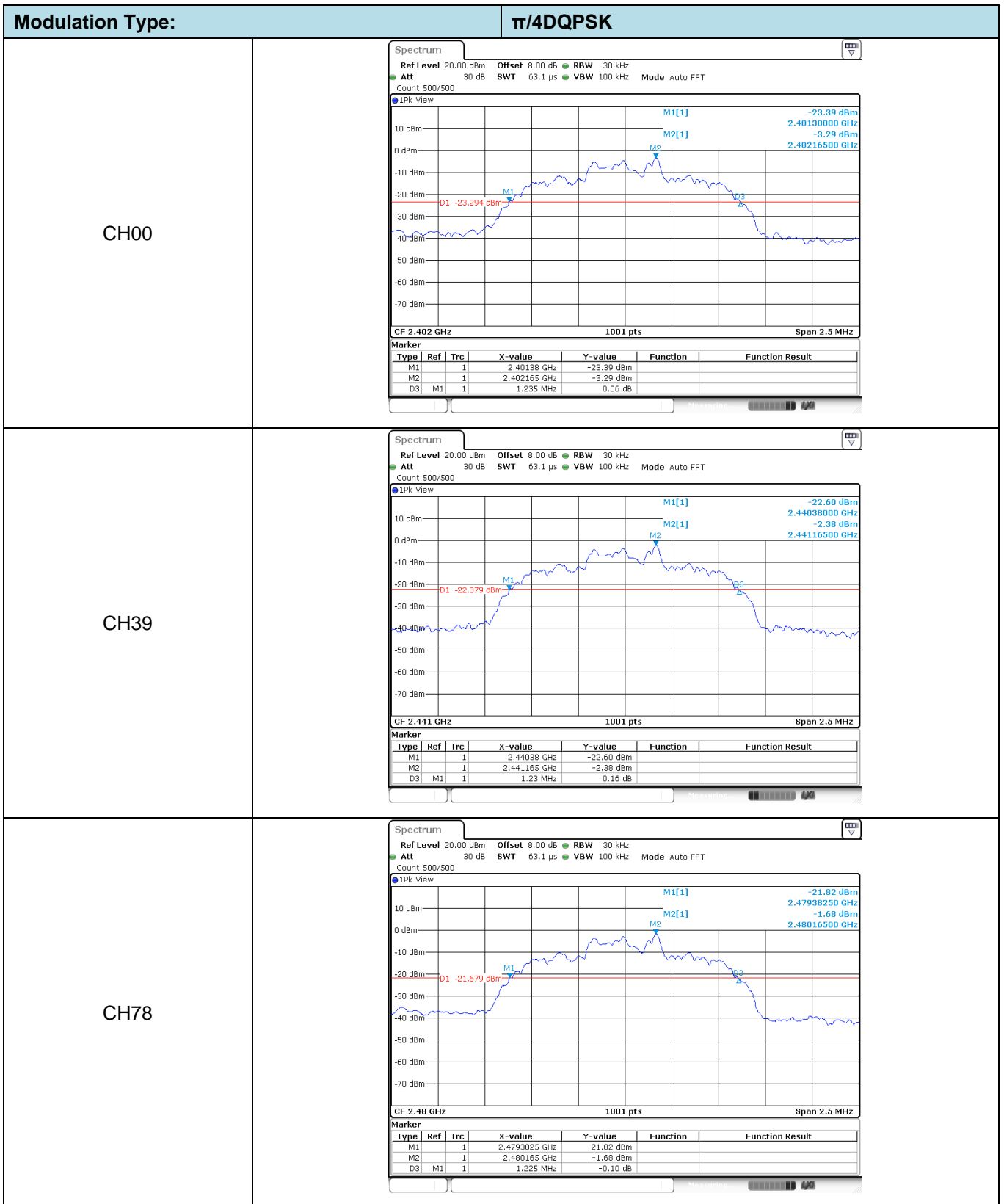

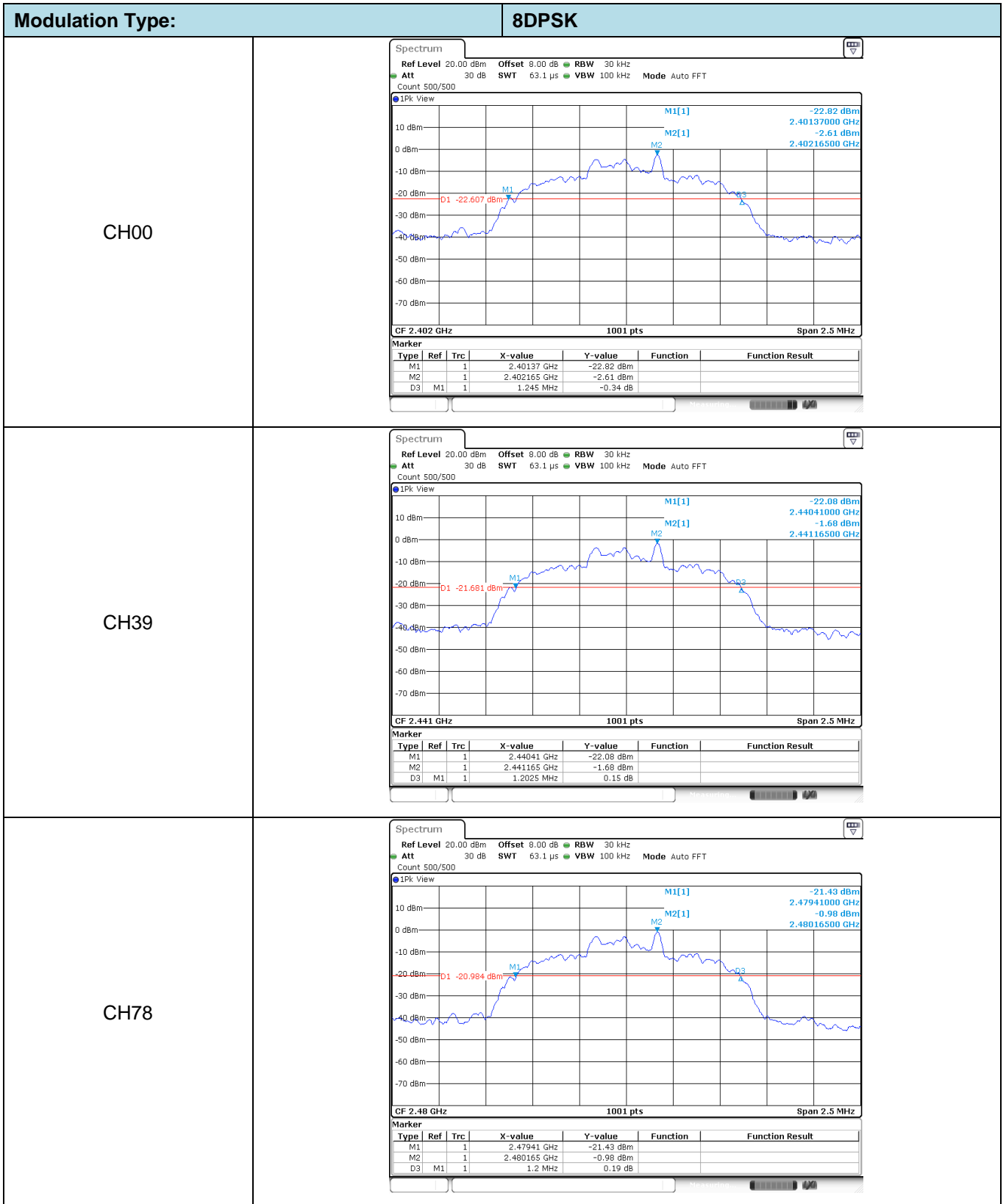

5.5. Carrier Frequencies Separation

LIMIT

FCC CFR Title 47 Part 15 Subpart C Section 15.247 (a)(1):

Frequency hopping systems shall have hopping channel carrier frequencies separated by a minimum of 25 kHz or the 20 dB bandwidth of the hopping channel, whichever is greater. Alternatively, Frequency hopping systems operating in the 2400-2483.5 MHz band may have hopping channel carrier frequencies that are separated by 25 kHz or two-thirds of the 20 dB bandwidth of the hopping channel, whichever is greater, provided the systems operate with an output power no greater than 125 mW.

TEST CONFIGURATION

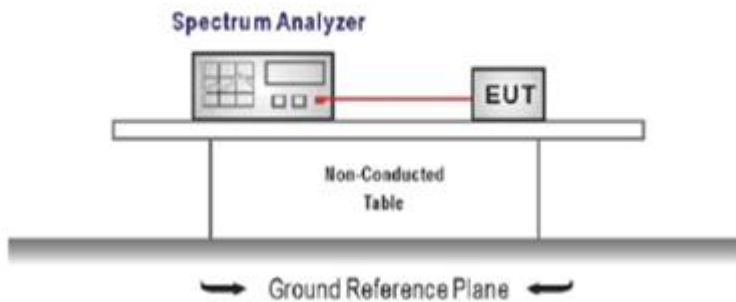

TEST PROCEDURE

1. The transmitter output was connected to the spectrum analyzer through an attenuator, the path loss was compensated to the results for each measurement.
2. Set to the maximum power setting and enable the EUT transmit continuously
3. Use the following spectrum analyzer settings:
 Span = wide enough to capture the peaks of two adjacent channels
 RBW ≥ 1% of the span, VBW ≥ RBW
 Sweep = auto, Detector function = peak, Trace = max hold
4. Measure and record the results in the test report.

TEST MODE:

Please refer to the clause 3.3

TEST RESULTS

Passed Not Applicable

| Modulation type | Channel | Carrier Frequencies Separation (MHz) | Limit (MHz) * | Result |
|-----------------|---------|--------------------------------------|---------------|--------|
| GFSK | 39 | 1.00 | ≥0.93 | Pass |
| π/4DQPSK | 39 | 1.00 | ≥0.83 | Pass |
| 8DPSK | 39 | 1.00 | ≥0.83 | Pass |

Note:

*: GFSK limit = The maximum 20 dB Bandwidth for GFSK modulation on the section 5.4.

π/4DQPSK limit = 2/3 * The maximum 20 dB Bandwidth for π/4DQPSK modulation on the section 5.4.

8DPSK limit = 2/3 * The maximum 20 dB Bandwidth for 8DPSK modulation on the section 5.4

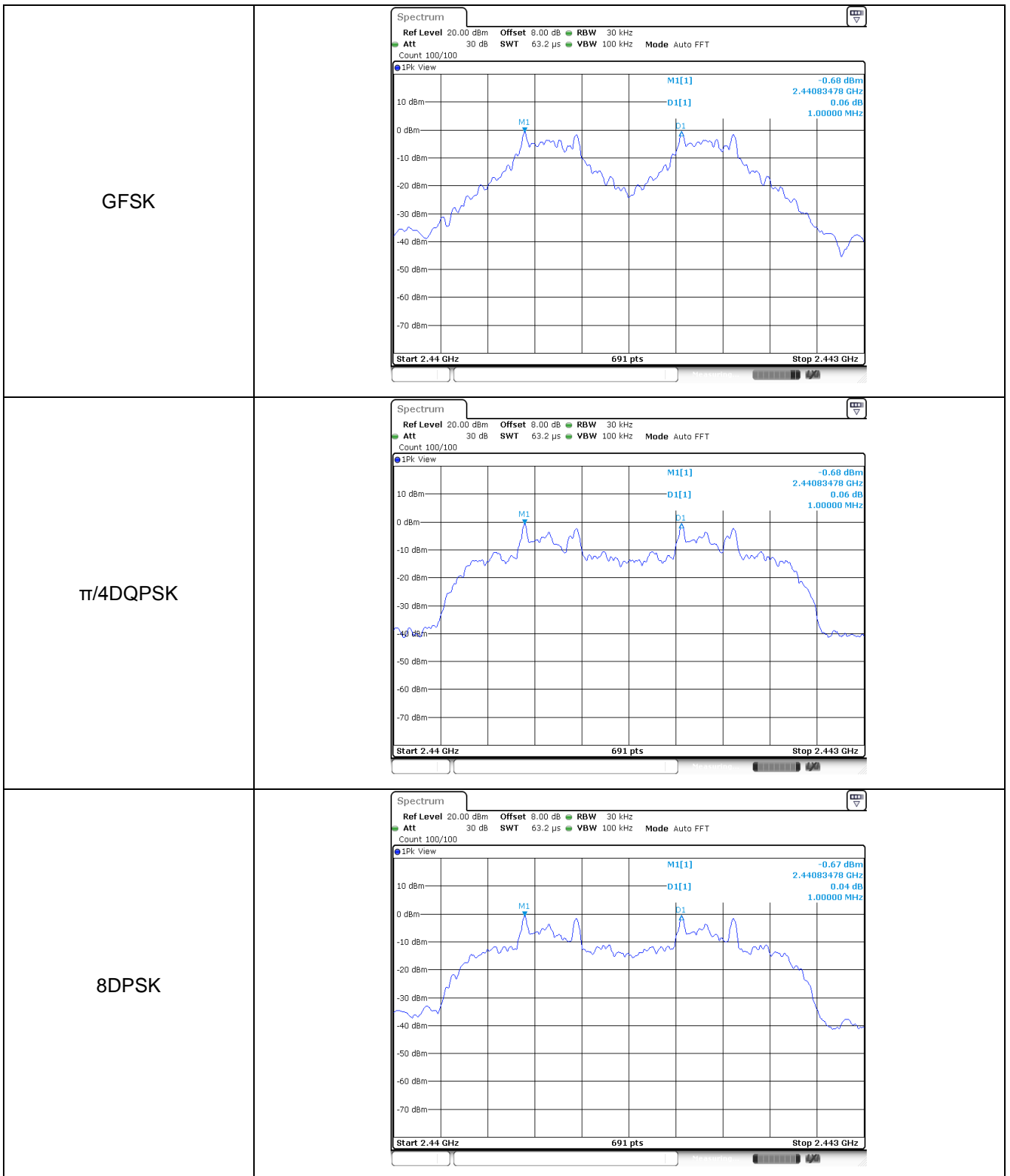

5.6. Hopping Channel Number

LIMIT

FCC CFR Title 47 Part 15 Subpart C Section 15.247 (a)(1):Frequency hopping systems in the 2400–2483.5 MHz band shall use at least **15** channels.

TEST CONFIGURATION

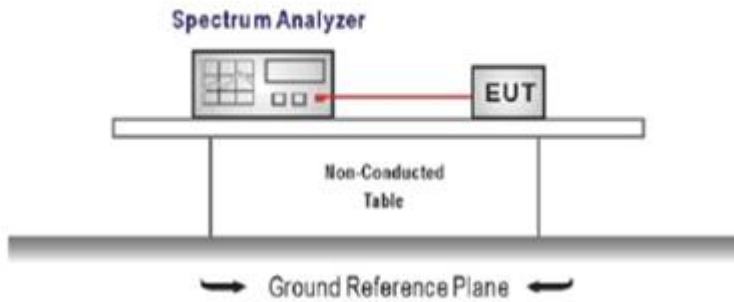

TEST PROCEDURE

1. The transmitter output was connected to the spectrum analyzer through an attenuator, the path loss was compensated to the results for each measurement.
2. Set to the maximum power setting and enable the EUT transmit continuously
3. Use the following spectrum analyzer settings:
 Span = the frequency band of operation
 RBW \geq 1% of the span, VBW \geq RBW
 Sweep = auto, Detector function = peak, Trace = max hold
4. Measure and record the results in the test report.

TEST MODE:

Please refer to the clause 3.3

TEST RESULTS

Passed Not Applicable

| Modulation type | Channel number | Limit | Result |
|-----------------|----------------|--------------|--------|
| GFSK | 79 | ≥ 15.00 | Pass |
| $\pi/4$ DQPSK | 79 | | |
| 8DPSK | 79 | | |

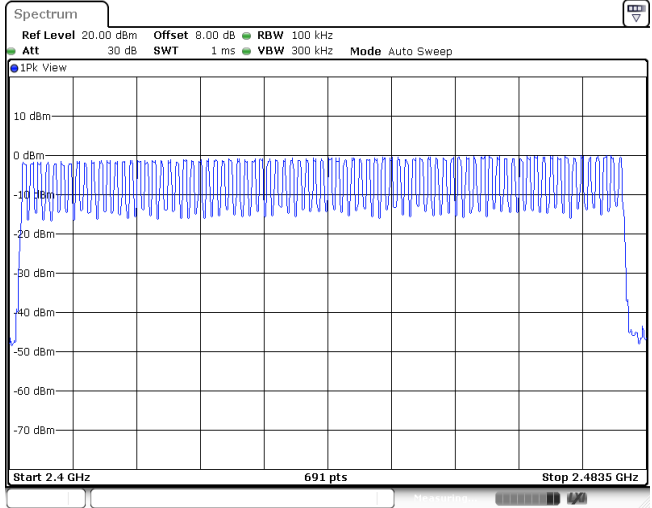
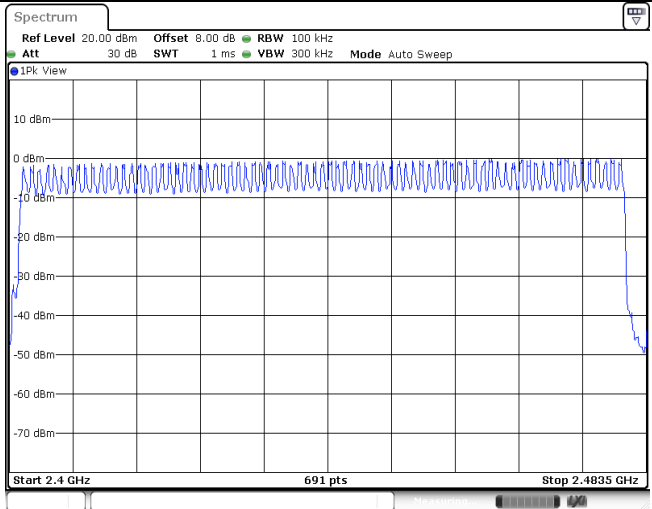
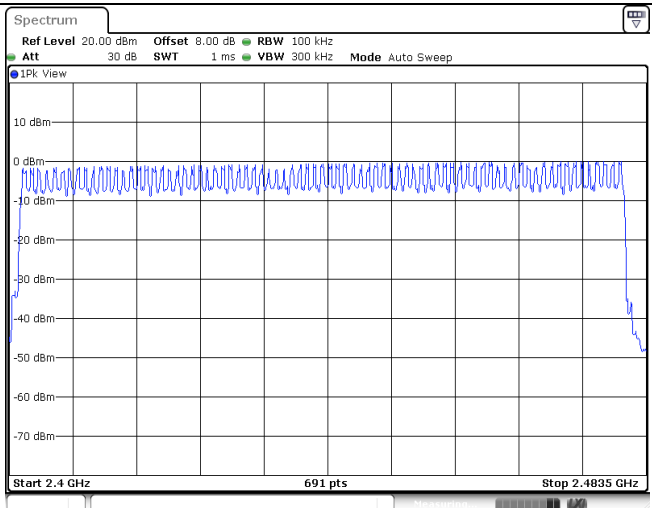
| | |
|--------------------------------|--|
| <p>GFSK</p> |  |
| <p>$\pi/4$DQPSK</p> |  |
| <p>8DPSK</p> |  |

5.7. Dwell Time

LIMIT

FCC CFR Title 47 Part 15 Subpart C Section 15.247 (a)(1):The average time of occupancy on any channel shall not be greater than 0.4 seconds within a pe-riod of 0.4 seconds multiplied by the number of hopping channels employed.

TEST CONFIGURATION

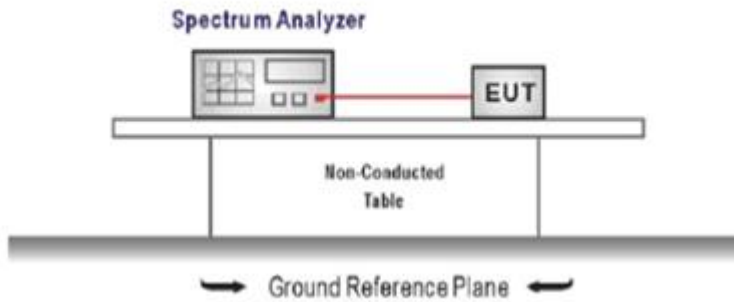

TEST PROCEDURE

1. The transmitter output was connected to the spectrum analyzer through an attenuator, the path loss was compensated to the results for each measurement.
2. Set to the maximum power setting and enable the EUT transmit continuously
3. Use the following spectrum analyzer settings:
 Span = zero span, centered on a hopping channel, RBW= 1 MHz, VBW ≥ RBW
 Sweep = as necessary to capture the entire dwell time per hopping channel,
 Detector function = peak, Trace = max hold
4. Measure and record the results in the test report.

TEST MODE:

Please refer to the clause 3.3

TEST RESULTS

Passed Not Applicable

| Modulation type | Channel | Burst Width [ms/hop/ch] | Total Hops[hop*ch] | Dwell time (Second) | Limit (Second) | Result |
|-----------------|---------|-------------------------|--------------------|---------------------|----------------|--------|
| GFSK | DH1 | 0.37 | 319.00 | 0.12 | ≤ 0.40 | Pass |
| | DH3 | 1.66 | 114.00 | 0.19 | | |
| | DH5 | 2.91 | 69.00 | 0.20 | | |
| π/4DQPSK | 2DH1 | 0.41 | 321.00 | 0.13 | ≤ 0.40 | Pass |
| | 2DH3 | 1.63 | 113.00 | 0.19 | | |
| | 2DH5 | 2.88 | 65.00 | 0.19 | | |
| 8DPSK | 3DH1 | 0.41 | 320.00 | 0.13 | ≤ 0.40 | Pass |
| | 3DH3 | 1.63 | 104.00 | 0.17 | | |
| | 3DH5 | 2.88 | 63.00 | 0.18 | | |

| Modulation Type: | | GFSK |
|---------------------|--|------|
| DH1 Burst width | | |
| DH1 Burst number | | |
| DH3 Burst width | | |

DH3
Burst number

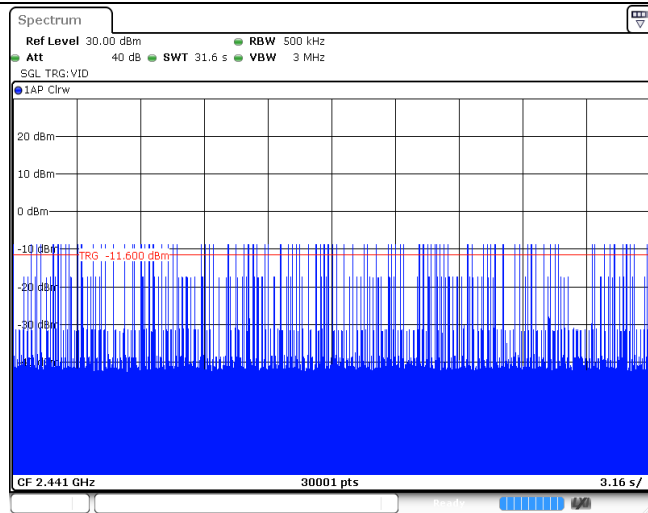

DH5
Burst width

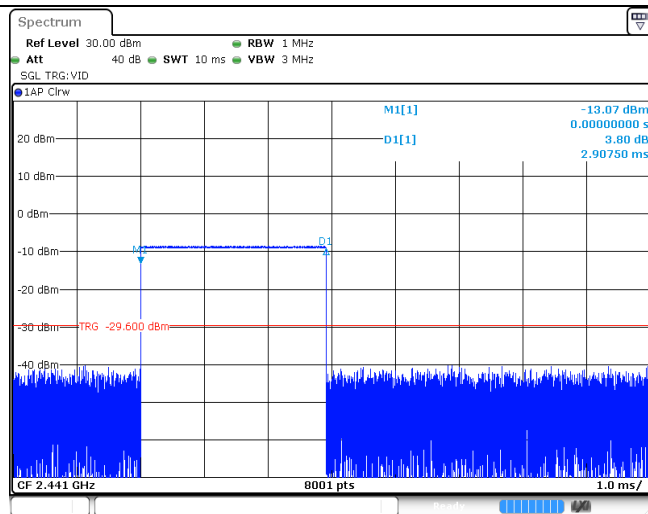

DH5
Burst number

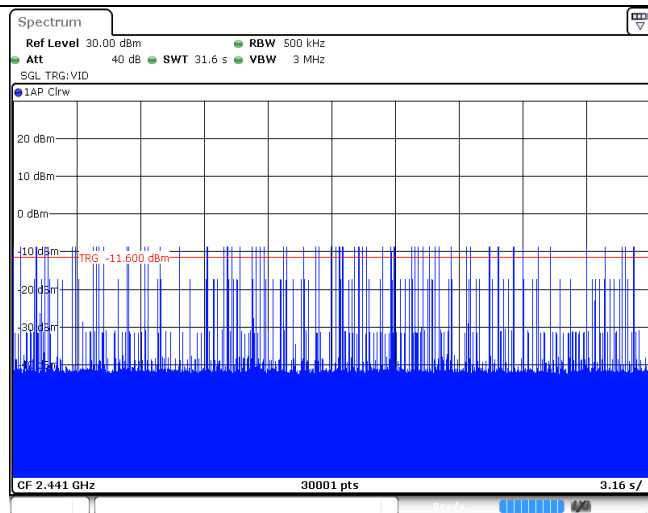

| Modulation Type: $\pi/4$DQPSK | |
|---|--|
| 2DH1 Burst width | |
| 2DH1 Burst number | |
| 2DH3 Burst width | |

2DH3
Burst number

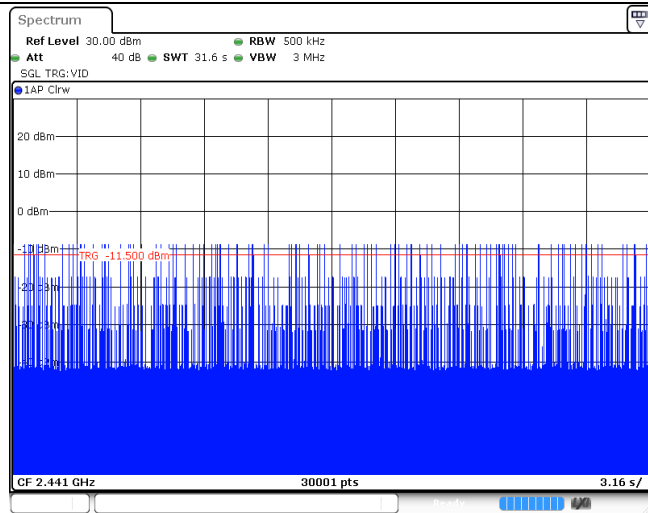

2DH5
Burst width

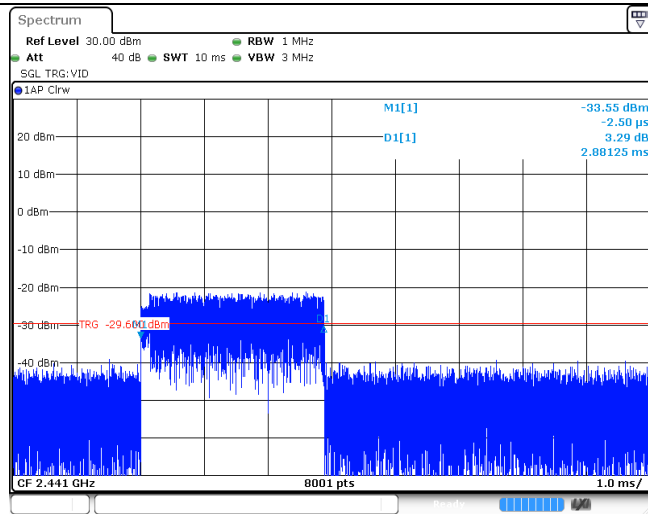

2DH5
Burst number

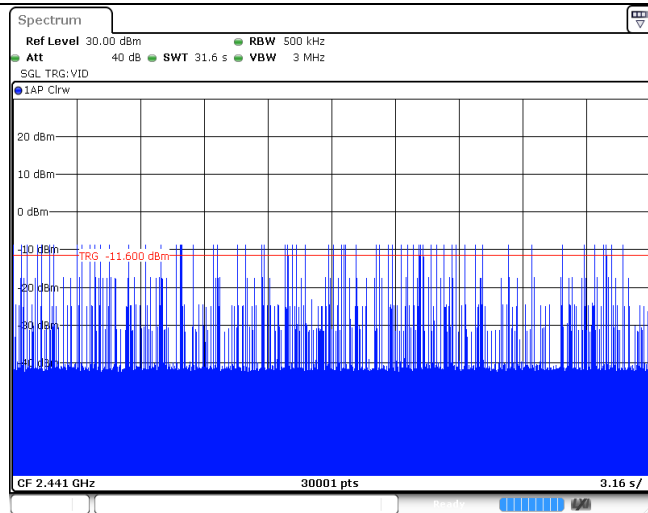

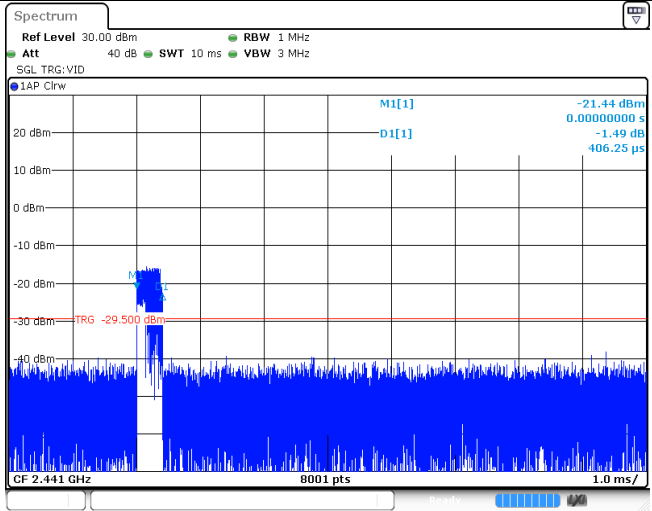
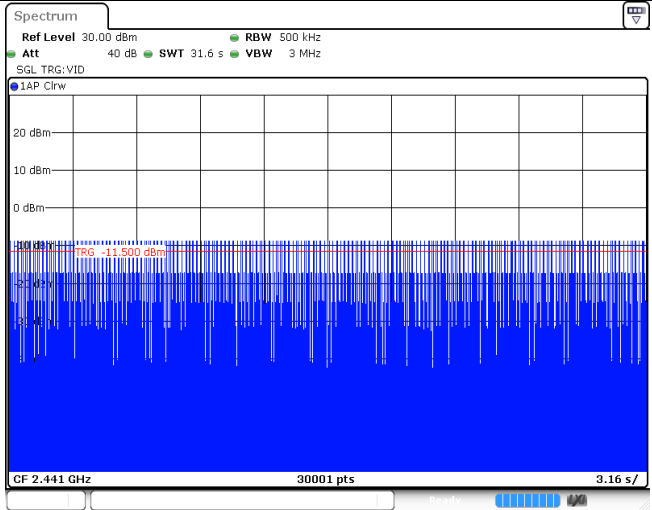
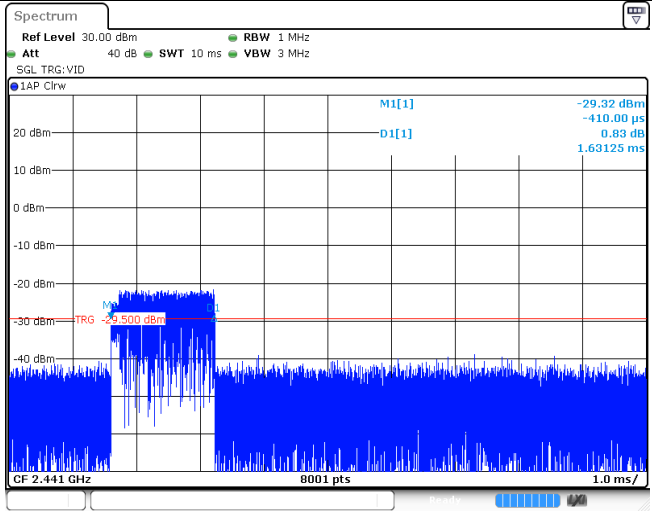
| Modulation Type: 8DPSK | |
|------------------------|--|
| 3DH1 Burst width |  |
| 3DH1 Burst number |  |
| 3DH3 Burst width |  |

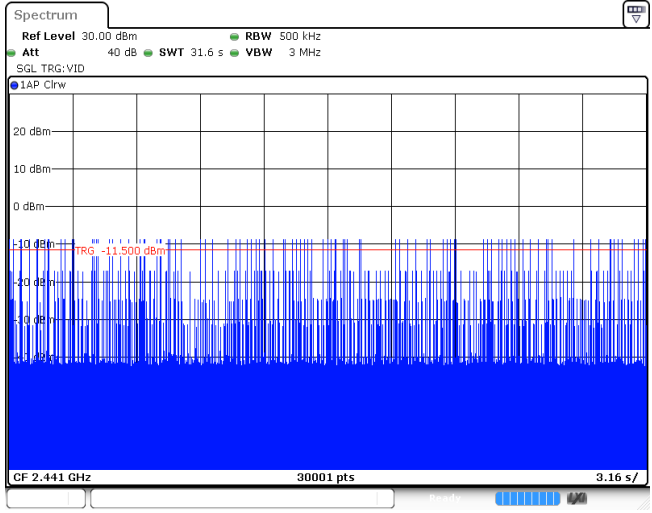
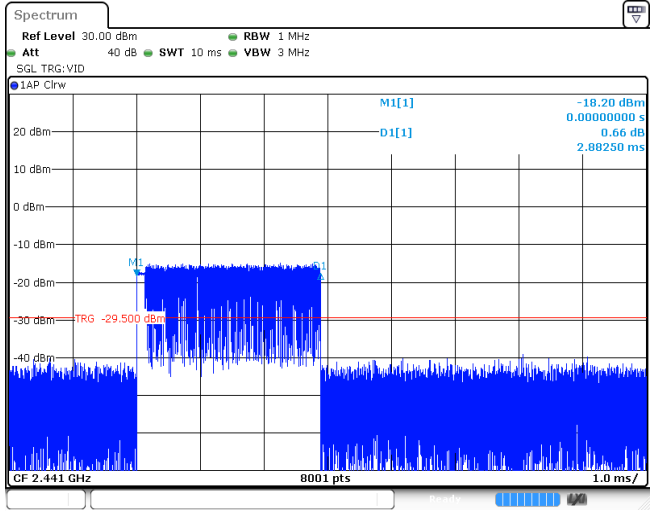
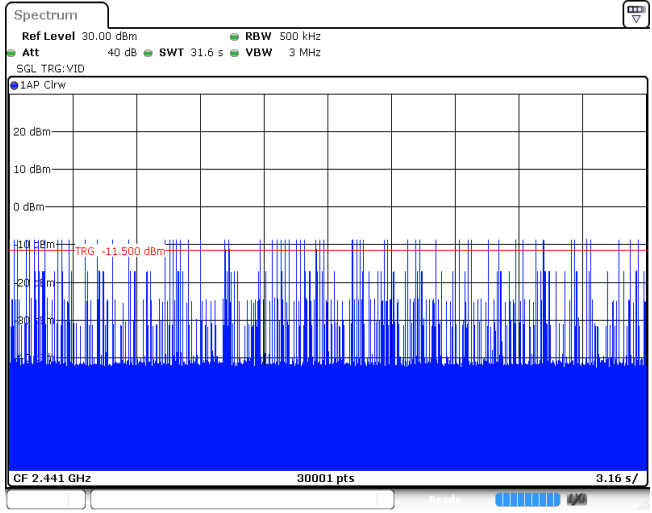
| | |
|------------------------------|--|
| <p>3DH3 Burst number</p> |  <p>Spectrum plot showing a signal at 2.441 GHz. The y-axis is dBm from -50 to 20. The x-axis is time from 0 to 3.16 s. A red trigger line is at -11.500 dBm. Parameters: Ref Level 30.00 dBm, Att 40 dB, RBW 500 kHz, SWT 31.6 s, VBW 3 MHz. 30001 pts.</p> |
| <p>3DH5 Burst width</p> |  <p>Spectrum plot showing a signal at 2.441 GHz. The y-axis is dBm from -40 to 20. The x-axis is time from 0 to 1.0 ms. A red trigger line is at -29.500 dBm. Parameters: Ref Level 30.00 dBm, Att 40 dB, RBW 1 MHz, SWT 10 ms, VBW 3 MHz. 8001 pts. Measurements: M1[1] -18.20 dBm, 0.00000000 s; D1[1] 0.66 dB, 2.88250 ms.</p> |
| <p>3DH5 Burst number</p> |  <p>Spectrum plot showing a signal at 2.441 GHz. The y-axis is dBm from -50 to 20. The x-axis is time from 0 to 3.16 s. A red trigger line is at -11.500 dBm. Parameters: Ref Level 30.00 dBm, Att 40 dB, RBW 500 kHz, SWT 31.6 s, VBW 3 MHz. 30001 pts.</p> |

5.8. Pseudorandom Frequency Hopping Sequence

LIMIT

FCC CFR Title 47 Part 15 Subpart C Section 15.247 (a)(1):Frequency hopping systems shall have hopping channel carrier frequencies separated by a minimum of 25 kHz or the 20 dB bandwidth of the hopping channel, whichever is greater. Alternatively, frequency hopping systems operating in the 2400–2483.5 MHz band may have hopping channel carrier frequencies that are separated by 25 kHz or two-thirds of the 20 dB bandwidth of the hopping channel, whichever is greater, provided the systems operate with an output power no greater than 125 mW. The system shall hop to channel frequencies that are selected at the system hopping rate from a pseudo-randomly ordered list of hopping frequencies. Each frequency must be used equally on the average by each transmitter. The system receivers shall have input bandwidths that match the hopping channel bandwidths of their corresponding transmitters and shall shift frequencies in synchronization with the transmitted signals.

TEST RESULTS

The pseudorandom frequency hopping sequence may be generated in a nine-stage shift register whose 5th and 9th stage outputs are added in a modulo-two addition stage. And the result is fed back to the input of the first stage. The sequence begins with the first one of 9 consecutive ones, for example: the shift register is initialized with nine ones.

- Number of shift register stages: 9
- Length of pseudo-random sequence: $2^9 - 1 = 511$ bits
- Longest sequence of zeros: 8 (non-inverted signal)

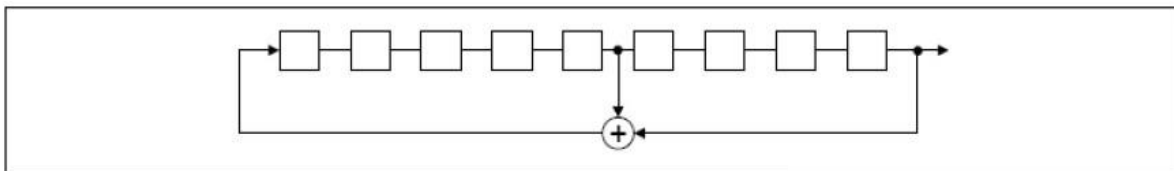

Linear Feedback Shift Register for Generation of the PRBS sequence

An example of pseudorandom frequency hopping sequence as follows:

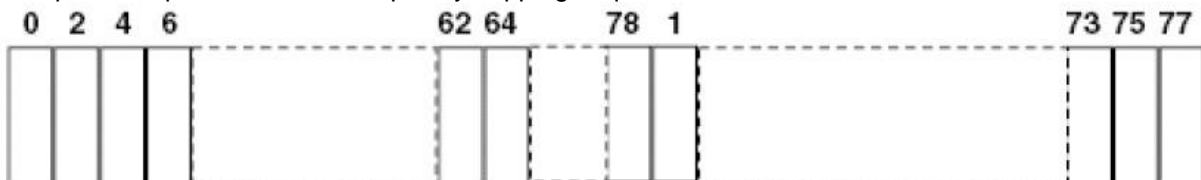

Each frequency used equally on the average by each transmitter. The system receiver has input bandwidths that match the hopping channel bandwidths of their corresponding transmitter and shift frequencies in synchronization with the transmitted signals.

5.9. Restricted band (radiated)

LIMIT

FCC CFR Title 47 Part 15 Subpart C Section 15.247 (d):

In any 100 kHz bandwidth outside the frequency band in which the spread spectrum or digitally modulated intentional radiator is operating, Radiated Emissions which fall in the restricted bands, as defined in §15.205(a), must also comply with the Radiated Emissions limits specified in §15.209(a) (see §15.205(c)).

TEST CONFIGURATION

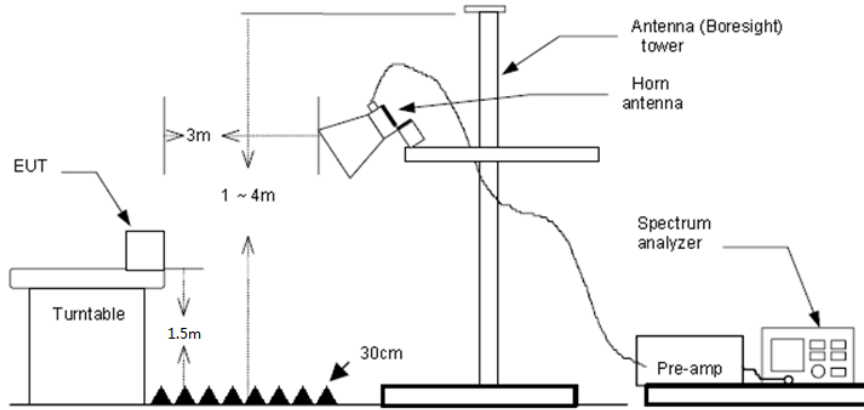

TEST PROCEDURE

1. The EUT was setup and tested according to ANSI C63.10:2013 for compliance to FCC 47CFR 15.247 requirements.
2. The EUT is placed on a turn table which is 1.5 meter above ground. The turn table is rotated 360 degrees to determine the position of the maximum emission level.
3. The EUT was positioned such that the distance from antenna to the EUT was 3 meters.
4. The antenna is scanned from 1 meter to 4 meters to find out the maximum emission level. This is repeated for both horizontal and vertical polarization of the antenna. In order to find the maximum emission, all of the interface cables were manipulated according to ANSI C63.10:2013 on radiated measurement.
5. The receiver set as follow:
 RBW=1 MHz, VBW=3 MHz Peak detector for Peak value
 RBW=1 MHz, VBW=10 Hz Peak detector for Average value.

TEST MODE:

Please refer to the clause 3.3

TEST RESULTS

Passed Not Applicable

Note:

- 1) Final level= Read level + Antenna Factor+ Cable Loss- Preamp Factor
- 2) Have pre-scan all modulation mode, found the GFSK modulation which it was worst case, so only the worst case's data on the test report.
- 3) The peak level is lower than average limit(54 dBuV/m), this data is the too weak instrument of signal is unable to test.

| Test channel: | | | | | CH00 | | | | |
|-----------------|-------------------|-----------------------|-----------------|--------------------|----------------|---------------------|-----------------|--------------|------------|
| Frequency (MHz) | Read Level (dBUV) | Antenna Factor (dB/m) | Cable Loss (dB) | Preamp Factor (dB) | Level (dBUV/m) | Limit Line (dBUV/m) | Over Limit (dB) | Polarization | Test value |
| 2310.00 | 31.34 | 28.05 | 6.62 | 37.59 | 28.42 | 74.00 | -45.58 | Horizontal | Peak |
| 2390.03 | 49.56 | 27.65 | 6.75 | 37.59 | 46.37 | 74.00 | -27.63 | Horizontal | Peak |
| 2310.00 | 32.97 | 28.05 | 6.62 | 37.59 | 30.05 | 74.00 | -43.95 | Vertical | Peak |
| 2389.93 | 40.84 | 27.65 | 6.75 | 37.59 | 37.65 | 74.00 | -36.35 | Vertical | Peak |
| 2310.00 | 20.44 | 28.05 | 6.62 | 37.59 | 17.52 | 54.00 | -36.48 | Horizontal | Average |
| 2376.01 | 21.61 | 27.72 | 6.73 | 37.59 | 18.47 | 54.00 | -35.53 | Horizontal | Average |
| 2390.03 | 20.38 | 27.65 | 6.75 | 37.59 | 17.19 | 54.00 | -36.81 | Horizontal | Average |
| 2310.00 | 20.41 | 28.05 | 6.62 | 37.59 | 17.49 | 54.00 | -36.51 | Vertical | Average |
| 2390.03 | 20.31 | 27.65 | 6.75 | 37.59 | 17.12 | 54.00 | -36.88 | Vertical | Average |

| Test channel: | | | | | CH78 | | | | |
|-----------------|-------------------|-----------------------|-----------------|--------------------|----------------|---------------------|-----------------|--------------|------------|
| Frequency (MHz) | Read Level (dBUV) | Antenna Factor (dB/m) | Cable Loss (dB) | Preamp Factor (dB) | Level (dBUV/m) | Limit Line (dBUV/m) | Over Limit (dB) | Polarization | Test value |
| 2483.52 | 65.98 | 27.26 | 6.83 | 37.59 | 62.48 | 74.00 | -11.52 | Horizontal | Peak |
| 2483.80 | 70.23 | 27.26 | 6.83 | 37.59 | 66.73 | 74.00 | -7.27 | Horizontal | Peak |
| 2500.00 | 35.06 | 27.20 | 6.84 | 37.59 | 31.51 | 74.00 | -42.49 | Horizontal | Peak |
| 2483.50 | 62.74 | 27.26 | 6.83 | 37.59 | 59.24 | 74.00 | -14.76 | Vertical | Peak |
| 2483.82 | 62.82 | 27.26 | 6.83 | 37.59 | 59.32 | 74.00 | -14.68 | Vertical | Peak |
| 2500.00 | 33.38 | 27.20 | 6.84 | 37.59 | 29.83 | 74.00 | -44.17 | Vertical | Peak |
| 2483.50 | 26.79 | 27.26 | 6.83 | 37.59 | 23.29 | 54.00 | -30.71 | Horizontal | Average |
| 2500.00 | 21.13 | 27.20 | 6.84 | 37.59 | 17.58 | 54.00 | -36.42 | Horizontal | Average |
| 2483.50 | 25.74 | 27.26 | 6.83 | 37.59 | 22.24 | 54.00 | -31.76 | Vertical | Average |
| 2500.00 | 20.51 | 27.20 | 6.84 | 37.59 | 16.96 | 54.00 | -37.04 | Vertical | Average |

5.10. Band edge and Spurious Emissions (conducted)

LIMIT

FCC CFR Title 47 Part 15 Subpart C Section 15.247 (d): In any 100 kHz bandwidth outside the frequency band in which the spread spectrum intentional radiator is operating, the radio frequency power that is produced by the intentional radiator shall be at least 20 dB below that in the 100 kHz bandwidth within the band that contains the highest level of the desired power, based on either an RF conducted or a radiated measurement.

TEST CONFIGURATION

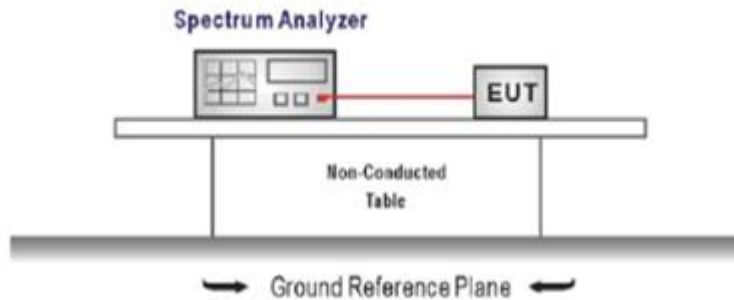

TEST PROCEDURE

1. The transmitter output was connected to the spectrum analyzer through an attenuator, the path loss was compensated to the results for each measurement.
2. Set to the maximum power setting and enable the EUT transmit continuously
3. Use the following spectrum analyzer settings:
RBW = 100 kHz, VBW \geq RBW, scan up through 10th harmonic.
Sweep = auto, Detector function = peak, Trace = max hold
4. Measure and record the results in the test report.

TEST MODE:

Please refer to the clause 3.3

TEST RESULTS

Passed Not Applicable

| Test Item: | Band edge | Modulation type: | GFSK | | | | | | | | | | | | | | | | | | | | | | | | | | | | | | | | | | | | | | | | | | |
|---------------------------------|---|------------------|---------------|------------|----------|-----------------|---------|---------|----------|-----------------|----|---|--|--------------|-----------|--|--|----|---|--|------------|------------|--|--|----|---|--|----------|------------|--|--|----|---|--|---------------|------------|--|--|----|---|--|--------------|------------|--|--|
| <p>CH00 No hopping mode</p> | <p>Spectrum</p> <p>Ref Level 20.00 dBm Offset 8.00 dB RBW 100 kHz Att 30 dB SWT 1.1 ms VBW 300 kHz Mode Auto Sweep Count 500/500</p> <p>1Pk Max</p> <p>10 dBm 0 dBm -10 dBm -20 dBm -30 dBm -40 dBm -50 dBm -60 dBm -70 dBm</p> <p>M1[1] -1.80 dBm 2.402180 GHz M2[1] -46.36 dBm 2.400000 GHz</p> <p>D1 -21.800 dBm</p> <p>Start 2.31 GHz 691 pts Stop 2.405 GHz</p> <table border="1"> <thead> <tr> <th>Type</th> <th>Ref</th> <th>Trc</th> <th>X-value</th> <th>Y-value</th> <th>Function</th> <th>Function Result</th> </tr> </thead> <tbody> <tr> <td>M1</td> <td>1</td> <td></td> <td>2.40218 GHz</td> <td>-1.80 dBm</td> <td></td> <td></td> </tr> <tr> <td>M2</td> <td>1</td> <td></td> <td>2.4 GHz</td> <td>-46.36 dBm</td> <td></td> <td></td> </tr> <tr> <td>M3</td> <td>1</td> <td></td> <td>2.39 GHz</td> <td>-50.72 dBm</td> <td></td> <td></td> </tr> <tr> <td>M4</td> <td>1</td> <td></td> <td>2.31 GHz</td> <td>-51.92 dBm</td> <td></td> <td></td> </tr> <tr> <td>M5</td> <td>1</td> <td></td> <td>2.39729 GHz</td> <td>-34.67 dBm</td> <td></td> <td></td> </tr> </tbody> </table> | | | Type | Ref | Trc | X-value | Y-value | Function | Function Result | M1 | 1 | | 2.40218 GHz | -1.80 dBm | | | M2 | 1 | | 2.4 GHz | -46.36 dBm | | | M3 | 1 | | 2.39 GHz | -50.72 dBm | | | M4 | 1 | | 2.31 GHz | -51.92 dBm | | | M5 | 1 | | 2.39729 GHz | -34.67 dBm | | |
| Type | Ref | Trc | X-value | Y-value | Function | Function Result | | | | | | | | | | | | | | | | | | | | | | | | | | | | | | | | | | | | | | | |
| M1 | 1 | | 2.40218 GHz | -1.80 dBm | | | | | | | | | | | | | | | | | | | | | | | | | | | | | | | | | | | | | | | | | |
| M2 | 1 | | 2.4 GHz | -46.36 dBm | | | | | | | | | | | | | | | | | | | | | | | | | | | | | | | | | | | | | | | | | |
| M3 | 1 | | 2.39 GHz | -50.72 dBm | | | | | | | | | | | | | | | | | | | | | | | | | | | | | | | | | | | | | | | | | |
| M4 | 1 | | 2.31 GHz | -51.92 dBm | | | | | | | | | | | | | | | | | | | | | | | | | | | | | | | | | | | | | | | | | |
| M5 | 1 | | 2.39729 GHz | -34.67 dBm | | | | | | | | | | | | | | | | | | | | | | | | | | | | | | | | | | | | | | | | | |
| <p>CH00 Hopping mode</p> | <p>Spectrum</p> <p>Ref Level 20.00 dBm Offset 8.00 dB RBW 100 kHz Att 30 dB SWT 1.1 ms VBW 300 kHz Mode Auto Sweep Count 500/500</p> <p>1Pk Max</p> <p>10 dBm 0 dBm -10 dBm -20 dBm -30 dBm -40 dBm -50 dBm -60 dBm -70 dBm</p> <p>M1[1] -1.76 dBm 2.404240 GHz M2[1] -46.85 dBm 2.400000 GHz</p> <p>D1 -21.760 dBm</p> <p>Start 2.31 GHz 691 pts Stop 2.405 GHz</p> <table border="1"> <thead> <tr> <th>Type</th> <th>Ref</th> <th>Trc</th> <th>X-value</th> <th>Y-value</th> <th>Function</th> <th>Function Result</th> </tr> </thead> <tbody> <tr> <td>M1</td> <td>1</td> <td></td> <td>2.40424 GHz</td> <td>-1.76 dBm</td> <td></td> <td></td> </tr> <tr> <td>M2</td> <td>1</td> <td></td> <td>2.4 GHz</td> <td>-46.85 dBm</td> <td></td> <td></td> </tr> <tr> <td>M3</td> <td>1</td> <td></td> <td>2.39 GHz</td> <td>-51.49 dBm</td> <td></td> <td></td> </tr> <tr> <td>M4</td> <td>1</td> <td></td> <td>2.31 GHz</td> <td>-50.48 dBm</td> <td></td> <td></td> </tr> <tr> <td>M5</td> <td>1</td> <td></td> <td>2.399906 GHz</td> <td>-46.67 dBm</td> <td></td> <td></td> </tr> </tbody> </table> | | | Type | Ref | Trc | X-value | Y-value | Function | Function Result | M1 | 1 | | 2.40424 GHz | -1.76 dBm | | | M2 | 1 | | 2.4 GHz | -46.85 dBm | | | M3 | 1 | | 2.39 GHz | -51.49 dBm | | | M4 | 1 | | 2.31 GHz | -50.48 dBm | | | M5 | 1 | | 2.399906 GHz | -46.67 dBm | | |
| Type | Ref | Trc | X-value | Y-value | Function | Function Result | | | | | | | | | | | | | | | | | | | | | | | | | | | | | | | | | | | | | | | |
| M1 | 1 | | 2.40424 GHz | -1.76 dBm | | | | | | | | | | | | | | | | | | | | | | | | | | | | | | | | | | | | | | | | | |
| M2 | 1 | | 2.4 GHz | -46.85 dBm | | | | | | | | | | | | | | | | | | | | | | | | | | | | | | | | | | | | | | | | | |
| M3 | 1 | | 2.39 GHz | -51.49 dBm | | | | | | | | | | | | | | | | | | | | | | | | | | | | | | | | | | | | | | | | | |
| M4 | 1 | | 2.31 GHz | -50.48 dBm | | | | | | | | | | | | | | | | | | | | | | | | | | | | | | | | | | | | | | | | | |
| M5 | 1 | | 2.399906 GHz | -46.67 dBm | | | | | | | | | | | | | | | | | | | | | | | | | | | | | | | | | | | | | | | | | |
| <p>CH78 No hopping mode</p> | <p>Spectrum</p> <p>Ref Level 20.00 dBm Offset 8.00 dB RBW 100 kHz Att 30 dB SWT 56.9 µs VBW 300 kHz Mode Auto FFT Count 500/500</p> <p>1Pk Max</p> <p>10 dBm 0 dBm -10 dBm -20 dBm -30 dBm -40 dBm -50 dBm -60 dBm -70 dBm</p> <p>M1[1] -0.01 dBm 2.4801810 GHz M2[1] -47.22 dBm 2.4835000 GHz</p> <p>D1 -20.010 dBm</p> <p>Start 2.478 GHz 691 pts Stop 2.5 GHz</p> <table border="1"> <thead> <tr> <th>Type</th> <th>Ref</th> <th>Trc</th> <th>X-value</th> <th>Y-value</th> <th>Function</th> <th>Function Result</th> </tr> </thead> <tbody> <tr> <td>M1</td> <td>1</td> <td></td> <td>2.480181 GHz</td> <td>-0.01 dBm</td> <td></td> <td></td> </tr> <tr> <td>M2</td> <td>1</td> <td></td> <td>2.4835 GHz</td> <td>-47.22 dBm</td> <td></td> <td></td> </tr> <tr> <td>M3</td> <td>1</td> <td></td> <td>2.5 GHz</td> <td>-52.51 dBm</td> <td></td> <td></td> </tr> <tr> <td>M4</td> <td>1</td> <td></td> <td>2.4845691 GHz</td> <td>-46.52 dBm</td> <td></td> <td></td> </tr> </tbody> </table> | | | Type | Ref | Trc | X-value | Y-value | Function | Function Result | M1 | 1 | | 2.480181 GHz | -0.01 dBm | | | M2 | 1 | | 2.4835 GHz | -47.22 dBm | | | M3 | 1 | | 2.5 GHz | -52.51 dBm | | | M4 | 1 | | 2.4845691 GHz | -46.52 dBm | | | | | | | | | |
| Type | Ref | Trc | X-value | Y-value | Function | Function Result | | | | | | | | | | | | | | | | | | | | | | | | | | | | | | | | | | | | | | | |
| M1 | 1 | | 2.480181 GHz | -0.01 dBm | | | | | | | | | | | | | | | | | | | | | | | | | | | | | | | | | | | | | | | | | |
| M2 | 1 | | 2.4835 GHz | -47.22 dBm | | | | | | | | | | | | | | | | | | | | | | | | | | | | | | | | | | | | | | | | | |
| M3 | 1 | | 2.5 GHz | -52.51 dBm | | | | | | | | | | | | | | | | | | | | | | | | | | | | | | | | | | | | | | | | | |
| M4 | 1 | | 2.4845691 GHz | -46.52 dBm | | | | | | | | | | | | | | | | | | | | | | | | | | | | | | | | | | | | | | | | | |

CH78
Hopping mode

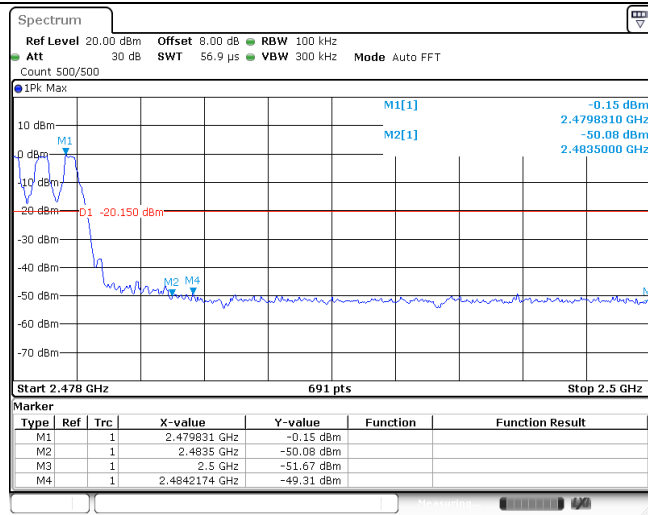

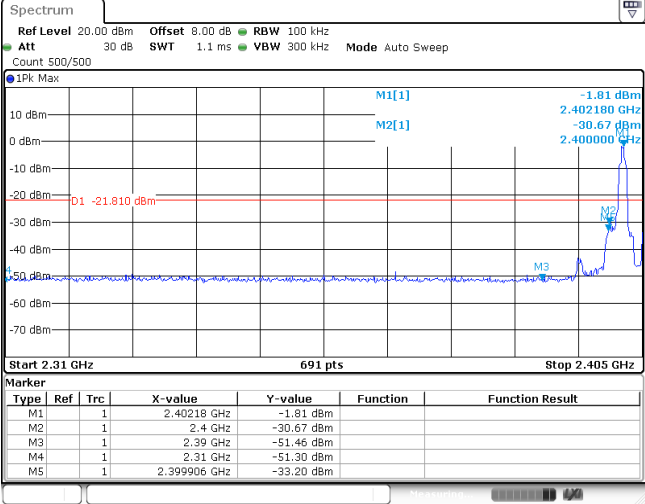
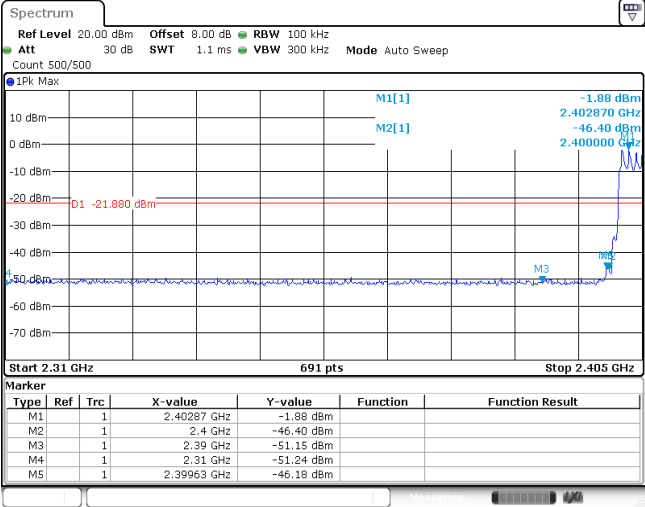
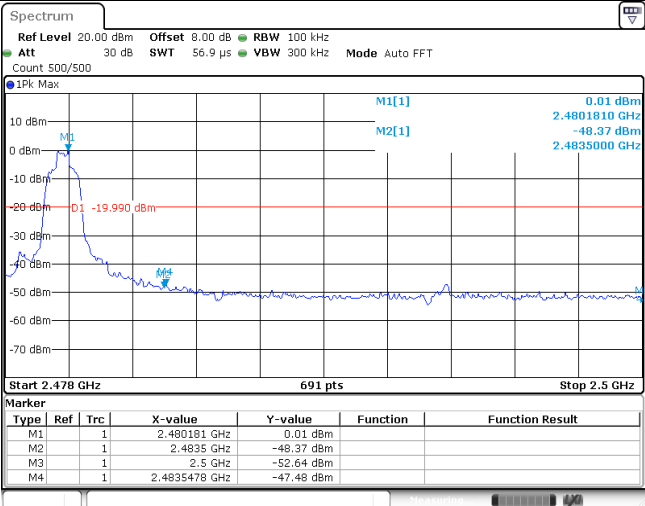
| Test Item: | Band edge | Modulation type: | $\pi/4$ DQPSK | | | | | | | | | | | | | | | | | | | | | | | | | | | | | | | | | | | | | | | | | | |
|---------------------------------|---|------------------|---------------|------------|----------|-----------------|---------|---------|----------|-----------------|----|---|--|--------------|-----------|--|--|----|---|--|------------|------------|--|--|----|---|--|----------|------------|--|--|----|---|--|---------------|------------|--|--|----|---|--|--------------|------------|--|--|
| <p>CH00 No hopping mode</p> |  <p>Spectrum</p> <p>Ref Level 20.00 dBm Offset 8.00 dB RBW 100 kHz Att 30 dB SWT 1.1 ms VBW 300 kHz Mode Auto Sweep Count 500/500</p> <p>1Pk Max</p> <p>M1[1] -1.81 dBm 2.402180 GHz M2[1] -30.67 dBm 2.400000 GHz D1 -21.810 dBm</p> <p>Start 2.31 GHz 691 pts Stop 2.405 GHz</p> <table border="1"> <thead> <tr> <th>Type</th> <th>Ref</th> <th>Trc</th> <th>X-value</th> <th>Y-value</th> <th>Function</th> <th>Function Result</th> </tr> </thead> <tbody> <tr> <td>M1</td> <td>1</td> <td></td> <td>2.40218 GHz</td> <td>-1.81 dBm</td> <td></td> <td></td> </tr> <tr> <td>M2</td> <td>1</td> <td></td> <td>2.4 GHz</td> <td>-30.67 dBm</td> <td></td> <td></td> </tr> <tr> <td>M3</td> <td>1</td> <td></td> <td>2.39 GHz</td> <td>-51.46 dBm</td> <td></td> <td></td> </tr> <tr> <td>M4</td> <td>1</td> <td></td> <td>2.31 GHz</td> <td>-51.30 dBm</td> <td></td> <td></td> </tr> <tr> <td>M5</td> <td>1</td> <td></td> <td>2.399906 GHz</td> <td>-33.20 dBm</td> <td></td> <td></td> </tr> </tbody> </table> | | | Type | Ref | Trc | X-value | Y-value | Function | Function Result | M1 | 1 | | 2.40218 GHz | -1.81 dBm | | | M2 | 1 | | 2.4 GHz | -30.67 dBm | | | M3 | 1 | | 2.39 GHz | -51.46 dBm | | | M4 | 1 | | 2.31 GHz | -51.30 dBm | | | M5 | 1 | | 2.399906 GHz | -33.20 dBm | | |
| Type | Ref | Trc | X-value | Y-value | Function | Function Result | | | | | | | | | | | | | | | | | | | | | | | | | | | | | | | | | | | | | | | |
| M1 | 1 | | 2.40218 GHz | -1.81 dBm | | | | | | | | | | | | | | | | | | | | | | | | | | | | | | | | | | | | | | | | | |
| M2 | 1 | | 2.4 GHz | -30.67 dBm | | | | | | | | | | | | | | | | | | | | | | | | | | | | | | | | | | | | | | | | | |
| M3 | 1 | | 2.39 GHz | -51.46 dBm | | | | | | | | | | | | | | | | | | | | | | | | | | | | | | | | | | | | | | | | | |
| M4 | 1 | | 2.31 GHz | -51.30 dBm | | | | | | | | | | | | | | | | | | | | | | | | | | | | | | | | | | | | | | | | | |
| M5 | 1 | | 2.399906 GHz | -33.20 dBm | | | | | | | | | | | | | | | | | | | | | | | | | | | | | | | | | | | | | | | | | |
| <p>CH00 Hopping mode</p> |  <p>Spectrum</p> <p>Ref Level 20.00 dBm Offset 8.00 dB RBW 100 kHz Att 30 dB SWT 1.1 ms VBW 300 kHz Mode Auto Sweep Count 500/500</p> <p>1Pk Max</p> <p>M1[1] -1.88 dBm 2.402870 GHz M2[1] -46.40 dBm 2.400000 GHz D1 -21.880 dBm</p> <p>Start 2.31 GHz 691 pts Stop 2.405 GHz</p> <table border="1"> <thead> <tr> <th>Type</th> <th>Ref</th> <th>Trc</th> <th>X-value</th> <th>Y-value</th> <th>Function</th> <th>Function Result</th> </tr> </thead> <tbody> <tr> <td>M1</td> <td>1</td> <td></td> <td>2.40287 GHz</td> <td>-1.88 dBm</td> <td></td> <td></td> </tr> <tr> <td>M2</td> <td>1</td> <td></td> <td>2.4 GHz</td> <td>-46.40 dBm</td> <td></td> <td></td> </tr> <tr> <td>M3</td> <td>1</td> <td></td> <td>2.39 GHz</td> <td>-51.15 dBm</td> <td></td> <td></td> </tr> <tr> <td>M4</td> <td>1</td> <td></td> <td>2.31 GHz</td> <td>-51.24 dBm</td> <td></td> <td></td> </tr> <tr> <td>M5</td> <td>1</td> <td></td> <td>2.39963 GHz</td> <td>-46.18 dBm</td> <td></td> <td></td> </tr> </tbody> </table> | | | Type | Ref | Trc | X-value | Y-value | Function | Function Result | M1 | 1 | | 2.40287 GHz | -1.88 dBm | | | M2 | 1 | | 2.4 GHz | -46.40 dBm | | | M3 | 1 | | 2.39 GHz | -51.15 dBm | | | M4 | 1 | | 2.31 GHz | -51.24 dBm | | | M5 | 1 | | 2.39963 GHz | -46.18 dBm | | |
| Type | Ref | Trc | X-value | Y-value | Function | Function Result | | | | | | | | | | | | | | | | | | | | | | | | | | | | | | | | | | | | | | | |
| M1 | 1 | | 2.40287 GHz | -1.88 dBm | | | | | | | | | | | | | | | | | | | | | | | | | | | | | | | | | | | | | | | | | |
| M2 | 1 | | 2.4 GHz | -46.40 dBm | | | | | | | | | | | | | | | | | | | | | | | | | | | | | | | | | | | | | | | | | |
| M3 | 1 | | 2.39 GHz | -51.15 dBm | | | | | | | | | | | | | | | | | | | | | | | | | | | | | | | | | | | | | | | | | |
| M4 | 1 | | 2.31 GHz | -51.24 dBm | | | | | | | | | | | | | | | | | | | | | | | | | | | | | | | | | | | | | | | | | |
| M5 | 1 | | 2.39963 GHz | -46.18 dBm | | | | | | | | | | | | | | | | | | | | | | | | | | | | | | | | | | | | | | | | | |
| <p>CH78 No hopping mode</p> |  <p>Spectrum</p> <p>Ref Level 20.00 dBm Offset 8.00 dB RBW 100 kHz Att 30 dB SWT 56.9 μs VBW 300 kHz Mode Auto FFT Count 500/500</p> <p>1Pk Max</p> <p>M1[1] 0.01 dBm 2.4801810 GHz M2[1] -48.37 dBm 2.4835000 GHz D1 -19.990 dBm</p> <p>Start 2.478 GHz 691 pts Stop 2.5 GHz</p> <table border="1"> <thead> <tr> <th>Type</th> <th>Ref</th> <th>Trc</th> <th>X-value</th> <th>Y-value</th> <th>Function</th> <th>Function Result</th> </tr> </thead> <tbody> <tr> <td>M1</td> <td>1</td> <td></td> <td>2.480181 GHz</td> <td>0.01 dBm</td> <td></td> <td></td> </tr> <tr> <td>M2</td> <td>1</td> <td></td> <td>2.4835 GHz</td> <td>-48.37 dBm</td> <td></td> <td></td> </tr> <tr> <td>M3</td> <td>1</td> <td></td> <td>2.5 GHz</td> <td>-52.64 dBm</td> <td></td> <td></td> </tr> <tr> <td>M4</td> <td>1</td> <td></td> <td>2.4835478 GHz</td> <td>-47.48 dBm</td> <td></td> <td></td> </tr> </tbody> </table> | | | Type | Ref | Trc | X-value | Y-value | Function | Function Result | M1 | 1 | | 2.480181 GHz | 0.01 dBm | | | M2 | 1 | | 2.4835 GHz | -48.37 dBm | | | M3 | 1 | | 2.5 GHz | -52.64 dBm | | | M4 | 1 | | 2.4835478 GHz | -47.48 dBm | | | | | | | | | |
| Type | Ref | Trc | X-value | Y-value | Function | Function Result | | | | | | | | | | | | | | | | | | | | | | | | | | | | | | | | | | | | | | | |
| M1 | 1 | | 2.480181 GHz | 0.01 dBm | | | | | | | | | | | | | | | | | | | | | | | | | | | | | | | | | | | | | | | | | |
| M2 | 1 | | 2.4835 GHz | -48.37 dBm | | | | | | | | | | | | | | | | | | | | | | | | | | | | | | | | | | | | | | | | | |
| M3 | 1 | | 2.5 GHz | -52.64 dBm | | | | | | | | | | | | | | | | | | | | | | | | | | | | | | | | | | | | | | | | | |
| M4 | 1 | | 2.4835478 GHz | -47.48 dBm | | | | | | | | | | | | | | | | | | | | | | | | | | | | | | | | | | | | | | | | | |

CH78
Hopping mode

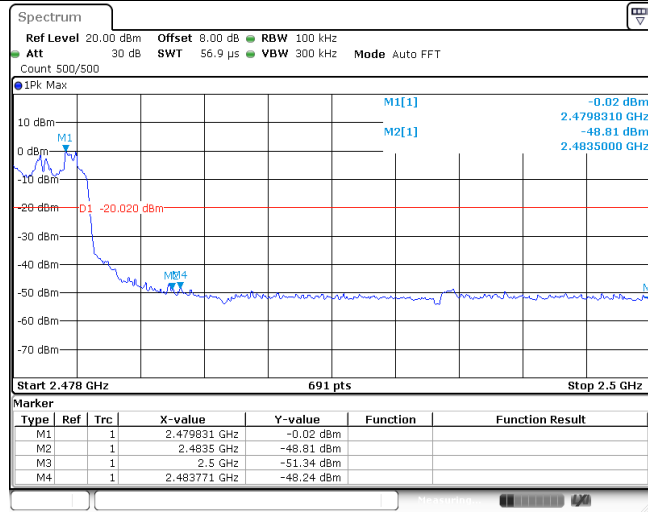

| Test Item: | Band edge | Modulation type: | 8DPSK | | | | | | | | | | | | | | | | | | | | | | | | | | | | | | | | | | | | | | | | | | |
|---------------------------------|--|------------------|---------------|------------|----------|-----------------|---------|---------|----------|-----------------|----|---|--|--------------|-----------|--|--|----|---|--|------------|------------|--|--|----|---|--|----------|------------|--|--|----|---|--|---------------|------------|--|--|----|---|--|-------------|------------|--|--|
| <p>CH00 No hopping mode</p> | <p>Spectrum</p> <p>Ref Level 20.00 dBm Offset 8.00 dB RBW 100 kHz Att 30 dB SWT 1.1 ms VBW 300 kHz Mode Auto Sweep Count 500/500</p> <p>1Pk Max</p> <p>10 dBm 0 dBm -10 dBm -20 dBm -30 dBm -40 dBm -50 dBm -60 dBm -70 dBm</p> <p>M1[1] -1.83 dBm 2.402180 GHz M2[1] -44.90 dBm 2.400000 GHz D1 -21.930 dBm M3 M4 M5</p> <p>Start 2.31 GHz 691 pts Stop 2.405 GHz</p> <table border="1"> <thead> <tr> <th>Type</th> <th>Ref</th> <th>Trc</th> <th>X-value</th> <th>Y-value</th> <th>Function</th> <th>Function Result</th> </tr> </thead> <tbody> <tr> <td>M1</td> <td>1</td> <td></td> <td>2.40218 GHz</td> <td>-1.83 dBm</td> <td></td> <td></td> </tr> <tr> <td>M2</td> <td>1</td> <td></td> <td>2.4 GHz</td> <td>-49.21 dBm</td> <td></td> <td></td> </tr> <tr> <td>M3</td> <td>1</td> <td></td> <td>2.31 GHz</td> <td>-52.07 dBm</td> <td></td> <td></td> </tr> <tr> <td>M4</td> <td>1</td> <td></td> <td>2.31 GHz</td> <td>-52.07 dBm</td> <td></td> <td></td> </tr> <tr> <td>M5</td> <td>1</td> <td></td> <td>2.39963 GHz</td> <td>-43.67 dBm</td> <td></td> <td></td> </tr> </tbody> </table> | | | Type | Ref | Trc | X-value | Y-value | Function | Function Result | M1 | 1 | | 2.40218 GHz | -1.83 dBm | | | M2 | 1 | | 2.4 GHz | -49.21 dBm | | | M3 | 1 | | 2.31 GHz | -52.07 dBm | | | M4 | 1 | | 2.31 GHz | -52.07 dBm | | | M5 | 1 | | 2.39963 GHz | -43.67 dBm | | |
| Type | Ref | Trc | X-value | Y-value | Function | Function Result | | | | | | | | | | | | | | | | | | | | | | | | | | | | | | | | | | | | | | | |
| M1 | 1 | | 2.40218 GHz | -1.83 dBm | | | | | | | | | | | | | | | | | | | | | | | | | | | | | | | | | | | | | | | | | |
| M2 | 1 | | 2.4 GHz | -49.21 dBm | | | | | | | | | | | | | | | | | | | | | | | | | | | | | | | | | | | | | | | | | |
| M3 | 1 | | 2.31 GHz | -52.07 dBm | | | | | | | | | | | | | | | | | | | | | | | | | | | | | | | | | | | | | | | | | |
| M4 | 1 | | 2.31 GHz | -52.07 dBm | | | | | | | | | | | | | | | | | | | | | | | | | | | | | | | | | | | | | | | | | |
| M5 | 1 | | 2.39963 GHz | -43.67 dBm | | | | | | | | | | | | | | | | | | | | | | | | | | | | | | | | | | | | | | | | | |
| <p>CH00 Hopping mode</p> | <p>Spectrum</p> <p>Ref Level 20.00 dBm Offset 8.00 dB RBW 100 kHz Att 30 dB SWT 1.1 ms VBW 300 kHz Mode Auto Sweep Count 500/500</p> <p>1Pk Max</p> <p>10 dBm 0 dBm -10 dBm -20 dBm -30 dBm -40 dBm -50 dBm -60 dBm -70 dBm</p> <p>M1[1] -1.94 dBm 2.403280 GHz M2[1] -47.26 dBm 2.400000 GHz D1 -21.940 dBm M3 M4 M5</p> <p>Start 2.31 GHz 691 pts Stop 2.405 GHz</p> <table border="1"> <thead> <tr> <th>Type</th> <th>Ref</th> <th>Trc</th> <th>X-value</th> <th>Y-value</th> <th>Function</th> <th>Function Result</th> </tr> </thead> <tbody> <tr> <td>M1</td> <td>1</td> <td></td> <td>2.40328 GHz</td> <td>-1.94 dBm</td> <td></td> <td></td> </tr> <tr> <td>M2</td> <td>1</td> <td></td> <td>2.4 GHz</td> <td>-47.26 dBm</td> <td></td> <td></td> </tr> <tr> <td>M3</td> <td>1</td> <td></td> <td>2.39 GHz</td> <td>-51.56 dBm</td> <td></td> <td></td> </tr> <tr> <td>M4</td> <td>1</td> <td></td> <td>2.31 GHz</td> <td>-50.80 dBm</td> <td></td> <td></td> </tr> <tr> <td>M5</td> <td>1</td> <td></td> <td>2.39963 GHz</td> <td>-44.15 dBm</td> <td></td> <td></td> </tr> </tbody> </table> | | | Type | Ref | Trc | X-value | Y-value | Function | Function Result | M1 | 1 | | 2.40328 GHz | -1.94 dBm | | | M2 | 1 | | 2.4 GHz | -47.26 dBm | | | M3 | 1 | | 2.39 GHz | -51.56 dBm | | | M4 | 1 | | 2.31 GHz | -50.80 dBm | | | M5 | 1 | | 2.39963 GHz | -44.15 dBm | | |
| Type | Ref | Trc | X-value | Y-value | Function | Function Result | | | | | | | | | | | | | | | | | | | | | | | | | | | | | | | | | | | | | | | |
| M1 | 1 | | 2.40328 GHz | -1.94 dBm | | | | | | | | | | | | | | | | | | | | | | | | | | | | | | | | | | | | | | | | | |
| M2 | 1 | | 2.4 GHz | -47.26 dBm | | | | | | | | | | | | | | | | | | | | | | | | | | | | | | | | | | | | | | | | | |
| M3 | 1 | | 2.39 GHz | -51.56 dBm | | | | | | | | | | | | | | | | | | | | | | | | | | | | | | | | | | | | | | | | | |
| M4 | 1 | | 2.31 GHz | -50.80 dBm | | | | | | | | | | | | | | | | | | | | | | | | | | | | | | | | | | | | | | | | | |
| M5 | 1 | | 2.39963 GHz | -44.15 dBm | | | | | | | | | | | | | | | | | | | | | | | | | | | | | | | | | | | | | | | | | |
| <p>CH78 No hopping mode</p> | <p>Spectrum</p> <p>Ref Level 20.00 dBm Offset 8.00 dB RBW 100 kHz Att 30 dB SWT 56.9 µs VBW 300 kHz Mode Auto FFT Count 500/500</p> <p>1Pk Max</p> <p>10 dBm 0 dBm -10 dBm -20 dBm -30 dBm -40 dBm -50 dBm -60 dBm -70 dBm</p> <p>M1[1] 0.01 dBm 2.4801810 GHz M2[1] -46.29 dBm 2.4835000 GHz D1 -19.990 dBm M3 M4</p> <p>Start 2.478 GHz 691 pts Stop 2.5 GHz</p> <table border="1"> <thead> <tr> <th>Type</th> <th>Ref</th> <th>Trc</th> <th>X-value</th> <th>Y-value</th> <th>Function</th> <th>Function Result</th> </tr> </thead> <tbody> <tr> <td>M1</td> <td>1</td> <td></td> <td>2.480181 GHz</td> <td>0.01 dBm</td> <td></td> <td></td> </tr> <tr> <td>M2</td> <td>1</td> <td></td> <td>2.4835 GHz</td> <td>-46.29 dBm</td> <td></td> <td></td> </tr> <tr> <td>M3</td> <td>1</td> <td></td> <td>2.5 GHz</td> <td>-50.51 dBm</td> <td></td> <td></td> </tr> <tr> <td>M4</td> <td>1</td> <td></td> <td>2.4856841 GHz</td> <td>-40.74 dBm</td> <td></td> <td></td> </tr> </tbody> </table> | | | Type | Ref | Trc | X-value | Y-value | Function | Function Result | M1 | 1 | | 2.480181 GHz | 0.01 dBm | | | M2 | 1 | | 2.4835 GHz | -46.29 dBm | | | M3 | 1 | | 2.5 GHz | -50.51 dBm | | | M4 | 1 | | 2.4856841 GHz | -40.74 dBm | | | | | | | | | |
| Type | Ref | Trc | X-value | Y-value | Function | Function Result | | | | | | | | | | | | | | | | | | | | | | | | | | | | | | | | | | | | | | | |
| M1 | 1 | | 2.480181 GHz | 0.01 dBm | | | | | | | | | | | | | | | | | | | | | | | | | | | | | | | | | | | | | | | | | |
| M2 | 1 | | 2.4835 GHz | -46.29 dBm | | | | | | | | | | | | | | | | | | | | | | | | | | | | | | | | | | | | | | | | | |
| M3 | 1 | | 2.5 GHz | -50.51 dBm | | | | | | | | | | | | | | | | | | | | | | | | | | | | | | | | | | | | | | | | | |
| M4 | 1 | | 2.4856841 GHz | -40.74 dBm | | | | | | | | | | | | | | | | | | | | | | | | | | | | | | | | | | | | | | | | | |

CH78
Hoppig mode

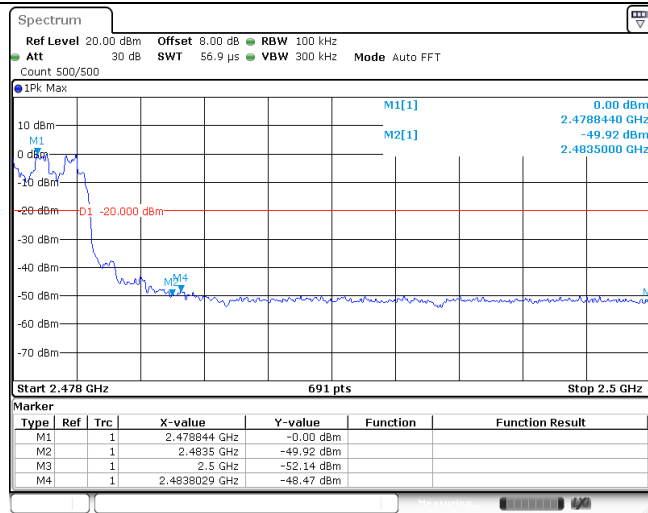

| Test Item: | SE | Modulation type: | GFSK |
|---------------------------------|----|------------------|------|
| <p>CH00 Reference level</p> | | | |
| <p>CH00 30MHz~1000MHz</p> | | | |
| <p>CH00 1GHz~26GHz</p> | | | |

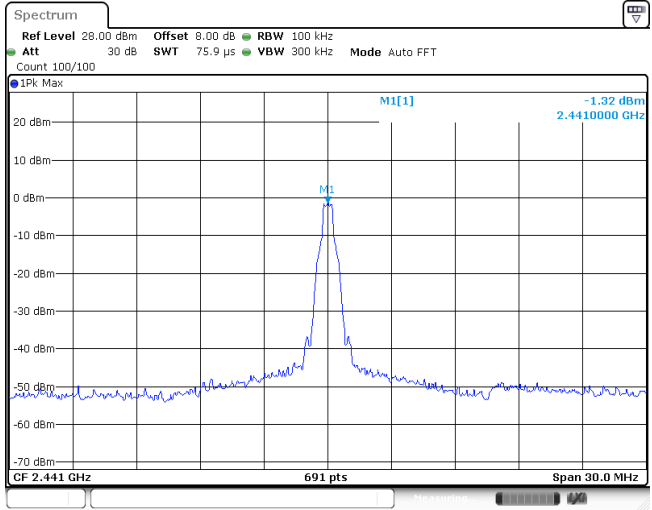
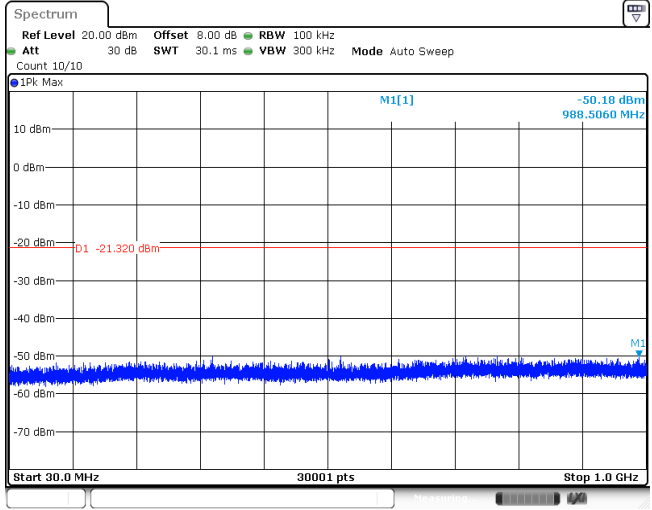
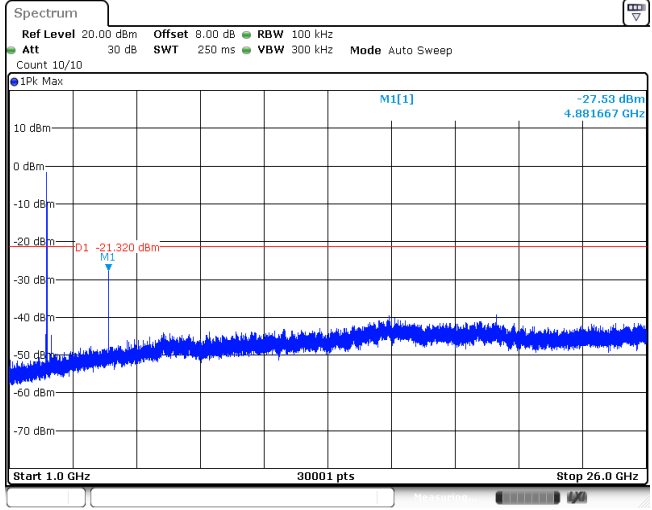
| | |
|---------------------------------|--|
| <p>CH39 Reference level</p> |  |
| <p>CH39 30MHz~1000MHz</p> |  |
| <p>CH39 1GHz~26GHz</p> |  |

CH78
Reference level

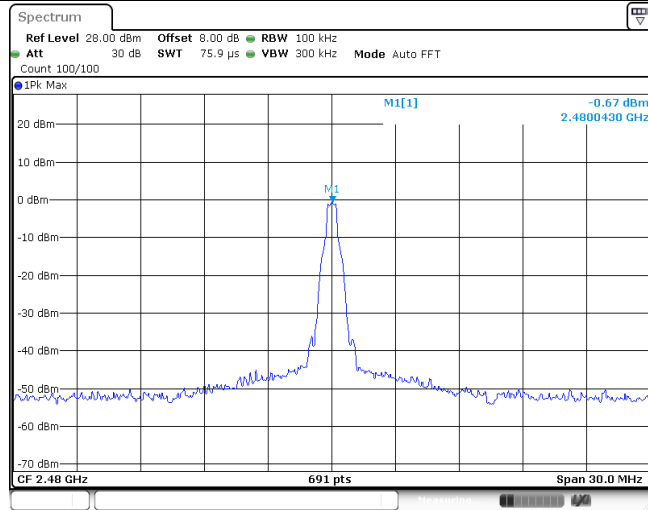

CH78
30MHz~1000MHz

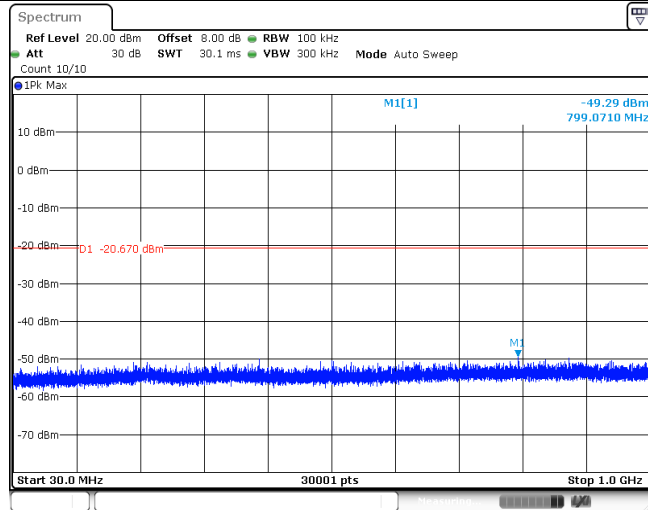

CH78
1GHz~26GHz

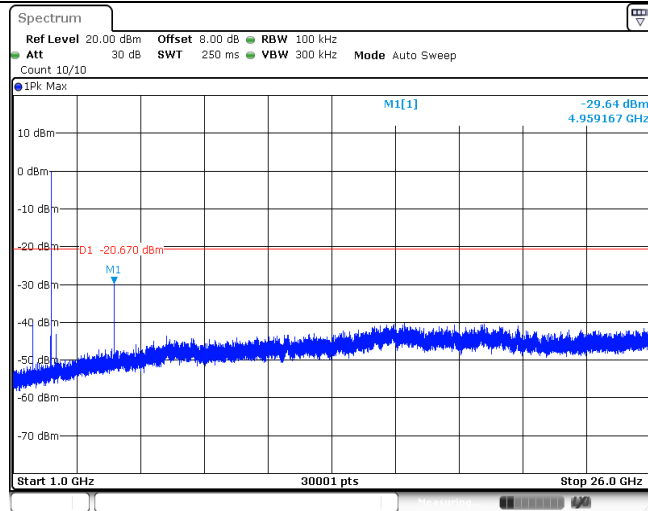

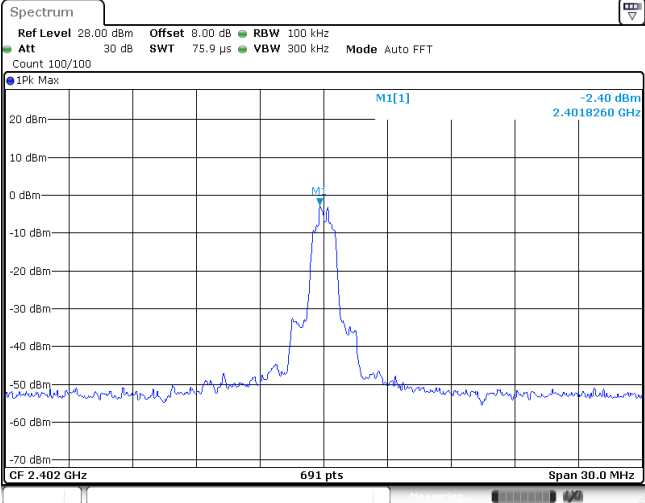
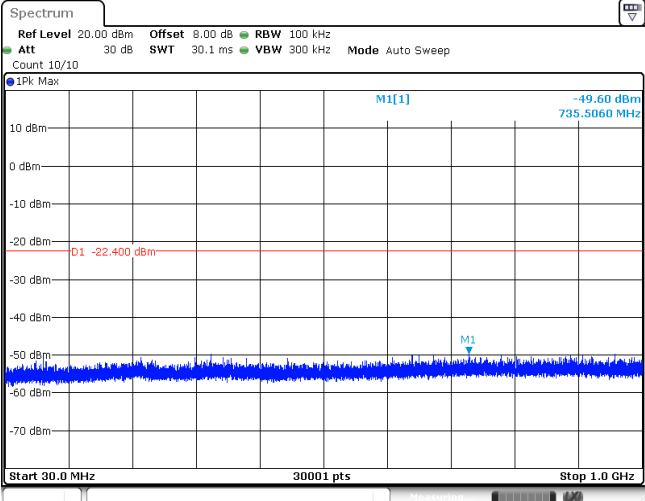
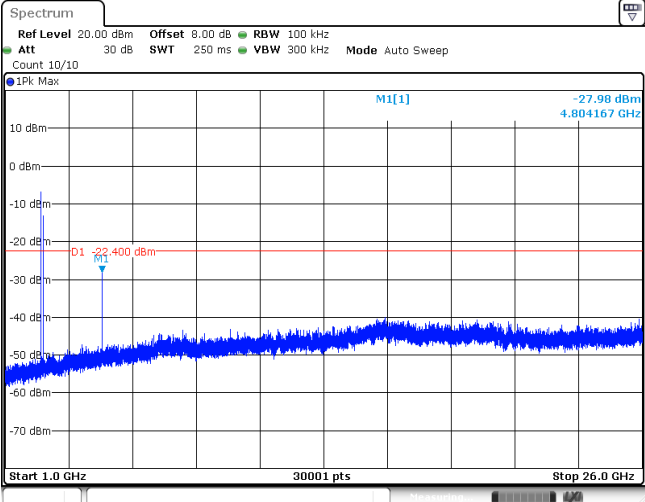
| Test Item: | SE | Modulation type: | π /4DQPSK |
|-------------------------|--|------------------|---------------|
| CH00 Reference level |  | | |
| CH00 30MHz~1000MHz |  | | |
| CH00 1GHz~26GHz |  | | |

CH39
Reference level

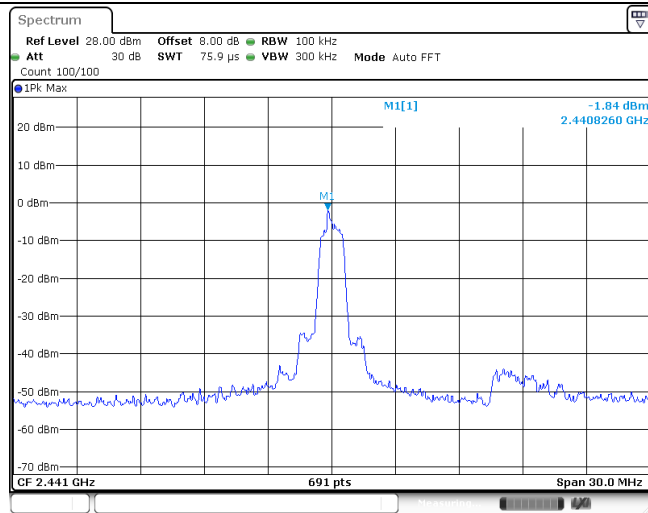

CH39
30MHz~1000MHz

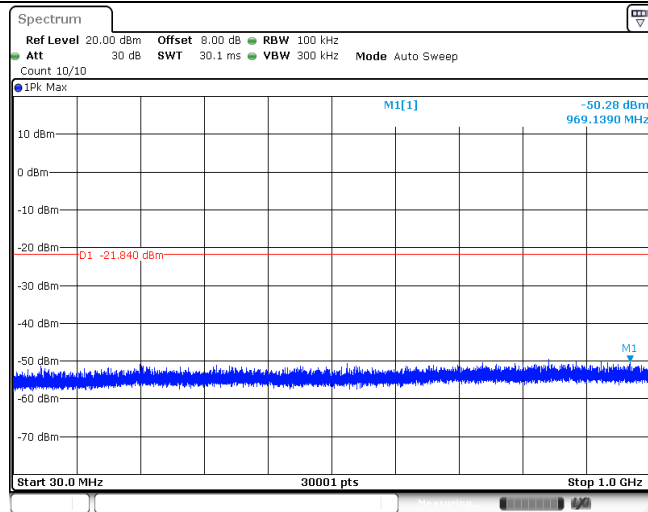

CH39
1GHz~26GHz

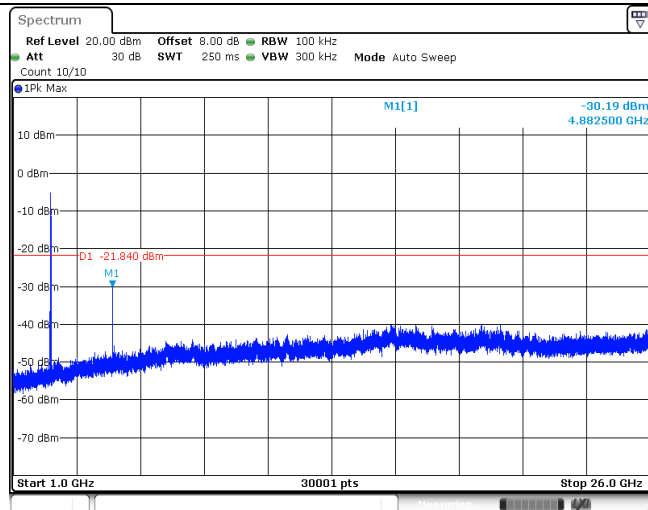

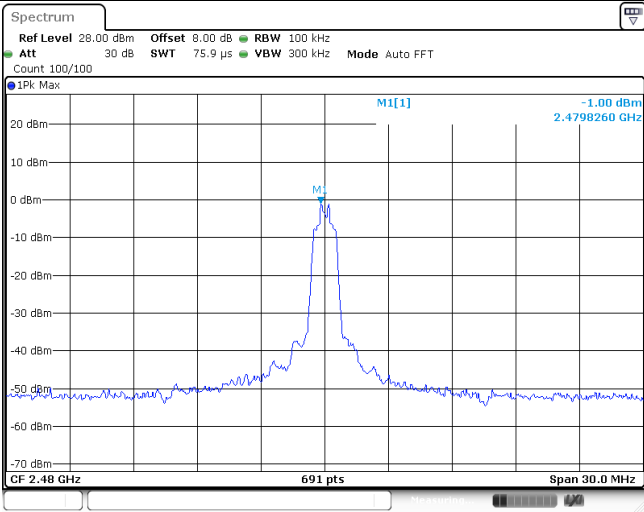
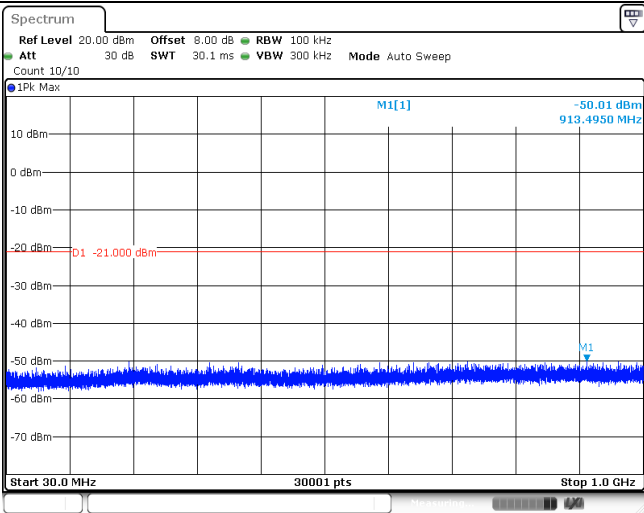
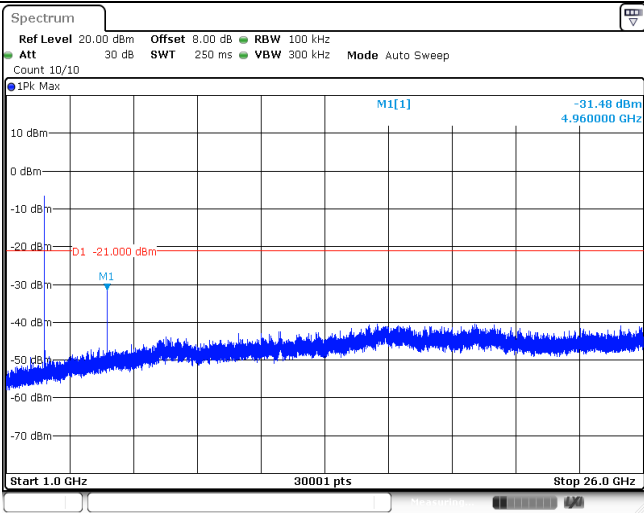
| | |
|---------------------------------|--|
| <p>CH78 Reference level</p> |  |
| <p>CH78 30MHz~1000MHz</p> |  |
| <p>CH78 1GHz~26GHz</p> |  |

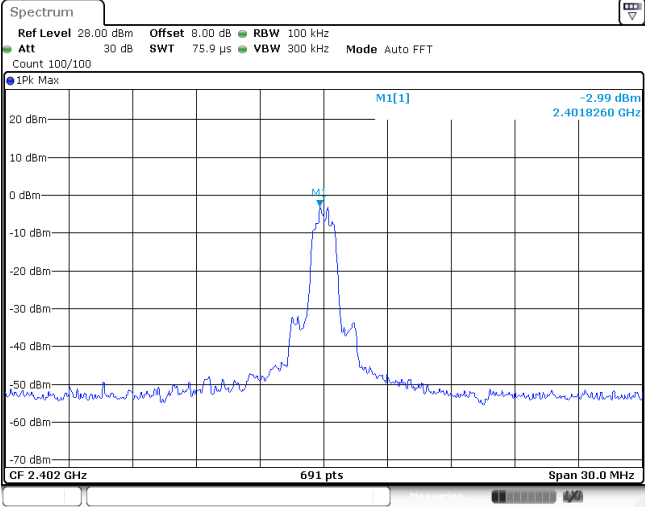
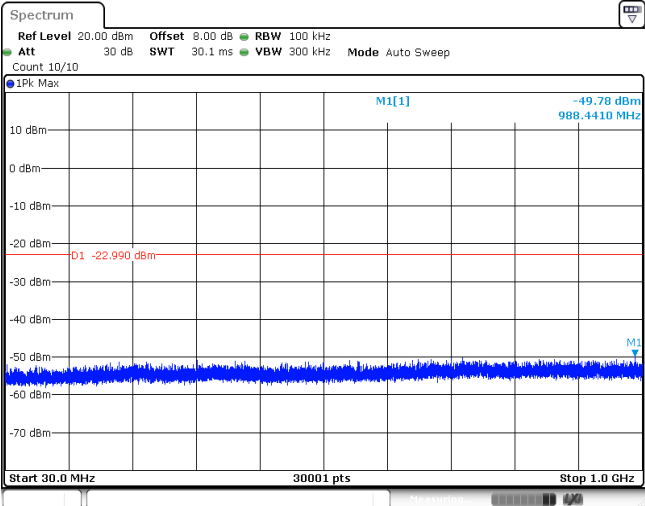
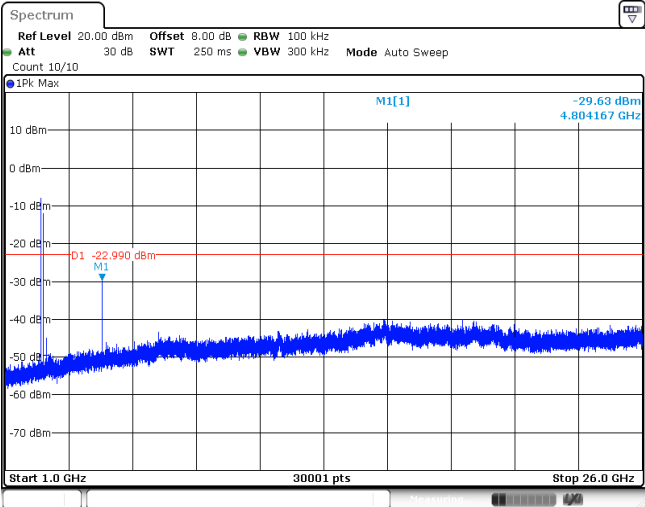
| Test Item: | SE | Modulation type: | 8DPSK |
|---------------------------------|---|------------------|-------|
| <p>CH00 Reference level</p> |  <p>Spectrum Ref Level 28.00 dBm Offset 8.00 dB RBW 100 kHz Att 30 dB SWT 75.9 μs VBW 300 kHz Mode Auto FFT Count 100/100 IPK Max M1[1] -2.99 dBm 2.4018260 GHz Span 30.0 MHz 691 pts</p> | | |
| <p>CH00 30MHz~1000MHz</p> |  <p>Spectrum Ref Level 20.00 dBm Offset 8.00 dB RBW 100 kHz Att 30 dB SWT 30.1 ms VBW 300 kHz Mode Auto Sweep Count 10/10 IPK Max M1[1] -49.78 dBm 988.4410 MHz D1 -22.990 dBm Start 30.0 MHz 30001 pts Stop 1.0 GHz</p> | | |
| <p>CH00 1GHz~26GHz</p> |  <p>Spectrum Ref Level 20.00 dBm Offset 8.00 dB RBW 100 kHz Att 30 dB SWT 250 ms VBW 300 kHz Mode Auto Sweep Count 10/10 IPK Max M1[1] -29.63 dBm 4.804167 GHz D1 -22.990 dBm Start 1.0 GHz 30001 pts Stop 26.0 GHz</p> | | |

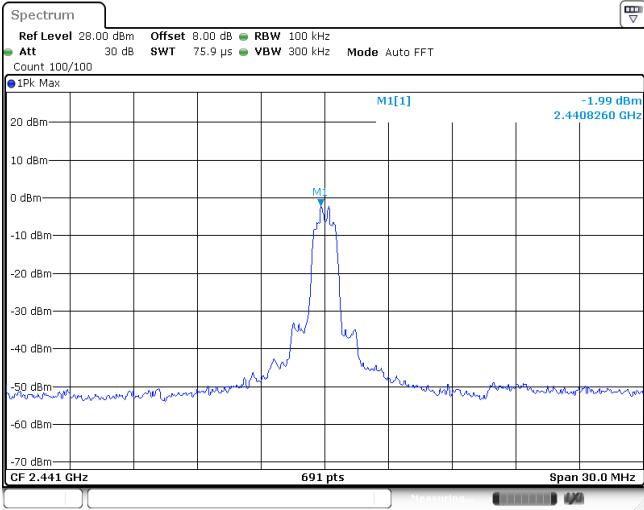
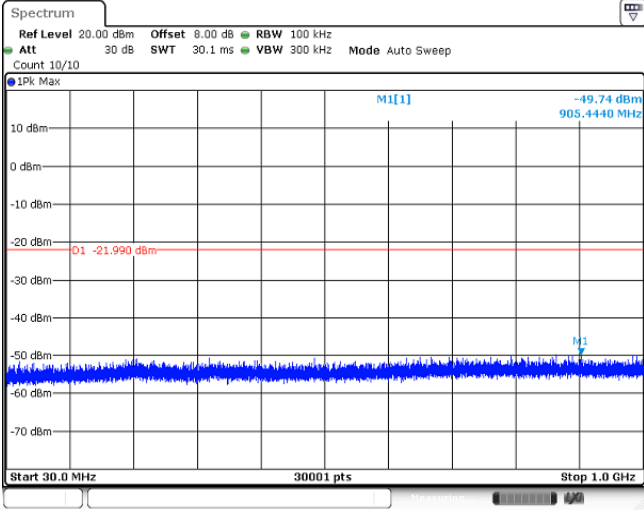
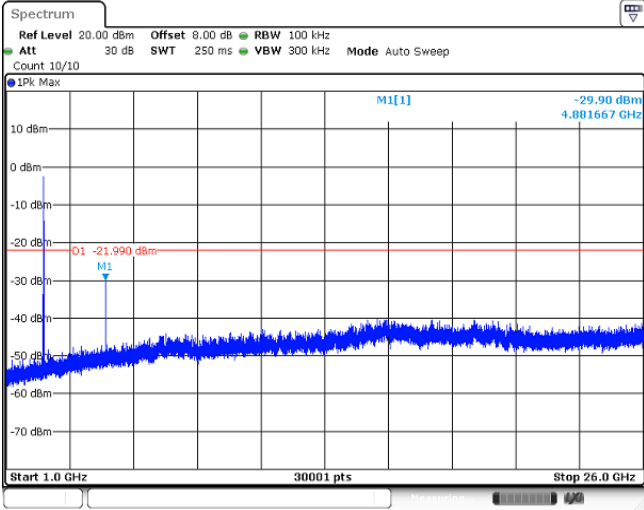
| | |
|---------------------------------|--|
| <p>CH39 Reference level</p> |  |
| <p>CH39 30MHz~1000MHz</p> |  |
| <p>CH39 1GHz~26GHz</p> |  |

CH78
Reference level

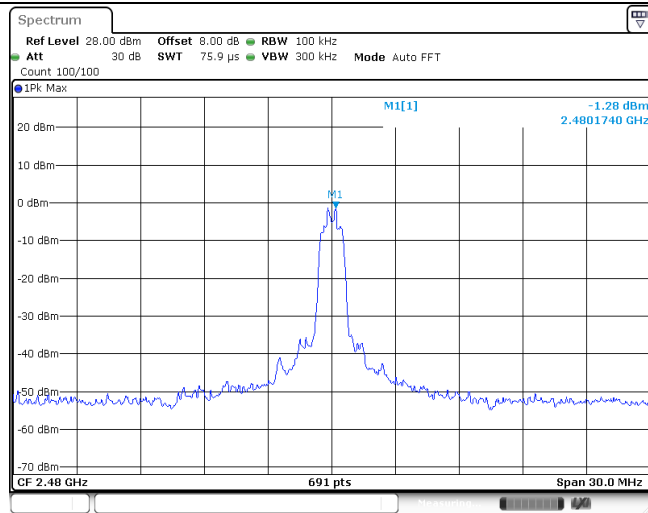

CH78
30MHz~1000MHz

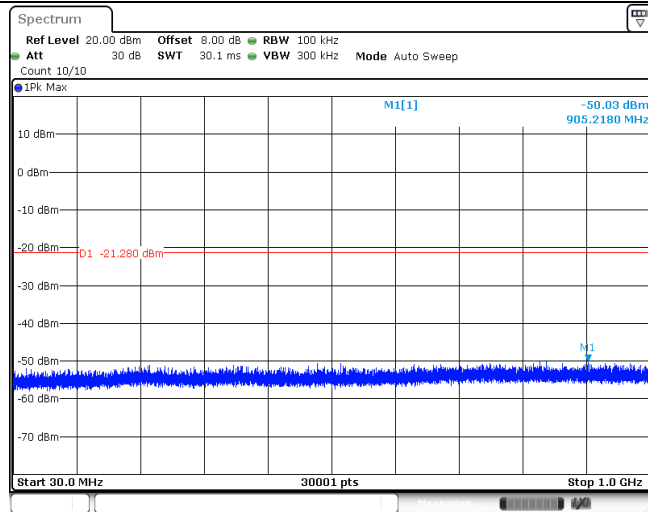

CH78
1GHz~26GHz

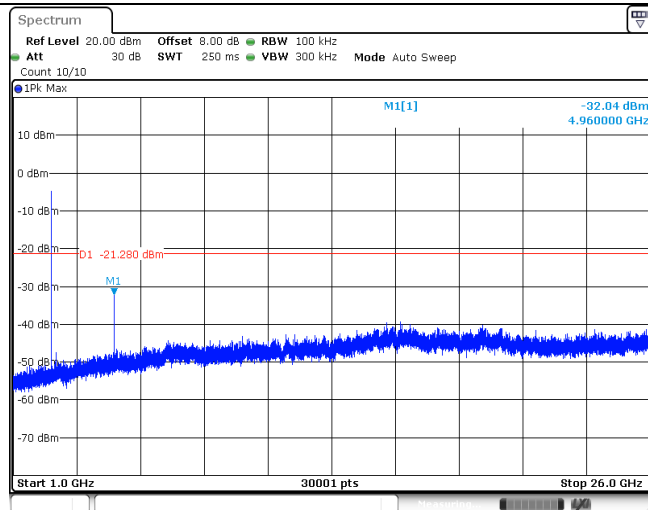

5.11. Spurious Emissions (radiated)

LIMIT

FCC CFR Title 47 Part 15 Subpart C Section 15.209

| Frequency | Limit (dBuV/m @3m) | Value |
|-------------------|--------------------|------------|
| 30 MHz ~ 88 MHz | 40.00 | Quasi-peak |
| 88 MHz ~ 216 MHz | 43.50 | Quasi-peak |
| 216 MHz ~ 960 MHz | 46.00 | Quasi-peak |
| 960 MHz ~ 1 GHz | 54.00 | Quasi-peak |
| Above 1 GHz | 54.00 | Average |
| | 74.00 | Peak |

TEST CONFIGURATION

- Below 30 MHz

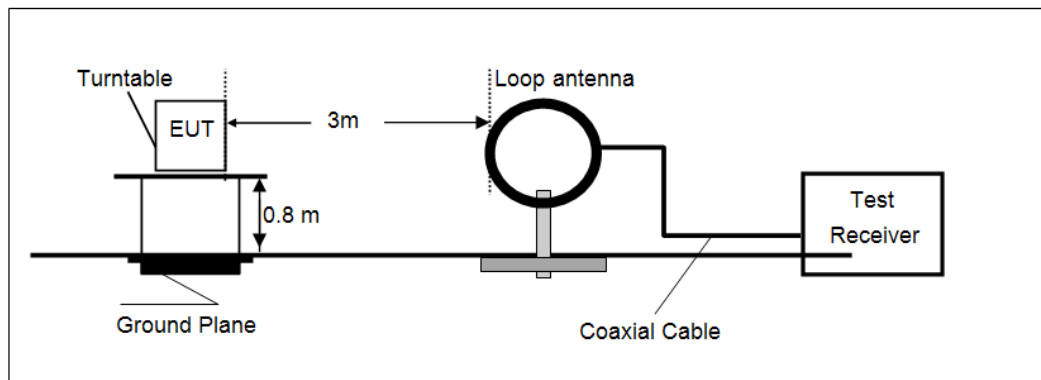

- 30 MHz ~1000 MHz

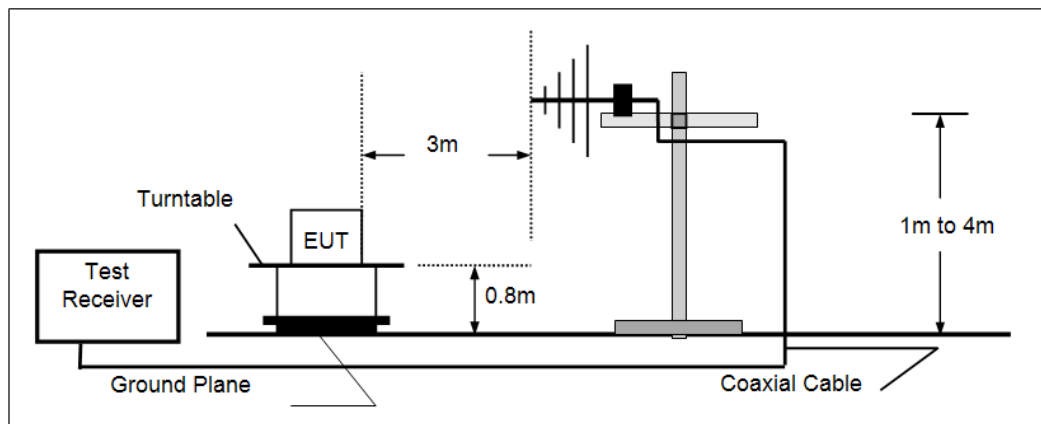

- Above 1 GHz

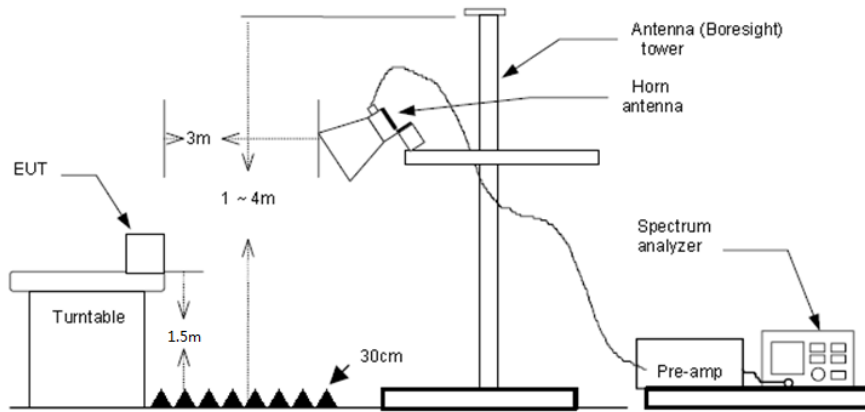

TEST PROCEDURE

1. The EUT was tested according to ANSI C63.10:2013.
2. The EUT is placed on a turn table with 0.8 meter above ground for below 1GHz, 1.5 meter above ground for above 1GHz.
3. The EUT was set 3 meters from the receiving antenna, which was mounted on the top of a variable height antenna tower.
4. For each suspected emission, the EUT was arranged to its worst case and then tune the Antenna tower (from 1 m to 4 m) and turntable (from 0 degree to 360 degrees) to find the maximum reading. A pre-amp and a high pass filter are used for the test in order to get better signal level to comply with the guidelines.
5. Set to the maximum power setting and enable the EUT transmit continuously.
6. Use the following spectrum analyzer settings
 - (1) Span shall wide enough to fully capture the emission being measured;
 - (2) Below 1 GHz:
 - RBW=120 kHz, VBW=300 kHz, Sweep=auto, Detector function=peak, Trace=max hold;
 - If the emission level of the EUT measured by the peak detector is 3 dB lower than the applicable limit, the peak emission level will be reported. Otherwise, the emission measurement will be repeated using the quasi-peak detector and reported.
 - (3) From 1 GHz to 10th harmonic:
 - RBW=1 MHz, VBW=3 MHz Peak detector for Peak value
 - RBW=1 MHz, VBW=10 Hz Peak detector for Average value.

TEST MODE:

Please refer to the clause 3.3

TEST RESULTS

Passed Not Applicable

Note:

- 1) Final Level = Receiver Read level + Antenna Factor + Cable Loss – Preamplifier Factor
- 2) The emission levels of other frequencies are very lower than the limit and not show in test report.
- 3) Below 1 GHz, Have pre-scan all modulation mode, found the GFSK modulation High channel which it was worst case, so only the worst case's data on the test report.
- 4) Above 1 GHz, Have pre-scan all modulation mode, found the GFSK modulation which it was worst case, so only the worst case's data on the test report
- 5) The peak level is lower than average limit(54 dBuV/m), this data is the too weak instrument of signal is unable to test.

➤ 9 kHz ~ 30 MHz

The low frequency, which started from 9 kHz to 30 MHz, was pre-scanned and the result which was 20 dB lower than the limit line per 15.31(o) was not reported.

➤ 30 MHz ~ 1 GHz

Polarization: Vertical

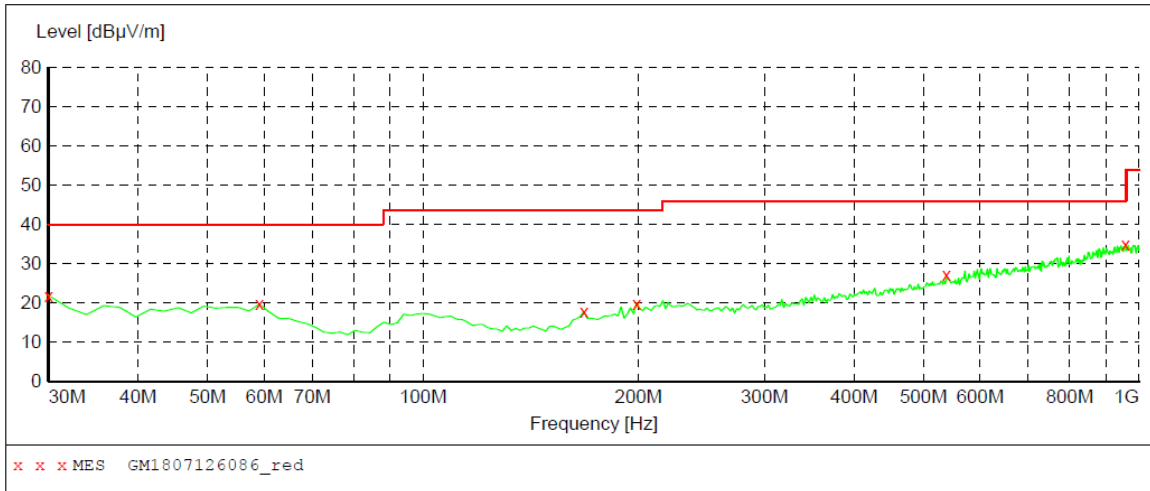

MEASUREMENT RESULT: "GM1807126086_red"

7/12/2018 9:22PM

| Frequency MHz | Level dBµV/m | Transd dB | Limit dBµV/m | Margin dB | Det. | Height cm | Azimuth deg | Polarization |
|---------------|--------------|-----------|--------------|-----------|------|-----------|-------------|--------------|
| 30.000000 | 21.90 | -13.3 | 40.0 | 18.1 | QP | 100.0 | 176.00 | VERTICAL |
| 59.100000 | 19.70 | -9.8 | 40.0 | 20.3 | QP | 100.0 | 62.00 | VERTICAL |
| 167.740000 | 17.80 | -13.0 | 43.5 | 25.7 | QP | 100.0 | 45.00 | VERTICAL |
| 198.780000 | 19.90 | -9.8 | 43.5 | 23.6 | QP | 100.0 | 62.00 | VERTICAL |
| 538.280000 | 27.10 | -1.0 | 46.0 | 18.9 | QP | 100.0 | 22.00 | VERTICAL |
| 957.320000 | 34.90 | 7.3 | 46.0 | 11.1 | QP | 100.0 | 73.00 | VERTICAL |

Polarization: Horizontal

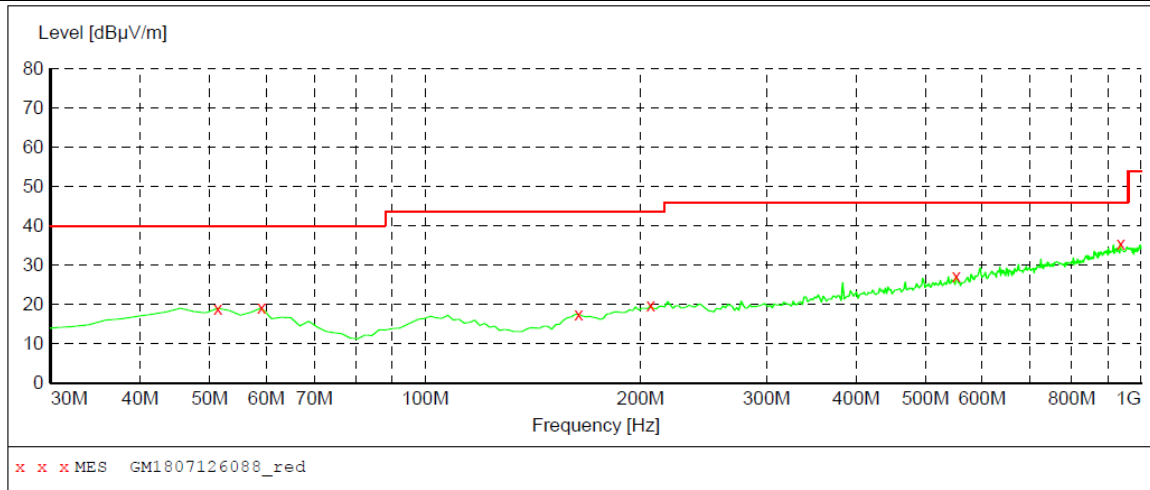

MEASUREMENT RESULT: "GM1807126088_red"

7/12/2018 9:26PM

| Frequency MHz | Level dBµV/m | Transd dB | Limit dBµV/m | Margin dB | Det. | Height cm | Azimuth deg | Polarization |
|---------------|--------------|-----------|--------------|-----------|------|-----------|-------------|--------------|
| 51.340000 | 19.00 | -8.8 | 40.0 | 21.0 | QP | 300.0 | 360.00 | HORIZONTAL |
| 59.100000 | 19.20 | -9.8 | 40.0 | 20.8 | QP | 300.0 | 186.00 | HORIZONTAL |
| 163.860000 | 17.50 | -13.2 | 43.5 | 26.0 | QP | 300.0 | 359.00 | HORIZONTAL |
| 206.540000 | 19.70 | -10.5 | 43.5 | 23.8 | QP | 300.0 | 199.00 | HORIZONTAL |
| 551.860000 | 27.10 | -0.7 | 46.0 | 18.9 | QP | 100.0 | 189.00 | HORIZONTAL |
| 935.980000 | 35.50 | 7.1 | 46.0 | 10.5 | QP | 100.0 | 126.00 | HORIZONTAL |

➤ 1 GHz ~ 25 GHz

| CH00 | | | | | | | | | |
|-----------------|-------------------|-----------------------|-----------------|--------------------|----------------|---------------------|-----------------|--------------|------------|
| Frequency (MHz) | Read Level (dBuV) | Antenna Factor (dB/m) | Cable Loss (dB) | Preamp Factor (dB) | Level (dBuV/m) | Limit Line (dBuV/m) | Over Limit (dB) | Polarization | Test value |
| 4107.32 | 36.07 | 29.91 | 8.87 | 36.65 | 38.20 | 74.00 | -35.80 | Vertical | Peak |
| 4809.50 | 42.62 | 31.58 | 9.55 | 35.72 | 48.03 | 54.00 | -5.97 | Vertical | Average |
| 4809.50 | 58.36 | 31.58 | 9.55 | 35.72 | 63.77 | 74.00 | -10.23 | Vertical | Peak |
| 4958.68 | 37.08 | 31.46 | 9.64 | 35.45 | 42.73 | 74.00 | -31.27 | Vertical | Peak |
| 7209.01 | 30.73 | 36.21 | 11.87 | 33.51 | 45.30 | 54.00 | -8.70 | Vertical | Average |
| 7209.02 | 51.20 | 36.21 | 11.87 | 33.51 | 65.77 | 74.00 | -8.23 | Vertical | Peak |
| 1192.01 | 35.34 | 26.24 | 4.64 | 37.23 | 28.99 | 74.00 | -45.01 | Horizontal | Peak |
| 3516.59 | 35.54 | 29.05 | 8.14 | 37.13 | 35.60 | 74.00 | -38.40 | Horizontal | Peak |
| 4809.50 | 33.58 | 31.58 | 9.55 | 35.72 | 38.99 | 54.00 | -15.01 | Horizontal | Average |
| 4809.50 | 49.33 | 31.58 | 9.55 | 35.72 | 54.74 | 74.00 | -19.26 | Horizontal | Peak |
| 7209.01 | 27.56 | 36.21 | 11.87 | 33.51 | 42.13 | 54.00 | -11.87 | Horizontal | Average |
| 7209.02 | 48.09 | 36.21 | 11.87 | 33.51 | 62.66 | 74.00 | -11.34 | Horizontal | Peak |

| CH39 | | | | | | | | | |
|-----------------|-------------------|-----------------------|-----------------|--------------------|----------------|---------------------|-----------------|--------------|------------|
| Frequency (MHz) | Read Level (dBuV) | Antenna Factor (dB/m) | Cable Loss (dB) | Preamp Factor (dB) | Level (dBuV/m) | Limit Line (dBuV/m) | Over Limit (dB) | Polarization | Test value |
| 3225.04 | 34.93 | 28.65 | 7.75 | 37.37 | 33.96 | 74.00 | -40.04 | Vertical | Peak |
| 4883.52 | 41.63 | 31.43 | 9.59 | 35.58 | 47.07 | 54.00 | -6.93 | Vertical | Average |
| 4883.52 | 57.94 | 31.43 | 9.59 | 35.58 | 63.38 | 74.00 | -10.62 | Vertical | Peak |
| 5034.99 | 35.71 | 31.64 | 9.70 | 35.31 | 41.74 | 74.00 | -32.26 | Vertical | Peak |
| 7319.96 | 29.58 | 36.30 | 11.99 | 33.32 | 44.55 | 54.00 | -9.45 | Vertical | Average |
| 7319.96 | 50.17 | 36.30 | 11.99 | 33.32 | 65.14 | 74.00 | -8.86 | Vertical | Peak |
| 2258.20 | 33.85 | 27.85 | 6.54 | 37.59 | 30.65 | 74.00 | -43.35 | Horizontal | Peak |
| 4107.32 | 35.44 | 29.91 | 8.87 | 36.65 | 37.57 | 74.00 | -36.43 | Horizontal | Peak |
| 4883.52 | 32.97 | 31.43 | 9.59 | 35.58 | 38.41 | 54.00 | -15.59 | Horizontal | Average |
| 4883.52 | 49.33 | 31.43 | 9.59 | 35.58 | 54.77 | 74.00 | -19.23 | Horizontal | Peak |
| 7319.96 | 28.88 | 36.30 | 11.99 | 33.32 | 43.85 | 54.00 | -10.15 | Horizontal | Average |
| 7319.96 | 48.60 | 36.30 | 11.99 | 33.32 | 63.57 | 74.00 | -10.43 | Horizontal | Peak |

Remark:

1. Final Level = Receiver Read level + Antenna Factor + Cable Loss – Preamplifier Factor
2. The peak level is lower than average limit(54 dBuV/m), this data is the too weak instrument of signal is unable to test.
3. The emission levels of other frequencies are very lower than the limit and not show in test report.

| CH78 | | | | | | | | | |
|-----------------|-------------------|-----------------------|-----------------|--------------------|----------------|---------------------|-----------------|--------------|------------|
| Frequency (MHz) | Read Level (dBuV) | Antenna Factor (dB/m) | Cable Loss (dB) | Preamp Factor (dB) | Level (dBuV/m) | Limit Line (dBuV/m) | Over Limit (dB) | Polarization | Test value |
| 4117.79 | 35.52 | 29.92 | 8.87 | 36.64 | 37.67 | 74.00 | -36.33 | Vertical | Peak |
| 4809.50 | 37.77 | 31.58 | 9.55 | 35.72 | 43.18 | 74.00 | -30.82 | Vertical | Peak |
| 4958.68 | 39.59 | 31.46 | 9.64 | 35.45 | 45.24 | 54.00 | -8.76 | Vertical | Average |
| 4958.68 | 57.69 | 31.46 | 9.64 | 35.45 | 63.34 | 74.00 | -10.66 | Vertical | Peak |
| 7451.57 | 31.49 | 36.20 | 12.24 | 33.10 | 46.83 | 54.00 | -7.17 | Vertical | Average |
| 7451.57 | 51.98 | 36.20 | 12.24 | 33.10 | 67.32 | 74.00 | -6.68 | Vertical | Peak |
| 3543.55 | 35.36 | 29.13 | 8.18 | 37.11 | 35.56 | 74.00 | -38.44 | Horizontal | Peak |
| 4958.68 | 31.47 | 31.46 | 9.64 | 35.45 | 37.12 | 54.00 | -16.88 | Horizontal | Average |
| 4958.68 | 45.76 | 31.46 | 9.64 | 35.45 | 51.41 | 74.00 | -22.59 | Horizontal | Peak |
| 6156.51 | 33.40 | 32.73 | 10.94 | 33.98 | 43.09 | 74.00 | -30.91 | Horizontal | Peak |
| 7451.57 | 28.23 | 36.20 | 12.24 | 33.10 | 43.57 | 54.00 | -10.43 | Horizontal | Average |
| 7451.57 | 48.27 | 36.20 | 12.24 | 33.10 | 63.61 | 74.00 | -10.39 | Horizontal | Peak |

Remark:

4. Final Level = Receiver Read level + Antenna Factor + Cable Loss – Preamplicifier Factor
5. The peak level is lower than average limit(54 dBuV/m), this data is the too weak instrument of signal is unable to test.
6. The emission levels of other frequencies are very lower than the limit and not show in test report.

6. TEST SETUP PHOTOS

Conducted Emissions (AC Mains)



Radiated Emissions



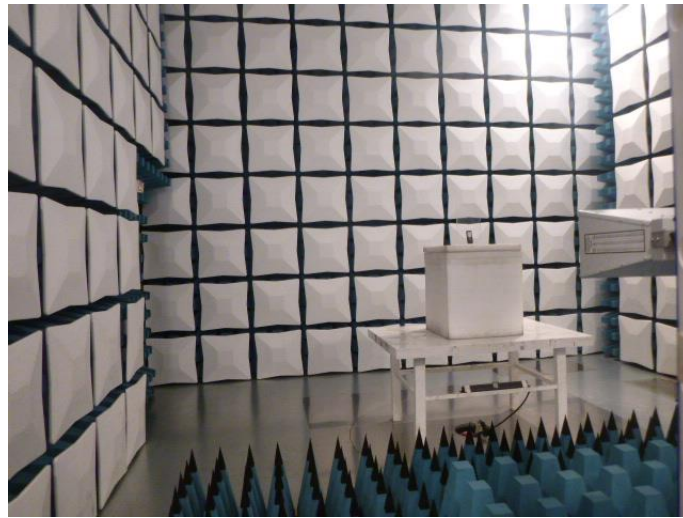

7. EXTERANAL AND INTERNAL PHOTOS

Reference to the test report No.: TRE1807004201

-----End of Report-----