



# FCC REPORT

**Report Reference No.**..... : **TRE1706025202** R/C.....: 87663  
**FCC ID**..... : **QRP-AZUMISPEEDP50**  
**Applicant's name**..... : **Azumi S.A**  
 Address.....: Avenida Aquilino de la Guardia con Calle 47, PH Ocean Plaza, Piso 16 of. 16-01, Marbella, Ciudad de Panama, Panama  
 Manufacturer.....: AZUMI HK LTD  
 Address.....: FLAT/RM 18 BLK 1 14/F GOLDEN INDUSTRIAL BUILDING 16-26 KWAI TAK STREET KWAI CHUNG,HK  
**Test item description** ..... : **4G Mobile Phone**  
 Trade Mark ..... : -  
 Model/Type reference.....: Speed Pro 50  
 Listed Model(s) ..... : -  
**Standard** ..... : **FCC Part 22: PUBLIC MOBILE SERVICES**  
**FCC Part 24:PERSONAL COMMUNICATIONS SERVICES**  
**FCC Part 27: MISCELLANEOUS WIRELESS COMMUNICATIONS SERVICES**  
 Date of receipt of test sample.....: Jun.26, 2017  
 Date of testing.....: Jun.27, 2017 - Jul.17, 2017  
 Date of issue.....: Jul.18, 2017  
**Result**.....: **Pass**

Compiled by  
 ( position+printedname+signature)....: File administrators Candy Liu   
 Supervised by  
 (position+printedname+signature).....: Project Engineer Lion Cai   
 Approved by  
 (position+printedname+signature).....: Manager Hans Hu 

**Testing Laboratory Name** ..... : **Shenzhen Huatongwei International Inspection Co., Ltd.**  
 Address.....: 1/F, Bldg 3, Hongfa Hi-tech Industrial Park, Genyu Road, Tianliao, Gongming, Shenzhen, China

**Shenzhen Huatongwei International Inspection Co., Ltd. All rights reserved.**

This publication may be reproduced in whole or in part for non-commercial purposes as long as the Shenzhen Huatongwei International Inspection Co., Ltd. is acknowledged as copyright owner and source of the material. Shenzhen Huatongwei International Inspection Co., Ltd. takes no responsibility for and will not assume liability for damages resulting from the reader's interpretation of the reproduced material due to its placement and context.

*The test report merely corresponds to the test sample.  
 It is not permitted to copy extracts of these test result without the written permission of the test laboratory.*

## Contents

<b>1.</b>	<b><u>TEST STANDARDS AND REPORT VERSION</u></b>	<b>3</b>
1.1.	Applicable Standards	3
1.2.	Report version	3
<b>2.</b>	<b><u>TEST DESCRIPTION</u></b>	<b>4</b>
<b>3.</b>	<b><u>SUMMARY</u></b>	<b>5</b>
3.1.	Client Information	5
3.2.	Product Description	5
3.3.	Operation state	6
3.4.	EUT operation mode	7
3.5.	EUT configuration	8
3.6.	Modifications	8
<b>4.</b>	<b><u>TEST ENVIRONMENT</u></b>	<b>9</b>
4.1.	Address of the test laboratory	9
4.2.	Test Facility	9
4.3.	Equipments Used during the Test	10
4.4.	Environmental conditions	11
4.5.	Statement of the measurement uncertainty	11
<b>5.</b>	<b><u>TEST CONDITIONS AND RESULTS</u></b>	<b>12</b>
5.1.	Conducted Output Power	12
5.2.	99% & -26 dB Occupied Bandwidth	13
5.3.	Conducted Spurious Emissions	14
5.4.	Band Edge	15
5.5.	ERP AND EIRP	16
5.6.	Radiated Spurious Emission	22
5.7.	Frequency stability V.S. Temperature measurement	32
5.8.	Frequency stability V.S. Voltagemasurement	33
5.9.	Peak-Average Ratio	34
<b>6.</b>	<b><u>TEST SETUP PHOTOS OF THE EUT</u></b>	<b>35</b>
<b>7.</b>	<b><u>EXTERNAL AND INTERNAL PHOTOS OF THE EUT</u></b>	<b>35</b>

# **1. Test standards and Report version**

## **1.1. Applicable Standards**

The tests were performed according to following standards:

[FCC Part 22](#):PRIVATE LAND MOBILE RADIO SERVICES.

[FCC Part 24](#):PUBLIC MOBILE SERVICES

[FCC Part 27](#):MISCELLANEOUS WIRELESS COMMUNICATIONS SERVICES

[TIA/EIA 603 D June 2010](#):Land Mobile FM or PM Communications Equipment Measurement and Performance Standards.

[FCC Part 2](#):FREQUENCY ALLOCA-TIONS AND RADIO TREATY MAT-TERS; GENERAL RULES AND REG-ULATIONS

[971168 D01 Power Meas License Digital Systems v02r02](#):provides a methodology for fully characterizing the fundamental power of wideband (> 1 MHz) digitally modulated RF signals acceptable to the FCC for demonstrating compliance for licensed transmitters.

## **1.2. Report version**

Version No.	Date of issue	Description
00	Jul. 18, 2017	Original

## 2. Test Description

Test Item	Section in CFR 47	Result
RF Output Power	Part 2.1046 Part 22.913(a) Part 24.232(c) Part 27.50	Pass
99% & -26 dB Occupied Bandwidth	Part 2.1049 Part 22.917(b) Part 24.238(b)	Pass
Conducted Spurious Emissions	Part 2.1051 Part 22.917 Part 24.238 Part 27.53	Pass
Band Edge	Part 2.1051 Part 22.917 Part 24.238 Part 27.53	Pass
ERP and EIRP	Part 22.913(a) Part 24.232(b)	Pass
Radiated Spurious Emissions	Part 2.1053 Part 22.917 Part 24.238 Part 27.53	Pass
Frequency stability vs. temperature	Part 2.1055(a)(1)(b) Part 22.255 Part 24.235 Part 27.54	Pass
Frequency stability vs. voltage	Part 2.1055(d)(1)(2) Part 22.255 Part 24.235 Part 27.54	Pass
Peak-Average Ratio	Part 24.232 Part 27.50	Pass

Note: The measurement uncertainty is not included in the test result.

### 3. SUMMARY

#### 3.1. Client Information

Applicant:	Azumi S.A
Address:	Avenida Aquilino de la Guardia con Calle 47, PH Ocean Plaza, Piso 16 of. 16-01, Marbella, Ciudad de Panama, Panama
Manufacturer:	AZUMI HK LTD
Address:	FLAT/RM 18 BLK 1 14/F GOLDEN INDUSTRIAL BUILDING 16-26 KWAI TAK STREET KWAI CHUNG,HK

#### 3.2. Product Description

Name of EUT:	4G Mobile Phone
Trade Mark:	-
Model No.:	Speed Pro 50
Listed Model(s):	-
IMEI:	134168350922470
Power supply:	DC 3.8V From internal battery
Adapter information:	Input: 100-240Va.c., 50/60Hz, 0.2A Output: 5Vd.c., 1A
Hardware version:	AZUMI_Speed_Pro_50_Hardware_V1.0
Software version:	AZUMI_Speed_Pro_50_OM_V01
<b>RF Technical Description</b>	
<input checked="" type="checkbox"/> FDD Band 2	
Operation Frequency:	Uplink:1850.7 MHz – 1909.3 MHz Downlink: 1930.7 MHz – 1989.3 MHz
Channel bandwidth:	<input checked="" type="checkbox"/> 1.4MHz <input checked="" type="checkbox"/> 3MHz <input checked="" type="checkbox"/> 5MHz <input checked="" type="checkbox"/> 10MHz <input checked="" type="checkbox"/> 15MHz <input checked="" type="checkbox"/> 20MHz
<input checked="" type="checkbox"/> FDD Band 4	
Operation Frequency:	Uplink:1710.7 MHz – 1754.3 MHz Downlink: 2110.7 MHz – 2154.3 MHz
Channel bandwidth:	<input checked="" type="checkbox"/> 1.4MHz <input checked="" type="checkbox"/> 3MHz <input checked="" type="checkbox"/> 5MHz <input checked="" type="checkbox"/> 10MHz <input checked="" type="checkbox"/> 15MHz <input checked="" type="checkbox"/> 20MHz
<input checked="" type="checkbox"/> FDD Band 7	
Operation Frequency:	Uplink:2502.5 MHz – 2567.5 MHz Downlink: 2622.5 MHz – 2687.5 MHz
Channel bandwidth:	<input type="checkbox"/> 1.4MHz <input type="checkbox"/> 3MHz <input checked="" type="checkbox"/> 5MHz <input checked="" type="checkbox"/> 10MHz <input type="checkbox"/> 15MHz <input type="checkbox"/> 20MHz
Power Class:	<input type="checkbox"/> Class 1 <input type="checkbox"/> Class 2 <input checked="" type="checkbox"/> Class 3 <input type="checkbox"/> Class 4
Modulation type:	<input checked="" type="checkbox"/> QPSK <input checked="" type="checkbox"/> 16QAM <input type="checkbox"/> 64QAM
Antenna type:	IntegralAntenna
Antenna gain:	Band 2:1.2 dBi, Band 4:1.1 dBi, Band 7:2 dBi,

### 3.3. Operation state

#### ➤ Test frequency list

FDD Band 2					
Test Frequency ID	Bandwidth [MHz]	N <sub>UL</sub>	Frequency of Uplink [MHz]	N <sub>DL</sub>	Frequency of Downlink [MHz]
Low Range	1.4	18607	1850.7	607	1930.7
	3	18615	1851.5	615	1931.5
	5	18625	1852.5	625	1932.5
	10	18650	1855	650	1935
	15 <sup>[1]</sup>	18675	1857.5	675	1937.5
	20 <sup>[1]</sup>	18700	1860	700	1940
Mid Range	1.4/3/5/10/15 <sup>[1]</sup> /20 <sup>[1]</sup>	18900	1880	900	1960
High Range	1.4	19193	1909.3	1193	1989.3
	3	19185	1908.5	1185	1988.5
	5	19175	1907.5	1175	1987.5
	10	19150	1905	1150	1985
	15 <sup>[1]</sup>	19125	1902.5	1125	1982.5
	20 <sup>[1]</sup>	19100	1900	1100	1980
NOTE 1: Bandwidth for which a relaxation of the specified UE receiver sensitivity requirement (TS 36.101 [27] Clause 7.3) is allowed.					
FDD Band 4					
Test Frequency ID	Bandwidth [MHz]	N <sub>UL</sub>	Frequency of Uplink [MHz]	N <sub>DL</sub>	Frequency of Downlink [MHz]
Low Range	1.4	19957	1710.7	1957	2110.7
	3	19965	1711.5	1965	2111.5
	5	19975	1712.5	1975	2112.5
	10	20000	1715	2000	2115
	15	20025	1717.5	2025	2117.5
	20	20050	1720	2050	2120
Mid Range	1.4/3/5/10/15/20	20175	1732.5	2175	2132.5
High Range	1.4	20393	1754.3	2393	2154.3
	3	20385	1753.5	2385	2153.5
	5	20375	1752.5	2375	2152.5
	10	20350	1750	2350	2150
	15	20325	1747.5	2325	2147.5
	20	20300	1745	2300	2145
FDD Band 7					
Test Frequency ID	Bandwidth [MHz]	N <sub>UL</sub>	Frequency of Uplink [MHz]	N <sub>DL</sub>	Frequency of Downlink [MHz]
Low Range	5	20775	2502.5	2775	2622.5
	10	20800	2505	2800	2625
	15	20825	2507.5	2825	2627.5
	20 <sup>[1]</sup>	20850	2510	2850	2630
Mid Range	5/10/15/20 <sup>[1]</sup>	21100	2535	3100	2655
High Range	5	21425	2567.5	3425	2687.5
	10	21400	2565	3400	2685
	15	21375	2562.5	3375	2682.5
	20 <sup>[1]</sup>	21350	2560	3350	2680
NOTE 1: Bandwidth for which a relaxation of the specified UE receiver sensitivity requirement (TS 36.101 [27] Clause 7.3) is allowed.					

### 3.4. EUT operation mode

For RF test items

The EUT has been tested under typical operating condition. The Applicant provides software to control the EUT for staying in continuous transmitting and receiving mode for testing.

Test Items	Band	Bandwidth (MHz)						Modulation		RB #			Test Channel		
		1.4	3	5	10	15	20	QPSK	16QAM	1	Half	Full	L	M	H
Max Output Power	2	v	v	v	v	v	v	v	v	v	v	v	v	v	v
	4	v	v	v	v	v	v	v	v	v	v	v	v	v	v
	7	-	-	v	v	v	v	v	v	v	v	v	v	v	v
26dB and 99% Bandwidth	2	v	v	v	v	v	v	v	v			v	v	v	v
	4	v	v	v	v	v	v	v	v			v	v	v	v
	7	-	-	v	v	v	v	v	v			v	v	v	v
Conducted Band Edge	2	v	v	v	v	v	v	v	v	v		v	v		v
	4	v	v	v	v	v	v	v	v	v		v	v		v
	7	-	-	v	v	v	v	v	v	v		v	v		v
Conducted Spurious Emission	2	v	v	v	v	v	v	v	v	v			v	v	v
	4	v	v	v	v	v	v	v	v	v			v	v	v
	7	-	-	v	v	v	v	v	v	v			v	v	v
E.R.P./ E.I.R.P.	2	v	v	v	v	v	v	v	v	v			v	v	v
	4	v	v	v	v	v	v	v	v	v			v	v	v
	7	-	-	v	v	v	v	v	v	v			v	v	v
Radiated Spurious Emission	2	v	v	v	v	v	v	v		v			v	v	v
	4	v	v	v	v	v	v	v		v			v	v	v
	7	-	-	v	v	v	v	v		v			v	v	v
Frequency Stability	2						v	v	v			v		v	
	4						v	v	v			v		v	
	7						v	v	v			v		v	
Peak-to-Average Ratio	2						v	v	v	v		v	v	v	v
	4						v	v	v	v		v	v	v	v
	7						v	v	v	v		v	v	v	v
Remark	1. The mark "v" means that this configuration is chosen for testing 2. The mark "-" means that this bandwidth is not supported. 3. The device is investigated from 30MHz to 10 times of fundamental signal for radiated spurious emission test under different RB size/offset and modulations in exploratory test. Subsequently, only the worst case emissions are reported.														

### 3.5. EUT configuration

The following peripheral devices and interface cables were connected during the measurement:

● - supplied by the manufacturer

○ - supplied by the lab

		Manufacturer :	
		Model No. :	
		Manufacturer :	
		Model No. :	
		Manufacturer :	
		Model No. :	

### 3.6. Modifications

No modifications were implemented to meet testing criteria.



## **4. TEST ENVIRONMENT**

### **4.1. Address of the test laboratory**

Laboratory: Shenzhen Huatongwei International Inspection Co., Ltd.

Address: 1/F, Bldg 3, Hongfa Hi-tech Industrial Park, Genyu Road, Tianliao, Gongming, Shenzhen, China

Phone: 86-755-26748019 Fax: 86-755-26748089

### **4.2. Test Facility**

The test facility is recognized, certified, or accredited by the following organizations:

#### **CNAS-Lab Code: L1225**

Shenzhen Huatongwei International Inspection Co., Ltd. has been assessed and proved to be in compliance with CNAS-CL01 Accreditation Criteria for Testing and Calibration Laboratories (identical to ISO/IEC17025: 2005 General Requirements) for the Competence of Testing and Calibration Laboratories.

#### **A2LA-Lab Cert. No.: 3902.01**

Shenzhen Huatongwei International Inspection Co., Ltd. EMC Laboratory has been accredited by A2LA for technical competence in the field of electrical testing, and proved to be in compliance with ISO/IEC 17025: 2005 General Requirements for the Competence of Testing and Calibration Laboratories and any additional program requirements in the identified field of testing.

#### **FCC-Registration No.: 762235**

Shenzhen Huatongwei International Inspection Co., Ltd. EMC Laboratory has been registered and fully described in a report filed with the FCC (Federal Communications Commission). The acceptance letter from the FCC is maintained in our files. Registration 762235

#### **IC-Registration No.: 5377B**

Two 3m Alternate Test Site of Shenzhen Huatongwei International Inspection Co., Ltd. has been registered by Certification and Engineering Bureau of Industry Canada for the performance of radiated measurements with Registration No. 5377B.

#### **ACA**

Shenzhen Huatongwei International Inspection Co., Ltd. EMC Laboratory can also perform testing for the Australian C-Tick mark as a result of our A2LA accreditation.

### 4.3. Equipments Used during the Test

Output Power(Conducted) &Occupied Bandwidth&EmissionBandwidth&Band Edge Compliance&Conducted Spurious Emission					
No.	Equipment	Manufacturer	Model No.	SerialNo.	Last Cal.
1	UNIVERSAL RADIO COMMUNICATION	Rohde&Schwarz	CMU200	112012	2016/11/13
2	WIDEB.RADIO COMM.TESRER	Rohde&Schwarz	CMW500	1201.0002K50	2016/11/13
3	Spectrum Analyzer	Rohde&Schwarz	FSU26	201141	2016/11/13
4	Splitter	Mini-Circuit	ZAPD-4	400059	2016/11/13

Frequency Stability					
No.	Equipment	Manufacturer	Model No.	SerialNo.	Last Cal.
1	UNIVERSAL RADIO COMMUNICATION	Rohde&Schwarz	CMU200	112012	2016/11/13
2	WIDEB.RADIO COMM.TESRER	Rohde&Schwarz	CMW500	1201.0002K50	2016/11/13
3	Spectrum Analyzer	Rohde&Schwarz	FSU26	201141	2016/11/13
4	Climate Chamber	ESPEC	EL-10KA	05107008	2016/11/13
5	Splitter	Mini-Circuit	ZAPD-4	400059	2016/11/13

Output Power (Radiated) &Radiated Spurious Emission					
No.	Equipment	Manufacturer	Model No.	SerialNo.	Last Cal.
1	UNIVERSAL RADIO COMMUNICATION	Rohde&Schwarz	CMU200	112012	2016/11/13
2	Spectrum Analyzer	Rohde&Schwarz	FSU26	201141	2016/11/13
3	HORNANTENNA	ShwarzBeck	9120D	1012	2016/11/13
4	HORNANTENNA	ShwarzBeck	9120D	1011	2016/11/13
5	Ultra-Broadband Antenna	ShwarzBeck	VULB9163	538	2016/11/13
6	Ultra-Broadband Antenna	ShwarzBeck	VULB9163	539	2016/11/13
7	TURNTABLE	MATURO	TT2.0	----	2016/11/13
8	ANTENNA MAST	MATURO	TAM-4.0-P	----	N/A
9	EMI Test Software	Audix	E3	N/A	N/A
10	EMI Test Receiver	Rohde&Schwarz	ESIB 26	100009	2016/11/13
11	RF Test Panel	Rohde&Schwarz	TS / RSP	335015/ 0017	2016/11/13
12	High pass filter	Compliance Direction systems	BSU-6	34202	2016/11/13
13	Splitter	Mini-Circuit	ZAPD-4	400059	2016/11/13
14	Horn Antenna	SCHWARZBECK	BBHA9170	25841	2016/11/13
15	Horn Antenna	SCHWARZBECK	BBHA9170	25842	2016/11/13
16	Preamplifier	ShwarzBeck	BBV 9718	BBV 9718	2016/11/13
17	Broadband Preamplifier	ShwarzBeck	BBV743	9743-0079	2016/11/13
18	Signal Generator	Rohde&Schwarz	SMF100A	101932	2016/11/13
19	Amplifier	Compliance Direction systems	PAP1-4060	120	2016/11/13
20	TURNTABLE	ETS	2088	2149	2016/11/13
21	ANTENNA MAST	ETS	2075	2346	2016/11/13
22	HORNANTENNA	Rohde&Schwarz	HF906	100068	2016/11/13
23	HORNANTENNA	Rohde&Schwarz	HF906	100039	2016/11/13
24	WIDEB.RADIO COMM.TESRER	R&S	CMW500	1201.0002K50	2016/11/13

The calibration interval was one year.

#### 4.4. Environmental conditions

During the measurement the environmental conditions were within the listed ranges:

Normal Temperature/Tnor:	15~35°C
Relative Humidity	30~60 %
Air Pressure	950-1050 hPa

#### 4.5. Statement of the measurement uncertainty

The data and results referenced in this document are true and accurate. The reader is cautioned that there may be errors within the calibration limits of the equipment and facilities. The measurement uncertainty was calculated for all measurements listed in this test report acc. to TR-100028-01 "Electromagnetic compatibility and Radio spectrum Matters (ERM); Uncertainties in the measurement of mobile radio equipment characteristics; Part 1" and TR-100028-02 "Electromagnetic compatibility and Radio spectrum Matters (ERM); Uncertainties in the measurement of mobile radio equipment characteristics; Part 2" and is documented in the Shenzhen Huatongwei International Inspection Co., Ltd quality system acc. to DIN EN ISO/IEC 17025. Furthermore, component and process variability of devices similar to that tested may result in additional deviation. The manufacturer has the sole responsibility of continued compliance of the device.

Hereafter the best measurement capability for Shenzhen Huatongwei laboratory is reported:

Test Items	Measurement Uncertainty	Notes
Frequency stability	25 Hz	(1)
Transmitter power conducted	0.57 dB	(1)
Transmitter power Radiated	2.20 dB	(1)
Conducted spurious emission 9KHz-12.75 GHz	1.60 dB	(1)
Conducted Emission 9KHz-30MHz	3.39 dB	(1)
Radiated Emission 30~1000MHz	4.24 dB	(1)
Radiated Emission 1~18GHz	5.16 dB	(1)
Radiated Emission 18-40GHz	5.54 dB	(1)
Occupied Bandwidth	-----	(1)
Emission Mask	-----	(1)
Modulation Characteristic	-----	(1)
Transmitter Frequency Behavior	-----	(1)

(1) This uncertainty represents an expanded uncertainty expressed at approximately the 95% confidence level using a coverage factor of  $k=1.96$ .

## 5. TEST CONDITIONS AND RESULTS

### 5.1. Conducted Output Power

#### LIMIT

N/A

#### TEST CONFIGURATION

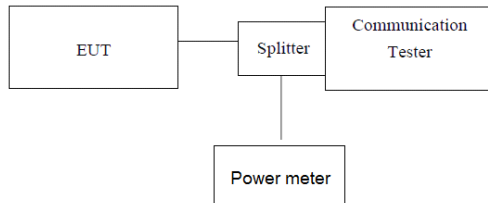

*Note: Measurement setup for testing on Antenna connector*

#### TEST PROCEDURE

1. The transmitter output port was connected to base station.
2. The RF output of EUT was connected to the power meter by RF cable and attenuator, the path loss was compensated to the results for each measurement.
3. Set EUT at maximum power through base station.
4. Select lowest, middle, and highest channels for each band and different modulation.
5. Measure the maximum burst average power.

#### TEST MODE:

Please refer to the clause 3.3

#### TEST RESULTS

**Passed**       **Not Applicable**

**Reference Appendix A:**

## 5.2. 99% & -26 dB Occupied Bandwidth

### LIMIT

N/A

### TEST CONFIGURATION

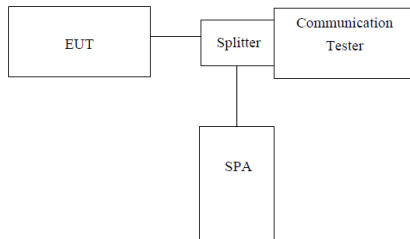

*Note: Measurement setup for testing on Antenna connector*

### TEST PROCEDURE

1. The EUT's output RF connector was connected with a short cable to the spectrum analyzer
2. RBW was set to about 1% of emission BW, VBW= 3 times RBW.
3. -26dBc display line was placed on the screen (or 99% bandwidth), the occupied bandwidth is the delta frequency between the two points where the display line intersects the signal trace.

### TEST MODE:

Please refer to the clause 3.3

### TEST RESULTS

**Passed**       **Not Applicable**

**Reference Appendix C:**

### 5.3. Conducted Spurious Emissions

#### LIMIT

Part 24.238 and Part 22.917 and Part 27.53 h(1) specify that the power of any emission outside of the authorized operating frequency ranges must be attenuated below the transmitting power (P) by a factor of at least  $43 + 10 \log(P)$  dB.

The specification that emissions shall be attenuated below the transmitter power (P) by at least  $43 + 10 \log(P)$  dB, translates in the relevant power range (1 to 0.001 W) to -13 dBm. At 1 W the specified minimum attenuation becomes 43 dB and relative to a 30 dBm (1 W) carrier becomes a limit of -13 dBm. At 0.001 W (0 dBm) the minimum attenuation is 13 dB, which again yields a limit of -13 dBm. In this way a translation of the specification from relative to absolute terms is carried out.

LTE Band 7

Part 27.53 m(4) For mobile digital stations, the attenuation factor shall be not less than  $40 + 10 \log(P)$  dB on all frequencies between the channel edge and 5 megahertz from the channel edge,  $43 + 10 \log(P)$  dB on all frequencies between 5 megahertz and X megahertz from the channel edge, and  $55 + 10 \log(P)$  dB on all frequencies more than X megahertz from the channel edge, where X is the greater of 6 megahertz or the actual emission bandwidth as defined in paragraph (m)(6) of this section. Limit  $< -25$  dBm

#### TEST CONFIGURATION

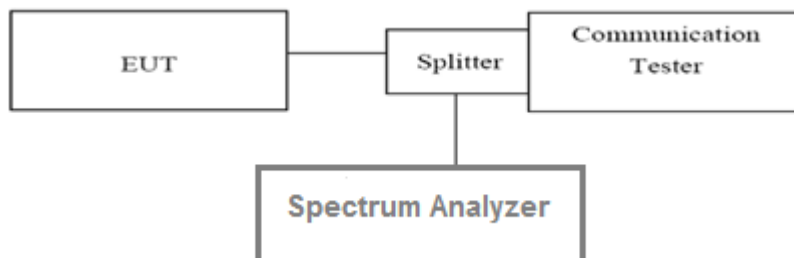

#### TEST PROCEDURE

1. The RF output of the transceiver was connected to a spectrum analyzer through appropriate attenuation.
2. The resolution bandwidth of the spectrum analyzer was set at 1MHz, sufficient scans were taken to show the out of band Emissions if any up to 10th harmonic.
3. For the out of band: Set the RBW= 1MHz, VBW = 3MHz, Start=30MHz, Stop= 10th harmonic.

#### TEST MODE:

Please refer to the clause 3.3

#### TEST RESULTS

**Passed**       **Not Applicable**

**Reference Appendix E:**

## 5.4. Band Edge

### LIMIT

Part 24.238 and Part 22.917 and Part 27.53h(1) specify that the power of any emission outside of the authorized operating frequency ranges must be attenuated below the transmitting power (P) by a factor of at least  $43 + 10 \log(P)$  dB.

The specification that emissions shall be attenuated below the transmitter power (P) by at least  $43 + 10 \log(P)$  dB, translates in the relevant power range (1 to 0.001 W) to -13 dBm. At 1 W the specified minimum attenuation becomes 43 dB and relative to a 30 dBm (1 W) carrier becomes a limit of -13 dBm. At 0.001 W (0 dBm) the minimum attenuation is 13 dB, which again yields a limit of -13 dBm. In this way a translation of the specification from relative to absolute terms is carried out.

LTE Band 7

Part 27.53 m(4) For mobile digital stations, the attenuation factor shall be not less than  $40 + 10 \log(P)$  dB on all frequencies between the channel edge and 5 megahertz from the channel edge,  $43 + 10 \log(P)$  dB on all frequencies between 5 megahertz and X megahertz from the channel edge, and  $55 + 10 \log(P)$  dB on all frequencies more than X megahertz from the channel edge, where X is the greater of 6 megahertz or the actual emission bandwidth as defined in paragraph (m)(6) of this section.

### TEST CONFIGURATION

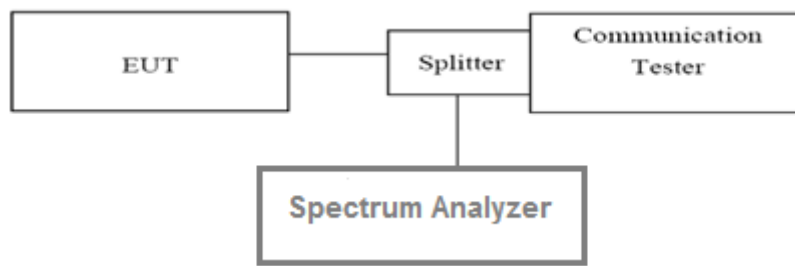

### TEST PROCEDURE

1. The RF output of the transceiver was connected to a spectrum analyzer through appropriate attenuation.
2. The band edges of low and high channels for the highest RF powers were measured. Set RBW  $\geq$  1% EBW in the 1MHz band immediately outside and adjacent to the band edge.
3. Set spectrum analyzer with RMS detector.

### TEST MODE:

Please refer to the clause 3.3

### TEST RESULTS

Passed  Not Applicable

Reference Appendix D:

## 5.5. ERP AND EIRP

### LIMIT

LTE Band 2: EIRP<2W ,LTE Band 4:EIRP<1W ,LTE Band 7:EIRP<2W,

### TEST CONFIGURATION

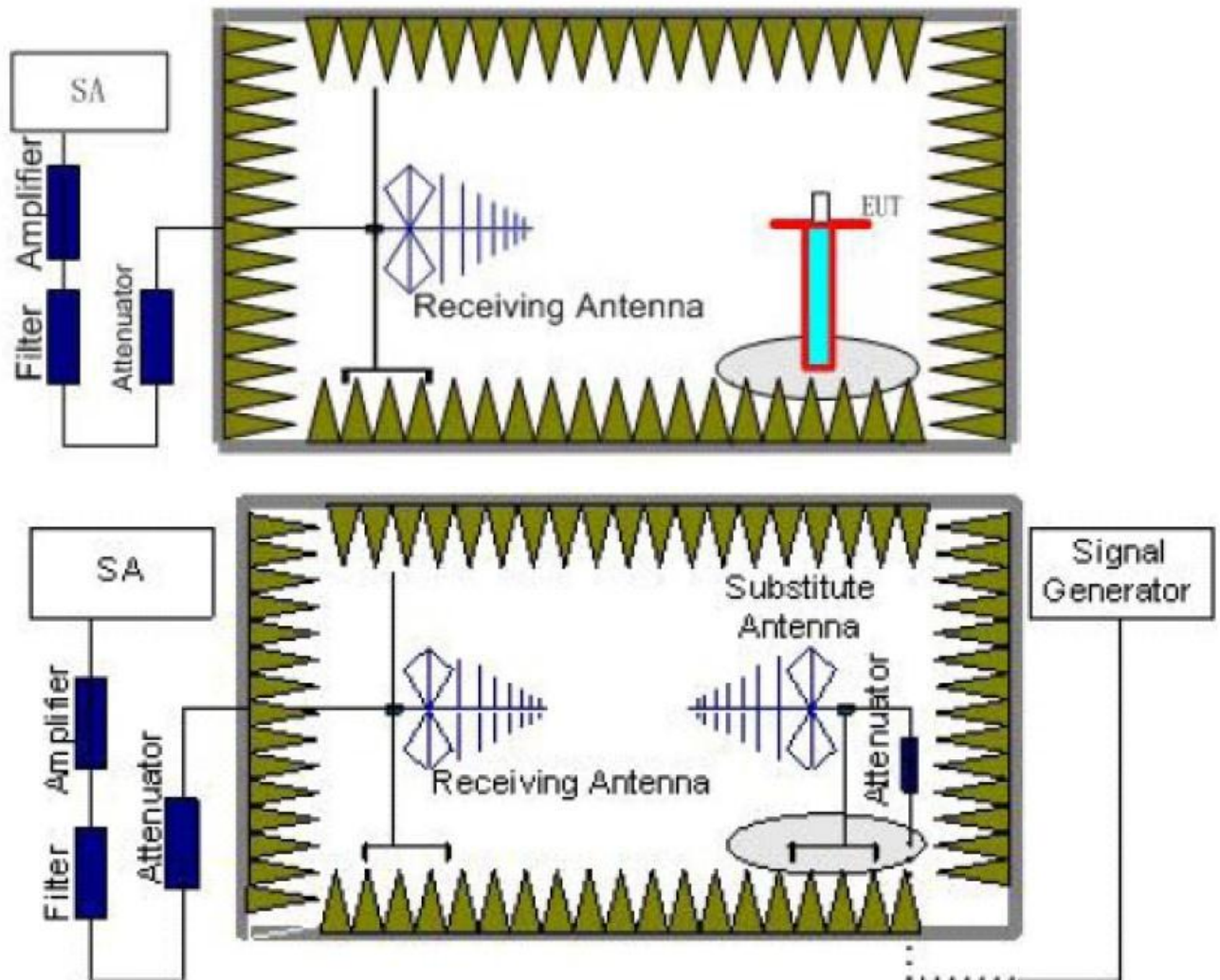

### TEST PROCEDURE

1. EUT was placed on a 0.8 meter high non-conductive stand at a 3 meter test distance from the receive antenna. A receiving antenna was placed on the antenna mast 3 meters from the EUT for emission measurements. The height of receiving antenna shall be moved from 1m to 4m. Detected emissions were maximized at each frequency by rotating the EUT through 360° and adjusting the receiving antenna polarization. The radiated emission measurements of all transmit frequencies in three channels (High, Middle, Low) were measured with peak detector.
2. A log-periodic antenna or double-ridged waveguide horn antenna shall be substituted in place of the EUT. The log-periodic antenna will be driven by a signal generator and the level will be adjusted till the same power value on the spectrum analyzer or receiver. The level of the spurious emissions can be calculated through the level of the signal generator, cable loss, the gain of the substitution antenna and the reading of the spectrum analyzer or receiver.
3. The EUT is then put into continuously transmitting mode at its maximum power level during the test. Set Test Receiver or Spectrum RBW=1MHz, VBW=3MHz for above 1GHz and RBW=100kHz, VBW=300kHz for 30MHz to 1GHz,, And the maximum value of the receiver should be recorded as (Pr).
4. The EUT shall be replaced by a substitution antenna. In the chamber, an substitution antenna for the frequency band of interest is placed at the reference point of the chamber. An RF Signal source for the frequency band of interest is connected to the substitution antenna with a cable that has been constructed to not interfere with the radiation pattern of the antenna. A power (P<sub>Mea</sub>) is applied to the input of the



substitution antenna, and adjust the level of the signal generator output until the value of the receiver reach the previously recorded (Pr). The power of signal source (PMea) is recorded. The test should be performed by rotating the test item and adjusting the receiving antenna polarization.

5. A amplifier should be connected to the Signal Source output port. And the cable should be connect between the Amplifier and the Substitution Antenna. The cable loss (Pcl) ,the Substitution Antenna Gain (Ga) and the Amplifier Gain (PAg) should be recorded after test.
6. The measurement results are obtained as described below:  
Power(EIRP)=PMea- PAg - Pcl + Ga  
We used SMF100A micowave signal generator which signal level can up to 33dBm,so we not used power Amplifier for substitution test; The measurement results are amend as described below:  
Power(EIRP)=PMea- Pcl + Ga
7. This value is EIRP since the measurement is calibrated using an antenna of known gain (2.15 dBi) and known input power.  
ERP can be calculated from EIRP by subtracting the gain of the dipole, ERP = EIRP-2.15dBi.

#### **TEST MODE:**

Please refer to the clause 3.3

#### **TEST RESULTS**

**Passed**       **Not Applicable**

LTE Band 2-1.4MHz					
Modulation	Channel	EIRP (dBm)		Limit (dBm)	Result
		Vertical	Horizontal		
QPSK	Low	22.15	20.52	33.00	PASS
	Mid	22.36	20.47		
	High	22.44	20.25		
16QAM	Low	22.86	20.41		PASS
	Mid	22.83	20.57		
	High	22.39	20.35		

LTE Band 2-3MHz					
Modulation	Channel	EIRP (dBm)		Limit (dBm)	Result
		Vertical	Horizontal		
QPSK	Low	22.22	20.25	33.00	PASS
	Mid	22.28	20.43		
	High	22.14	20.55		
16QAM	Low	22.68	20.35		PASS
	Mid	22.97	20.61		
	High	22.21	20.56		

LTE Band 2-5MHz					
Modulation	Channel	EIRP (dBm)		Limit (dBm)	Result
		Vertical	Horizontal		
QPSK	Low	22.44	20.25	33.00	PASS
	Mid	22.52	20.47		
	High	22.28	20.52		
16QAM	Low	21.64	20.25		PASS
	Mid	21.72	20.47		
	High	22.92	20.66		

LTE Band 2-10MHz					
Modulation	Channel	EIRP (dBm)		Limit (dBm)	Result
		Vertical	Horizontal		
QPSK	Low	22.26	20.58	33.00	PASS
	Mid	22.47	20.47		
	High	22.37	20.55		
16QAM	Low	22.13	19.95		PASS
	Mid	22.71	20.60		
	High	22.16	20.31		

LTE Band 2-15MHz					
Modulation	Channel	EIRP (dBm)		Limit (dBm)	Result
		Vertical	Horizontal		
QPSK	Low	20.64	19.55	33.00	PASS
	Mid	20.52	19.36		
	High	20.88	19.43		
16QAM	Low	20.04	19.55		
	Mid	20.52	19.36		
	High	20.73	19.43		

LTE Band 2-20MHz					
Modulation	Channel	EIRP (dBm)		Limit (dBm)	Result
		Vertical	Horizontal		
QPSK	Low	20.55	19.58	33.00	PASS
	Mid	20.34	19.52		
	High	20.64	19.36		
16QAM	Low	19.99	19.46		
	Mid	19.51	19.31		
	High	20.74	19.38		

LTE Band 4-1.4MHz					
Modulation	Channel	EIRP (dBm)		Limit (dBm)	Result
		Vertical	Horizontal		
QPSK	Low	22.25	20.22	30.00	PASS
	Mid	22.17	20.54		
	High	22.38	20.36		
16QAM	Low	21.42	20.39		
	Mid	21.46	20.38		
	High	22.12	20.20		

LTE Band 4-3MHz					
Modulation	Channel	EIRP (dBm)		Limit (dBm)	Result
		Vertical	Horizontal		
QPSK	Low	22.43	20.08	30.00	PASS
	Mid	22.17	20.15		
	High	22.52	20.66		
16QAM	Low	21.73	19.93		
	Mid	21.13	19.88		
	High	22.67	20.69		

LTE Band 4-5MHz						
Modulation	Channel	EIRP (dBm)		Limit (dBm)	Result	
		Vertical	Horizontal			
QPSK	Low	22.14	20.22	30.00	PASS	
	Mid	22.08	20.43			
	High	22.15	20.22			
16QAM	Low	21.37	20.05		30.00	PASS
	Mid	22.85	20.57			
	High	21.54	20.09			

LTE Band 4-10MHz						
Modulation	Channel	EIRP (dBm)		Limit (dBm)	Result	
		Vertical	Horizontal			
QPSK	Low	22.18	20.15	30.00	PASS	
	Mid	22.06	20.26			
	High	22.22	20.43			
16QAM	Low	21.94	20.18		30.00	PASS
	Mid	22.03	20.23			
	High	22.05	20.40			

LTE Band 4-15MHz						
Modulation	Channel	EIRP (dBm)		Limit (dBm)	Result	
		Vertical	Horizontal			
QPSK	Low	21.96	19.66	30.00	PASS	
	Mid	21.78	19.74			
	High	21.84	19.55			
16QAM	Low	21.37	19.66		30.00	PASS
	Mid	21.78	19.74			
	High	21.69	19.55			

LTE Band 4-20MHz						
Modulation	Channel	EIRP (dBm)		Limit (dBm)	Result	
		Vertical	Horizontal			
QPSK	Low	21.88	19.44	30.00	PASS	
	Mid	21.96	19.52			
	High	21.54	19.37			
16QAM	Low	21.33	19.33		30.00	PASS
	Mid	21.14	19.31			
	High	22.32	19.54			

LTE Band 7-5MHz					
Modulation	Channel	EIRP (dBm)		Limit (dBm)	Result
		Vertical	Horizontal		
QPSK	Low	19.84	17.55	33.00	PASS
	Mid	19.52	17.43		
	High	19.43	17.36		
16QAM	Low	19.94	17.47		
	Mid	19.45	17.50		
	High	19.75	17.29		

LTE Band 7-10MHz					
Modulation	Channel	EIRP (dBm)		Limit (dBm)	Result
		Vertical	Horizontal		
QPSK	Low	19.22	17.56	33.00	PASS
	Mid	19.66	17.48		
	High	19.34	17.55		
16QAM	Low	19.54	17.63		
	Mid	20.14	17.60		
	High	19.37	17.56		

LTE Band 7-15MHz					
Modulation	Channel	EIRP (dBm)		Limit (dBm)	Result
		Vertical	Horizontal		
QPSK	Low	19.58	17.38	33.00	PASS
	Mid	19.25	17.52		
	High	19.46	17.43		
16QAM	Low	19.22	17.46		
	Mid	19.53	17.46		
	High	19.73	17.49		

LTE Band 7-20MHz					
Modulation	Channel	EIRP (dBm)		Limit (dBm)	Result
		Vertical	Horizontal		
QPSK	Low	19.52	17.38	33.00	PASS
	Mid	19.43	17.52		
	High	19.88	17.66		
16QAM	Low	19.92	17.55		
	Mid	19.71	17.39		
	High	20.31	17.55		

## 5.6. Radiated Spurious Emission

### LIMIT

LTE Band 2/4/5/17:<-13dBm;LTE Band 7<-25dBm

### TEST CONFIGURATION

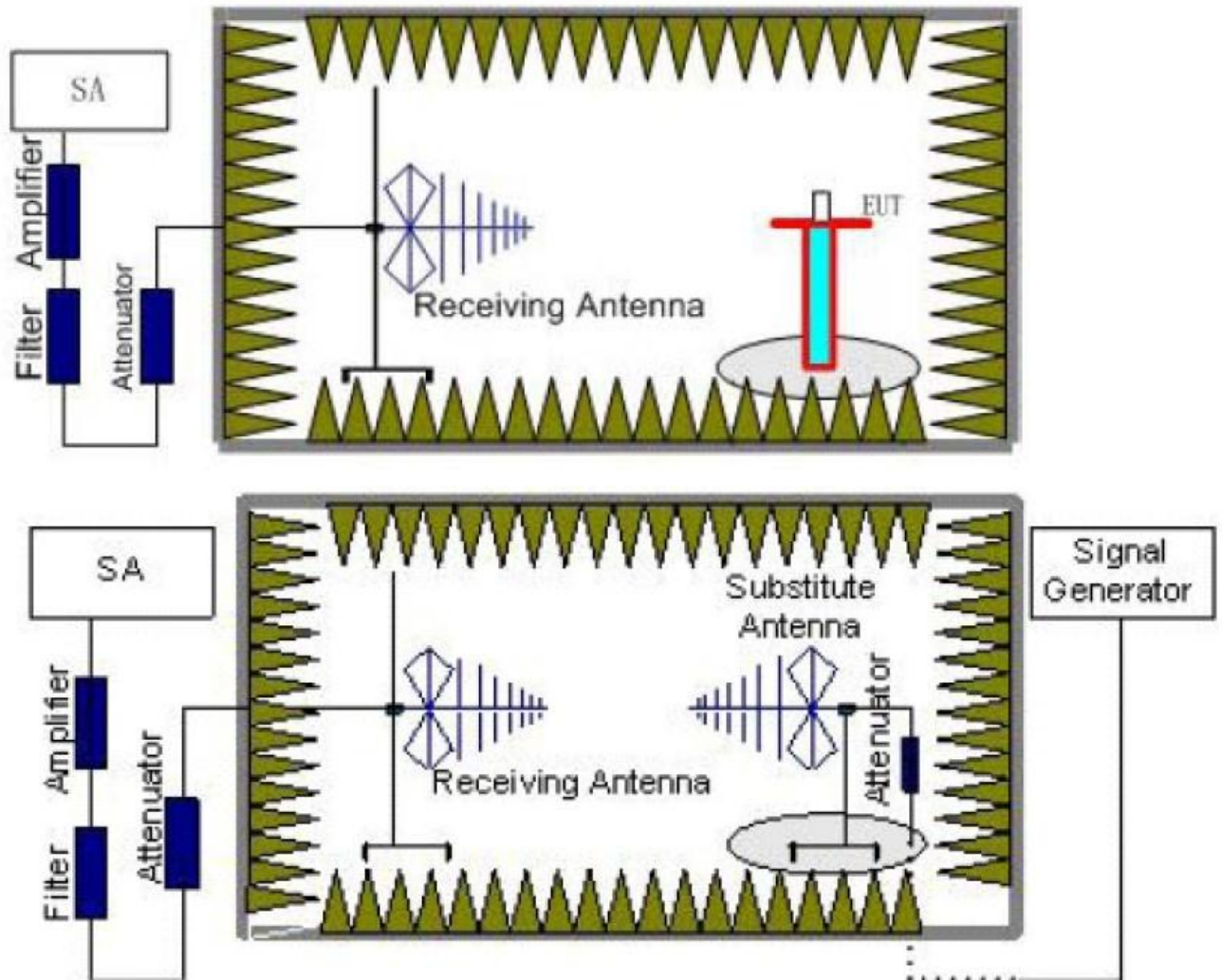

### TEST RESULTS

1. EUT was placed on a 0.8 meter high non-conductive stand at a 3 meter test distance from the receive antenna. A receiving antenna was placed on the antenna mast 3 meters from the EUT for emission measurements. The height of receiving antenna shall be moved from 1m to 4m. Detected emissions were maximized at each frequency by rotating the EUT through 360° and adjusting the receiving antenna polarization. The radiated emission measurements of all transmit frequencies in three channels (High, Middle, Low) were measured with peak detector.
2. A log-periodic antenna or double-ridged waveguide horn antenna shall be substituted in place of the EUT. The log-periodic antenna will be driven by a signal generator and the level will be adjusted till the same power value on the spectrum analyzer or receiver. The level of the spurious emissions can be calculated through the level of the signal generator, cable loss, the gain of the substitution antenna and the reading of the spectrum analyzer or receiver.
3. The EUT is then put into continuously transmitting mode at its maximum power level during the test. Set Test Receiver or Spectrum RBW=1MHz,VBW=3MHz for above 1GHz and RBW=100kHz,VBW=300kHz for 30MHz to 1GHz, And the maximum value of the receiver should be recorded as (Pr).
4. The EUT shall be replaced by a substitution antenna. In the chamber, an substitution antenna for the frequency band of interest is placed at the reference point of the chamber. An RF Signal source for the frequency band of interest is connected to the substitution antenna with a cable that has been constructed to not interfere with the radiation pattern of the antenna. A power (PMea) is applied to the input of the substitution antenna, and adjust the level of the signal generator output until the value of the receiver

reach the previously recorded (Pr). The power of signal source (PMea) is recorded. The test should be performed by rotating the test item and adjusting the receiving antenna polarization.

5. A amplifier should be connected to the Signal Source output port. And the cable should be connect between the Amplifier and the Substitution Antenna. The cable loss (Pcl) ,the Substitution Antenna Gain (Ga) and the Amplifier Gain (PAg) should be recorded after test.
6. The measurement results are obtained as described below:  
Power(EIRP)=PMea- PAg - Pcl + Ga  
We used SMF100A micowave signal generator which signal level can up to 33dBm,so we not used power Amplifier for substitution test; The measurement results are amend as described below:  
Power(EIRP)=PMea- Pcl + Ga
7. This value is EIRP since the measurement is calibrated using an antenna of known gain (2.15 dBi) and known input power.  
ERP can be calculated from EIRP by subtracting the gain of the dipole, ERP = EIRP-2.15dBi.

#### **TEST MODE:**

Please refer to the clause 3.3

#### **TEST RESULTS**

**Passed**       **Not Applicable**

LTE Band 2-1.4MHz					
Channel	Frequency (MHz)	Spurious Emission		Limit (dBm)	Result
		Polarization	Level (dBm)		
Low	3701.4	Vertical	-39.43	-13.00	Pass
	5552.1	V	-34.85		
	7402.8	V	---		
	3701.4	Horizontal	-40.88	-13.00	Pass
	5552.1	H	-37.52		
	7402.8	H	---		
Mid	3760	Vertical	-39.16	-13.00	Pass
	5640	V	-34.91		
	7520	V	---		
	3760	Horizontal	-40.82	-13.00	Pass
	5640	H	-37.46		
	7520	H	---		
High	3818.6	Vertical	-39.26	-13.00	Pass
	5727.9	V	-35.00		
	7637.2	V	---		
	3818.6	Horizontal	-40.83	-13.00	Pass
	5727.9	H	-37.46		
	7637.2	H	---		

## Remark:

1. Remark"---" means that the emission level is too low to be measured
2. The emission levels of below 1 GHz are very lower than the limit and not show in test report.

LTE Band 2-3MHz					
Channel	Frequency (MHz)	Spurious Emission		Limit (dBm)	Result
		Polarization	Level (dBm)		
Low	3703	Vertical	-39.69	-13.00	Pass
	5554.5	V	-34.98		
	7406	V	---		
	3703	Horizontal	-39.11	-13.00	Pass
	5554.5	H	-35.10		
	7406	H	---		
Mid	3760	Vertical	-39.21	-13.00	Pass
	5640	V	-35.48		
	7520	V	---		
	3760	Horizontal	-39.48	-13.00	Pass
	5640	H	-36.50		
	7520	H	---		
High	3817	Vertical	-37.72	-13.00	Pass
	5725.5	V	-36.16		
	7634	V	---		
	3817	Horizontal	-38.44	-13.00	Pass
	5725.5	H	-36.31		
	7634	H	---		

## Remark:

1. Remark"---" means that the emission level is too low to be measured
2. The emission levels of below 1 GHz are very lower than the limit and not show in test report.



LTE Band 2-5MHz					
Channel	Frequency (MHz)	Spurious Emission		Limit (dBm)	Result
		Polarization	Level (dBm)		
Low	3705	Vertical	-39.28	-13.00	Pass
	5557.5	V	-35.15		
	7410	V	---		
	3705	Horizontal	-38.49	-13.00	Pass
	5557.5	H	-35.31		
	7410	H	---		
Mid	3760	Vertical	-38.62	-13.00	Pass
	5640	V	-35.84		
	7520	V	---		
	3760	Horizontal	-38.10	-13.00	Pass
	5640	H	-35.28		
	7520	H	---		
High	3815	Vertical	-39.06	-13.00	Pass
	5722.5	V	-35.47		
	7630	V	---		
	3815	Horizontal	-39.61	-13.00	Pass
	5722.5	H	-35.58		
	7630	H	---		

## Remark:

1. Remark"---" means that the emission level is too low to be measured
2. The emission levels of below 1 GHz are very lower than the limit and not show in test report.

LTE Band 2-10MHz					
Channel	Frequency (MHz)	Spurious Emission		Limit (dBm)	Result
		Polarization	Level (dBm)		
Low	3710	Vertical	-38.72	-13.00	Pass
	5565	V	-35.45		
	7420	V	---		
	3710	Horizontal	-37.37	-13.00	Pass
	5565	H	-35.73		
	7420	H	---		
Mid	3760	Vertical	-37.59	-13.00	Pass
	5640	V	-36.62		
	7520	V	---		
	3760	Horizontal	-36.70	-13.00	Pass
	5640	H	-35.97		
	7520	H	---		
High	3810	Vertical	-37.83	-13.00	Pass
	5715	V	-36.18		
	7620	V	---		
	3810	Horizontal	-37.07	-13.00	Pass
	5715	H	-36.03		
	7620	H	---		

## Remark:

1. Remark"---" means that the emission level is too low to be measured
2. The emission levels of below 1 GHz are very lower than the limit and not show in test report.

LTE Band 2-15MHz					
Channel	Frequency (MHz)	Spurious Emission		Limit (dBm)	Result
		Polarization	Level (dBm)		
Low	3715	Vertical	-37.77	-13.00	Pass
	5572.5	V	-35.84		
	7430	V	---		
	3715	Horizontal	-35.99		
	5572.5	H	-36.21		
	7430	H	---		
Mid	3760	Vertical	-36.28	-13.00	Pass
	5640	V	-37.39		
	7520	V	---		
	3760	Horizontal	-35.10		
	5640	H	-36.92		
	7520	H	---		
High	3805	Vertical	-35.91	-13.00	Pass
	5707.5	V	-37.07		
	7610	V	---		
	3805	Horizontal	-36.16		
	5707.5	H	-37.12		
	7610	H	---		

## Remark:

1. Remark"---" means that the emission level is too low to be measured
2. The emission levels of below 1 GHz are very lower than the limit and not show in test report.

LTE Band 2-20MHz					
Channel	Frequency (MHz)	Spurious Emission		Limit (dBm)	Result
		Polarization	Level (dBm)		
Low	3720	Vertical	-36.51	-13.00	Pass
	5580	V	-36.28		
	7440	V	---		
	3720	Horizontal	-34.50		
	5580	H	-36.70		
	7440	H	---		
Mid	3760	Vertical	-34.83	-13.00	Pass
	5640	V	-38.03		
	7520	V	---		
	3760	Horizontal	-33.50		
	5640	H	-38.84		
	7520	H	---		
High	3800	Vertical	-32.10	-13.00	Pass
	5700	V	-38.58		
	7600	V	---		
	3800	Horizontal	-33.52		
	5700	H	-38.87		
	7600	H	---		

## Remark:

1. Remark"---" means that the emission level is too low to be measured
2. The emission levels of below 1 GHz are very lower than the limit and not show in test report.

LTE Band 4-1.4MHz					
Channel	Frequency (MHz)	Spurious Emission		Limit (dBm)	Result
		Polarization	Level (dBm)		
Low	3421.4	Vertical	-40.52	-13.00	Pass
	5132.1	V	-44.78		
	6842.8	V	---		
	3421.4	Horizontal	-43.52		
	5132.1	H	-46.87		
	6842.8	H	---		
Mid	3465	Vertical	-40.63	-13.00	Pass
	5197.5	V	-44.68		
	6930	V	---		
	3465	Horizontal	-43.39		
	5197.5	H	-46.76		
	6930	H	---		
High	3508.6	Vertical	-40.80	-13.00	Pass
	5262.9	V	-44.85		
	7017.2	V	---		
	3508.6	Horizontal	-43.40		
	5262.9	H	-46.78		
	7017.2	H	---		

## Remark:

1. Remark"---" means that the emission level is too low to be measured
2. The emission levels of below 1 GHz are very lower than the limit and not show in test report.

LTE Band 4-3MHz					
Channel	Frequency (MHz)	Spurious Emission		Limit (dBm)	Result
		Polarization	Level (dBm)		
Low	3423	Vertical	-40.99	-13.00	Pass
	5134.5	V	-45.05		
	6846	V	---		
	3423	Horizontal	-43.65		
	5134.5	H	-47.12		
	6846	H	---		
Mid	3465	Vertical	-40.79	-13.00	Pass
	5197.5	V	-44.86		
	6930	V	---		
	3465	Horizontal	-43.97		
	5197.5	H	-46.86		
	6930	H	---		
High	3507	Vertical	-40.34	-13.00	Pass
	5260.5	V	-45.26		
	7014	V	---		
	3423	Horizontal	-44.23		
	5134.5	H	-46.62		
	6846	H	---		

## Remark:

1. Remark"---" means that the emission level is too low to be measured
2. The emission levels of below 1 GHz are very lower than the limit and not show in test report.

LTE Band 4-5MHz					
Channel	Frequency (MHz)	Spurious Emission		Limit (dBm)	Result
		Polarization	Level (dBm)		
Low	3425	Vertical	-40.13	-13.00	Pass
	5137.5	V	-45.22		
	6850	V	---		
	3425	Horizontal	-44.41	-13.00	Pass
	5137.5	H	-46.78		
	6850	H	---		
Mid	3465	Vertical	-40.00	-13.00	Pass
	5197.5	V	-45.10		
	6930	V	-		
	3465	Horizontal	-44.56	-13.00	Pass
	5197.5	H	-46.90		
	6930	H	---		
High	3505	Vertical	-39.79	-13.00	Pass
	5257.5	V	-44.90		
	7010	V	-		
	3505	Horizontal	-44.68	-13.00	Pass
	5257.5	H	-47.02		
	7010	H	---		

## Remark:

1. Remark"---" means that the emission level is too low to be measured
2. The emission levels of below 1 GHz are very lower than the limit and not show in test report.

LTE Band 4-10MHz					
Channel	Frequency (MHz)	Spurious Emission		Limit (dBm)	Result
		Polarization	Level (dBm)		
Low	3430	Vertical	-39.58	-13.00	Pass
	5145	V	-45.52		
	6860	V	---		
	3430	Horizontal	-44.26	-13.00	Pass
	5145	H	-46.66		
	6860	H	---		
Mid	3465	Vertical	-39.80	-13.00	Pass
	5197.5	V	-45.73		
	6930	V	---		
	3465	Horizontal	-44.08	-13.00	Pass
	5197.5	H	-46.52		
	6930	H	-		
High	3500	Vertical	-40.05	-13.00	Pass
	5250	V	-45.96		
	7000	V	-		
	3500	Horizontal	-43.91	-13.00	Pass
	5250	H	-46.36		
	7000	H	---		

## Remark:

1. Remark"---" means that the emission level is too low to be measured
2. The emission levels of below 1 GHz are very lower than the limit and not show in test report.

LTE Band 4-15MHz					
Channel	Frequency (MHz)	Spurious Emission		Limit (dBm)	Result
		Polarization	Level (dBm)		
Low	3435	Vertical	-38.62	-13.00	Pass
	5152.5	V	-45.91		
	6870	V	---		
	3435	Horizontal	-44.30	-13.00	Pass
	5152.5	H	-45.99		
	6870	H	---		
Mid	3465	Vertical	-38.92	-13.00	Pass
	5197.5	V	-46.18		
	6930	V	---		
	3465	Horizontal	-44.45	-13.00	Pass
	5197.5	H	-46.11		
	6930	H	---		
High	3495	Vertical	-38.71	-13.00	Pass
	5242.5	V	-46.00		
	6990	V	---		
	3495	Horizontal	-44.39	-13.00	Pass
	5242.5	H	-46.06		
	6990	H	---		

## Remark:

1. Remark"---" means that the emission level is too low to be measured
2. The emission levels of below 1 GHz are very lower than the limit and not show in test report.

LTE Band 4-20MHz					
Channel	Frequency (MHz)	Spurious Emission		Limit (dBm)	Result
		Polarization	Level (dBm)		
Low	3440	Vertical	-37.37	-13.00	Pass
	5160	V	-46.44		
	6880	V	---		
	3440	Horizontal	-43.98	-13.00	Pass
	5160	H	-46.41		
	6880	H	---		
Mid	3465	Vertical	-37.05	-13.00	Pass
	5197.5	V	-46.61		
	6930	V	---		
	3465	Horizontal	-44.15	-13.00	Pass
	5197.5	H	-46.27		
	6930	H	---		
High	3490	Vertical	-36.82	-13.00	Pass
	5235	V	-46.19		
	6980	V	---		
	3490	Horizontal	-43.67	-13.00	Pass
	5235	H	-46.12		
	6980	H	---		

## Remark:

1. Remark"---" means that the emission level is too low to be measured
2. The emission levels of below 1 GHz are very lower than the limit and not show in test report.

LTE Band 7-5MHz					
Channel	Frequency (MHz)	Spurious Emission		Limit (dBm)	Result
		Polarization	Level (dBm)		
Low	5005	Vertical	-44.55	-25.00	Pass
	7507.5	V	-48.74		
	10010	V	---		
	5005	Horizontal	-45.63	-25.00	Pass
	7507.5	H	-50.25		
	10010	H	---		
Mid	5070	Vertical	-45.42	-25.00	Pass
	7605	V	-49.51		
	10140	V	---		
	5070	Horizontal	-46.53	-25.00	Pass
	7605	H	-48.82		
	10140	H	---		
High	5135	Vertical	-44.73	-25.00	Pass
	7702.5	V	-48.37		
	10270	V	---		
	5135	Horizontal	-46.23	-25.00	Pass
	7702.5	H	-48.43		
	10270	H	---		

## Remark:

1. Remark"---" means that the emission level is too low to be measured
2. The emission levels of below 1 GHz are very lower than the limit and not show in test report.

LTE Band 7-10MHz					
Channel	Frequency (MHz)	Spurious Emission		Limit (dBm)	Result
		Polarization	Level (dBm)		
Low	5010	Vertical	-44.54	-25.00	Pass
	7515	V	-48.75		
	10020	V	---		
	5010	Horizontal	-45.57	-25.00	Pass
	7515	H	-50.24		
	10020	H	---		
Mid	5070	Vertical	-44.49	-25.00	Pass
	7605	V	-48.71		
	10140	V	---		
	5070	Horizontal	-45.80	-25.00	Pass
	7605	H	-48.54		
	10140	H	---		
High	5130	Vertical	-44.31	-25.00	Pass
	7695	V	-48.42		
	10260	V	---		
	5130	Horizontal	-45.78	-25.00	Pass
	7695	H	-48.43		
	10260	H	---		

## Remark:

1. Remark"---" means that the emission level is too low to be measured
2. The emission levels of below 1 GHz are very lower than the limit and not show in test report.

LTE Band 7-15MHz					
Channel	Frequency (MHz)	Spurious Emission		Limit (dBm)	Result
		Polarization	Level (dBm)		
Low	5015	Vertical	-44.54	-25.00	Pass
	7522.5	V	-48.75		
	10030	V	---		
	5015	Horizontal	-45.59	-25.00	Pass
	7522.5	H	-50.24		
	10030	H	---		
Mid	5070	Vertical	-44.55	-25.00	Pass
	7605	V	-48.76		
	10140	V	---		
	5070	Horizontal	-44.65	-25.00	Pass
	7605	H	-49.48		
	10140	H	---		
High	5125	Vertical	-45.27	-25.00	Pass
	7687.5	V	-49.95		
	10250	V	---		
	5125	Horizontal	-44.33	-25.00	Pass
	7687.5	H	-50.01		
	10250	H	---		

## Remark:

1. Remark"---" means that the emission level is too low to be measured
2. The emission levels of below 1 GHz are very lower than the limit and not show in test report.

LTE Band 7-20MHz					
Channel	Frequency (MHz)	Spurious Emission		Limit (dBm)	Result
		Polarization	Level (dBm)		
Low	5020	Vertical	-44.48	-25.00	Pass
	7530	V	-48.81		
	10040	V	---		
	5020	Horizontal	-45.32	-25.00	Pass
	7530	H	-50.18		
	10040	H	---		
Mid	5070	Vertical	-44.26	-25.00	Pass
	7605	V	-48.62		
	10140	V	---		
	5070	Horizontal	-46.30	-25.00	Pass
	7605	H	-47.86		
	10140	H	---		
High	5120	Vertical	-43.50	-25.00	Pass
	7680	V	-47.37		
	10240	V	---		
	5120	Horizontal	-45.94	-25.00	Pass
	7680	H	-47.44		
	10240	H	---		

## Remark:

1. Remark"---" means that the emission level is too low to be measured
2. The emission levels of below 1 GHz are very lower than the limit and not show in test report.

## 5.7. Frequency stability V.S. Temperature measurement

### LIMIT

2.5ppm

### TEST CONFIGURATION

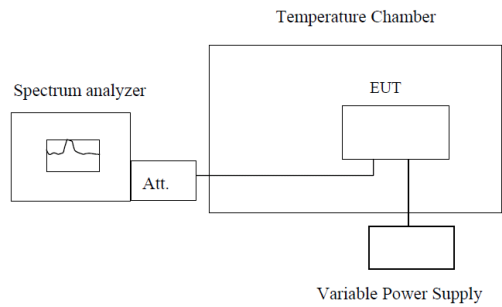

**Note :** Measurement setup for testing on Antenna connector

### TEST PROCEDURE

1. The equipment under test was connected to an external DC power supply and input rated voltage.
2. RF output was connected to a frequency counter or spectrum analyzer via feed through attenuators.
3. The EUT was placed inside the temperature chamber.
4. Set the spectrum analyzer RBW low enough to obtain the desired frequency resolution and measure EUT 25°C operating frequency as reference frequency.
5. Turn EUT off and set the chamber temperature to -30°C. After the temperature stabilized for approximately 30 minutes recorded the frequency.
6. Repeat step measure with 10°C increased per stage until the highest temperature of +50°C reached.

### TEST MODE:

Please refer to the clause 3.3

### TEST RESULTS

**Passed**       **Not Applicable**

**Reference Appendix F:**



## 5.8. Frequency stability V.S. Voltage measurement

### LIMIT

2.5ppm

### TEST CONFIGURATION

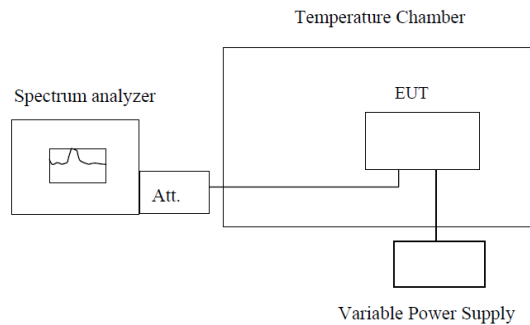

**Note :** Measurement setup for testing on Antenna connector

### TEST PROCEDURE

1. Set chamber temperature to 25°C. Use a variable DC power source to power the EUT and set the voltage to rated voltage.
2. Set the spectrum analyzer RBW low enough to obtain the desired frequency resolution and record the frequency.
3. Reduce the input voltage to specified extreme voltage variation (+/- 15%) and endpoint, record the maximum frequency change.

### TEST MODE:

Please refer to the clause 3.3

### TEST RESULTS

**Passed**       **Not Applicable**

**Reference Appendix F:**

## 5.9. Peak-Average Ratio

### LIMIT

13dB

### TEST CONFIGURATION

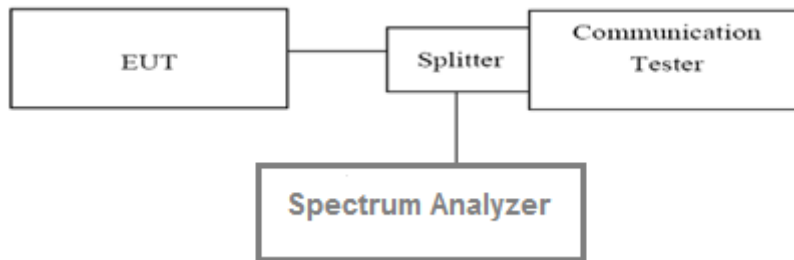

### TEST PROCEDURE

According with KDB 971168

1. The signal analyzer's CCDF measurement profile is enabled
2. Frequency = carrier center frequency
3. Measurement BW > Emission bandwidth of signal
4. The signal analyzer was set to collect one million samples to generate the CCDF curve
5. The measurement interval was set depending on the type of signal analyzed. For continuous signals (>98% duty cycle), the measurement interval was set to 1ms. For burst transmissions, the spectrum analyzer is set to use an internal "RF Burst" trigger that is synced with an incoming pulse and the measurement interval is set to less than the duration of the "on time" of one burst to ensure that energy is only captured during a time in which the transmitter is operating at maximum power

### TEST MODE:

Please refer to the clause 3.3

### TEST RESULTS

Passed       Not Applicable

**Reference Appendix B:**

## 6. Test Setup Photos of the EUT

Radiated emission:

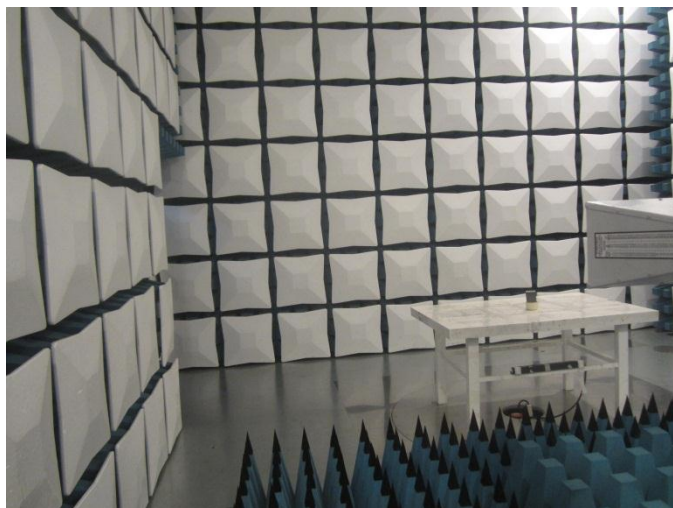
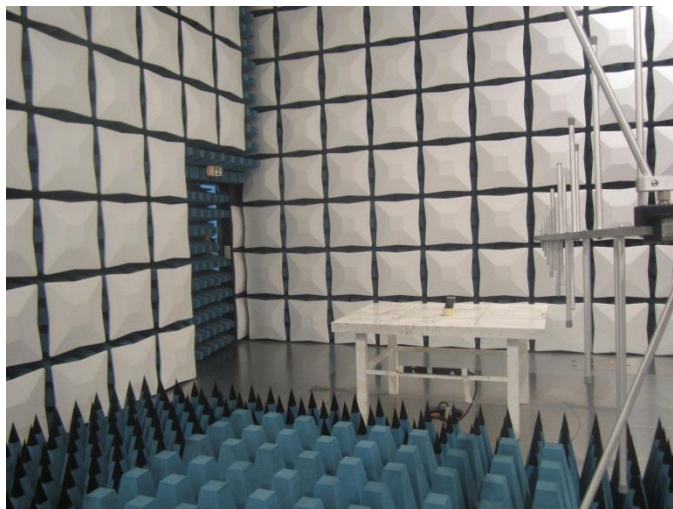

## 7. External and Internal Photos of the EUT

Reference to the test report No.: TRE1706025201.

.....End of Report.....

## Appendix A: Maximum Output Power

### Test Result

Band	Bandwidth	Modulation	Channel	RB Configuration	Max.Average Power [dBm]	Verdict
2	1.4MHz	QPSK	18607	1RB#0	23.27	PASS
2	1.4MHz	16QAM	18607	1RB#0	22.39	PASS
2	1.4MHz	QPSK	18607	1RB#2	23.34	PASS
2	1.4MHz	16QAM	18607	1RB#2	22.55	PASS
2	1.4MHz	QPSK	18607	1RB#5	23.27	PASS
2	1.4MHz	16QAM	18607	1RB#5	22.45	PASS
2	1.4MHz	QPSK	18607	3RB#0	23.35	PASS
2	1.4MHz	16QAM	18607	3RB#0	23.35	PASS
2	1.4MHz	QPSK	18607	3RB#1	23.36	PASS
2	1.4MHz	16QAM	18607	3RB#1	23.36	PASS
2	1.4MHz	QPSK	18607	3RB#3	23.37	PASS
2	1.4MHz	16QAM	18607	3RB#3	23.37	PASS
2	1.4MHz	QPSK	18607	6RB#0	22.34	PASS
2	1.4MHz	16QAM	18607	6RB#0	21.25	PASS
2	1.4MHz	QPSK	18900	1RB#0	23.57	PASS
2	1.4MHz	16QAM	18900	1RB#0	22.49	PASS
2	1.4MHz	QPSK	18900	1RB#2	23.62	PASS
2	1.4MHz	16QAM	18900	1RB#2	22.57	PASS
2	1.4MHz	QPSK	18900	1RB#5	23.56	PASS
2	1.4MHz	16QAM	18900	1RB#5	22.47	PASS
2	1.4MHz	QPSK	18900	3RB#0	23.63	PASS
2	1.4MHz	16QAM	18900	3RB#0	23.64	PASS
2	1.4MHz	QPSK	18900	3RB#1	23.65	PASS
2	1.4MHz	16QAM	18900	3RB#1	23.65	PASS
2	1.4MHz	QPSK	18900	3RB#3	23.62	PASS
2	1.4MHz	16QAM	18900	3RB#3	23.61	PASS
2	1.4MHz	QPSK	18900	6RB#0	22.65	PASS
2	1.4MHz	16QAM	18900	6RB#0	21.66	PASS
2	1.4MHz	QPSK	19193	1RB#0	23.33	PASS
2	1.4MHz	16QAM	19193	1RB#0	22.40	PASS
2	1.4MHz	QPSK	19193	1RB#2	23.48	PASS
2	1.4MHz	16QAM	19193	1RB#2	22.57	PASS
2	1.4MHz	QPSK	19193	1RB#5	23.49	PASS
2	1.4MHz	16QAM	19193	1RB#5	22.43	PASS
2	1.4MHz	QPSK	19193	3RB#0	23.43	PASS

2	1.4MHz	16QAM	19193	3RB#0	23.44	PASS
2	1.4MHz	QPSK	19193	3RB#1	23.43	PASS
2	1.4MHz	16QAM	19193	3RB#1	23.44	PASS
2	1.4MHz	QPSK	19193	3RB#3	23.45	PASS
2	1.4MHz	16QAM	19193	3RB#3	23.45	PASS
2	1.4MHz	QPSK	19193	6RB#0	22.49	PASS
2	1.4MHz	16QAM	19193	6RB#0	21.51	PASS
2	3MHz	QPSK	18615	15RB#0	22.43	PASS
2	3MHz	16QAM	18615	15RB#0	21.37	PASS
2	3MHz	QPSK	18615	1RB#0	23.25	PASS
2	3MHz	16QAM	18615	1RB#0	22.44	PASS
2	3MHz	QPSK	18615	1RB#14	23.33	PASS
2	3MHz	16QAM	18615	1RB#14	22.46	PASS
2	3MHz	QPSK	18615	1RB#8	23.33	PASS
2	3MHz	16QAM	18615	1RB#8	22.47	PASS
2	3MHz	QPSK	18615	8RB#0	22.47	PASS
2	3MHz	16QAM	18615	8RB#0	22.47	PASS
2	3MHz	QPSK	18615	8RB#4	22.51	PASS
2	3MHz	16QAM	18615	8RB#4	22.51	PASS
2	3MHz	QPSK	18615	8RB#7	22.45	PASS
2	3MHz	16QAM	18615	8RB#7	22.46	PASS
2	3MHz	QPSK	18900	15RB#0	22.72	PASS
2	3MHz	16QAM	18900	15RB#0	21.65	PASS
2	3MHz	QPSK	18900	1RB#0	23.60	PASS
2	3MHz	16QAM	18900	1RB#0	22.51	PASS
2	3MHz	QPSK	18900	1RB#14	23.59	PASS
2	3MHz	16QAM	18900	1RB#14	22.51	PASS
2	3MHz	QPSK	18900	1RB#8	23.63	PASS
2	3MHz	16QAM	18900	1RB#8	22.56	PASS
2	3MHz	QPSK	18900	8RB#0	22.51	PASS
2	3MHz	16QAM	18900	8RB#0	22.51	PASS
2	3MHz	QPSK	18900	8RB#4	22.56	PASS
2	3MHz	16QAM	18900	8RB#4	22.56	PASS
2	3MHz	QPSK	18900	8RB#7	22.51	PASS
2	3MHz	16QAM	18900	8RB#7	22.50	PASS
2	3MHz	QPSK	19185	15RB#0	22.45	PASS
2	3MHz	16QAM	19185	15RB#0	21.49	PASS
2	3MHz	QPSK	19185	1RB#0	23.15	PASS
2	3MHz	16QAM	19185	1RB#0	22.40	PASS
2	3MHz	QPSK	19185	1RB#14	23.34	PASS
2	3MHz	16QAM	19185	1RB#14	22.47	PASS
2	3MHz	QPSK	19185	1RB#8	23.30	PASS
2	3MHz	16QAM	19185	1RB#8	22.47	PASS

2	3MHz	QPSK	19185	8RB#0	22.41	PASS
2	3MHz	16QAM	19185	8RB#0	22.40	PASS
2	3MHz	QPSK	19185	8RB#4	22.48	PASS
2	3MHz	16QAM	19185	8RB#4	22.48	PASS
2	3MHz	QPSK	19185	8RB#7	22.49	PASS
2	3MHz	16QAM	19185	8RB#7	22.49	PASS
2	5MHz	QPSK	18625	12RB#0	22.50	PASS
2	5MHz	16QAM	18625	12RB#0	22.50	PASS
2	5MHz	QPSK	18625	12RB#13	22.54	PASS
2	5MHz	16QAM	18625	12RB#13	22.54	PASS
2	5MHz	QPSK	18625	12RB#6	22.50	PASS
2	5MHz	16QAM	18625	12RB#6	22.51	PASS
2	5MHz	QPSK	18625	1RB#0	23.39	PASS
2	5MHz	16QAM	18625	1RB#0	22.59	PASS
2	5MHz	QPSK	18625	1RB#12	23.44	PASS
2	5MHz	16QAM	18625	1RB#12	22.62	PASS
2	5MHz	QPSK	18625	1RB#24	23.45	PASS
2	5MHz	16QAM	18625	1RB#24	22.63	PASS
2	5MHz	QPSK	18625	25RB#0	22.48	PASS
2	5MHz	16QAM	18625	25RB#0	21.49	PASS
2	5MHz	QPSK	18900	12RB#0	22.80	PASS
2	5MHz	16QAM	18900	12RB#0	22.80	PASS
2	5MHz	QPSK	18900	12RB#13	22.77	PASS
2	5MHz	16QAM	18900	12RB#13	22.78	PASS
2	5MHz	QPSK	18900	12RB#6	22.80	PASS
2	5MHz	16QAM	18900	12RB#6	22.80	PASS
2	5MHz	QPSK	18900	1RB#0	23.74	PASS
2	5MHz	16QAM	18900	1RB#0	22.73	PASS
2	5MHz	QPSK	18900	1RB#12	23.76	PASS
2	5MHz	16QAM	18900	1RB#12	22.76	PASS
2	5MHz	QPSK	18900	1RB#24	23.72	PASS
2	5MHz	16QAM	18900	1RB#24	22.73	PASS
2	5MHz	QPSK	18900	25RB#0	22.73	PASS
2	5MHz	16QAM	18900	25RB#0	21.79	PASS
2	5MHz	QPSK	19175	12RB#0	22.43	PASS
2	5MHz	16QAM	19175	12RB#0	22.42	PASS
2	5MHz	QPSK	19175	12RB#13	22.53	PASS
2	5MHz	16QAM	19175	12RB#13	22.53	PASS
2	5MHz	QPSK	19175	12RB#6	22.42	PASS
2	5MHz	16QAM	19175	12RB#6	22.42	PASS
2	5MHz	QPSK	19175	1RB#0	23.28	PASS
2	5MHz	16QAM	19175	1RB#0	22.33	PASS
2	5MHz	QPSK	19175	1RB#12	23.41	PASS

2	5MHz	16QAM	19175	1RB#12	22.39	PASS
2	5MHz	QPSK	19175	1RB#24	23.49	PASS
2	5MHz	16QAM	19175	1RB#24	22.45	PASS
2	5MHz	QPSK	19175	25RB#0	22.39	PASS
2	5MHz	16QAM	19175	25RB#0	21.49	PASS
2	10MHz	QPSK	18650	1RB#0	23.32	PASS
2	10MHz	16QAM	18650	1RB#0	22.55	PASS
2	10MHz	QPSK	18650	1RB#24	23.37	PASS
2	10MHz	16QAM	18650	1RB#24	22.58	PASS
2	10MHz	QPSK	18650	1RB#49	23.54	PASS
2	10MHz	16QAM	18650	1RB#49	22.70	PASS
2	10MHz	QPSK	18650	25RB#0	22.51	PASS
2	10MHz	16QAM	18650	25RB#0	22.50	PASS
2	10MHz	QPSK	18650	25RB#12	22.50	PASS
2	10MHz	16QAM	18650	25RB#12	22.50	PASS
2	10MHz	QPSK	18650	25RB#25	22.58	PASS
2	10MHz	16QAM	18650	25RB#25	22.58	PASS
2	10MHz	QPSK	18650	50RB#0	22.55	PASS
2	10MHz	16QAM	18650	50RB#0	21.59	PASS
2	10MHz	QPSK	18900	1RB#0	23.58	PASS
2	10MHz	16QAM	18900	1RB#0	22.50	PASS
2	10MHz	QPSK	18900	1RB#24	23.53	PASS
2	10MHz	16QAM	18900	1RB#24	22.48	PASS
2	10MHz	QPSK	18900	1RB#49	23.65	PASS
2	10MHz	16QAM	18900	1RB#49	22.61	PASS
2	10MHz	QPSK	18900	25RB#0	22.64	PASS
2	10MHz	16QAM	18900	25RB#0	22.62	PASS
2	10MHz	QPSK	18900	25RB#12	22.63	PASS
2	10MHz	16QAM	18900	25RB#12	22.63	PASS
2	10MHz	QPSK	18900	25RB#25	22.69	PASS
2	10MHz	16QAM	18900	25RB#25	22.69	PASS
2	10MHz	QPSK	18900	50RB#0	22.73	PASS
2	10MHz	16QAM	18900	50RB#0	20.51	PASS
2	10MHz	QPSK	19150	1RB#0	21.99	PASS
2	10MHz	16QAM	19150	1RB#0	21.21	PASS
2	10MHz	QPSK	19150	1RB#24	21.88	PASS
2	10MHz	16QAM	19150	1RB#24	21.10	PASS
2	10MHz	QPSK	19150	1RB#49	22.16	PASS
2	10MHz	16QAM	19150	1RB#49	21.28	PASS
2	10MHz	QPSK	19150	25RB#0	21.09	PASS
2	10MHz	16QAM	19150	25RB#0	21.06	PASS
2	10MHz	QPSK	19150	25RB#12	21.03	PASS
2	10MHz	16QAM	19150	25RB#12	21.03	PASS

2	10MHz	QPSK	19150	25RB#25	21.12	PASS
2	10MHz	16QAM	19150	25RB#25	21.12	PASS
2	10MHz	QPSK	19150	50RB#0	21.11	PASS
2	10MHz	16QAM	19150	50RB#0	20.49	PASS
2	15MHz	QPSK	18675	1RB#0	23.44	PASS
2	15MHz	16QAM	18675	1RB#0	22.66	PASS
2	15MHz	QPSK	18675	1RB#38	23.50	PASS
2	15MHz	16QAM	18675	1RB#38	22.72	PASS
2	15MHz	QPSK	18675	1RB#74	23.63	PASS
2	15MHz	16QAM	18675	1RB#74	22.88	PASS
2	15MHz	QPSK	18675	38RB#0	22.67	PASS
2	15MHz	16QAM	18675	38RB#0	22.68	PASS
2	15MHz	QPSK	18675	38RB#18	22.71	PASS
2	15MHz	16QAM	18675	38RB#18	22.72	PASS
2	15MHz	QPSK	18675	38RB#37	22.87	PASS
2	15MHz	16QAM	18675	38RB#37	22.86	PASS
2	15MHz	QPSK	18675	75RB#0	22.64	PASS
2	15MHz	16QAM	18675	75RB#0	21.61	PASS
2	15MHz	QPSK	18900	1RB#0	23.60	PASS
2	15MHz	16QAM	18900	1RB#0	22.55	PASS
2	15MHz	QPSK	18900	1RB#38	23.59	PASS
2	15MHz	16QAM	18900	1RB#38	22.52	PASS
2	15MHz	QPSK	18900	1RB#74	23.63	PASS
2	15MHz	16QAM	18900	1RB#74	22.55	PASS
2	15MHz	QPSK	18900	38RB#0	22.56	PASS
2	15MHz	16QAM	18900	38RB#0	22.55	PASS
2	15MHz	QPSK	18900	38RB#18	22.52	PASS
2	15MHz	16QAM	18900	38RB#18	22.53	PASS
2	15MHz	QPSK	18900	38RB#37	22.55	PASS
2	15MHz	16QAM	18900	38RB#37	22.55	PASS
2	15MHz	QPSK	18900	75RB#0	22.72	PASS
2	15MHz	16QAM	18900	75RB#0	21.69	PASS
2	15MHz	QPSK	19125	1RB#0	23.29	PASS
2	15MHz	16QAM	19125	1RB#0	22.50	PASS
2	15MHz	QPSK	19125	1RB#38	23.06	PASS
2	15MHz	16QAM	19125	1RB#38	22.28	PASS
2	15MHz	QPSK	19125	1RB#74	23.28	PASS
2	15MHz	16QAM	19125	1RB#74	22.44	PASS
2	15MHz	QPSK	19125	38RB#0	22.51	PASS
2	15MHz	16QAM	19125	38RB#0	22.51	PASS
2	15MHz	QPSK	19125	38RB#18	22.29	PASS
2	15MHz	16QAM	19125	38RB#18	22.30	PASS
2	15MHz	QPSK	19125	38RB#37	22.46	PASS



2	15MHz	16QAM	19125	38RB#37	22.44	PASS
2	15MHz	QPSK	19125	75RB#0	22.34	PASS
2	15MHz	16QAM	19125	75RB#0	22.30	PASS
2	20MHz	QPSK	18700	100RB#0	22.55	PASS
2	20MHz	16QAM	18700	100RB#0	21.56	PASS
2	20MHz	QPSK	18700	1RB#0	23.51	PASS
2	20MHz	16QAM	18700	1RB#0	22.55	PASS
2	20MHz	QPSK	18700	1RB#49	23.48	PASS
2	20MHz	16QAM	18700	1RB#49	22.53	PASS
2	20MHz	QPSK	18700	1RB#99	23.79	PASS
2	20MHz	16QAM	18700	1RB#99	22.85	PASS
2	20MHz	QPSK	18700	50RB#0	22.47	PASS
2	20MHz	16QAM	18700	50RB#0	22.48	PASS
2	20MHz	QPSK	18700	50RB#25	22.47	PASS
2	20MHz	16QAM	18700	50RB#25	22.49	PASS
2	20MHz	QPSK	18700	50RB#50	22.65	PASS
2	20MHz	16QAM	18700	50RB#50	22.63	PASS
2	20MHz	QPSK	18900	100RB#0	22.60	PASS
2	20MHz	16QAM	18900	100RB#0	21.63	PASS
2	20MHz	QPSK	18900	1RB#0	23.48	PASS
2	20MHz	16QAM	18900	1RB#0	22.65	PASS
2	20MHz	QPSK	18900	1RB#49	23.37	PASS
2	20MHz	16QAM	18900	1RB#49	22.56	PASS
2	20MHz	QPSK	18900	1RB#99	23.50	PASS
2	20MHz	16QAM	18900	1RB#99	22.63	PASS
2	20MHz	QPSK	18900	50RB#0	22.62	PASS
2	20MHz	16QAM	18900	50RB#0	22.62	PASS
2	20MHz	QPSK	18900	50RB#25	22.62	PASS
2	20MHz	16QAM	18900	50RB#25	22.62	PASS
2	20MHz	QPSK	18900	50RB#50	22.62	PASS
2	20MHz	16QAM	18900	50RB#50	22.62	PASS
2	20MHz	QPSK	19100	100RB#0	22.30	PASS
2	20MHz	16QAM	19100	100RB#0	21.35	PASS
2	20MHz	QPSK	19100	1RB#0	23.53	PASS
2	20MHz	16QAM	19100	1RB#0	22.53	PASS
2	20MHz	QPSK	19100	1RB#49	23.21	PASS
2	20MHz	16QAM	19100	1RB#49	22.24	PASS
2	20MHz	QPSK	19100	1RB#99	23.43	PASS
2	20MHz	16QAM	19100	1RB#99	22.37	PASS
2	20MHz	QPSK	19100	50RB#0	22.42	PASS
2	20MHz	16QAM	19100	50RB#0	22.42	PASS
2	20MHz	QPSK	19100	50RB#25	22.42	PASS
2	20MHz	16QAM	19100	50RB#25	22.42	PASS

2	20MHz	QPSK	19100	50RB#50	22.26	PASS
2	20MHz	16QAM	19100	50RB#50	22.27	PASS
4	1.4MHz	QPSK	19957	1RB#0	23.39	PASS
4	1.4MHz	16QAM	19957	1RB#0	23.48	PASS
4	1.4MHz	QPSK	19957	1RB#2	23.44	PASS
4	1.4MHz	16QAM	19957	1RB#2	23.57	PASS
4	1.4MHz	QPSK	19957	1RB#5	23.38	PASS
4	1.4MHz	16QAM	19957	1RB#5	23.51	PASS
4	1.4MHz	QPSK	19957	3RB#0	23.49	PASS
4	1.4MHz	16QAM	19957	3RB#0	23.49	PASS
4	1.4MHz	QPSK	19957	3RB#1	23.49	PASS
4	1.4MHz	16QAM	19957	3RB#1	23.49	PASS
4	1.4MHz	QPSK	19957	3RB#3	23.49	PASS
4	1.4MHz	16QAM	19957	3RB#3	23.49	PASS
4	1.4MHz	QPSK	19957	6RB#0	23.44	PASS
4	1.4MHz	16QAM	19957	6RB#0	23.30	PASS
4	1.4MHz	QPSK	20175	1RB#0	23.31	PASS
4	1.4MHz	16QAM	20175	1RB#0	23.21	PASS
4	1.4MHz	QPSK	20175	1RB#2	23.38	PASS
4	1.4MHz	16QAM	20175	1RB#2	23.33	PASS
4	1.4MHz	QPSK	20175	1RB#5	23.33	PASS
4	1.4MHz	16QAM	20175	1RB#5	23.22	PASS
4	1.4MHz	QPSK	20175	3RB#0	23.41	PASS
4	1.4MHz	16QAM	20175	3RB#0	23.41	PASS
4	1.4MHz	QPSK	20175	3RB#1	23.41	PASS
4	1.4MHz	16QAM	20175	3RB#1	23.40	PASS
4	1.4MHz	QPSK	20175	3RB#3	23.39	PASS
4	1.4MHz	16QAM	20175	3RB#3	23.39	PASS
4	1.4MHz	QPSK	20175	6RB#0	23.38	PASS
4	1.4MHz	16QAM	20175	6RB#0	23.36	PASS
4	1.4MHz	QPSK	20393	1RB#0	23.22	PASS
4	1.4MHz	16QAM	20393	1RB#0	23.28	PASS
4	1.4MHz	QPSK	20393	1RB#2	23.27	PASS
4	1.4MHz	16QAM	20393	1RB#2	23.42	PASS
4	1.4MHz	QPSK	20393	1RB#5	23.19	PASS
4	1.4MHz	16QAM	20393	1RB#5	23.26	PASS
4	1.4MHz	QPSK	20393	3RB#0	23.35	PASS
4	1.4MHz	16QAM	20393	3RB#0	23.36	PASS
4	1.4MHz	QPSK	20393	3RB#1	23.36	PASS
4	1.4MHz	16QAM	20393	3RB#1	23.36	PASS
4	1.4MHz	QPSK	20393	3RB#3	23.32	PASS
4	1.4MHz	16QAM	20393	3RB#3	23.32	PASS
4	1.4MHz	QPSK	20393	6RB#0	23.27	PASS

4	1.4MHz	16QAM	20393	6RB#0	23.29	PASS
4	3MHz	QPSK	19965	15RB#0	23.46	PASS
4	3MHz	16QAM	19965	15RB#0	23.36	PASS
4	3MHz	QPSK	19965	1RB#0	23.40	PASS
4	3MHz	16QAM	19965	1RB#0	23.50	PASS
4	3MHz	QPSK	19965	1RB#14	23.35	PASS
4	3MHz	16QAM	19965	1RB#14	23.47	PASS
4	3MHz	QPSK	19965	1RB#8	23.42	PASS
4	3MHz	16QAM	19965	1RB#8	23.51	PASS
4	3MHz	QPSK	19965	8RB#0	23.50	PASS
4	3MHz	16QAM	19965	8RB#0	23.49	PASS
4	3MHz	QPSK	19965	8RB#4	23.52	PASS
4	3MHz	16QAM	19965	8RB#4	23.53	PASS
4	3MHz	QPSK	19965	8RB#7	23.48	PASS
4	3MHz	16QAM	19965	8RB#7	23.47	PASS
4	3MHz	QPSK	20175	15RB#0	23.44	PASS
4	3MHz	16QAM	20175	15RB#0	23.32	PASS
4	3MHz	QPSK	20175	1RB#0	23.36	PASS
4	3MHz	16QAM	20175	1RB#0	23.23	PASS
4	3MHz	QPSK	20175	1RB#14	23.37	PASS
4	3MHz	16QAM	20175	1RB#14	23.25	PASS
4	3MHz	QPSK	20175	1RB#8	23.39	PASS
4	3MHz	16QAM	20175	1RB#8	23.29	PASS
4	3MHz	QPSK	20175	8RB#0	23.21	PASS
4	3MHz	16QAM	20175	8RB#0	23.23	PASS
4	3MHz	QPSK	20175	8RB#4	23.27	PASS
4	3MHz	16QAM	20175	8RB#4	23.27	PASS
4	3MHz	QPSK	20175	8RB#7	23.25	PASS
4	3MHz	16QAM	20175	8RB#7	23.25	PASS
4	3MHz	QPSK	20385	15RB#0	23.36	PASS
4	3MHz	16QAM	20385	15RB#0	23.34	PASS
4	3MHz	QPSK	20385	1RB#0	23.23	PASS
4	3MHz	16QAM	20385	1RB#0	23.41	PASS
4	3MHz	QPSK	20385	1RB#14	23.22	PASS
4	3MHz	16QAM	20385	1RB#14	23.34	PASS
4	3MHz	QPSK	20385	1RB#8	23.27	PASS
4	3MHz	16QAM	20385	1RB#8	23.41	PASS
4	3MHz	QPSK	20385	8RB#0	23.41	PASS
4	3MHz	16QAM	20385	8RB#0	23.40	PASS
4	3MHz	QPSK	20385	8RB#4	23.39	PASS
4	3MHz	16QAM	20385	8RB#4	23.40	PASS
4	3MHz	QPSK	20385	8RB#7	23.35	PASS
4	3MHz	16QAM	20385	8RB#7	23.35	PASS

4	5MHz	QPSK	19975	12RB#0	23.53	PASS
4	5MHz	16QAM	19975	12RB#0	23.53	PASS
4	5MHz	QPSK	19975	12RB#13	23.56	PASS
4	5MHz	16QAM	19975	12RB#13	23.55	PASS
4	5MHz	QPSK	19975	12RB#6	23.54	PASS
4	5MHz	16QAM	19975	12RB#6	23.53	PASS
4	5MHz	QPSK	19975	1RB#0	23.50	PASS
4	5MHz	16QAM	19975	1RB#0	23.64	PASS
4	5MHz	QPSK	19975	1RB#12	23.52	PASS
4	5MHz	16QAM	19975	1RB#12	23.68	PASS
4	5MHz	QPSK	19975	1RB#24	23.51	PASS
4	5MHz	16QAM	19975	1RB#24	23.66	PASS
4	5MHz	QPSK	19975	25RB#0	23.51	PASS
4	5MHz	16QAM	19975	25RB#0	23.45	PASS
4	5MHz	QPSK	20175	12RB#0	23.52	PASS
4	5MHz	16QAM	20175	12RB#0	23.52	PASS
4	5MHz	QPSK	20175	12RB#13	23.48	PASS
4	5MHz	16QAM	20175	12RB#13	23.48	PASS
4	5MHz	QPSK	20175	12RB#6	23.52	PASS
4	5MHz	16QAM	20175	12RB#6	23.52	PASS
4	5MHz	QPSK	20175	1RB#0	23.54	PASS
4	5MHz	16QAM	20175	1RB#0	23.48	PASS
4	5MHz	QPSK	20175	1RB#12	23.52	PASS
4	5MHz	16QAM	20175	1RB#12	23.48	PASS
4	5MHz	QPSK	20175	1RB#24	23.49	PASS
4	5MHz	16QAM	20175	1RB#24	23.45	PASS
4	5MHz	QPSK	20175	25RB#0	23.45	PASS
4	5MHz	16QAM	20175	25RB#0	23.45	PASS
4	5MHz	QPSK	20375	12RB#0	23.44	PASS
4	5MHz	16QAM	20375	12RB#0	23.44	PASS
4	5MHz	QPSK	20375	12RB#13	23.45	PASS
4	5MHz	16QAM	20375	12RB#13	23.43	PASS
4	5MHz	QPSK	20375	12RB#6	23.44	PASS
4	5MHz	16QAM	20375	12RB#6	23.44	PASS
4	5MHz	QPSK	20375	1RB#0	23.39	PASS
4	5MHz	16QAM	20375	1RB#0	23.38	PASS
4	5MHz	QPSK	20375	1RB#12	23.43	PASS
4	5MHz	16QAM	20375	1RB#12	23.39	PASS
4	5MHz	QPSK	20375	1RB#24	23.37	PASS
4	5MHz	16QAM	20375	1RB#24	23.37	PASS
4	5MHz	QPSK	20375	25RB#0	23.41	PASS
4	5MHz	16QAM	20375	25RB#0	23.39	PASS
4	10MHz	QPSK	20000	1RB#0	23.45	PASS

4	10MHz	16QAM	20000	1RB#0	23.57	PASS
4	10MHz	QPSK	20000	1RB#24	23.49	PASS
4	10MHz	16QAM	20000	1RB#24	23.64	PASS
4	10MHz	QPSK	20000	1RB#49	23.50	PASS
4	10MHz	16QAM	20000	1RB#49	23.66	PASS
4	10MHz	QPSK	20000	25RB#0	23.52	PASS
4	10MHz	16QAM	20000	25RB#0	23.52	PASS
4	10MHz	QPSK	20000	25RB#12	23.51	PASS
4	10MHz	16QAM	20000	25RB#12	23.50	PASS
4	10MHz	QPSK	20000	25RB#25	23.56	PASS
4	10MHz	16QAM	20000	25RB#25	23.57	PASS
4	10MHz	QPSK	20000	50RB#0	23.55	PASS
4	10MHz	16QAM	20000	50RB#0	23.55	PASS
4	10MHz	QPSK	20175	1RB#0	23.44	PASS
4	10MHz	16QAM	20175	1RB#0	23.34	PASS
4	10MHz	QPSK	20175	1RB#24	23.48	PASS
4	10MHz	16QAM	20175	1RB#24	23.36	PASS
4	10MHz	QPSK	20175	1RB#49	23.49	PASS
4	10MHz	16QAM	20175	1RB#49	23.39	PASS
4	10MHz	QPSK	20175	25RB#0	23.46	PASS
4	10MHz	16QAM	20175	25RB#0	23.46	PASS
4	10MHz	QPSK	20175	25RB#12	23.46	PASS
4	10MHz	16QAM	20175	25RB#12	23.46	PASS
4	10MHz	QPSK	20175	25RB#25	23.52	PASS
4	10MHz	16QAM	20175	25RB#25	23.52	PASS
4	10MHz	QPSK	20175	50RB#0	23.50	PASS
4	10MHz	16QAM	20175	50RB#0	23.46	PASS
4	10MHz	QPSK	20350	1RB#0	23.32	PASS
4	10MHz	16QAM	20350	1RB#0	23.51	PASS
4	10MHz	QPSK	20350	1RB#24	23.36	PASS
4	10MHz	16QAM	20350	1RB#24	23.53	PASS
4	10MHz	QPSK	20350	1RB#49	23.38	PASS
4	10MHz	16QAM	20350	1RB#49	23.51	PASS
4	10MHz	QPSK	20350	25RB#0	23.43	PASS
4	10MHz	16QAM	20350	25RB#0	23.42	PASS
4	10MHz	QPSK	20350	25RB#12	23.42	PASS
4	10MHz	16QAM	20350	25RB#12	23.42	PASS
4	10MHz	QPSK	20350	25RB#25	23.44	PASS
4	10MHz	16QAM	20350	25RB#25	23.44	PASS
4	10MHz	QPSK	20350	50RB#0	23.45	PASS
4	10MHz	16QAM	20350	50RB#0	23.41	PASS
4	15MHz	QPSK	20025	1RB#0	23.49	PASS
4	15MHz	16QAM	20025	1RB#0	23.74	PASS

4	15MHz	QPSK	20025	1RB#38	23.47	PASS
4	15MHz	16QAM	20025	1RB#38	23.74	PASS
4	15MHz	QPSK	20025	1RB#74	23.53	PASS
4	15MHz	16QAM	20025	1RB#74	23.78	PASS
4	15MHz	QPSK	20025	38RB#0	23.74	PASS
4	15MHz	16QAM	20025	38RB#0	23.75	PASS
4	15MHz	QPSK	20025	38RB#18	23.74	PASS
4	15MHz	16QAM	20025	38RB#18	23.74	PASS
4	15MHz	QPSK	20025	38RB#37	23.78	PASS
4	15MHz	16QAM	20025	38RB#37	23.78	PASS
4	15MHz	QPSK	20025	75RB#0	23.66	PASS
4	15MHz	16QAM	20025	75RB#0	23.62	PASS
4	15MHz	QPSK	20175	1RB#0	23.44	PASS
4	15MHz	16QAM	20175	1RB#0	23.35	PASS
4	15MHz	QPSK	20175	1RB#38	23.48	PASS
4	15MHz	16QAM	20175	1RB#38	23.37	PASS
4	15MHz	QPSK	20175	1RB#74	23.54	PASS
4	15MHz	16QAM	20175	1RB#74	23.42	PASS
4	15MHz	QPSK	20175	38RB#0	23.36	PASS
4	15MHz	16QAM	20175	38RB#0	23.36	PASS
4	15MHz	QPSK	20175	38RB#18	23.37	PASS
4	15MHz	16QAM	20175	38RB#18	23.37	PASS
4	15MHz	QPSK	20175	38RB#37	23.42	PASS
4	15MHz	16QAM	20175	38RB#37	23.42	PASS
4	15MHz	QPSK	20175	75RB#0	23.64	PASS
4	15MHz	16QAM	20175	75RB#0	23.58	PASS
4	15MHz	QPSK	20325	1RB#0	23.36	PASS
4	15MHz	16QAM	20325	1RB#0	23.53	PASS
4	15MHz	QPSK	20325	1RB#38	23.35	PASS
4	15MHz	16QAM	20325	1RB#38	23.52	PASS
4	15MHz	QPSK	20325	1RB#74	23.41	PASS
4	15MHz	16QAM	20325	1RB#74	23.59	PASS
4	15MHz	QPSK	20325	38RB#0	23.55	PASS
4	15MHz	16QAM	20325	38RB#0	23.51	PASS
4	15MHz	QPSK	20325	38RB#18	23.53	PASS
4	15MHz	16QAM	20325	38RB#18	23.52	PASS
4	15MHz	QPSK	20325	38RB#37	23.58	PASS
4	15MHz	16QAM	20325	38RB#37	23.58	PASS
4	15MHz	QPSK	20325	75RB#0	23.57	PASS
4	15MHz	16QAM	20325	75RB#0	23.51	PASS
4	20MHz	QPSK	20050	100RB#0	23.56	PASS
4	20MHz	16QAM	20050	100RB#0	23.54	PASS
4	20MHz	QPSK	20050	1RB#0	23.57	PASS

4	20MHz	16QAM	20050	1RB#0	23.64	PASS
4	20MHz	QPSK	20050	1RB#49	23.58	PASS
4	20MHz	16QAM	20050	1RB#49	23.64	PASS
4	20MHz	QPSK	20050	1RB#99	23.70	PASS
4	20MHz	16QAM	20050	1RB#99	23.76	PASS
4	20MHz	QPSK	20050	50RB#0	23.57	PASS
4	20MHz	16QAM	20050	50RB#0	23.58	PASS
4	20MHz	QPSK	20050	50RB#25	23.58	PASS
4	20MHz	16QAM	20050	50RB#25	23.57	PASS
4	20MHz	QPSK	20050	50RB#50	23.61	PASS
4	20MHz	16QAM	20050	50RB#50	23.60	PASS
4	20MHz	QPSK	20175	100RB#0	23.55	PASS
4	20MHz	16QAM	20175	100RB#0	23.52	PASS
4	20MHz	QPSK	20175	1RB#0	23.40	PASS
4	20MHz	16QAM	20175	1RB#0	23.54	PASS
4	20MHz	QPSK	20175	1RB#49	23.42	PASS
4	20MHz	16QAM	20175	1RB#49	23.52	PASS
4	20MHz	QPSK	20175	1RB#99	23.49	PASS
4	20MHz	16QAM	20175	1RB#99	23.63	PASS
4	20MHz	QPSK	20175	50RB#0	23.53	PASS
4	20MHz	16QAM	20175	50RB#0	23.52	PASS
4	20MHz	QPSK	20175	50RB#25	23.52	PASS
4	20MHz	16QAM	20175	50RB#25	23.52	PASS
4	20MHz	QPSK	20175	50RB#50	23.60	PASS
4	20MHz	16QAM	20175	50RB#50	23.62	PASS
4	20MHz	QPSK	20300	100RB#0	23.48	PASS
4	20MHz	16QAM	20300	100RB#0	23.45	PASS
4	20MHz	QPSK	20300	1RB#0	23.53	PASS
4	20MHz	16QAM	20300	1RB#0	23.51	PASS
4	20MHz	QPSK	20300	1RB#49	23.50	PASS
4	20MHz	16QAM	20300	1RB#49	23.50	PASS
4	20MHz	QPSK	20300	1RB#99	23.62	PASS
4	20MHz	16QAM	20300	1RB#99	23.59	PASS
4	20MHz	QPSK	20300	50RB#0	23.48	PASS
4	20MHz	16QAM	20300	50RB#0	23.47	PASS
4	20MHz	QPSK	20300	50RB#25	23.48	PASS
4	20MHz	16QAM	20300	50RB#25	23.46	PASS
4	20MHz	QPSK	20300	50RB#50	23.53	PASS
4	20MHz	16QAM	20300	50RB#50	23.52	PASS
7	5MHz	QPSK	20775	12RB#0	21.39	PASS
7	5MHz	16QAM	20775	12RB#0	21.40	PASS
7	5MHz	QPSK	20775	12RB#13	21.40	PASS
7	5MHz	16QAM	20775	12RB#13	21.41	PASS

7	5MHz	QPSK	20775	12RB#6	21.39	PASS
7	5MHz	16QAM	20775	12RB#6	21.40	PASS
7	5MHz	QPSK	20775	1RB#0	22.37	PASS
7	5MHz	16QAM	20775	1RB#0	21.43	PASS
7	5MHz	QPSK	20775	1RB#12	22.33	PASS
7	5MHz	16QAM	20775	1RB#12	21.47	PASS
7	5MHz	QPSK	20775	1RB#24	22.31	PASS
7	5MHz	16QAM	20775	1RB#24	21.43	PASS
7	5MHz	QPSK	20775	25RB#0	21.37	PASS
7	5MHz	16QAM	20775	25RB#0	20.44	PASS
7	5MHz	QPSK	21100	12RB#0	21.32	PASS
7	5MHz	16QAM	21100	12RB#0	21.32	PASS
7	5MHz	QPSK	21100	12RB#13	21.35	PASS
7	5MHz	16QAM	21100	12RB#13	21.34	PASS
7	5MHz	QPSK	21100	12RB#6	21.32	PASS
7	5MHz	16QAM	21100	12RB#6	21.32	PASS
7	5MHz	QPSK	21100	1RB#0	22.32	PASS
7	5MHz	16QAM	21100	1RB#0	21.27	PASS
7	5MHz	QPSK	21100	1RB#12	22.34	PASS
7	5MHz	16QAM	21100	1RB#12	21.31	PASS
7	5MHz	QPSK	21100	1RB#24	22.31	PASS
7	5MHz	16QAM	21100	1RB#24	21.30	PASS
7	5MHz	QPSK	21100	25RB#0	21.28	PASS
7	5MHz	16QAM	21100	25RB#0	20.49	PASS
7	5MHz	QPSK	21425	12RB#0	21.54	PASS
7	5MHz	16QAM	21425	12RB#0	21.55	PASS
7	5MHz	QPSK	21425	12RB#13	21.61	PASS
7	5MHz	16QAM	21425	12RB#13	21.60	PASS
7	5MHz	QPSK	21425	12RB#6	21.55	PASS
7	5MHz	16QAM	21425	12RB#6	21.55	PASS
7	5MHz	QPSK	21425	1RB#0	22.50	PASS
7	5MHz	16QAM	21425	1RB#0	21.43	PASS
7	5MHz	QPSK	21425	1RB#12	22.52	PASS
7	5MHz	16QAM	21425	1RB#12	21.48	PASS
7	5MHz	QPSK	21425	1RB#24	22.51	PASS
7	5MHz	16QAM	21425	1RB#24	21.47	PASS
7	5MHz	QPSK	21425	25RB#0	21.54	PASS
7	5MHz	16QAM	21425	25RB#0	20.53	PASS
7	10MHz	QPSK	20800	1RB#0	22.34	PASS
7	10MHz	16QAM	20800	1RB#0	21.43	PASS
7	10MHz	QPSK	20800	1RB#24	22.33	PASS
7	10MHz	16QAM	20800	1RB#24	21.44	PASS
7	10MHz	QPSK	20800	1RB#49	22.38	PASS



7	10MHz	16QAM	20800	1RB#49	21.48	PASS
7	10MHz	QPSK	20800	25RB#0	21.41	PASS
7	10MHz	16QAM	20800	25RB#0	21.38	PASS
7	10MHz	QPSK	20800	25RB#12	21.41	PASS
7	10MHz	16QAM	20800	25RB#12	21.41	PASS
7	10MHz	QPSK	20800	25RB#25	21.42	PASS
7	10MHz	16QAM	20800	25RB#25	21.41	PASS
7	10MHz	QPSK	20800	50RB#0	21.38	PASS
7	10MHz	16QAM	20800	50RB#0	20.36	PASS
7	10MHz	QPSK	21100	1RB#0	22.30	PASS
7	10MHz	16QAM	21100	1RB#0	21.26	PASS
7	10MHz	QPSK	21100	1RB#24	22.35	PASS
7	10MHz	16QAM	21100	1RB#24	21.26	PASS
7	10MHz	QPSK	21100	1RB#49	22.37	PASS
7	10MHz	16QAM	21100	1RB#49	21.29	PASS
7	10MHz	QPSK	21100	25RB#0	21.33	PASS
7	10MHz	16QAM	21100	25RB#0	21.32	PASS
7	10MHz	QPSK	21100	25RB#12	21.33	PASS
7	10MHz	16QAM	21100	25RB#12	21.34	PASS
7	10MHz	QPSK	21100	25RB#25	21.38	PASS
7	10MHz	16QAM	21100	25RB#25	21.38	PASS
7	10MHz	QPSK	21100	50RB#0	21.34	PASS
7	10MHz	16QAM	21100	50RB#0	20.31	PASS
7	10MHz	QPSK	21400	1RB#0	22.36	PASS
7	10MHz	16QAM	21400	1RB#0	21.56	PASS
7	10MHz	QPSK	21400	1RB#24	22.44	PASS
7	10MHz	16QAM	21400	1RB#24	21.60	PASS
7	10MHz	QPSK	21400	1RB#49	22.57	PASS
7	10MHz	16QAM	21400	1RB#49	21.73	PASS
7	10MHz	QPSK	21400	25RB#0	21.49	PASS
7	10MHz	16QAM	21400	25RB#0	21.50	PASS
7	10MHz	QPSK	21400	25RB#12	21.48	PASS
7	10MHz	16QAM	21400	25RB#12	21.50	PASS
7	10MHz	QPSK	21400	25RB#25	21.60	PASS
7	10MHz	16QAM	21400	25RB#25	21.59	PASS
7	10MHz	QPSK	21400	50RB#0	21.54	PASS
7	10MHz	16QAM	21400	50RB#0	20.47	PASS
7	15MHz	QPSK	20825	1RB#0	22.42	PASS
7	15MHz	16QAM	20825	1RB#0	21.59	PASS
7	15MHz	QPSK	20825	1RB#38	22.42	PASS
7	15MHz	16QAM	20825	1RB#38	21.59	PASS
7	15MHz	QPSK	20825	1RB#74	22.50	PASS
7	15MHz	16QAM	20825	1RB#74	21.66	PASS

7	15MHz	QPSK	20825	38RB#0	21.57	PASS
7	15MHz	16QAM	20825	38RB#0	21.60	PASS
7	15MHz	QPSK	20825	38RB#18	21.59	PASS
7	15MHz	16QAM	20825	38RB#18	21.59	PASS
7	15MHz	QPSK	20825	38RB#37	21.67	PASS
7	15MHz	16QAM	20825	38RB#37	21.66	PASS
7	15MHz	QPSK	20825	75RB#0	21.52	PASS
7	15MHz	16QAM	20825	75RB#0	20.48	PASS
7	15MHz	QPSK	21100	1RB#0	22.32	PASS
7	15MHz	16QAM	21100	1RB#0	21.22	PASS
7	15MHz	QPSK	21100	1RB#38	22.31	PASS
7	15MHz	16QAM	21100	1RB#38	21.21	PASS
7	15MHz	QPSK	21100	1RB#74	22.39	PASS
7	15MHz	16QAM	21100	1RB#74	21.27	PASS
7	15MHz	QPSK	21100	38RB#0	21.22	PASS
7	15MHz	16QAM	21100	38RB#0	21.22	PASS
7	15MHz	QPSK	21100	38RB#18	21.21	PASS
7	15MHz	16QAM	21100	38RB#18	21.20	PASS
7	15MHz	QPSK	21100	38RB#37	21.27	PASS
7	15MHz	16QAM	21100	38RB#37	21.27	PASS
7	15MHz	QPSK	21100	75RB#0	21.45	PASS
7	15MHz	16QAM	21100	75RB#0	20.41	PASS
7	15MHz	QPSK	21375	1RB#0	22.32	PASS
7	15MHz	16QAM	21375	1RB#0	21.45	PASS
7	15MHz	QPSK	21375	1RB#38	22.43	PASS
7	15MHz	16QAM	21375	1RB#38	21.56	PASS
7	15MHz	QPSK	21375	1RB#74	22.60	PASS
7	15MHz	16QAM	21375	1RB#74	21.72	PASS
7	15MHz	QPSK	21375	38RB#0	21.50	PASS
7	15MHz	16QAM	21375	38RB#0	21.48	PASS
7	15MHz	QPSK	21375	38RB#18	21.56	PASS
7	15MHz	16QAM	21375	38RB#18	21.56	PASS
7	15MHz	QPSK	21375	38RB#37	21.74	PASS
7	15MHz	16QAM	21375	38RB#37	21.73	PASS
7	15MHz	QPSK	21375	75RB#0	21.62	PASS
7	15MHz	16QAM	21375	75RB#0	20.51	PASS
7	20MHz	QPSK	20850	100RB#0	21.53	PASS
7	20MHz	16QAM	20850	100RB#0	20.51	PASS
7	20MHz	QPSK	20850	1RB#0	22.53	PASS
7	20MHz	16QAM	20850	1RB#0	21.54	PASS
7	20MHz	QPSK	20850	1RB#49	22.52	PASS
7	20MHz	16QAM	20850	1RB#49	21.60	PASS
7	20MHz	QPSK	20850	1RB#99	22.65	PASS

7	20MHz	16QAM	20850	1RB#99	21.67	PASS
7	20MHz	QPSK	20850	50RB#0	21.49	PASS
7	20MHz	16QAM	20850	50RB#0	21.50	PASS
7	20MHz	QPSK	20850	50RB#25	21.49	PASS
7	20MHz	16QAM	20850	50RB#25	21.44	PASS
7	20MHz	QPSK	20850	50RB#50	21.46	PASS
7	20MHz	16QAM	20850	50RB#50	21.54	PASS
7	20MHz	QPSK	21100	100RB#0	21.43	PASS
7	20MHz	16QAM	21100	100RB#0	20.30	PASS
7	20MHz	QPSK	21100	1RB#0	22.28	PASS
7	20MHz	16QAM	21100	1RB#0	21.37	PASS
7	20MHz	QPSK	21100	1RB#49	22.24	PASS
7	20MHz	16QAM	21100	1RB#49	21.36	PASS
7	20MHz	QPSK	21100	1RB#99	22.40	PASS
7	20MHz	16QAM	21100	1RB#99	21.53	PASS
7	20MHz	QPSK	21100	50RB#0	21.35	PASS
7	20MHz	16QAM	21100	50RB#0	21.37	PASS
7	20MHz	QPSK	21100	50RB#25	21.35	PASS
7	20MHz	16QAM	21100	50RB#25	21.58	PASS
7	20MHz	QPSK	21100	50RB#50	21.39	PASS
7	20MHz	16QAM	21100	50RB#50	21.40	PASS
7	20MHz	QPSK	21350	100RB#0	21.41	PASS
7	20MHz	16QAM	21350	100RB#0	20.40	PASS
7	20MHz	QPSK	21350	1RB#0	22.43	PASS
7	20MHz	16QAM	21350	1RB#0	21.40	PASS
7	20MHz	QPSK	21350	1RB#49	22.43	PASS
7	20MHz	16QAM	21350	1RB#49	21.49	PASS
7	20MHz	QPSK	21350	1RB#99	22.64	PASS
7	20MHz	16QAM	21350	1RB#99	21.59	PASS
7	20MHz	QPSK	21350	50RB#0	21.37	PASS
7	20MHz	16QAM	21350	50RB#0	21.38	PASS
7	20MHz	QPSK	21350	50RB#25	21.38	PASS
7	20MHz	16QAM	21350	50RB#25	21.38	PASS
7	20MHz	QPSK	21350	50RB#50	21.51	PASS
7	20MHz	16QAM	21350	50RB#50	21.50	PASS

## Appendix B: Peak-to-Average Ratio

### Test Result

Band	Bandwidth	Modulation	Channel	RB Configuration	Peak-to-Average Ratio (dB)	Limit (dB)	Verdict
2	1.4MHz	QPSK	18900	1RB#0	3.55	13	Pass
2	1.4MHz	16QAM	18900	1RB#0	5.37	13	Pass
2	1.4MHz	QPSK	18900	6RB#0	4.58	13	Pass
2	1.4MHz	16QAM	18900	6RB#0	5.64	13	Pass
2	3MHz	QPSK	18900	15RB#0	5.26	13	Pass
2	3MHz	16QAM	18900	15RB#0	5.79	13	Pass
2	3MHz	QPSK	18900	1RB#0	3.66	13	Pass
2	3MHz	16QAM	18900	1RB#0	4.09	13	Pass
2	5MHz	QPSK	18900	1RB#0	3.29	13	Pass
2	5MHz	16QAM	18900	1RB#0	4.24	13	Pass
2	5MHz	QPSK	18900	25RB#0	4.97	13	Pass
2	5MHz	16QAM	18900	25RB#0	5.81	13	Pass
2	10MHz	QPSK	18900	1RB#0	3.44	13	Pass
2	10MHz	16QAM	18900	1RB#0	5.19	13	Pass
2	10MHz	QPSK	18900	50RB#0	5.24	13	Pass
2	10MHz	16QAM	18900	50RB#0	6.03	13	Pass
2	15MHz	QPSK	18900	1RB#0	4.00	13	Pass
2	15MHz	16QAM	18900	1RB#0	4.29	13	Pass
2	15MHz	QPSK	18900	75RB#0	5.69	13	Pass
2	15MHz	16QAM	18900	75RB#0	6.12	13	Pass
2	20MHz	QPSK	18900	100RB#0	5.39	13	Pass
2	20MHz	16QAM	18900	100RB#0	5.96	13	Pass
2	20MHz	QPSK	18900	1RB#0	3.95	13	Pass
2	20MHz	16QAM	18900	1RB#0	4.76	13	Pass
4	1.4MHz	QPSK	20175	1RB#0	4.03	13	Pass
4	1.4MHz	16QAM	20175	1RB#0	4.41	13	Pass
4	1.4MHz	QPSK	20175	6RB#0	4.58	13	Pass
4	1.4MHz	16QAM	20175	6RB#0	4.58	13	Pass
4	3MHz	QPSK	20175	15RB#0	4.71	13	Pass
4	3MHz	16QAM	20175	15RB#0	4.58	13	Pass
4	3MHz	QPSK	20175	1RB#0	3.77	13	Pass
4	3MHz	16QAM	20175	1RB#0	3.87	13	Pass
4	5MHz	QPSK	20175	1RB#0	4.02	13	Pass

4	5MHz	16QAM	20175	1RB#0	4.71	13	Pass
4	5MHz	QPSK	20175	25RB#0	4.68	13	Pass
4	5MHz	16QAM	20175	25RB#0	5.19	13	Pass
4	10MHz	QPSK	20175	1RB#0	8.42	13	Pass
4	10MHz	16QAM	20175	1RB#0	3.76	13	Pass
4	10MHz	QPSK	20175	50RB#0	4.83	13	Pass
4	10MHz	16QAM	20175	50RB#0	4.79	13	Pass
4	15MHz	QPSK	20175	1RB#0	3.64	13	Pass
4	15MHz	16QAM	20175	1RB#0	4.59	13	Pass
4	15MHz	QPSK	20175	75RB#0	5.08	13	Pass
4	15MHz	16QAM	20175	75RB#0	5.21	13	Pass
4	20MHz	QPSK	20175	100RB#0	5.14	13	Pass
4	20MHz	16QAM	20175	100RB#0	5.51	13	Pass
4	20MHz	QPSK	20175	1RB#0	3.92	13	Pass
4	20MHz	16QAM	20175	1RB#0	4.95	13	Pass
7	5MHz	QPSK	21100	1RB#0	3.48	13	Pass
7	5MHz	16QAM	21100	1RB#0	4.21	13	Pass
7	5MHz	QPSK	21100	25RB#0	5.29	13	Pass
7	5MHz	16QAM	21100	25RB#0	5.87	13	Pass
7	10MHz	QPSK	21100	1RB#0	3.27	13	Pass
7	10MHz	16QAM	21100	1RB#0	3.89	13	Pass
7	10MHz	QPSK	21100	50RB#0	5.10	13	Pass
7	10MHz	16QAM	21100	50RB#0	5.71	13	Pass
7	15MHz	QPSK	21100	1RB#0	2.85	13	Pass
7	15MHz	16QAM	21100	1RB#0	3.94	13	Pass
7	15MHz	QPSK	21100	75RB#0	5.85	13	Pass
7	15MHz	16QAM	21100	75RB#0	6.23	13	Pass
7	20MHz	QPSK	21100	100RB#0	5.66	13	Pass
7	20MHz	16QAM	21100	100RB#0	6.30	13	Pass
7	20MHz	QPSK	21100	1RB#0	2.93	13	Pass
7	20MHz	16QAM	21100	1RB#0	3.48	13	Pass

### Test Graphs

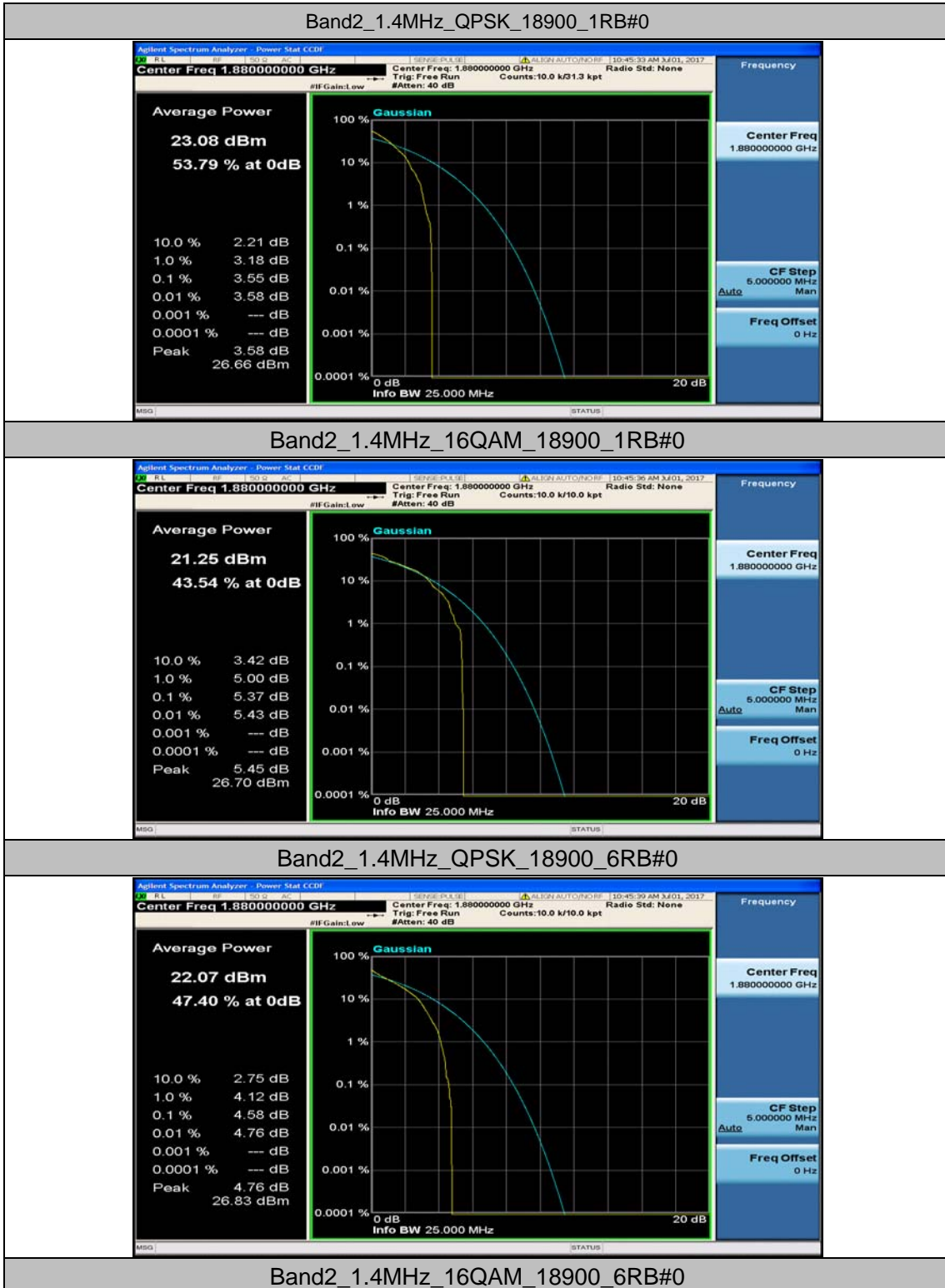

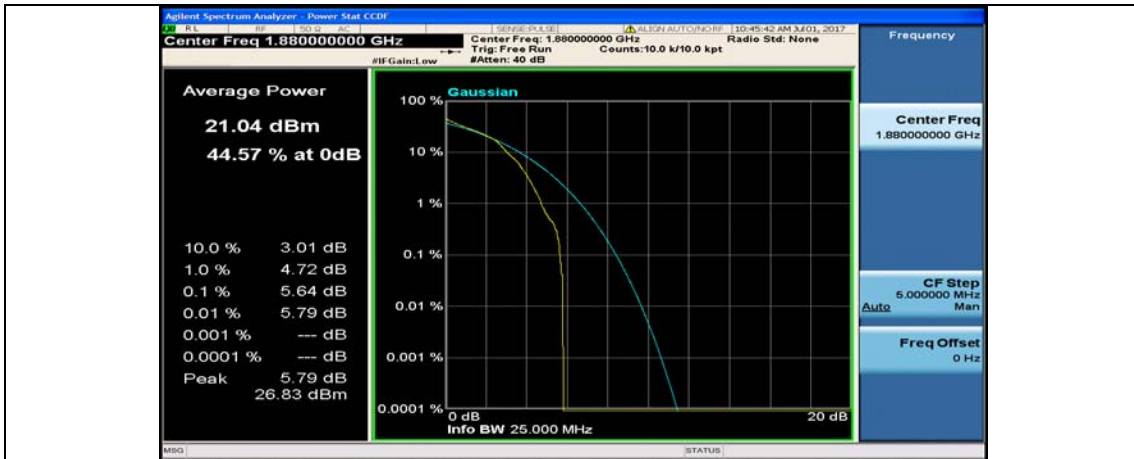

Band2\_3MHz\_QPSK\_18900\_15RB#0



Band2\_3MHz\_16QAM\_18900\_15RB#0

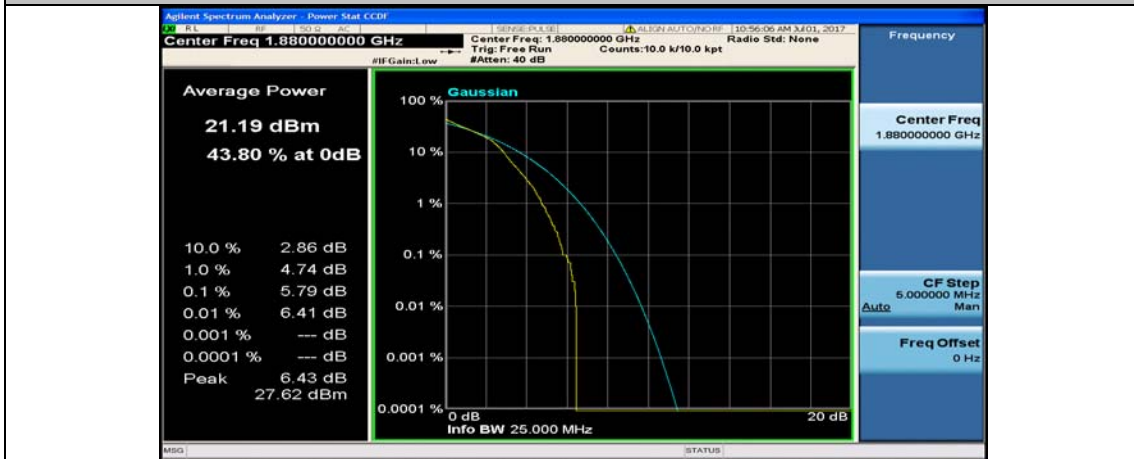

Band2\_3MHz\_QPSK\_18900\_1RB#0

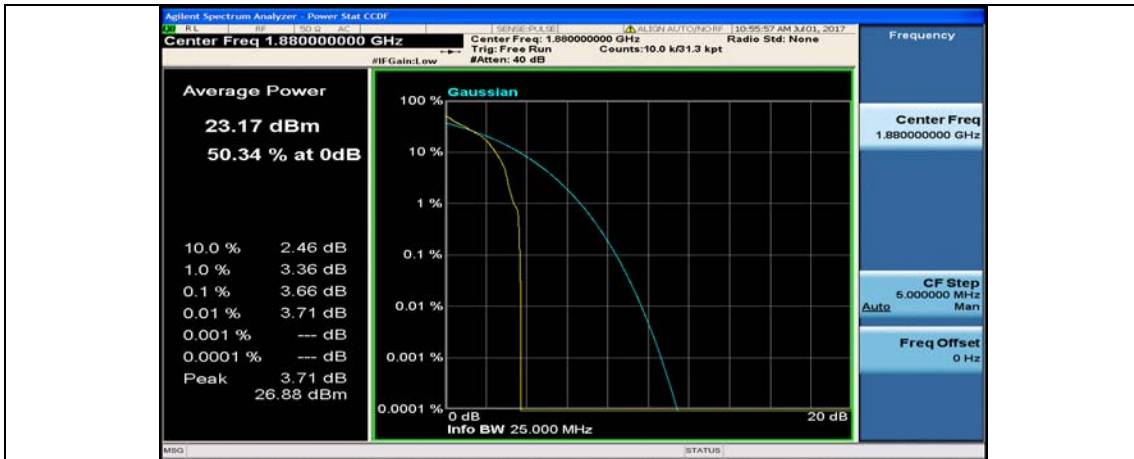

Band2\_3MHz\_16QAM\_18900\_1RB#0

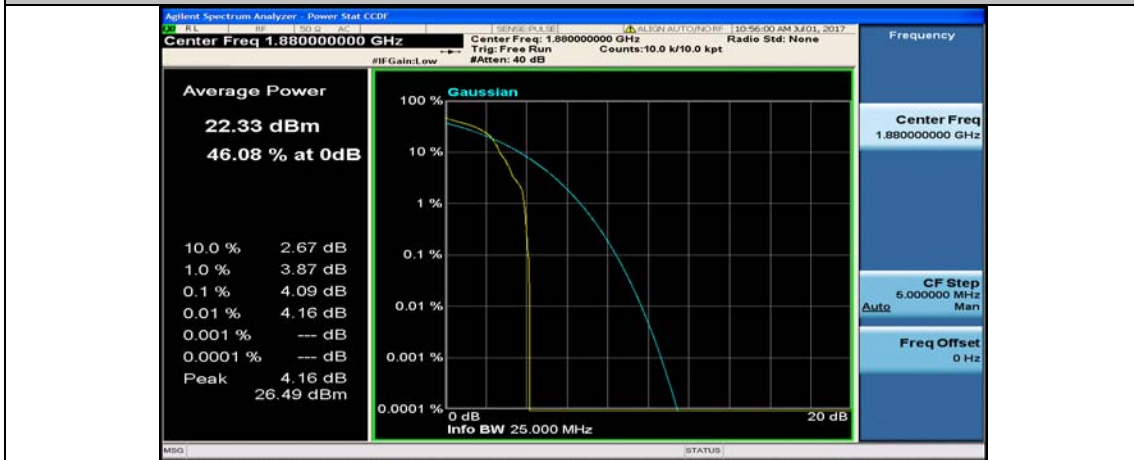

Band2\_5MHz\_QPSK\_18900\_1RB#0



Band2\_5MHz\_16QAM\_18900\_1RB#0



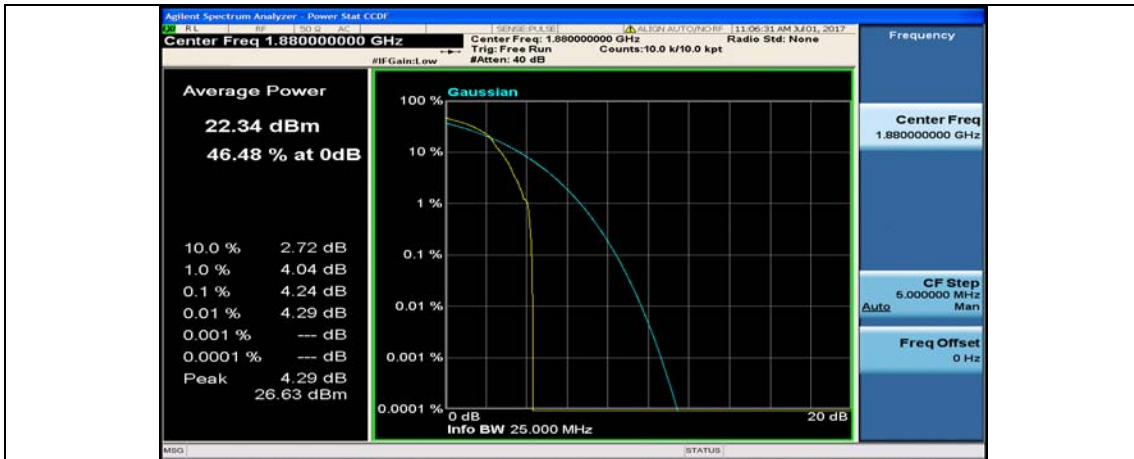

Band2\_5MHz\_QPSK\_18900\_25RB#0



Band2\_5MHz\_16QAM\_18900\_25RB#0

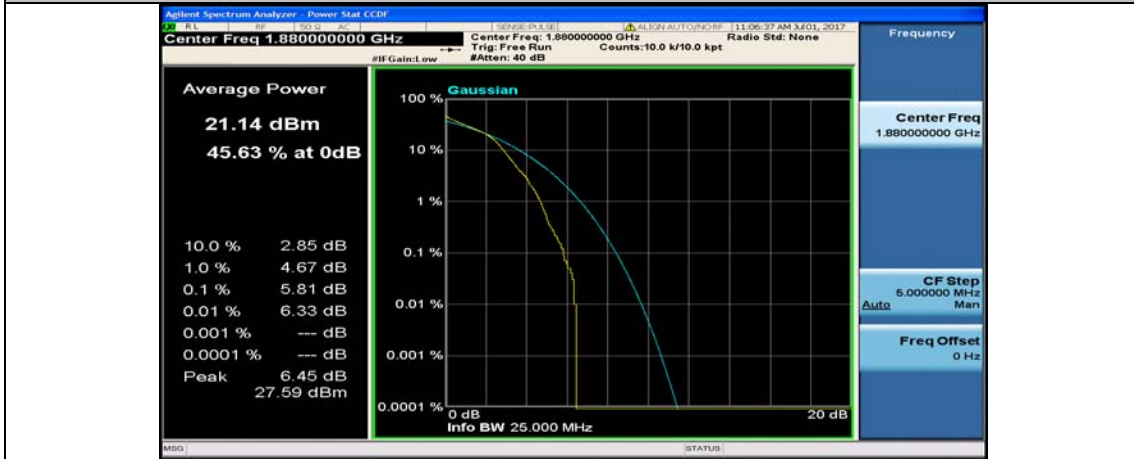

Band2\_10MHz\_QPSK\_18900\_1RB#0

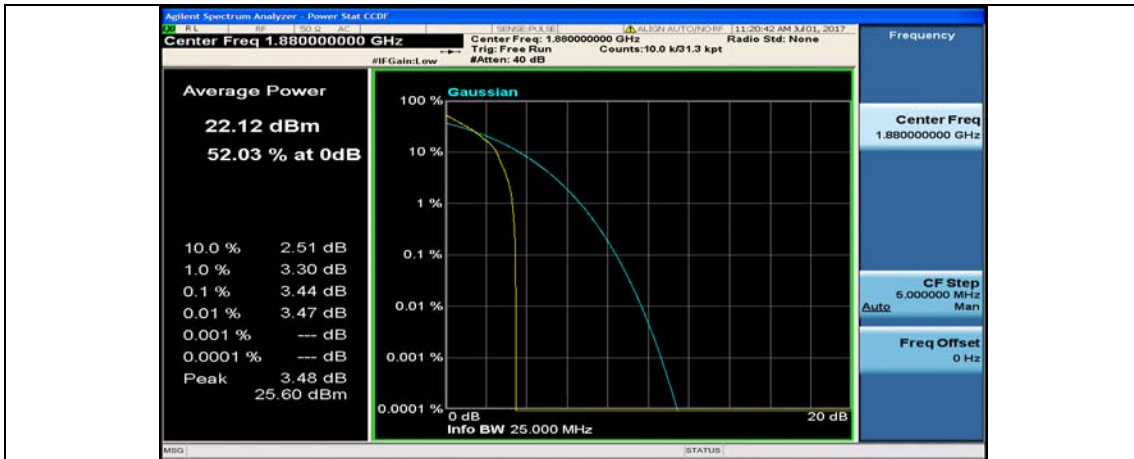

Band2\_10MHz\_16QAM\_18900\_1RB#0

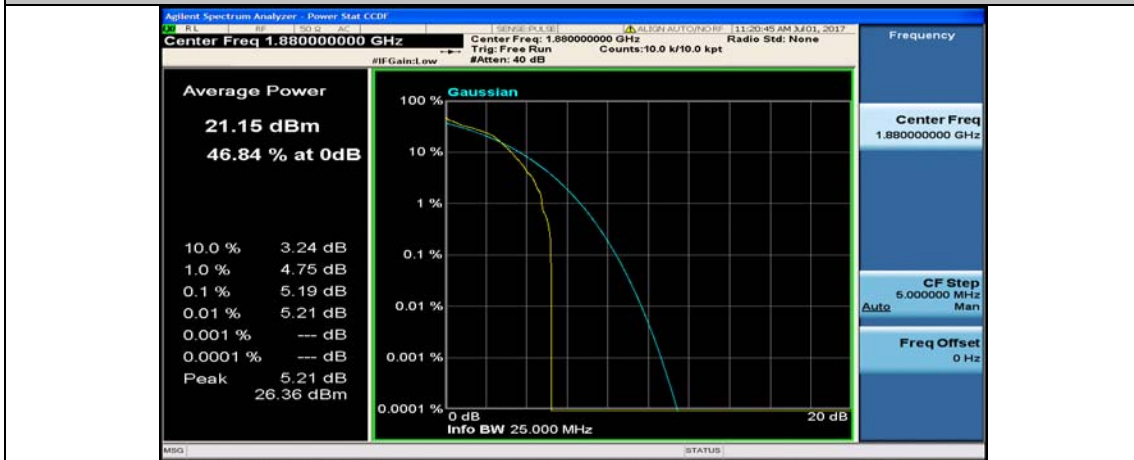

Band2\_10MHz\_QPSK\_18900\_50RB#0

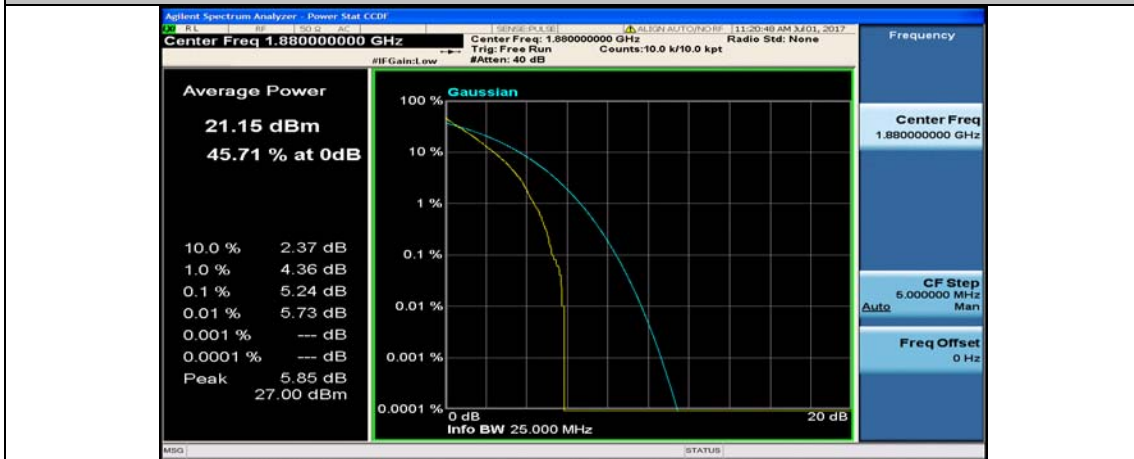

Band2\_10MHz\_16QAM\_18900\_50RB#0

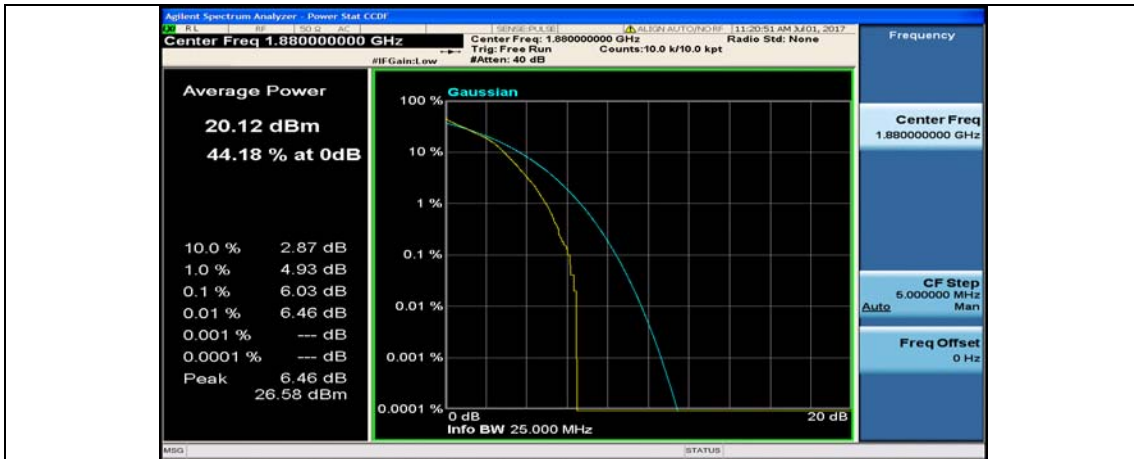

Band2\_15MHz\_QPSK\_18900\_1RB#0



Band2\_15MHz\_16QAM\_18900\_1RB#0

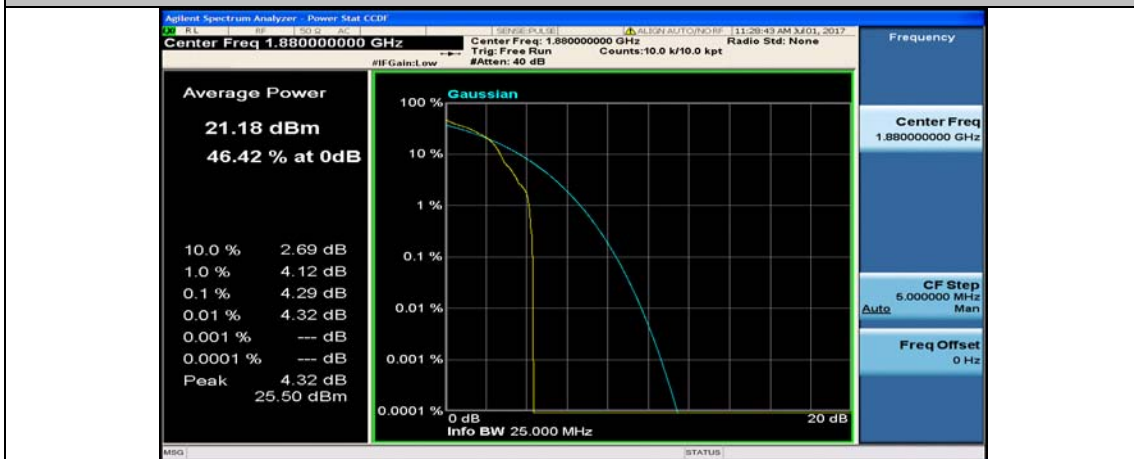

Band2\_15MHz\_QPSK\_18900\_75RB#0

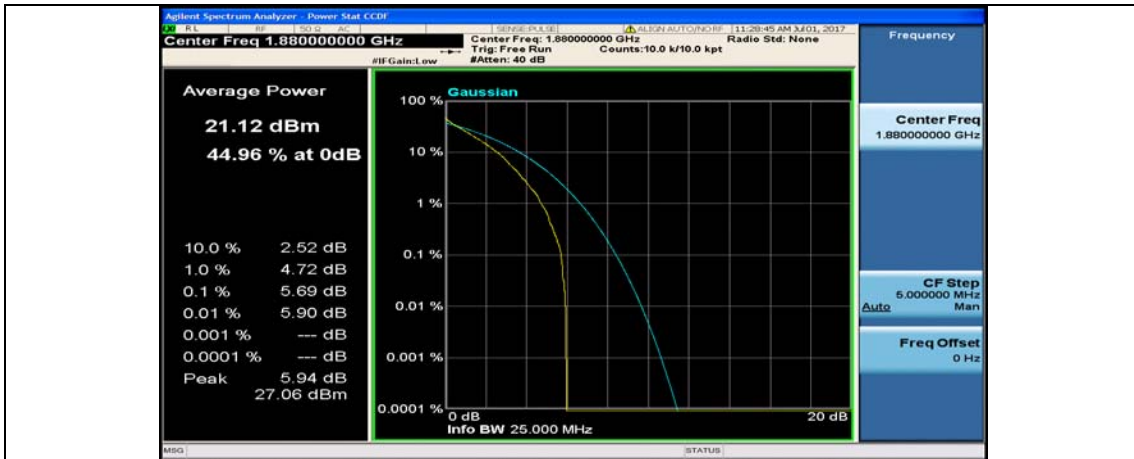

Band2\_15MHz\_16QAM\_18900\_75RB#0



Band2\_20MHz\_QPSK\_18900\_100RB#0

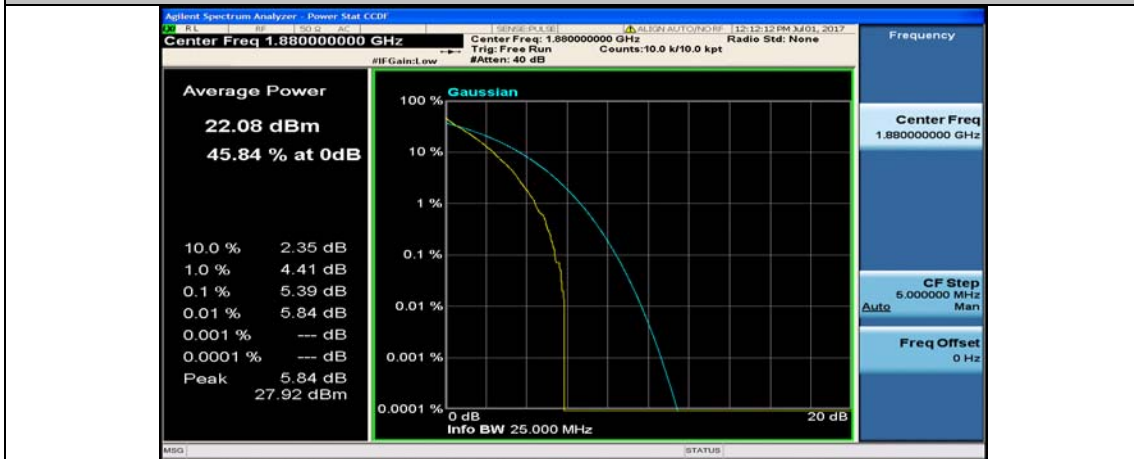

Band2\_20MHz\_16QAM\_18900\_100RB#0



Band2\_20MHz\_QPSK\_18900\_1RB#0



Band2\_20MHz\_16QAM\_18900\_1RB#0

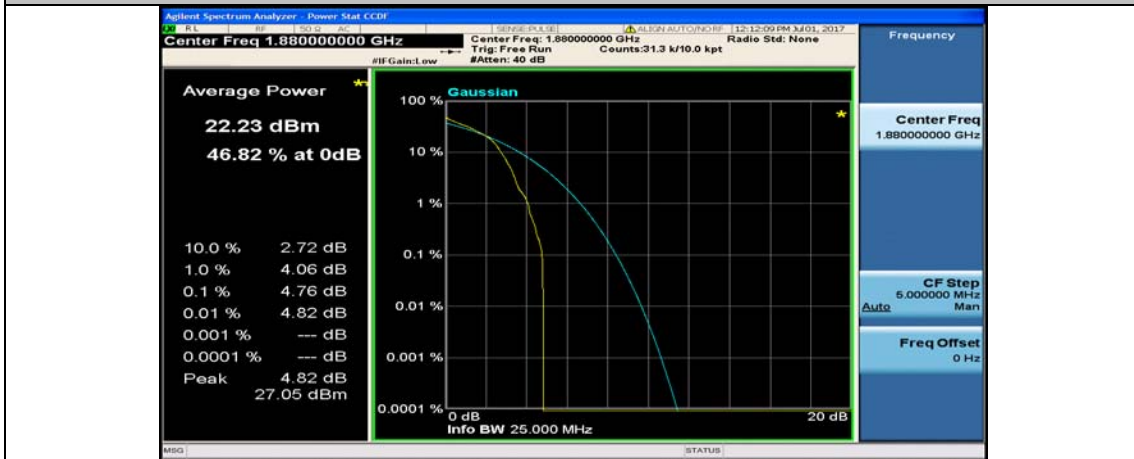

Band4\_1.4MHz\_QPSK\_20175\_1RB#0

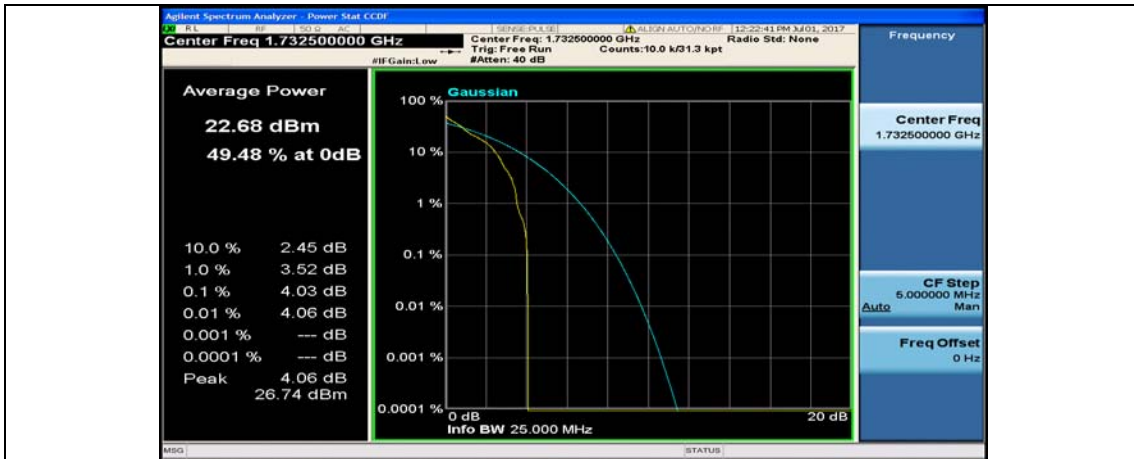

Band4\_1.4MHz\_16QAM\_20175\_1RB#0

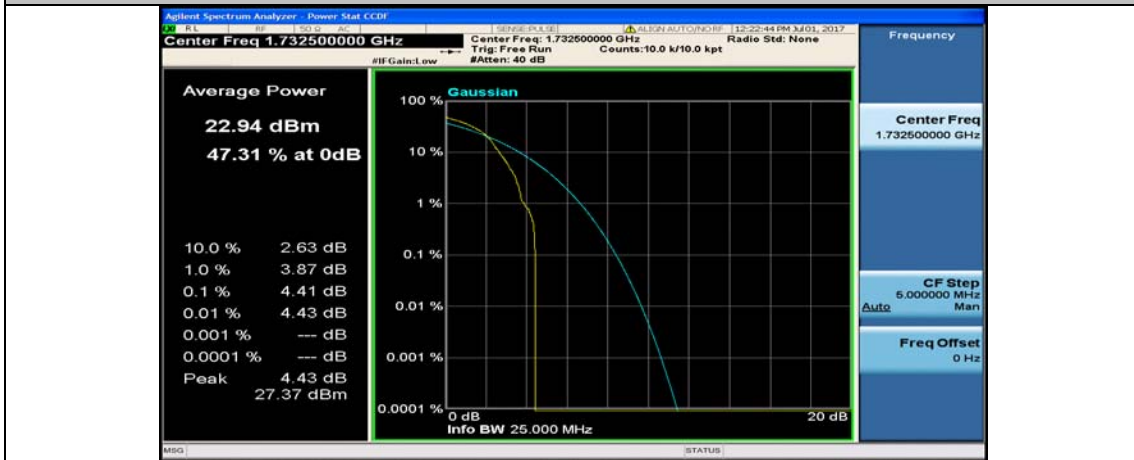

Band4\_1.4MHz\_QPSK\_20175\_6RB#0

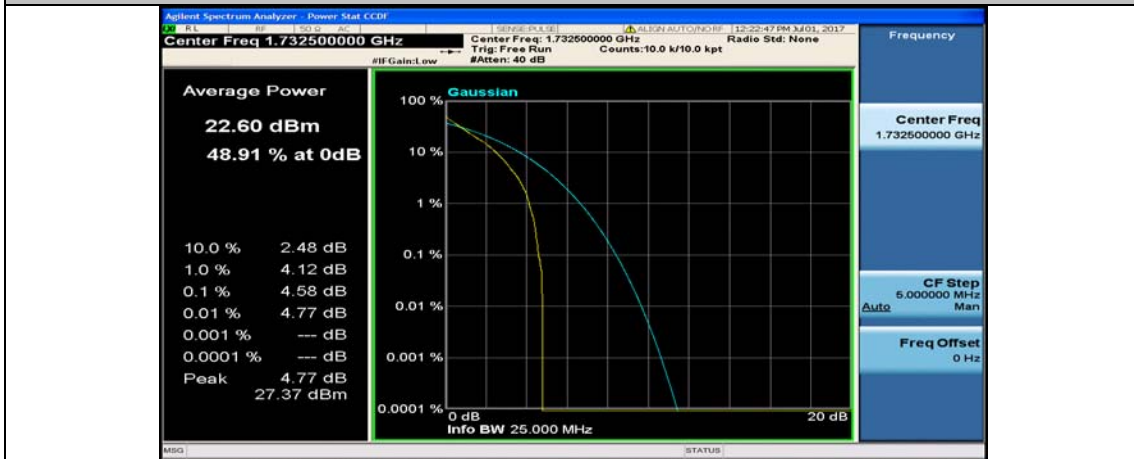

Band4\_1.4MHz\_16QAM\_20175\_6RB#0

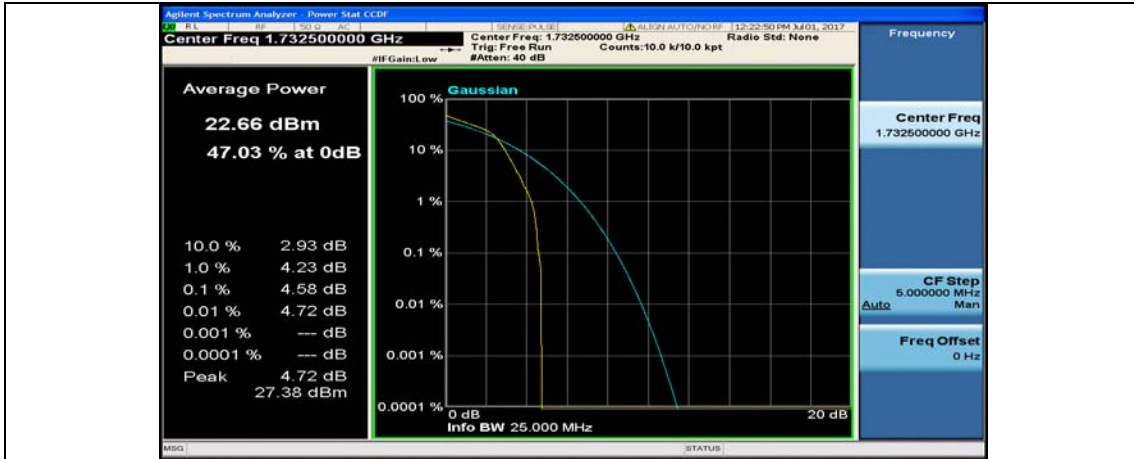

Band4\_3MHz\_QPSK\_20175\_15RB#0



Band4\_3MHz\_16QAM\_20175\_15RB#0

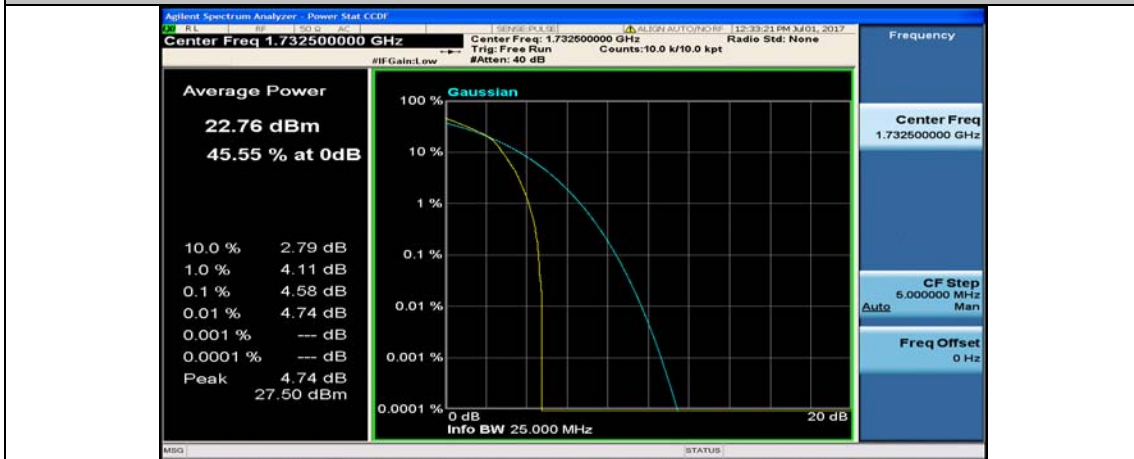

Band4\_3MHz\_QPSK\_20175\_1RB#0



Band4\_3MHz\_16QAM\_20175\_1RB#0



Band4\_5MHz\_QPSK\_20175\_1RB#0

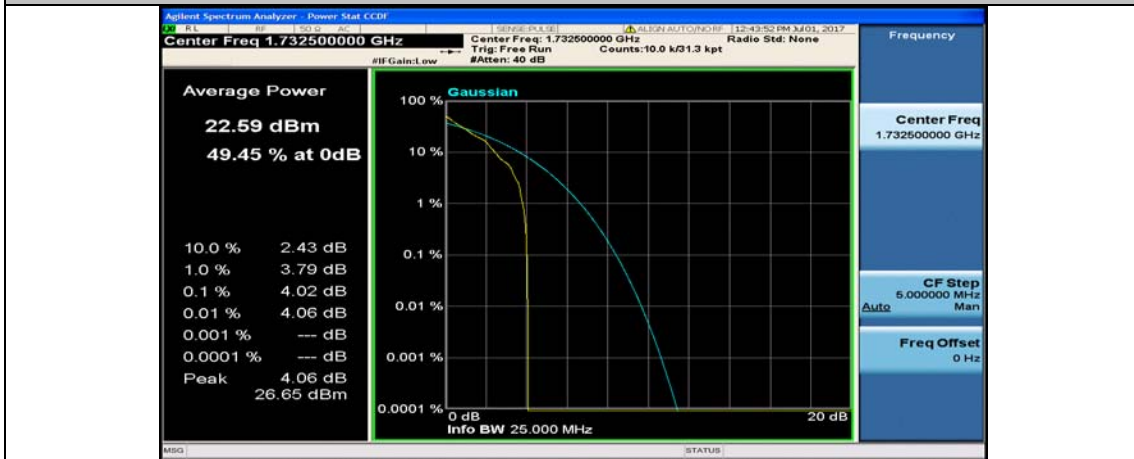

Band4\_5MHz\_16QAM\_20175\_1RB#0



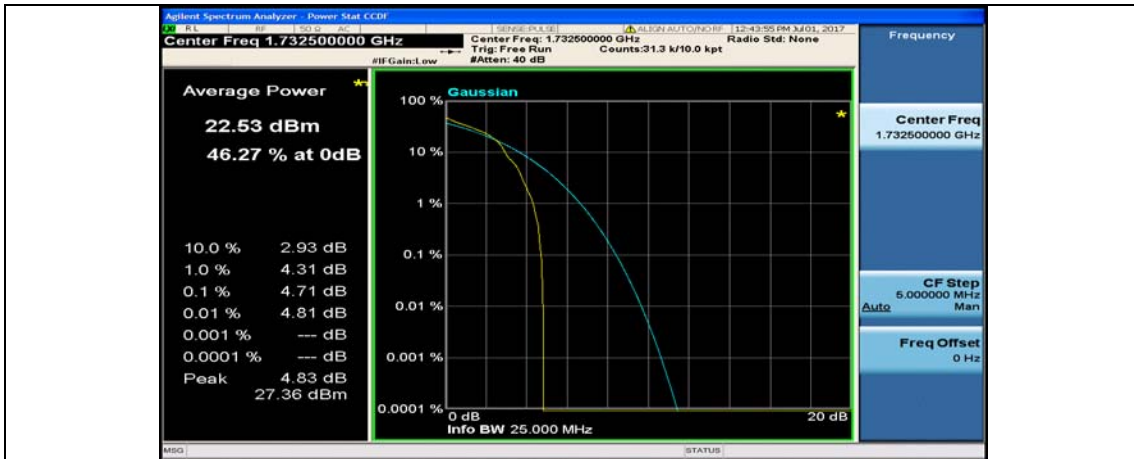

Band4\_5MHz\_QPSK\_20175\_25RB#0



Band4\_5MHz\_16QAM\_20175\_25RB#0



Band4\_10MHz\_QPSK\_20175\_1RB#0

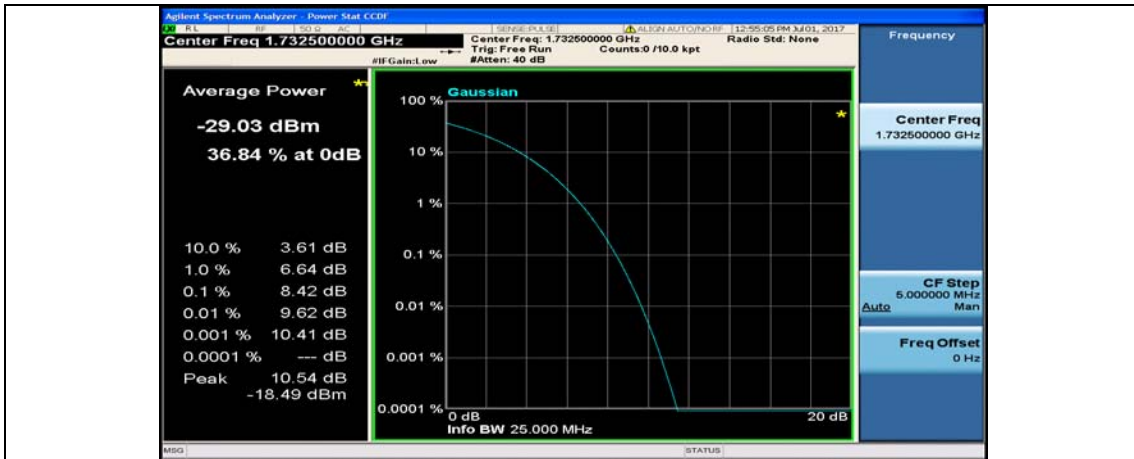

Band4\_10MHz\_16QAM\_20175\_1RB#0



Band4\_10MHz\_QPSK\_20175\_50RB#0

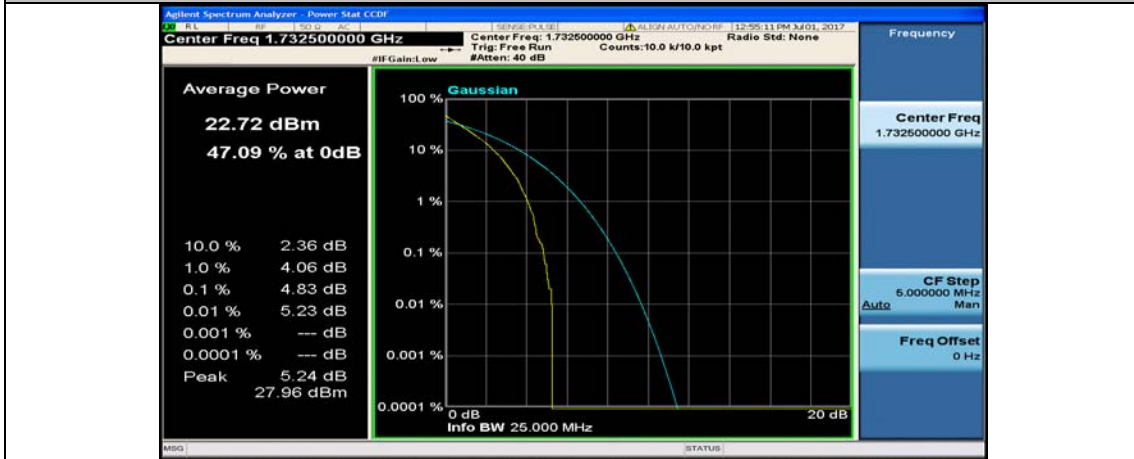

Band4\_10MHz\_16QAM\_20175\_50RB#0

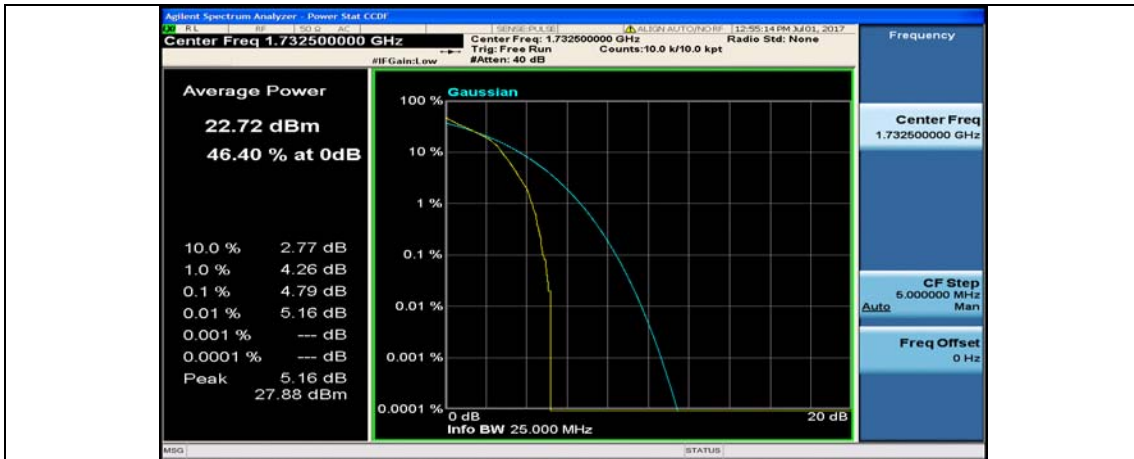

Band4\_15MHz\_QPSK\_20175\_1RB#0



Band4\_15MHz\_16QAM\_20175\_1RB#0

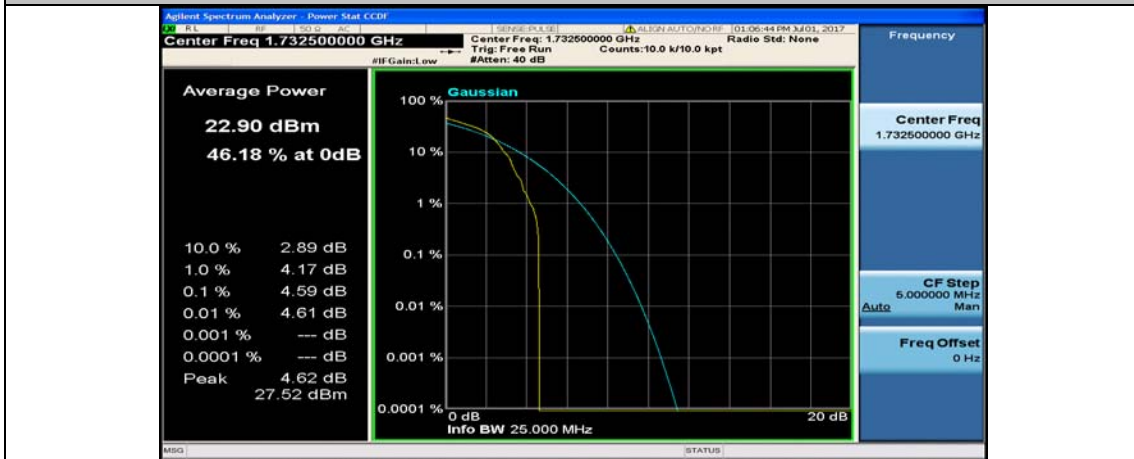

Band4\_15MHz\_QPSK\_20175\_75RB#0

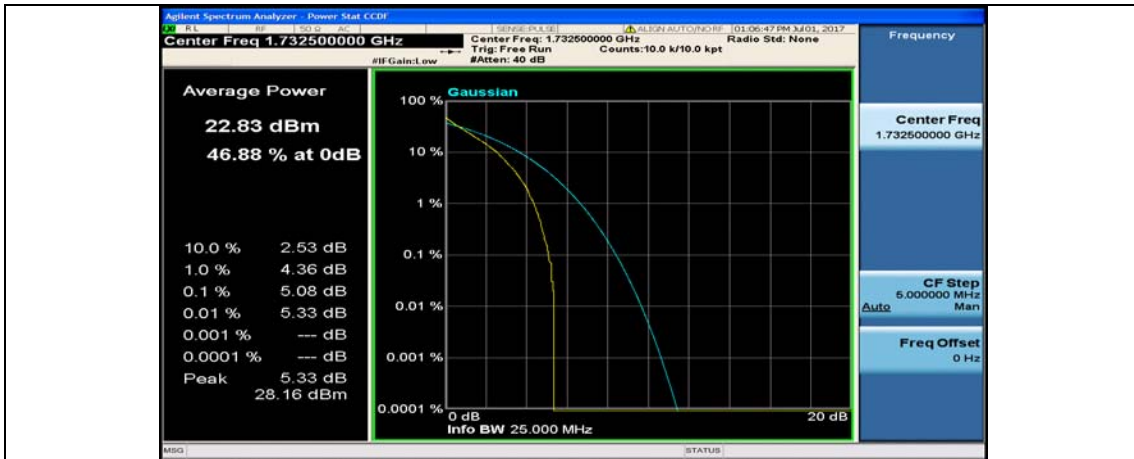

Band4\_15MHz\_16QAM\_20175\_75RB#0

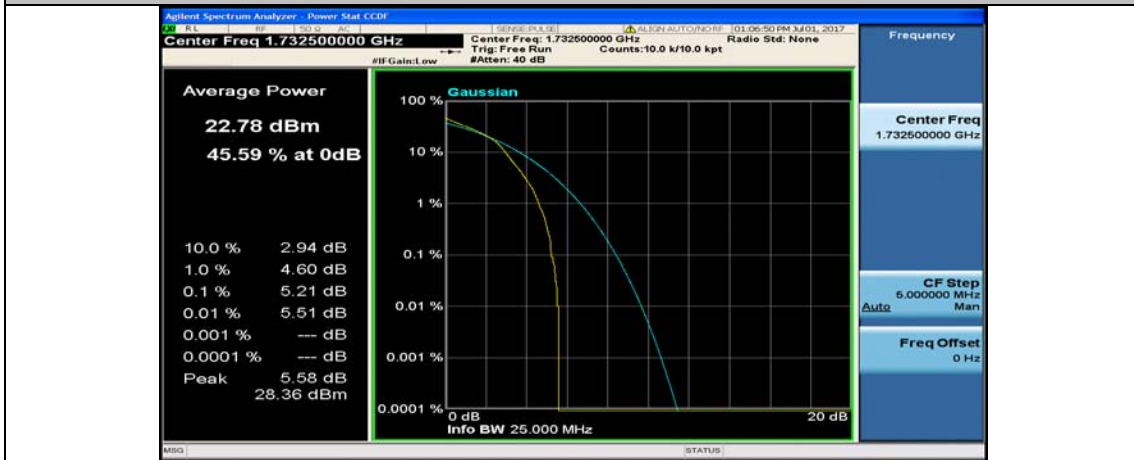

Band4\_20MHz\_QPSK\_20175\_100RB#0

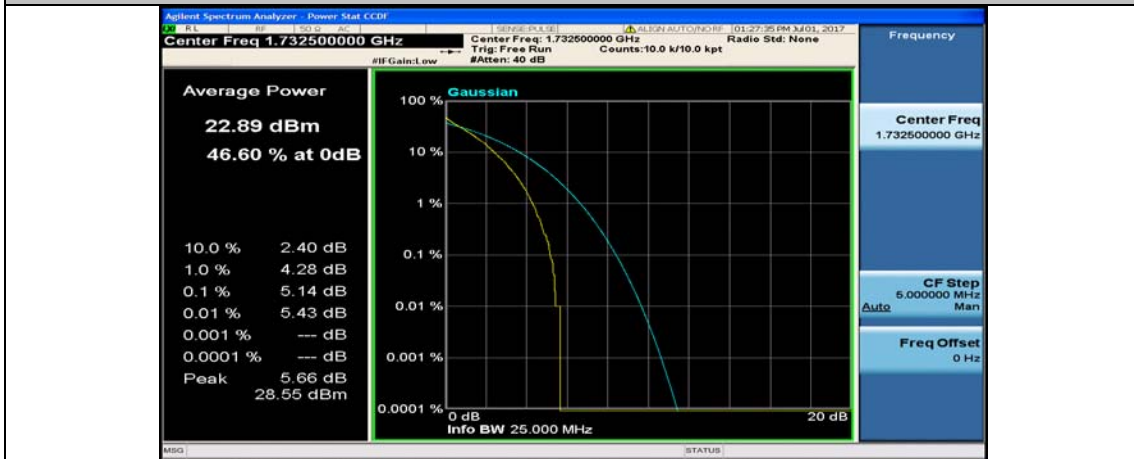

Band4\_20MHz\_16QAM\_20175\_100RB#0



Band4\_20MHz\_QPSK\_20175\_1RB#0



Band4\_20MHz\_16QAM\_20175\_1RB#0

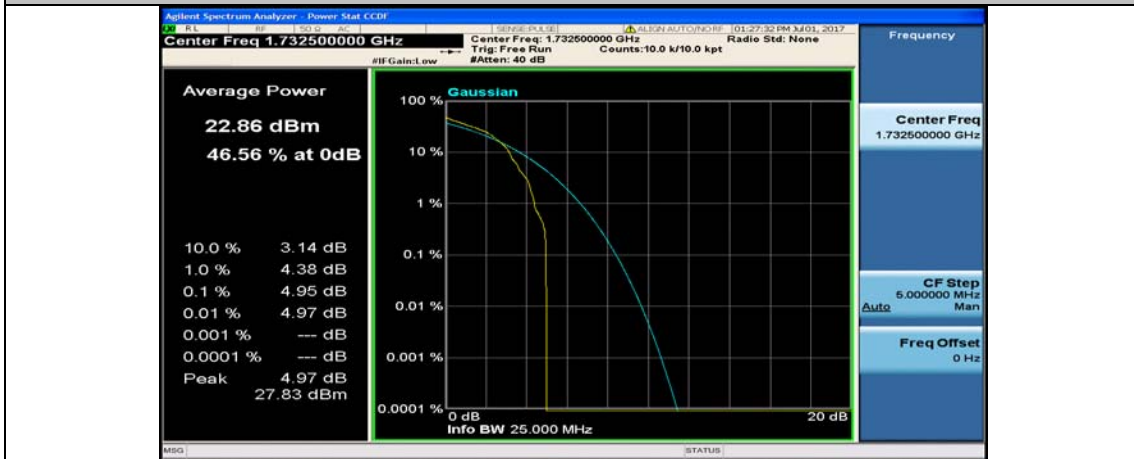

Band7\_5MHz\_QPSK\_21100\_1RB#0

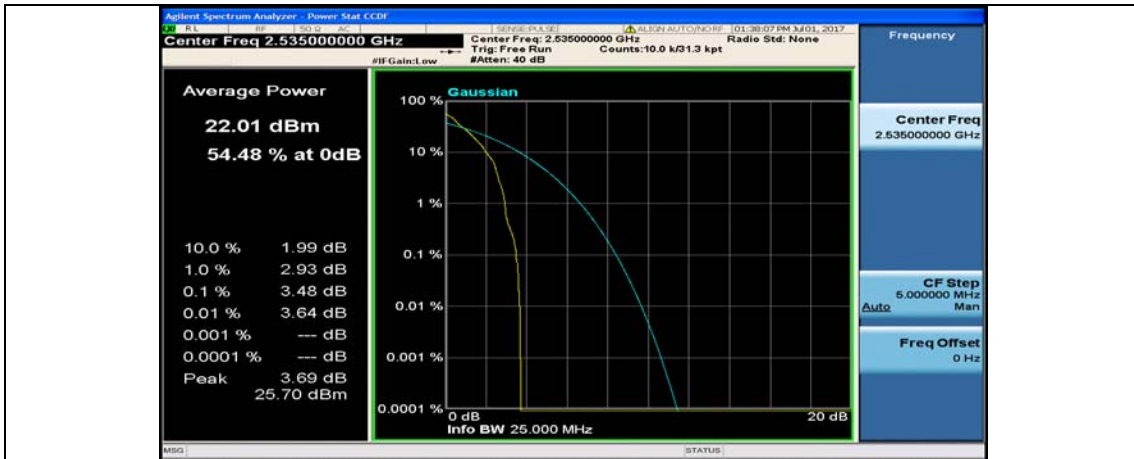

Band7\_5MHz\_16QAM\_21100\_1RB#0



Band7\_5MHz\_QPSK\_21100\_25RB#0

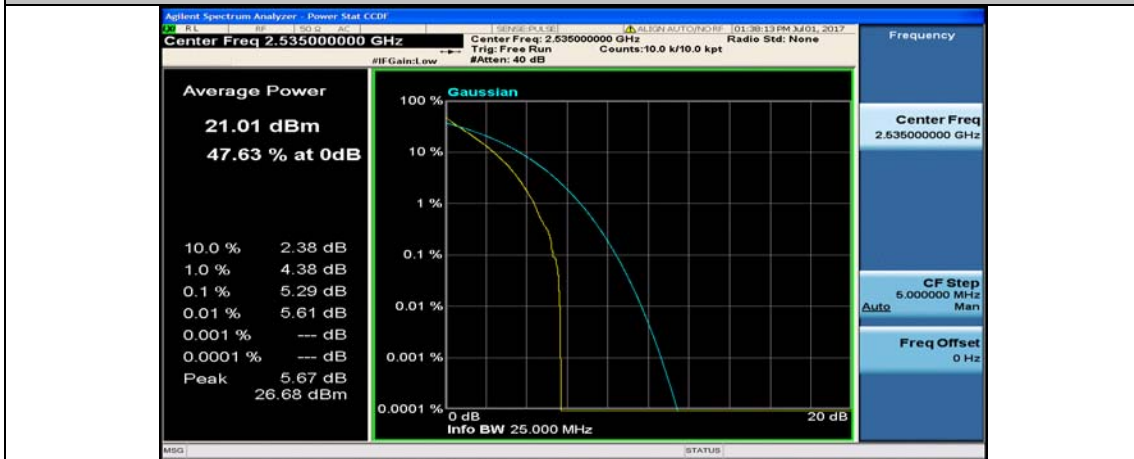

Band7\_5MHz\_16QAM\_21100\_25RB#0



Band7\_10MHz\_QPSK\_21100\_1RB#0



Band7\_10MHz\_16QAM\_21100\_1RB#0

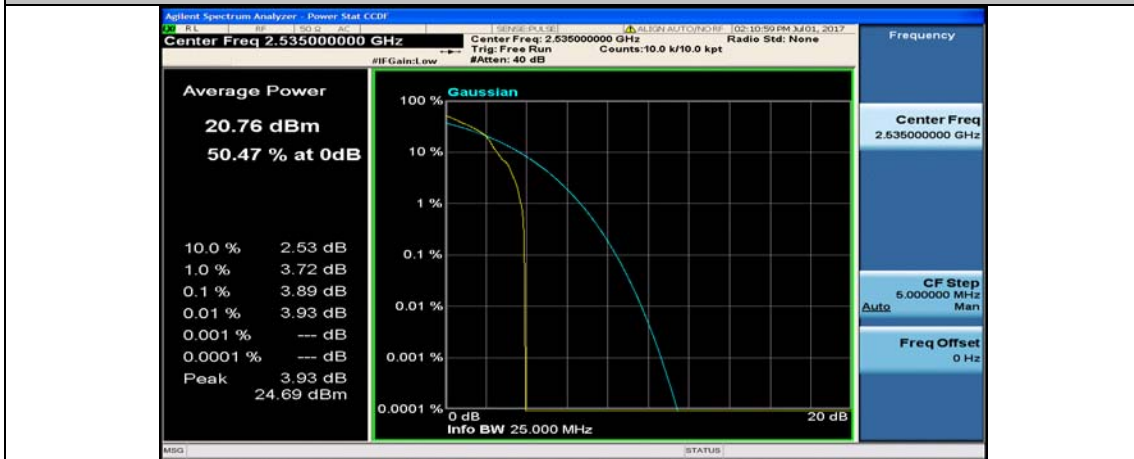

Band7\_10MHz\_QPSK\_21100\_50RB#0

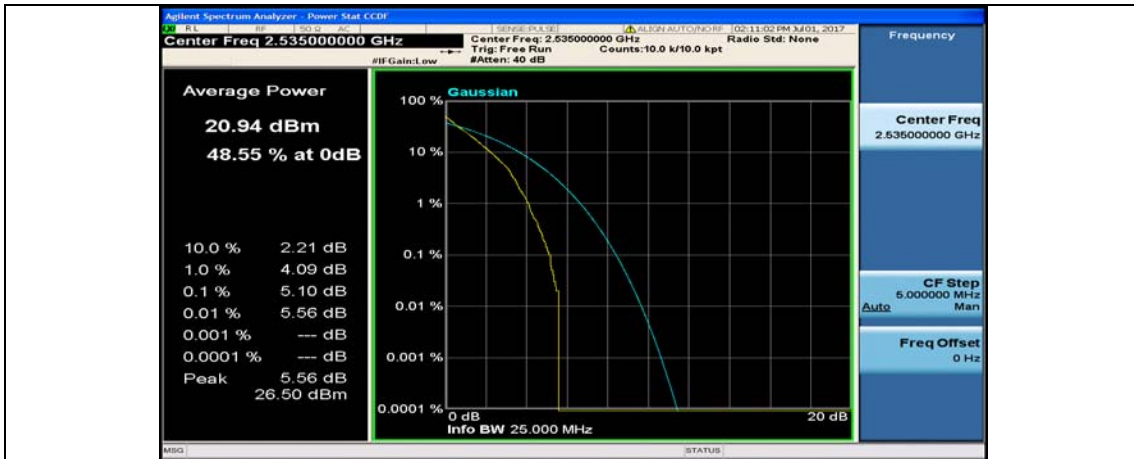

Band7\_10MHz\_16QAM\_21100\_50RB#0



Band7\_15MHz\_QPSK\_21100\_1RB#0



Band7\_15MHz\_16QAM\_21100\_1RB#0



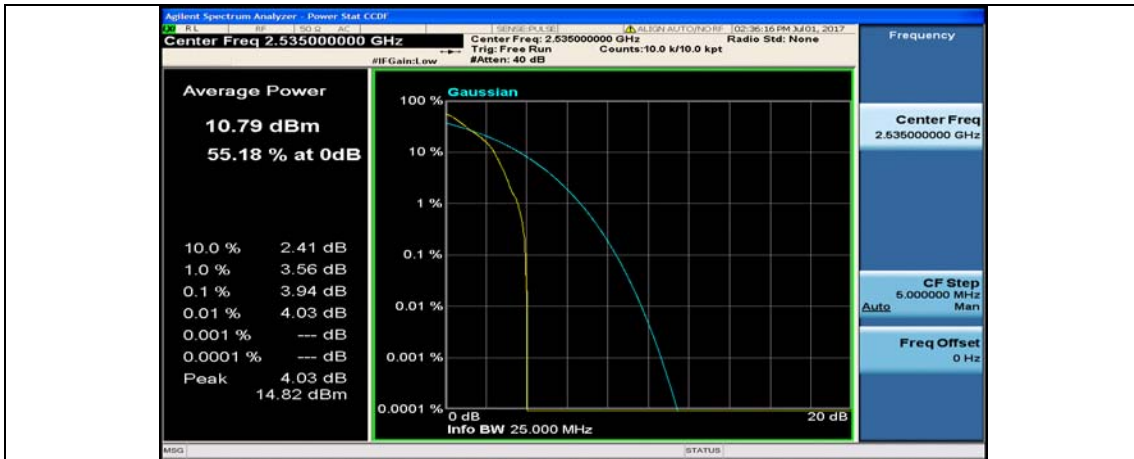

Band7\_15MHz\_QPSK\_21100\_75RB#0



Band7\_15MHz\_16QAM\_21100\_75RB#0



Band7\_20MHz\_QPSK\_21100\_100RB#0

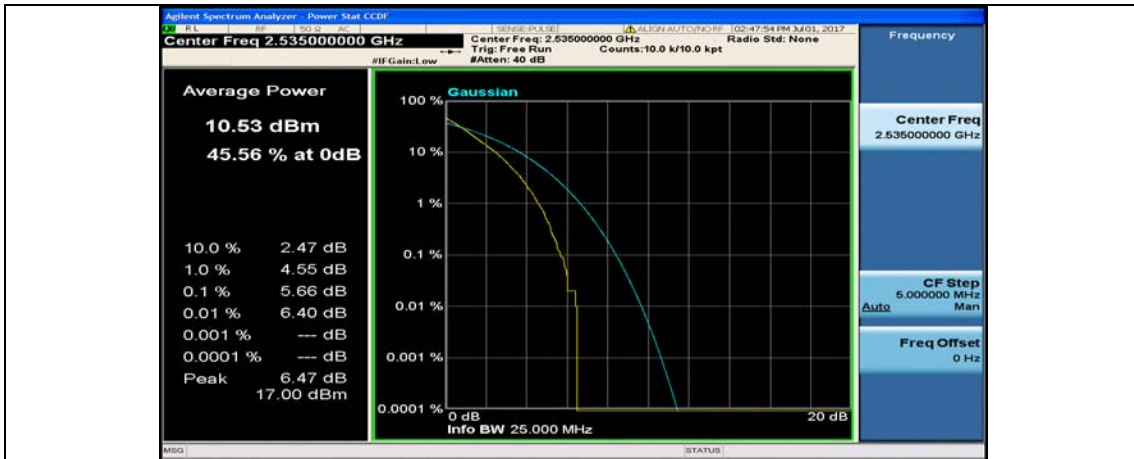

Band7\_20MHz\_16QAM\_21100\_100RB#0



Band7\_20MHz\_QPSK\_21100\_1RB#0



Band7\_20MHz\_16QAM\_21100\_1RB#0

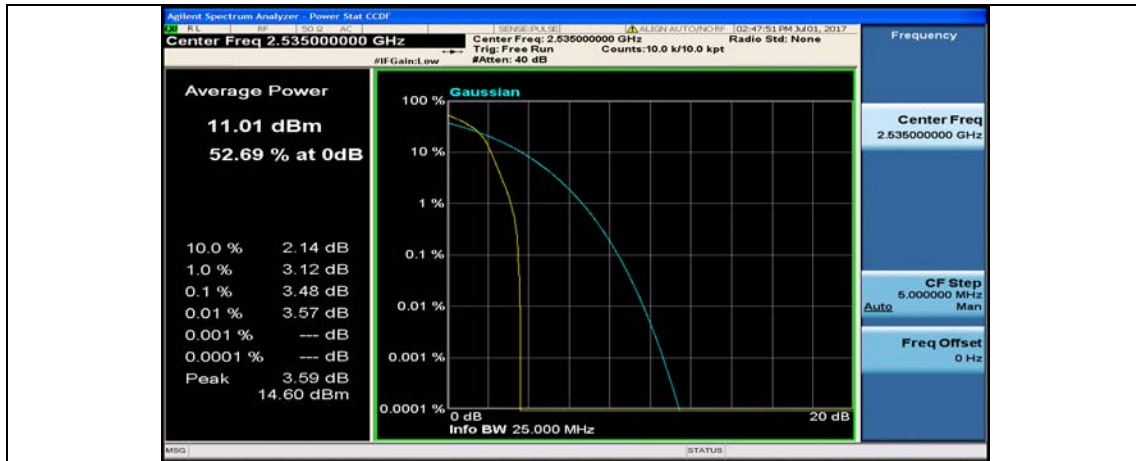

## Appendix C: 26dB Bandwidth and Occupied Bandwidth

### Test Result

Band	Bandwidth	Modulation	Channel	RB Configuration	Occupied Bandwidth (MHz)	26dB Bandwidth (MHz)	Verdict
2	1.4MHz	QPSK	18607	6RB#0	1.0811	1.227	PASS
2	1.4MHz	16QAM	18607	6RB#0	1.0790	1.236	PASS
2	1.4MHz	QPSK	18900	6RB#0	1.0783	1.236	PASS
2	1.4MHz	16QAM	18900	6RB#0	1.0769	1.221	PASS
2	1.4MHz	QPSK	19193	6RB#0	1.0803	1.220	PASS
2	1.4MHz	16QAM	19193	6RB#0	1.0791	1.230	PASS
2	3MHz	QPSK	18615	15RB#0	2.6877	2.894	PASS
2	3MHz	16QAM	18615	15RB#0	2.6845	2.880	PASS
2	3MHz	QPSK	18900	15RB#0	2.6897	2.882	PASS
2	3MHz	16QAM	18900	15RB#0	2.6886	2.872	PASS
2	3MHz	QPSK	19185	15RB#0	2.6837	2.870	PASS
2	3MHz	16QAM	19185	15RB#0	2.6808	2.890	PASS
2	5MHz	QPSK	18625	25RB#0	4.4764	4.844	PASS
2	5MHz	16QAM	18625	25RB#0	4.4771	4.868	PASS
2	5MHz	QPSK	18900	25RB#0	4.4850	4.795	PASS
2	5MHz	16QAM	18900	25RB#0	4.4825	4.866	PASS
2	5MHz	QPSK	19175	25RB#0	4.4817	4.802	PASS
2	5MHz	16QAM	19175	25RB#0	4.4783	4.846	PASS
2	10MHz	QPSK	18650	50RB#0	8.9194	9.442	PASS
2	10MHz	16QAM	18650	50RB#0	8.9175	9.419	PASS
2	10MHz	QPSK	18900	50RB#0	8.9376	9.464	PASS
2	10MHz	16QAM	18900	50RB#0	8.9249	9.441	PASS
2	10MHz	QPSK	19150	50RB#0	8.9409	9.468	PASS
2	10MHz	16QAM	19150	50RB#0	8.9336	9.475	PASS
2	15MHz	QPSK	18675	75RB#0	13.384	14.11	PASS
2	15MHz	16QAM	18675	75RB#0	13.375	14.10	PASS
2	15MHz	QPSK	18900	75RB#0	13.396	14.05	PASS
2	15MHz	16QAM	18900	75RB#0	13.391	14.04	PASS
2	15MHz	QPSK	19125	75RB#0	13.415	14.15	PASS
2	15MHz	16QAM	19125	75RB#0	13.409	14.13	PASS
2	20MHz	QPSK	18700	100RB#0	17.849	18.70	PASS
2	20MHz	16QAM	18700	100RB#0	17.873	18.70	PASS
2	20MHz	QPSK	18900	100RB#0	17.867	18.68	PASS

2	20MHz	16QAM	18900	100RB#0	17.876	18.72	PASS
2	20MHz	QPSK	19100	100RB#0	17.903	18.67	PASS
2	20MHz	16QAM	19100	100RB#0	17.885	18.68	PASS
4	1.4MHz	QPSK	19957	6RB#0	1.0808	1.229	PASS
4	1.4MHz	16QAM	19957	6RB#0	1.0798	1.237	PASS
4	1.4MHz	QPSK	20175	6RB#0	1.0786	1.221	PASS
4	1.4MHz	16QAM	20175	6RB#0	1.0779	1.217	PASS
4	1.4MHz	QPSK	20393	6RB#0	1.0798	1.216	PASS
4	1.4MHz	16QAM	20393	6RB#0	1.0784	1.238	PASS
4	3MHz	QPSK	19965	15RB#0	2.6870	2.871	PASS
4	3MHz	16QAM	19965	15RB#0	2.6828	2.891	PASS
4	3MHz	QPSK	20175	15RB#0	2.6923	2.879	PASS
4	3MHz	16QAM	20175	15RB#0	2.6867	2.890	PASS
4	3MHz	QPSK	20385	15RB#0	2.6872	2.877	PASS
4	3MHz	16QAM	20385	15RB#0	2.6854	2.885	PASS
4	5MHz	QPSK	19975	25RB#0	4.4778	4.833	PASS
4	5MHz	16QAM	19975	25RB#0	4.4789	4.886	PASS
4	5MHz	QPSK	20175	25RB#0	4.4838	4.844	PASS
4	5MHz	16QAM	20175	25RB#0	4.4879	4.871	PASS
4	5MHz	QPSK	20375	25RB#0	4.4784	4.818	PASS
4	5MHz	16QAM	20375	25RB#0	4.4845	4.861	PASS
4	10MHz	QPSK	20000	50RB#0	8.9377	9.441	PASS
4	10MHz	16QAM	20000	50RB#0	8.9345	9.435	PASS
4	10MHz	QPSK	20175	50RB#0	8.9303	9.464	PASS
4	10MHz	16QAM	20175	50RB#0	8.9306	9.445	PASS
4	10MHz	QPSK	20350	50RB#0	8.9427	9.451	PASS
4	10MHz	16QAM	20350	50RB#0	8.9318	9.451	PASS
4	15MHz	QPSK	20025	75RB#0	13.403	14.11	PASS
4	15MHz	16QAM	20025	75RB#0	13.400	14.10	PASS
4	15MHz	QPSK	20175	75RB#0	13.411	14.04	PASS
4	15MHz	16QAM	20175	75RB#0	13.405	14.12	PASS
4	15MHz	QPSK	20325	75RB#0	13.423	14.18	PASS
4	15MHz	16QAM	20325	75RB#0	13.406	14.15	PASS
4	20MHz	QPSK	20050	100RB#0	17.864	18.75	PASS
4	20MHz	16QAM	20050	100RB#0	17.885	18.70	PASS
4	20MHz	QPSK	20175	100RB#0	17.877	18.65	PASS
4	20MHz	16QAM	20175	100RB#0	17.898	18.75	PASS
4	20MHz	QPSK	20300	100RB#0	17.889	18.65	PASS
4	20MHz	16QAM	20300	100RB#0	17.868	18.70	PASS
7	5MHz	QPSK	20775	25RB#0	4.4811	4.820	PASS
7	5MHz	16QAM	20775	25RB#0	4.4833	4.877	PASS
7	5MHz	QPSK	21100	25RB#0	4.4831	4.822	PASS
7	5MHz	16QAM	21100	25RB#0	4.4808	4.833	PASS

7	5MHz	QPSK	21425	25RB#0	4.4800	4.872	PASS
7	5MHz	16QAM	21425	25RB#0	4.4810	4.822	PASS
7	10MHz	QPSK	20800	50RB#0	8.9421	9.450	PASS
7	10MHz	16QAM	20800	50RB#0	8.9325	9.429	PASS
7	10MHz	QPSK	21100	50RB#0	8.9335	9.476	PASS
7	10MHz	16QAM	21100	50RB#0	8.9373	9.471	PASS
7	10MHz	QPSK	21400	50RB#0	8.9619	9.534	PASS
7	10MHz	16QAM	21400	50RB#0	8.9402	9.464	PASS
7	15MHz	QPSK	20825	75RB#0	13.403	14.13	PASS
7	15MHz	16QAM	20825	75RB#0	13.399	14.05	PASS
7	15MHz	QPSK	21100	75RB#0	13.424	14.07	PASS
7	15MHz	16QAM	21100	75RB#0	13.414	14.07	PASS
7	15MHz	QPSK	21375	75RB#0	13.450	14.24	PASS
7	15MHz	16QAM	21375	75RB#0	13.428	14.13	PASS
7	20MHz	QPSK	20850	100RB#0	17.778	18.64	PASS
7	20MHz	16QAM	20850	100RB#0	17.808	18.63	PASS
7	20MHz	QPSK	21100	100RB#0	17.919	18.70	PASS
7	20MHz	16QAM	21100	100RB#0	17.929	18.69	PASS
7	20MHz	QPSK	21350	100RB#0	17.903	18.64	PASS
7	20MHz	16QAM	21350	100RB#0	17.878	18.67	PASS

### Test Graphs

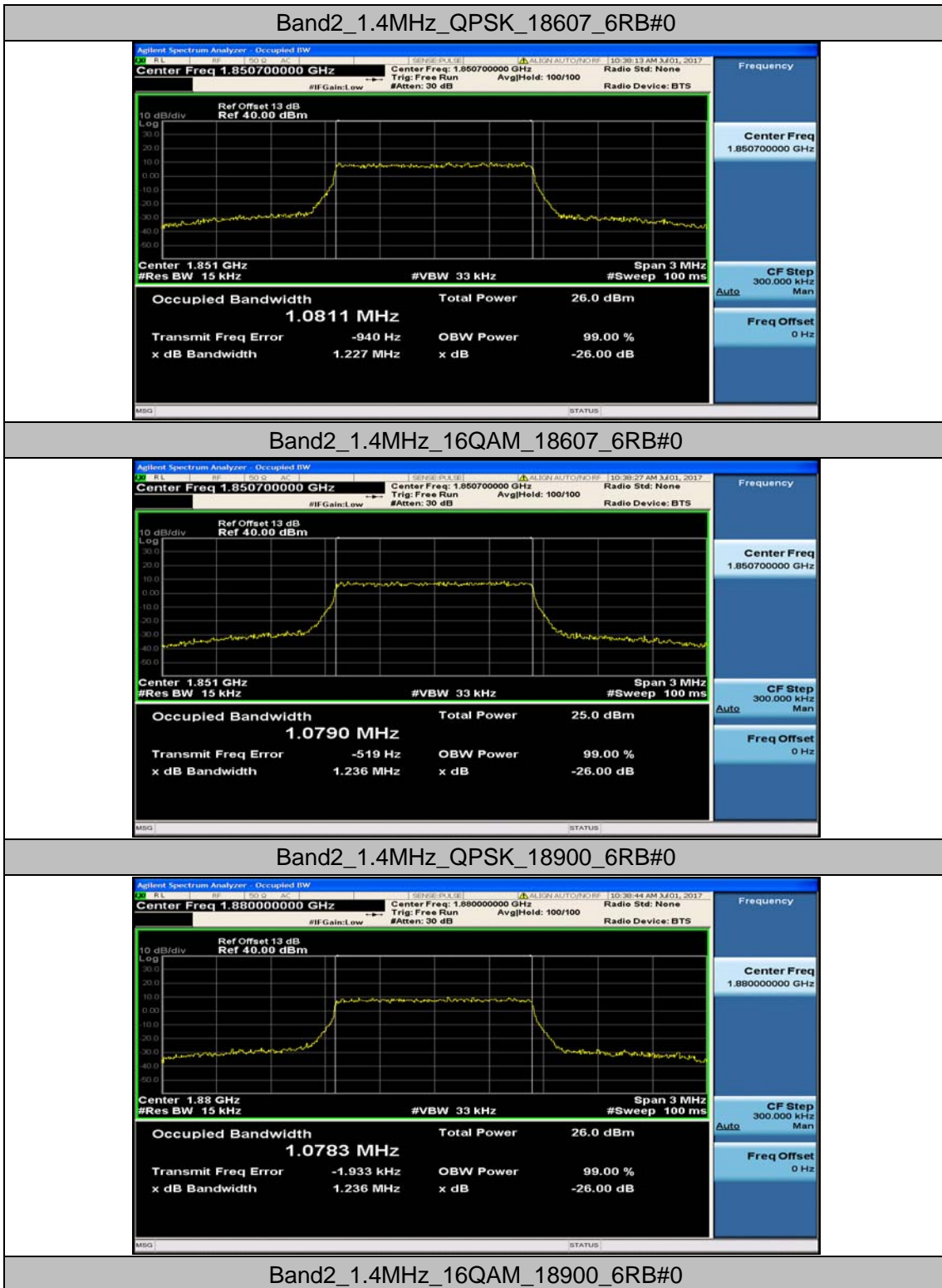

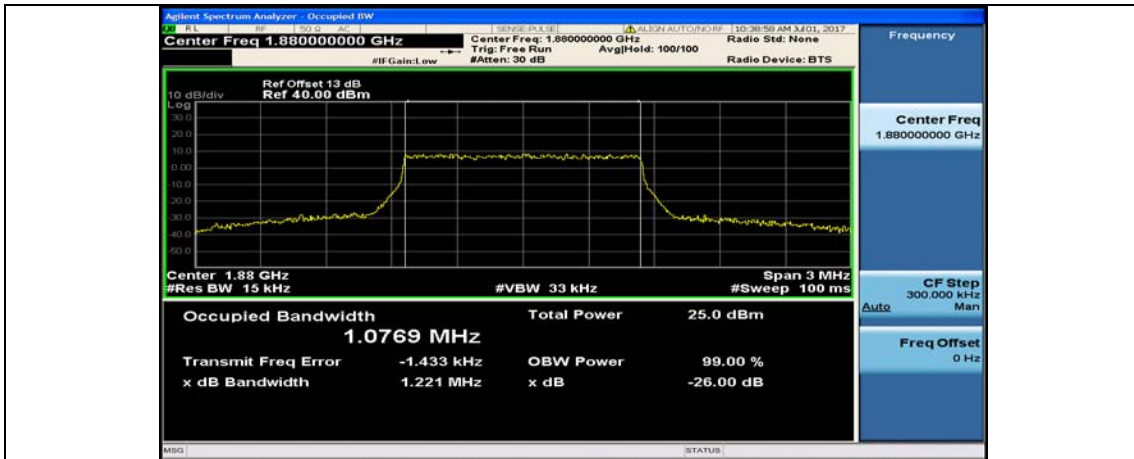

Band2\_1.4MHz\_QPSK\_19193\_6RB#0

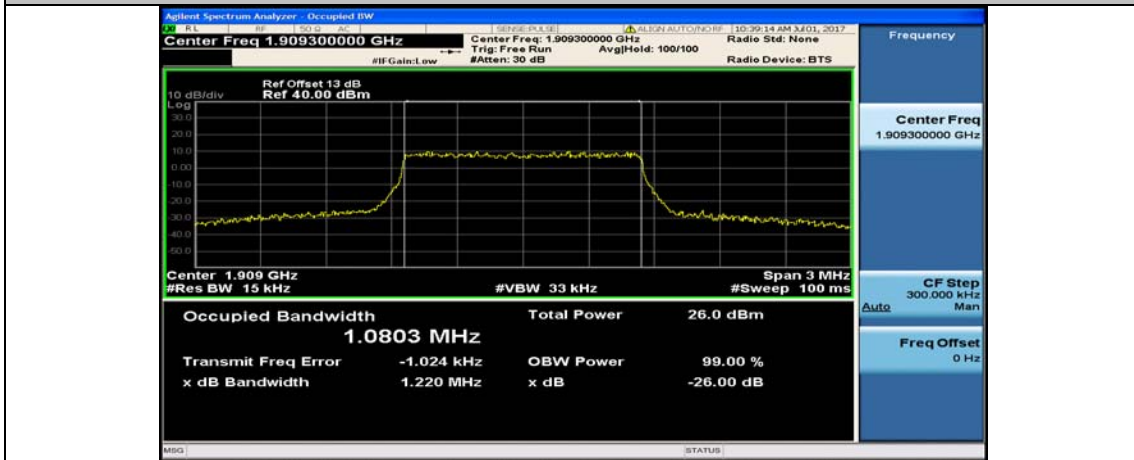

Band2\_1.4MHz\_16QAM\_19193\_6RB#0

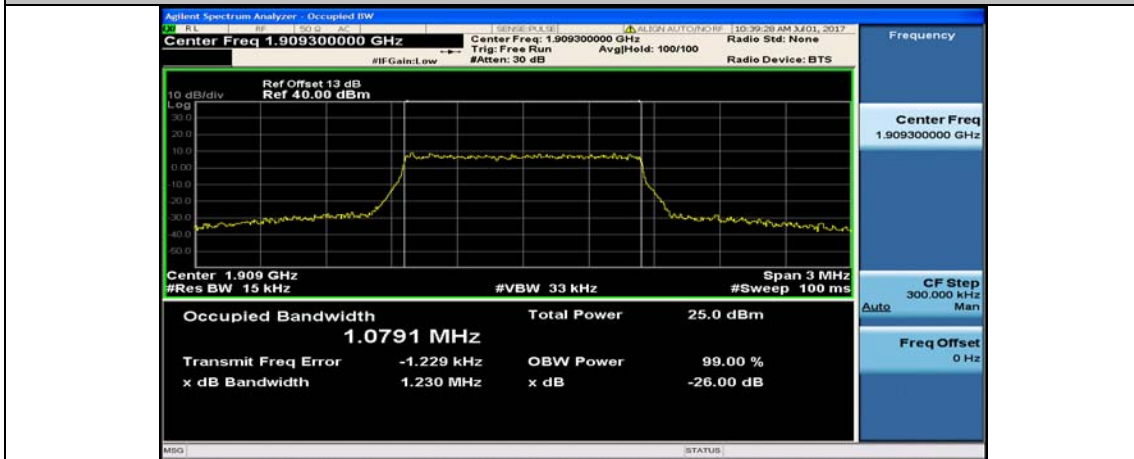

Band2\_3MHz\_QPSK\_18615\_15RB#0



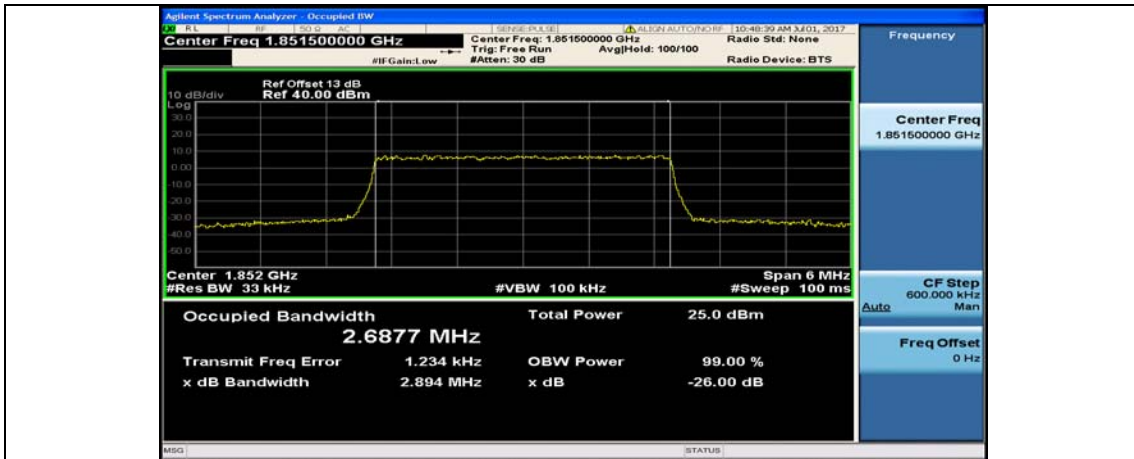

Band2\_3MHz\_16QAM\_18615\_15RB#0

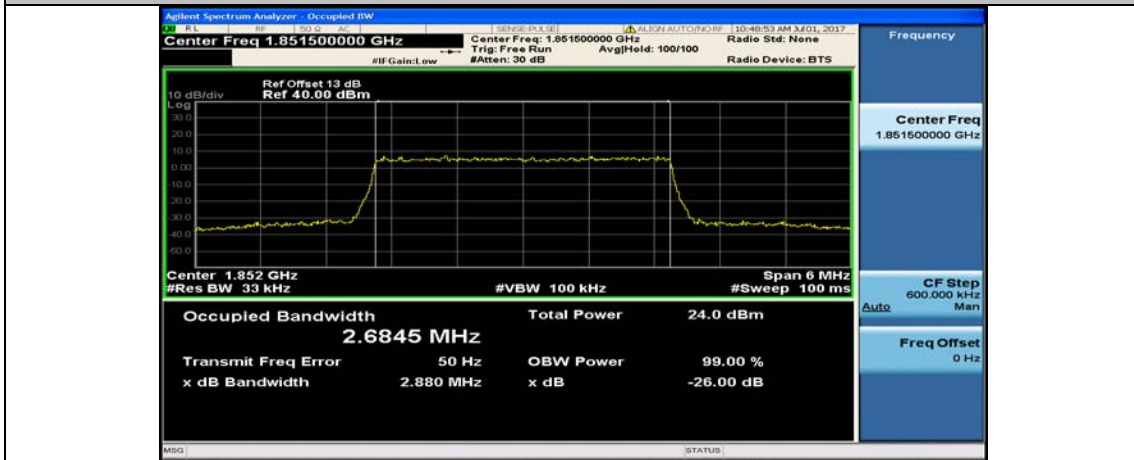

Band2\_3MHz\_QPSK\_18900\_15RB#0

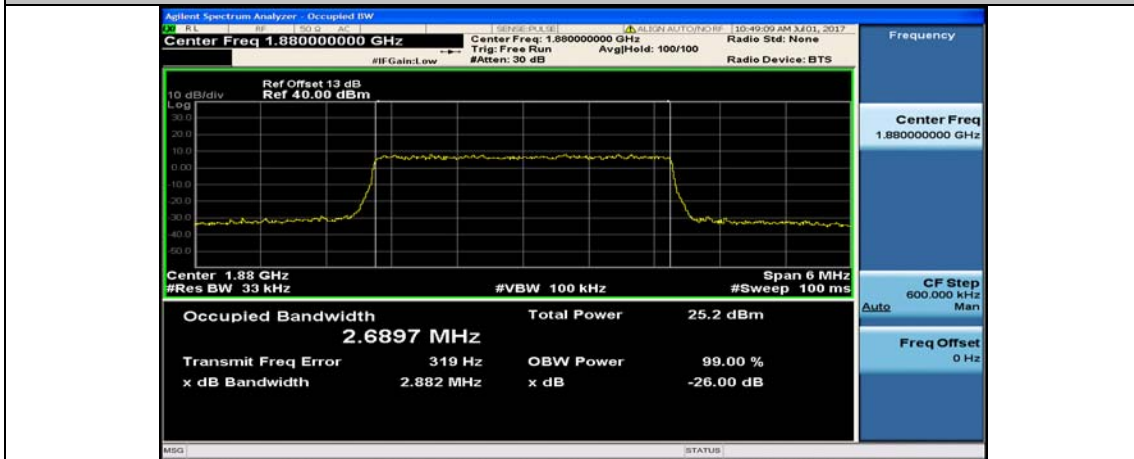

Band2\_3MHz\_16QAM\_18900\_15RB#0

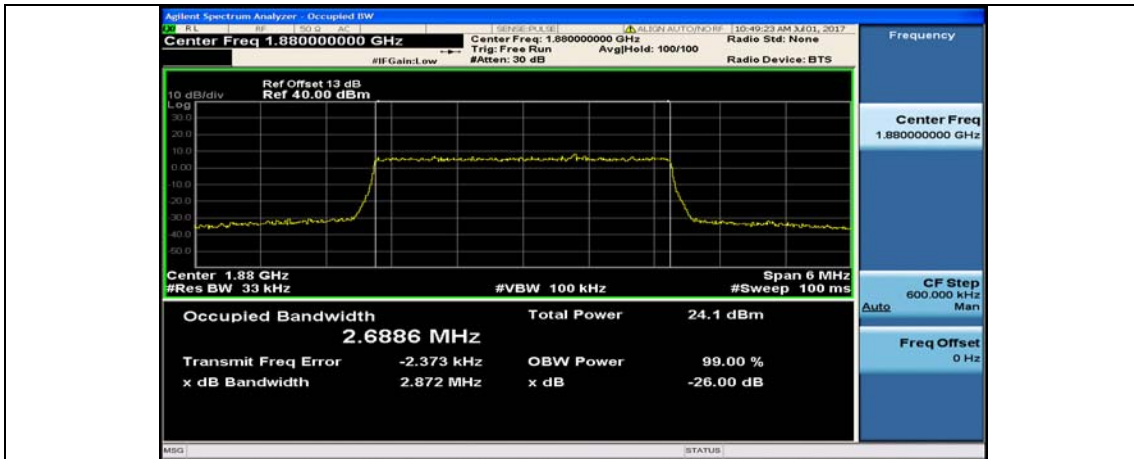

Band2\_3MHz\_QPSK\_19185\_15RB#0

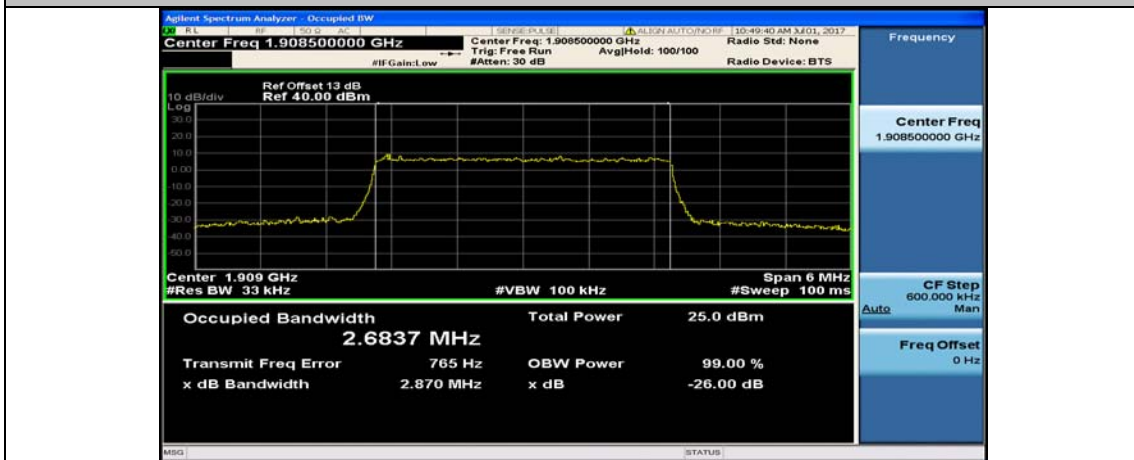

Band2\_3MHz\_16QAM\_19185\_15RB#0

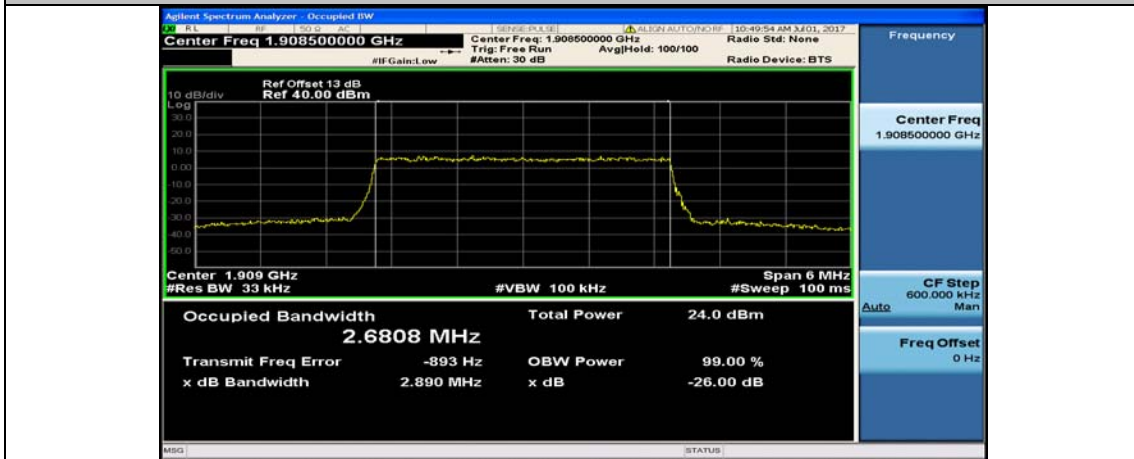

Band2\_5MHz\_QPSK\_18625\_25RB#0

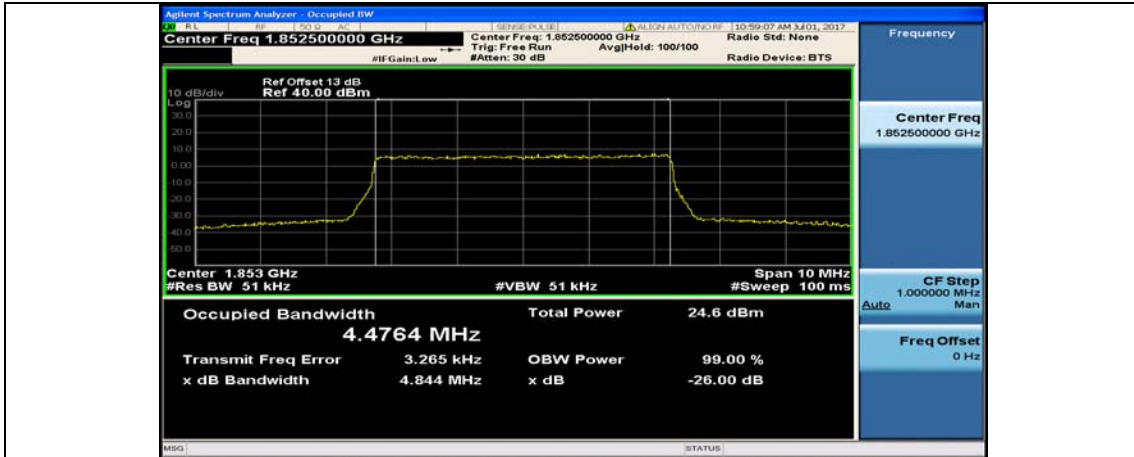

Band2\_5MHz\_16QAM\_18625\_25RB#0

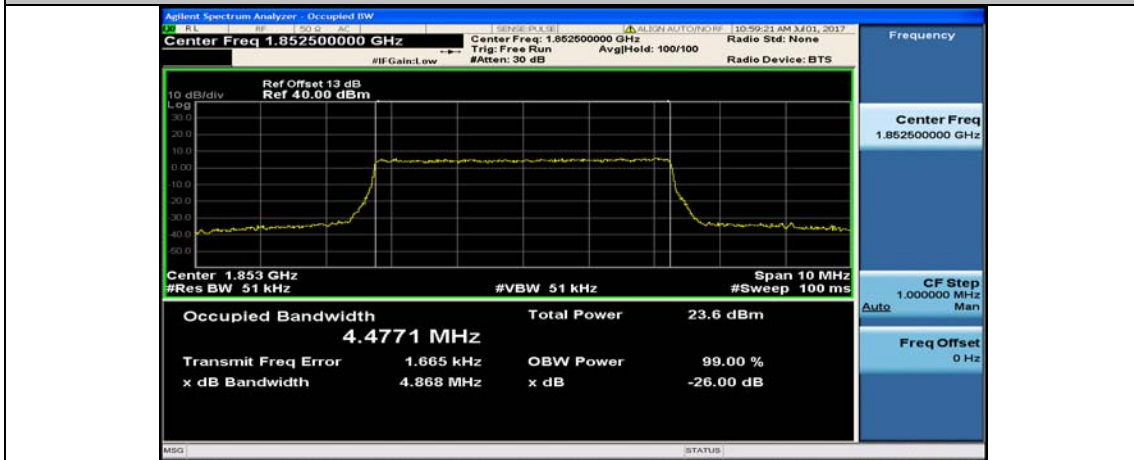

Band2\_5MHz\_QPSK\_18900\_25RB#0

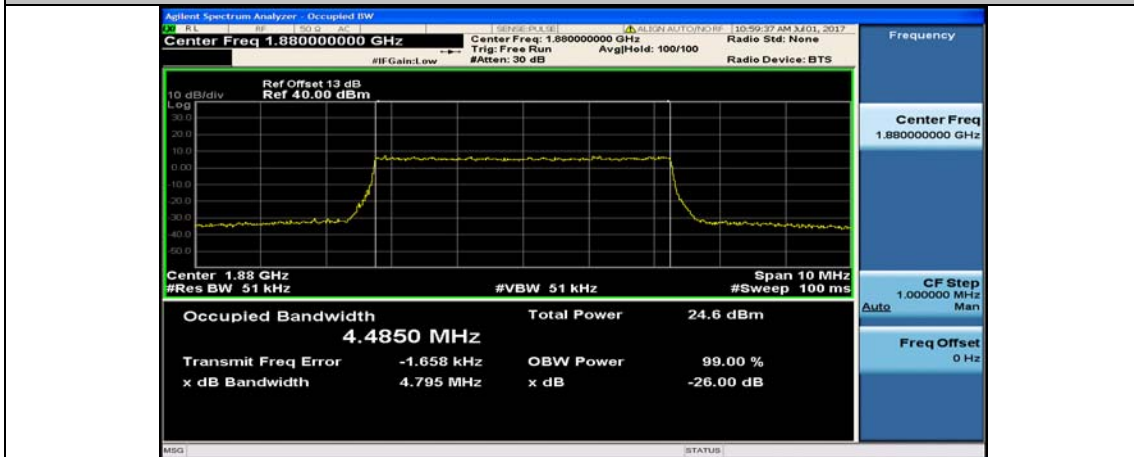

Band2\_5MHz\_16QAM\_18900\_25RB#0

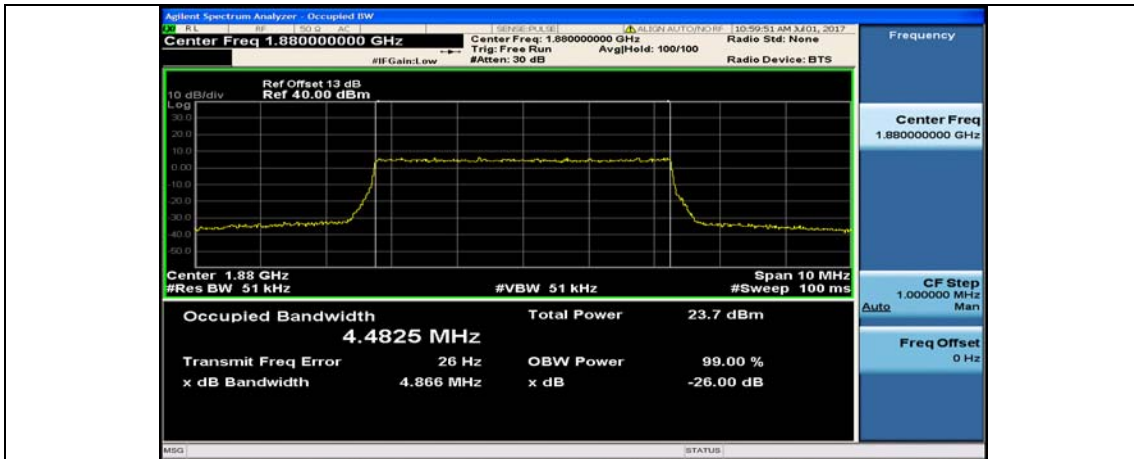

Band2\_5MHz\_QPSK\_19175\_25RB#0

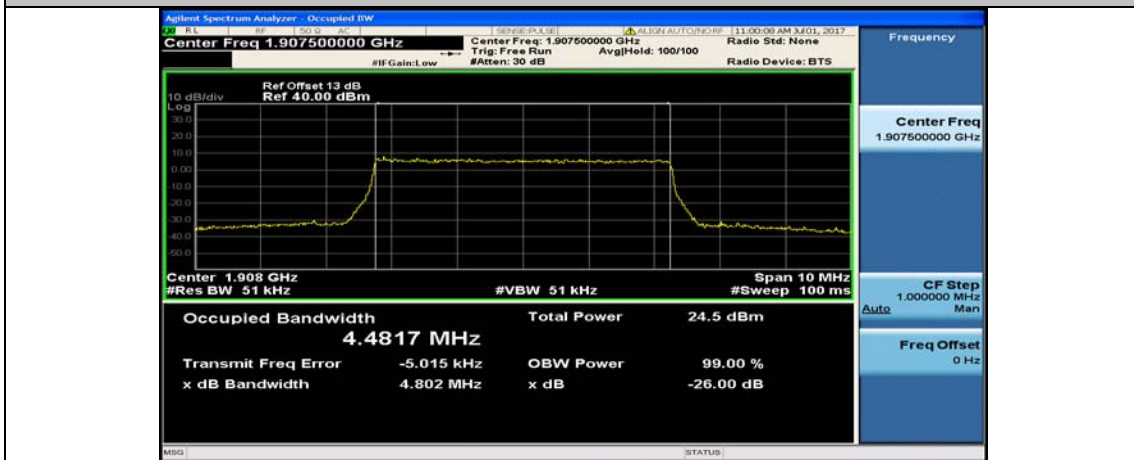

Band2\_5MHz\_16QAM\_19175\_25RB#0

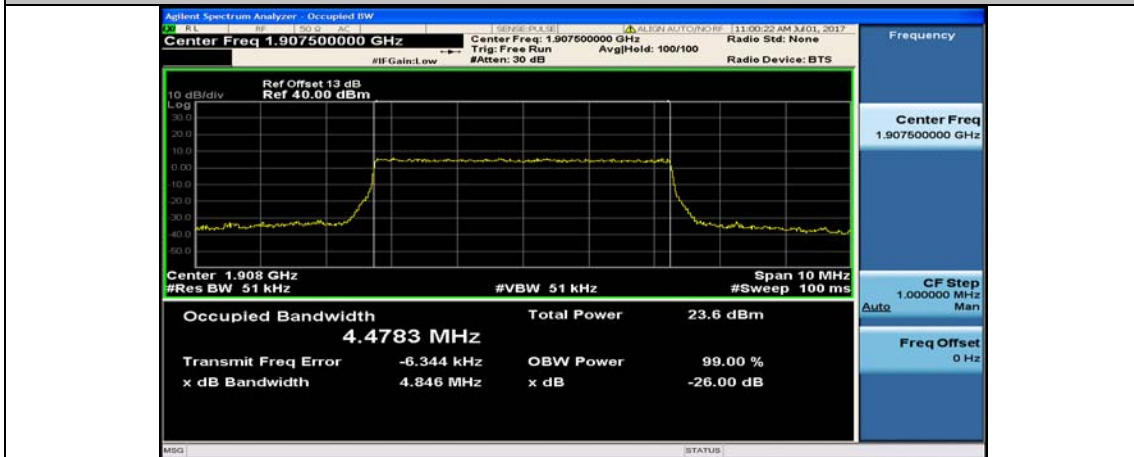

Band2\_10MHz\_QPSK\_18650\_50RB#0

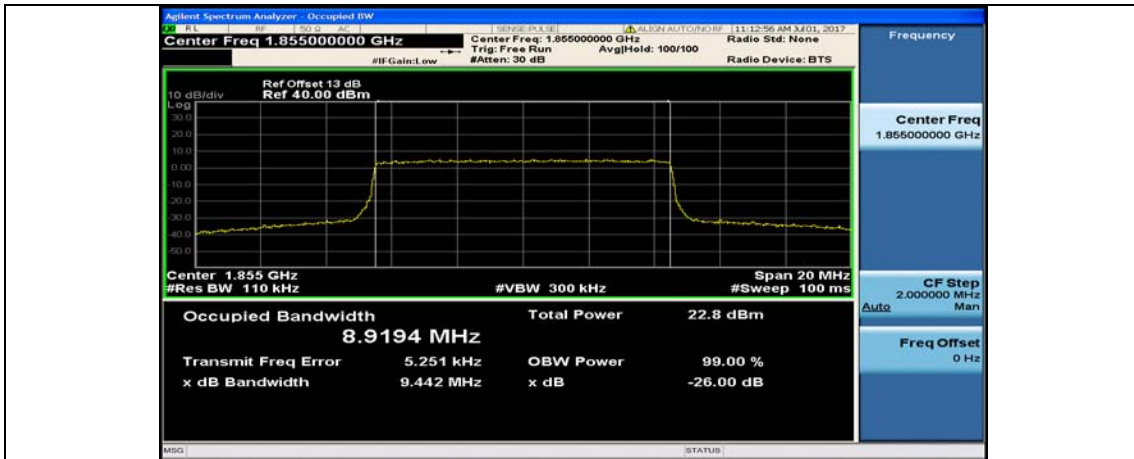

Band2\_10MHz\_16QAM\_18650\_50RB#0

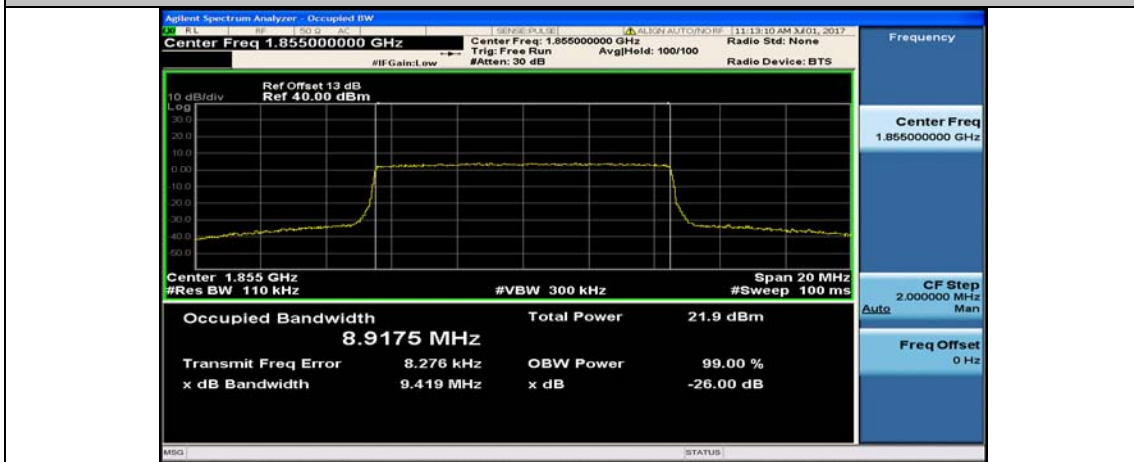

Band2\_10MHz\_QPSK\_18900\_50RB#0

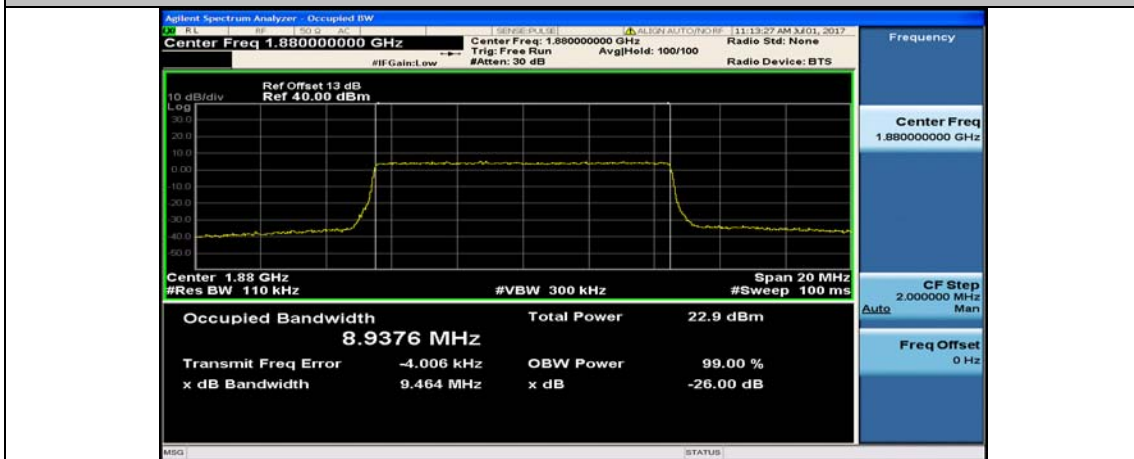

Band2\_10MHz\_16QAM\_18900\_50RB#0

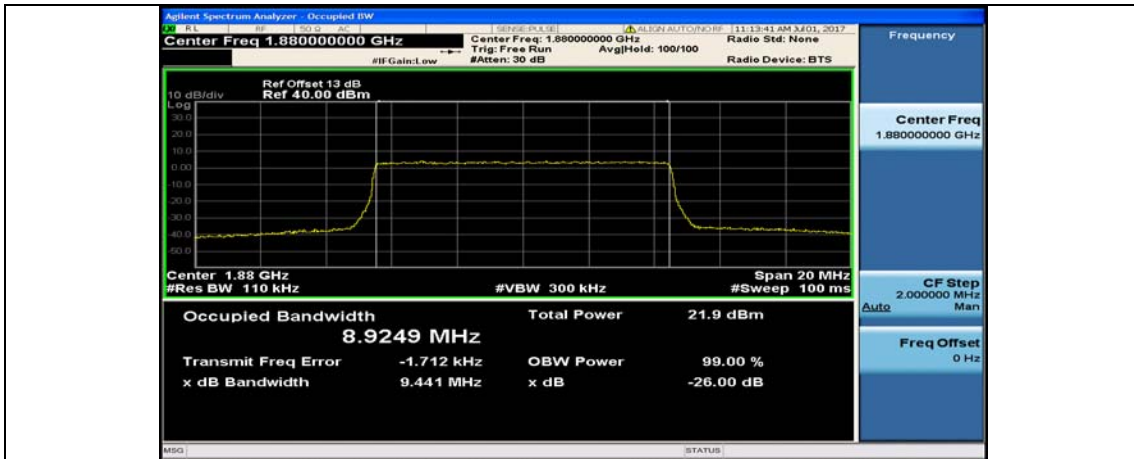

Band2\_10MHz\_QPSK\_19150\_50RB#0

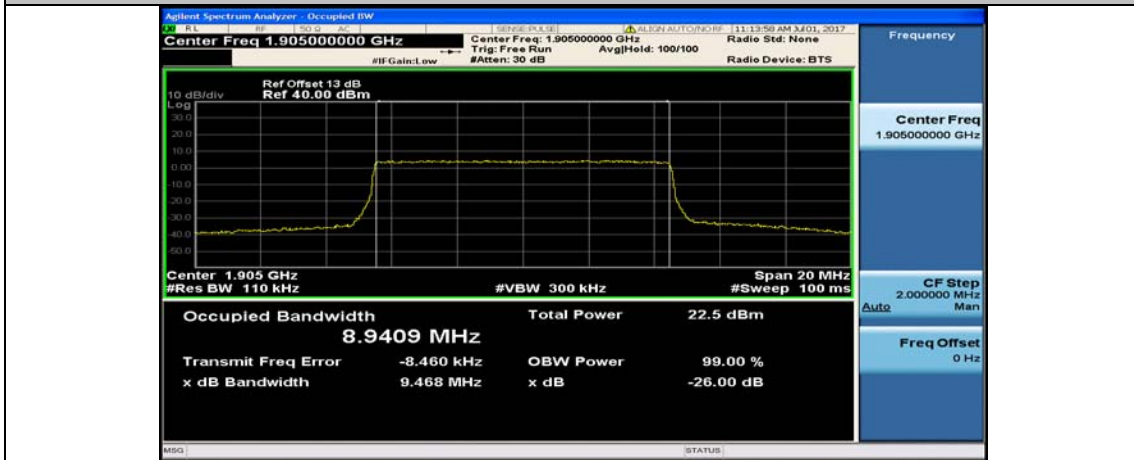

Band2\_10MHz\_16QAM\_19150\_50RB#0

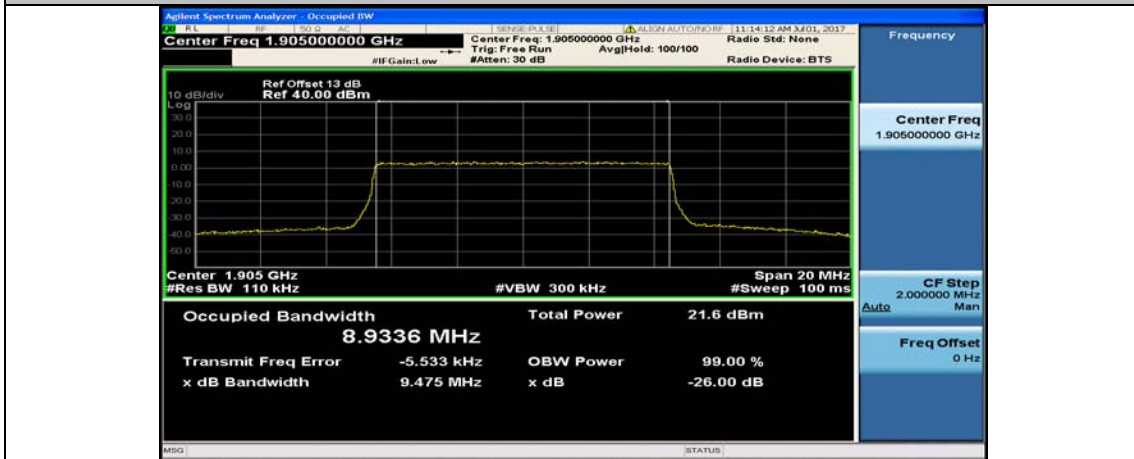

Band2\_15MHz\_QPSK\_18675\_75RB#0