

RF TEST REPORT



Report No.: 15070965-FCC-R1

Supersede Report No.: N/A

Applicant	AZUMI S.A	
Product Name	Mobile phone	
Model No.	L3GA Lite	
Serial No.	N/A	
Test Standard	FCC Part 22(H), FCC Part 24(E); ANSI/TIAC603 D: 2010	
Test Date	October 22 to December 19, 2015	
Issue Date	December 19, 2015	
Test Result	<input checked="" type="checkbox"/> Pass <input type="checkbox"/> Fail	
Equipment complied with the specification	<input checked="" type="checkbox"/>	
Equipment did not comply with the specification	<input type="checkbox"/>	
<i>Winnie Zhang</i>	<i>David Huang</i>	
Winnie Zhang Test Engineer	David Huang Checked By	
This test report may be reproduced in full only Test result presented in this test report is applicable to the tested sample only		

Issued by:

SIEMIC (SHENZHEN-CHINA) LABORATORIES

Zone A, Floor 1, Building 2 Wan Ye Long Technology Park

South Side of Zhoushi Road, Bao' an District, Shenzhen, Guangdong China 518108

Phone: +86 0755 2601 4629801 Email: China@siemic.com.cn

Laboratories Introduction

SIEMIC, headquartered in the heart of Silicon Valley, with superior facilities in US and Asia, is one of the leading independent testing and certification facilities providing customers with one-stop shop services for Compliance Testing and Global Certifications.



In addition to testing and certification, SIEMIC provides initial design reviews and compliance management throughout a project. Our extensive experience with China, Asia Pacific, North America, European, and International compliance requirements, assures the fastest, most cost effective way to attain regulatory compliance for the global markets.

Accreditations for Conformity Assessment

Country/Region	Scope
USA	EMC, RF/Wireless, SAR, Telecom
Canada	EMC, RF/Wireless, SAR, Telecom
Taiwan	EMC, RF, Telecom, SAR, Safety
Hong Kong	RF/Wireless, SAR, Telecom
Australia	EMC, RF, Telecom, SAR, Safety
Korea	EMI, EMS, RF, SAR, Telecom, Safety
Japan	EMI, RF/Wireless, SAR, Telecom
Singapore	EMC, RF, SAR, Telecom
Europe	EMC, RF, SAR, Telecom, Safety

Test Report	15070965-FCC-R1
Page	3 of 52

This page has been left blank intentionally.

CONTENTS

1. REPORT REVISION HISTORY	5
2. CUSTOMER INFORMATION	5
3. TEST SITE INFORMATION.....	5
4. EQUIPMENT UNDER TEST (EUT) INFORMATION.....	6
5. TEST SUMMARY	8
6. MEASUREMENTS, EXAMINATION AND DERIVED RESULTS	9
6.1 RF EXPOSURE (SAR).....	9
6.2 RF OUTPUT POWER.....	10
6.3 PEAK-AVERAGE RATIO.....	17
6.4 MODULATION CHARACTERISTIC.....	19
6.5 OCCUPIED BANDWIDTH.....	20
6.6 SPURIOUS EMISSIONS AT ANTENNA TERMINALS	24
6.7 SPURIOUS RADIATED EMISSIONS.....	29
6.8 BAND EDGE.....	34
6.9 FREQUENCY STABILITY	38
ANNEX A. TEST INSTRUMENT.....	42
ANNEX B. EUT AND TEST SETUP PHOTOGRAPHS.....	43
ANNEX C. TEST SETUP AND SUPPORTING EQUIPMENT.....	48
ANNEX C.II. EUT OPERATING CONKITIONS.....	50
ANNEX D. USER MANUAL / BLOCK DIAGRAM / SCHEMATICS / PARTLIST.....	51
ANNEX E. DECLARATION OF SIMILARITY.....	52

1. Report Revision History

Report No.	Report Version	Description	Issue Date
15070965-FCC-R1	NONE	Original	December 8,2015
15070965-FCC-R1	V1	Change EUT Photos and data	December 19, 2015

2. Customer information

Applicant Name	AZUMI S.A
Applicant Add	Avenida Aquilino de la Guardia con Calle 47, PH Ocean Plaza, Piso 16 of. 16-01, Marbella, Ciudad de Panamá City, Rep. Panamá
Manufacturer	Shenzhen Haierhea Telecom Co.,Ltd.
Manufacturer Add	Room 418,Block M-3,Middle of Hi-Tech Park,Nanshan,Shenzhen,China 518057

3. Test site information

Lab performing tests	SIEMIC (Shenzhen-China) LABORATORIES
Lab Address	Zone A, Floor 1, Building 2 Wan Ye Long Technology Park South Side of Zhoushi Road, Bao' an District, Shenzhen, Guangdong China 518108
FCC Test Site No.	718246
IC Test Site No.	4842E-1
Test Software	Radiated Emission Program-To Shenzhen v2.0

4. Equipment under Test (EUT) Information

Description of EUT:	Mobile phone
Main Model:	L3GA Lite
Serial Model:	N/A
Date EUT received:	October 21, 2015
Test Date(s):	October 22 to December 19, 2015
Equipment Category :	PCE
Antenna Gain:	GSM850: -3dBi PCS1900: -3 dBi UMTS-FDD Band V: -3 dBi UMTS-FDD Band II: -3 dBi Bluetooth: -1 dBi GPS:-1 dBi
Type of Modulation:	GSM / GPRS: GMSK UMTS-FDD: QPSK, 16QAM Bluetooth: GFSK, π /4DQPSK, 8DPSK GPS:BPSK
RF Operating Frequency (ies):	GSM850 TX: 824.2 ~ 848.8 MHz; RX: 869.2 ~ 893.8 MHz PCS1900 TX: 1850.2 ~ 1909.8 MHz; RX: 1930.2 ~ 1989.8 MHz UMTS-FDD Band V TX: 826.4 ~ 846.6 MHz; RX: 871.4 ~ 891.6 MHz UMTS-FDD Band II TX:1852.4 ~ 1907.6 MHz; RX: 1932.4 ~ 1987.6 MHz Bluetooth: 2402-2480 MHz GPS RX:1575.42 MHz
Maximum Conducted AV Power to Antenna:	GSM850: 31.98 dBm PCS1900: 30.73 dBm UMTS-FDD Band V : 22.72 dBm UMTS-FDD Band II : 23.09 dBm

ERP/EIRP: GSM850: 26.59 dBm / ERP
PCS1900: 28.48 dBm / EIRP
UMTS-FDD Band V : 17.86 dBm / ERP
UMTS-FDD Band II : 20.46 dBm / EIRP

Number of Channels: GSM 850: 124CH
PCS1900: 299CH
UMTS-FDD Band V : 102CH
UMTS-FDD Band II : 277CH
Bluetooth: 79CH
GPS:1CH

Port: Power Port, Earphone Port, USB Port

Input Power: Adapter:
Model: L3GA Lite
Input: AC 100-240V; 50/60Hz;0.2A
Output: DC 5.0V,500mA
Battery:
Model: L3GA Lite
Spec:3.7V,600mAh,2.22Wh

Trade Name : AZUMI

GPRS Multi-slot class 8/10/12

FCC ID: QRP-AZUMIL3GALITE

5. Test Summary

The product was tested in accordance with the following specifications.

All testing has been performed according to below product classification:

FCC Rules	Description of Test	Result
§ 1.1307; § 2.1093	RF Exposure (SAR)	Compliance
§2.1046; § 22.913(a); § 24.232(c);	RF Output Power	Compliance
§ 24.232 (d) ;	Peak-Average Ratio	Compliance
§ 2.1047	Modulation Characteristics	Compliance
§ 2.1049; § 22.905; § 22.917; § 24.238;	99% & -26 dB Occupied Bandwidth	Compliance
§ 2.1051; § 22.917(a); § 24.238(a);	Spurious Emissions at Antenna Terminal	Compliance
§ 2.1053; § 22.917(a); § 24.238(a);	Field Strength of Spurious Radiation	Compliance
§ 22.917(a); § 24.238(a);	Out of band emission, Band Edge	Compliance
§ 2.1055; § 22.355; § 24.235;	Frequency stability vs. temperature Frequency stability vs. voltage	Compliance

Note: Testing was performed by configuring EUT to maximum output power status, the declared output power class for different

Measurement Uncertainty

Emissions		
Test Item	Description	Uncertainty
Band Edge and Radiated Spurious Emissions	Confidence level of approximately 95% (in the case where distributions are normal), with a coverage factor of 2 (for EUTs < 0.5m X 0.5m X 0.5m)	+5.6dB/-4.5dB
-	-	-

6. MEASUREMENTS, EXAMINATION AND DERIVED RESULTS

6.1 RF Exposure (SAR)

Test Result: Pass

The EUT is a portable device, thus requires SAR evaluation;

Please refer to RF Exposure Evaluation Report: 15070965-FCC-H.

6.2 RF Output Power

Temperature	28°C
Relative Humidity	52%
Atmospheric Pressure	1028mbar
Test date :	November 28, 2015& December 19, 2015
Tested By :	Winnie Zhang

Requirement(s):

Spec	Item	Requirement	Applicable
§22.913 (a)	a)	ERP:38.45dBm	<input checked="" type="checkbox"/>
§24.232 (c)	b)	EIRP:33dBm	<input checked="" type="checkbox"/>

Test Setup

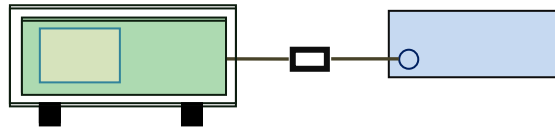

Test Procedure

For Conducted Power:

- The transmitter output port was connected to base station.
- Set EUT at maximum power through base station.
- Select lowest, middle, and highest channels for each band and different test mode.

For ERP/EIRP:

- The transmitter was placed on a wooden turntable, and it was transmitting into a non-radiating load which was also placed on the turntable.
- The measurement antenna was placed at a distance of 3 meters from the EUT. During the tests, the antenna height and polarization as well as EUT azimuth were varied in order to identify the maximum level of emissions from the EUT. The test was performed by placing the EUT on 3-orthogonal axis.
- The frequency range up to tenth harmonic of the fundamental frequency was investigated.
- Remove the EUT and replace it with substitution antenna. A signal generator was connected to the substitution antenna by a non-

Test Report	15070965-FCC-R1
Page	11 of 52

	<p>radiating cable. The absolute levels of the spurious emissions were measured by the substitution.</p> <ul style="list-style-type: none"> - Spurious emissions in dB = 10 log (TX power in Watts/0.001) – the absolute level - Spurious attenuation limit in dB = 43 + 10 Log10 (power out in Watts).
Remark	
Result	<input checked="" type="checkbox"/> Pass <input type="checkbox"/> Fail

Test Data Yes N/A

Test Plot Yes (See below) N/A

Conducted Power

GSM Mode:

Burst Average Power (dBm);								
Band	GSM850				PCS1900			
Channel	128	190	251	Tune up Power tolerant	512	661	810	Tune up Power tolerant
Frequency (MHz)	824.2	836.6	848.8	/	1850.2	1880	1909.8	/
GSM Voice (1 uplink),GMSK	31.98	31.97	31.93	31±1	30.73	30.42	30.25	30±1
GPRS Multi-Slot Class 8 (1 uplink),GMSK	31.96	31.95	31.92	31±1	30.24	30.41	30.71	30±1
GPRS Multi-Slot Class 10 (2 uplink) GMSK	31.51	31.48	31.44	31±1	29.62	29.78	30.02	30±1
GPRS Multi-Slot Class 12 (4 uplink) GMSK	28.91	28.95	28.93	28±1	26.76	26.89	27.11	28±1

Remark :

GPRS, CS1 coding scheme.

Multi-Slot Class 8 , Support Max 4 downlink, 1 uplink , 5 working link

Multi-Slot Class 10 , Support Max 4 downlink, 2 uplink , 5 working link

Multi-Slot Class 12 , Support Max 4 downlink, 4 uplink , 5 working link

Note: Since GSM mode has higher power, so the test items below were not performed to GPRS mode.

UMTS Mode:

UMTS-FDD Band V

Band/ Time Slot configuration	Channel	Frequency	Average power (dBm)	Tune up Power tolerant
RMC 12.2kbps	4132	826.4	22.46	22±1
	4175	835	22.72	22±1
	4233	846.6	22.27	22±1
HSDPA Subtest1	4132	826.4	21.34	21.3±1
	4175	835	21.51	21.3±1
	4233	846.6	21.31	21.3±1
HSDPA Subtest2	4132	826.4	21.29	21.3±1
	4175	835	21.38	21.3±1
	4233	846.6	21.25	21.3±1
HSDPA Subtest3	4132	826.4	21.16	21.3±1
	4175	835	21.22	21.3±1
	4233	846.6	21.11	21.3±1
HSDPA Subtest4	4132	826.4	21.34	21.3±1
	4175	835	21.47	21.3±1
	4233	846.6	21.28	21.3±1
HSUPA Subtest1	4132	826.4	20.88	21.3±1
	4175	835	21.08	21.3±1
	4233	846.6	20.79	21.3±1
HSUPA Subtest2	4132	826.4	21.36	21.3±1
	4175	835	21.45	21.3±1
	4233	846.6	21.31	21.3±1
HSUPA Subtest3	4132	826.4	20.96	21.3±1
	4175	835	21.25	21.3±1
	4233	846.6	20.89	21.3±1
HSUPA Subtest4	4132	826.4	21.25	21.3±1
	4175	835	21.39	21.3±1
	4233	846.6	21.22	21.3±1
HSUPA Subtest5	4132	826.4	21.32	21.3±1
	4175	835	21.47	21.3±1
	4233	846.6	21.26	21.3±1

UMTS-FDD Band II

Band/ Time Slot configuration	Channel	Frequency	Average power (dBm)	Tune up Power tolerant
RMC 12.2kbps	9262	1852.4	22.91	23±1
	9400	1880	23.09	23±1
	9538	1907.6	22.87	23±1
HSDPA Subtest1	9262	1852.4	21.34	21.3±1
	9400	1880	21.42	21.3±1
	9538	1907.6	21.31	21.3±1
HSDPA Subtest2	9262	1852.4	21.36	21.3±1
	9400	1880	21.39	21.3±1
	9538	1907.6	21.31	21.3±1
HSDPA Subtest3	9262	1852.4	21.32	21.3±1
	9400	1880	21.38	21.3±1
	9538	1907.6	21.31	21.3±1
HSDPA Subtest4	9262	1852.4	21.29	21.3±1
	9400	1880	21.25	21.3±1
	9538	1907.6	21.26	21.3±1
HSUPA Subtest1	9262	1852.4	20.86	21.3±1
	9400	1880	20.95	21.3±1
	9538	1907.6	20.84	21.3±1
HSUPA Subtest2	9262	1852.4	20.96	21.3±1
	9400	1880	20.99	21.3±1
	9538	1907.6	20.93	21.3±1
HSUPA Subtest3	9262	1852.4	20.35	21.3±1
	9400	1880	20.46	21.3±1
	9538	1907.6	20.62	21.3±1
HSUPA Subtest4	9262	1852.4	20.58	21.3±1
	9400	1880	20.41	21.3±1
	9538	1907.6	20.55	21.3±1
HSUPA Subtest5	9262	1852.4	20.78	21.3±1
	9400	1880	20.85	21.3±1
	9538	1907.6	20.74	21.3±1

ERP & EIRP

ERP for Cellular Band (Part 22H)

Frequency (MHz)	Substituted level (dBm)	Antenna Polarization	Antenna Gain correction (dBi)	Cable Loss (dB)	Absolute Level (dBm)	Limit (dBm)
824.2	20.17	V	6.8	0.53	26.44	38.45
824.2	19.44	H	6.8	0.53	25.71	38.45
836.6	20.23	V	6.8	0.53	26.5	38.45
836.6	19.32	H	6.8	0.53	25.59	38.45
848.8	20.22	V	6.9	0.53	26.59	38.45
848.8	19.6	H	6.9	0.53	25.97	38.45

EIRP for PCS Band (Part 24E)

Frequency (MHz)	Substituted level (dBm)	Antenna Polarization	Antenna Gain correction (dBi)	Cable Loss (dB)	Absolute Level (dBm)	Limit (dBm)
1850.2	21.42	V	7.88	0.85	28.45	33
1850.2	20.66	H	7.88	0.85	27.69	33
1880	21.45	V	7.88	0.85	28.48	33
1880	20.78	H	7.88	0.85	27.81	33
1909.8	21.42	V	7.86	0.85	28.43	33
1909.8	20.66	H	7.86	0.85	27.67	33

ERP for UMTS-FDD Band V (Part 22H)

Frequency (MHz)	Substituted level (dBm)	Antenna Polarization	Antenna Gain correction (dBi)	Cable Loss (dB)	Absolute Level (dBm)	Limit (dBm)
826.4	11.56	V	6.8	0.53	17.83	38.45
826.4	10.79	H	6.8	0.53	17.06	38.45
835	11.59	V	6.8	0.53	17.86	38.45
835	10.79	H	6.8	0.53	17.06	38.45
846.6	11.42	V	6.9	0.53	17.79	38.45
846.6	10.89	H	6.9	0.53	17.26	38.45

EIRP for UMTS-FDD Band II (Part 24E)

Frequency (MHz)	Substituted level (dBm)	Antenna Polarization	Antenna Gain correction (dBi)	Cable Loss (dB)	Absolute Level (dBm)	Limit (dBm)
1852.4	13.17	V	7.88	0.85	20.2	33
1852.4	12.45	H	7.88	0.85	19.48	33
1880	13.35	V	7.88	0.85	20.38	33
1880	12.24	H	7.88	0.85	19.27	33
1907.6	13.45	V	7.86	0.85	20.46	33
1907.6	12.61	H	7.86	0.85	19.62	33

6.3 Peak-Average Ratio

Temperature	28°C
Relative Humidity	52%
Atmospheric Pressure	1028mbar
Test date :	November 28, 2015
Tested By :	Winnie Zhang

Requirement(s):

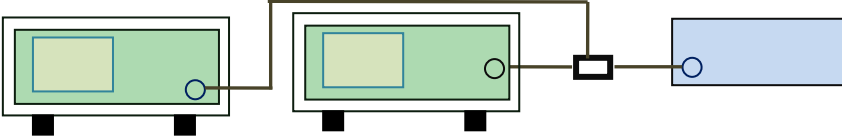
Spec	Item	Requirement	Applicable
§24.232(d)	a)	The peak-to-average ratio (PAR) of the transmission may not exceed 13 dB.	<input checked="" type="checkbox"/>
Test Setup			
Test Procedure	<p>According with KDB 971168</p> <ol style="list-style-type: none"> 1. The signal analyzer' s CCDF measurement profile is enabled 2. Frequency = carrier center frequency 3. Measurement BW > Emission bandwidth of signal 4. The signal analyzer was set to collect one million samples to generate the CCDF curve 5. The measurement interval was set depending on the type of signal analyzed. For continuous signals (>98% duty cycle), the measurement interval was set to 1ms. For burst transmissions, the spectrum analyzer is set to use an internal “ RF Burst” trigger that is synced with an incoming pulse and the measurement interval is set to less than the duration of the “ on time” of one burst to ensure that energy is only captured during a time in which the transmitter is operating at maximum power 		
Remark			
Result	<input checked="" type="checkbox"/> Pass <input type="checkbox"/> Fail		

Test Data Yes N/A
 Test Plot Yes (See below) N/A

GSM 1900 PK-AV POWER(PART 24E)

Frequency (MHz)	Conducted power(dBm)		Peak-Average Ratio(PAR)
	Peak	Average	
1850.2	30.87	30.25	0.62
1880	30.91	30.42	0.49
1909.8	31.02	30.73	0.29

UMTS-FDD Band II PK-AV POWER(PART 24E)

Frequency (MHz)	Conducted power(dBm)		Peak-Average Ratio(PAR)
	Peak	Average	
1852.4	25.97	22.91	3.06
1880	26.27	23.09	3.18
1907.6	25.83	22.87	2.96

6.4 Modulation Characteristic

According to FCC § 2.1047(d), Part 22H, 24E there is no specific requirement for digital modulation, therefore modulation characteristic is not presented.

According to FCC § 2.1033(c)(13) For equipment employing digital modulation techniques, a detailed description of the modulation system to be used, including the response characteristics (frequency, phase and amplitude) of any filters provided, and a description of the modulating wavetrain, shall be submitted for the maximum rated conditions under which the equipment will be operated.

Result: Pass.

Note: The mobile phone C240 meets the requirement of 3GPP standards

6.5 Occupied Bandwidth

Temperature	28°C
Relative Humidity	52%
Atmospheric Pressure	1028mbar
Test date :	November 28, 2015
Tested By :	Winnie Zhang

Requirement(s):

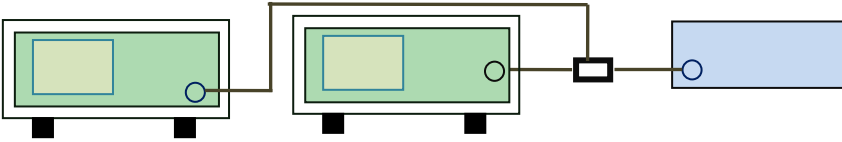
Spec	Item	Requirement	Applicable
§2.1049, §22.917, §22.905 §24.238	a)	99% Occupied Bandwidth(kHz)	<input checked="" type="checkbox"/>
	b)	26 dB Bandwidth(kHz)	<input checked="" type="checkbox"/>
Test Setup			
Test Procedure	<ul style="list-style-type: none"> - The EUT was connected to Spectrum Analyzer and Base Station via power divider. - The 99% and 26 dB occupied bandwidth (BW) of the middle channel for the highest RF powers. 		
Remark			
Result	<input checked="" type="checkbox"/> Pass <input type="checkbox"/> Fail		

Test Data Yes N/A

Test Plot Yes (See below) N/A

Cellular Band (Part 22H) result

Channel	Frequency (MHz)	99% Occupied Bandwidth (kHz)	26 dB Bandwidth (kHz)
128	824.2	247.7746	319.518
190	836.6	248.1770	320.915
251	848.8	250.0850	321.270

PCS Band (Part 24E) result

Channel	Frequency (MHz)	99% Occupied Bandwidth (kHz)	26 dB Bandwidth (kHz)
512	1850.2	248.7509	319.399
661	1880.0	249.6643	319.838
810	1909.8	247.1057	316.485

UMTS-FDD Band V (Part 22H)

Channel	Frequency (MHz)	99% Occupied Bandwidth (MHz)	26 dB Bandwidth (MHz)
4132	826.4	4.1455	4.663
4175	835.0	4.1714	4.688
4233	846.6	4.2230	4.877

UMTS-FDD Band II (Part 24E)

Channel	Frequency (MHz)	99% Occupied Bandwidth (MHz)	26 dB Bandwidth (MHz)
9262	1852.4	4.1684	4.700
9400	1880.0	4.1610	4.702
9538	1907.6	4.1804	4.717

Test Plots

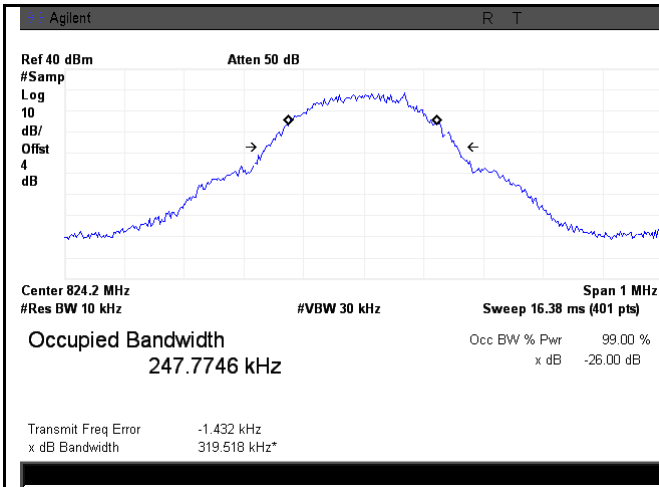

GSM 850 BW - Low CH 824.2MHz

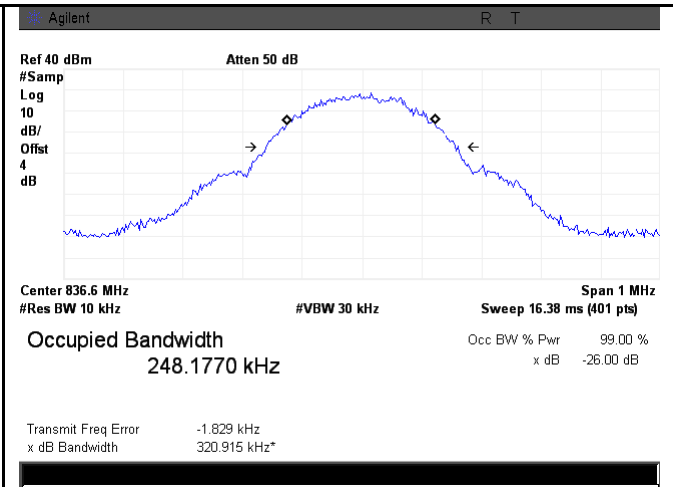

GSM 850 BW - Mid CH 836.6MHz

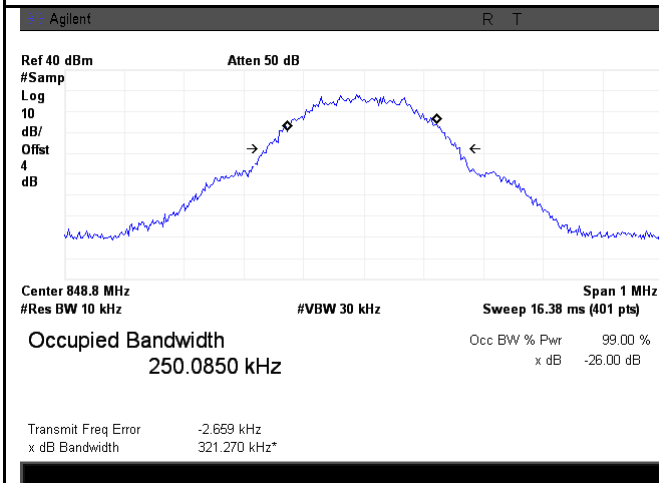

GSM 850 BW - High CH 848.8MHz

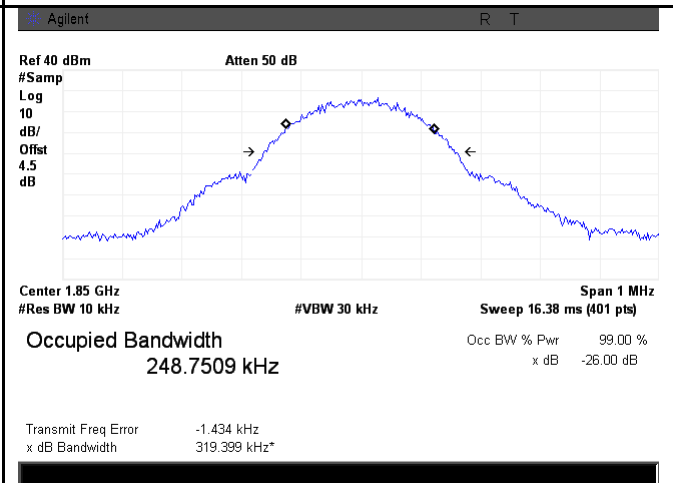

PCS 1900 BW - Low CH 1850.2MHz

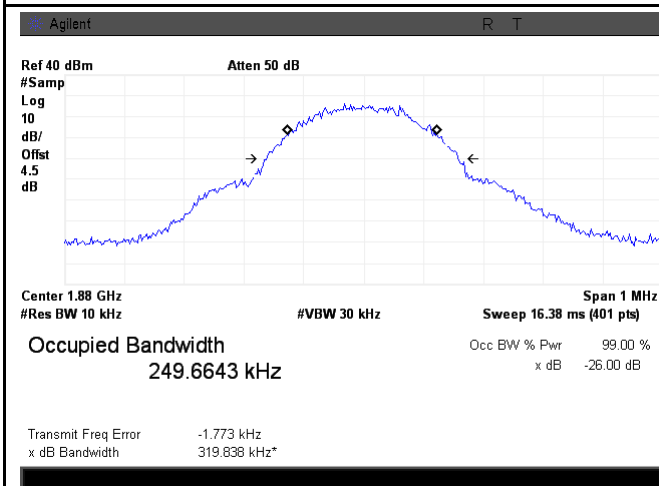

PCS 1900 BW - Mid CH 1880MHz

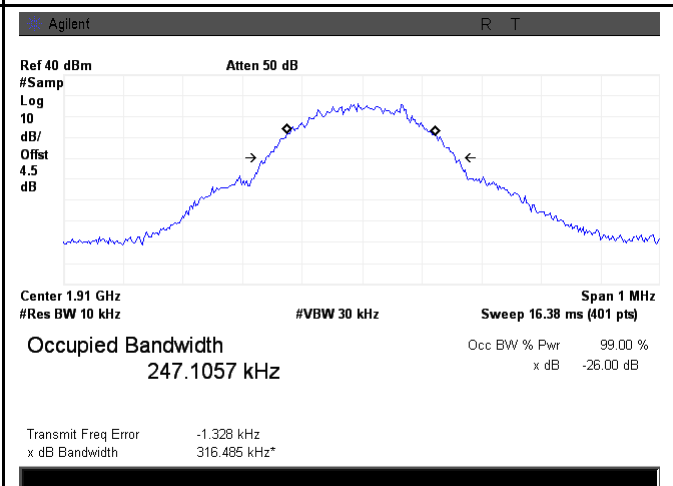

PCS 1900 BW - High CH 1909.8MHz

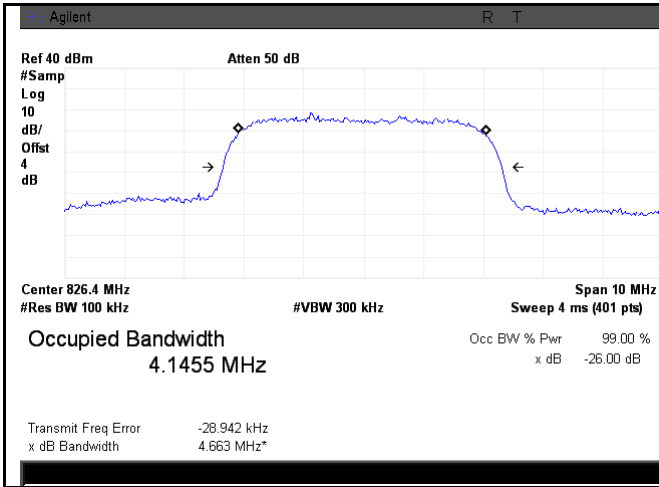

Band V BW - Low CH 826.6 MHz

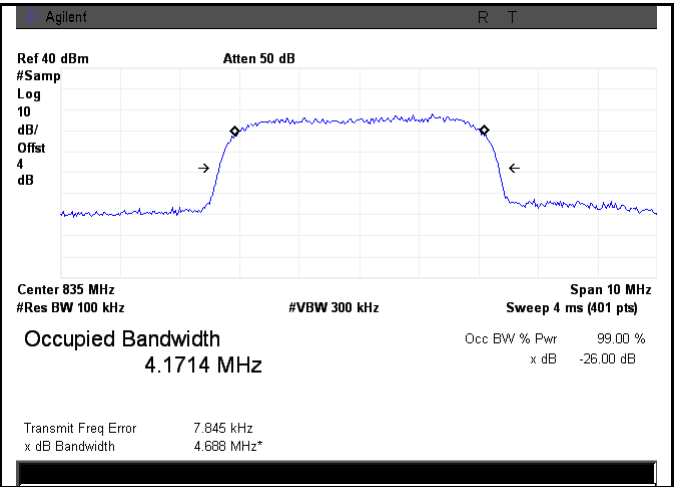

Band V BW - Mid CH 835.0 MHz

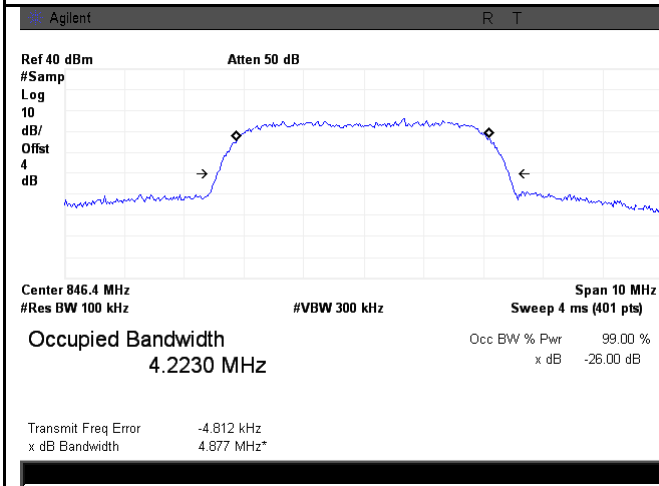

Band V BW - High CH 846.4 MHz

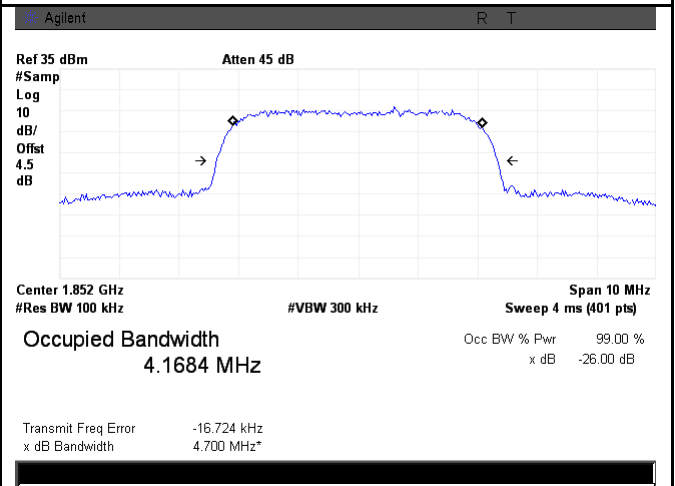

Band II BW - Low CH 1852.4MHz

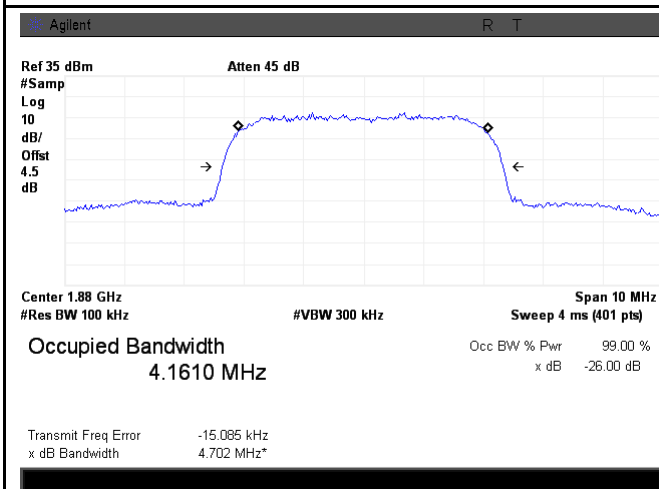

Band II BW - Mid CH 1880MHz

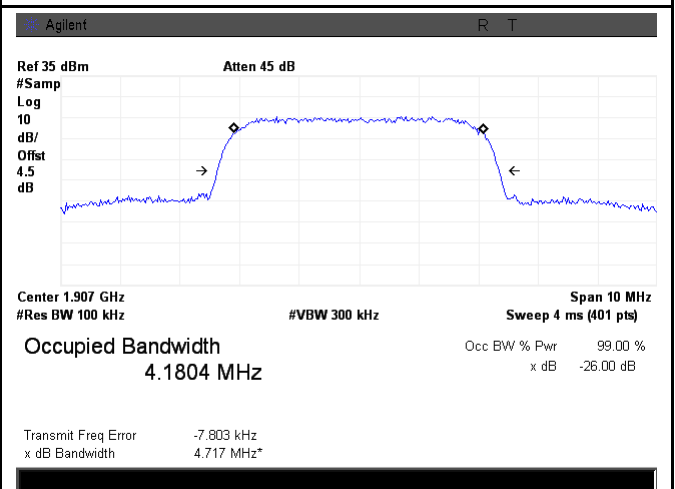

Band II BW - High CH 1907.6MHz

6.6 Spurious Emissions at Antenna Terminals

Temperature	28°C
Relative Humidity	52%
Atmospheric Pressure	1028mbar
Test date :	November 28, 2015
Tested By :	Winnie Zhang

Requirement(s):

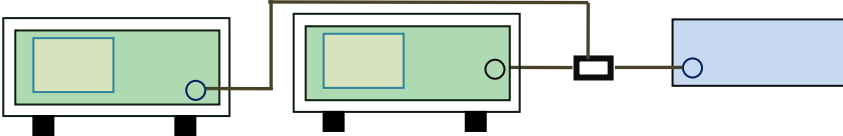
Spec	Item	Requirement	Applicable
§2.1051, §22.917(a)& §24.238(a)	a)	The power of any emission outside of the authorized operating frequency ranges must be lower than the transmitter power (P) by a factor of at least $43 + 10 \log (P)$ dB	<input checked="" type="checkbox"/>
Test Setup			
Test Procedure	<ul style="list-style-type: none"> - The EUT was connected to Spectrum Analyzer and Base Station via power divider. - The Band Edges of low and high channels for the highest RF powers were measured. - Setting RBW as roughly BW/100. 		
Remark			
Result	<input checked="" type="checkbox"/> Pass <input type="checkbox"/> Fail		

Test Data Yes N/A
 Test Plot Yes (See below) N/A

Test Plots

Cellular Band (Part 22H) result

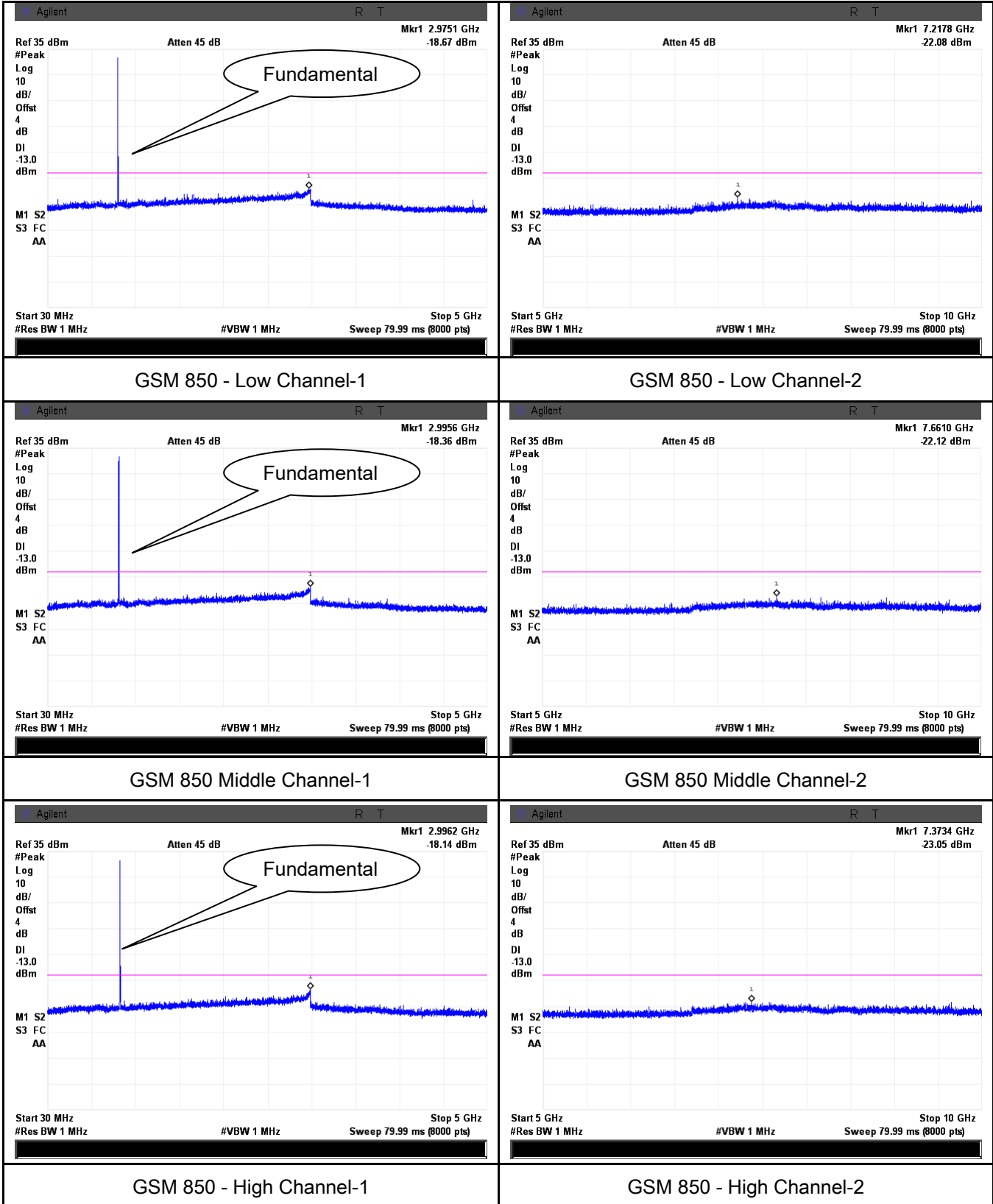

PCS Band (Part24E) result

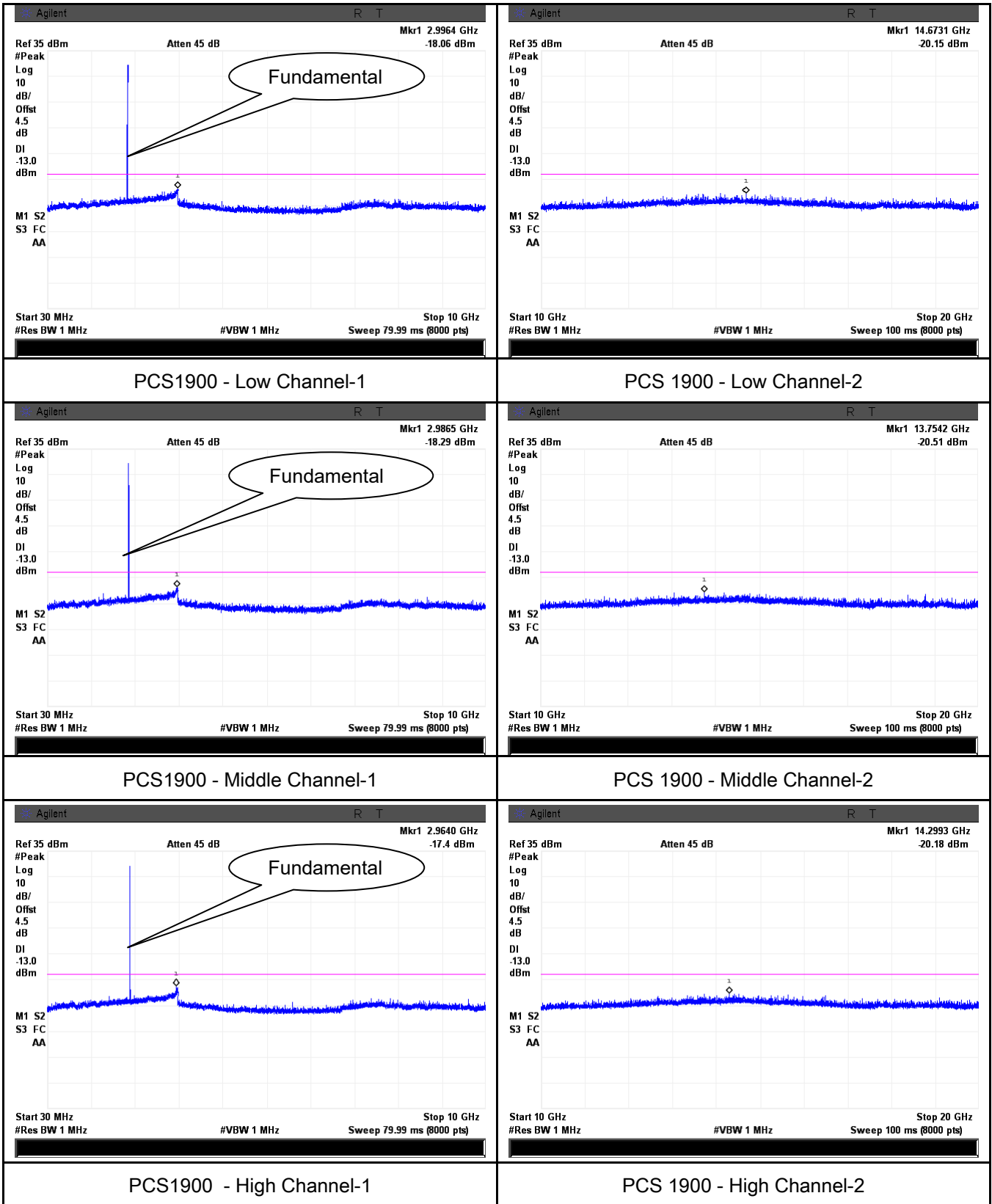

UMTS-FDD Band V (Part 22H)

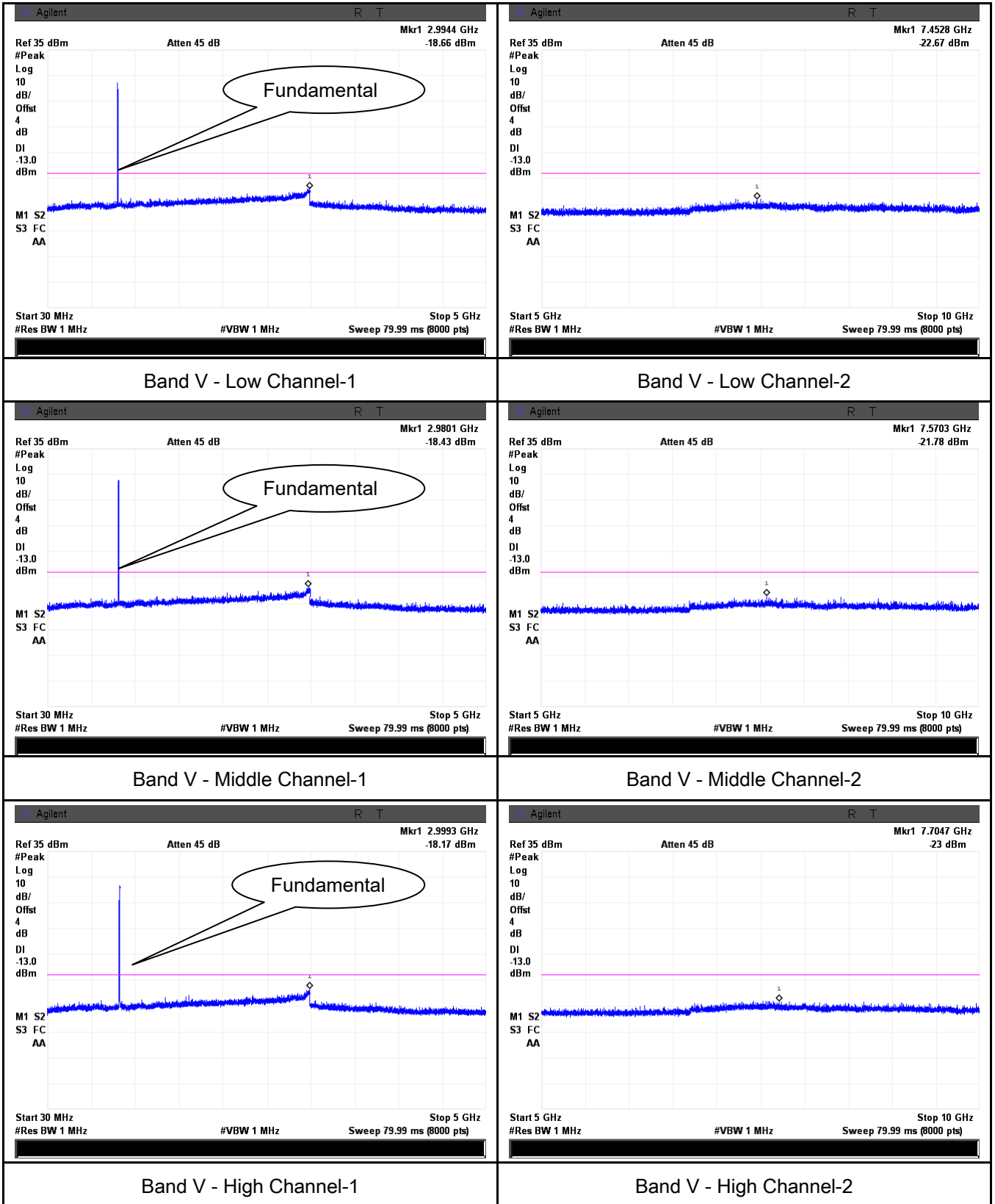

UMTS-FDD Band II (Part 24E)

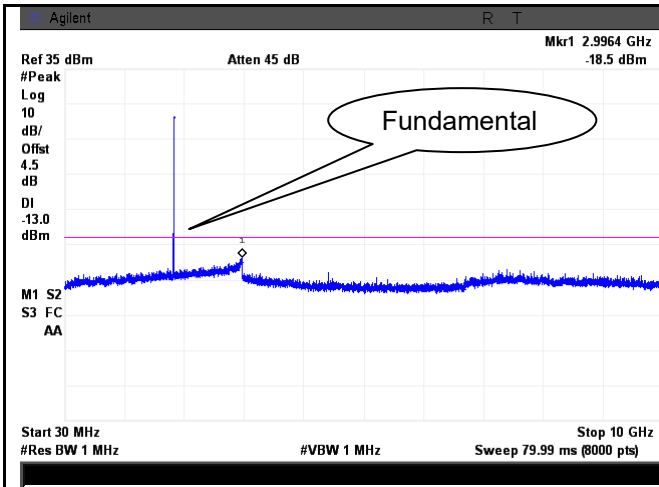

Band II - Low Channel-1

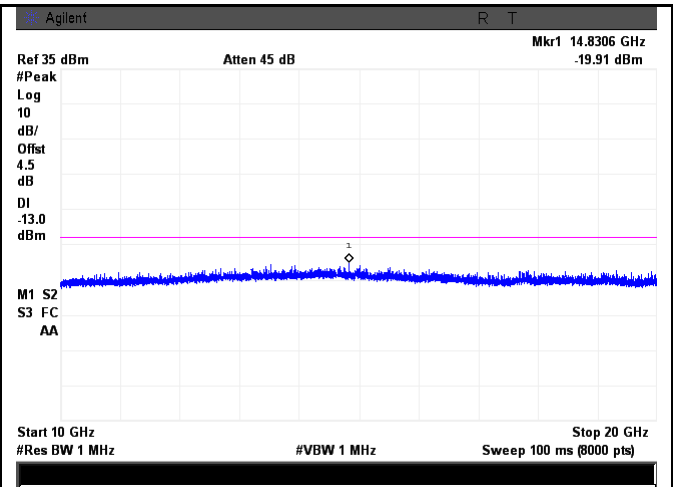

Band II - Low Channel-2

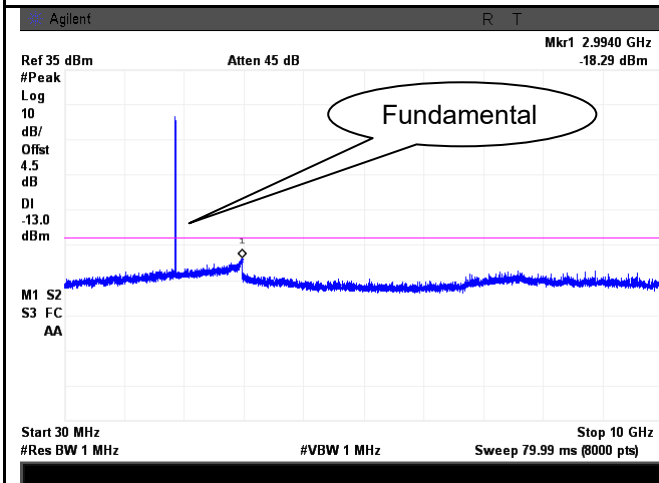

Band II - Middle Channel-1

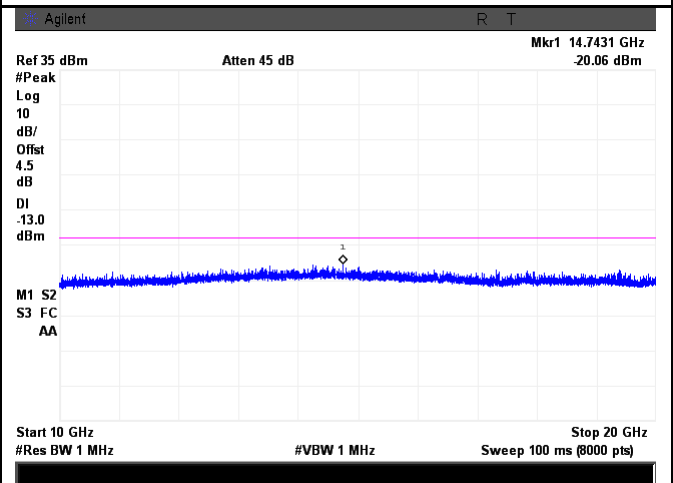

Band II - Middle Channel-2

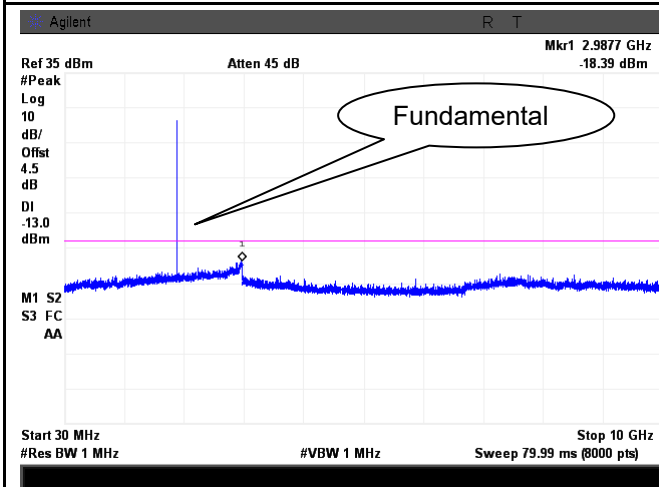

Band II - High Channel-1

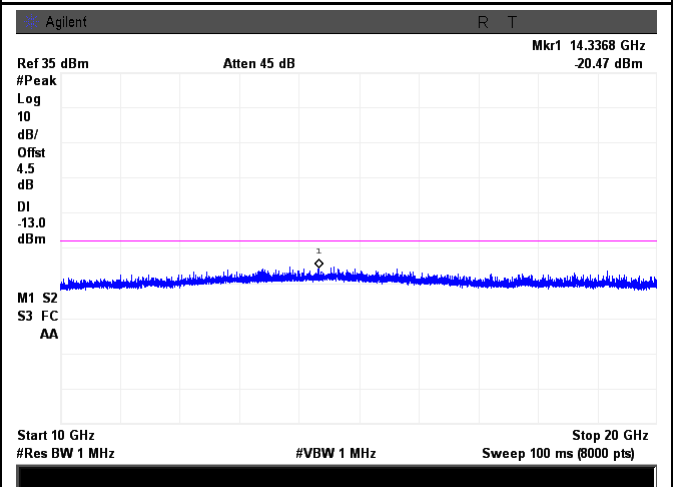

Band II - High Channel-2

6.7 Spurious Radiated Emissions

Temperature	28°C
Relative Humidity	52%
Atmospheric Pressure	1028mbar
Test date :	November 28, 2015& December 19,2015
Tested By :	Winnie Zhang

Requirement(s):

Spec	Item	Requirement	Applicable
§2.1053, §22.917 & §24.238	a)	The power of any emission outside of the authorized operating frequency ranges must be attenuated below the transmitter power (P) by a factor of at least $43 + 10 \log (P)$ dB. The spectrum is scanned from 30 MHz up to a frequency including its 10th harmonic.	<input checked="" type="checkbox"/>

Test setup	
------------	--

Test Procedure	<ol style="list-style-type: none"> The transmitter was placed on a wooden turntable, and it was transmitting into a non-radiating load which was also placed on the turntable. The measurement antenna was placed at a distance of 3 meters from the EUT. During the tests, the antenna height and polarization as well as EUT azimuth were varied in order to identify the maximum level of emissions from the EUT. The test was performed by placing the EUT on 3-orthogonal axis. Remove the EUT and replace it with substitution antenna. A signal generator was connected to the substitution antenna by a non-radiating cable. The absolute levels of the spurious emissions were measured by the substitution. <p>Sample Calculation:</p> <p>EUT Field Strength = Raw Amplitude (dBµV/m) – Amplifier Gain (dB) + Antenna Factor (dB) + Cable Loss (dB) + Filter Attenuation (dB, if used)</p>
----------------	---

Remark	
--------	--

Result	<input checked="" type="checkbox"/> Pass	<input type="checkbox"/> Fail
--------	--	-------------------------------

Test Data Yes N/A

Test Plot Yes (See below) N/A

Cellular Band (Part 22H) result

Low channel

Frequency (MHz)	Substituted level (dBm)	Polarity (H/V)	Antenna Gain Correction (dB)	Cable Loss (dB)	Corrected Reading (dBm)	Limit (dBm)	Margin (dB)
1648.4	-44.55	V	7.95	0.78	-37.38	-13	-24.38
1648.4	-45.31	H	7.95	0.78	-38.14	-13	-25.14
389.7	-50.21	V	6.5	0.3	-44.01	-13	-31.01
793.5	-51.18	H	6.9	0.44	-44.72	-13	-31.72

Middle channel

Frequency (MHz)	Substituted level (dBm)	Polarity (H/V)	Antenna Gain Correction (dB)	Cable Loss (dB)	Corrected Reading (dBm)	Limit (dBm)	Margin (dB)
1673.2	-44.54	V	7.95	0.78	-37.37	-13	-24.37
1673.2	-45.22	H	7.95	0.78	-38.05	-13	-25.05
389.1	-50.19	V	6.5	0.3	-43.99	-13	-30.99
793.6	-51.44	H	6.9	0.44	-44.98	-13	-31.98

High channel

Frequency (MHz)	Substituted level (dBm)	Polarity (H/V)	Antenna Gain Correction (dB)	Cable Loss (dB)	Corrected Reading (dBm)	Limit (dBm)	Margin (dB)
1697.6	-44.66	V	7.95	0.78	-37.49	-13	-24.49
1697.6	-45.55	H	7.95	0.78	-38.38	-13	-25.38
389.5	-50.22	V	6.5	0.3	-44.02	-13	-31.02
793.4	-51.19	H	6.9	0.44	-44.73	-13	-31.73

PCS Band (Part24E) result

Low channel

Frequency (MHz)	Substituted level (dBm)	Polarity (H/V)	Antenna Gain Correction (dB)	Cable Loss (dB)	Corrected Reading (dBm)	Limit (dBm)	Margin (dB)
3700.4	-47.33	V	10.25	2.73	-39.81	-13	-26.81
3700.4	-48.45	H	10.25	2.73	-40.93	-13	-27.93
388.5	-52.21	V	6.5	0.3	-46.01	-13	-33.01
792.8	-52.66	H	6.9	0.44	-46.2	-13	-33.2

Middle channel

Frequency (MHz)	Substituted level (dBm)	Polarity (H/V)	Antenna Gain Correction (dB)	Cable Loss (dB)	Corrected Reading (dBm)	Limit (dBm)	Margin (dB)
3760	-47.24	V	10.25	2.73	-39.72	-13	-26.72
3760	-48.45	H	10.25	2.73	-40.93	-13	-27.93
388.9	-52.19	V	6.5	0.3	-45.99	-13	-32.99
794.1	-52.33	H	6.9	0.44	-45.87	-13	-32.87

High channel

Frequency (MHz)	Substituted level (dBm)	Polarity (H/V)	Antenna Gain Correction (dB)	Cable Loss (dB)	Corrected Reading (dBm)	Limit (dBm)	Margin (dB)
3819.6	-47.22	V	10.36	2.73	-39.59	-13	-26.59
3819.6	-48.41	H	10.36	2.73	-40.78	-13	-27.78
388.4	-52.32	V	6.5	0.3	-46.12	-13	-33.12
794.3	-52.48	H	6.9	0.44	-46.02	-13	-33.02

UMTS-FDD Band V (Part 22H)

Low channel

Frequency (MHz)	Substituted level (dBm)	Polarity (H/V)	Antenna Gain Correction (dB)	Cable Loss (dB)	Corrected Reading (dBm)	Limit (dBm)	Margin (dB)
1652.8	-46.24	V	7.95	0.78	-39.07	-13	-26.07
1652.8	-46.56	H	7.95	0.78	-39.39	-13	-26.39
389.2	-51.44	V	6.5	0.3	-45.24	-13	-32.24
793.5	-51.66	H	6.9	0.44	-45.2	-13	-32.2

Middle channel

Frequency (MHz)	Substituted level (dBm)	Polarity (H/V)	Antenna Gain Correction (dB)	Cable Loss (dB)	Corrected Reading (dBm)	Limit (dBm)	Margin (dB)
1670	-46.45	V	7.95	0.78	-39.28	-13	-26.28
1670	-46.87	H	7.95	0.78	-39.7	-13	-26.7
389.6	-51.18	V	6.5	0.3	-44.98	-13	-31.98
793.1	-52.15	H	6.9	0.44	-45.69	-13	-32.69

High channel

Frequency (MHz)	Substituted level (dBm)	Polarity (H/V)	Antenna Gain Correction (dB)	Cable Loss (dB)	Corrected Reading (dBm)	Limit (dBm)	Margin (dB)
1693.2	-47.12	V	7.95	0.78	-39.95	-13	-26.95
1693.2	-47.24	H	7.95	0.78	-40.07	-13	-27.07
389.4	-52.14	V	6.5	0.3	-45.94	-13	-32.94
793.6	-52.3	H	6.9	0.44	-45.84	-13	-32.84

UMTS-FDD Band II (Part 24E)

Low channel

Frequency (MHz)	Substituted level (dBm)	Polarity (H/V)	Antenna Gain Correction (dB)	Cable Loss (dB)	Corrected Reading (dBm)	Limit (dBm)	Margin (dB)
3704.8	-49.45	V	10.25	2.73	-41.93	-13	-28.93
3704.8	-49.88	H	10.25	2.73	-42.36	-13	-29.36
388.6	-50.14	V	6.5	0.3	-43.94	-13	-30.94
794.1	-50.45	H	6.9	0.44	-43.99	-13	-30.99

Middle channel

Frequency (MHz)	Substituted level (dBm)	Polarity (H/V)	Antenna Gain Correction (dB)	Cable Loss (dB)	Corrected Reading (dBm)	Limit (dBm)	Margin (dB)
3760	-49.18	V	10.25	2.73	-41.66	-13	-28.66
3760	-49.88	H	10.25	2.73	-42.36	-13	-29.36
388.7	-51.88	V	6.5	0.3	-45.68	-13	-32.68
794.5	-52.8	H	6.9	0.44	-46.34	-13	-33.34

High channel

Frequency (MHz)	Substituted level (dBm)	Polarity (H/V)	Antenna Gain Correction (dB)	Cable Loss (dB)	Corrected Reading (dBm)	Limit (dBm)	Margin (dB)
3815.2	-50.15	V	10.36	2.73	-42.52	-13	-29.52
3815.2	-51.45	H	10.36	2.73	-43.82	-13	-30.82
388.9	-52.15	V	6.5	0.3	-45.95	-13	-32.95
794.8	-52.45	H	6.9	0.44	-45.99	-13	-32.99

6.8 Band Edge

Temperature	28°C
Relative Humidity	52%
Atmospheric Pressure	1028mbar
Test date :	November 28, 2015
Tested By :	Winnie Zhang

Requirement(s):

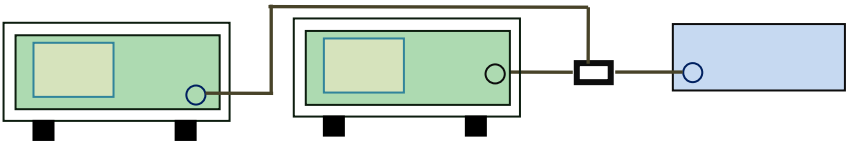
Spec	Item	Requirement	Applicable
§22.917(a) §24.238(a)	a)	The power of any emission outside of the authorized operating frequency ranges must be lower than the transmitter power (P) by a factor of at least $43 + 10 \log (P)$ dB.	<input checked="" type="checkbox"/>
Test setup			
Procedure	<ul style="list-style-type: none"> - The EUT was connected to Spectrum Analyzer and Base Station via power divider. - The Band Edges of low and high channels for the highest RF powers were measured. Setting RBW as roughly BW/100. 		
Remark			
Result	<input checked="" type="checkbox"/> Pass <input type="checkbox"/> Fail		

Test Data Yes N/A

Test Plot Yes (See below) N/A

Cellular Band (Part 22H) result

Frequency (MHz)	Emission (dBm)	Limit (dBm)
823.9800	-13.94	-13
849.0175	-13.97	-13

PCS Band (Part24E) result

Frequency (MHz)	Emission (dBm)	Limit (dBm)
1849.9950	-15.71	-13
1910.0150	-15.22	-13

UMTS-FDD Band V (Part 22H)

Frequency (MHz)	Emission (dBm)	Limit (dBm)
823.9250	-21.76	-13
849.0250	-23.29	-13

UMTS-FDD Band II (Part 24E)

Frequency (MHz)	Emission (dBm)	Limit (dBm)
1849.775	-23.94	-13
1910.025	-25.43	-13

Test Plots

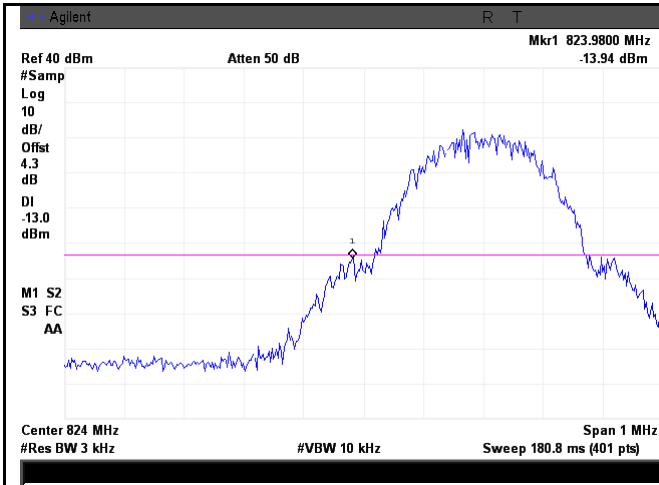

Cellular Band - Low Channel

Note: Offset=Cable loss (4.0) + 10log
 (3.19/3)=4.0+0.3=4.3 dB

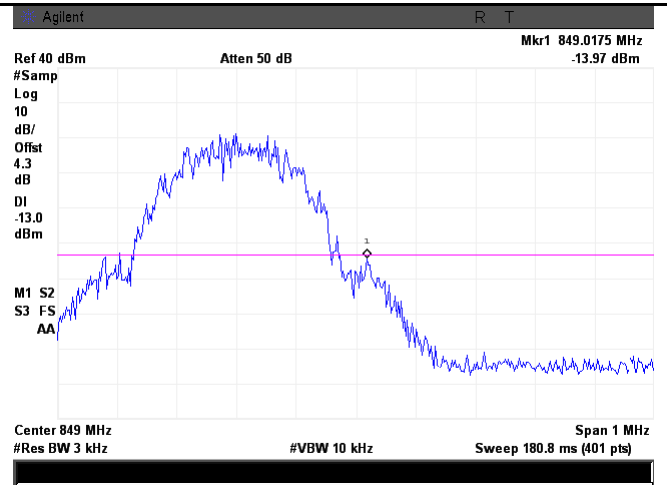

Cellular Band - High Channel

Note: Offset=Cable loss (4.0) + 10log
 (3.21/3)=4.0+0.3=4.3 dB

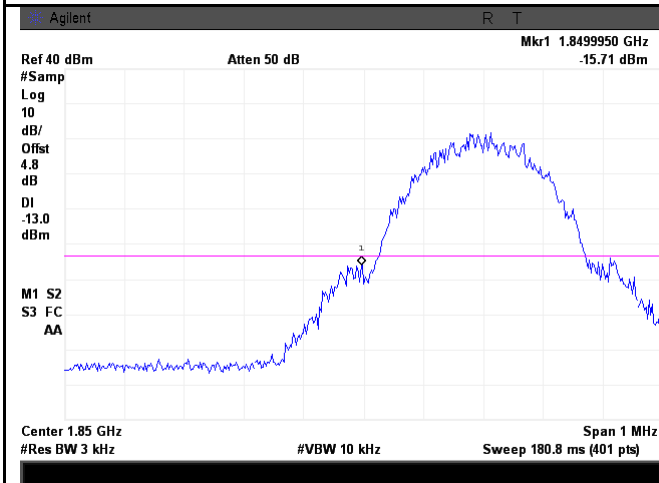

PCS Band - Low Channel

Note: Offset=Cable loss (4.5) + 10log
 (3.19/3)=4.5+0.3=4.8 dB

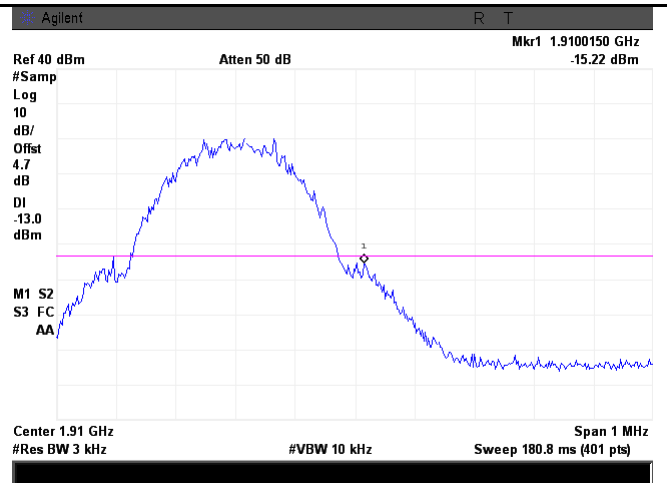

PCS Band - High Channel

Note: Offset=Cable loss (4.5) + 10log
 (3.16/3)=4.5+0.2=4.7 dB

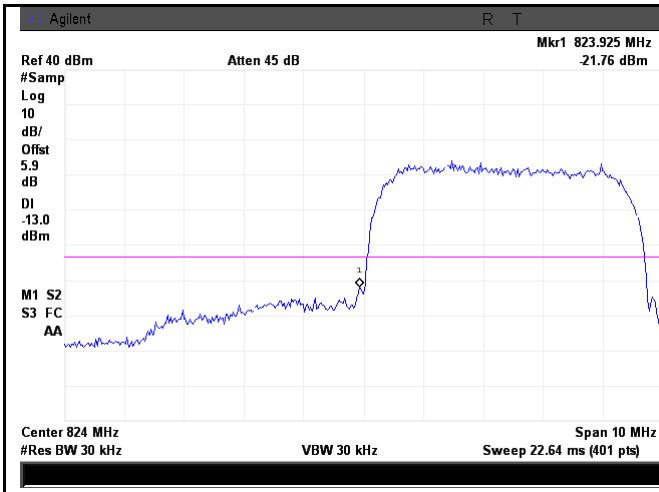

UMTS-FDD Band V - Low Channel

Note: Offset=Cable loss (4.0) + 10log
 (46.63/30)=4.0+1.9=5.9 dB

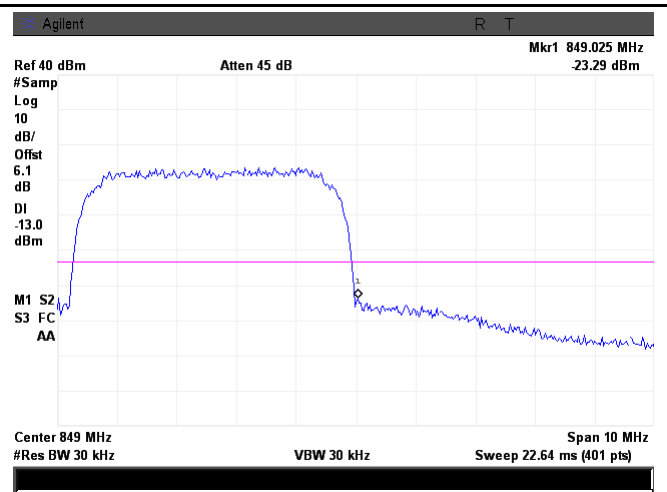

UMTS-FDD Band V - High Channel

Note: Offset=Cable loss (4.0) + 10log
 (48.77/30)=4.0+2.1=6.1 dB

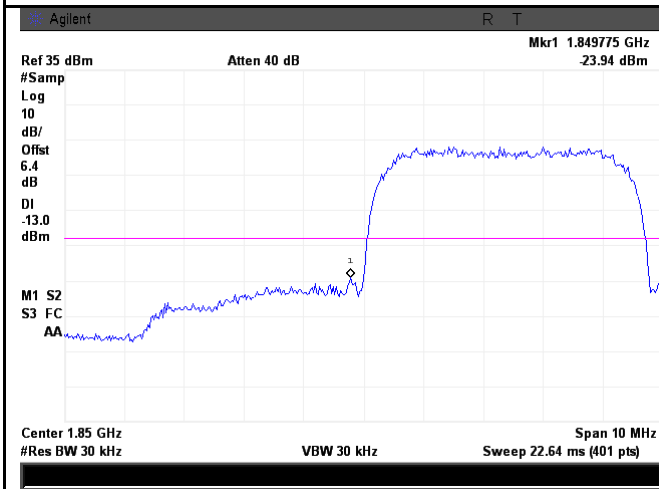

UMTS-FDD Band II - Low Channel

Note: Offset=Cable loss (4.5) + 10log
 (47/30)=4.5+1.9=6.4 dB

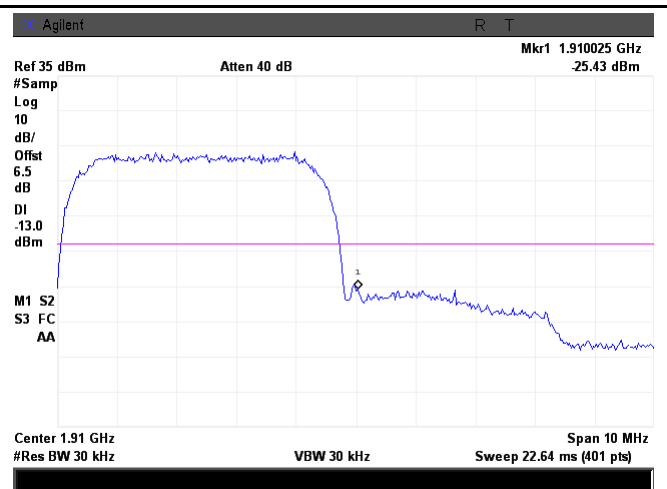

UMTS-FDD Band II - High Channel

Note: Offset=Cable loss (4.5) + 10log
 (47.17/30)=4.5+2.0=6.5 dB

6.9 Frequency Stability

Temperature	28°C
Relative Humidity	52%
Atmospheric Pressure	1028mbar
Test date :	November 28, 2015
Tested By :	Winnie Zhang

Requirement(s):

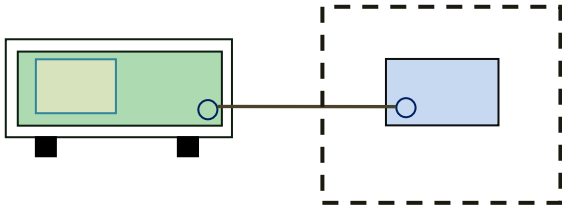
Spec	Item	Requirement	Applicable																																
§2.1055, §22.355 & §24.235	a)	According to §22.355, the carrier frequency of each transmitter in the Public Mobile Services must be maintained within the tolerances given in Table below: Frequency Tolerance for Transmitters in the Public Mobile Services	<input checked="" type="checkbox"/>																																
		<table border="1"> <thead> <tr> <th>Frequency Range (MHz)</th> <th>Base, fixed (ppm)</th> <th>Mobile ≤ 3 watts (ppm)</th> <th>Mobile ≤ 3 watts (ppm)</th> </tr> </thead> <tbody> <tr> <td>25 to 50</td> <td>20.0</td> <td>20.0</td> <td>50.0</td> </tr> <tr> <td>5 to 450</td> <td>5.0</td> <td>5.0</td> <td>50.0</td> </tr> <tr> <td>450 to 512</td> <td>2.5</td> <td>5.0</td> <td>5.0</td> </tr> <tr> <td>821 to 896</td> <td>1.5</td> <td>2.5</td> <td>2.5</td> </tr> <tr> <td>928 to 29.</td> <td>5.0</td> <td>N/A</td> <td>N/A</td> </tr> <tr> <td>929 to 960.</td> <td>1.5</td> <td>N/A</td> <td>N/A</td> </tr> <tr> <td>2110 to 2220</td> <td>10.0</td> <td>N/A</td> <td>N/A</td> </tr> </tbody> </table>		Frequency Range (MHz)	Base, fixed (ppm)	Mobile ≤ 3 watts (ppm)	Mobile ≤ 3 watts (ppm)	25 to 50	20.0	20.0	50.0	5 to 450	5.0	5.0	50.0	450 to 512	2.5	5.0	5.0	821 to 896	1.5	2.5	2.5	928 to 29.	5.0	N/A	N/A	929 to 960.	1.5	N/A	N/A	2110 to 2220	10.0	N/A	N/A
		Frequency Range (MHz)		Base, fixed (ppm)	Mobile ≤ 3 watts (ppm)	Mobile ≤ 3 watts (ppm)																													
		25 to 50		20.0	20.0	50.0																													
		5 to 450		5.0	5.0	50.0																													
		450 to 512		2.5	5.0	5.0																													
		821 to 896		1.5	2.5	2.5																													
		928 to 29.		5.0	N/A	N/A																													
929 to 960.	1.5	N/A	N/A																																
2110 to 2220	10.0	N/A	N/A																																
According to §24.235, the frequency stability shall be sufficient to ensure that the fundamental emissions stay within the authorized frequency block.																																			
Test setup																																			

Test Report	15070965-FCC-R1
Page	39 of 52

Procedure	A communication link was established between EUT and base station. The frequency error was monitored and measured by base station under variation of ambient temperature and variation of primary supply voltage. Limit: The frequency stability of the transmitter shall be maintained within $\pm 0.00025\%$ ($\pm 2.5\text{ppm}$) of the center frequency.
Remark	
Result	<input checked="" type="checkbox"/> Pass <input type="checkbox"/> Fail

Test Data Yes N/A

Test Plot Yes (See below) N/A

Cellular Band (Part 22H) result

Middle Channel, $f_0 = 836.6$ MHz				
Temperature (°C)	Power Supplied (V _{DC})	Frequency Error (Hz)	Frequency Error (ppm)	Limit (ppm)
-10	3.7	19	0.0227	2.5
0		17	0.0203	2.5
10		20	0.0239	2.5
20		14	0.0167	2.5
30		16	0.0191	2.5
40		18	0.0215	2.5
50		23	0.0275	2.5
55		29	0.0347	2.5
25		4.2	23	0.0275
	3.5	25	0.0299	2.5

PCS Band (Part 24E) result

Middle Channel, $f_0 = 1880$ MHz				
Temperature (°C)	Power Supplied (V _{DC})	Frequency Error (Hz)	Frequency Error (ppm)	Limit (ppm)
-10	3.7	29	0.0154	2.5
0		25	0.0133	2.5
10		27	0.0144	2.5
20		18	0.0096	2.5
30		15	0.0080	2.5
40		12	0.0064	2.5
50		20	0.0106	2.5
55		16	0.0085	2.5
25		4.2	22	0.0117
	3.5	26	0.0138	2.5

UMTS-FDD Band V (Part 22H)

Middle Channel, $f_0 = 835$ MHz				
Temperature (°C)	Power Supplied (V _{DC})	Frequency Error (Hz)	Frequency Error (ppm)	Limit (ppm)
-10	3.7	15	0.0180	2.5
0		12	0.0144	2.5
10		17	0.0204	2.5
20		14	0.0168	2.5
30		16	0.0192	2.5
40		19	0.0228	2.5
50		10	0.0120	2.5
55		21	0.0251	2.5
25	4.2	17	0.0204	2.5
	3.5	19	0.0228	2.5

UMTS-FDD Band II (Part 24E)

Middle Channel, $f_0 = 1880$ MHz				
Temperature (°C)	Power Supplied (V _{DC})	Frequency Error (Hz)	Frequency Error (ppm)	Limit (ppm)
-10	3.7	14	0.0074	2.5
0		10	0.0053	2.5
10		9	0.0048	2.5
20		5	0.0027	2.5
30		7	0.0037	2.5
40		8	0.0043	2.5
50		12	0.0064	2.5
55		19	0.0101	2.5
25	4.2	10	0.0053	2.5
	3.5	11	0.0059	2.5

Annex A. TEST INSTRUMENT

Instrument	Model	Serial #	Cal Date	Cal Due	In use
RF Conducted Test					
Agilent ESA-E SERIES SPECTRUM ANALYZER	E4407B	MY45108319	09/16/2015	09/15/2016	<input checked="" type="checkbox"/>
Power Splitter	1#	1#	09/01/2015	08/31/2016	<input checked="" type="checkbox"/>
Universal Radio Communication Tester	CMU200	121393	09/25/2015	09/24/2016	<input checked="" type="checkbox"/>
Temperature/Humidity Chamber	UHL-270	001	10/09/2015	10/08/2016	<input checked="" type="checkbox"/>
DC Power Supply	E3640A	MY40004013	09/17/2015	09/16/2016	<input checked="" type="checkbox"/>
Radiated Emissions					
EMI test receiver	ESL6	100262	09/17/2015	09/16/2016	<input checked="" type="checkbox"/>
OPT 010 AMPLIFIER (0.1-1300MHz)	8447E	2727A02430	09/01/2015	08/31/2016	<input checked="" type="checkbox"/>
Microwave Preamplifier (1 ~ 26.5GHz)	8449B	3008A02402	03/25/2015	03/24/2016	<input checked="" type="checkbox"/>
Bilog Antenna (30MHz~6GHz)	JB6	A110712	09/21/2015	09/20/2016	<input checked="" type="checkbox"/>
Bilog Antenna (30MHz~2GHz)	JB1	A112017	09/21/2015	09/20/2016	<input checked="" type="checkbox"/>
Double Ridge Horn Antenna (1 ~18GHz)	AH-118	71259	09/24/2015	09/23/2016	<input checked="" type="checkbox"/>
Double Ridge Horn Antenna (1 ~18GHz)	AH-118	71283	09/24/2015	09/23/2016	<input checked="" type="checkbox"/>
SYNTHESIZED SIGNAL GENERATOR	8665B	3744A01293	09/17/2015	09/16/2016	<input checked="" type="checkbox"/>
Tunable Notch Filter	3NF-800/1000-S	AA4	09/01/2015	08/31/2016	<input checked="" type="checkbox"/>
Tunable Notch Filter	3NF-1000/2000-S	AM 4	09/01/2015	08/31/2016	<input checked="" type="checkbox"/>

Annex B. EUT And Test Setup Photographs

Annex B.i. Photograph: EUT External Photo





EUT - Top View



EUT - Bottom View



EUT - Left View



EUT - Right View

Annex B.ii. Photograph: EUT Internal Photo



Cover Off - Top View 1



Cover Off - Top View 2



Battery - Front View

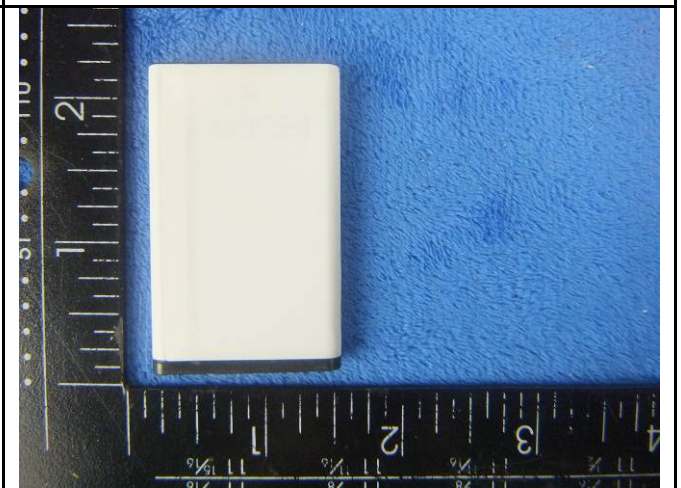

Battery - Rear View

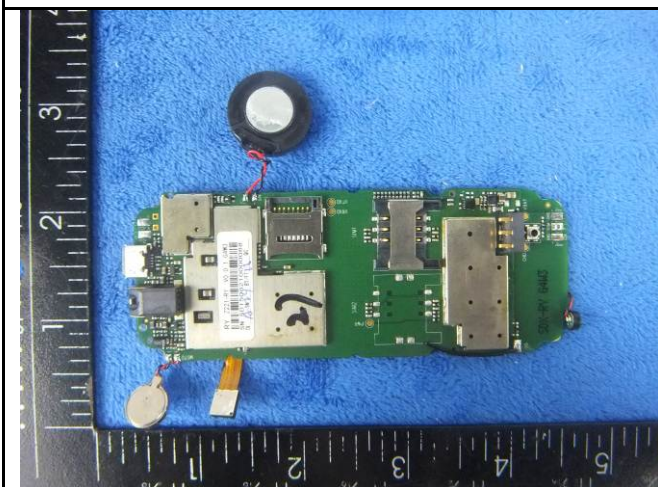

Mainboard with Shielding - Front View

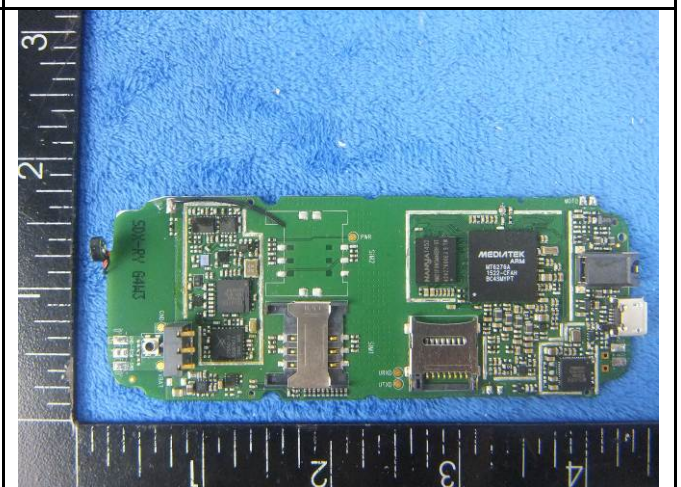

Mainboard without Shielding - Front View

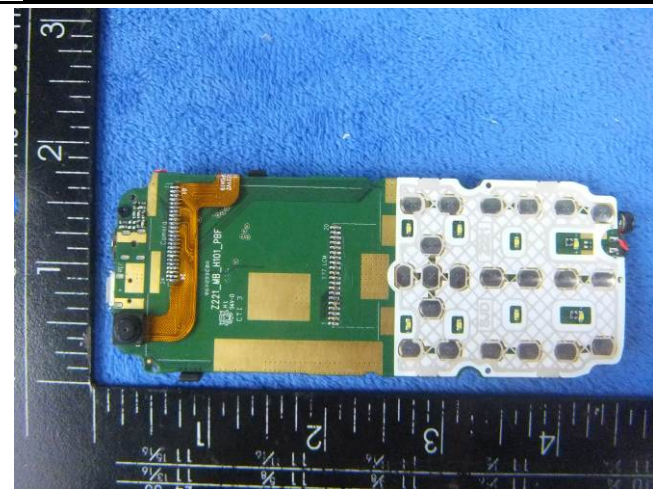

Mainboard – Rear View

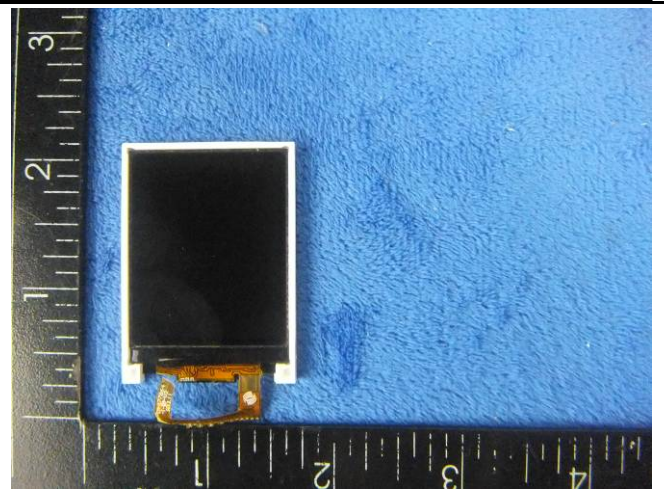

LCD – Front View

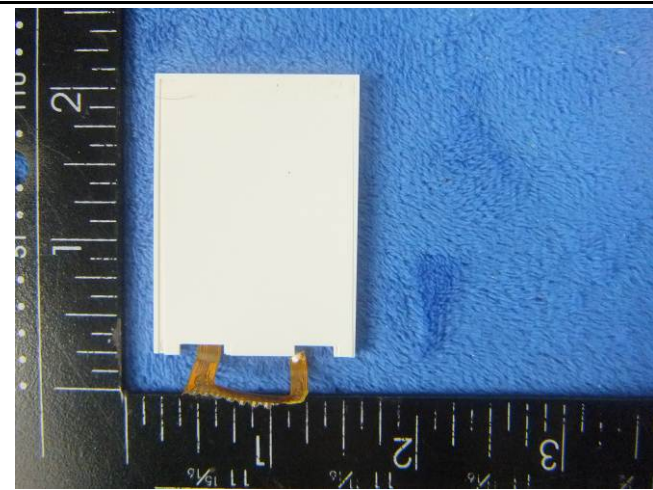

LCD – Rear View



GSM/PCS/UMTS-FDD Antenna View

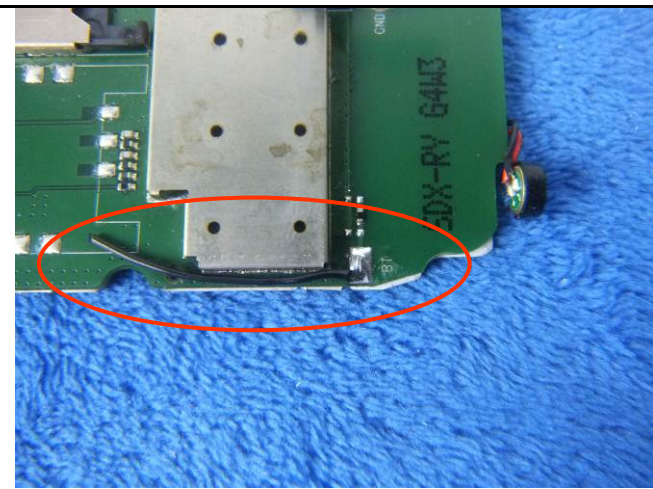

BT - Antenna View

Annex B.iii. Photograph: Test Setup Photo

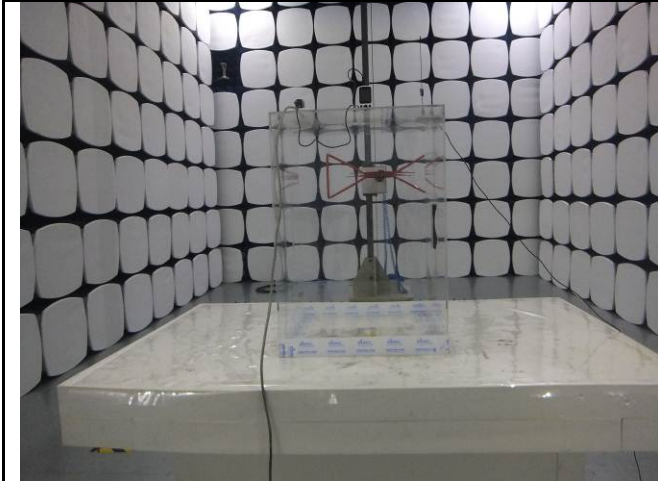

Radiated Spurious Emissions Test Setup Below 1GHz

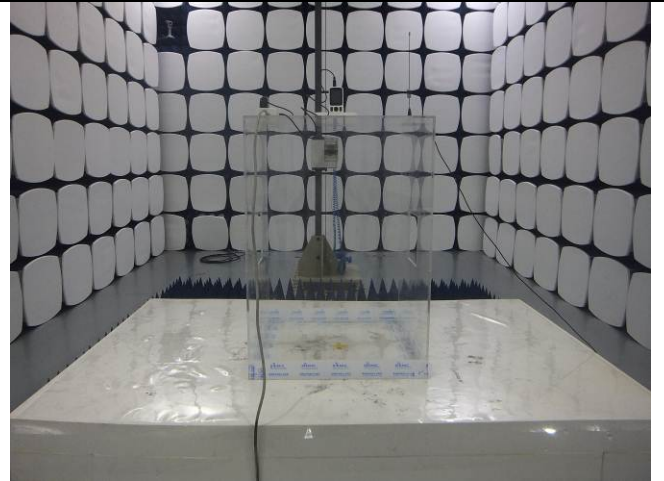

Radiated Spurious Emissions Test Setup Above
1GHz

Annex C. TEST SETUP AND SUPPORTING EQUIPMENT

Annex C.ii. TEST SET UP BLOCK

Block Configuration Diagram for Radiated Emissions

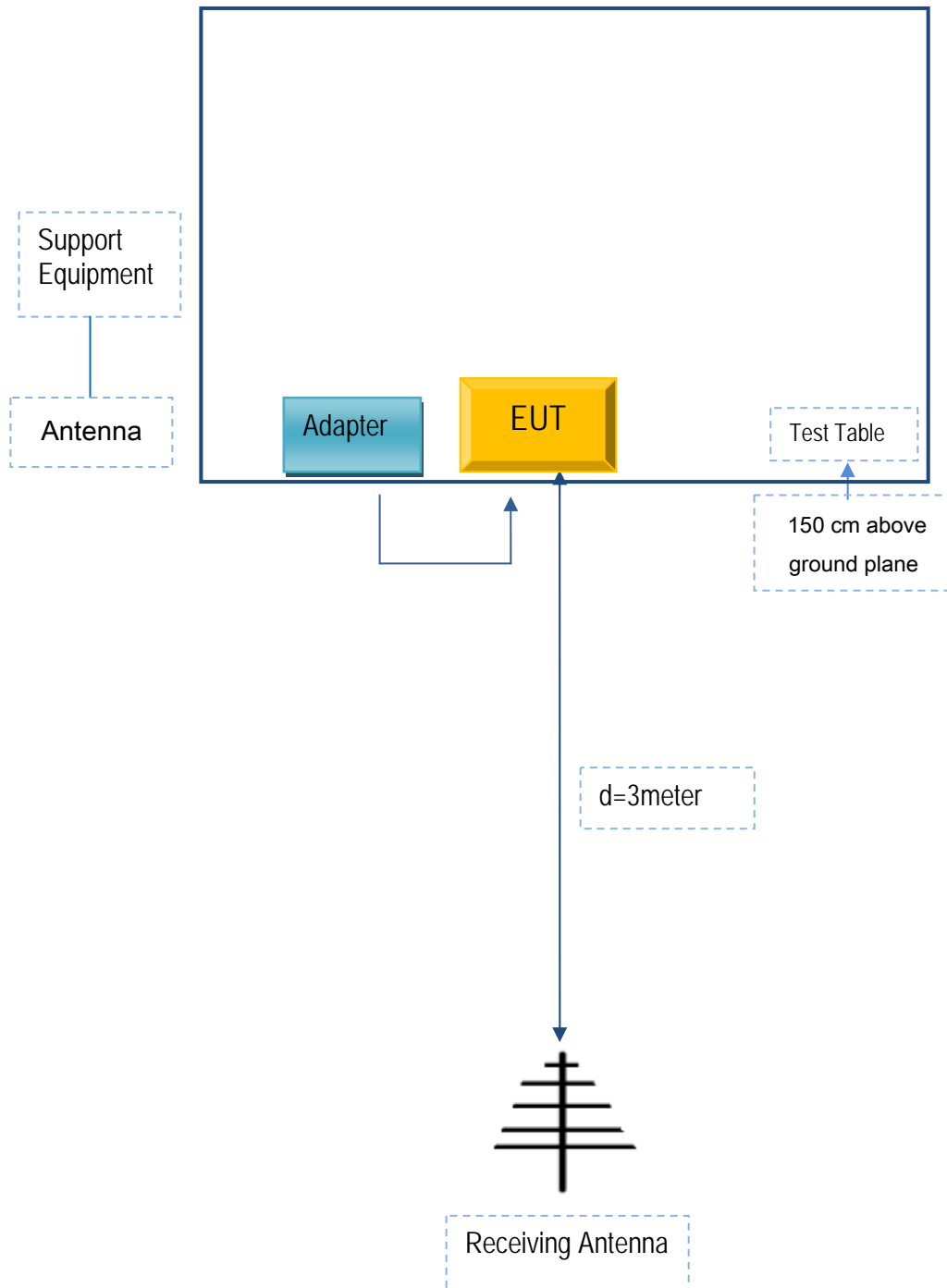

Annex C. ii. SUPPORTING EQUIPMENT DESCRIPTION

The following is a description of supporting equipment and details of cables used with the EUT.

Manufacturer	Equipment Description	Model	Serial No	Calibration Date	Calibration Due Date
AZUMI S.A	Adapter	L3GA Lite	JK119577	N/A	N/A

Supporting Cable:

Cable type	Shield Type	Ferrite Core	Length	Serial No	Calibration Date	Calibration Due Date
USB Cable	Un-shielding	No	0.8m	JX542214	N/A	N/A

Test Report	15070965-FCC-R1
Page	50 of 52

Annex C.ii. EUT OPERATING CONKITIONS

N/A

Test Report	15070965-FCC-R1
Page	51 of 52

Annex D. User Manual / Block Diagram / Schematics / Partlist

Please see attachment

Test Report	15070965-FCC-R1
Page	52 of 52

Annex E. DECLARATION OF SIMILARITY

N/A