

AZUMI

User Guide



KIREI A5 D

WELCOME

- Congratulations on the purchase of your Azumi Mobile phone. Your phone provides many functions which are practical for daily use, such as a hands-free, loudspeaker, camera, MP3 player and ultra clear video
- You can read the manual to understand how to use your Azumi mobile phone and experience the well-established functions and simple operation method. Please use the original accessories in order to achieve the best use of your device. Azumi shall not be responsible for any damage in the machinery due to use of non-original accessories.

User precautions

Before using your Azumi handset, it is important that you read the following recommendations:

- Minimize exposing your phone to water and any other liquid. Keep your phone dry and avoid humid spaces.
- Use only authorized accessories
- Do not try to open your phone.
- If the phone or any accessory is not working properly, take it to a qualified service center.
- The use headphones or earphones for a prolonged time (at high volume) may cause serious damage to your hearing.
- Do not use the phone while charging.
- In extreme heat or cold: avoid temperatures below -10 ° C / 14 ° F or above 40 ° C / 104 ° F.

Note: Remember to visit our website **www.azumi-mobile.com** and our Facebook page **www.facebook.com/Azumi-Africa** if you have questions. Our Team is always available to answer your queries.

YOUR PHONE FUNCTIONS

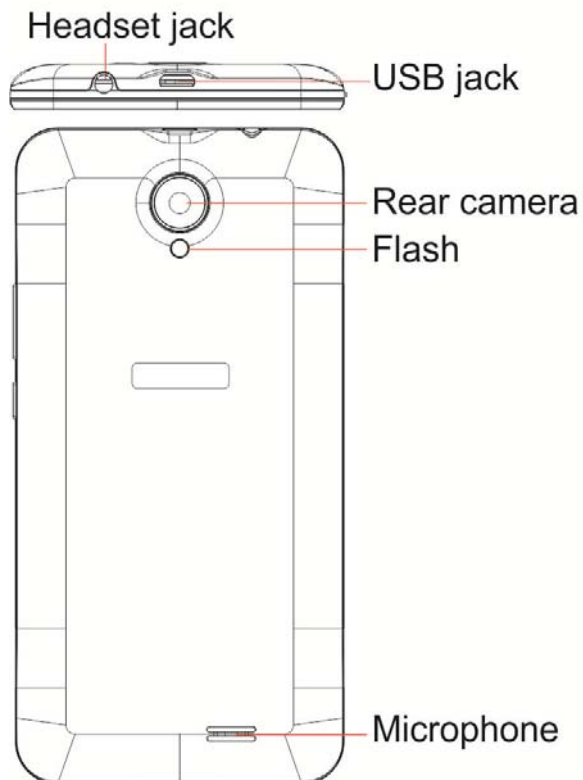
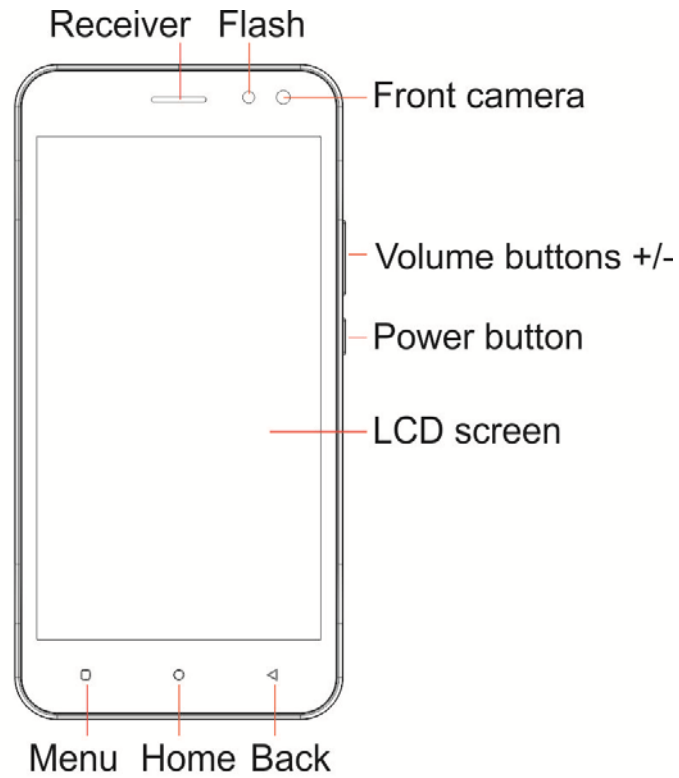

CHARGE THE BATTERY

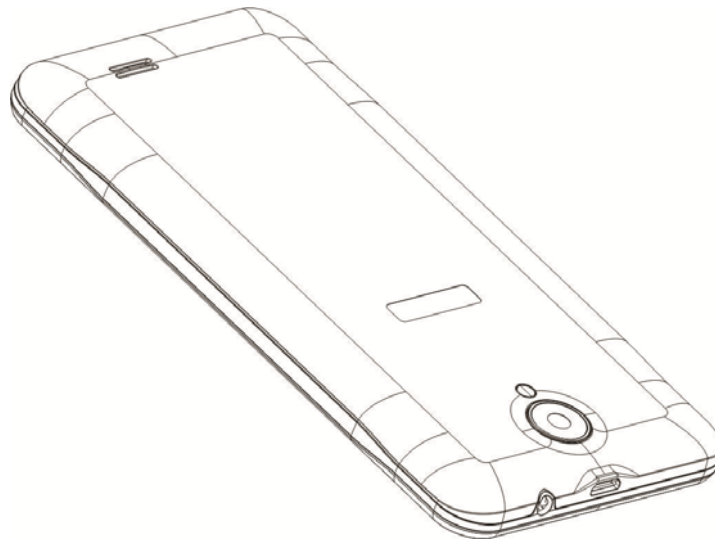

Connect this end to phone's USB port.

Tip: Charge the battery before using it for the first time. Use only AZUMI approved chargers, batteries and cables.

INSERT SIM AND Micro SD CARD

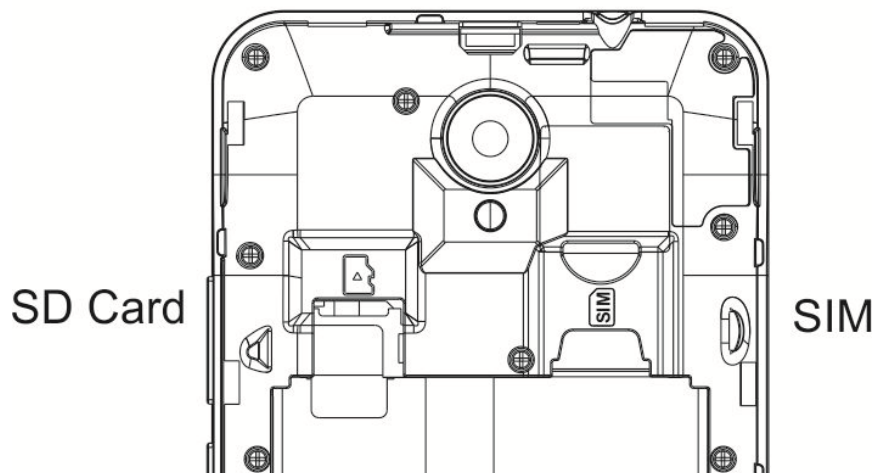

Please insert the SIM card according to the label on the

phone. Make sure that the clipped corner of the SIM card and the metallic contacts are facing the correct direction. Slide the SIM card into the slot until it doesn't move up any further.

Tip: For additional media storage insert a micro SD card.

TURNING THE PHONE ON & OFF

Hold down the power button to turn the phone on.

Hold down the power button, then touch Power off to turn the phone off

DIM, LOCK & WAKING THE PHONE

When the power is on and you want to dim the screen, press the power button.



When the screen is dimmed and you want to wake the phone, press the power button and slide your finger from bottom to top.

HOME SCREEN



Phone status bar and notifications

Touch and hold an empty spot to change the wallpaper

Slide left or right to see more panels

Touch it to enter camera

Touch it to enter web

Touch it to enter main menu

Touch it to enter messages

Touch it to enter the dial pad interface

APPS



1. Touch it to enter app tray.

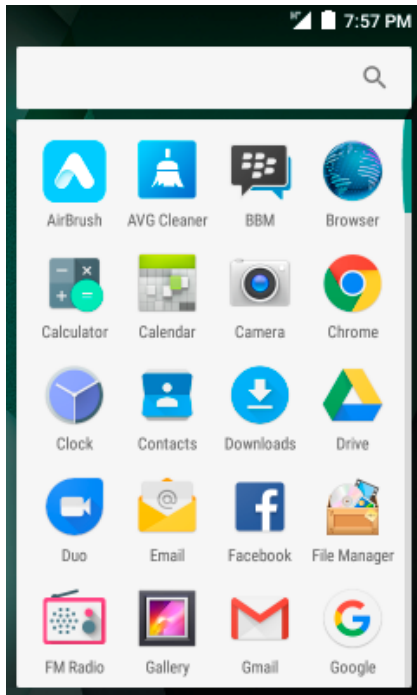

2. Touch an app to launch it

STATUS BAR









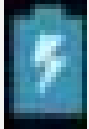

The status bar shows your phone's status and notifications. (Notifications are described on the next page.)

Notification icons

Status icons

Status icons

The following status icons may appear on your screen:

Icon	Statement	Icon	Statement
	SIM Network signal level		Headset is inserted
	Indicates battery capacity		Bluetooth is activated
	Unread messages		Wi-Fi is connected
	Missed calls		Airplane mode is activated
	Alarm is activated		USB is connected

NOTIFICATION PANEL

The notification panel is your center for new events: like new e-mail, voicemail, updates, and more.

Drag down to display notifications.

Touch a notification to respond

MAKE & ANSWER A CALL

1. From the Home screen, touch



2. Touch  to show the dial pad



3. Dial a number, then touch to initiate the call.

Answer a call

Drag to the right

Decline a call



Drag to the left

VOLUME CONTROL WHEN CALLING

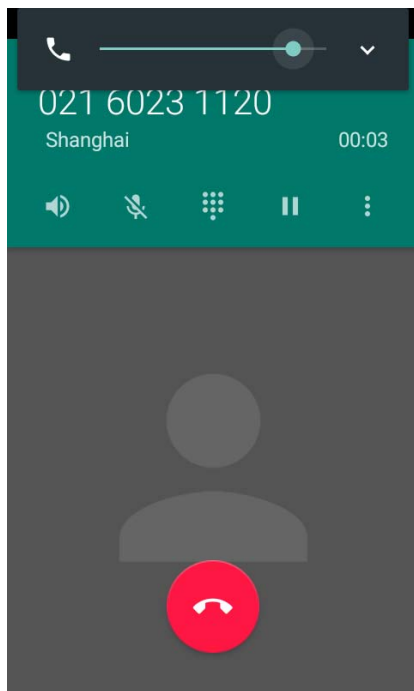
Volume key is at the left side of the phone. During a conversation, you can press the volume key to tune the sound volume.



SEND A TEXT

1. From the Home screen, touch 
2. Touch 
3. Touch the "To" field, then enter a recipient.
4. Touch the Type message field, then enter a message
5. Touch  Send the message

ADDING EMAIL ACCOUNTS

The first time you open Email, you will be prompted to set up an email account. After that, you can configure Email to send and receive email from additional accounts.

To add an email account:

- 1) Tap the e-mail icon. In Your account interface, tap Next. In e-mail address option, enter your e-mail address. In password option, → enter your e-mail password. Tap Next.
- 2) Filling the email address and password, tap next to setup email
- 3) Tap next to enter your email.

SETTINGS

The settings for various features of the phone

Get to know the settings on your phone so that you can personalize them to your own requirements. Go to Settings to configure how your phone looks, sounds, communication, privacy, and operations in a variety of ways:

Wi-Fi	You can use Wireless & Network settings to manage your SIM card, configure and manage connections to networks and devices by using Wi-Fi. You can set Bluetooth, data usage, airplane mode, VPN, tethering & portable hotspot and mobile networks in this interface.
Audio profiles	There are four profiles: General, Silent, Meeting and Outdoor. You can set the profiles according to different conditions.
Display	You can set Wallpaper, Auto-rotate screen, Brightness, Daydream, wireless display, Sleep and Font size in this interface.
Storage	Use the Storage settings to monitor the used and available space on your phone and on your SD card and to manage your SD

	card.
Battery	You can view your battery status, battery level and battery use in this interface.
Apps	You can use the Applications settings to view details about the applications installed on your phone, to manage their data and force them to stop, to view and control services that are currently running, and to view the storage used by applications, etc.
Location	You can turn on Wi-Fi & mobile network location, GPS satellites, etc through this function.
Security	You can set the parameters related to security through this function.
Language & input	Use the Language & Keyboard settings to select the language for the text on your phone and for configuring the input method.
Backup & reset	You can backup your data and reset your phone in this interface.

Add account	You should add an account first before using this function.
Data & time	You can use Date & Time settings to set your preferences for how dates are displayed. You can also use these settings to set your own time and time zone, rather than obtaining the current time from the network, etc.
Timer switch machine	You should set a certain time, when the time arrive, the phone would power on/off automatically.
Accessibility	Enable your installed accessibility applications and adjust related settings.
About phone	This function enables you to view some phone related information.

SET A RINGTONE

Press  Sound & notification, select the profiles you want to set, you can customize the ringtone and volume of incoming call, notification ringtone in this interface.

MULTIMEDIA

listen, watch, capture and enjoy it!

FM RADIO





1. Insert earphone, then Tap the Power icon to stop or play FM.
2. Tap the forward by 0.1 MHz or scroll the knob icon to change channel frequency. Press volume key to adjust the volume.
3. Tap Auto search, Record and Favorites icon to adjust.

MUSIC

Controls

Play/Pause

Touch  / 

Previous/Next	Touch 
Rewind/Forward	Touch the Progress bar
Volume adjust	Press side key
Now playing: Touch to open the current playlist.	Touch 
Shuffle: Touch to shuffle the current playlist.	Touch 
Repeat: Touch to repeat the current playlist; touch again to repeat the current track.	Touch 

Camera

1. Launch the camera by pressing the camera icon on the home screen
2. In the camera app, tap the screen to focus on a specific area.
3. Press the camera button all the way down to take a picture.

SHOOT A VIDEO

1. Press the camera icon.
2. In the Camera app, select video 
3. Press the camera button to begin filming and press again to stop filming.

Calculator

1. Launch the calculator by pressing the calculator icon on the home screen.
2. In the calculator app, enter numbers and arithmetic operators on the basic screen.

Calendar

You can use the calendar to keep track of important events. After entering the calendar function menu you can select year, month and date. Slide the Calendar screen up and down to switch month.

Sound Recorder

Use this function to record audio files. Two function icons at the bottom of the Recorder screen are corresponding to start recording and review recorded file.

Clock

The clock allows you to view time and date. You can also add an alarm, set the alarm and turn it on. Then, the alarm can ring at a specific time you set.

Gallery

Both pictures and videos taken by camera or stored in SD card can be scanned through this function.

Video player

With Videos, you can play video clips in your device (for example, the video you captured by the camera) or

video files stored in compatible SD card (if inserted)

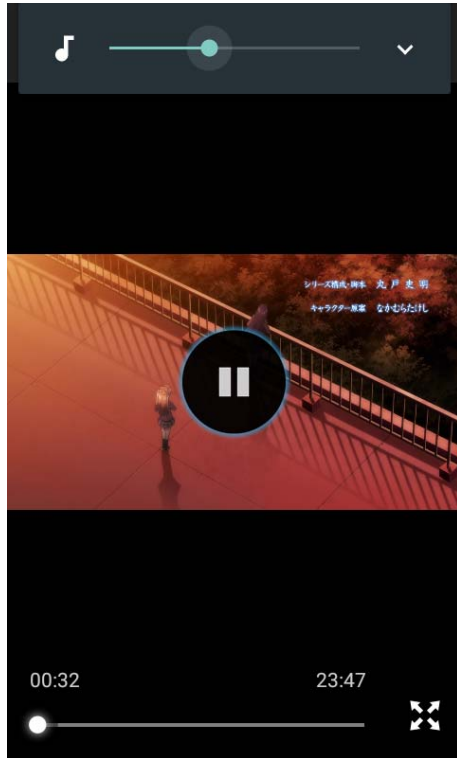

SIM1 Toolkit

STK features are provided by your service provider. If your SIM card supports STK feature, you will see the STK menu. Different STK's have different STK main menu. Please contact your service provider if the STK does not work.

Browser

To let you browse the Internet.

File Manager

This phone supports an SD card. You can use the File Explorer to conveniently manage various directories and files on the SD card.

USE AS MODEM VIA USB

You can connect your phone to a computer with a USB cable, to transfer music, pictures, and other files between your phone's SD card and the computer.

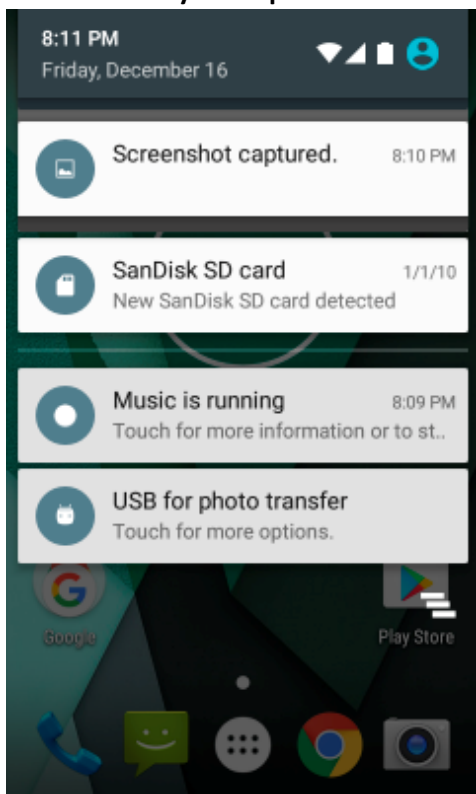

CONNECT TO Wi-Fi NETWORKS

Wi-Fi is a wireless networking technology that can provide Internet access at distances of up to 100 meters, depending on the Wi-Fi router and your surroundings.

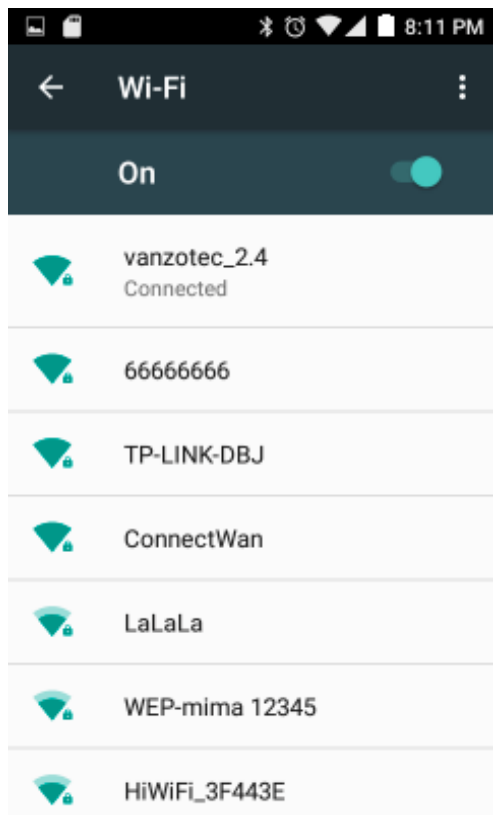

Touch Settings> WI-FI. Check Wi-Fi to turn it on. The phone scans for available Wi-Fi networks and displays the names of those it finds. Secured networks are indicated with a Lock icon.

Health and Safety Information

Please read the following guidelines regarding the use of your phone. Not following them may be dangerous or illegal.

Certification information (SAR)

Your phone is designed not to exceed the limits of emission of radio waves recommended by international guidelines. These guidelines include safety margins designed to assure the protection of all persons, regardless of age and health.

SAR (specific absorption rate) is the unit of body-absorbed RF quantity when the phone is in use. SAR value is ascertained according to the highest RF level generated during laboratory tests. The true SAR level during phone usage will be far lower than this level.

The SAR value of the phone may change depending on factors such as how close you are to a network tower, use of accessories and other enhancements.

The highest SAR value of the device is 0.362W/kg (head) and 0.813W/kg (body) averaged over 10 gm of human tissue.

The SAR value may differ depending on national reporting, testing requirements and the network band.

SAR recommendations

Use a wireless hands-free system (headphone, headset) with a low power Bluetooth emitter.

Please keep your calls short and use SMS whenever more convenient. This advice applies especially to children, adolescents and pregnant women.

Try to use your cell phone when the signal quality is good.

People having active medical implants should preferably keep the cell phone at least 15 cm away from the implant.

Maintain a preferable distance of 15 mm from the device.

Safe driving

Do not use the phone while driving. When you have to use the phone, please use the personal hands-free kit.

Please do not put the phone onto any passenger seat or any place from which it may fall down in case of vehicular collision or emergency braking.

During flight

Flight is influenced by interference caused by the phone. It is illegal to use a phone on the airplane. Please turn off your phone or switch to flight mode during a flight.

In hospitals

Your phone's radio waves may interfere with the functioning of medical devices. Consult a physician or the manufacturer of the medical device to determine whether they are adequately shielded from external radio frequency. Switch off your device when regulations instruct you to do so. Do not carry the wireless device in the breast pocket.

Turn off the phone if there is any reason to suspect that interference is taking place.

Unsafe areas

Please turn off your phone when you are close to a gas station or in the vicinity of any place where fuel and chemical preparations, or any other dangerous goods are stored.

Taking care of your device

Your device is a product of superior design and craftsmanship and should be handled with care. The following suggestions will help you protect your phone.

Keep the device dry. If your device gets wet, remove the battery without turning on the device, wipe it with a dry cloth and take it to the service center.

Do not store the device in high or cold temperature. High temperatures can shorten the life of electronic devices and damage batteries.

Do not use or store the device in dusty, dirty areas. Its moving parts and electronic components can be damaged.

Do not attempt to open the device other than as instructed in this guide. Repairing the phone by yourself and not using our authorized service agents/centers goes against the warranty rules.

Do not drop, knock or shake the device. Rough handling can break internal circuit boards and fine mechanics.

Do not use harsh chemicals, cleaning solvents, or strong detergents to clean the device. Only use a soft, clean, dry cloth to clean the surface of the device.

Do not store your device near magnetic fields or allow your device to come in contact with magnetic fields for extended periods of time.

Battery recommendations

Please put the battery in a well-ventilated place out of direct sunlight. Charge the battery at room temperature range.

If the time span of the battery after charging becomes much shorter than usual, the battery life is at an end. Replace the battery with a new battery of the same make and specification.

Do not discard the battery with household trash.

Please dispose of the used battery according to your local environmental laws and guidelines.

Use manufacturer approved batteries, chargers, accessories and supplies. We will not be responsible

for the user's safety when using unapproved batteries or accessories.

Recycle your phone

 The WEEE logo (shown at the left) appears on the product (battery, handset, and charger) to indicate that this product must not be disposed of or dumped with your other household waste. You are liable to dispose of all your electronic or electrical waste equipment by relocating over to the specified collection point for recycling of such hazardous waste.

Collection and proper recovery of your electronic waste equipment at the time of disposal will allow us to help preserve the environment. Recycling of the electronic waste equipment will ensure safety of human health and the environment.

Disclaimers

The colours and specifications shown/mentioned in the user manual may differ from the actual product. Images shown are for representation purposes only.

Other product logos and company names mentioned herein may be trademarks or trade names of their respective owners.

The content of this manual may vary from the actual content displayed on the mobile phone. In such a case, the latter shall govern.

We keep the right to make modifications to any of the content in this user guide without public announcement or prior notification.

For devices with external power supplies, the plug socket should be placed in short distance and be easily accessible.

Using the wrong type of battery replacement may increase the chance of explosion. Be sure to follow the instructions for disposal of used batteries.

Copyrights

All rights reserved. Reproduction, transfer, distribution or storage of part or all of the contents in this document in any form without the prior written permission of is strictly prohibited.



To prevent possible hearing damage, do not listen at high volume levels of long periods.

To use the device only with the earphones included, never change the earphones included for another one.

FCC Caution.

This equipment has been tested and found to comply with the limits for a Class B digital device, pursuant to Part 15 of the FCC Rules. These limits are designed to provide reasonable protection against harmful interference in a residential installation. This equipment generates, uses and can radiate radio frequency energy and, if not installed and used in accordance with the instructions, may cause harmful interference to radio communications. However, there is no guarantee that interference will not occur in a parti

cular installation. If this equipment does cause harmful interference to radio or television reception, which can be determined by turning the equipment off and on, the user is encouraged to try to correct the interference by one or more of the following measures:

- Reorient or relocate the receiving antenna.
- Increase the separation between the equipment and receiver.
- Connect the equipment into an outlet on a circuit different from that to which the receiver is connected.
- Consult the dealer or an experienced radio/TV technician for help.

§ 15.19 Labelling requirements.

This device complies with part 15 of the FCC Rules.

Operation is subject to the following two conditions:

(1) This device may not cause harmful interference, and (2) this device must accept any interference received, including interference that may cause undesired operation.

§ 15.21 Information to user.

Any Changes or modifications not expressly approved by the party responsible for compliance could void the user's authority to operate the equipment.

Specific Absorption Rate (SAR) information:

This Mobile Phone meets the government's requirements for exposure to radio waves. The guidelines are based on standards that were developed by independent scientific organizations through periodic and thorough evaluation of scientific studies. The standards include a

substantial safety margin designed to assure the safety of all persons regardless of age or health.

FCC RF Exposure Information and Statement The SAR limit of USA (FCC) is 1.6 W/kg averaged over one gram of tissue. This device was tested for typical body-worn operations with the back of the handset kept 10mm for body worn. To maintain compliance with FCC RF exposure requirements, use accessories that maintain a 10mm for body worn. The use of belt clips, holsters and similar accessories should not contain metallic components in its assembly. The use of accessories that do not satisfy these requirements may not comply with FCC RF exposure requirements, and should be avoided.

Body-worn Operation

This device was tested for typical body-worn

operations. To comply with RF exposure requirements, a minimum separation distance of 10mm for body worn must be maintained between the user's body and the handset, including the antenna. Third-party belt-clips, holsters, and similar accessories used by this device should not contain any metallic components. Body-worn accessories that do not meet these requirements may not comply with RF exposure requirements and should be avoided. Use only the supplied or an approved antenna.