

FCC SAR REPORT

Applicant: AZUMI S.A

Address of Applicant: Avenida Aquilino de la Guardia con Calle 47, PH Ocean Plaza,
Piso 16 of. 16-01, Marbella, Ciudad de Panamá City, Rep.
Panamá

Equipment Under Test (EUT)

Product Name: Mobile phone

Model No.: KINZO A5 QL

Trade mark: AZUMI

FCC ID: QRP-AZUMIKINZOA5Q

Applicable standards: FCC 47 CFR Part 2.1093

Date of Test: 01 Jul., 2016 ~ 07 Jul., 2016

Test Result: Maximum Reported 1-g SAR (W/kg)
Head: 0.469 Body: 0.888 Hotspot: 1.196

Authorized Signature:



Bruce Zhang
Laboratory Manager

This report details the results of the testing carried out on one sample. The results contained in this test report do not relate to other samples of the same product and does not permit the use of the CCIS product certification mark. The manufacturer should ensure that all products in series production are in conformity with the product sample detailed in this report.

This report may only be reproduced and distributed in full. If the product in this report is used in any configuration other than that detailed in the report, the manufacturer must ensure the new system complies with all relevant standards.

This document cannot be reproduced except in full, without prior written approval of the Company. Any unauthorized alteration, forgery or falsification of the content or appearance of this document is unlawful and offenders may be prosecuted to the fullest extent of the law. Unless otherwise stated the results shown in this test report refer only to the sample(s) tested and such sample(s) are retained for 90 days only.

2 Version

Version No.	Date	Description
00	25 Jul., 2016	Original
01	11 Aug., 2016	1. Added SAR value on page 1. 2. Added note 3 on page 56.

Prepared by: Sera Xiang Date: 11 Aug., 2016
Report Clerk

Reviewed by: Tanet Wei Date: 11 Aug., 2016
Project Engineer

3 Contents

1	COVER PAGE	1
2	VERSION	2
3	CONTENTS	3
4	SAR RESULTS SUMMARY	5
5	GENERAL INFORMATION	6
5.1	CLIENT INFORMATION.....	6
5.2	GENERAL DESCRIPTION OF EUT.....	6
5.3	MAXIMUM RF OUTPUT POWER.....	7
5.4	ENVIRONMENT OF TEST SITE.....	8
5.5	TEST LOCATION.....	8
6	INTRODUCTION	9
6.1	INTRODUCTION.....	9
6.2	SAR DEFINITION.....	9
7	RF EXPOSURE LIMITS	10
7.1	UNCONTROLLED ENVIRONMENT.....	10
7.2	CONTROLLED ENVIRONMENT.....	10
7.3	RF EXPOSURE LIMITS.....	10
8	SAR MEASUREMENT SYSTEM	11
8.1	E-FIELD PROBE.....	12
8.2	DATA ACQUISITION ELECTRONICS (DAE).....	12
8.3	ROBOT.....	13
8.4	MEASUREMENT SERVER.....	13
8.5	LIGHT BEAM UNIT.....	13
8.6	PHANTOM.....	14
8.7	DEVICE HOLDER.....	15
8.8	DATA STORAGE AND EVALUATION.....	16
8.9	TEST EQUIPMENT LIST.....	18
9	TISSUE SIMULATING LIQUIDS	19
10	SAR SYSTEM VERIFICATION	22
11	EUT TESTING POSITION	24
11.1	HANDSET REFERENCE POINTS.....	24
11.2	POSITIONING FOR CHEEK / TOUCH.....	25
11.3	POSITIONING FOR EAR / 15° TILT.....	25
11.4	SAR EVALUATIONS NEAR THE MOUTH/JAW REGIONS OF THE SAM PHANTOM.....	26
11.5	BODY WORN ACCESSORY CONFIGURATIONS.....	26
11.6	WIRELESS ROUTER (HOTSPOT) CONFIGURATIONS.....	27
12	MEASUREMENT PROCEDURES	28
12.1	SPATIAL PEAK SAR EVALUATION.....	28
12.2	POWER REFERENCE MEASUREMENT.....	29
12.3	AREA & ZOOM SCAN PROCEDURES.....	29
12.4	VOLUME SCAN PROCEDURES.....	30
12.5	SAR AVERAGED METHODS.....	30
12.6	POWER DRIFT MONITORING.....	30
13	CONDUCTED RF OUTPUT POWER	31
13.1	GSM CONDUCTED POWER.....	31
13.2	WCDMA CONDUCTED POWER.....	33
13.3	LTE CONDUCTED POWER.....	36
13.4	WLAN 2.4 GHZ BAND CONDUCTED POWER.....	46
13.5	BLUETOOTH CONDUCTED POWER.....	47
14	EXPOSURE POSITIONS CONSIDERATION	48
14.1	EUT ANTENNA LOCATIONS.....	48
14.2	TEST POSITIONS CONSIDERATION.....	48

15 SAR TEST RESULTS SUMMARY 49

- 15.1 STANDALONE HEAD SAR DATA.....49
- 15.2 STANDALONE BODY SAR 51
- 15.3 BODY SAR IN HOTSPOT MODE 53
- 15.4 REPEATED SAR MEASUREMENT.....56
- 15.5 MULTI-BAND SIMULTANEOUS TRANSMISSION CONSIDERATIONS.....57
- 15.6 SAR SIMULTANEOUS TRANSMISSION ANALYSIS.....58
- 15.7 MEASUREMENT UNCERTAINTY.....63
- 15.8 MEASUREMENT CONCLUSION.....65

16 REFERENCE..... 66

APPENDIX A: EUT PHOTOS..... 67

APPENDIX B: TEST SETUP PHOTOS 69

APPENDIX C: PLOTS OF SAR SYSTEM CHECK..... 72

APPENDIX D: PLOTS OF SAR TEST DATA 85

APPENDIX E: SYSTEM CALIBRATION CERTIFICATE..... 125

4 SAR Results Summary

The maximum results of Specific Absorption Rate (SAR) found during test as bellows:

<Highest Reported standalone SAR Summary>

Exposure Position	Frequency Band	Reported 1-g SAR (W/kg)	Equipment Class	Highest Reported 1-g SAR (W/kg)
Head	GSM 850	0.171	PCE	0.469
	GSM 1900	0.121		
	WCDMA Band V	0.190		
	WCDMA Band II	0.195		
	LTE Band 2	0.229		
	LTE Band 4	0.220		
	LTE Band 7	0.304		
	LTE Band 17	0.041		
	WLAN 2.4 GHz	0.469	DTS	
Body (10 mm Gap)	GSM 850	0.269	PCE	0.888
	GSM 1900	0.533		
	WCDMA Band V	0.281		
	WCDMA Band II	0.792		
	LTE Band 2	0.888		
	LTE Band 4	0.812		
	LTE Band 7	0.525		
	LTE Band 17	0.104		
	WLAN 2.4 GHz	0.211	DTS	
Hotspot (10 mm Gap)	GSM 850	0.482	PCE	1.196
	GSM 1900	0.907		
	WCDMA Band V	0.281		
	WCDMA Band II	0.989		
	LTE Band 2	1.176		
	LTE Band 4	1.196		
	LTE Band 7	0.746		
	LTE Band 17	0.104		
	WLAN 2.4 GHz	0.211	DTS	

<Highest Reported simultaneous SAR Summary>

Exposure Position	Frequency Band	Reported 1-g SAR (W/kg)	Equipment Class	Highest Reported Simultaneous Transmission 1-g SAR (W/kg)
Bottom	LTE Band 4	1.196	PCE	1.196
	WLAN 2.4 GHz	/	DTS	

Note:

1. The highest simultaneous transmission is scalar summation of Reported standalone SAR per FCC KDB 690783 D01 v01r03, and scalar SAR summation of all possible simultaneous transmission scenarios are < 1.6W/kg.
2. This device is compliance with Specific Absorption Rate (SAR) for general population/uncontrolled exposure limits (1.6 W/kg) specified in FCC 47 CFR part 2 (2.1093) and ANSI/IEEE C95.1-2005, and had been tested in accordance with the measurement methods and procedures specified in IEEE 1528-2013.

5 General Information

5.1 Client Information

Applicant:	AZUMI S.A
Address of Applicant:	Avenida Aquilino de la Guardia con Calle 47, PH Ocean Plaza, Piso 16 of. 16-01, Marbella, Ciudad de Panamá City, Rep. Panamá
Manufacturer:	AZUMI HK LTD
Address of Manufacturer:	FLAT/RM 18 BLK 1 14/F GOLDEN INDUSTRIAL BUILDING 16-26 KWAI TAK STREET KWAI CHUNG, HK

5.2 General Description of EUT

Product Name:	Mobile phone	
Model No.:	KINZO A5 QL	
Category of device	Portable device	
Operation Frequency:	GSM850: 824.2 ~ 848.8 MHz PCS 1900: 1850.2 ~ 1909.8 MHz WCDMA Band V: 826.4 ~ 846.6 MHz WCDMA Band II: 1852.4 ~ 1907.6 MHz FDD LTE Band 2 :1850MHz~1910MHz FDD LTE Band 4 :1710MHz~1755MHz FDD LTE Band 7: 2500MHz~2570MHz FDD LTE Band 17: 704MHz~716MHz Bluetooth: 2402 MHz ~ 2480 MHz Wi-Fi: 802.11b/g/n-HT20: 2412MHz ~ 2462 MHz 802.11n-HT40 :2422MHz~2452MHz	
Modulation technology:	GSM/GPRS:GMSK, EGPRS: 8PSK WCDMA/HSDPA/HSUPA: BPSK LTE:QPSK/16QAM Bluetooth: GFSK/π/4DQPSK/8DPSK Wi-Fi: 802.11b: DSSS, 802.11a/g/n: OFDM	
Antenna Type:	Internal Antenna	
Antenna Gain:	GSM850:-1.0dBi, PCS1900:-0.6dBi WCDMA Band V:-1.0dBi, WCDMA Band II:-0.6dBi LTE Band 2: 0dBi, LTE Band4: 0dBi LTE Band 7: 0.5dBi, LTE Band 17: -0.5dBi WIFI/BT: 0dBi	
Release Version:	R99 for GSM, R6 for WCDMA, R8 for LTE	
(E)GPRS Class:	(E)GPRS Class: 12	
Dimensions (L*W*H):	144 mm (L)x 70 mm (W)x 8 mm (H)	
Accessories information:	Adapter: Model: TPA-46B050100UU Input: AC100-240V 50/60Hz 0.2A Output: DC 5.0V, 1A	Battery: Li-ion Battery 3.8V/2200mAh
		Headset: Support headset

5.3 Maximum RF Output Power

Mode	Average Power (dBm)	
	GSM 850	GSM 1900
GSM (Voice)	31.74	28.70
GPRS (1 TX Slot)	31.72	28.69
GPRS (2 TX Slots)	31.07	28.06
GPRS (3 TX Slots)	29.38	26.41
GPRS (4 TX Slots)	28.23	25.35
EGPRS (1 TX Slot)	26.46	23.81
EGPRS (2 TX Slots)	25.36	22.44
EGPRS (3 TX Slots)	23.27	21.94
EGPRS (4 TX Slots)	22.09	20.80

Mode	Average Power (dBm)	
	WCDMA Band V	WCDMA Band II
AMR 12.2 kbps	22.57	21.91
RMC 12.2 kbps	22.58	21.95
HSDPA Sub-test 1	21.50	20.78
HSDPA Sub-test 2	21.11	20.55
HSDPA Sub-test 3	19.43	18.95
HSDPA Sub-test 4	19.52	19.03
HSUPA Sub-test 1	21.40	20.86
HSUPA Sub-test 2	21.39	20.76
HSUPA Sub-test 3	19.44	18.87
HSUPA Sub-test 4	21.49	20.78
HSUPA Sub-test 5	20.43	19.92

Mode	Average Power (dBm)			
	LTE Band 2	LTE Band 4	LTE Band 7	LTE Band 17
BW/1.4 MHz	22.19	23.04	/	/
BW/3.0 MHz	21.87	22.93	/	/
BW/5.0 MHz	22.61	23.67	23.49	22.93
BW/10 MHz	22.51	22.80	23.48	23.79
BW/15 MHz	22.48	23.08	23.41	/
BW/20 MHz	22.54	22.93	23.43	/

WLAN 2.4 GHz Band Average Power (dBm)				
Mode/Band	b	g	n (HT-20)	n (HT-40)
WLAN 2.4GHz	15.37	14.39	14.48	12.79

Bluetooth Average Power (dBm)				
Mode/Band	1 Mbps(GFSK)	2 Mbps($\pi/4$ DQPSK)	3 Mbps (8DPSK)	LE (BT 4.0)
Bluetooth 2.4 GHz	3.89	3.01	3.01	-3.11

5.4 Environment of Test Site

Temperature:	18°C ~25 °C
Humidity:	35%~75% RH
Atmospheric Pressure:	1010 mbar

5.5 Test Location

Shenzhen Zhongjian Nanfang Testing Co., Ltd.
Address: No. B-C, 1/F., Building 2, Laodong No.2 Industrial Park, Xixiang Road,
Bao'an District, Shenzhen, Guangdong, China
Tel: +86-755-23118282
Fax: +86-755-23116366

6 Introduction

6.1 Introduction

SAR is related to the rate at which energy is absorbed per unit mass in an object exposed to a radio field. The SAR distribution in a biological body is complicated and is usually carried out by experimental techniques or numerical modeling. The standard recommends limits for two tiers of groups, occupational/controlled and general population/uncontrolled, based on a person's awareness and ability to exercise control over his or her exposure. In general, occupational/controlled exposure limits are higher than the limits for general population/uncontrolled.

6.2 SAR Definition

The SAR definition is the time derivative (rate) of the incremental energy (dW) absorbed by (dissipated in) an incremental mass (dm) contained in a volume element (dv) of a given density (ρ). The equation description is as below:

$$SAR = \frac{d}{dt} \left(\frac{dU}{dm} \right) = \frac{d}{dt} \left(\frac{dU}{\rho dv} \right)$$

SAR is expressed in units of Watts per kilogram (W/kg)

SAR measurement can be either related to the temperature elevation in tissue by

$$SAR = C \left(\frac{\delta T}{\delta t} \right)$$

Where: C is the specific heat capacity, δT is the temperature rise and δt is the exposure duration, or related to the electrical field in the tissue by

$$SAR = \frac{\sigma \cdot E^2}{\rho}$$

Where: σ is the conductivity of the tissue, ρ is the mass density of the tissue and E is the RMS electrical field strength. However for evaluating SAR of low power transmitter, electrical field measurement is typically applied.

7 RF Exposure Limits

7.1 Uncontrolled Environment

Uncontrolled Environments are defined as locations where there is the exposure of individuals who have no knowledge or control of their exposure. The general population/uncontrolled exposure limits are applicable to situations in which the general public may be exposed or in which persons who are exposed as a consequence of their employment may not be made fully aware of the potential for exposure or cannot exercise control over their exposure. Members of the general public would come under this category when exposure is not employment-related; for example, in the case of a wireless transmitter that exposes persons in its vicinity.

7.2 Controlled Environment

Controlled Environments are defined as locations where there is exposure that may be incurred by persons who are aware of the potential for exposure, (i.e. as a result of employment or occupation). In general, occupational/controlled exposure limits are applicable to situations in which persons are exposed as a consequence of their employment, who have been made fully aware of the potential for exposure and can exercise control over their exposure. This exposure category is also applicable when the exposure is of a transient nature due to incidental passage through a location where the exposure levels may be higher than the general population/uncontrolled limits, but the exposed person is fully aware of the potential for exposure and can exercise control over his or her exposure by leaving the area or by some other appropriate means.

7.3 RF Exposure Limits

SAR Human Exposure Specified in ANSI/IEEE C95.1-1992 and Health Canada Safety Code 6

HUMAN EXPOSURE LIMITS		
	UNCONTROLLED ENVIRONMENT <i>General Population</i> (W/kg) or (mW/g)	CONTROLLED ENVIRONMENT <i>Occupational</i> (W/kg) or (mW/g)
SPATIAL PEAK SAR Brain	1.6	8.0
SPATIAL AVERAGE SAR Whole Body	0.08	0.4
SPATIAL PEAK SAR Hands, Feet, Ankles, Wrists	4.0	20

Note:

1. The Spatial Peak value of the SAR averaged over any 1 gram of tissue (defined as a tissue volume in the shape of a cube) and over the appropriate averaging time.
2. The Spatial Average value of the SAR averaged over the whole body.
3. The Spatial Peak value of the SAR averaged over any 10 grams of tissue (defined as a tissue volume in the shape of a cube) and over the appropriate averaging time.

8 SAR Measurement System

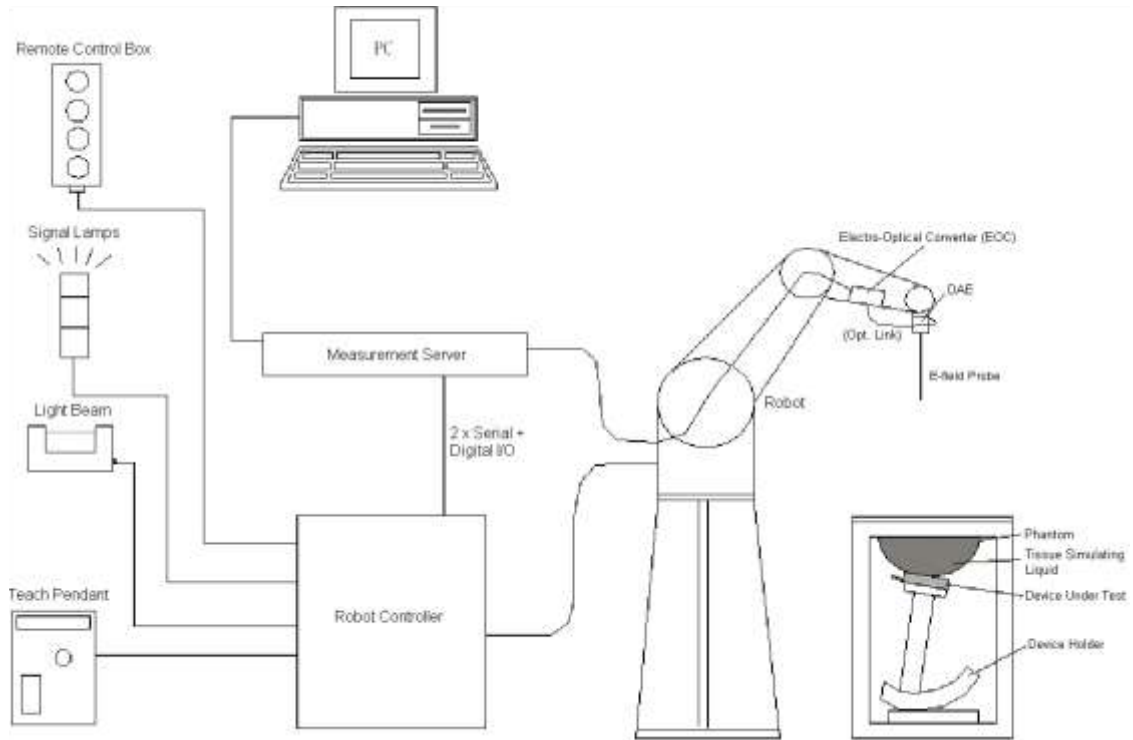

Fig. 8.1 SPEAG DASY System Configurations

The DASY system for performance compliance tests is illustrated above graphically. This system consists of the following items:

- A standard high precision 6-axis robot with controller, a teach pendant and software
- A data acquisition electronic (DAE) attached to the robot arm extension
- A dosimetric probe equipped with an optical surface detector system
- The electro-optical converter (EOC) performs the conversion between optical and electrical signals
- A measurement server performs the time critical tasks such as signal filtering, control of the robot operation and fast movement interrupts.
- A probe alignment unit which improves the accuracy of the probe positioning
- A computer operating Windows XP
- DASY software
- Remove control with teach pendant and additional circuitry for robot safety such as warning lamps, etc.
- The SAM twin phantom
- A device holder
- Tissue simulating liquid
- Dipole for evaluating the proper functioning of the system

Component details are described in the following sub-sections.

8.1 E-Field Probe

The SAR measurement is conducted with the dosimetric probe (manufactured by SPEAG). The probe is specially designed and calibrated for use in liquid with high permittivity. The dosimetric probe has special calibration in liquid at different frequency. This probe has a built in optical surface detection system to prevent from collision with phantom.

➤ E-Field Probe Specification <EX3DV4 Probe>

Construction	Symmetrical design with triangular core Built-in shielding against static charges PEEK enclosure material (resistant to organic solvents, e.g., DGBE)
Frequency Directivity	10 MHz to 6 GHz; Linearity: ± 0.2 dB ± 0.3 dB in HSL (rotation around probe axis) ± 0.5 dB in tissue material (rotation normal to probe axis)
Dynamic Range	10 μ W/g to 100 mW/g; Linearity: ± 0.2 dB (noise: typically < 1 μ W/g)
Dimensions	Overall length: 330 mm (Tip: 20mm) Tip diameter: 2.5 mm (Body: 12mm) Typical distance from probe tip to dipole centers: 1 mm



Fig. 8.2 Photo of E-Field Probe

➤ E-Field Probe Calibration

Each probe needs to be calibrated according to a dosimetric assessment procedure with accuracy better than $\pm 10\%$. The spherical isotropy shall be evaluated and within ± 0.25 dB. The sensitivity parameters (Norm X, Norm Y and Norm Z), the diode compression parameter (DCP) and the conversion factor (ConvF) of the probe are tested. The calibration data can be referred to appendix E of this report.

8.2 Data Acquisition Electronics (DAE)

The Data acquisition electronics (DAE) consists of a highly sensitive electrometer-grade preamplifier with auto-zeroing, a channel and gain-switching multiplexer, a fast 16 bit AD-converter and a command decoder and control logic unit. Transmission to the measurement server is accomplished through an optical downlink for data and status information as well as an optical uplink for commands and the clock. The input impedance of the DAE is 200 MOhm; the inputs are symmetrical and floating. Common mode rejection is above 80 dB.



Fig. 8.3 Photo of DAE

8.3 Robot

The SPEAG DASY system uses the high precision robots (DASY5: TX60XL) type from Stäubli SA (France). For the 6-axis controller system, the robot controller version (DASY5: CS8c) from Stäubli is used. The Stäubli robot series have many features that are important for our application:

- High precision (repeatability 0.02 mm)
- High reliability (industrial design)
- Low maintenance costs (virtually maintenance free due to direct drive gears; no belt drives)
- Jerk-free straight movements
- Low ELF interference (motor control fields shielded via the closed metallic construction shields)



Fig. 8.4 Photo of Robot

8.4 Measurement Server

The measurement server is based on a PC/104 CPU board with CPU (DASY 5: 400MHz, Intel Celeron), chip-disk (DASY5: 128 MB), RAM (DASY5: 128 MB). The necessary circuits for communication with the DAE electronic box, as well as the 16 bit AD converter system for optical detection and digital I/O interface are contained on the DASY I/O board, which is directly connected to the PC/104 bus of the CPU board. The measurement server performs all the real-time data evaluation for field measurements and surface detection, controls robot movements and handles safety operations.



Fig. 8.5 Photo of Server for DASY5

8.5 Light Beam Unit

The light beam switch allows automatic "tooling" of the probe. During the process, the actual position of the probe tip with respect to the robot arm is measured, as well as the probe length and the horizontal probe offset. The software then corrects all movements, such that the robot coordinates are valid for the probe tip. The repeatability of this process is better than 0.1 mm. If a position has been taught with an aligned probe, the same position will be reached with another aligned probe within 0.1 mm, even if the other probe has different dimensions. During probe rotations, the probe tip will keep its actual position.



Fig. 8.6 Photo of Light Beam

8.6 Phantom

<SAM Twin Phantom>

Shell Thickness	2 ± 0.2 mm; Center ear point: 6 ± 0.2 mm
Filling Volume Dimensions	Approx. 25 liters Length: 1000mm; Width: 500mm; Height: adjustable feet
Measurement Areas	Left Head, Right Head, Flat phantom



Fig. 8.7 Photo of SAM Twin Phantom

The bottom plate contains three pair of bolts for locking the device holder. The device holder positions are adjusted to the standard measurement positions in the three sections. A white cover is provided to tap the phantom during off-periods to prevent water evaporation and changes in the liquid parameters. On the phantom top, three reference markers are provided to identify the phantom position with respect to the robot.

<ELI4 Phantom >

The ELI4 phantom is intended for compliance testing of handheld and body-mounted wireless devices in the frequency range of 30MHz to 6 GHz. ELI4 is fully compatible with the latest draft of the standard IEC 62209-2 and all known tissue simulating liquids.

ELI4 has been optimized regarding its performance and can be integrated into a SPEAG standard phantom table. A cover prevents evaporation of the liquid. Reference markings on the phantom allow installation of the complete setup, including all predefined phantom positions and measurement grids, by teaching three points. The phantom can be used with the following tissue simulating liquids:

- Water-sugar based liquids can be left permanently in the phantom. Always cover the liquid if the system is not in use; otherwise the parameters will change due to water evaporation.
- DGBE based liquids should be used with care. As DGBE is a softener for most plastics, the liquid should be taken out of the phantom and the phantom should be dried when the system is not in use (desirable at least once a week).
- Do not use other organic solvents without previously testing the phantom resistiveness.



Fig.8.8 Photo of ELI4 Phantom

8.7 Device Holder

<Device Holder for SAM Twin Phantom>

The SAR in the phantom is approximately inversely proportional to the square of the distance between the source and the liquid surface. For a source at 5 mm distance, a positioning uncertainty of ± 0.5 mm would produce a SAR uncertainty of ± 20 %. Accurate device positioning is therefore crucial for accurate and repeatable measurements. The positions in which the devices must be measured are defined by the standards. The DASY device holder is designed to cope with different positions given in the standard. It has two scales for the device rotation (with respect to the body axis) and the device inclination (with respect to the line between the ear reference points). The rotation center for both scales is the ear reference point (ERP).

Thus the device needs no repositioning when changing the angles.

The DASY device holder is constructed of low-loss POM material having the following dielectric parameters: relative permittivity $\epsilon = 3$ and loss tangent $\delta = 0.02$. The amount of dielectric material has been reduced in the closest vicinity of the device, since measurements have suggested that the influence of the clamp on the test results could thus be lowered.



Fig. 8.9 Photo of Device Holder

8.8 Data storage and Evaluation

➤ Data Storage

The DASY software stores the assessed data from the data acquisition electronics as raw data (in microvolt readings from the probe sensors), together with all the necessary software parameters for the data evaluation (probe calibration data, liquid parameters and device frequency and modulation data) in measurement files. The post-processing software evaluates the desired unit and format for output each time the data is visualized or exported. This allows verifications of the complete software setup even after the measurement and allows correction of erroneous parameter settings. For example, if a measurement has been performed with an incorrect crest factor parameter in the device setup, the parameter can be corrected afterwards and the data can be reevaluated.

The measured data can be visualized or exported in different units or formats, depending on the selected probe type (e.g., [V/m], [mW/g]). Some of these units are not available in certain situations or give meaningless results, e.g., a SAR-output in a non-lose media, will always be zero. Raw data can also be exported to perform the evaluation with other software packages.

➤ Data Evaluation

The DASY post-processing software (SEMCAD) automatically executes the following procedures to calculate the field units from the microvolt readings at the probe connector. The parameters used in the evaluation are stored in the configuration modules of the software:

Probe Parameters:	<ul style="list-style-type: none"> - Sensitivity - Conversion - Diode compression point 	<ul style="list-style-type: none"> Norm_i, a_{i0}, a_{i1}, a_{i2} ConvF_i dcp_i
Device Parameters:	<ul style="list-style-type: none"> - Frequency - Crest 	<ul style="list-style-type: none"> f cf
Media Parameters:	<ul style="list-style-type: none"> - Conductivity - Density 	<ul style="list-style-type: none"> σ ρ

These parameters must be set correctly in the software. They can be found in the component documents or they can be imported into the software from the configuration files issued for the DASY components. In the direct measuring mode of the multi-meter option, the parameters of the actual system setup are used. In the scan visualization and export modes, the parameters stored in the corresponding document files are used.

The first step of the evaluation is a linearization of the filtered input signal to account for the compression characteristics of the detector diode. The compensation depends on the input signal, the diode type and the DC-transmission factor from the diode to the evaluation electronics. If the exciting field is pulsed, the crest factor of the signal must be known to correctly compensate for peak power.

The formula for each channel can be given as:

$$V_i = U_i + U_i^2 \cdot \frac{cf}{dcp_i}$$

With V_i = compensated signal of channel i, (i = x, y, z)
 U_i = input signal of channel i, (i = x, y, z)
 cf = crest factor of exciting field (DASY parameter)
 dcp_i = diode compression point (DASY parameter)

From the compensated input signals, the primary field data for each channel can be evaluated:

$$\text{E- Field Probes: } E_i = \sqrt{\frac{V_i}{\text{Norm}_i \cdot \text{ConvF}}}$$

$$\text{H-Field Probes: } H_i = \sqrt{V_i} \cdot \frac{a_{i0} + a_{i1}f + a_{i2}f^2}{f}$$

With V_i = compensated signal of channel i, (i = x, y, z)
 Norm_i = sensor sensitivity of channel i, (i = x, y, z), $\mu\text{V}/(\text{V/m})^2$
 ConvF = sensitivity enhancement in solution
 a_{ij} = sensor sensitivity factors for H-field probes
 f = carrier frequency (GHz)
 E_i = electric field strength of channel i in V/m
 H_i = magnetic field strength of channel i in A/m

The RSS value of the field components gives the total field strength (Hermitian magnitude):

$$E_{tot} = \sqrt{E_x^2 + E_y^2 + E_z^2}$$

The primary field data are used to calculate the derived field units.

$$SAR = E_{tot}^2 \cdot \frac{\sigma}{\rho \cdot 1000}$$

With SAR = local specific absorption rate in mW/g
 E_{tot} = total field strength in V/m
 σ = conductivity in (mho/m) or (Siemens/m)
 ρ = equipment tissue density in g/cm^3

Note that the density is set to 1, to account for actual head tissue density rather than the density of the tissue simulating liquid.

8.9 Test Equipment List

Manufacturer	Equipment Description	Model	S/N	Cal. Information	
				Last Cal.	Due Date
SPEAG	750MHz System Validation Kit	D750V3	1118	06.10.2014	06.09.2017
SPEAG	900MHz System Validation Kit	D900V2	1d086	08.09.2013	08.08.2016
SPEAG	1750MHz System Validation Kit	D1750V2	1021	08.02.2013	08.01.2016
SPEAG	1900MHz System Validation Kit	D1900V2	5d194	01.07.2015	01.06.2018
SPEAG	2450MHz System Validation Kit	D2450V2	955	01.08.2015	01.07.2018
SPEAG	2600MHz System Validation Kit	D2600V2	1114	09.21.2015	09.20.2018
SPEAG	Data Acquisition Electronics	DAE4	1373	02.11.2016	02.10.2017
SPEAG	Dosimetric E-Field Probe	EX3DV4	3924	07.10.2015	07.09.2016
SPEAG	Phantom	Twin Phantom	1765	N.C.R	
SPEAG	Phantom	ELI V5.0	1208	N.C.R	
SPEAG	Phone Positioner	N/A	N/A	N.C.R	
Stäubli	Robot	TX60L	F13/5P6VB1/A/01	N.C.R	
R&S	Universal Radio Communication Tester	CMU200	116766	03.24.2016	03.24.2017
R&S	Universal Radio Communication Tester	CMU200	117042	03.31.2016	03.31.2017
HP	Network Analyzer	8753D	3410A06291	03.24.2016	03.24.2017
Agilent	EPM Series Power Meter	E4418B	GB39512692	03.24.2016	03.24.2017
Agilent	Power Sensor	8481A	MY41090341	03.24.2016	03.24.2017
Agilent	MAX Signal Analyzer	N9020A	MY50510123	03.24.2016	03.24.2017
R&S	Signal Generator	SMX	835457/016	03.24.2016	03.24.2017
R&S	Signal Generator	SMR20	10080050	03.24.2016	03.24.2017
Huber Suhner	RF Cable	SUCOFLEX	12341	See Note 3	
Huber Suhner	RF Cable	SUCOFLEX	17268	See Note 3	
Huber Suhner	RF Cable	SUCOFLEX	2080	See Note 3	
Weinschel	Attenuator	23-3-34	BL5513	See Note 3	
Anritsu	Directional Coupler	MP654A	100217491	See Note 3	
SPEAG	Dielectric Assessment Kit	3.5 Probe	1119	See Note 4	
Mini-circuits	Power amplifier	ZHL-42W	SC609401309	See Note 5	

Note:

1. The calibration certificate of DASY can be referred to appendix C of this report.
2. Referring to KDB 865664 D01v01r04, the dipole calibration interval can be extended to 3 years with justification. The dipoles are also not physically damaged, or repaired during the interval.
3. The Insertion Loss calibration of Dual Directional Coupler and Attenuator were characterized via the network analyzer and compensated during system check.
4. The dielectric probe kit was calibrated via the network analyzer, with the specified procedure (calibrated in pure water) and calibration kit (standard) short circuit, before the dielectric measurement. The specific procedure and calibration kit are provided by Speag.
5. In system check we need to monitor the level on the power meter, and adjust the power amplifier level to have precise power level to the dipole; the measured SAR will be normalized to 1 W input power according to the ratio of 1 W to the input power to the dipole. For system check, the calibration of the power amplifier is deemed not critically required for correct measurement; the power meter is critical and we do have calibration for it
6. Attenuator insertion loss is calibrated by the network Analyzer, which the calibration is valid, before system check.
7. N.C.R means No Calibration Requirement.

9 Tissue Simulating Liquids

For the measurement of the field distribution inside the SAM phantom with DASY, the phantom must be filled with around 25 liters of homogeneous body tissue simulating liquid. For head SAR testing, the liquid height from the ear reference point (ERP) of the phantom to the liquid top surface is larger than 15 cm, which is shown in Fig. 9.1, for body SAR testing, the liquid height from the center of the flat phantom to liquid top surface is larger than 15 cm, which is shown in Fig. 9.2.

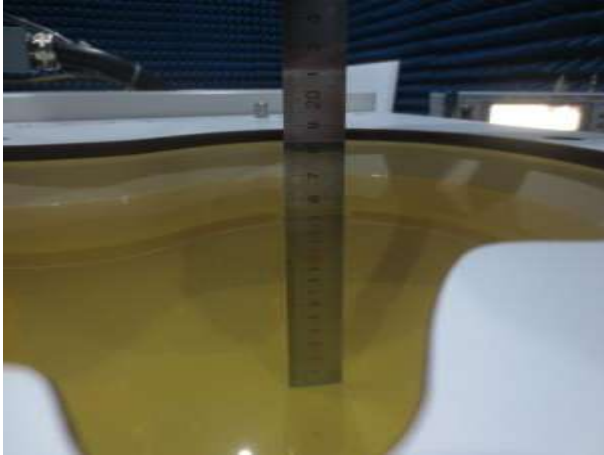

Fig. 9.1 Photo of Liquid Height for Head SAR (700MHz~1000MHz) (depth>15cm)

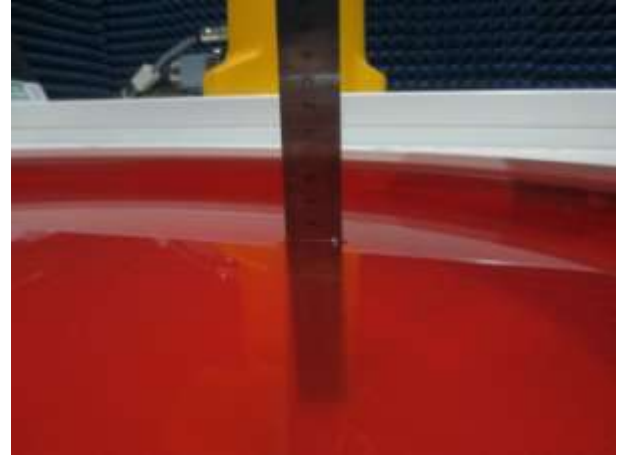

Fig. 9.2 Photo of Liquid Height for Body SAR of (700MHz~1000MHz) (depth>15cm)

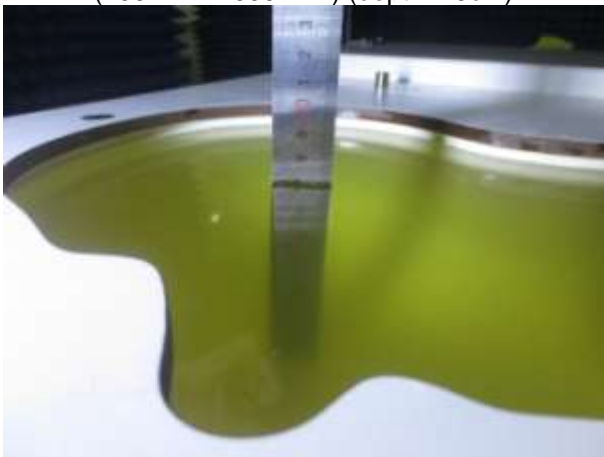

Fig. 9.3 Photo of Liquid Height for Head SAR (1700MHz~1900MHz) (depth>15cm)

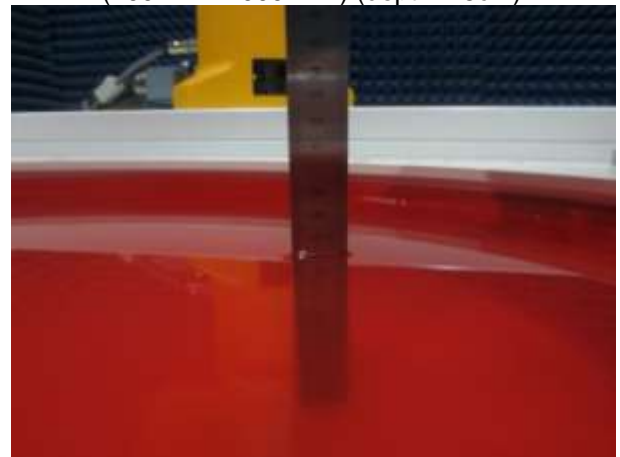

Fig. 9.4 Photo of Liquid Height for Body SAR of ELI V5.0 (1700MHz~1900MHz) (depth>15cm)

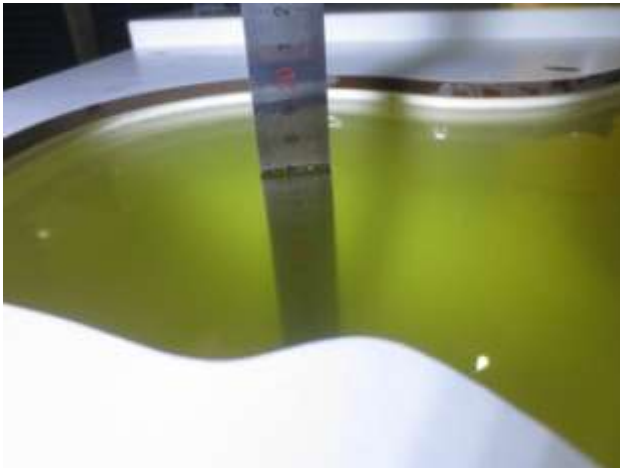

Fig. 9.5 Photo of Liquid Height for Head SAR (2000MHz~2600MHz) (depth>15cm)

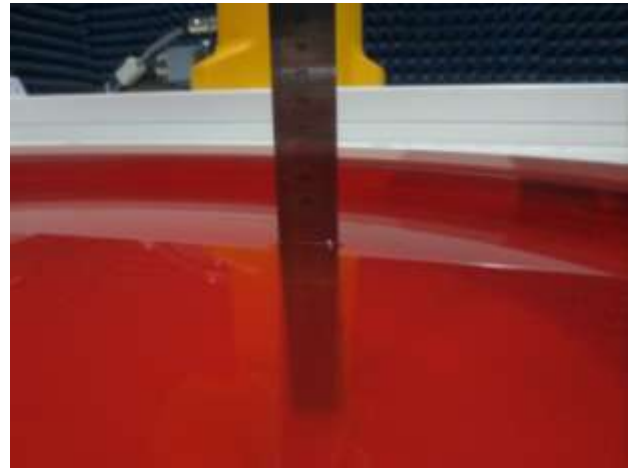

Fig. 9.6 Photo of Liquid Height for Body SAR of Twin Phantom (2000MHz~2600MHz) (depth>15cm)

The relative permittivity and conductivity of the tissue material should be within $\pm 5\%$ of the values given in the table below recommended by the FCC OET 65 supplement C and RSS 102 Issue 5.

Target Frequency (MHz)	Head		Body	
	ϵ_r	σ (S/m)	ϵ_r	σ (S/m)
150	52.3	0.76	61.9	0.80
300	45.3	0.87	58.2	0.92
450	43.5	0.87	56.7	0.94
835	41.5	0.90	55.2	0.97
900	41.5	0.97	55.0	1.05
915	41.5	0.98	55.0	1.06
1450	40.5	1.20	54.0	1.30
1610	40.3	1.29	53.8	1.40
1800-2000	40.0	1.40	53.3	1.52
2450	39.2	1.80	52.7	1.95
3000	38.5	2.40	52.0	2.73
5800	35.3	5.27	48.2	6.00

(ϵ_r = relative permittivity, σ = conductivity and $\rho = 1000 \text{ kg/m}^3$)

The dielectric parameters of liquids were verified prior to the SAR evaluation using a Speag Dielectric Probe Kit and an Agilent Network Analyzer.

The following table shows the measuring results for simulating liquid.

Frequency (MHz)	Liquid Type	Liquid Temp. (°C)	Conductivity (σ)	Permittivity (ϵ_r)	Conductivity Target(σ)	Permittivity Target(ϵ_r)	Delta (σ)%	Delta (ϵ_r)%	Limit (%)	Date (mm/dd/yy)
750	Head	21.6	0.87	42.14	0.89	41.9	-2.25	0.57	±5	07.03.2016
835	Head	21.5	0.90	42.12	0.9	41.5	0.00	1.49	±5	07.01.2016
1750	Head	21.4	1.39	38.91	1.37	40.1	1.46	-2.97	±5	07.05.2016
1900	Head	21.4	1.42	40.06	1.4	40.0	1.43	0.15	±5	07.05.2016
2450	Head	21.0	1.82	38.92	1.8	39.2	1.11	-0.71	±5	07.07.2016
2600	Head	21.0	2.00	38.05	1.96	39.0	2.04	-2.44	±5	07.07.2016
750	Body	21.5	0.97	54.90	0.96	55.5	1.04	-1.08	±5	07.03.2016
835	Body	21.6	0.99	53.62	0.97	55.2	2.06	-2.86	±5	07.02.2016
1750	Body	21.8	1.50	52.34	1.49	53.4	0.67	-1.99	±5	07.04.2016
1900	Body	21.8	1.52	53.46	1.52	53.3	0.00	0.30	±5	07.04.2016
2450	Body	21.3	1.96	53.10	1.95	52.7	0.51	0.76	±5	07.06.2016
2600	Body	21.0	2.15	52.36	2.16	52.5	-0.46	-0.27	±5	07.07.2016

10 SAR System Verification

Each DASY system is equipped with one or more system validation kits. These units, together with the predefined measurement procedures within the DASY software, enable the user to conduct the system performance check and system validation. System validation kit includes a dipole, tripod holder to fix it underneath the flat phantom and a corresponding distance holder.

➤ **Purpose of System Performance check**

The system performance check verifies that the system operates within its specifications. System and operator errors can be detected and corrected. It is recommended that the system performance check be performed prior to any usage of the system in order to guarantee reproducible results. The system performance check uses normal SAR measurements in a simplified setup with a well characterized source. This setup was selected to give a high sensitivity to all parameters that might fail or vary over time. The system check does not intend to replace the calibration of the components, but indicates situations where the system uncertainty is exceeded due to drift or failure.

➤ **System Setup**

In the simplified setup for system evaluation, the EUT is replaced by a calibrated dipole and the power source is replaced by a continuous wave that comes from a signal generator. The calibrated dipole must be placed beneath the flat phantom section of the SAM twin phantom with the correct distance holder. The distance holder should touch the phantom surface with a light pressure at the reference marking and be oriented parallel to the long side of the phantom. The equipment setup is shown below:

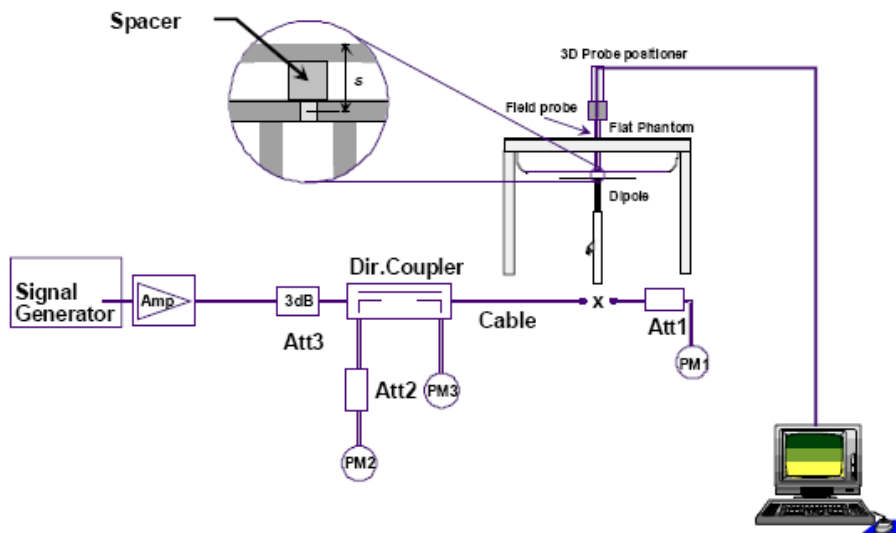

Fig.10.1 System Verification Setup Diagram



Fig.10.2 Photo of Dipole setup

➤ **System Verification Results**

Comparing to the original SAR value provided by SPEAG, the verification data should be within its specification of 10%. The table as below indicates the system performance check can meet the variation criterion and the plots can be referred to Appendix C of this report.

Date (mm/dd/yy)	Frequency (MHz)	Liquid Type	Power fed onto dipole (mW)	Measured 1g SAR (W/kg)	Normalized to 250 mW 1g SAR (W/kg)	250 mW Target 1g SAR (W/kg)	Deviation (%)
07.03.2016	750	Head	80	0.672	2.10	2.09	0.48
07.01.2016	900	Head	80	0.833	2.60	2.67	-2.62
07.05.2016	1750	Head	40	1.38	8.63	8.54	1.05
07.05.2016	1900	Head	40	1.65	10.31	10.1	2.08
07.07.2016	2450	Head	40	2.16	13.50	13.2	2.27
07.07.2016	2600	Head	40	2.27	14.19	14.5	-2.14
07.03.2016	750	Body	80	0.718	2.24	2.19	2.28
07.02.2016	900	Body	80	0.818	2.56	2.63	-2.66
07.04.2016	1750	Body	40	1.48	9.25	9.52	-2.84
07.04.2016	1900	Body	40	1.66	10.38	9.95	4.32
07.06.2016	2450	Body	40	2.15	13.44	13.8	-2.61
07.07.2016	2600	Body	40	2.22	13.88	13.7	1.31

11 EUT Testing Position

This EUT was tested in ten different positions. They are right cheek/right tilted/left cheek/left tilted for head, Front/Back/Right Side/Top Side/Bottom Side of the EUT with phantom 1 cm gap, as illustrated below, please refer to Appendix B for the test setup photos.

11.1 Handset Reference Points

- The vertical centreline passes through two points on the front side of the handset – the midpoint of the width w_t of the handset at the level of the acoustic output, and the midpoint of the width w_b of the bottom of the handset.
- The horizontal line is perpendicular to the vertical centreline and passes the center of the acoustic output. The horizontal line is also tangential to the handset at point A.
- The two lines intersect at point A. Note that for many handsets, point A coincides with the center of the acoustic output; however, the acoustic output may be located elsewhere on the horizontal line. Also note that the vertical centreline is not necessarily parallel to the front face of the handset, especially for clamshell handsets, handsets with flip covers, and other irregularly shaped handsets.



Fig.11.1 Illustration for Front, Back and Side of SAM Phantom

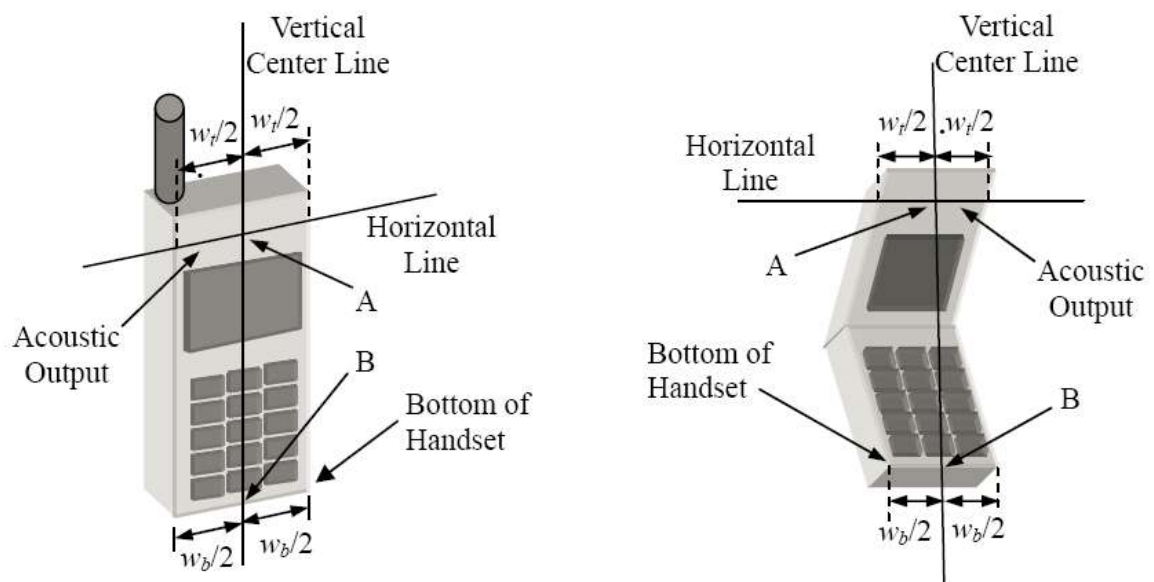

Fig. 11.2 Illustration for Handset Vertical and Horizontal Reference Lines

11.2 Positioning for Cheek / Touch

- To position the device with the vertical center line of the body of the device and the horizontal line crossing the center piece in a plane parallel to the sagittal plane of the phantom. While maintaining the device in this plane, align the vertical center line with the reference plane containing the three ear and mouth reference point (M: Mouth, RE: Right Ear and LE: Left Ear) and align the center of the ear piece with the line RE-LE.
- To move the device towards the phantom with the ear piece aligned with the line LE-RE until the phone touched the ear. While maintaining the device in the reference plane and maintaining the phone contact with the ear, move the bottom of the phone until any point on the front side is in contact with the cheek of the phantom or until contact with the ear is lost (see below figure)



Fig. 11.3 Illustration for Cheek Position

11.3 Positioning for Ear / 15° Tilt

- To position the device in the “cheek” position described above.
- While maintaining the device the reference plane described above and pivoting against the ear, moves it outward away from the mouth by an angle of 15 degrees or until contact with the ear is lost (see figure below).



Fig.11.4 Illustration for Tilted Position

11.4 SAR Evaluations near the Mouth/Jaw Regions of the SAM Phantom

Antennas located near the bottom of a phone may require SAR measurements around the mouth and jaw regions of the SAM head phantom. This typically applies to clam-shell style phones that are generally longer in the unfolded normal use positions or to certain older style long rectangular phones.

Under these circumstances, the following procedures apply, adopted from the FCC guidance on SAR handsets document FCC KDB Publication 648474 D04v01r03. The SAR required in these regions of SAM should be measured using a flat phantom. The phone should be positioned with a separation distance of 4 mm between the ear reference point (ERP) and the outer surface of the flat phantom shell. While maintaining this distance at the ERP location, the low (bottom) edge of the phone should be lowered from the phantom to establish the same separation distance between the peak SAR locations identified by the truncated partial SAR distribution measured with the SAM phantom. The distance from the peak SAR location to the phone is determined by the straight line passing perpendicularly through the phantom surface. When it is not feasible to maintain 4 mm separation at the ERP while also establishing the required separation at the peak SAR location, the top edge of the phone will be allowed to touch the phantom with a separation < 4 mm at the ERP. The phone should not be tilted to the left or right while placed in this inclined position to the flat phantom.

11.5 Body Worn Accessory Configurations

- To position the device parallel to the phantom surface with either keypad up or down.
- To adjust the device parallel to the flat phantom.
- To adjust the distance between the device surface and the flat phantom to 1.5 cm or holster surface and the flat phantom to 0 cm.

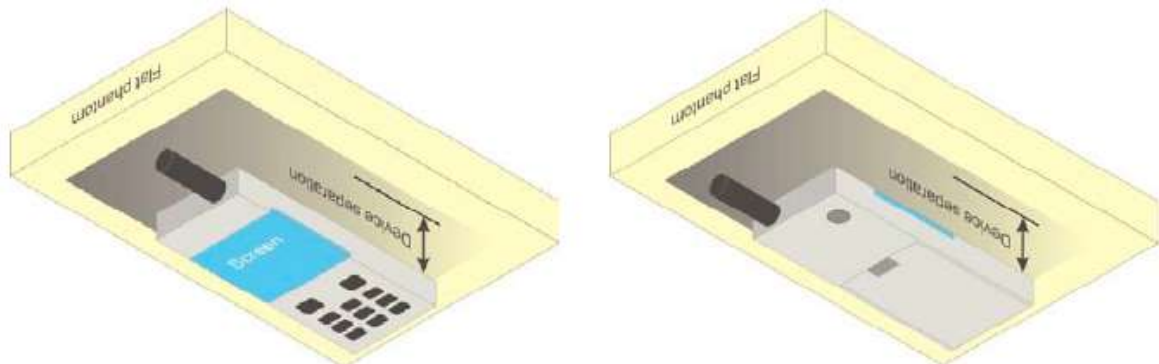

Fig.11.5 Illustration for Body Worn Position

11.6 Wireless Router (Hotspot) Configurations

Some battery-operated handsets have the capability to transmit and receive internet connectivity through simultaneous transmission of WIFI in conjunction with a separate licensed transmitter. The FCC has provided guidance in KDB Publication 941225 D06 where SAR test considerations for handsets ($L \times W \geq 9 \text{ cm} \times 5 \text{ cm}$) are based on a composite test separation distance of 10 mm from the front, back and edges of the device with antennas 2.5 cm or closer to the edge of the device, determined from general mixed use conditions for this type of devices. Since the hotspot SAR results may overlap with the body-worn accessory SAR requirements, the more conservative configurations can be considered, thus excluding some body-worn accessory SAR tests.

When the user enables the personal wireless router functions for the handset, actual operations include simultaneous transmission of both the WIFI transmitter and another licensed transmitter. Both transmitters often do not transmit at the same transmitting frequency and thus cannot be evaluated for SAR under actual use conditions. Therefore, SAR must be evaluated for each frequency transmission and mode separately and summed with the WIFI transmitter according to KDB 648474 publication procedures. The "Portable Hotspot" feature on the handset was NOT activated, to ensure the SAR measurements were evaluated for a single transmission frequency RF signal.

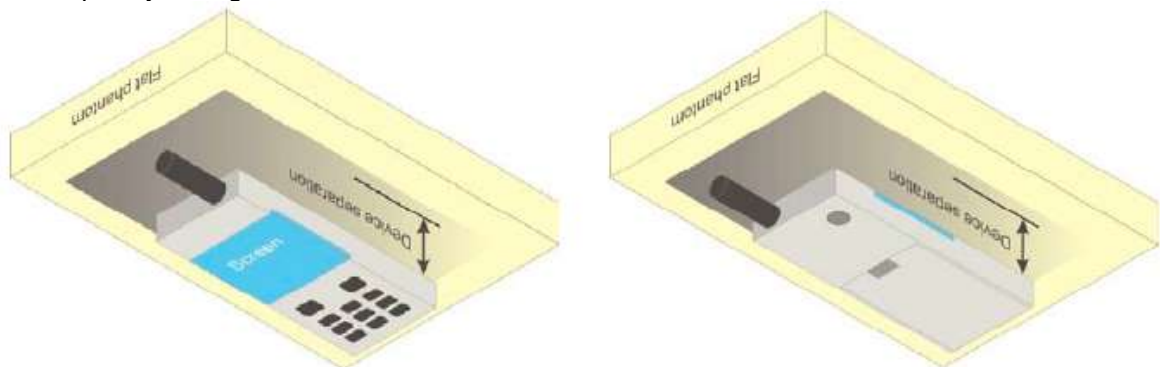

Fig.11.6 Illustration for Hotspot Position

12 Measurement Procedures

The measurement procedures are as follows:

<Conducted power measurement>

- For WWAN power measurement, use base station simulator to configure EUT WWAN transition in conducted connection with RF cable, at maximum power in each supported wireless interface and frequency band.
- Read the WWAN RF power level from the base station simulator.
- For WLAN/BT power measurement, use engineering software to configure EUT WLAN/BT continuously transmission, at maximum RF power in each supported wireless interface and frequency band.
- Connect EUT RF port through RF cable to the power meter or spectrum analyzer, and measure WLAN/BT output power.

<Conducted power measurement>

- Use base station simulator to configure EUT WWAN transmission in radiated connection, and engineering software to configure EUT WLAN/BT continuously transmission, at maximum RF power, in the highest power channel.
- Place the EUT in positions as Appendix B demonstrates.
- Set scan area, grid size and other setting on the DASY software.
- Measure SAR results for the highest power channel on each testing position.
- Find out the largest SAR result on these testing positions of each band.
- Measure SAR results for other channels in worst SAR testing position if the Reported SAR or highest power channel is larger than 0.8 W/kg.

According to the test standard, the recommended procedure for assessing the peak spatial-average SAR value consists of the following steps:

- Power reference measurement
- Area scan
- Zoom scan
- Power drift measurement

12.1 Spatial Peak SAR Evaluation

The procedure for spatial peak SAR evaluation has been implemented according to the test standard. It can be conducted for 1g and 10g, as well as for user-specific masses. The DASY software includes all numerical procedures necessary to evaluate the spatial peak SAR value.

The base for the evaluation is a “cube” measurement. The measured volume must include the 1g and 10 g cubes with the highest averaged SAR values. For that purpose, the center of the measured volume is aligned to the interpolated peak SAR value of a previously performed area scan.

The entire evaluation of the spatial peak values is performed within the post-processing engine (SEMCAD). The system always gives the maximum values for 1g and 10g cubes. The algorithm to find the cube with highest averaged SAR is divided into the following stages:

- Extraction of the measured data (grid and values) from the Zoom Scan.
- Calculation of the SAR value at every measurement point based on all stored data (A/D values and measurement parameters).
- Generation of a high-resolution mesh within the measured volume.
- Interpolation of all measured values from the measurement grid to the high-resolution grid
- Extrapolation of the entire 3-D field distribution to the phantom surface over the distance from sensor to surface
- Calculation of the averaged SAR within masses of 1g and 10g.

12.2 Power Reference Measurement

The Power Reference Measurement and Power Drift Measurement are for monitoring the power drift of the device under test in the batch process. The minimum distance of probe sensors to surface determines the closest measurement point to phantom surface. This distance cannot be smaller than the distance of sensor calibration points to probe tip as defined in the probe properties.

12.3 Area & Zoom Scan Procedures

First Area Scan is used to locate the approximate location(s) of the local peak SAR value(s). The measurement grid within an Area Scan is defined by the grid extent, grid step size and grid offset. Next, in order to determine the EM field distribution in a three-dimensional spatial extension, Zoom Scan is required. The Zoom Scan is performed around the highest E-field value to determine the averaged SAR-distribution over 10g. Area scan and zoom scan resolution setting follows KDB 865664 D01v01r04 quoted below.

		≤ 3 GHz	> 3 GHz	
Maximum distance from closest measurement point (geometric center of probe sensors) to phantom surface		5 ± 1 mm	$\frac{1}{2} \cdot \delta \cdot \ln(2) \pm 0.5$ mm	
Maximum probe angle from probe axis to phantom surface normal at the measurement location		$30^\circ \pm 1^\circ$	$20^\circ \pm 1^\circ$	
Maximum area scan spatial resolution: $\Delta x_{Area}, \Delta y_{Area}$		≤ 2 GHz: ≤ 15 mm 2 – 3 GHz: ≤ 12 mm	3 – 4 GHz: ≤ 12 mm 4 – 6 GHz: ≤ 10 mm	
		When the x or y dimension of the test device, in the measurement plane orientation, is smaller than the above, the measurement resolution must be \leq the corresponding x or y dimension of the test device with at least one measurement point on the test device.		
Maximum zoom scan spatial resolution: $\Delta x_{Zoom}, \Delta y_{Zoom}$		≤ 2 GHz: ≤ 8 mm 2 – 3 GHz: ≤ 5 mm*	3 – 4 GHz: ≤ 5 mm* 4 – 6 GHz: ≤ 4 mm*	
Maximum zoom scan spatial resolution, normal to phantom surface	uniform grid: $\Delta z_{Zoom}(n)$	≤ 5 mm	3 – 4 GHz: ≤ 4 mm 4 – 5 GHz: ≤ 3 mm 5 – 6 GHz: ≤ 2 mm	
	graded grid	$\Delta z_{Zoom}(1)$: between 1 st two points closest to phantom surface	≤ 4 mm	3 – 4 GHz: ≤ 3 mm 4 – 5 GHz: ≤ 2.5 mm 5 – 6 GHz: ≤ 2 mm
		$\Delta z_{Zoom}(n>1)$: between subsequent points	$\leq 1.5 \cdot \Delta z_{Zoom}(n-1)$	
Minimum zoom scan volume	x, y, z	≥ 30 mm	3 – 4 GHz: ≥ 28 mm 4 – 5 GHz: ≥ 25 mm 5 – 6 GHz: ≥ 22 mm	
Note: δ is the penetration depth of a plane-wave at normal incidence to the tissue medium; see draft standard IEEE P1528-2011 for details. * When zoom scan is required and the <i>reported</i> SAR from the <i>area scan based 1-g SAR estimation</i> procedures of KDB 447498 is ≤ 1.4 W/kg, ≤ 8 mm, ≤ 7 mm and ≤ 5 mm zoom scan resolution may be applied, respectively, for 2 GHz to 3 GHz, 3 GHz to 4 GHz and 4 GHz to 6 GHz.				

12.4 Volume Scan Procedures

The volume scan is used for assess overlapping SAR distributions for antennas transmitting in different frequency bands. It is equivalent to an oversized zoom scan used in standalone measurements. The measurement volume will be used to enclose all the simultaneous transmitting antennas. For antennas transmitting simultaneously in different frequency bands, the volume scan is measured separately in each frequency band. In order to sum correctly to compute the 1g aggregate SAR, the EUT remain in the same test position for all measurements and all volume scan use the same spatial resolution and grid spacing. When all volume scan were completed, the software, SEMCAD post-processor scan combine and subsequently superpose these measurement data to calculating the multiband SAR.

12.5 SAR Averaged Methods

In DASYS, the interpolation and extrapolation are both based on the modified Quadratic Shepard's method. The interpolation scheme combines a least-square fitted function method and a weighted average method which are the two basic types of computational interpolation and approximation.

Extrapolation routines are used to obtain SAR values between the lowest measurement points and the inner phantom surface. The extrapolation distance is determined by the surface detection distance and the probe sensor offset. The uncertainty increases with the extrapolation distance. To keep the uncertainty within 1% for the 1g and 10g cubes, the extrapolation distance should not be larger than 5 mm.

12.6 Power Drift Monitoring

All SAR testing is under the EUT install full charged battery and transmit maximum output power. In DASYS measurement software, the power reference measurement and power drift measurement procedures are used for monitoring the power drift of EUT during SAR test. Both these procedures measure the field at a specified reference position before and after the SAR testing. The software will calculate the field difference in dB. If the power drifts more than 5%, the SAR will be retested.

13 Conducted RF Output Power

13.1 GSM Conducted Power

Band: GSM 850 Channel	Burst Average Power (dBm)			Frame-Average Power(dBm)		
	128	190	251	128	190	251
Frequency (MHz)	824.2	836.6	848.8	824.2	836.6	848.8
GSM (GMSK, Voice)	31.68	31.74	31.74	22.65	22.71	22.71
GPRS (GMSK, 1 TX slot)	31.59	31.72	31.71	22.56	22.69	22.68
GPRS (GMSK, 2 TX slots)	30.99	31.07	31.07	24.97	25.05	25.05
GPRS (GMSK, 3 TX slots)	29.31	29.38	29.38	25.05	25.12	25.12
GPRS (GMSK, 4 TX slots)	28.14	28.23	28.22	25.13	25.22	25.21
EGPRS (8PSK, 1 TX slot)	26.46	26.31	26.25	17.43	17.28	17.22
EGPRS (8PSK, 2 TX slots)	25.36	25.26	25.14	19.34	19.24	19.12
EGPRS (8PSK, 3 TX slots)	23.27	23.07	23.03	19.01	18.81	18.77
EGPRS (8PSK, 4 TX slots)	22.09	21.86	21.86	19.08	18.85	18.85

Remark:

- The frame-averaged power is linearly reported the maximum burst averaged power over 8 time slots. The calculated method are shown as below:
The duty cycle "x" of different time slots as below:
1 TX slot is 1/8, 2 TX slots is 2/8, 3 TX slots is 3/8 and 4 TX slots is 4/8
Based on the calculation formula:
Frame-averaged power = Burst averaged power + 10 log (x)
So,
Frame-averaged power (1 TX slot) = Burst averaged power (1 TX slot) – 9.03
Frame-averaged power (2 TX slots) = Burst averaged power (2 TX slots) – 6.02
Frame-averaged power (3 TX slots) = Burst averaged power (3 TX slots) – 4.26
Frame-averaged power (4 TX slots) = Burst averaged power (4 TX slots) – 3.01
- CS1 coding scheme was used in GPRS conducted power measurements and SAR testing, MCS5 coding scheme was used in EGPRS conducted power measurements and SAR testing (if necessary).

Note:

- For Head SAR testing, GSM Voice mode should be evaluated, therefore the EUT was set in GSM 850 Voice mode.
- For Body worn SAR testing, GSM Voice mode should be evaluated, therefore the EUT was set in GSM 850 Voice mode.
- For Hotspot mode SAR testing, GPRS and EGPRS mode should be evaluated, therefore the EUT was set in GPRS 4 TX slots mode due to the highest frame-averaged power.
- Per KDB447498 D01v06, the maximum output power channel is used for SAR testing and for further SAR test reduction.
- The EUT do not support DTM and VoIP function.

Band: GSM 1900	Burst Average Power (dBm)			Frame-Average Power(dBm)		
Channel	512	661	810	512	661	810
Frequency (MHz)	1850.2	1880.0	1909.8	1850.2	1880.0	1909.8
GSM (GMSK, Voice)	28.70	28.53	28.48	19.67	19.50	19.45
GPRS (GMSK, 1 TX slot)	28.69	28.51	28.47	19.66	19.48	19.44
GPRS (GMSK, 2 TX slots)	28.06	27.90	27.83	22.04	21.88	21.81
GPRS (GMSK, 3 TX slots)	26.41	26.25	26.21	22.15	21.99	21.95
GPRS (GMSK, 4 TX slots)	25.35	25.15	25.12	22.34	22.14	22.11
EGPRS (8PSK, 1 TX slot)	23.80	23.81	23.75	14.77	14.78	14.72
EGPRS (8PSK, 2 TX slots)	22.44	22.41	22.32	16.42	16.39	16.30
EGPRS (8PSK, 3 TX slots)	21.94	21.87	21.82	17.68	17.61	17.56
EGPRS (8PSK, 4 TX slots)	20.80	20.65	20.64	17.79	17.64	17.63

Remark:

- The frame-averaged power is linearly reported the maximum burst averaged power over 8 time slots. The calculated method are shown as below:
 The duty cycle "x" of different time slots as below:
 1 TX slot is 1/8, 2 TX slots is 2/8, 3 TX slots is 3/8 and 4 TX slots is 4/8
 Based on the calculation formula:
 Frame-averaged power = Burst averaged power + 10 log (x)
 So,
 Frame-averaged power (1 TX slot) = Burst averaged power (1 TX slot) – 9.03
 Frame-averaged power (2 TX slots) = Burst averaged power (2 TX slots) – 6.02
 Frame-averaged power (3 TX slots) = Burst averaged power (3 TX slots) – 4.26
 Frame-averaged power (4 TX slots) = Burst averaged power (4 TX slots) – 3.01
- CS1 coding scheme was used in GPRS conducted power measurements and SAR testing, MCS5 coding scheme was used in EGPRS conducted power measurements and SAR testing (if necessary).

Note:

- For Head SAR testing, GSM Voice mode should be evaluated, therefore the EUT was set in GSM 1900 Voice mode.
- For Body worn SAR testing, GSM Voice mode should be evaluated, therefore the EUT was set in GSM Voice 1900 mode.
- For Hotspot mode SAR testing, GPRS and EGPRS mode should be evaluated, therefore the EUT was set in GPRS 4 TX slots mode due to the highest frame-averaged power.
- Per KDB447498 D01v06, the maximum output power channel is used for SAR testing and for further SAR test reduction.
- The EUT do not support DTM and VoIP function.

13.2 WCDMA Conducted Power

The following tests were conducted according to the test requirements outlines in 3GPP TS 34.121 specification. A summary of these settings are illustrated below:

HSDPA Setup Configuration:

- a. The EUT was connected to Base Station Rohde & Schwarz CMU200 referred to the Setup Configuration.
- b. The RF path losses were compensated into the measurements.
- c. A call was established between EUT and Base Station with following setting:
 - i. Set Gain Factors (β_c and β_d) and parameters were set according to each
 - ii. Specific sub-test in the following table, C10.1.4, quoted from the TS 34.121
 - iii. Set RMC 12.2kbps + HSDPA mode.
 - iv. Set Cell Power = -86 dBm
 - v. Set HS-DSCH Configuration Type to FRC (H-set 1, QPSK)
 - vi. Select HSDPA Uplink Parameters
 - vii. Set Delta ACK, Delta NACK and Delta CQI = 8
 - viii. Set Ack-Nack Repetition Factor to 3
 - ix. Set CQI Feedback Cycle (k) to 4 ms
 - x. Set CQI Repetition Factor to 2
 - xi. Power Ctrl Mode = All Up bits
- d. The transmitted maximum output power was recorded.

Table 1

Sub-test	β_c	β_d	β_d (SF)	β_c/β_d	$\beta_{hs}^{(1)}$	CM (dB) ⁽²⁾
1	2/15	15/15	64	2/15	4/15	0.0
2	12/15 ⁽³⁾	15/15 ⁽³⁾	64	12/15 ⁽³⁾	24/15	1.0
3	15/15	8/15	64	15/8	30/15	1.5
4	15/15	4/15	64	15/4	30/15	1.5

Note 1: $\Delta_{ACK}, \Delta_{NACK}$ and $\Delta_{CQI} = 8 \Leftrightarrow A_{hs} = \beta_{hs}/\beta_c = 30/15 \Leftrightarrow \beta_{hs} = 30/15 * \beta_c$

Note 2: CM = 1 for $\beta_c/\beta_d = 12/15, \beta_{hs}/\beta_c = 24/15$.

Note 3: For subtest 2 the β_c/β_d ratio of 12/15 for the TFC during the measurement period (TF1, TF0) is achieved by setting the signaled gain factors for the reference TFC (TF1, TF1) to $\beta_c = 11/15$ and $\beta_d = 15/15$.

HSDPA Sub-test setup configuration

HSUPA Setup Configuration:

- a. The EUT was connected to Base Station Rohde & Schwarz CMU200 referred to the Setup Configuration.
- b. The RF path losses were compensated into the measurements.
- c. A call was established between EUT and Base Station with following setting * :
 - i. Call Configs = 5.2B, 5.9B, 5.10B, and 5.13.2B with QPSK
 - ii. Set the Gain Factors (β_c and β_d) and parameters (AG Index) were set according to each specific sub-test in the following table, C11.1.3, quoted from the TS 34.121
 - iii. Set Cell Power = -86 dBm
 - iv. Set Channel Type = 12.2k + HSPA
 - v. Set UE Target Power
 - vi. Power Ctrl Mode= Alternating bits
 - vii. Set and observe the E-TFCI
 - viii. Confirm that E-TFCI is equal to the target E-TFCI of 75 for sub-test 1, and other subtest's E-TFCI
- d. The transmitted maximum output power was recorded.

Table 2

Sub-test	β_c	β_d	β_d (SF)	β_c/β_d	$\beta_{hs}^{(1)}$	β_{ec}	β_{ed}	β_{ed} (SF)	β_{ed} (codes)	CM ⁽²⁾ (dB)	MPR (dB)	AG ⁽⁴⁾ Index	E-TFCI
1	11/15 ⁽³⁾	15/15 ⁽³⁾	64	11/15 ⁽³⁾	22/15	209/225	1039/225	4	1	1.0	0.0	20	75
2	6/15	15/15	64	6/15	12/15	12/15	94/75	4	1	3.0	2.0	12	67
3	15/15	9/15	64	15/9	30/15	30/15	$\beta_{ed1}: 47/15$ $\beta_{ed2}: 47/15$	4	2	2.0	1.0	15	92
4	2/15	15/15	64	2/15	4/15	2/15	56/75	4	1	3.0	2.0	17	71
5	15/15 ⁽⁴⁾	15/15 ⁽⁴⁾	64	15/15 ⁽⁴⁾	30/15	24/15	134/15	4	1	1.0	0.0	21	81

Note 1: $\Delta_{ACK}, \Delta_{NACK}$ and $\Delta_{CQI} = 8 \Leftrightarrow A_{hs} = \beta_{hs}/\beta_c = 30/15 \Leftrightarrow \beta_{hs} = 30/15 * \beta_c$.

Note 2: CM = 1 for $\beta_c/\beta_d = 12/15, \beta_{hs}/\beta_c = 24/15$. For all other combinations of DPDCH, DPCCH, HS-DPCCH, E-DPDCH and E-DPCCH the MPR is based on the relative CM difference.

Note 3: For subtest 1 the β_c/β_d ratio of 11/15 for the TFC during the measurement period (TF1, TF0) is achieved by setting the signaled gain factors for the reference TFC (TF1, TF1) to $\beta_c = 10/15$ and $\beta_d = 15/15$.

Note 4: For subtest 5 the β_c/β_d ratio of 15/15 for the TFC during the measurement period (TF1, TF0) is achieved by setting the signaled gain factors for the reference TFC (TF1, TF1) to $\beta_c = 14/15$ and $\beta_d = 15/15$.

Note 5: Testing UE using E-DPDCH Physical Layer category 1 Sub-test 3 is not required according to TS 25.306 Table 5.1g.

Note 6: β_{ed} cannot be set directly; it is set by Absolute Grant Value.

HSUPA Sub-test setup configuration

WCDMA Conducted Power:

Band	WCDMA Average power (dBm)					
	WCDMA Band V			WCDMA Band II		
Channel	4132	4183	4233	9262	9400	9538
Frequency (MHz)	826.4	836.6	846.6	1852.4	1880.0	1907.6
AMR 12.2 kbps	21.90	22.57	21.59	21.91	21.26	21.19
RMC 12.2 kbps	22.01	22.58	21.62	21.95	21.30	21.33
HSDPA Sub-test 1	21.09	21.50	20.54	20.78	20.36	20.39
HSDPA Sub-test 2	20.79	21.11	20.28	20.55	19.95	19.88
HSDPA Sub-test 3	19.21	19.43	18.57	18.95	18.49	18.38
HSDPA Sub-test 4	19.36	19.52	18.60	19.03	18.39	18.46
HSUPA Sub-test 1	21.15	21.40	20.51	20.86	20.43	20.55
HSUPA Sub-test 2	21.11	21.39	20.52	20.76	20.30	20.38
HSUPA Sub-test 3	19.25	19.54	18.64	18.87	18.44	18.87
HSUPA Sub-test 4	21.05	21.49	20.56	20.78	20.38	20.41
HSUPA Sub-test 5	20.13	20.43	19.55	19.92	19.48	19.41

Note:

1. Applying the subtest setup in Table C.11.1.3 of 3GPP TS 34.121-1
2. Per KDB 941225 D01, RMC 12.2kbps mode is used to evaluate SAR due the highest output power. If AMR 12.2 kbps power is < 0.25dB higher than RMC 12.2kbps, SAR tests with AMR 12.2 kbps can be excluded.
3. AMR, HSDPA RF power will not be larger than RMC 12.2kbps, detailed information is included in Tune-up Procure exhibit.

13.3 LTE Conducted Power

13.3.1 Largest channel bandwidth standalone SAR test requirements

QPSK with 1 RB allocation

Start with the largest channel bandwidth and measure SAR for QPSK with 1 RB allocation, using the RB offset and required test channel combination with the highest maximum output power among RB offsets at the upper edge, middle and lower edge of each required test channel. When the reported SAR is ≤ 0.8 W/kg, testing of the remaining RB offset configurations and required test channels is not required for 1 RB allocation; otherwise, SAR is required for the remaining required test channels and only for the RB offset configuration with the highest output power for that channel.⁸ When the reported SAR of a required test channel is > 1.45 W/kg, SAR is required for all three RB offset configurations for that required test channel.

QPSK with 50% RB allocation

The procedures required for 1 RB allocation in section 4.2.1 are applied to measure the SAR for QPSK with 50% RB allocation.⁹

QPSK with 100% RB allocation

For QPSK with 100% RB allocation, SAR is not required when the highest maximum output power for 100 % RB allocation is less than the highest maximum output power in 50% and 1 RB allocations and the highest reported SAR for 1 RB and 50% RB allocation in sections 4.2.1 and 4.2.2 are ≤ 0.8 W/kg. Otherwise, SAR is measured for the highest output power channel; and if the reported SAR is > 1.45 W/kg, the remaining required test channels must also be tested.

Higher order modulations

For each modulation besides QPSK; e.g., 16-QAM, 64-QAM, apply the QPSK procedures in sections 4.2.1, 5.2.2 and 4.2.3 to determine the QAM configurations that may need SAR measurement. For each configuration identified as required for testing, SAR is required only when the highest maximum output power for the configuration in the higher order modulation is $> \frac{1}{2}$ dB higher than the same configuration in QPSK or when the reported SAR for the QPSK configuration is > 1.45 W/kg.

13.3.2 Other channel bandwidth standalone SAR test requirements

For the other channel bandwidths used by the device in a frequency band, apply all the procedures required for the largest channel bandwidth in section 4.2 to determine the channels and RB configurations that need SAR testing and only measure SAR when the highest maximum output power of a configuration requiring testing in the smaller channel bandwidth is $> \frac{1}{2}$ dB higher than the equivalent channel configurations in the largest channel bandwidth configuration or the reported SAR of a configuration for the largest channel bandwidth is > 1.45 W/kg. The equivalent channel configuration for the RB allocation, RB offset and modulation etc. is determined for the smaller channel bandwidth according to the same number of RB allocated in the largest channel bandwidth. For example, 50 RB in 10 MHz channel bandwidth does not apply to 5 MHz channel bandwidth; therefore, this cannot be tested in the smaller channel bandwidth. However, 50% RB allocation in 10 MHz channel bandwidth is equivalent to 100% RB allocation in 5 MHz channel bandwidth; therefore, these are the equivalent configurations to be compared to determine the specific channel and configuration in the smaller channel bandwidth that need SAR testing.

LTE Band 2 part

LTE Band	Bandwidth (MHz)	Modulation	RB Size	RB Offset	Average Power (dBm)		
					18607	18900	19193
					1850.7MHz	1880.0MHz	1909.3MHz
Band 2	1.4	QPSK	1	0	22.06	21.44	20.68
			1	2	22.01	21.43	20.60
			1	5	22.02	21.47	20.64
			3	0	22.19	21.55	20.73
			3	1	22.09	21.53	20.68
			3	2	22.11	21.58	20.71
		16QAM	6	0	21.18	20.59	19.82
			1	0	21.15	20.48	19.77
			1	2	21.40	20.58	19.69
			1	5	21.09	19.60	19.92
			3	0	21.27	20.80	19.90
			3	1	21.14	20.56	19.66
			3	2	21.06	20.59	19.82
			6	0	20.25	19.59	18.80

LTE Band	Bandwidth (MHz)	Modulation	RB Size	RB Offset	Average Power (dBm)		
					18615	18900	19185
					1851.5MHz	1880.0MHz	1908.5MHz
Band 2	3	QPSK	1	0	21.82	21.39	20.65
			1	7	21.87	21.41	20.66
			1	14	21.70	21.34	20.56
			8	0	21.04	20.58	20.86
			8	4	20.97	20.51	19.96
			8	7	20.97	20.52	19.88
			15	0	21.00	20.57	19.99
		16QAM	1	0	20.84	20.76	20.77
			1	7	20.95	20.43	20.83
			1	14	20.84	20.48	20.73
			8	0	19.94	19.60	20.15
			8	4	19.92	19.69	19.89
			8	7	20.00	19.51	19.83
			15	0	19.86	19.59	19.95

LTE Band	Bandwidth (MHz)	Modulation	RB Size	RB Offset	Average Power (dBm)		
					18625	18900	19175
					1852.5MHz	1880.0MHz	1907.5MHz
Band 2	5	QPSK	1	0	22.61	22.09	21.39
			1	12	22.45	22.04	21.30
			1	24	22.36	22.07	21.16
			12	0	21.71	21.24	20.55
			12	6	22.07	21.25	20.49
			12	11	21.54	21.23	20.37
			25	0	21.56	21.23	20.49
		16QAM	1	0	21.62	21.56	20.33
			1	12	21.59	21.22	20.35
			1	24	21.37	21.06	20.23
			12	0	20.66	20.22	19.50
			12	6	20.71	20.22	19.45
			12	11	20.44	20.18	19.37
			25	0	20.59	20.17	19.44

LTE Band	Bandwidth (MHz)	Modulation	RB Size	RB Offset	Average Power (dBm)		
					18650	18900	19150
					1855.0MHz	1880.0MHz	1905.0MHz
Band 2	10	QPSK	1	0	22.51	22.17	21.52
			1	24	22.27	21.99	21.37
			1	49	22.22	21.95	21.11
			25	0	21.52	21.18	20.61
			25	12	21.45	21.18	20.52
			25	24	21.36	21.12	20.34
			50	0	21.55	21.21	20.61
		16QAM	1	0	21.91	21.19	20.90
			1	24	21.40	20.86	20.19
			1	49	21.29	21.08	20.14
			25	0	20.52	20.21	19.52
			25	12	20.49	20.10	19.43
			25	24	20.41	20.09	19.38
			50	0	20.53	20.20	19.51

LTE Band	Bandwidth (MHz)	Modulation	RB Size	RB Offset	Average Power (dBm)		
					18675	18900	19125
					1857.5MHz	1880.0MHz	1902.5MHz
Band 2	15	QPSK	1	0	22.48	22.11	21.71
			1	37	22.28	21.96	21.41
			1	74	22.11	21.77	21.25
			36	0	21.52	21.18	20.79
			36	16	21.39	21.13	20.66
			36	35	21.34	21.04	20.45
			75	0	21.46	21.09	20.61
		16QAM	1	0	21.70	21.09	21.00
			1	37	21.05	20.74	20.67
			1	74	20.93	21.46	20.22
			36	0	20.58	20.19	19.75
			36	16	20.38	20.08	19.49
			36	35	20.34	20.28	19.47
			75	0	20.43	20.07	19.55

LTE Band	Bandwidth (MHz)	Modulation	RB Size	RB Offset	Average Power (dBm)		
					18700	18900	19100
					1860.0MHz	1880.0MHz	1900.0MHz
Band 2	20	QPSK	1	0	22.54	22.29	21.94
			1	49	22.12	21.77	21.45
			1	99	21.97	21.80	21.03
			50	0	21.49	21.21	20.80
			50	24	21.37	21.05	20.58
			50	49	21.27	20.96	20.54
			100	0	21.36	21.06	20.63
		16QAM	1	0	21.28	21.43	20.99
			1	49	21.07	20.82	20.61
			1	99	21.64	20.67	20.22
			50	0	20.54	20.12	19.78
			50	24	20.33	20.01	19.59
			50	49	20.23	19.94	19.48
			100	0	20.35	20.07	19.60

LTE Band 4 part

LTE Band	Bandwidth (MHz)	Modulation	RB Size	RB Offset	Average Power (dBm)		
					19957	20175	20393
					1710.7MHz	1732.5MHz	1754.3MHz
Band 4	1.4	QPSK	1	0	22.72	22.72	22.86
			1	2	22.67	22.60	22.82
			1	5	22.77	22.62	22.88
			3	0	22.83	22.69	23.04
			3	1	22.78	22.65	23.01
			3	2	22.84	22.73	23.03
		16QAM	6	0	21.83	21.78	22.07
			1	0	21.85	21.71	22.32
			1	2	21.74	21.67	21.97
			1	5	21.58	22.02	21.99
			3	0	21.88	21.73	22.07
			3	1	21.80	21.81	21.89
			3	2	21.91	21.68	22.09
			6	0	20.78	20.65	21.04

LTE Band	Bandwidth (MHz)	Modulation	RB Size	RB Offset	Average Power (dBm)		
					19965	20175	20385
					1711.5MHz	1732.5MHz	1753.5MHz
Band 4	3	QPSK	1	0	22.63	22.58	22.71
			1	7	22.73	22.63	22.93
			1	14	22.61	22.52	22.93
			8	0	21.40	21.75	21.99
			8	4	22.66	21.75	22.00
			8	7	21.84	21.77	22.03
			15	0	21.88	21.82	21.94
		16QAM	1	0	21.81	21.68	21.89
			1	7	21.82	21.69	22.03
			1	14	21.77	21.57	22.20
			8	0	20.76	20.71	20.98
			8	4	20.74	20.76	21.13
			8	7	20.77	20.77	20.96
			15	0	20.79	20.72	21.04

LTE Band	Bandwidth (MHz)	Modulation	RB Size	RB Offset	Average Power (dBm)		
					19975	20175	20375
					1712.5MHz	1732.5MHz	1752.5MHz
Band 4	5	QPSK	1	0	22.75	22.68	22.81
			1	12	23.67	22.62	22.78
			1	24	23.08	22.56	22.83
			12	0	21.88	21.76	21.94
			12	6	21.86	21.83	21.96
			12	11	21.84	21.77	22.02
			25	0	21.87	21.76	21.97
		16QAM	1	0	21.86	21.76	21.88
			1	12	21.84	21.97	21.77
			1	24	21.76	21.86	21.95
			12	0	20.85	20.73	20.83
			12	6	20.69	20.78	20.84
			12	11	20.78	20.82	21.01
			25	0	20.79	20.76	20.93

LTE Band	Bandwidth (MHz)	Modulation	RB Size	RB Offset	Average Power (dBm)		
					20000	20175	20350
					1715.0MHz	1732.5MHz	1750.0MHz
Band 4	10	QPSK	1	0	22.80	22.69	22.71
			1	24	22.58	22.57	22.69
			1	49	22.54	22.57	22.72
			25	0	21.89	21.77	21.85
			25	12	21.81	21.79	21.86
			25	24	21.82	21.74	21.96
			50	0	21.88	21.86	21.92
		16QAM	1	0	21.81	21.78	21.83
			1	24	21.61	22.00	22.15
			1	49	21.79	21.64	22.15
			25	0	20.75	20.70	20.91
			25	12	20.84	20.70	20.83
			25	24	20.65	20.68	20.90
			50	0	20.79	20.69	20.82

LTE Band	Bandwidth (MHz)	Modulation	RB Size	RB Offset	Average Power (dBm)		
					20025	20175	20325
					1717.5MHz	1732.5MHz	1747.5MHz
Band 4	15	QPSK	1	0	22.66	22.64	22.81
			1	37	22.68	21.72	22.80
			1	74	22.88	22.95	22.86
			36	0	21.93	22.81	21.49
			36	16	22.00	21.59	21.86
			36	35	21.77	21.81	21.88
			75	0	20.76	21.13	22.09
		16QAM	1	0	22.02	21.83	22.32
			1	37	22.31	21.37	22.76
			1	74	21.74	21.72	23.08
			36	0	22.02	20.81	20.85
			36	16	20.79	20.71	20.85
			36	35	20.77	20.75	20.88
			75	0	20.74	20.72	20.85

LTE Band	Bandwidth (MHz)	Modulation	RB Size	RB Offset	Average Power (dBm)		
					20050	20175	20300
					1720.0MHz	1732.5MHz	1745.0MHz
Band 4	20	QPSK	1	0	22.93	22.70	22.56
			1	49	22.59	22.55	22.61
			1	99	22.56	22.58	22.72
			50	0	21.86	21.88	21.95
			50	24	21.86	21.71	21.92
			50	49	21.74	21.68	21.81
			100	0	21.74	21.69	21.89
		16QAM	1	0	22.13	22.30	21.88
			1	49	21.70	22.08	22.16
			1	99	21.87	21.52	22.10
			50	0	20.81	20.87	20.84
			50	24	20.71	20.72	20.79
			50	49	20.62	20.64	21.05
			100	0	20.69	20.78	21.23

LTE Band 7 part:

LTE Band	Bandwidth (MHz)	Modulation	RB Size	RB Offset	Average Power (dBm)		
					20775	21100	21425
					2502.5MHz	2535.0MHz	2567.5MHz
Band 7	5	QPSK	1	0	23.49	22.82	22.87
			1	12	23.32	22.77	22.89
			1	24	23.28	22.70	22.84
			12	0	22.45	21.96	21.95
			12	6	22.41	21.95	21.94
			12	11	22.53	21.93	21.95
			25	0	22.47	21.90	21.99
		16QAM	1	0	22.29	21.80	21.83
			1	12	22.09	21.88	21.79
			1	24	22.24	22.15	21.71
			12	0	21.30	20.94	20.94
			12	6	21.25	21.02	20.86
			12	11	21.35	20.86	20.91
			25	0	21.40	20.90	20.85

LTE Band	Bandwidth (MHz)	Modulation	RB Size	RB Offset	Average Power (dBm)		
					20800	21100	21400
					2505.0MHz	2535.0MHz	2565.0MHz
Band 7	10	QPSK	1	0	23.48	22.80	22.62
			1	24	23.32	22.89	22.85
			1	49	23.25	22.73	22.87
			25	0	22.49	22.03	21.92
			25	12	22.46	22.03	21.92
			25	24	22.40	21.94	22.02
			50	0	22.50	22.07	22.01
		16QAM	1	0	22.28	21.85	21.75
			1	24	22.24	21.82	22.15
			1	49	22.20	22.15	21.61
			25	0	21.48	20.93	20.95
			25	12	21.44	20.98	21.02
			25	24	21.32	20.98	20.96
			50	0	21.38	21.01	21.01

LTE Band	Bandwidth (MHz)	Modulation	RB Size	RB Offset	Average Power (dBm)		
					20825	21100	21375
					2507.5MHz	2535.0MHz	2562.5MHz
Band 7	15	QPSK	1	0	23.41	22.84	22.83
			1	37	23.32	22.81	22.75
			1	74	22.89	22.81	23.02
			36	0	22.56	22.07	21.98
			36	16	22.58	21.97	22.02
			36	35	22.44	22.12	22.08
			75	0	22.56	22.03	22.05
		16QAM	1	0	22.73	21.78	21.85
			1	37	22.42	22.09	22.28
			1	74	21.87	21.89	21.97
			36	0	21.45	21.02	20.98
			36	16	21.45	21.06	21.00
			36	35	21.27	20.95	21.04
			75	0	21.43	21.02	21.02

LTE Band	Bandwidth (MHz)	Modulation	RB Size	RB Offset	Average Power (dBm)		
					20850	21100	21350
					2510.0MHz	2535.0MHz	2560.0MHz
Band 7	20	QPSK	1	0	23.43	22.55	22.88
			1	49	23.07	22.94	22.73
			1	99	22.67	22.95	22.96
			50	0	22.69	22.10	21.97
			50	24	22.49	22.00	22.10
			50	49	22.23	22.10	22.19
			100	0	22.46	22.09	22.05
		16QAM	1	0	22.38	21.63	21.58
			1	49	22.07	21.89	21.93
			1	99	22.25	21.98	22.36
			50	0	21.50	21.10	20.87
			50	24	21.36	21.02	21.11
			50	49	21.32	20.97	21.03
			100	0	21.46	21.04	21.10

LTE Band 17 part:

LTE Band	Bandwidth (MHz)	Modulation	RB Size	RB Offset	Average Power (dBm)		
					23755	23790	23825
					706.5MHz	710.0MHz	713.5MHz
Band 17	5	QPSK	1	0	22.81	22.88	21.48
			1	12	22.83	22.93	22.74
			1	24	22.81	22.88	22.65
			12	0	21.96	21.96	21.96
			12	6	21.98	22.00	21.89
			12	11	22.00	22.00	21.87
			25	0	21.91	21.94	21.89
		16QAM	1	0	22.30	21.93	22.01
			1	12	21.89	22.00	21.91
			1	24	22.00	21.72	21.76
			12	0	20.87	20.81	21.20
			12	6	20.99	21.00	21.78
			12	11	20.90	20.84	20.35
			25	0	20.94	21.19	22.23

LTE Band	Bandwidth (MHz)	Modulation	RB Size	RB Offset	Average Power (dBm)		
					23780	23790	23800
					709.0MHz	710.0MHz	711.0MHz
Band 17	10	QPSK	1	0	23.78	23.79	22.53
			1	24	22.86	22.87	23.35
			1	49	22.78	22.12	22.80
			25	0	21.93	20.92	22.62
			25	12	20.64	21.93	21.46
			25	24	21.93	22.65	21.92
			50	0	21.93	21.95	21.94
		16QAM	1	0	22.05	22.52	20.51
			1	24	21.94	22.57	22.55
			1	49	22.53	21.34	21.71
			25	0	20.90	21.95	21.92
			25	12	20.30	20.09	22.03
			25	24	22.27	21.90	20.92
			50	0	20.95	20.89	20.95

13.4 WLAN 2.4 GHz Band Conducted Power

Average Power (dBm)				
Channel	Frequency (MHz)	802.11 b	802.11 g	802.11n (HT20)
CH 01	2412	14.42	11.16	11.37
CH 06	2437	15.37	14.39	14.48
CH 11	2462	15.13	14.33	14.33

Average Power (dBm)		
Channel	Frequency (MHz)	802.11n (HT40)
CH 03	2422	10.31
CH 06	2437	12.79
CH 09	2452	12.38

Note:

- Per KDB 447498 D01v06, the 1-g SAR test exclusion thresholds for 100 MHz to 6 GHz at *test separation distances* ≤ 50 mm are determined by:

$$[(\text{max. power of channel, including tune-up tolerance, mW}) / (\text{min. test separation distance, mm})] \cdot [\sqrt{f(\text{GHz})}] \leq 3.0$$
 for 1-g SAR, where
 - f(GHz) is the RF channel transmit frequency in GHz
 - Power and distance are rounded to the nearest mW and mm before calculation
 - The result is rounded to one decimal place for comparison

Channel	Frequency (GHz)	Max. Tune-up Power (dBm)	Max. Power (mW)	Test distance (mm)	Result	exclusion thresholds for 1-g SAR
b/CH 06	2.437	15.5	35.48	5	11.07	3.0
n20/CH 06	2.437	14.5	28.18	5	8.79	3.0

- Base on the result of note1, RF exposure evaluation of 802.11 b mode is required.
- Per KDB 248227 D01v02r02, choose the highest output power channel to test SAR and determine further SAR exclusion.
- Per KDB 248227 D01v02r02, In the 2.4 GHz band, separate SAR procedures are applied to DSSS and OFDM configurations to simplify DSSS test requirements. SAR is not required for the following 2.4 GHz OFDM conditions:
 - When KDB Publication 447498 SAR test exclusion applies to the OFDM configuration.
 - When the highest reported SAR for DSSS is adjusted by the ratio of OFDM to DSSS specified maximum output power and the adjusted SAR is ≤ 1.2 W/kg.
- The output power of all data rate were pre-scan, just the worst case (the lowest data rate) of all mode were shown in report.
- Per KDB 248227 D01V02r02 section 2.2, when the EUT in continuously transmitting mode, the actual duty cycle is 98.6%, so the duty cycle factor is 1.01.

13.5 Bluetooth Conducted Power

Average Power (dBm) (BT 2.0)				
Channel	Frequency (MHz)	GFSK	$\pi/4$ -DQPSK	8DPSK
CH 01	2402	2.09	1.09	1.18
CH 39	2441	3.89	3.01	3.01
CH 78	2480	2.03	1.18	1.18

Average Power (dBm)		
Channel	Frequency (MHz)	BLE (BT 4.0)
CH 00	2402	-5.06
CH 20	2442	-3.11
CH 39	2480	-5.04

Note:

- Per KDB 447498 D01v06, the 1-g SAR test exclusion thresholds for 100 MHz to 6 GHz at *test separation distances* \leq 50 mm are determined by:

$$[(\text{max. power of channel, including tune-up tolerance, mW}) / (\text{min. test separation distance, mm})] \cdot [\sqrt{f(\text{GHz})}] \leq 3.0$$
 for 1-g SAR, where
 - $f(\text{GHz})$ is the RF channel transmit frequency in GHz
 - Power and distance are rounded to the nearest mW and mm before calculation
 - The result is rounded to one decimal place for comparison

Channel	Frequency (GHz)	Max. tune-up Power (dBm)	Max. Power (mW)	Test distance (mm)	Result	exclusion thresholds for 1-g SAR
CH 39	2.441	4.0	2.51	5	0.78	3.0

- The max. tune-up power was provided by manufacturer, base on the result of note 1, RF exposure evaluation is not required.
- The output power of all data rate were pre-scan, just the worst case of all mode were shown in report.
- When the minimum *test separation distance* is $<$ 5 mm, a distance of 5 mm according is applied to determine SAR test exclusion.

14 Exposure Positions Consideration

14.1 EUT Antenna Locations

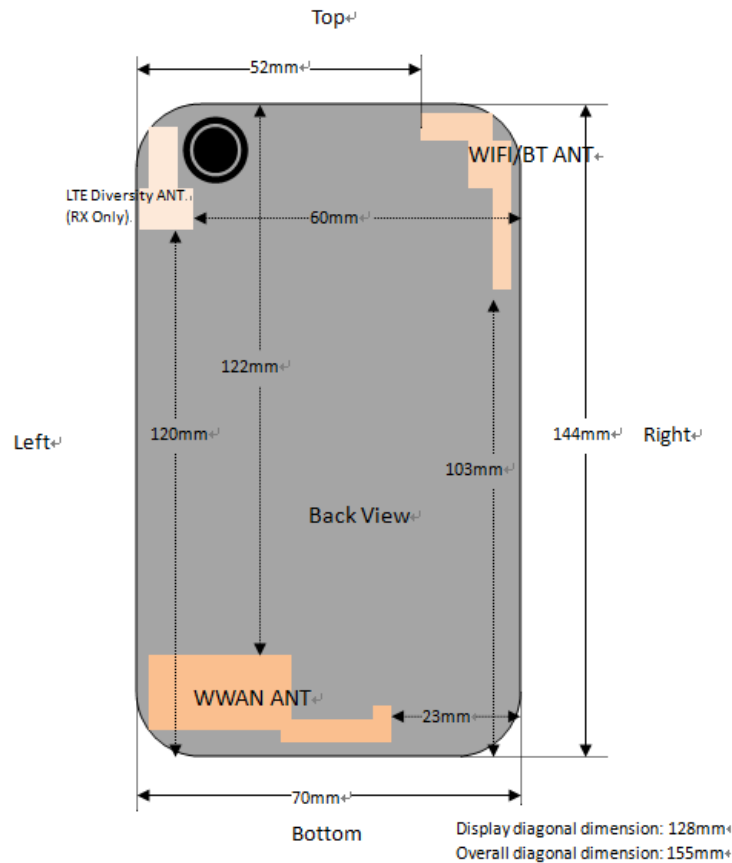

Fig.14.1 EUT Antenna Locations

14.2 Test Positions Consideration

Distance of Antennas to EUT edge/surface Test distance: 10mm						
Antennas	Back	Front	Top Side	Bottom Side	Right Side	Left Side
WWAN	<25mm	<25mm	122mm	<25mm	<25mm	<25mm
WLAN & Bluetooth	<25mm	<25mm	<25mm	103mm	<25mm	52mm

Test Positions Test distance: 10mm						
Antennas	Back	Front	Top Side	Bottom Side	Right Side	Left Side
WWAN	Yes	Yes	No	Yes	Yes	Yes
WLAN & Bluetooth	Yes	Yes	Yes	No	Yes	No

Note:

1. Head/Body-worn/Hotspot mode SAR assessments are required.
2. Referring to KDB 941225 D06v02r01, when the overall device length and width are $\geq 9\text{cm} * 5\text{cm}$, the test distance is 10mm. SAR must be measured for all sides and surfaces with a transmitting antenna located within 25mm from that surface or edge.
3. Per KDB 447498 D01v06, for handsets the test separation distance is determined by the smallest distance between the outer surface of the device and the user, which is 0 mm for head SAR, 10 mm for hotspot SAR, and 10 mm for body-worn SAR.

15 SAR Test Results Summary

15.1 Standalone Head SAR Data

➤ GSM Head SAR

Plot No.	Band/Mode	Test Position	CH.	Freq. (MHz)	Ave. Power (dBm)	Power Drift (dB)	Tune-Up Limit (dBm)	Meas. SAR _{1g} (W/kg)	Scaling Factor	Reported SAR _{1g} (W/kg)
	GSM850/Voice	Right Cheek	190	836.6	31.74	-0.33	32.0	0.122	1.062	0.130
	GSM850/Voice	Right Tilted	190	836.6	31.74	0.20	32.0	0.085	1.062	0.090
1	GSM850/Voice	Left Cheek	190	836.6	31.74	-0.04	32.0	0.161	1.062	0.171
	GSM850/Voice	Left Tilted	190	836.6	31.74	0.05	32.0	0.072	1.062	0.076
	GSM1900/Voice	Right Cheek	512	1850.2	28.70	-0.12	29.0	0.087	1.072	0.093
	GSM1900/Voice	Right Tilted	512	1850.2	28.70	0.06	29.0	0.040	1.072	0.043
2	GSM1900/Voice	Left Cheek	512	1850.2	28.70	0.22	29.0	0.113	1.072	0.121
	GSM1900/Voice	Left Tilted	512	1850.2	28.70	0.05	29.0	0.034	1.072	0.036
ANSI / IEEE C95.1 – SAFETY LIMIT Spatial Peak Uncontrolled Exposure/General Population							1.6 W/kg (mW/g) Averaged over 1g			

➤ WCDMA Head SAR

Plot No.	Band/Mode	Test Position	CH.	Freq. (MHz)	Ave. Power (dBm)	Power Drift (dB)	Tune-Up Limit (dBm)	Meas. SAR _{1g} (W/kg)	Scaling Factor	Reported SAR _{1g} (W/kg)
	Band V/RMC	Right Cheek	4183	836.6	22.58	-0.18	23.0	0.121	1.102	0.133
	Band V/RMC	Right Tilted	4183	836.6	22.58	0.05	23.0	0.089	1.102	0.098
3	Band V/RMC	Left Cheek	4183	836.6	22.58	-0.21	23.0	0.172	1.102	0.190
	Band V/RMC	Left Tilted	4183	836.6	22.58	0.03	23.0	0.084	1.102	0.093
	Band II/RMC	Right Cheek	9262	1852.4	21.95	0.21	22.0	0.144	1.012	0.146
	Band II/RMC	Right Tilted	9262	1852.4	21.95	-0.24	22.0	0.079	1.012	0.080
4	Band II/RMC	Left Cheek	9262	1852.4	21.95	-0.01	22.0	0.193	1.012	0.195
	Band II/RMC	Left Tilted	9262	1852.4	21.95	-0.21	22.0	0.059	1.012	0.060
ANSI / IEEE C95.1 – SAFETY LIMIT Spatial Peak Uncontrolled Exposure/General Population							1.6 W/kg (mW/g) Averaged over 1g			

➤ LTE 20MHz QPSK 1RB Head SAR

Plot No.	Band/Mode	Test Position	CH.	Freq. (MHz)	Ave. Power (dBm)	Power Drift (dB)	Tune-Up Limit (dBm)	Meas. SAR _{1g} (W/kg)	Scaling Factor	Reported SAR _{1g} (W/kg)
5	Band2/RB#0	Right Cheek	18700	1860.0	22.54	-0.26	23.0	0.206	1.112	0.229
	Band2/RB#0	Right Tilted	18700	1860.0	22.54	-0.04	23.0	0.058	1.112	0.064
	Band2/RB#0	Left Cheek	18700	1860.0	22.54	0.03	23.0	0.186	1.112	0.207
	Band2/RB#0	Left Tilted	18700	1860.0	22.54	0.36	23.0	0.093	1.112	0.103
6	Band4/RB#0	Right Cheek	20050	1720.0	22.93	0.20	23.0	0.217	1.016	0.220
	Band4/RB#0	Right Tilted	20050	1720.0	22.93	-0.02	23.0	0.110	1.016	0.112
	Band4/RB#0	Left Cheek	20050	1720.0	22.93	0.30	23.0	0.118	1.016	0.120
	Band4/RB#0	Left Tilted	20050	1720.0	22.93	0.22	23.0	0.092	1.016	0.093
	Band7/RB#0	Right Cheek	20850	2510.0	23.43	-0.24	23.5	0.154	1.016	0.156
	Band7/RB#0	Right Tilted	20850	2510.0	23.43	0.07	23.5	0.126	1.016	0.128
7	Band7/RB#0	Left Cheek	20850	2510.0	23.43	0.23	23.5	0.296	1.016	0.301
	Band7/RB#0	Left Tilted	20850	2510.0	23.43	-0.08	23.5	0.104	1.016	0.106
	Band17/RB#0	Right Cheek	23790	710.0	23.79	-0.27	24.0	0.032	1.05	0.034
	Band17/RB#0	Right Tilted	23790	710.0	23.79	0.06	24.0	0.021	1.05	0.022
8	Band17/RB#0	Left Cheek	23790	710.0	23.79	-0.19	24.0	0.036	1.05	0.038
	Band17/RB#0	Left Tilted	23790	710.0	23.79	0.15	24.0	0.024	1.05	0.025
ANSI / IEEE C95.1 – SAFETY LIMIT Spatial Peak Uncontrolled Exposure/General Population							1.6 W/kg (mW/g) Averaged over 1g			

➤ LTE 20MHz QPSK 50%RB Head SAR

Plot No.	Band/Mode	Test Position	CH.	Freq. (MHz)	Ave. Power (dBm)	Power Drift (dB)	Tune-Up Limit (dBm)	Meas. SAR _{1g} (W/kg)	Scaling Factor	Reported SAR _{1g} (W/kg)	
9	Band2/RB#0	Right Cheek	18700	1860.0	21.49	0.02	21.5	0.159	1.002	0.159	
	Band2/RB#0	Right Tilted	18700	1860.0	21.49	-0.09	21.5	0.045	1.002	0.045	
	Band2/RB#0	Left Cheek	18700	1860.0	21.49	0.24	21.5	0.146	1.002	0.146	
	Band2/RB#0	Left Tilted	18700	1860.0	21.49	0.29	21.5	0.038	1.002	0.038	
10	Band4/RB#0	Right Cheek	20300	1745.0	21.95	0.33	22.0	0.145	1.012	0.147	
	Band4/RB#0	Right Tilted	20300	1745.0	21.95	-0.17	22.0	0.099	1.012	0.100	
	Band4/RB#0	Left Cheek	20300	1745.0	21.95	0.30	22.0	0.118	1.012	0.119	
	Band4/RB#0	Left Tilted	20300	1745.0	21.95	0.22	22.0	0.092	1.012	0.093	
11	Band7/RB#0	Right Cheek	20850	2510.0	22.69	0.12	23.0	0.093	1.074	0.100	
	Band7/RB#0	Right Tilted	20850	2510.0	22.69	-0.00	23.0	0.099	1.074	0.106	
	Band7/RB#0	Left Cheek	20850	2510.0	22.69	0.11	23.0	0.283	1.074	0.304	
	Band7/RB#0	Left Tilted	20850	2510.0	22.69	-0.03	23.0	0.059	1.074	0.063	
12	Band17/RB#24	Right Cheek	23790	710.0	22.65	0.13	23.0	0.029	1.084	0.031	
	Band17/RB#24	Right Tilted	23790	710.0	22.65	0.30	23.0	0.021	1.084	0.023	
12	Band17/RB#24	Left Cheek	23790	710.0	22.65	-0.10	23.0	0.038	1.084	0.041	
	Band17/RB#24	Left Tilted	23790	710.0	22.65	0.21	23.0	0.023	1.084	0.025	
ANSI / IEEE C95.1 – SAFETY LIMIT Spatial Peak Uncontrolled Exposure/General Population							1.6 W/kg (mW/g) Averaged over 1g				

➤ WLAN 2.4 GHz Head SAR

Plot No.	Band/Mode	Test Position	CH.	Freq. (MHz)	Ave. Power (dBm)	Power Drift (dB)	Tune-Up Limit (dBm)	Meas. SAR _{1g} (W/kg)	Scaling Factor	D.C Factor	Reported SAR _{1g} (W/kg)
13	2.4GHz/802.11b	Right Cheek	06	2437	15.37	0.15	15.5	0.451	1.03	1.01	0.469
	2.4GHz/802.11b	Right Tilted	06	2437	15.37	0.31	15.5	0.306	1.03	1.01	0.318
	2.4GHz/802.11b	Left Cheek	06	2437	15.37	0.23	15.5	0.166	1.03	1.01	0.173
	2.4GHz/802.11b	Left Tilted	06	2437	15.37	-0.11	15.5	0.111	1.03	1.01	0.115
ANSI / IEEE C95.1 – SAFETY LIMIT Spatial Peak Uncontrolled Exposure/General Population							1.6 W/kg (mW/g) Averaged over 1g				

Note:

- Per KDB 447498 D01v06, for each exposure position, if the highest output power channel Reported SAR ≤ 0.8W/kg, other channels SAR testing is not necessary.
- Per KDB 865664 D01v01r04, for each frequency band, repeated SAR measurement is required when the measured SAR is ≥ 0.8W/kg.
- Per KDB 941225 D05v02r05, 100% RB allocation SAR measurement is not required when the highest reported SAR for 1 RB and 50% RB allocation are ≤ 0.8 W/kg.
- Per KDB 248227 D01v02r02, for 802.11b DSSS, when the reported SAR of the highest measured maximum output power channel for the exposure configuration is ≤ 0.8 W/kg, no further SAR testing is required in that exposure configuration.
- Per KDB 248227 D01v02r02, OFDM SAR is not required when the highest reported SAR for DSSS is adjusted by the ratio of OFDM to DSSS specified maximum output power and the adjusted SAR is ≤ 1.2 W/kg. Cuz the maximum output power specified for OFDM and DSSS are 28.05mW(14.48dBm) and 34.43mW(15.37dBm), the scaled SAR would be 0.469×(28.05/34.43)=0.382W/Kg<1.2 W/kg, therefore, SAR is not required for OFDM.
- According to KDB 865664 D02v01r02, SAR plot is required for the highest measured SAR in each exposure configuration, wireless mode and frequency band combination.

15.2 Standalone Body SAR

> GSM Body SAR

Plot No.	Band/Mode	Test Position	CH.	Freq. (MHz)	Ave. Power (dBm)	Power Drift (dB)	Tune-Up Limit (dBm)	Meas. SAR _{1g} (W/kg)	Scaling Factor	Reported SAR _{1g} (W/kg)
	GSM850/Voice	Front	190	836.6	31.74	0.07	32.0	0.204	1.062	0.217
14	GSM850/Voice	Back	190	836.6	31.74	0.04	32.0	0.253	1.062	0.269
	GSM1900/Voice	Front	512	1850.2	28.70	-0.06	29.0	0.439	1.072	0.471
15	GSM1900/Voice	Back	512	1850.2	28.70	0.01	29.0	0.497	1.072	0.533
ANSI / IEEE C95.1 – SAFETY LIMIT Spatial Peak Uncontrolled Exposure/General Population							1.6 W/kg (mW/g) Averaged over 1g			

> WCDMA Body SAR

Plot No.	Band/Mode	Test Position	CH.	Freq. (MHz)	Ave. Power (dBm)	Power Drift (dB)	Tune-Up Limit (dBm)	Meas. SAR _{1g} (W/kg)	Scaling Factor	Reported SAR _{1g} (W/kg)
	Band V/RMC	Front	4183	836.6	22.58	0.07	23.0	0.195	1.102	0.215
16	Band V/RMC	Back	4183	836.6	22.58	0.01	23.0	0.255	1.102	0.281
	Band II/RMC	Front	9262	1852.4	21.95	0.17	22.0	0.578	1.012	0.585
17	Band II/RMC	Back	9262	1852.4	21.95	-0.13	22.0	0.783	1.012	0.792
ANSI / IEEE C95.1 – SAFETY LIMIT Spatial Peak Uncontrolled Exposure/General Population							1.6 W/kg (mW/g) Averaged over 1g			

> LTE 20MHz QPSK 1RB Body SAR

Plot No.	Band/Mode	Test Position	CH.	Freq. (MHz)	Ave. Power (dBm)	Power Drift (dB)	Tune-Up Limit (dBm)	Meas. SAR _{1g} (W/kg)	Scaling Factor	Reported SAR _{1g} (W/kg)
	Band2/RB#0	Front	18700	1860.0	22.54	0.00	23.0	0.630	1.112	0.701
18	Band2/RB#0	Back	18700	1860.0	22.54	0.07	23.0	0.663	1.112	0.737
	Band4/RB#0	Front	20050	1720.0	22.93	0.01	23.0	0.781	1.016	0.793
19	Band4/RB#0	Back	20050	1720.0	22.93	0.15	23.0	0.799	1.016	0.812
	Band4/RB#0	Back	20175	1732.5	22.70	0.21	23.0	0.706	1.072	0.757
	Band4/RB#0	Back	20300	1745.0	22.56	-0.08	23.0	0.682	1.107	0.755
20	Band7/RB#0	Front	20850	2510.0	23.43	0.17	23.5	0.517	1.016	0.525
	Band7/RB#0	Back	20850	2510.0	23.43	0.06	23.5	0.472	1.016	0.480
	Band17/RB#0	Front	23790	710.0	23.79	0.07	24.0	0.068	1.05	0.071
21	Band17/RB#0	Back	23790	710.0	23.79	0.19	24.0	0.099	1.05	0.104
ANSI / IEEE C95.1 – SAFETY LIMIT Spatial Peak Uncontrolled Exposure/General Population							1.6 W/kg (mW/g) Averaged over 1g			

> LTE 20MHz QPSK 50%RB Body SAR

Plot No.	Band/Mode	Test Position	CH.	Freq. (MHz)	Ave. Power (dBm)	Power Drift (dB)	Tune-Up Limit (dBm)	Meas. SAR _{1g} (W/kg)	Scaling Factor	Reported SAR _{1g} (W/kg)
	Band2/RB#0	Front	18700	1860.0	21.49	0.07	21.5	0.808	1.002	0.810
	Band2/RB#0	Front	18700	1860.0	21.49	-0.14	21.5	0.799	1.002	0.801
	Band2/RB#0	Front	18900	1880.0	21.21	-0.20	21.5	0.786	1.069	0.840
	Band2/RB#0	Front	19100	1900.0	20.80	0.03	21.0	0.608	1.047	0.637
22	Band2/RB#0	Back	18700	1860.0	21.49	0.01	21.5	0.848	1.002	0.850
	Band2/RB#0	Back	18700	1860.0	21.49	0.06	21.5	0.819	1.002	0.821
	Band2/RB#0	Back	18900	1880.0	21.21	-0.10	21.5	0.831	1.069	0.888
	Band2/RB#0	Back	19100	1900.0	20.80	-0.04	21.0	0.646	1.047	0.676
	Band4/RB#0	Front	20300	1745.0	21.95	0.36	22.0	0.621	1.012	0.628
23	Band4/RB#0	Back	20300	1745.0	21.95	0.01	22.0	0.663	1.012	0.671
24	Band7/RB#0	Front	20850	2510.0	22.69	0.18	23.0	0.448	1.074	0.481
	Band7/RB#0	Back	20850	2510.0	22.69	-0.20	23.0	0.395	1.074	0.424
	Band17/RB#24	Front	23790	710.0	22.65	-0.02	23.0	0.065	1.084	0.070
25	Band17/RB#24	Back	23790	710.0	22.65	0.01	23.0	0.094	1.084	0.102

ANSI / IEEE C95.1 – SAFETY LIMIT Spatial Peak Uncontrolled Exposure/General Population	1.6 W/kg (mW/g) Averaged over 1g
-------------------------------------------------------------------------------------------------------------------	---------------------------------------------------

➤ LTE 20MHz QPSK 100%RB Body SAR

Plot No.	Band/Mode	Test Position	CH.	Freq. (MHz)	Ave. Power (dBm)	Power Drift (dB)	Tune-Up Limit (dBm)	Meas. SAR _{1g} (W/kg)	Scaling Factor	Reported SAR _{1g} (W/kg)
	Band2/RB#0	Front	18700	1860.0	21.36	0.12	21.5	0.709	1.033	0.732
26	Band2/RB#0	Back	18700	1860.0	21.36	-0.23	21.5	0.725	1.033	0.749
27	Band4/RB#0	Back	20300	1745.0	21.89	0.05	22.0	0.655	1.026	0.672

ANSI / IEEE C95.1 – SAFETY LIMIT Spatial Peak Uncontrolled Exposure/General Population	1.6 W/kg (mW/g) Averaged over 1g
-------------------------------------------------------------------------------------------------------------------	---------------------------------------------------

➤ WLAN 2.4 GHz Body SAR

Plot No.	Band/Mode	Test Position	CH.	Freq. (MHz)	Ave. Power (dBm)	Power Drift (dB)	Tune-Up Limit (dBm)	Meas. SAR _{1g} (W/kg)	Scaling Factor	D.C Factor	Reported SAR _{1g} (W/kg)
	2.4GHz/802.11b	Front	06	2437	15.37	0.16	15.5	0.078	1.03	1.01	0.081
28	2.4GHz/802.11b	Back	06	2437	15.37	-0.15	15.5	0.203	1.03	1.01	0.211

ANSI / IEEE C95.1 – SAFETY LIMIT Spatial Peak Uncontrolled Exposure/General Population	1.6 W/kg (mW/g) Averaged over 1g
-------------------------------------------------------------------------------------------------------------------	---------------------------------------------------

Note:

- Body-worn SAR testing was performed at 10mm separation, and this distance is determined by the handset manufacturer that there will be body-worn accessories that users may acquire at the time of equipment certification, to enable users to purchase aftermarket body-worn accessories with the required minimum separation.
- Per KDB 941225 D06v02r01, when the same wireless modes and device transmission configurations are required for testing body-worn accessories and hotspot mode, it is not necessary to test body-worn accessory SAR for the same device orientation if the test separation distance for hotspot mode is more conservative than that used for body-worn accessories.
- Body-worn exposure conditions are intended to voice call operations, therefore GSM voice call is selected to be tested.
- Per KDB 648474 D04v01r03, when the *Reported* SAR for a body-worn accessory measured without a headset connected to the handset is ≤ 1.2 W/kg, SAR testing with a headset connected to the handset is not required.
- The WLAN SAR perform the front and back position, due considered the simultaneous SAR for body-worn.
- Per KDB 447498 D01v06, for each exposure position, if the highest output channel Reported SAR ≤ 0.8 W/kg, other channels SAR testing is not necessary.
- Per KDB 865664 D01v01r04, for each frequency band, repeated SAR measurement is required when the measured SAR is ≥ 0.8 W/kg.
- Per KDB 941225 D05v02r05, 100% RB allocation SAR measurement is not required when the highest reported SAR for 1 RB and 50% RB allocation are ≤ 0.8 W/kg.
- According to KDB 865664 D02v01r02, SAR plot is required for the highest measured SAR in each exposure configuration, wireless mode and frequency band combination.
- Highlight part of test data means repeated test.

15.3 Body SAR in Hotspot Mode

➤ GSM Body SAR in Hotspot mode

Plot No.	Band/Mode	Test Position	CH.	Freq. (MHz)	Ave. Power (dBm)	Power Drift (dB)	Tune-Up Limit (dBm)	Meas. SAR _{1g} (W/kg)	Scaling Factor	Reported SAR _{1g} (W/kg)
	GPRS850/4 slots	Front	190	836.6	28.23	0.10	28.5	0.338	1.064	0.360
29	GPRS850/4 slots	Back	190	836.6	28.23	-0.06	28.5	0.453	1.064	0.482
	GPRS850/4 slots	Left	190	836.6	28.23	0.12	28.5	0.152	1.064	0.162
	GPRS850/4 slots	Right	190	836.6	28.23	0.28	28.5	0.381	1.064	0.405
	GPRS850/4 slots	Bottom	190	836.6	28.23	0.28	28.5	0.190	1.064	0.202
	GPRS1900/4 slots	Front	512	1850.2	25.35	-0.07	25.5	0.757	1.035	0.783
	GPRS1900/4 slots	Back	512	1850.2	25.35	0.01	25.5	0.822	1.035	0.851
	GPRS1900/4 slots	Back	512	1850.2	25.35	0.19	25.5	0.802	1.035	0.830
	GPRS1900/4 slots	Back	661	1880.0	25.15	0.06	25.5	0.651	1.084	0.706
	GPRS1900/4 slots	Back	810	1909.8	25.12	0.02	25.5	0.568	1.091	0.620
	GPRS1900/4 slots	Left	512	1850.2	25.35	-0.20	25.5	0.153	1.035	0.158
	GPRS1900/4 slots	Right	512	1850.2	25.35	-0.13	25.5	0.166	1.035	0.172
30	GPRS1900/4 slots	Bottom	512	1850.2	25.35	-0.20	25.5	0.860	1.035	0.890
	GPRS1900/4 slots	Bottom	512	1850.2	25.35	0.05	25.5	0.767	1.035	0.794
	GPRS1900/4 slots	Bottom	661	1880.0	25.15	0.36	25.5	0.813	1.084	0.881
	GPRS1900/4 slots	Bottom	810	1909.8	25.12	0.26	25.5	0.831	1.091	0.907
ANSI / IEEE C95.1 – SAFETY LIMIT										
Spatial Peak							1.6 W/kg (mW/g)			
Uncontrolled Exposure/General Population										

➤ WCDMA Body SAR in Hotspot mode

Plot No.	Band/Mode	Test Position	CH.	Freq. (MHz)	Ave. Power (dBm)	Power Drift (dB)	Tune-Up Limit (dBm)	Meas. SAR _{1g} (W/kg)	Scaling Factor	Reported SAR _{1g} (W/kg)
	Band V/RMC	Front	4183	836.6	22.58	0.07	23.0	0.195	1.102	0.215
16	Band V/RMC	Back	4183	836.6	22.58	0.01	23.0	0.255	1.102	0.281
	Band V/RMC	Left	4183	836.6	22.58	0.21	23.0	0.093	1.102	0.102
	Band V/RMC	Right	4183	836.6	22.58	0.15	23.0	0.205	1.102	0.226
	Band V/RMC	Bottom	4183	836.6	22.58	0.31	23.0	0.111	1.102	0.122
	Band II/RMC	Front	9262	1852.4	21.95	0.17	22.0	0.578	1.012	0.585
	Band II/RMC	Back	9262	1852.4	21.95	-0.13	22.0	0.783	1.012	0.792
	Band II/RMC	Left	9262	1852.4	21.95	0.02	22.0	0.091	1.012	0.092
	Band II/RMC	Right	9262	1852.4	21.95	0.12	22.0	0.113	1.012	0.114
	Band II/RMC	Bottom	9262	1852.4	21.95	0.16	22.0	0.800	1.012	0.810
31	Band II/RMC	Bottom	9400	1880.0	21.30	0.05	22.0	0.842	1.175	0.989
	Band II/RMC	Bottom	9400	1880.0	21.30	0.14	22.0	0.811	1.175	0.953
	Band II/RMC	Bottom	9538	1907.6	21.33	-0.13	22.0	0.738	1.167	0.861
ANSI / IEEE C95.1 – SAFETY LIMIT										
Spatial Peak							1.6 W/kg (mW/g)			
Uncontrolled Exposure/General Population										

➤ LTE 20MHz QPSK 1RB Body SAR in Hotspot mode

Plot No.	Band/Mode	Test Position	CH.	Freq. (MHz)	Ave. Power (dBm)	Power Drift (dB)	Tune-Up Limit (dBm)	Meas. SAR _{1g} (W/kg)	Scaling Factor	Reported SAR _{1g} (W/kg)
	Band2/RB#0	Front	18700	1860.0	22.54	0.00	23.0	0.630	1.112	0.701
	Band2/RB#0	Back	18700	1860.0	22.54	0.07	23.0	0.663	1.112	0.737
	Band2/RB#0	Left	18700	1860.0	22.54	-0.31	23.0	0.308	1.112	0.342
	Band2/RB#0	Right	18700	1860.0	22.54	0.13	23.0	0.057	1.112	0.063
	Band2/RB#0	Bottom	18700	1860.0	22.54	0.08	23.0	0.858	1.112	0.954
	Band2/RB#0	Bottom	18900	1880.0	22.29	0.11	22.5	1.100	1.05	1.155
32	Band2/RB#0	Bottom	19100	1900.0	21.94	0.20	22.0	1.160	1.014	1.176
	Band2/RB#0	Bottom	19100	1900.0	21.84	0.05	22.0	1.030	1.038	1.069
	Band4/RB#0	Front	20050	1720.0	22.93	0.01	23.0	0.781	1.016	0.793
	Band4/RB#0	Back	20050	1720.0	22.93	0.15	23.0	0.799	1.016	0.812
	Band4/RB#0	Back	20175	1732.5	22.70	0.21	23.0	0.706	1.072	0.757

	Band4/RB#0	Back	20300	1745.0	22.56	-0.08	23.0	0.682	1.107	0.755
	Band4/RB#0	Left	20050	1720.0	22.70	0.09	23.0	0.238	1.072	0.255
	Band4/RB#0	Right	20050	1720.0	22.56	0.04	23.0	0.084	1.107	0.093
	Band4/RB#0	Bottom	20050	1720.0	22.93	0.14	23.0	0.986	1.04	1.025
	Band4/RB#0	Bottom	20175	1732.5	22.70	-0.13	23.0	1.050	1.072	1.126
33	Band4/RB#0	Bottom	20300	1745.0	22.56	0.26	23.0	1.080	1.107	1.196
	Band4/RB#0	Bottom	20300	1745.0	22.56	0.11	23.0	0.993	1.107	1.099
	Band7/RB#0	Front	20850	2510.0	23.43	0.17	23.5	0.517	1.016	0.525
	Band7/RB#0	Back	20850	2510.0	23.43	0.06	23.5	0.472	1.016	0.480
	Band7/RB#0	Left	20850	2510.0	23.43	0.09	23.5	0.107	1.016	0.109
	Band7/RB#0	Right	20850	2510.0	23.43	0.39	23.5	0.169	1.016	0.172
34	Band7/RB#0	Bottom	20850	2510.0	23.43	0.39	23.5	0.669	1.016	0.680
	Band17/RB#0	Front	23790	710.0	23.79	0.07	24.0	0.068	1.05	0.071
21	Band17/RB#0	Back	23790	710.0	23.79	0.19	24.0	0.099	1.05	0.104
	Band17/RB#0	Left	23790	710.0	23.79	0.20	24.0	0.034	1.05	0.036
	Band17/RB#0	Right	23790	710.0	23.79	-0.06	24.0	0.049	1.05	0.051
	Band17/RB#0	Bottom	23790	710.0	23.79	0.18	24.0	0.021	1.05	0.022
ANSI / IEEE C95.1 – SAFETY LIMIT Spatial Peak Uncontrolled Exposure/General Population							1.6 W/kg (mW/g) Averaged over 1g			

➤ LTE 20MHz QPSK 50%RB Body SAR in Hotspot mode

Plot No.	Band/Mode	Test Position	CH.	Freq. (MHz)	Ave. Power (dBm)	Power Drift (dB)	Tune-Up Limit (dBm)	Meas. SAR _{1g} (W/kg)	Scaling Factor	Reported SAR _{1g} (W/kg)
	Band2/RB#0	Front	18700	1860.0	21.49	0.07	21.5	0.808	1.002	0.810
	Band2/RB#0	Front	18700	1860.0	21.49	-0.14	21.5	0.799	1.002	0.801
	Band2/RB#0	Front	18900	1880.0	21.21	-0.20	21.5	0.786	1.069	0.840
	Band2/RB#0	Front	19100	1900.0	20.80	0.03	21.0	0.608	1.047	0.637
	Band2/RB#0	Back	18700	1860.0	21.49	0.01	21.5	0.848	1.002	0.850
	Band2/RB#0	Back	18700	1860.0	21.49	0.06	21.5	0.819	1.002	0.821
	Band2/RB#0	Back	18900	1880.0	21.21	-0.10	21.5	0.831	1.069	0.888
	Band2/RB#0	Back	19100	1900.0	20.80	-0.04	21.0	0.646	1.047	0.676
	Band2/RB#0	Left	18700	1860.0	21.49	-0.26	21.5	0.458	1.002	0.459
	Band2/RB#0	Right	18700	1860.0	21.49	0.09	21.5	0.067	1.002	0.067
	Band2/RB#0	Bottom	18700	1860.0	21.49	0.22	21.5	0.849	1.002	0.851
35	Band2/RB#0	Bottom	18900	1880.0	21.21	0.09	21.5	0.920	1.069	0.983
	Band2/RB#0	Bottom	18900	1880.0	21.21	-0.07	21.5	0.895	1.069	0.957
	Band2/RB#0	Bottom	19100	1900.0	20.80	0.21	21.0	0.855	1.047	0.895
	Band4/RB#0	Front	20300	1745.0	21.95	0.36	22.0	0.621	1.012	0.628
	Band4/RB#0	Back	20300	1745.0	21.95	0.01	22.0	0.663	1.012	0.671
	Band4/RB#0	Left	20300	1745.0	21.95	-0.07	22.0	0.261	1.012	0.264
	Band4/RB#0	Right	20300	1745.0	21.95	0.04	22.0	0.079	1.012	0.080
	Band4/RB#0	Bottom	20300	1745.0	21.95	-0.01	22.0	0.839	1.012	0.849
36	Band4/RB#0	Bottom	20050	1720.0	21.86	-0.20	22.0	0.873	1.033	0.902
	Band4/RB#0	Bottom	20050	1720.0	21.86	0.09	22.0	0.834	1.033	0.862
	Band4/RB#0	Bottom	20175	1732.5	21.88	0.03	22.0	0.804	1.028	0.827
	Band7/RB#0	Front	20850	2510.0	22.69	0.18	23.0	0.448	1.074	0.481
	Band7/RB#0	Back	20850	2510.0	22.69	-0.20	23.0	0.395	1.074	0.424
	Band7/RB#0	Left	20850	2510.0	22.69	0.03	23.0	0.101	1.074	0.108
	Band7/RB#0	Right	20850	2510.0	22.69	0.23	23.0	0.247	1.074	0.265
37	Band7/RB#0	Bottom	20850	2510.0	22.69	-0.00	23.0	0.695	1.074	0.746
	Band17/RB#24	Front	23790	710.0	22.65	-0.02	23.0	0.065	1.084	0.070
25	Band17/RB#24	Back	23790	710.0	22.65	0.01	23.0	0.094	1.084	0.102
	Band17/RB#24	Left	23790	710.0	22.65	-0.21	23.0	0.034	1.084	0.037
	Band17/RB#24	Right	23790	710.0	22.65	0.13	23.0	0.041	1.084	0.044
	Band17/RB#24	Bottom	23790	710.0	22.65	-0.17	23.0	0.022	1.084	0.024
ANSI / IEEE C95.1 – SAFETY LIMIT Spatial Peak Uncontrolled Exposure/General Population							1.6 W/kg (mW/g) Averaged over 1g			

➤ LTE 20MHz QPSK 100%RB Body SAR in Hotspot mode

Plot No.	Band/Mode	Test Position	CH.	Freq. (MHz)	Ave. Power (dBm)	Power Drift (dB)	Tune-Up Limit (dBm)	Meas. SAR _{1g} (W/kg)	Scaling Factor	Reported SAR _{1g} (W/kg)	
	Band2/RB#0	Front	18700	1860.0	21.36	0.12	21.5	0.709	1.033	0.732	
26	Band2/RB#0	Back	18700	1860.0	21.36	-0.23	21.5	0.725	1.033	0.749	
38	Band2/RB#0	Bottom	18700	1860.0	21.36	0.26	21.5	0.953	1.033	0.984	
	Band2/RB#0	Bottom	18700	1860.0	21.36	-0.11	21.5	0.907	1.033	0.937	
	Band2/RB#0	Bottom	18900	1880.0	21.06	0.28	21.5	0.889	1.107	0.984	
	Band2/RB#0	Bottom	19100	1900.0	20.63	0.22	21.0	0.912	1.089	0.993	
27	Band4/RB#0	Back	20300	1745.0	21.89	0.05	22.0	0.655	1.026	0.672	
39	Band4/RB#0	Bottom	20300	1745.0	21.89	0.26	22.0	0.868	1.026	0.891	
	Band4/RB#0	Bottom	20300	1745.0	21.89	0.19	22.0	0.822	1.026	0.843	
	Band4/RB#0	Bottom	20050	1720.0	21.74	0.23	22.0	0.719	1.062	0.764	
	Band4/RB#0	Bottom	20175	1732.5	21.69	0.24	22.0	0.854	1.074	0.917	
ANSI / IEEE C95.1 – SAFETY LIMIT Spatial Peak Uncontrolled Exposure/General Population							1.6 W/kg (mW/g) Averaged over 1g				

➤ WLAN 2.4GHz Body SAR in Hotspot mode

Plot No.	Band/Mode	Test Position	CH.	Freq. (MHz)	Ave. Power (dBm)	Power Drift (dB)	Tune-Up Limit (dBm)	Meas. SAR _{1g} (W/kg)	Scaling Factor	D.C Factor	Reported SAR _{1g} (W/kg)
	2.4GHz/802.11b	Front	06	2437	15.37	0.16	15.5	0.078	1.03	1.01	0.081
28	2.4GHz/802.11b	Back	06	2437	15.37	-0.15	15.5	0.203	1.03	1.01	0.211
	2.4GHz/802.11b	Left	06	2437	15.37	-0.22	15.5	0.009	1.03	1.01	0.009
	2.4GHz/802.11b	Top	06	2437	15.37	0.23	15.5	0.002	1.03	1.01	0.002
ANSI / IEEE C95.1 – SAFETY LIMIT Spatial Peak Uncontrolled Exposure/General Population							1.6 W/kg (mW/g) Averaged over 1g				

Note:

- Per KDB 447498 D01v06, for each exposure position, if the highest output channel Reported SAR ≤ 0.8W/kg, other channels SAR testing is not necessary.
- Additional WLAN SAR testing was performed for simultaneous transmission analysis.
- For Hotspot SAR testing, per KDB 941225 D06v02r01, for EUT dimension ≥ 9cm*5cm, the test distance is 10mm. SAR must be measured for all surfaces and sides with a transmitting antenna located within 2.5cm from that surface or edge.
- Per KDB 941225 D01v03r01, RMC 12.2kbps setting is used to evaluate SAR. If HSDPA output power is < 0.25dB higher than RMC 12.2kbps, or Reported SAR with RMC 12.2kbps setting is ≤ 1.2W/kg, HSDPA SAR evaluation can be excluded.
- Per KDB 865664 D01v01r04, for each frequency band, repeated SAR measurement is required when the measured SAR is ≥ 0.8W/kg.
- Per KDB 648474 D04v01r03, when the Reported SAR for a body-worn accessory measured without a headset connected to the handset is > 1.2 W/kg, SAR testing with a headset connected to the handset is required.
- Per KDB 941225 D05v02r05, 100% RB allocation SAR measurement is not required when the highest reported SAR for 1 RB and 50% RB allocation are ≤ 0.8 W/kg. Otherwise, SAR is measured for the highest output power channel.
- According to KDB 865664 D02v01r02, SAR plot is required for the highest measured SAR in each exposure configuration, wireless mode and frequency band combination.
- Highlight part of test data means repeated test.

15.4 Repeated SAR measurement

Band/ Mode	Test Position	CH.	Freq. (MHz)	Measured SAR (W/kg)				
				Original	1 st Repeated		2 nd Repeated	
					Value	Ratio	Value	Ratio
Band2/50%RB/RB#0	Front	18700	1860.0	0.808	0.799	1.01	/	/
Band2/50%RB/RB#0	Back	18700	1860.0	0.848	0.819	1.04	/	/
GPRS1900/4 slots	Back	512	1850.2	0.822	0.802	1.02	/	/
GPRS1900/4 slots	Bottom	512	1850.2	0.860	0.767	1.12	/	/
Band II/RMC	Bottom	9400	1880.0	0.842	0.811	1.04	/	/
Band2/1RB/RB#0	Bottom	19100	1900.0	1.160	1.030	1.13	/	/
Band4/1RB/RB#0	Bottom	20300	1745.0	1.080	0.993	1.09	/	/
Band2/50%RB/RB#0	Bottom	18900	1880.0	0.920	0.895	1.03	/	/
Band4/50%RB/RB#0	Bottom	20050	1720.0	0.873	0.834	1.05	/	/
Band2/100%RB/RB#0	Bottom	18700	1860.0	0.953	0.907	1.05	/	/
Band4/100%RB/RB#0	Bottom	20300	1745.0	0.868	0.822	1.06	/	/
ANSI / IEEE C95.1 – SAFETY LIMIT Spatial Peak Uncontrolled Exposure/General Population				1.6 W/kg (mW/g) Averaged over 1g				

Note:

- Per KDB 865664 D01v01r04, for each frequency band, repeated SAR measurement is required only when the measured SAR is ≥ 0.8 W/kg
- Per KDB 865664 D01v01r04, if the ratio of *original* and *repeated* is ≤ 1.2 and the measured SAR < 1.45 W/kg, only one repeated measurement is required.
- Per KDB 941225 D05v02r05, 100% RB allocation SAR measurement is not required when the highest reported SAR for 1 RB and 50% RB allocation are ≤ 0.8 W/kg. Otherwise, SAR is measured for the highest output power channel.

15.5 Multi-Band Simultaneous Transmission Considerations

➤ Simultaneous Transmission Capabilities

According to FCC KDB Publication 447498 D01v06, transmitters are considered to be transmitting simultaneously when there is overlapping transmission, with the exception of transmissions during network hand-offs with maximum hand-off duration less than 30 seconds. Possible transmission paths for the EUT are shown in below Figure and are color-coded to indicate communication modes which share the same path. Modes which share the same transmission path cannot transmit simultaneously with one another.



Fig.15.1 Simultaneous Transmission Paths

➤ Simultaneous Transmission Procedures

This device contains transmitters that may operate simultaneously. Therefore simultaneous transmission analysis is required. Per FCC KDB 447498 D01v06, simultaneous transmission SAR test exclusion may be applied when the sum of the 1-g SAR for all the simultaneous transmitting antennas in a specific a physical test configuration is ≤ 1.6 W/kg. When standalone SAR is not required to be measured, per FCC KDB 447498 D01v06 4.3.2), the following equation must be used to estimate the standalone 1g SAR for simultaneous transmission assessment involving that transmitter.

$$\text{Estimated SAR} = \frac{\sqrt{f(\text{GHz})}}{7.5} \cdot \frac{\text{Max. power of channel, mW}}{\text{Min. Separation Distance, mm}}$$

Mode	Max. tune-up Power (dBm)	Exposure Position	Head	Body	Hotspot
		Test Distance (mm)	0	10	10
Bluetooth	4	Estimated SAR (W/kg)	0.104	0.052	0.052

Note:

- When the minimum *test separation distance* is < 5 mm, a distance of 5 mm according is applied to determine estimated SAR.

➤ Multi-Band simultaneous Transmission Consideration

Simultaneous Transmission Consideration	Position	Applicable Combination
	Head	WWAN (Voice) + WLAN 2.4 GHz
		WWAN (Voice) + Bluetooth
	Body	WWAN (Voice) + WLAN 2.4 GHz
		WWAN (Voice) + Bluetooth
	Hotspot	WWAN (Voice) + WLAN 2.4 GHz
WWAN (Data) + Bluetooth		

Note:

- WLAN 2.4GHz Band and Bluetooth share the same antenna, and cannot transmit simultaneously.
- GSM/WCDMA/LTE shares the same antenna, and cannot transmit simultaneously.
- The Report SAR summation is calculated based on the same configuration and test position.
- Per KDB 447498 D01v06, simultaneous transmission SAR is compliant if,
 - Scalar SAR summation < 1.6 W/kg.
 - $SPLSR = (SAR_1 + SAR_2)^{1.5} / (\text{min. separation distance, mm})$, and the peak separation distance is determined from the square root of $[(x_1-x_2)^2 + (y_1-y_2)^2 + (z_1-z_2)^2]$, where (x_1, y_1, z_1) and (x_2, y_2, z_2) are the coordinates of the extrapolated peak SAR locations in the zoom scan If $SPLSR \leq 0.04$, simultaneously transmission SAR measurement is not necessary
 - Simultaneously transmission SAR measurement, and the Reported multi-band SAR < 1.6 W/kg

15.6 SAR Simultaneous Transmission Analysis

➤ Head Simultaneous Transmission

WWAN Mode	Position	WWAN SAR _{1g} (W/kg)	WLAN SAR _{1g} (W/kg)	Σ SAR (W/kg)
GSM850	Right Cheek	0.130	0.469	0.599
	Right Tilted	0.090	0.318	0.408
	Left Cheek	0.171	0.173	0.344
	Left Tilted	0.076	0.115	0.191

WWAN Mode	Position	WWAN SAR _{1g} (W/kg)	Bluetooth Estimated SAR _{1g} (W/kg)	Σ SAR (W/kg)
GSM850	Right Cheek	0.130	0.104	0.234
	Right Tilted	0.090	0.104	0.194
	Left Cheek	0.171	0.104	0.275
	Left Tilted	0.076	0.104	0.180

WWAN Mode	Position	WWAN SAR _{1g} (W/kg)	WLAN SAR _{1g} (W/kg)	Σ SAR (W/kg)
GSM 1900	Right Cheek	0.093	0.469	0.562
	Right Tilted	0.043	0.318	0.361
	Left Cheek	0.121	0.173	0.294
	Left Tilted	0.036	0.115	0.151

WWAN Mode	Position	WWAN SAR _{1g} (W/kg)	Bluetooth Estimated SAR _{1g} (W/kg)	Σ SAR (W/kg)
GSM 1900	Right Cheek	0.093	0.104	0.197
	Right Tilted	0.043	0.104	0.147
	Left Cheek	0.121	0.104	0.225
	Left Tilted	0.036	0.104	0.140

WWAN Mode	Position	WWAN SAR _{1g} (W/kg)	WLAN SAR _{1g} (W/kg)	Σ SAR (W/kg)
WCDMA Band V	Right Cheek	0.133	0.469	0.602
	Right Tilted	0.098	0.318	0.416
	Left Cheek	0.190	0.173	0.363
	Left Tilted	0.093	0.115	0.208

WWAN Mode	Position	WWAN SAR _{1g} (W/kg)	Bluetooth Estimated SAR _{1g} (W/kg)	Σ SAR (W/kg)
WCDMA Band V	Right Cheek	0.133	0.104	0.237
	Right Tilted	0.098	0.104	0.202
	Left Cheek	0.190	0.104	0.294
	Left Tilted	0.093	0.104	0.197

WWAN Mode	Position	WWAN SAR _{1g} (W/kg)	WLAN SAR _{1g} (W/kg)	Σ SAR (W/kg)
WCDMA Band II	Right Cheek	0.146	0.469	0.615
	Right Tilted	0.080	0.318	0.398
	Left Cheek	0.195	0.173	0.368
	Left Tilted	0.060	0.115	0.175

WWAN Mode	Position	WWAN SAR _{1g} (W/kg)	Bluetooth Estimated SAR _{1g} (W/kg)	Σ SAR (W/kg)
WCDMA Band II	Right Cheek	0.146	0.104	0.250
	Right Tilted	0.080	0.104	0.184
	Left Cheek	0.195	0.104	0.299
	Left Tilted	0.060	0.104	0.164

WWAN Mode	Position	WWAN SAR _{1g} (W/kg)	WLAN SAR _{1g} (W/kg)	Σ SAR (W/kg)
LTE Band 2	Right Cheek	0.229	0.469	0.698
	Right Tilted	0.064	0.318	0.382
	Left Cheek	0.207	0.173	0.380
	Left Tilted	0.103	0.115	0.218

WWAN Mode	Position	WWAN SAR _{1g} (W/kg)	Bluetooth Estimated SAR _{1g} (W/kg)	Σ SAR (W/kg)
LTE Band 2	Right Cheek	0.229	0.104	0.333
	Right Tilted	0.064	0.104	0.168
	Left Cheek	0.207	0.104	0.311
	Left Tilted	0.103	0.104	0.207

WWAN Mode	Position	WWAN SAR1g (W/kg)	WLAN SAR1g (W/kg)	Σ SAR (W/kg)
LTE Band 4	Right Cheek	0.220	0.469	0.689
	Right Tilted	0.112	0.318	0.430
	Left Cheek	0.120	0.173	0.293
	Left Tilted	0.093	0.115	0.208

WWAN Mode	Position	WWAN SAR1g (W/kg)	Bluetooth Estimated SAR1g (W/kg)	Σ SAR (W/kg)
LTE Band 4	Right Cheek	0.220	0.104	0.324
	Right Tilted	0.112	0.104	0.216
	Left Cheek	0.120	0.104	0.224
	Left Tilted	0.093	0.104	0.197

WWAN Mode	Position	WWAN SAR1g (W/kg)	WLAN SAR1g (W/kg)	Σ SAR (W/kg)
LTE Band 7	Right Cheek	0.156	0.469	0.625
	Right Tilted	0.128	0.318	0.446
	Left Cheek	0.304	0.173	0.477
	Left Tilted	0.106	0.115	0.221

WWAN Mode	Position	WWAN SAR1g (W/kg)	Bluetooth Estimated SAR1g (W/kg)	Σ SAR (W/kg)
LTE Band 7	Right Cheek	0.156	0.104	0.260
	Right Tilted	0.128	0.104	0.232
	Left Cheek	0.304	0.104	0.408
	Left Tilted	0.106	0.104	0.210

WWAN Mode	Position	WWAN SAR1g (W/kg)	WLAN SAR1g (W/kg)	Σ SAR (W/kg)
LTE Band 17	Right Cheek	0.034	0.469	0.503
	Right Tilted	0.023	0.318	0.341
	Left Cheek	0.041	0.173	0.214
	Left Tilted	0.025	0.115	0.140

WWAN Mode	Position	WWAN SAR1g (W/kg)	Bluetooth Estimated SAR1g (W/kg)	Σ SAR (W/kg)
LTE Band 17	Right Cheek	0.034	0.104	0.138
	Right Tilted	0.023	0.104	0.127
	Left Cheek	0.041	0.104	0.145
	Left Tilted	0.025	0.104	0.129

> **Body worn Simultaneous Transmission**

WWAN Mode	Position	WWAN SAR _{1g} (W/kg)	WLAN SAR _{1g} (W/kg)	Σ SAR (W/kg)
GSM850	Front	0.217	0.081	0.298
	Back	0.269	0.211	0.480

WWAN Mode	Position	WWAN SAR _{1g} (W/kg)	Bluetooth Estimated SAR _{1g} (W/kg)	Σ SAR (W/kg)
GSM850	Front	0.217	0.052	0.269
	Back	0.269	0.052	0.321

WWAN Mode	Position	WWAN SAR _{1g} (W/kg)	WLAN SAR _{1g} (W/kg)	Σ SAR (W/kg)
GSM 1900	Front	0.471	0.081	0.552
	Back	0.533	0.211	0.744

WWAN Mode	Position	WWAN SAR _{1g} (W/kg)	Bluetooth Estimated SAR _{1g} (W/kg)	Σ SAR (W/kg)
GSM 1900	Front	0.471	0.052	0.523
	Back	0.533	0.052	0.585

WWAN Mode	Position	WWAN SAR _{1g} (W/kg)	WLAN SAR _{1g} (W/kg)	Σ SAR (W/kg)
WCDMA Band V	Front	0.215	0.081	0.296
	Back	0.281	0.211	0.492

WWAN Mode	Position	WWAN SAR _{1g} (W/kg)	Bluetooth Estimated SAR _{1g} (W/kg)	Σ SAR (W/kg)
WCDMA Band V	Front	0.215	0.052	0.267
	Back	0.281	0.052	0.333

WWAN Mode	Position	WWAN SAR _{1g} (W/kg)	WLAN SAR _{1g} (W/kg)	Σ SAR (W/kg)
WCDMA Band II	Front	0.585	0.081	0.666
	Back	0.792	0.211	1.003

WWAN Mode	Position	WWAN SAR _{1g} (W/kg)	Bluetooth Estimated SAR _{1g} (W/kg)	Σ SAR (W/kg)
WCDMA Band II	Front	0.585	0.052	0.637
	Back	0.792	0.052	0.844

WWAN Mode	Position	WWAN SAR _{1g} (W/kg)	WLAN SAR _{1g} (W/kg)	Σ SAR (W/kg)
LTE Band 2	Front	0.840	0.081	0.921
	Back	0.888	0.211	1.099

WWAN Mode	Position	WWAN SAR _{1g} (W/kg)	Bluetooth Estimated SAR _{1g} (W/kg)	Σ SAR (W/kg)
LTE Band 2	Front	0.840	0.052	0.892
	Back	0.888	0.052	0.940

WWAN Mode	Position	WWAN SAR _{1g} (W/kg)	WLAN SAR _{1g} (W/kg)	Σ SAR (W/kg)
LTE Band 4	Front	0.793	0.081	0.874
	Back	0.812	0.211	1.023

WWAN Mode	Position	WWAN SAR _{1g} (W/kg)	Bluetooth Estimated SAR _{1g} (W/kg)	Σ SAR (W/kg)
LTE Band 4	Front	0.793	0.052	0.845
	Back	0.812	0.052	0.864

WWAN Mode	Position	WWAN SAR _{1g} (W/kg)	WLAN SAR _{1g} (W/kg)	Σ SAR (W/kg)
LTE Band 7	Front	0.525	0.081	0.606
	Back	0.480	0.211	0.691

WWAN Mode	Position	WWAN SAR _{1g} (W/kg)	Bluetooth Estimated SAR _{1g} (W/kg)	Σ SAR (W/kg)
LTE Band 7	Front	0.525	0.052	0.577
	Back	0.480	0.052	0.532

WWAN Mode	Position	WWAN SAR _{1g} (W/kg)	WLAN SAR _{1g} (W/kg)	Σ SAR (W/kg)
LTE Band 17	Front	0.071	0.081	0.152
	Back	0.104	0.211	0.315

WWAN Mode	Position	WWAN SAR _{1g} (W/kg)	Bluetooth Estimated SAR _{1g} (W/kg)	Σ SAR (W/kg)
LTE Band 17	Front	0.071	0.052	0.123
	Back	0.104	0.052	0.156

➤ Hotspot mode Simultaneous Transmission

WWAN Mode	Position	WWAN SAR _{1g} (W/kg)	WLAN SAR _{1g} (W/kg)	Σ SAR (W/kg)
GSM850	Front	0.360	0.081	0.441
	Back	0.482	0.211	0.693
	Left	0.162	/	0.162
	Right	0.405	0.009	0.414
	Top	/	0.002	0.002
	Bottom	0.202	/	0.202

WWAN Mode	Position	WWAN SAR _{1g} (W/kg)	Bluetooth Estimated SAR _{1g} (W/kg)	Σ SAR (W/kg)
GSM850	Front	0.360	0.052	0.412
	Back	0.482	0.052	0.534
	Left	0.162	/	0.162
	Right	0.405	0.052	0.457
	Top	/	0.052	0.052
	Bottom	0.202	/	0.202

WWAN Mode	Position	WWAN SAR _{1g} (W/kg)	WLAN SAR _{1g} (W/kg)	Σ SAR (W/kg)
GSM 1900	Front	0.783	0.081	0.864
	Back	0.851	0.211	1.062
	Left	0.158	/	0.158
	Right	0.172	0.009	0.181
	Top	/	0.002	0.002
	Bottom	0.907	/	0.907

WWAN Mode	Position	WWAN SAR _{1g} (W/kg)	Bluetooth Estimated SAR _{1g} (W/kg)	Σ SAR (W/kg)
GSM 1900	Front	0.783	0.052	0.835
	Back	0.851	0.052	0.903
	Left	0.158	/	0.158
	Right	0.172	0.052	0.224
	Top	/	0.052	0.052
	Bottom	0.907	/	0.907

WWAN Mode	Position	WWAN SAR _{1g} (W/kg)	WLAN SAR _{1g} (W/kg)	Σ SAR (W/kg)
WCDMA Band V	Front	0.215	0.081	0.296
	Back	0.281	0.211	0.492
	Left	0.102	/	0.102
	Right	0.226	0.009	0.235
	Top	/	0.002	0.002
	Bottom	0.122	/	0.122

WWAN Mode	Position	WWAN SAR _{1g} (W/kg)	Bluetooth Estimated SAR _{1g} (W/kg)	Σ SAR (W/kg)
WCDMA Band V	Front	0.215	0.052	0.267
	Back	0.281	0.052	0.333
	Left	0.102	/	0.102
	Right	0.226	0.052	0.278
	Top	/	0.052	0.052
	Bottom	0.122	/	0.122

WWAN Mode	Position	WWAN SAR _{1g} (W/kg)	WLAN SAR _{1g} (W/kg)	Σ SAR (W/kg)
WCDMA Band II	Front	0.585	0.081	0.666
	Back	0.792	0.211	1.003
	Left	0.092	/	0.092
	Right	0.114	0.009	0.123
	Top	/	0.002	0.002
	Bottom	0.989	/	0.989

WWAN Mode	Position	WWAN SAR _{1g} (W/kg)	Bluetooth Estimated SAR _{1g} (W/kg)	Σ SAR (W/kg)
WCDMA Band II	Front	0.585	0.052	0.637
	Back	0.792	0.052	0.844
	Left	0.092	/	0.092
	Right	0.114	0.052	0.166
	Top	/	0.052	0.052
	Bottom	0.989	/	0.989

WWAN Mode	Position	WWAN SAR1g (W/kg)	WLAN SAR1g (W/kg)	Σ SAR (W/kg)
LTE Band 2	Front	0.840	0.081	0.921
	Back	0.888	0.211	1.099
	Left	0.459	/	0.459
	Right	0.067	0.009	0.076
	Top	/	0.002	0.002
	Bottom	1.176	/	1.176

WWAN Mode	Position	WWAN SAR1g (W/kg)	Bluetooth Estimated SAR1g (W/kg)	Σ SAR (W/kg)
LTE Band 2	Front	0.840	0.052	0.892
	Back	0.888	0.052	0.940
	Left	0.459	/	0.459
	Right	0.067	0.052	0.119
	Top	/	0.052	0.052
	Bottom	1.176	/	1.176

WWAN Mode	Position	WWAN SAR1g (W/kg)	WLAN SAR1g (W/kg)	Σ SAR (W/kg)
LTE Band 4	Front	0.793	0.081	0.874
	Back	0.812	0.211	1.023
	Left	0.264	/	0.264
	Right	0.093	0.009	0.102
	Top	/	0.002	0.002
	Bottom	1.196	/	1.196

WWAN Mode	Position	WWAN SAR1g (W/kg)	Bluetooth Estimated SAR1g (W/kg)	Σ SAR (W/kg)
LTE Band 4	Front	0.793	0.052	0.845
	Back	0.812	0.052	0.864
	Left	0.264	/	0.264
	Right	0.093	0.052	0.145
	Top	/	0.052	0.052
	Bottom	1.196	/	1.196

WWAN Mode	Position	WWAN SAR1g (W/kg)	WLAN SAR1g (W/kg)	Σ SAR (W/kg)
LTE Band 7	Front	0.525	0.081	0.606
	Back	0.481	0.211	0.692
	Left	0.109	/	0.109
	Right	0.265	0.009	0.274
	Top	/	0.002	0.002
	Bottom	0.746	/	0.746

WWAN Mode	Position	WWAN SAR1g (W/kg)	Bluetooth Estimated SAR1g (W/kg)	Σ SAR (W/kg)
LTE Band 7	Front	0.525	0.052	0.577
	Back	0.481	0.052	0.533
	Left	0.109	/	0.109
	Right	0.265	0.052	0.317
	Top	/	0.052	0.052
	Bottom	0.746	/	0.746

WWAN Mode	Position	WWAN SAR1g (W/kg)	WLAN SAR1g (W/kg)	Σ SAR (W/kg)
LTE Band 17	Front	0.071	0.081	0.152
	Back	0.104	0.211	0.315
	Left	0.037	/	0.037
	Right	0.044	0.009	0.053
	Top	/	0.002	0.002
	Bottom	0.024	/	0.024

WWAN Mode	Position	WWAN SAR1g (W/kg)	Bluetooth Estimated SAR1g (W/kg)	Σ SAR (W/kg)
LTE Band 17	Front	0.071	0.052	0.123
	Back	0.104	0.052	0.156
	Left	0.037	/	0.037
	Right	0.044	0.052	0.096
	Top	/	0.052	0.052
	Bottom	0.024	/	0.024

➤ **Simultaneous Transmission Conclusion**

The above numerical summed SAR results for all the case simultaneous transmission conditions were below the SAR limit. Therefore, the above analysis is sufficient to determine that simultaneous transmission cases will not exceed the SAR limit and therefore no measured volumetric simultaneous SAR summation is required per FCC KDB Publication 447498 D01v06.

15.7 Measurement Uncertainty

The component of uncertainty may generally be categorized according to the methods used to evaluate them. The evaluation of uncertainty by the statistical analysis of a series of observations is termed a Type A evaluation of uncertainty. The evaluation of uncertainty by means other than the statistical analysis of a series of observation is termed a Type B evaluation of uncertainty. Each component of uncertainty, however evaluated, is represented by an estimated standard deviation, termed standard uncertainty, which is determined by the positive square root of the estimated variance.

A Type A evaluation of standard uncertainty may be based on any valid statistical method for treating data. This includes calculating the standard deviation of the mean of a series of independent observations; using the method of least squares to fit a curve to the data in order to estimate the parameter of the curve and their standard deviations; or carrying out an analysis of variance in order to identify and quantify random effects in certain kinds of measurement.

A Type B evaluation of standard uncertainty is typically based on scientific judgment using all of the relevant information available. These may include previous measurement data, experience, and knowledge of the behavior and properties of relevant materials and instruments, manufacture’s specification, data provided in calibration reports and uncertainties assigned to reference data taken from handbooks. Broadly speaking, the uncertainty is either obtained from an outdoor source or obtained from an assumed distribution, such as the normal distribution, rectangular or triangular distributions indicated in below Table.

Uncertainty Distributions	Normal	Rectangular	Triangular	U-Shape
Multi-plying Factor	1/k(b)	$1/\sqrt{3}$	$1/\sqrt{6}$	$1/\sqrt{2}$

Standard Uncertainty for Assumed Distribution

The combined standard uncertainty of the measurement result represents the estimated standard deviation of the result. It is obtained by combining the individual standard uncertainties of both Type A and Type B evaluation using the usual “root-sum-squares” (RSS) methods of combining standard deviations by taking the positive square root of the estimated variances.

Expanded uncertainty is a measure of uncertainty that defines an interval about the measurement result within which the measured value is confidently believed to lie. It is obtained by multiplying the combined standard uncertainty by a coverage factor. Typically, the coverage factor ranges from 2 to 3. Using a coverage factor allows the true value of a measured quantity to be specified with a defined probability within the specified uncertainty range. For purpose of this document, a coverage factor two is used, which corresponds to confidence interval of about 95 %. The DASY uncertainty Budget is shown in the following tables.

Uncertainty Component	Section	Uncert. Value	Prob. Dist.	Div.	(C _i) (1 g)	(C _i) (10 g)	Std. Unc. (1 g)	Std. Unc. (10 g)	V _i
Measurement System									
Probe Calibration	E.2.1	±6.0%	N	1	1	1	±6.0%	±6.0%	∞
Axial Isotropy	E.2.2	±0.5%	R	$\sqrt{3}$	0.7	0.7	±0.20%	±0.20%	∞
Hemispherical Isotropy	E.2.2	±2.6%	R	$\sqrt{3}$	0.7	0.7	±1.05%	±1.05%	∞
Boundary Effects	E.2.3	±1.0%	R	$\sqrt{3}$	1	1	±0.58%	±0.58%	∞
Linearity	E.2.4	±0.6%	R	$\sqrt{3}$	1	1	±0.35%	±0.35%	∞
System Detection Limits	E.2.5	±0.25%	R	$\sqrt{3}$	1	1	±0.14%	±0.14%	∞
Readout Electronics	E.2.6	±0.3%	N	1	1	1	±0.3%	±0.3%	∞
Response Time	E.2.7	±0.8%	R	$\sqrt{3}$	1	1	±0.46%	±0.46%	∞
Integration Time	E.2.8	±2.6%	R	$\sqrt{3}$	1	1	±1.5%	±1.5%	∞
RF Ambient Noise	E.6.1	±3.0%	R	$\sqrt{3}$	1	1	±1.73%	±1.73%	∞
RF Ambient Reflections	E.6.1	±3.0%	R	$\sqrt{3}$	1	1	±1.73%	±1.73%	∞
Probe positioner mechanical tolerances	E.6.2	±0.4%	R	$\sqrt{3}$	1	1	±0.23%	±0.23%	∞
Probe positioning tolerance with respect to the phantom shell surface	E.6.3	±2.9%	R	$\sqrt{3}$	1	1	±1.67%	±1.67%	∞
Interpolation, extrapolation, and integration algorithm For max. SAR Evaluation.	E.5	±1.0%	R	$\sqrt{3}$	1	1	±0.58%	±0.58%	∞
Test Sample Related									
Device Positioning	E.4.2	±4.6%	N	1	1	1	±4.6%	±4.6%	M-1
Device Holder	E.4.1	±5.2%	N	1	1	1	±5.2%	±5.2%	M-1
Power Drift	6.6.2	±5.0%	R	$\sqrt{3}$	1	1	±2.89%	±2.89%	∞
Phantom and Setup									
Phantom Uncertainty	E.3.1	±4.0%	R	$\sqrt{3}$	1	1	±2.31%	±2.31%	∞
Liquid Conductivity(Target)	E.3.2	±5.0%	R	$\sqrt{3}$	0.64	0.43	±1.85%	±1.24%	∞
Liquid Conductivity(Meas.)	E.3.3	±2.5%	N	1	0.64	0.43	±1.64%	±1.08%	M
Liquid Permittivity(Target)	E.3.2	±5.0%	R	$\sqrt{3}$	0.6	0.49	±1.73%	±1.41%	∞
Liquid Permittivity(Meas.)	E.3.3	±2.5%	N	1	0.6	0.49	±1.5%	±1.23%	M
Combined Standard Uncertainty (RSS)							±11.07%	±10.84%	
Expanded Uncertainty (95% Confidence Level, k = 2)							±22.2%	±21.7%	

Uncertainty Budget for frequency range 300 MHz to 3 GHz according to IEEE1528-2013

15.8 Measurement Conclusion

The SAR evaluation indicates that the EUT complies with the RF radiation exposure limits of the FCC and Industry Canada, with respect to all parameters subject to this test. These measurements were taken to simulate the RF effects of RF exposure under worst-case conditions. Precise laboratory measures were taken to assure repeatability of the tests. The results and statements relate only to the item(s) tested. Please note that the absorption and distribution of electromagnetic energy in the body are very complex phenomena that depend on the mass, shape, and size of the body, the orientation of the body with respect to the field vectors, and the electrical properties of both the body and the environment. Other variables that may play a substantial role in possible biological effects are those that characterize the environment (e.g. ambient temperature, air velocity, relative humidity, and body insulation) and those that characterize the individual (e.g. age, gender, activity level, debilitation, or disease). Because various factors may interact with one another to vary the specific biological outcome of an exposure to electromagnetic fields, any protection guide should consider maximal amplification of biological effects as a result of field-body interactions, environmental conditions, and physiological variables.

16 Reference

- [1]. FCC 47 CFR Part 2 “Frequency Allocations and Radio Treaty Matters; General Rules and Regulations”
- [2]. ANSI/IEEE Std. C95.1-1992, “IEEE Standard for Safety Levels with Respect to Human Exposure to Radio Frequency Electromagnetic Fields, 3 kHz to 300 GHz”, September 1992
- [3]. IEEE Std. 1528-2013, “Recommended Practice for Determining the Peak Spatial-Average Specific Absorption Rate (SAR) in the Human Head from Wireless Communications Devices: Measurement Techniques”, September 2013
- [4]. SPEAG DASY52 System Handbook
- [5]. FCC KDB 248227 D01 v02r02, “SAR GUIDANCE FOR IEEE 802.11 (Wi-Fi) TRANSMITTERS”, October 2015
- [6]. FCC KDB 447498 D01 v06, “RF EXPOSURE PROCEDURES AND EQUIPMENT AUTHORIZATION POLICIES FOR MOBILE AND PORTABLE DEVICES”, October 2015
- [7]. FCC KDB 648474 D04 v01r03, “SAR EVALUATION CONSIDERATIONS FOR WIRELESS HANDSETS”, October 2015
- [8]. FCC KDB 941225 D01 v03r01, “3G SAR MEASUREMENT PROCEDURES”, October 2015
- [9]. FCC KDB 941225 D05 v02r05, “SAR EVALUATION CONSIDERATIONS FOR LTE DEVICES”, Dec 2015
- [10]. FCC KDB 941225 D03 v01, “Recommended SAR Test Reduction Procedures for GSM / GPRS / EDGE”, December 2008
- [11]. FCC KDB 941225 D06 v02r01, “SAR EVALUATION PROCEDURES FOR PORTABLE DEVICES WITH WIRELESS ROUTER CAPABILITIES”, October 2015
- [12]. FCC KDB 865664 D01 v01r04, “SAR MEASUREMENT REQUIREMENTS FOR 100 MHz TO 6 GHz”, August 2015

Appendix A: EUT Photos



Appendix B: Test Setup Photos

Head

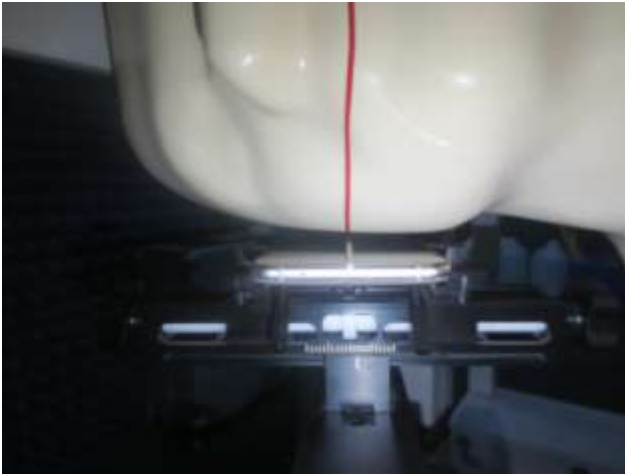

Right Cheek

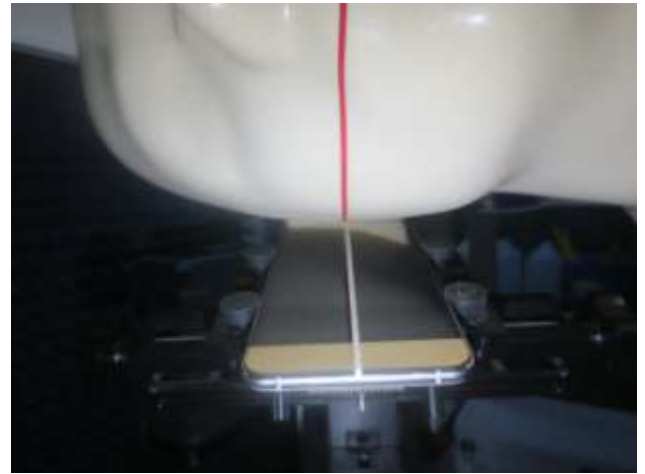

Right Tilted

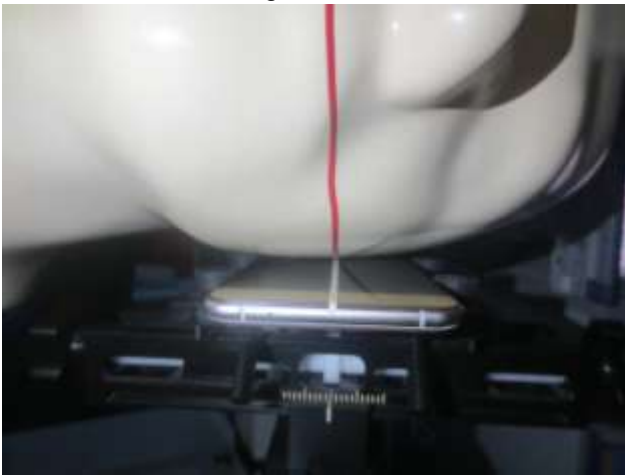

Left Cheek

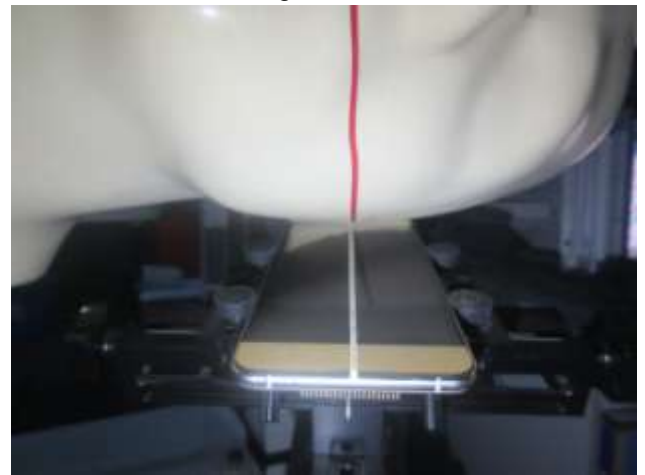

Left Tilted

Body



Front side (10mm)



Back side(10mm)



Top side(10mm)



Bottom side(10mm)



Left side(10mm)



Right side(10mm)

Appendix C: Plots of SAR System Check

Test Laboratory: CCIS

Date/Time: 07.03.2016 08:53:48

DUT: HAC Dipole 700 MHz; Type: CD700V3; Serial: SN:1118

Communication System: UID 0, CW (0); Frequency: 750 MHz

Medium parameters used: $f = 750 \text{ MHz}$; $\sigma = 0.868 \text{ S/m}$; $\epsilon_r = 42.135$; $\rho = 1000 \text{ kg/m}^3$

Phantom section: Flat Section

Measurement Standard: DASYS (IEEE/IEC/ANSI C63.19-2007)

DASY Configuration:

- Probe: EX3DV4 - SN3924; ConvF(9.95, 9.95, 9.95); Calibrated: 07.10.2015;
- Sensor-Surface: 2mm (Mechanical Surface Detection), $z = 31.0$
- Electronics: DAE4 Sn1373; Calibrated: 02.11.2016
- Phantom: SAM 5.0; Type: QD000P40CD; Serial: TP:1765
- DASYS2 52.8.8(1222); SEMCAD X 14.6.10(7331)

System Performance Check at Frequency 750 MHz Head Tissue/ $d=15\text{mm}$, $P_{in}=80 \text{ mW}$, $dist=2.0\text{mm}$ (EX-Probe)/Zoom Scan (7x7x7) (5x5x7)/Cube 0:

Measurement grid: $dx=8\text{mm}$, $dy=8\text{mm}$, $dz=5\text{mm}$

Reference Value = 34.091 V/m ; Power Drift = -0.10 dB

Peak SAR (extrapolated) = 0.989 W/kg

SAR(1 g) = 0.672 W/kg ; SAR(10 g) = 0.441 W/kg

Maximum value of SAR (measured) = 0.834 W/kg

System Performance Check at Frequency 750 MHz Head Tissue/ $d=15\text{mm}$, $P_{in}=80 \text{ mW}$, $dist=2.0\text{mm}$ (EX-Probe)/Area Scan (41x131x1): Interpolated grid:

$dx=1.500 \text{ mm}$, $dy=1.500 \text{ mm}$

Maximum value of SAR (interpolated) = 0.837 W/kg

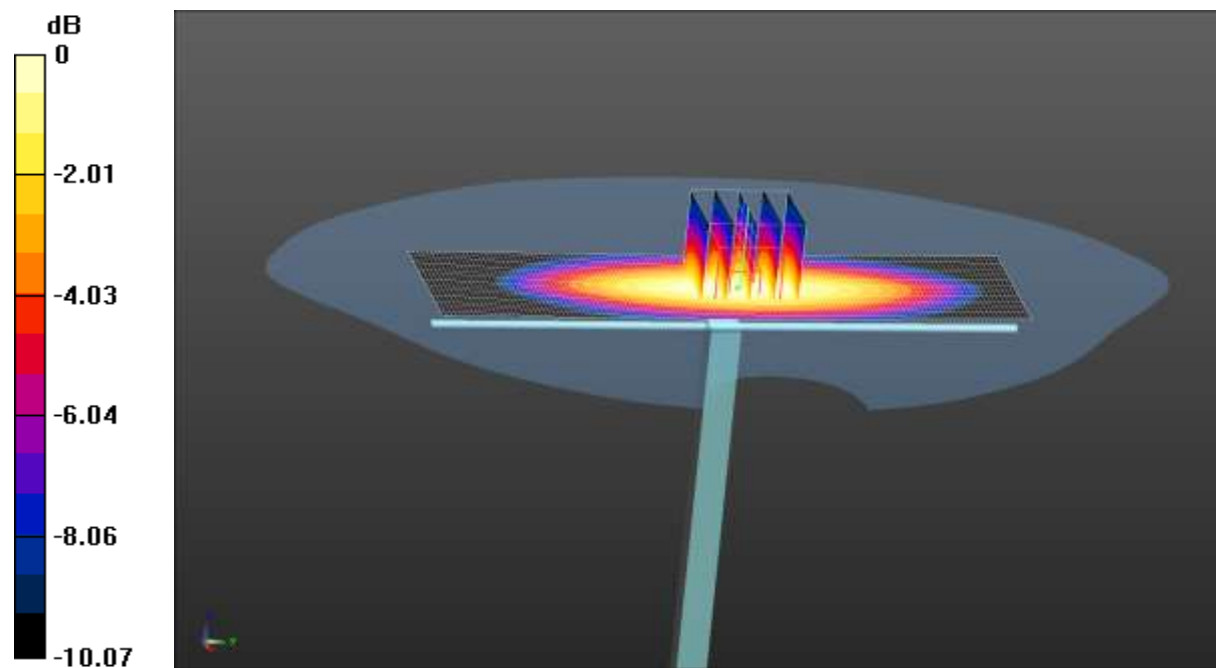

0 dB = 0.837 W/kg = -0.77 dBW/kg

Test Laboratory: CCIS

Date/Time: 07.01.2016 14:29:11

DUT: Dipole 900 MHz; Type: D900V2; Serial: 1d086

Communication System: UID 0, CW (0); Frequency: 900 MHz

Medium parameters used: $f = 900 \text{ MHz}$; $\sigma = 0.898 \text{ S/m}$; $\epsilon_r = 42.101$; $\rho = 1000 \text{ kg/m}^3$

Phantom section: Flat Section

Measurement Standard: DASY5 (IEEE/IEC/ANSI C63.19-2007)

DASY Configuration:

- Probe: EX3DV4 - SN3924; ConvF(9.42, 9.42, 9.42); Calibrated: 07.10.2015;
- Sensor-Surface: 2mm (Mechanical Surface Detection), $z = 1.0, 31.0$
- Electronics: DAE4 Sn1373; Calibrated: 02.11.2016
- Phantom: SAM 5.0; Type: QD000P40CD; Serial: TP:1765
- DASY52 52.8.8(1222); SEMCAD X 14.6.10(7331)

System Performance Check at Frequency 900MHz Head Tissue/d=15mm, Pin=80 mW, dist=2.0mm (EX-Probe)/Area Scan (41x131x1): Interpolated grid: $dx=1.500 \text{ mm}$, $dy=1.500 \text{ mm}$
 Maximum value of SAR (interpolated) = 1.19 W/kg

System Performance Check at Frequency 900MHz Head Tissue/d=15mm, Pin=80 mW, dist=2.0mm (EX-Probe)/Zoom Scan (7x7x7) (5x5x7)/Cube 0:
 Measurement grid: $dx=8\text{mm}$, $dy=8\text{mm}$, $dz=5\text{mm}$
 Reference Value = 37.84 V/m; Power Drift = 0.09 dB
 Peak SAR (extrapolated) = 1.35 W/kg
SAR(1 g) = 0.833 W/kg; SAR(10 g) = 0.542W/kg
 Maximum value of SAR (measured) = 1.22 W/kg

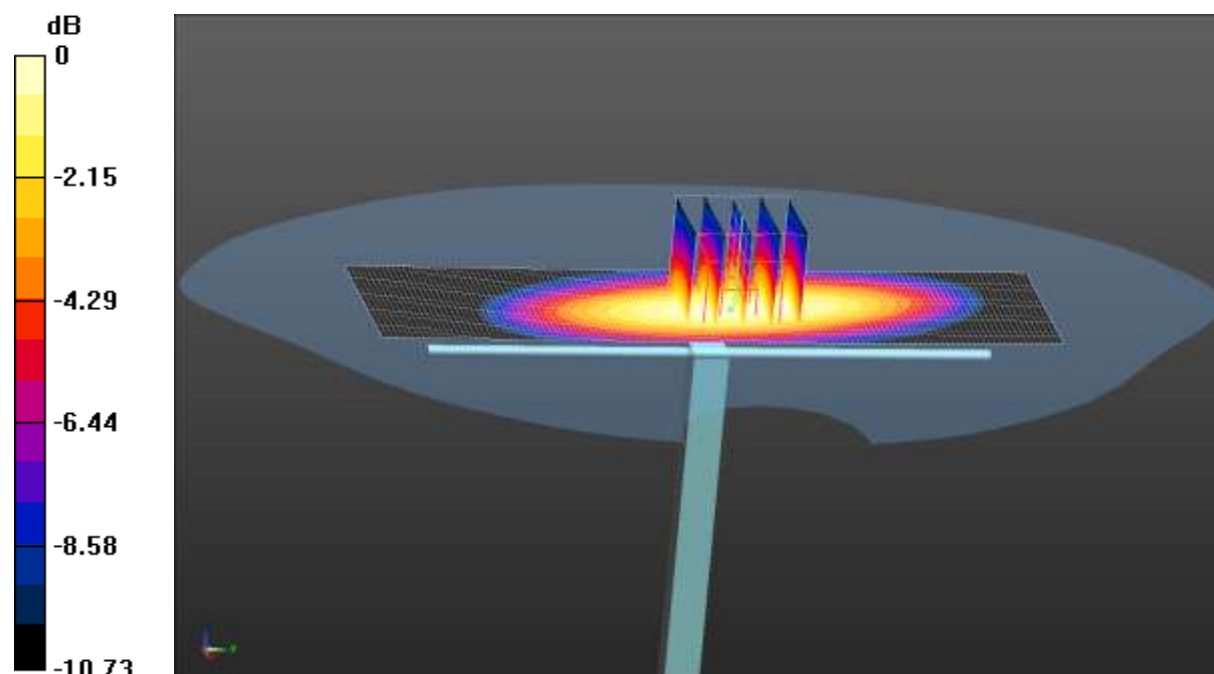

0 dB = 1.22 W/kg = 0.86 dBW/kg

Test Laboratory: CCIS

Date/Time: 07.05.2016 07:38:50

DUT: Dipole 1750 MHz D1750V2; Type: D1750V2; Serial: 1062

Communication System: UID 0, CW (0); Frequency: 1750 MHz

Medium parameters used: $f = 1750$ MHz; $\sigma = 1.388$ S/m; $\epsilon_r = 38.908$; $\rho = 1000$ kg/m³

Phantom section: Flat Section

Measurement Standard: DASYS5 (IEEE/IEC/ANSI C63.19-2007)

DASY Configuration:

- Probe: EX3DV4 - SN3924; ConvF(8.37, 8.37, 8.37); Calibrated: 07.10.2015;
- Sensor-Surface: 2mm (Mechanical Surface Detection), $z = 1.0, 31.0$
- Electronics: DAE4 Sn1373; Calibrated: 02.11.2016
- Phantom: SAM 5.0; Type: QD000P40CD; Serial: TP:1765
- DASYS2 52.8.8(1222); SEMCAD X 14.6.10(7331)

System Performance Check at Frequency 1750MHz Head Tissue/d=10mm, Pin=40 mW, dist=2.0mm (EX-Probe)/Zoom Scan (7x7x7) (5x5x7)/Cube 0:

Measurement grid: $dx=8$ mm, $dy=8$ mm, $dz=5$ mm

Reference Value = 33.05 V/m; Power Drift = 0.04 dB

Peak SAR (extrapolated) = 2.42 W/kg

SAR(1 g) = 1.38 W/kg; SAR(10 g) = 0.664 W/kg

Maximum value of SAR (measured) = 2.12 W/kg

System Performance Check at Frequency 1750MHz Head Tissue/d=10mm, Pin=10 mW, dist=2.0mm (EX-Probe)/Area Scan (41x51x1): Interpolated grid:

$dx=1.500$ mm, $dy=1.500$ mm

Maximum value of SAR (interpolated) = 2.11 W/kg

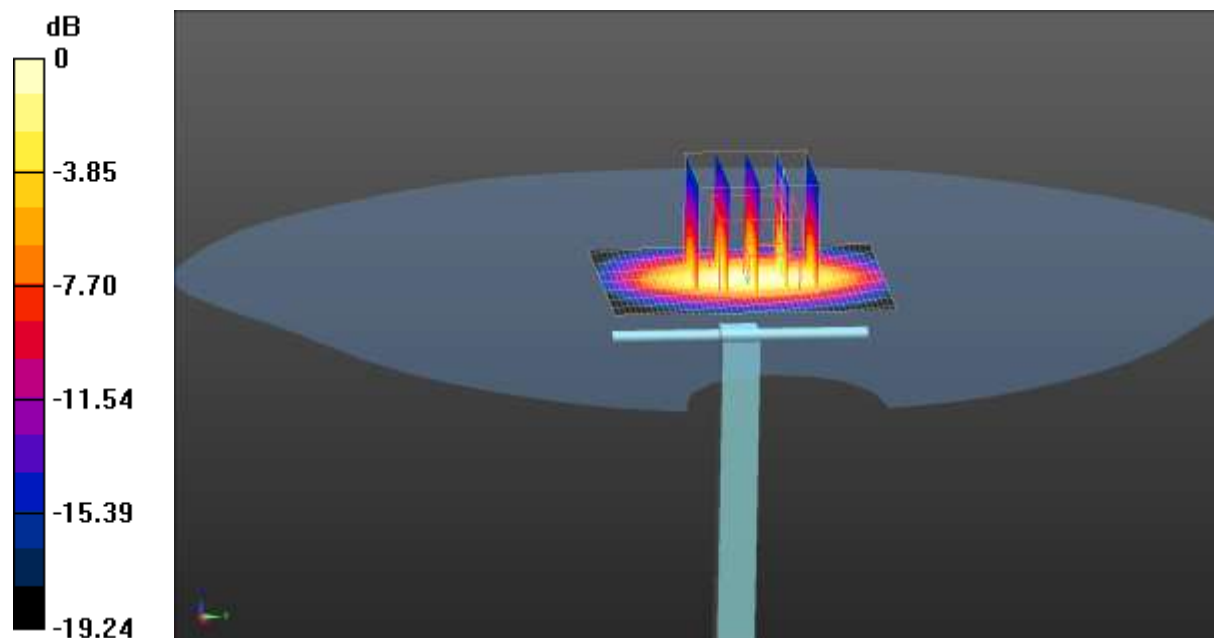

0 dB = 2.11 W/kg = 3.24 dBW/kg

Test Laboratory: CCIS

Date/Time: 07.05.2016 08:01:16

DUT: Dipole 1900 MHz; Type: D1900V2; Serial: 5d194

Communication System: UID 0, CW (0); Frequency: 1900 MHz

Medium parameters used: $f = 1900$ MHz; $\sigma = 1.415$ S/m; $\epsilon_r = 40.06$; $\rho = 1000$ kg/m³

Phantom section: Flat Section

Measurement Standard: DASYS (IEEE/IEC/ANSI C63.19-2007)

DASY Configuration:

- Probe: EX3DV4 - SN3924; ConvF(7.95, 7.95, 7.95); Calibrated: 07.10.2015;
- Sensor-Surface: 2mm (Mechanical Surface Detection), $z = 1.0, 31.0$
- Electronics: DAE4 Sn1373; Calibrated: 02.11.2016
- Phantom: SAM 5.0; Type: QD000P40CD; Serial: TP:1765
- DASYS2 52.8.8(1222); SEMCAD X 14.6.10(7331)

System Performance Check at Frequency 1900MHz Head Tissue/d=10mm, Pin=40 mW, dist=2.0mm (EX-Probe)/Area Scan (41x51x1): Interpolated grid: $dx=1.500$ mm, $dy=1.500$ mm

Maximum value of SAR (interpolated) = 2.43 W/kg

System Performance Check at Frequency 1900MHz Head Tissue/d=10mm, Pin=40 mW, dist=2.0mm (EX-Probe)/Zoom Scan (7x7x7) (5x5x7)/Cube 0:

Measurement grid: $dx=8$ mm, $dy=8$ mm, $dz=5$ mm

Reference Value = 40.09 V/m; Power Drift = -0.05 dB

Peak SAR (extrapolated) = 3.09 W/kg

SAR(1 g) = 1.65 W/kg; SAR(10 g) = 0.782 W/kg

Maximum value of SAR (measured) = 2.33 W/kg

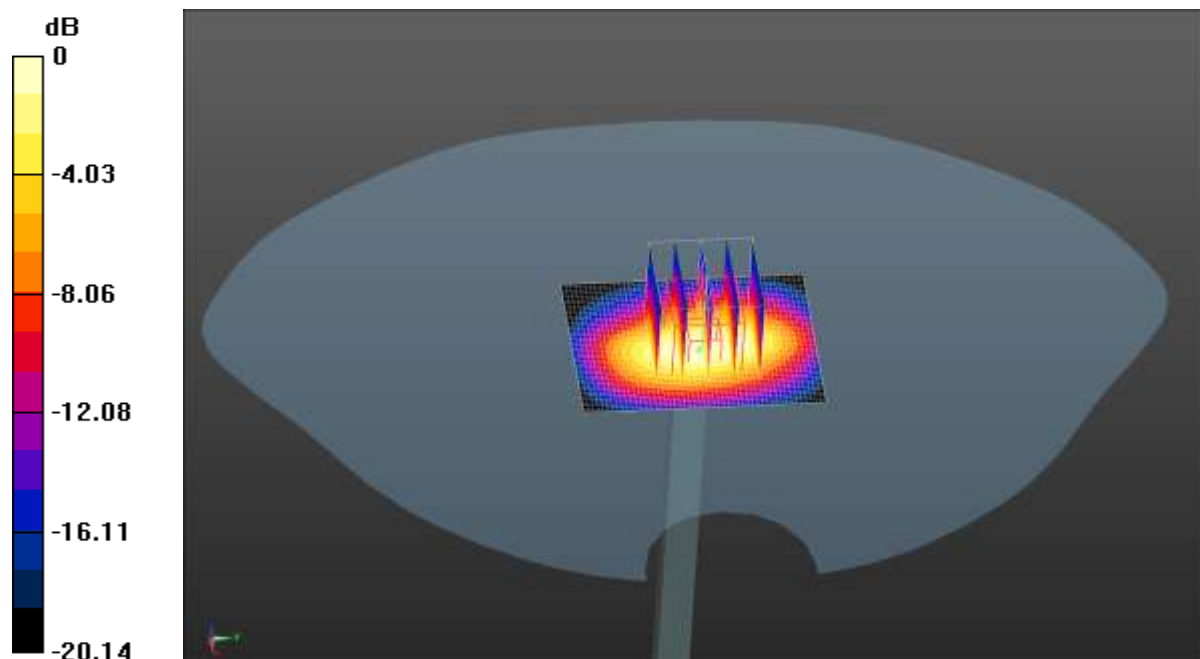

0 dB = 2.33 W/kg = 3.67 dBW/kg

Test Laboratory: CCIS

Date/Time: 07.07.2016 13:05:37

DUT: Dipole 2450 MHz; Type: D2450V2; Serial: SN: 955

Communication System: UID 0, CW (0); Frequency: 2450 MHz

Medium parameters used: $f = 2450 \text{ MHz}$; $\sigma = 1.819 \text{ S/m}$; $\epsilon_r = 38.918$; $\rho = 1000 \text{ kg/m}^3$

Phantom section: Flat Section

Measurement Standard: DASYS5 (IEEE/IEC/ANSI C63.19-2007)

DASY Configuration:

- Probe: EX3DV4 - SN3924; ConvF(7.17, 7.17, 7.17); Calibrated: 07.10.2015;
- Sensor-Surface: 2mm (Mechanical Surface Detection), $z = 1.0, 31.0$
- Electronics: DAE4 Sn1373; Calibrated: 02.11.2016
- Phantom: SAM 5.0; Type: QD000P40CD; Serial: TP:1765
- DASY52 52.8.8(1222); SEMCAD X 14.6.10(7331)

System Performance Check at Frequency 2450MHz Head Tissue/d=10mm, Pin=40 mW, dist=2.0mm (EX-Probe)/Area Scan (51x61x1): Interpolated grid: $dx=1.200 \text{ mm}$, $dy=1.200 \text{ mm}$
 Maximum value of SAR (interpolated) = 3.73 W/kg

System Performance Check at Frequency 2450MHz Head Tissue/d=10mm, Pin=40 mW, dist=2.0mm (EX-Probe)/Zoom Scan (7x7x7) (7x7x7)/Cube 0:
 Measurement grid: $dx=5\text{mm}$, $dy=5\text{mm}$, $dz=5\text{mm}$
 Reference Value = 40.02 V/m; Power Drift = 0.07 dB
 Peak SAR (extrapolated) = 4.63 W/kg
SAR(1 g) = 2.16 W/kg; SAR(10 g) = 0.992 W/kg
 Maximum value of SAR (measured) = 3.52 W/kg

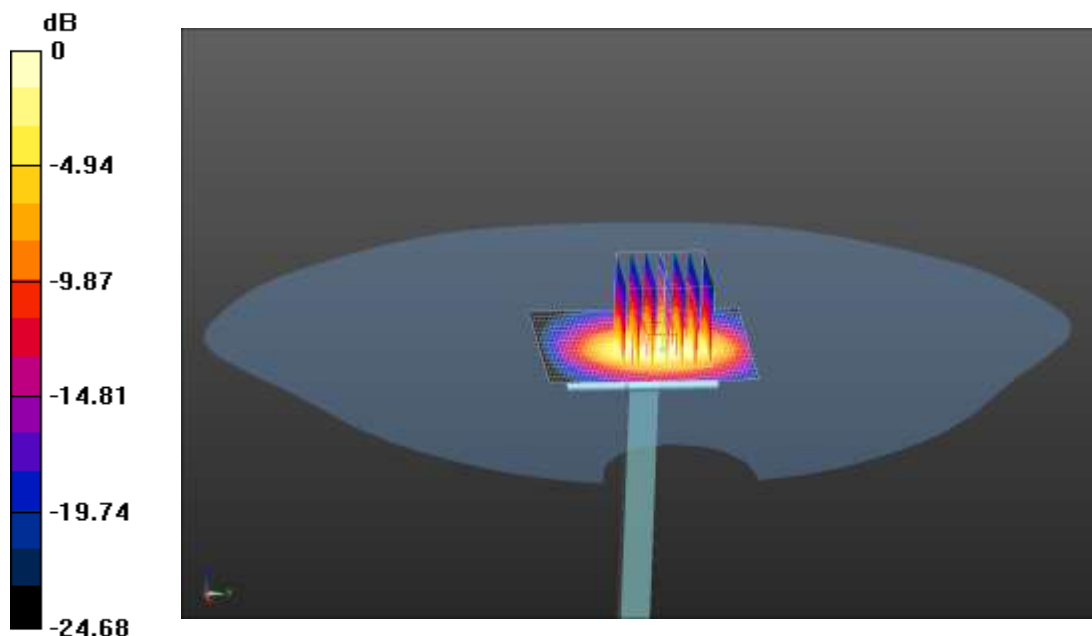

0 dB = 3.52 W/kg = 5.47 dBW/kg

Test Laboratory: CCIS

Date/Time: 07.07.2016 12:29:05

DUT: Dipole 2600 MHz D2600V2; Type: SAAAD245BB; Serial: D2600V2 - SN:1114

Communication System: UID 0, CW (0); Frequency: 2600 MHz

Medium parameters used: $f = 2600$ MHz; $\sigma = 1.997$ S/m; $\epsilon_r = 38.051$; $\rho = 1000$ kg/m³

Phantom section: Flat Section

Measurement Standard: DASYS5 (IEEE/IEC/ANSI C63.19-2007)

DASY Configuration:

- Probe: EX3DV4 - SN3924; ConvF(7.04, 7.04, 7.04); Calibrated: 07.10.2015;
- Sensor-Surface: 2mm (Mechanical Surface Detection), $z = 31.0$
- Electronics: DAE4 Sn1373; Calibrated: 02.11.2016
- Phantom: SAM 5.0; Type: QD000P40CD; Serial: TP:1765
- DASYS2 52.8.8(1222); SEMCAD X 14.6.10(7331)

System Performance Check at Frequency 2600MHz Head Tissue/d=10mm, Pin=40 mW, dist=2.0mm (EX-Probe)/Zoom Scan(7X7X7) (7x7x7)/Cube 0:

Measurement grid: $dx=5$ mm, $dy=5$ mm, $dz=5$ mm

Reference Value = 41.72 V/m; Power Drift = -0.11 dB

Peak SAR (extrapolated) = 5.14 W/kg

SAR(1 g) = 2.27 W/kg; SAR(10 g) = 0.970 W/kg

Maximum value of SAR (measured) = 3.63 W/kg

System Performance Check at Frequency 2600MHz Head Tissue/d=10mm, Pin=40 mW, dist=2.0mm (EX-Probe)/Area Scan (51x61x1): Interpolated grid:

$dx=1.200$ mm, $dy=1.200$ mm

Maximum value of SAR (interpolated) = 3.92 W/kg

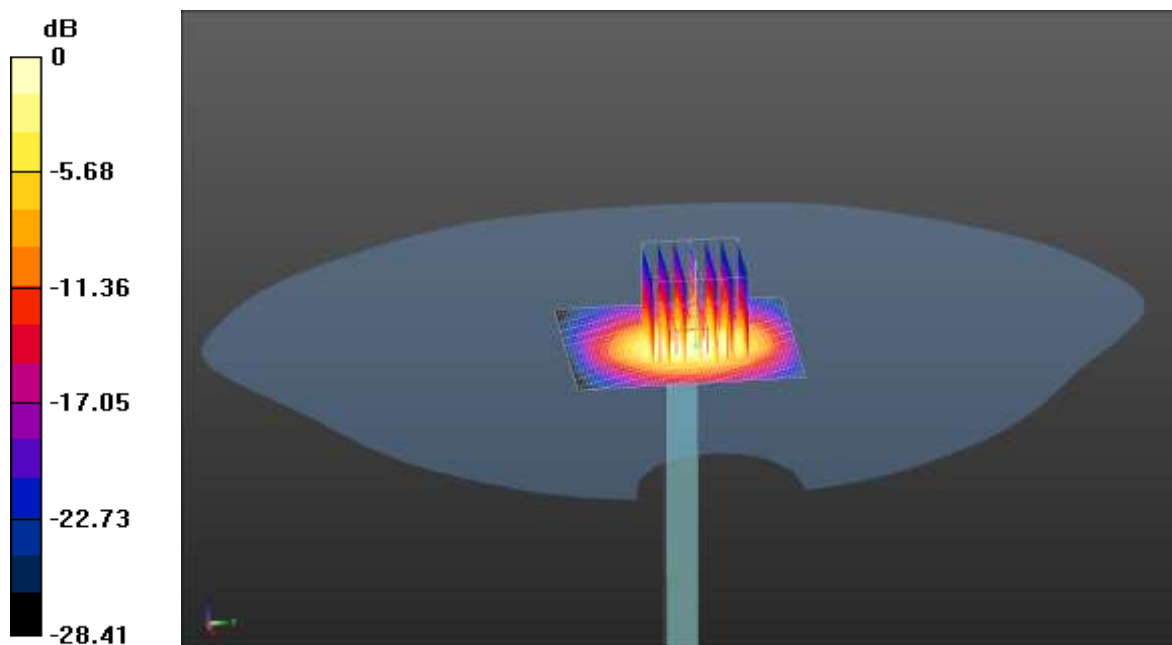

0 dB = 3.92 W/kg = 5.93 dBW/kg

Test Laboratory: CCIS

Date/Time: 07.03.2016 08:11:25

DUT: Dipole 750 MHz; Type: D750V3; Serial: SN:1118

Communication System: UID 0, CW (0); Frequency: 750 MHz

Medium parameters used: $f = 750 \text{ MHz}$; $\sigma = 0.971 \text{ S/m}$; $\epsilon_r = 54.904$; $\rho = 1000 \text{ kg/m}^3$

Phantom section: Flat Section

Measurement Standard: DASY5 (IEEE/IEC/ANSI C63.19-2007)

DASY Configuration:

- Probe: EX3DV4 - SN3924; ConvF(9.9, 9.9, 9.9); Calibrated: 07.10.2015;
- Sensor-Surface: 2mm (Mechanical Surface Detection), $z = 31.0$
- Electronics: DAE4 Sn1373; Calibrated: 02.11.2016
- Phantom: ELI v5.0; Type: QDOVA002AA; Serial: TP:1208
- DASY52 52.8.8(1222); SEMCAD X 14.6.10(7331)

System Performance Check at Frequency 750 MHz Body Tissue/d=15mm, Pin=80 mW, dist=2.0mm (EX-Probe)/Zoom Scan (7x7x7) (5x5x7)/Cube 0:

Measurement grid: $dx=8\text{mm}$, $dy=8\text{mm}$, $dz=5\text{mm}$

Reference Value = 32.34 V/m; Power Drift = -0.06 dB

Peak SAR (extrapolated) = 1.06 W/kg

SAR(1 g) = 0.718 W/kg; SAR(10 g) = 0.475 W/kg

Maximum value of SAR (measured) = 0.900 W/kg

System Performance Check at Frequency 750 MHz Body Tissue/d=15mm, Pin=80 mW, dist=2.0mm (EX-Probe)/Area Scan (41x131x1): Interpolated grid:

$dx=1.500 \text{ mm}$, $dy=1.500 \text{ mm}$

Maximum value of SAR (interpolated) = 0.904 W/kg

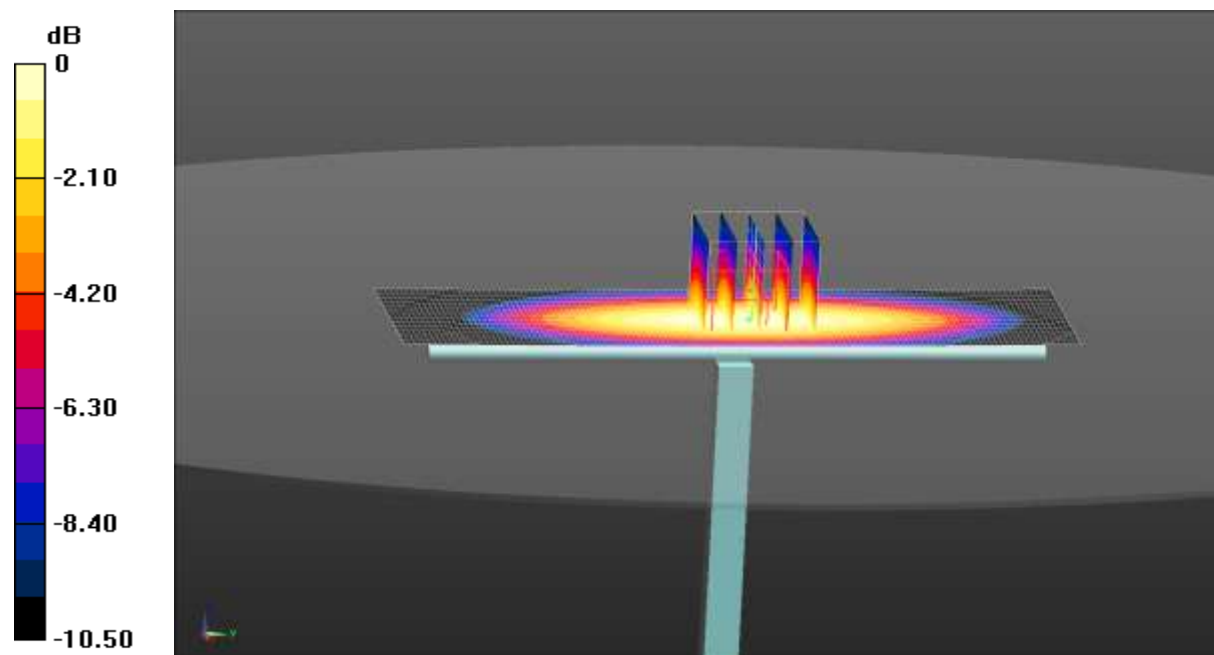

0 dB = 0.904 W/kg = -0.44 dBW/kg

Test Laboratory: CCIS

Date/Time: 07.02.2016 09:46:31

DUT: Dipole 900 MHz; Type: D900V2; Serial: 1d086

Communication System: UID 0, CW (0); Frequency: 900 MHz

Medium parameters used (interpolated): $f = 900$ MHz; $\sigma = 0.992$ S/m; $\epsilon_r = 53.623$; $\rho = 1000$ kg/m³

Phantom section: Flat Section

Measurement Standard: DASY5 (IEEE/IEC/ANSI C63.19-2007)

DASY Configuration:

- Probe: EX3DV4 - SN3924; ConvF(9.51, 9.51, 9.51); Calibrated: 07.10.2015;
- Sensor-Surface: 2mm (Mechanical Surface Detection), $z = 1.0, 31.0$
- Electronics: DAE4 Sn1373; Calibrated: 02.11.2016
- Phantom: ELI v5.0; Type: QDOVA002AA; Serial: TP:1208
- DASY52 52.8.8(1222); SEMCAD X 14.6.10(7331)

System Performance Check at Frequency 900 MHz Body Tissue/d=15mm, Pin=80 mW, dist=2.0mm (EX-Probe)/Area Scan (41x131x1): Interpolated grid: dx=1.500 mm, dy=1.500 mm

Maximum value of SAR (interpolated) = 1.02 W/kg

System Performance Check at Frequency 900 MHz Body Tissue/d=15mm, Pin=80 mW, dist=2.0mm (EX-Probe)/Zoom Scan (7x7x7) (5x5x7)/Cube 0:

Measurement grid: dx=8mm, dy=8mm, dz=5mm

Reference Value = 33.105 V/m; Power Drift = 0.09 dB

Peak SAR (extrapolated) = 1.11 W/kg

SAR(1 g) = 0.818 W/kg; SAR(10 g) = 0.515 W/kg

Maximum value of SAR (measured) = 1.01 W/kg

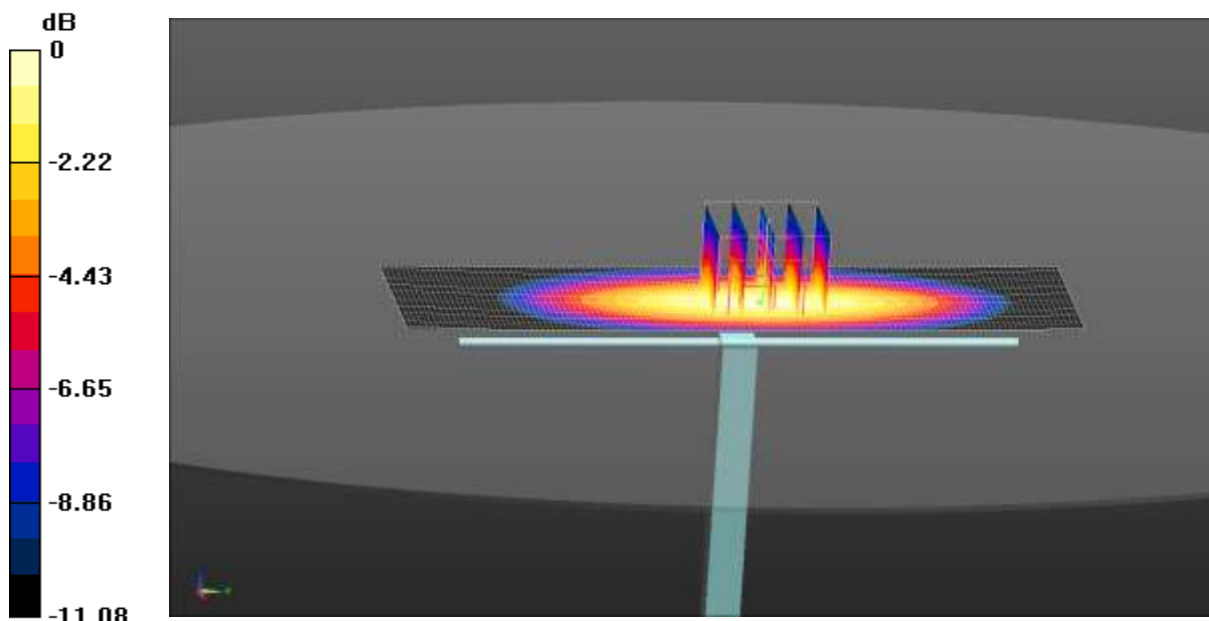

0 dB = 1.01 W/kg = 0.043 dBW/kg

Test Laboratory: CCIS

Date/Time: 07.04.2016 07:42:57

DUT: Dipole 1750 MHz D1750V2; Type: D1750V2; Serial: 1062

Communication System: UID 0, CW (0); Frequency: 1750 MHz

Medium parameters used: $f = 1750 \text{ MHz}$; $\sigma = 1.496 \text{ S/m}$; $\epsilon_r = 52.342$; $\rho = 1000 \text{ kg/m}^3$

Phantom section: Flat Section

Measurement Standard: DASYS5 (IEEE/IEC/ANSI C63.19-2007)

DASY Configuration:

- Probe: EX3DV4 - SN3924; ConvF(7.94, 7.94, 7.94); Calibrated: 07.10.2015;
- Sensor-Surface: 2mm (Mechanical Surface Detection), $z = 1.0, 31.0$
- Electronics: DAE4 Sn1373; Calibrated: 02.11.2016
- Phantom: ELI v5.0; Type: QDOVA002AA; Serial: TP:1208
- DASYS2 52.8.8(1222); SEMCAD X 14.6.10(7331)

System Performance Check at Frequency 1750MHz Body Tissue/d=10mm, Pin=40 mW, dist=2.0mm (EX-Probe)/Area Scan (41x51x1): Interpolated grid: $dx=1.500 \text{ mm}$, $dy=1.500 \text{ mm}$

Maximum value of SAR (interpolated) = 2.15 W/kg

System Performance Check at Frequency 1750MHz Body Tissue/d=10mm, Pin=40 mW, dist=2.0mm (EX-Probe)/Zoom Scan (7x7x7) (5x5x7)/Cube 0:

Measurement grid: $dx=8\text{mm}$, $dy=8\text{mm}$, $dz=5\text{mm}$

Reference Value = 32.029 V/m; Power Drift = 0.13 dB

Peak SAR (extrapolated) = 2.63 W/kg

SAR(1 g) = 1.48 W/kg; SAR(10 g) = 0.795 W/kg

Maximum value of SAR (measured) = 2.07 W/kg

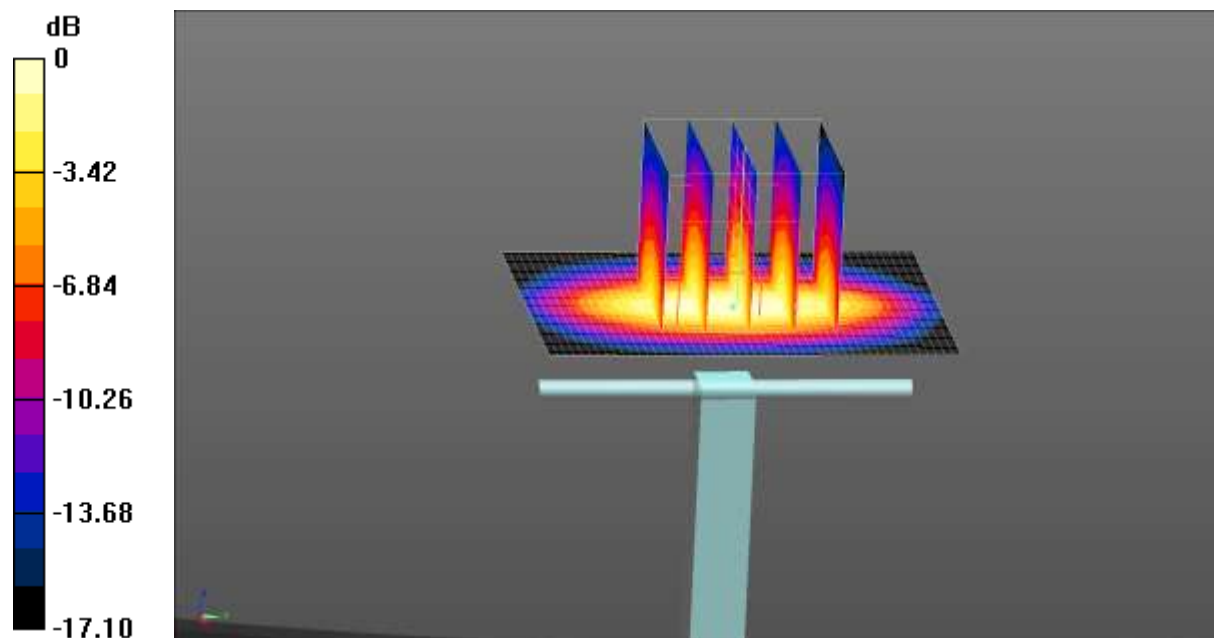

0 dB = 2.07 W/kg = 3.16 dBW/kg

Test Laboratory: CCIS

Date/Time: 07.04.2016 08:13:57

DUT: Dipole 1900 MHz; Type: D1900V2; Serial: 5d194

Communication System: UID 0, CW (0); Frequency: 1900 MHz

Medium parameters used: $f = 1900 \text{ MHz}$; $\sigma = 1.516 \text{ S/m}$; $\epsilon_r = 53.458$; $\rho = 1000 \text{ kg/m}^3$

Phantom section: Flat Section

Measurement Standard: DASYS5 (IEEE/IEC/ANSI C63.19-2007)

DASY Configuration:

- Probe: EX3DV4 - SN3924; ConvF(7.65, 7.65, 7.65); Calibrated: 07.10.2015;
- Sensor-Surface: 2mm (Mechanical Surface Detection), $z = 1.0, 31.0$
- Electronics: DAE4 Sn1373; Calibrated: 02.11.2016
- Phantom: ELI v5.0; Type: QDOVA002AA; Serial: TP:1208
- DASYS2 52.8.8(1222); SEMCAD X 14.6.10(7331)

System Performance Check at Frequency 1900MHz Body Tissue/d=10mm, Pin=40 mW, dist=2.0mm (EX-Probe)/Area Scan (41x51x1): Interpolated grid: $dx=1.500 \text{ mm}$, $dy=1.500 \text{ mm}$
 Maximum value of SAR (interpolated) = 2.38 W/kg

System Performance Check at Frequency 1900MHz Body Tissue/d=10mm, Pin=40 mW, dist=2.0mm (EX-Probe)/Zoom Scan (7x7x7) (5x5x7)/Cube 0:
 Measurement grid: $dx=8\text{mm}$, $dy=8\text{mm}$, $dz=5\text{mm}$
 Reference Value = 38.31 V/m; Power Drift = -0.13 dB
 Peak SAR (extrapolated) = 2.85 W/kg
SAR(1 g) = 1.66 W/kg; SAR(10 g) = 0.833 W/kg
 Maximum value of SAR (measured) = 2.25 W/kg

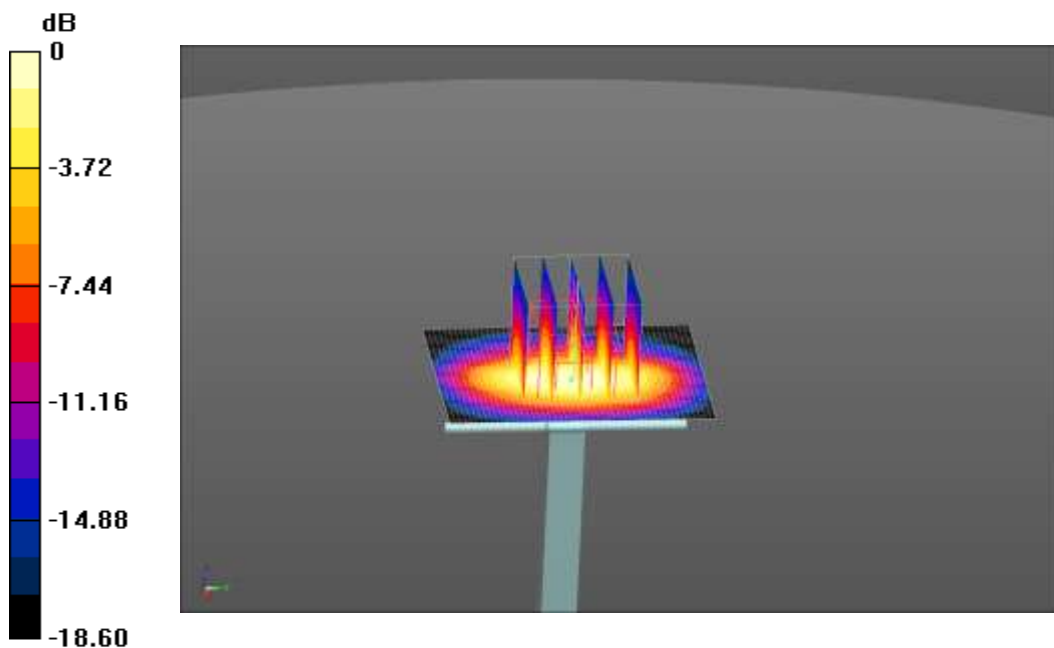

0 dB = 2.25 W/kg = 3.52 dBW/kg

Test Laboratory: CCIS

Date/Time: 07.06.2016 22:34:33

DUT: Dipole 2450 MHz; Type: D2450V2; Serial: SN: 955

Communication System: UID 0, CW (0); Frequency: 2450 MHz

Medium parameters used: $f = 2450$ MHz; $\sigma = 1.956$ S/m; $\epsilon_r = 53.095$; $\rho = 1000$ kg/m³

Phantom section: Flat Section

Measurement Standard: DASY5 (IEEE/IEC/ANSI C63.19-2007)

DASY Configuration:

- Probe: EX3DV4 - SN3924; ConvF(7.3, 7.3, 7.3); Calibrated: 07.10.2015;
- Sensor-Surface: 2mm (Mechanical Surface Detection), $z = 31.0$
- Electronics: DAE4 Sn1373; Calibrated: 02.11.2016
- Phantom: ELI v5.0; Type: QDOVA002AA; Serial: TP:1208
- DASY52 52.8.8(1222); SEMCAD X 14.6.10(7331)

System Performance Check at Frequency 2450MHz Body Tissue/d=10mm, Pin=40 mW, dist=2.0mm (EX-Probe)/Zoom Scan (7x7x7) (7x7x7)/Cube 0:

Measurement grid: $dx=5$ mm, $dy=5$ mm, $dz=5$ mm

Reference Value = 38.103 V/m; Power Drift = 0.02 dB

Peak SAR (extrapolated) = 4.23 W/kg

SAR(1 g) = 2.15 W/kg; SAR(10 g) = 0.962 W/kg

Maximum value of SAR (measured) = 3.19 W/kg

System Performance Check at Frequency 2450MHz Body Tissue/d=10mm, Pin=40 mW, dist=2.0mm (EX-Probe)/Area Scan (51x61x1): Interpolated grid:

$dx=1.200$ mm, $dy=1.200$ mm

Maximum value of SAR (interpolated) = 3.37 W/kg

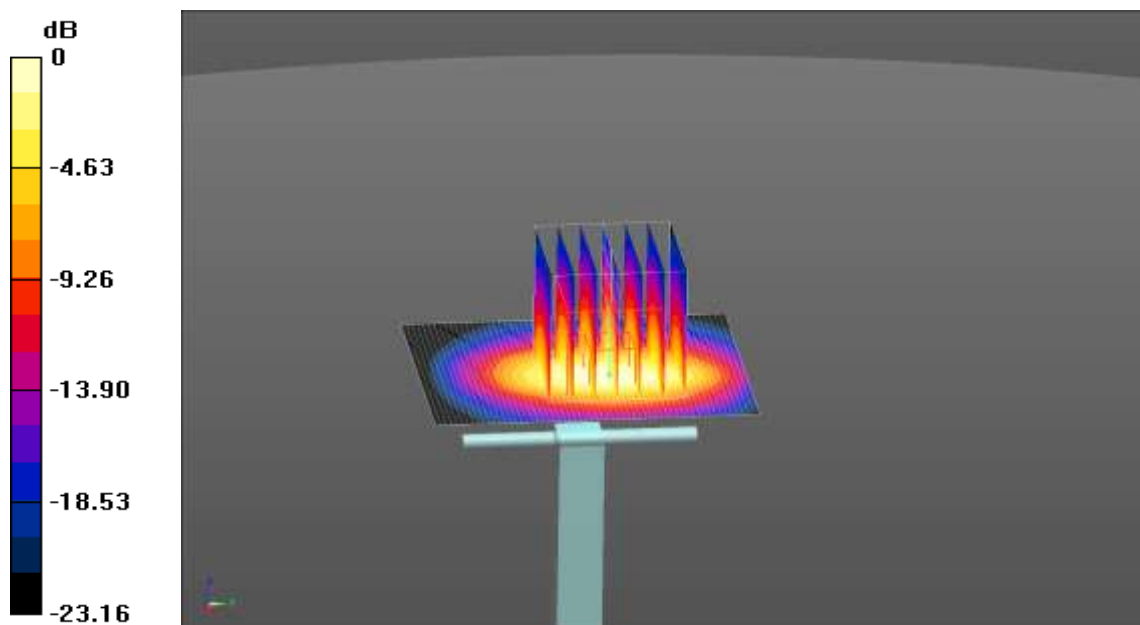

0 dB = 3.37 W/kg = 5.28 dBW/kg

Test Laboratory: CCIS

Date/Time: 07.07.2016 08:04:59

DUT: Dipole 2600 MHz D2600V2; Type: SAAAD260BB; Serial: D2600V2 - SN:1114

Communication System: UID 0, CW (0); Frequency: 2600 MHz

Medium parameters used: $f = 2600$ MHz; $\sigma = 2.15$ S/m; $\epsilon_r = 52.364$; $\rho = 1000$ kg/m³

Phantom section: Flat Section

Measurement Standard: DASYS5 (IEEE/IEC/ANSI C63.19-2007)

DASY Configuration:

- Probe: EX3DV4 - SN3924; ConvF(7.2, 7.2, 7.2); Calibrated: 07.10.2015;
- Sensor-Surface: 2mm (Mechanical Surface Detection), $z = 1.0, 31.0$
- Electronics: DAE4 Sn1373; Calibrated: 02.11.2016
- Phantom: ELI v5.0; Type: QDOVA002AA; Serial: TP:1208
- DASYS2 52.8.8(1222); SEMCAD X 14.6.10(7331)

System Performance Check at Frequency 2600MHz Body Tissue/d=10mm,

Pin=40mW, dist=2.0mm(EX-Probe)/Area Scan (51x61x1): Interpolated grid:

$dx=1.200$ mm, $dy=1.200$ mm

Maximum value of SAR (interpolated) = 3.66 W/kg

System Performance Check at Frequency 2600MHz Body Tissue/d=10mm,

Pin=40mW, dist=2.0mm(EX-Probe)/Zoom Scan(7X7X7) (7x7x7)/Cube 0:

Measurement grid: $dx=5$ mm, $dy=5$ mm, $dz=5$ mm

Reference Value = 34.11 V/m; Power Drift = -0.04 dB

Peak SAR (extrapolated) = 4.65 W/kg

SAR(1 g) = 2.22 W/kg; SAR(10 g) = 0.961 W/kg

Maximum value of SAR (measured) = 3.34 W/kg

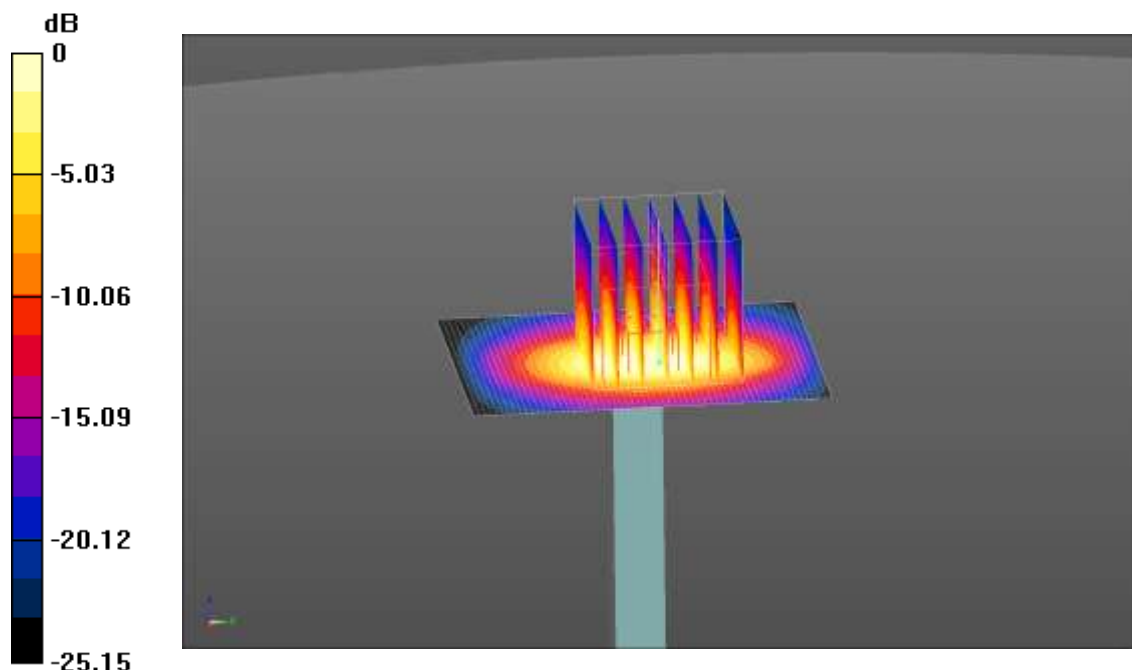

0 dB = 3.34 W/kg = 5.24 dBW/kg

Appendix D: Plots of SAR Test Data

Test Laboratory: CCIS

Date/Time: 07.01.2016 15:44:47

DUT: MOBILE PHONE; Type: Kinzo A5QL; Serial: 1#

Communication System: UID 0, GSM (0); Frequency: 836.6 MHz

Medium parameters used (extrapolated): $f = 836.6$ MHz; $\sigma = 0.941$ S/m; $\epsilon_r = 43.353$; $\rho = 1000$ kg/m³

Phantom section: Left Section

Measurement Standard: DASYS5 (IEEE/IEC/ANSI C63.19-2007)

DASY Configuration:

- Probe: EX3DV4 - SN3924; ConvF(9.68, 9.68, 9.68); Calibrated: 07.10.2015;
- Sensor-Surface: 1.4mm (Mechanical Surface Detection), $z = 31.0$
- Electronics: DAE4 Sn1373; Calibrated: 02.11.2016
- Phantom: SAM 5.0; Type: QD000P40CD; Serial: TP:1765
- DASYS2 52.8.8(1222); SEMCAD X 14.6.10(7331)

GSM 850 Left Cheek/Middle Channel/Zoom Scan (5x5x7)/Cube 0: Measurement grid: $dx=8$ mm, $dy=8$ mm, $dz=5$ mm

Reference Value = 6.404 V/m; Power Drift = -0.04 dB

Peak SAR (extrapolated) = 0.212 W/kg

SAR(1 g) = 0.161 W/kg; SAR(10 g) = 0.125 W/kg

Maximum value of SAR (measured) = 0.193 W/kg

GSM 850 Left Cheek/Middle Channel/Area Scan (41x61x1): Interpolated grid:

$dx=1.500$ mm, $dy=1.500$ mm

Maximum value of SAR (interpolated) = 0.201 W/kg

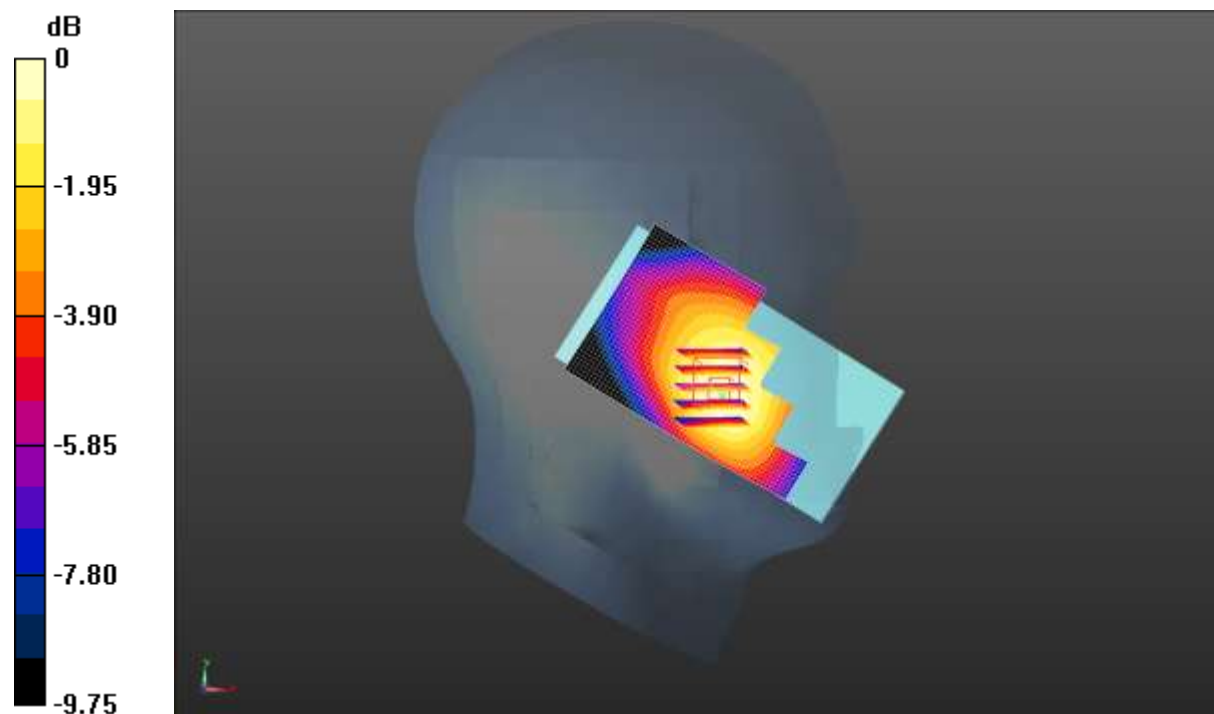

0 dB = 0.201 W/kg = -6.97 dBW/kg

Test Laboratory: CCIS

Date/Time: 07.05.2016 08:57:08

DUT: MOBILE PHONE; Type: Kinzo A5QL; Serial: 1#

Communication System: UID 0, GSM (0); Frequency: 1850.2 MHz

Medium parameters used: $f = 1850.2 \text{ MHz}$; $\sigma = 1.382 \text{ S/m}$; $\epsilon_r = 40.047$; $\rho = 1000 \text{ kg/m}^3$

Phantom section: Left Section

Measurement Standard: DASYS5 (IEEE/IEC/ANSI C63.19-2007)

DASY Configuration:

- Probe: EX3DV4 - SN3924; ConvF(7.95, 7.95, 7.95); Calibrated: 07.10.2015;
- Sensor-Surface: 1.4mm (Mechanical Surface Detection), $z = 31.0$
- Electronics: DAE4 Sn1373; Calibrated: 02.11.2016
- Phantom: SAM 5.0; Type: QD000P40CD; Serial: TP:1765
- DASYS2 52.8.8(1222); SEMCAD X 14.6.10(7331)

GSM 1900 Left Cheek/Low Channel/Zoom Scan (5x5x7)/Cube 0: Measurement

grid: $dx=8\text{mm}$, $dy=8\text{mm}$, $dz=5\text{mm}$

Reference Value = 3.657 V/m; Power Drift = 0.22 dB

Peak SAR (extrapolated) = 0.186 W/kg

SAR(1 g) = 0.113 W/kg; SAR(10 g) = 0.065 W/kg

Maximum value of SAR (measured) = 0.154 W/kg

GSM 1900 Left Cheek/Low Channel/Area Scan (41x61x1): Interpolated grid:

$dx=1.500 \text{ mm}$, $dy=1.500 \text{ mm}$

Maximum value of SAR (interpolated) = 0.133 W/kg

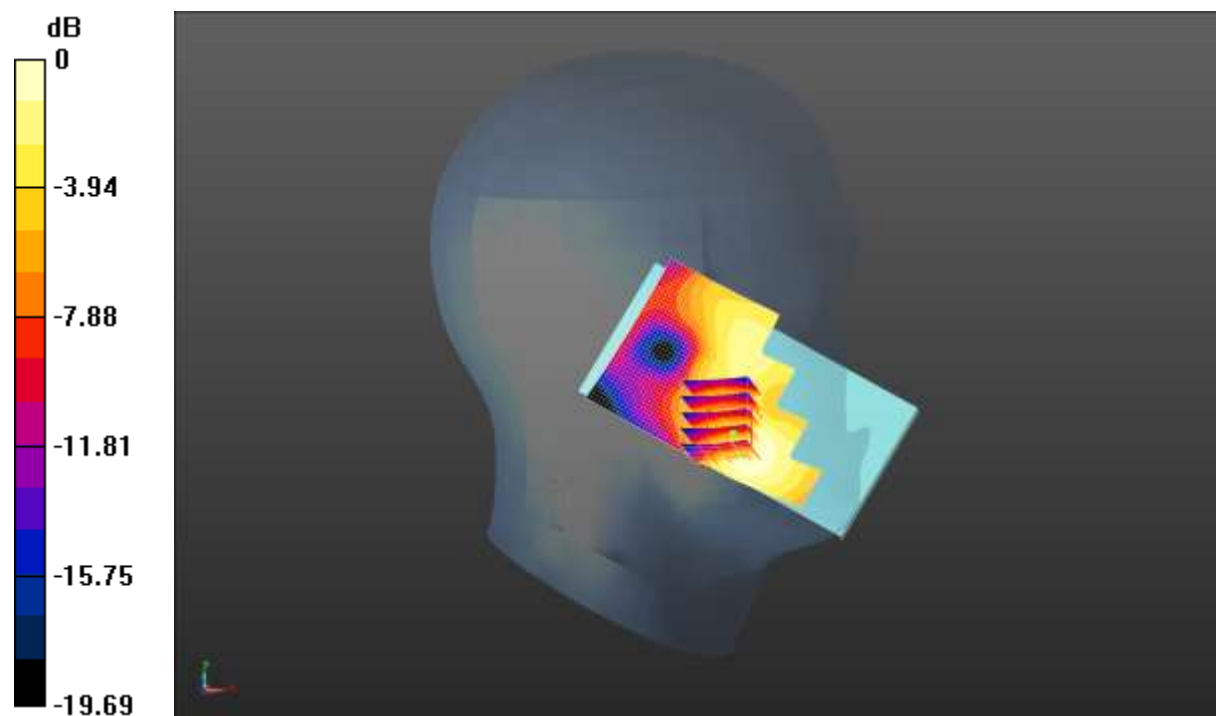

0 dB = 0.133 W/kg = -8.76 dBW/kg

Test Laboratory: CCIS

Date/Time: 07.01.2016 17:07:03

DUT: MOBILE PHONE; Type: Kinzo A5QL; Serial: 1#

Communication System: UID 0, UMTS-FDD(WCDMA) (0); Frequency: 836.6 MHz
 Medium parameters used (extrapolated): $f = 836.6 \text{ MHz}$; $\sigma = 0.941 \text{ S/m}$; $\epsilon_r = 43.353$; $\rho = 1000 \text{ kg/m}^3$
 Phantom section: Left Section
 Measurement Standard: DASY5 (IEEE/IEC/ANSI C63.19-2007)

DASY Configuration:

- Probe: EX3DV4 - SN3924; ConvF(9.68, 9.68, 9.68); Calibrated: 07.10.2015;
- Sensor-Surface: 1.4mm (Mechanical Surface Detection), $z = 31.0$
- Electronics: DAE4 Sn1373; Calibrated: 02.11.2016
- Phantom: SAM 5.0; Type: QD000P40CD; Serial: TP:1765
- DASY52 52.8.8(1222); SEMCAD X 14.6.10(7331)

WCDMA 850 Left Cheek/Middle Channel/Zoom Scan (5x5x7)/Cube 0:

Measurement grid: $dx=8\text{mm}$, $dy=8\text{mm}$, $dz=5\text{mm}$
 Reference Value = 5.689 V/m; Power Drift = -0.21 dB
 Peak SAR (extrapolated) = 0.229 W/kg
SAR(1 g) = 0.172 W/kg; SAR(10 g) = 0.132 W/kg
 Maximum value of SAR (measured) = 0.206 W/kg

WCDMA 850 Left Cheek/Middle Channel/Area Scan (41x61x1): Interpolated

grid: $dx=1.500 \text{ mm}$, $dy=1.500 \text{ mm}$
 Maximum value of SAR (interpolated) = 0.220 W/kg

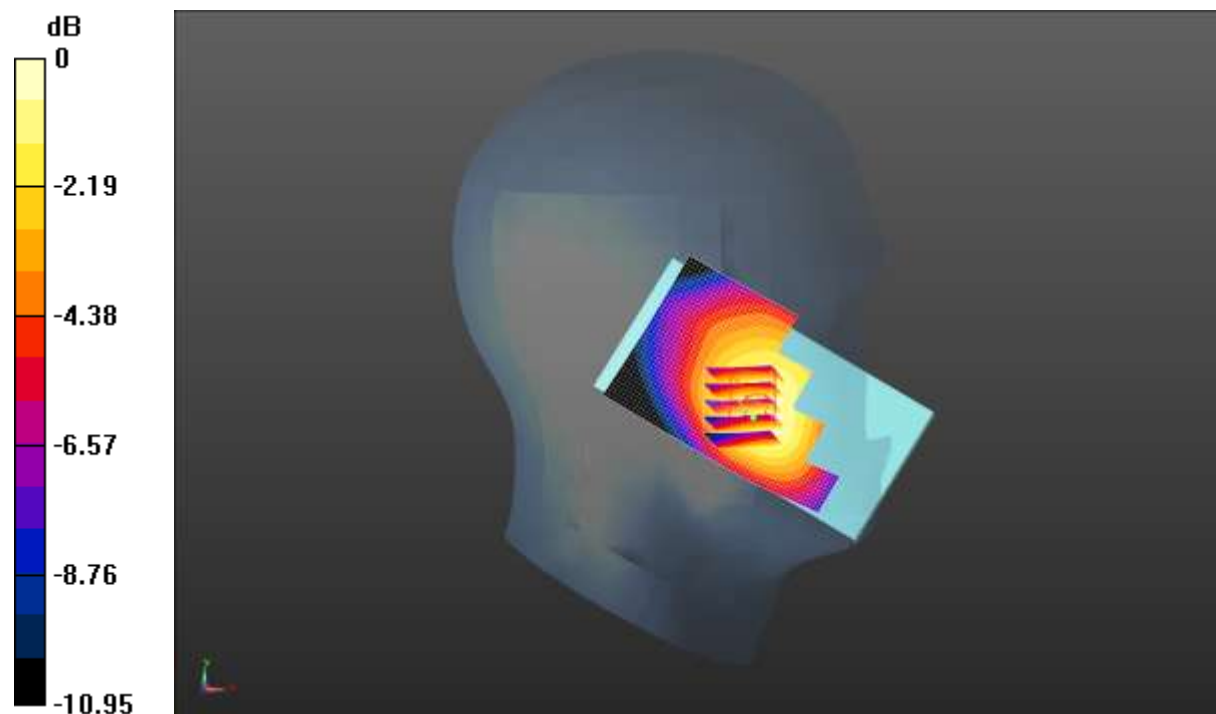

0 dB = 0.220 W/kg = -6.58 dBW/kg

Test Laboratory: CCIS

Date/Time: 07.05.2016 09:09:51

DUT: MOBILE PHONE; Type: Kinzo A5QL; Serial: 1#

Communication System: UID 0, UMTS-FDD(WCDMA) (0); Frequency: 1852.4 MHz
 Medium parameters used: $f = 1852.4 \text{ MHz}$; $\sigma = 1.382 \text{ S/m}$; $\epsilon_r = 40.047$; $\rho = 1000 \text{ kg/m}^3$
 Phantom section: Left Section
 Measurement Standard: DASYS5 (IEEE/IEC/ANSI C63.19-2007)

DASY Configuration:

- Probe: EX3DV4 - SN3924; ConvF(7.95, 7.95, 7.95); Calibrated: 07.10.2015;
- Sensor-Surface: 1.4mm (Mechanical Surface Detection), $z = 31.0$
- Electronics: DAE4 Sn1373; Calibrated: 02.11.2016
- Phantom: SAM 5.0; Type: QD000P40CD; Serial: TP:1765
- DASYS2 52.8.8(1222); SEMCAD X 14.6.10(7331)

WCDMA 1900 Left Cheek/Low Channel/Zoom Scan (5x5x7)/Cube 0:

Measurement grid: $dx=8\text{mm}$, $dy=8\text{mm}$, $dz=5\text{mm}$
 Reference Value = 5.992 V/m; Power Drift = -0.01 dB
 Peak SAR (extrapolated) = 0.318 W/kg
SAR(1 g) = 0.193 W/kg; SAR(10 g) = 0.113 W/kg
 Maximum value of SAR (measured) = 0.263 W/kg

WCDMA 1900 Left Cheek/Low Channel/Area Scan (41x61x1): Interpolated grid:

$dx=1.500 \text{ mm}$, $dy=1.500 \text{ mm}$
 Maximum value of SAR (interpolated) = 0.232 W/kg

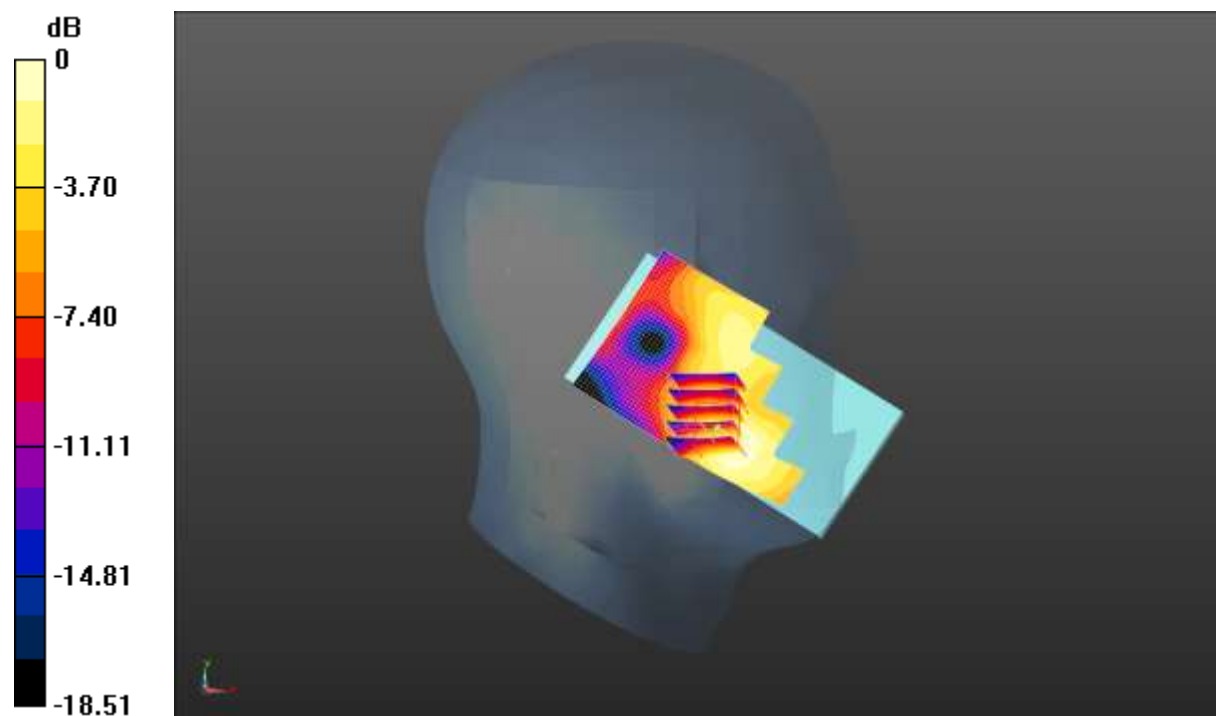

0 dB = 0.232 W/kg = -6.35 dBW/kg

Test Laboratory: CCIS

Date/Time: 07.05.2016 10:00:24

DUT: MOBILE PHONE; Type: Kinzo A5QL; Serial: 1#

Communication System: UID 0, LTE-Fdd(USA) 1RB QPSK (0); Frequency: 1860 MHz
 Medium parameters used: $f = 1860 \text{ MHz}$; $\sigma = 1.37 \text{ S/m}$; $\epsilon_r = 40.464$; $\rho = 1000 \text{ kg/m}^3$
 Phantom section: Right Section
 Measurement Standard: DASYS5 (IEEE/IEC/ANSI C63.19-2007)

DASY Configuration:

- Probe: EX3DV4 - SN3924; ConvF(7.95, 7.95, 7.95); Calibrated: 07.10.2015;
- Sensor-Surface: 1.4mm (Mechanical Surface Detection), $z = 1.0, 31.0$
- Electronics: DAE4 Sn1373; Calibrated: 02.11.2016
- Phantom: SAM 5.0; Type: QD000P40CD; Serial: TP:1765
- DASYS2 52.8.8(1222); SEMCAD X 14.6.10(7331)

LTE Band 2 1RB(20MHz) Right Cheek/Low Channel/Area Scan (41x61x1):

Interpolated grid: $dx=1.500 \text{ mm}$, $dy=1.500 \text{ mm}$
 Maximum value of SAR (interpolated) = 0.265 W/kg

LTE Band 2 1RB(20MHz) Right Cheek/Low Channel/Zoom Scan

(5x5x7)/Cube 0: Measurement grid: $dx=8\text{mm}$, $dy=8\text{mm}$, $dz=5\text{mm}$
 Reference Value = 7.985 V/m ; Power Drift = -0.26 dB
 Peak SAR (extrapolated) = 0.354 W/kg
SAR(1 g) = 0.206 W/kg ; SAR(10 g) = 0.119 W/kg
 Maximum value of SAR (measured) = 0.290 W/kg

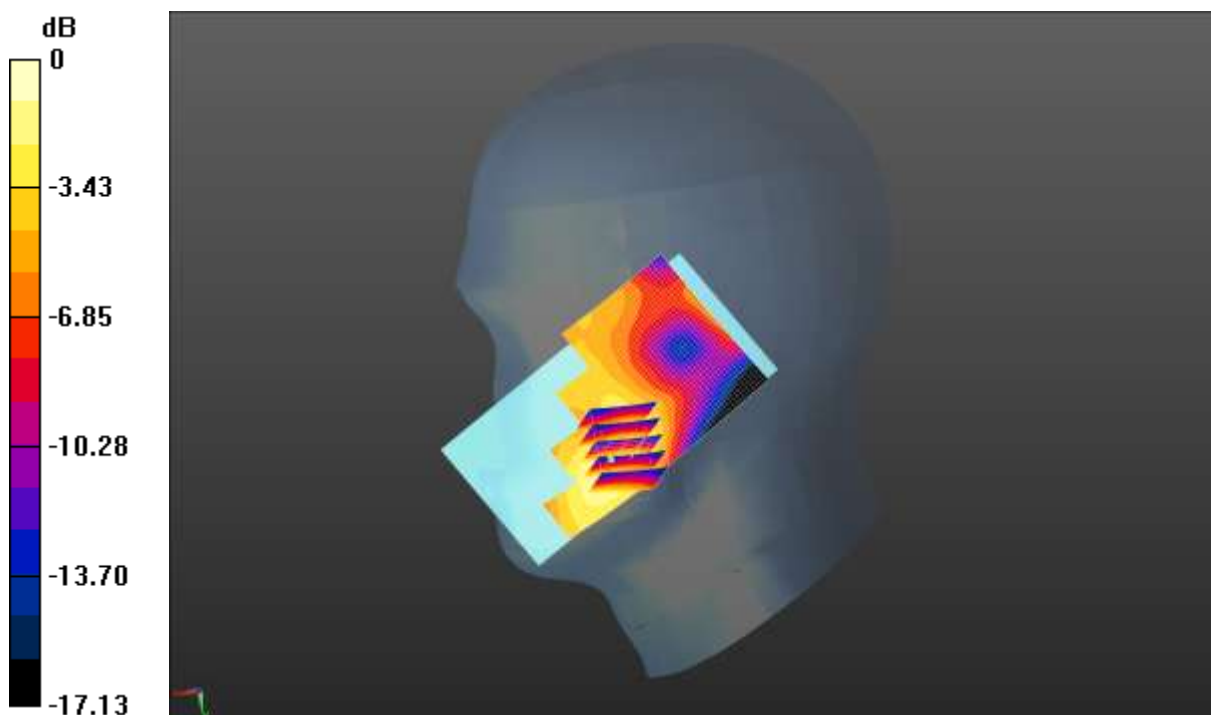

0 dB = $0.290 \text{ W/kg} = -5.38 \text{ dBW/kg}$

Test Laboratory: CCIS

Date/Time: 07.05.2016 14:59:47

DUT: MOBILE PHONE; Type: Kinzo A5QL; Serial: 1#

Communication System: UID 0, LTE-Fdd(USA) 1RB QPSK (0); Frequency: 1720 MHz
 Medium parameters used: $f = 1720$ MHz; $\sigma = 1.38$ S/m; $\epsilon_r = 40.902$; $\rho = 1000$ kg/m³
 Phantom section: Right Section
 Measurement Standard: DASYS5 (IEEE/IEC/ANSI C63.19-2007)

DASY Configuration:

- Probe: EX3DV4 - SN3924; ConvF(8.37, 8.37, 8.37); Calibrated: 07.10.2015;
- Sensor-Surface: 1.4mm (Mechanical Surface Detection), $z = 1.0, 31.0$
- Electronics: DAE4 Sn1373; Calibrated: 02.11.2016
- Phantom: SAM 5.0; Type: QD000P40CD; Serial: TP:1765
- DASYS2 52.8.8(1222); SEMCAD X 14.6.10(7331)

LTE Band 4 1RB(20MHz) Right Cheek/Low Channel/Area Scan (41x61x1):

Interpolated grid: $dx=1.500$ mm, $dy=1.500$ mm
 Maximum value of SAR (interpolated) = 0.303 W/kg

LTE Band 4 1RB(20MHz) Right Cheek/Low Channel/Zoom Scan

(5x5x7)/Cube 0: Measurement grid: $dx=8$ mm, $dy=8$ mm, $dz=5$ mm
 Reference Value = 7.721 V/m; Power Drift = 0.20 dB
 Peak SAR (extrapolated) = 0.363 W/kg
SAR(1 g) = 0.217 W/kg; SAR(10 g) = 0.129 W/kg
 Maximum value of SAR (measured) = 0.303 W/kg

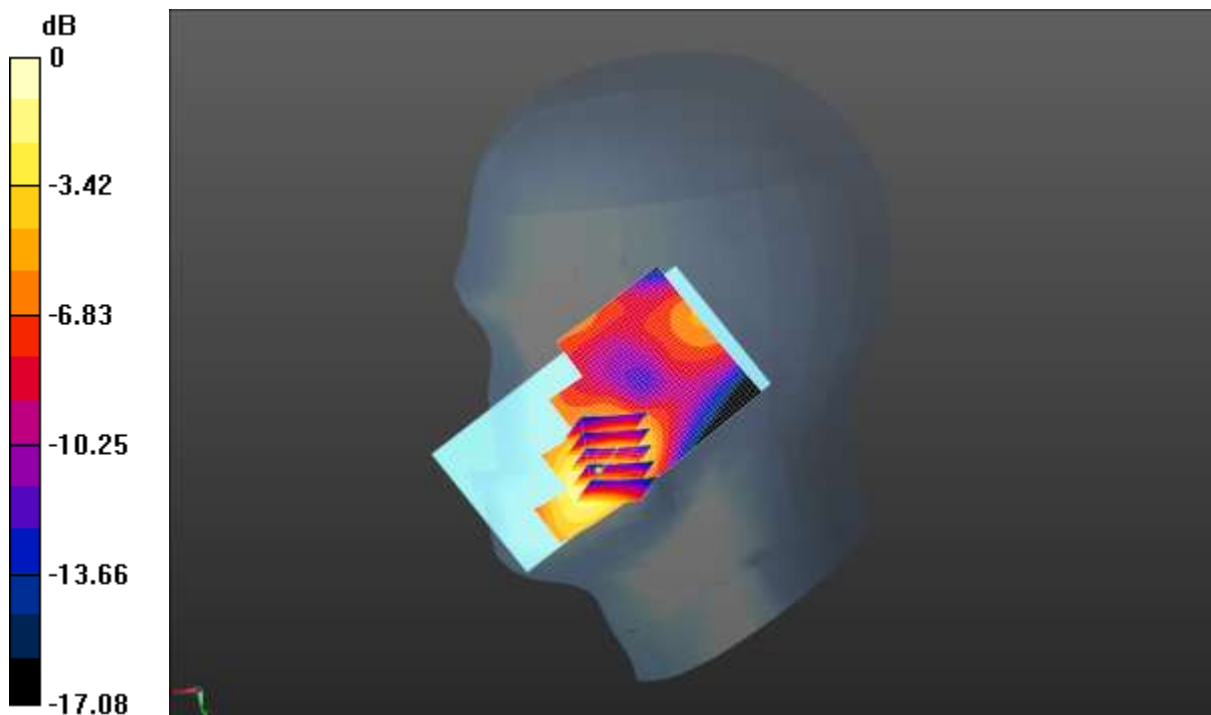

0 dB = 0.303 W/kg = -5.19 dBW/kg

Test Laboratory: CCIS

Date/Time: 07.07.2016 16:59:18

DUT: MOBILE PHONE; Type: Kinzo A5QL; Serial: 1#

Communication System: UID 0, LTE-Fdd(USA) 1RB QPSK (0); Frequency: 2510 MHz
 Medium parameters used: $f = 2510 \text{ MHz}$; $\sigma = 1.91 \text{ S/m}$; $\epsilon_r = 38.325$; $\rho = 1000 \text{ kg/m}^3$
 Phantom section: Left Section
 Measurement Standard: DASYS5 (IEEE/IEC/ANSI C63.19-2007)

DASY Configuration:

- Probe: EX3DV4 - SN3924; ConvF(7.17, 7.17, 7.17); Calibrated: 07.10.2015;
- Sensor-Surface: 1.4mm (Mechanical Surface Detection), $z = 1.0, 31.0$
- Electronics: DAE4 Sn1373; Calibrated: 02.11.2016
- Phantom: SAM 5.0; Type: QD000P40CD; Serial: TP:1765
- DASYS2 52.8.8(1222); SEMCAD X 14.6.10(7331)

LTE Band 7 1RB(20MHz) Left Cheek/Low Channel/Area Scan (41x61x1):

Interpolated grid: $dx=1.200 \text{ mm}$, $dy=1.200 \text{ mm}$
 Maximum value of SAR (interpolated) = 0.325 W/kg

LTE Band 7 1RB(20MHz) Left Cheek/Low Channel/Zoom Scan (5x5x7)/Cube

0: Measurement grid: $dx=5\text{mm}$, $dy=5\text{mm}$, $dz=5\text{mm}$
 Reference Value = 4.878 V/m ; Power Drift = 0.23 dB
 Peak SAR (extrapolated) = 0.551 W/kg
SAR(1 g) = 0.296 W/kg ; SAR(10 g) = 0.156 W/kg
 Maximum value of SAR (measured) = 0.425 W/kg

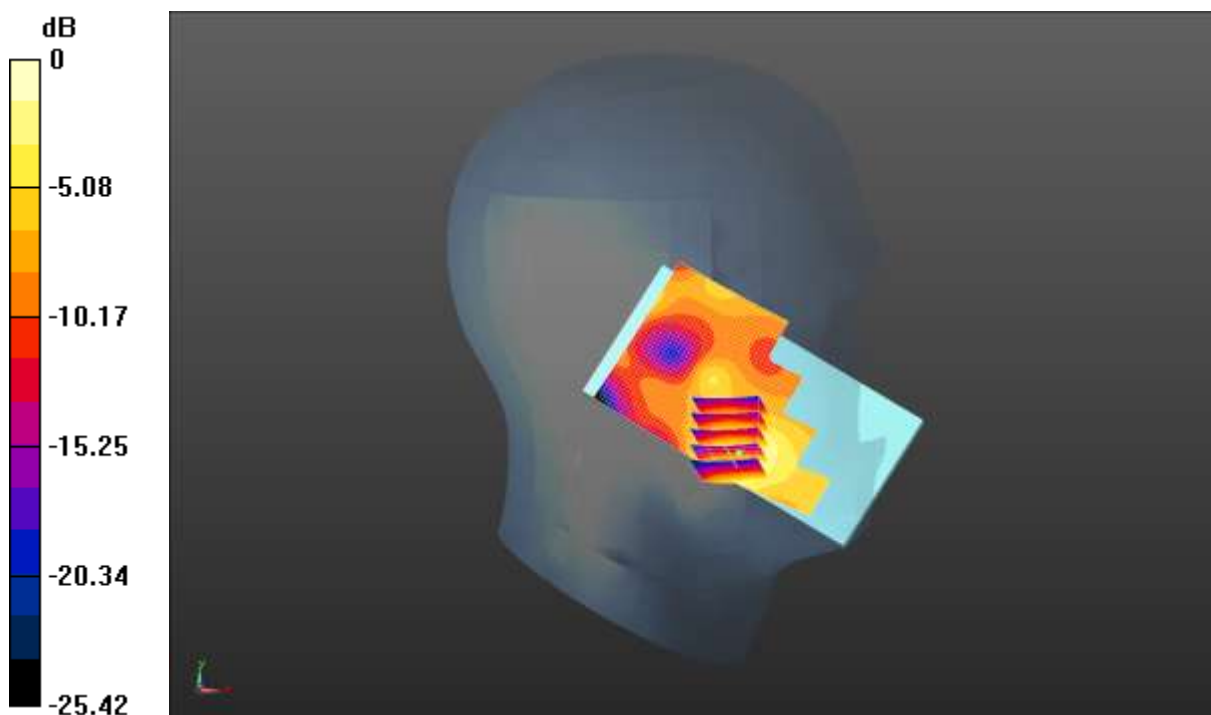

0 dB = $0.425 \text{ W/kg} = -3.72 \text{ dBW/kg}$

Test Laboratory: CCIS

Date/Time: 07.03.2016 10:31:39

DUT: MOBILE PHONE; Type: Kinzo A5QL; Serial: 1#

Communication System: UID 0, LTE-Fdd(USA) 1RB QPSK (0); Frequency: 710 MHz
 Medium parameters used (interpolated): $f = 710 \text{ MHz}$; $\sigma = 0.86 \text{ S/m}$; $\epsilon_r = 42.412$; $\rho = 1000 \text{ kg/m}^3$

Phantom section: Left Section

Measurement Standard: DASYS (IEEE/IEC/ANSI C63.19-2007)

DASY Configuration:

- Probe: EX3DV4 - SN3924; ConvF(9.95, 9.95, 9.95); Calibrated: 07.10.2015;
- Sensor-Surface: 1.4mm (Mechanical Surface Detection), $z = 31.0$
- Electronics: DAE4 Sn1373; Calibrated: 02.11.2016
- Phantom: SAM 5.0; Type: QD000P40CD; Serial: TP:1765
- DASY52 52.8.8(1222); SEMCAD X 14.6.10(7331)

LTE Band 17 1RB(10MHz) Left Cheek/Middle Channel/Zoom Scan

(5x5x7)/Cube 0: Measurement grid: $dx=8\text{mm}$, $dy=8\text{mm}$, $dz=5\text{mm}$

Reference Value = 2.692 V/m; Power Drift = -0.19 dB

Peak SAR (extrapolated) = 0.0460 W/kg

SAR(1 g) = 0.036 W/kg; SAR(10 g) = 0.029 W/kg

Maximum value of SAR (measured) = 0.0421 W/kg

LTE Band 17 1RB(10MHz) Left Cheek/Middle Channel/Area Scan (41x61x1):

Interpolated grid: $dx=1.500 \text{ mm}$, $dy=1.500 \text{ mm}$

Maximum value of SAR (interpolated) = 0.0422 W/kg

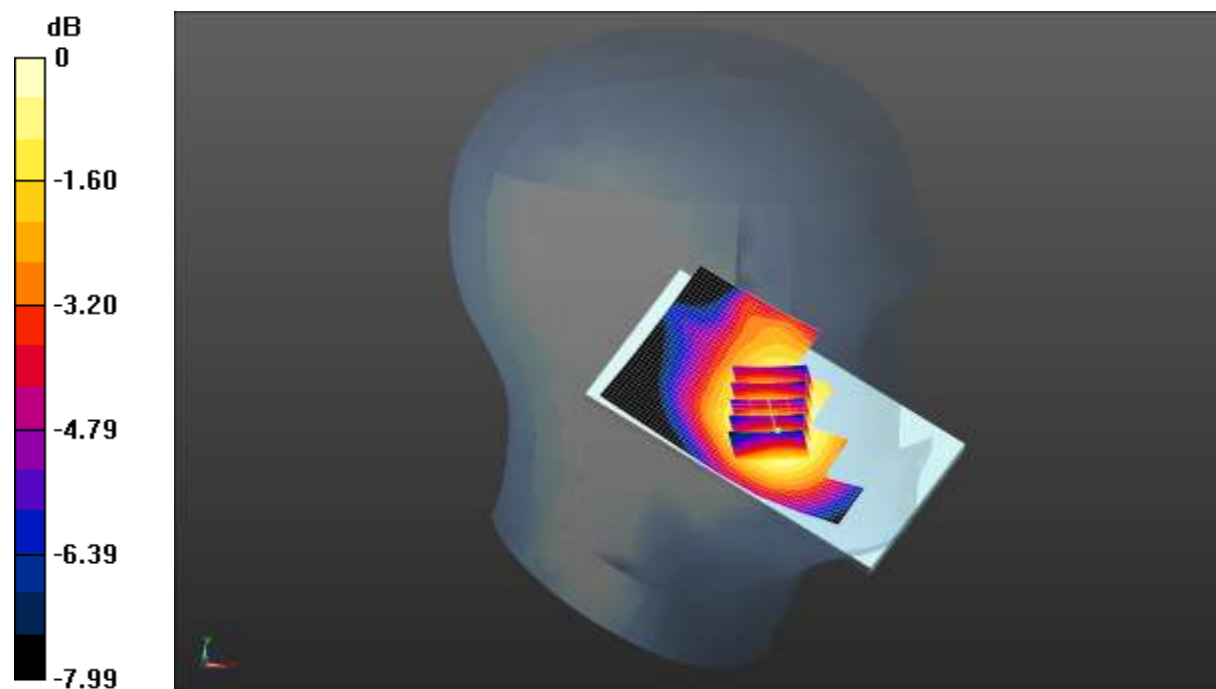

0 dB = 0.0422 W/kg = -13.75 dBW/kg

Test Laboratory: CCIS

Date/Time: 07.05.2016 11:31:17

DUT: MOBILE PHONE; Type: Kinzo A5QL; Serial: 1#

Communication System: UID 0, LTE-FDD(USA) 20MHz 50%RB QPSK (0); Frequency: 1860 MHz

Medium parameters used: $f = 1860$ MHz; $\sigma = 1.37$ S/m; $\epsilon_r = 40.464$; $\rho = 1000$ kg/m³

Phantom section: Right Section

Measurement Standard: DASYS (IEEE/IEC/ANSI C63.19-2007)

DASY Configuration:

- Probe: EX3DV4 - SN3924; ConvF(7.95, 7.95, 7.95); Calibrated: 07.10.2015;
- Sensor-Surface: 1.4mm (Mechanical Surface Detection), $z = 1.0, 31.0$
- Electronics: DAE4 Sn1373; Calibrated: 02.11.2016
- Phantom: SAM 5.0; Type: QD000P40CD; Serial: TP:1765
- DASYS2 52.8.8(1222); SEMCAD X 14.6.10(7331)

LTE Band 2 50%RB(20MHz) Right Cheek/Low Channel/Area Scan (41x61x1):

Interpolated grid: $dx=1.500$ mm, $dy=1.500$ mm

Maximum value of SAR (interpolated) = 0.209 W/kg

LTE Band 2 50%RB(20MHz) Right Cheek/Low Channel/Zoom Scan

(5x5x7)/Cube 0: Measurement grid: $dx=8$ mm, $dy=8$ mm, $dz=5$ mm

Reference Value = 6.624 V/m; Power Drift = 0.02 dB

Peak SAR (extrapolated) = 0.276 W/kg

SAR(1 g) = 0.159 W/kg; SAR(10 g) = 0.092 W/kg

Maximum value of SAR (measured) = 0.229 W/kg

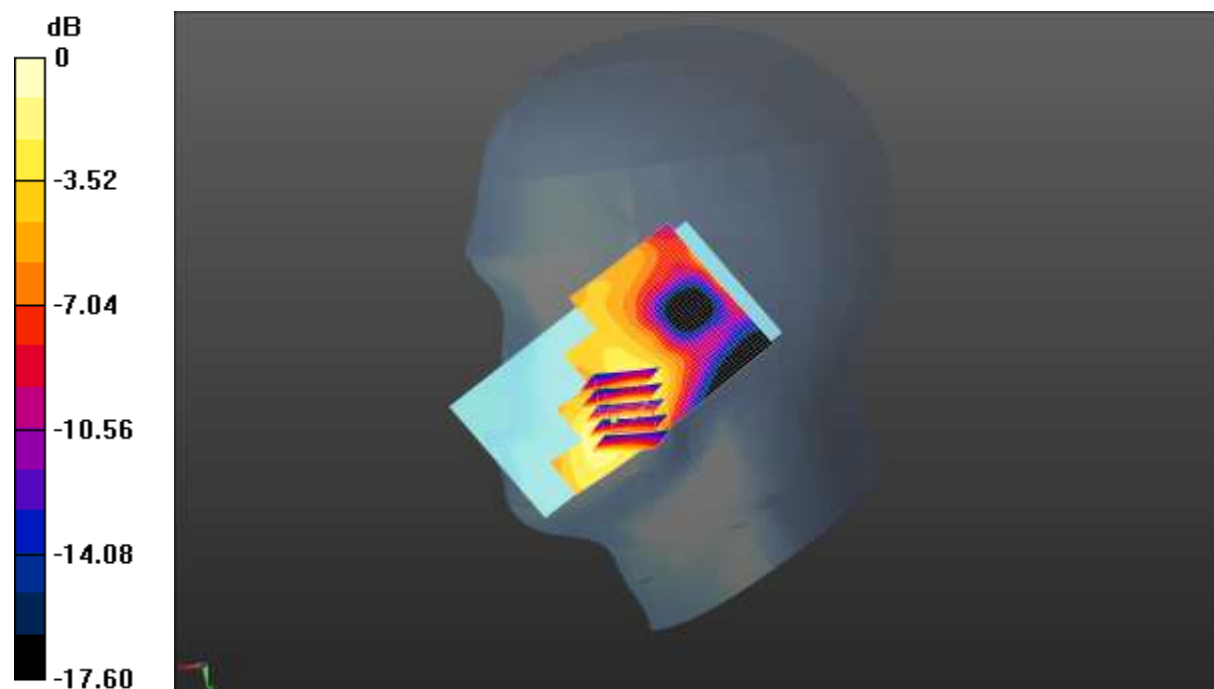

0 dB = 0.229 W/kg = -6.40 dBW/kg

Test Laboratory: CCIS

Date/Time: 07.05.2016 11:43:39

DUT: MOBILE PHONE; Type: Kinzo A5QL; Serial: 1#

Communication System: UID 0, LTE-FDD(USA) 20MHz 50%RB QPSK (0); Frequency: 1745 MHz

Medium parameters used: $f = 1745 \text{ MHz}$; $\sigma = 1.382 \text{ S/m}$; $\epsilon_r = 40.995$; $\rho = 1000 \text{ kg/m}^3$

Phantom section: Right Section

Measurement Standard: DASYS (IEEE/IEC/ANSI C63.19-2007)

DASY Configuration:

- Probe: EX3DV4 - SN3924; ConvF(8.37, 8.37, 8.37); Calibrated: 07.10.2015;
- Sensor-Surface: 1.4mm (Mechanical Surface Detection), $z = 1.0, 31.0$
- Electronics: DAE4 Sn1373; Calibrated: 02.11.2016
- Phantom: SAM 5.0; Type: QD000P40CD; Serial: TP:1765
- DASY52 52.8.8(1222); SEMCAD X 14.6.10(7331)

LTE Band 4 50%RB(20MHz) Right Cheek/High Channel/Area Scan

(41x61x1): Interpolated grid: $dx=1.500 \text{ mm}$, $dy=1.500 \text{ mm}$

Maximum value of SAR (interpolated) = 0.199 W/kg

LTE Band 4 50%RB(20MHz) Right Cheek/High Channel/Zoom Scan

(5x5x7)/Cube 0: Measurement grid: $dx=8\text{mm}$, $dy=8\text{mm}$, $dz=5\text{mm}$

Reference Value = 6.615 V/m; Power Drift = 0.33 dB

Peak SAR (extrapolated) = 0.242 W/kg

SAR(1 g) = 0.145 W/kg; SAR(10 g) = 0.087 W/kg

Maximum value of SAR (measured) = 0.202 W/kg

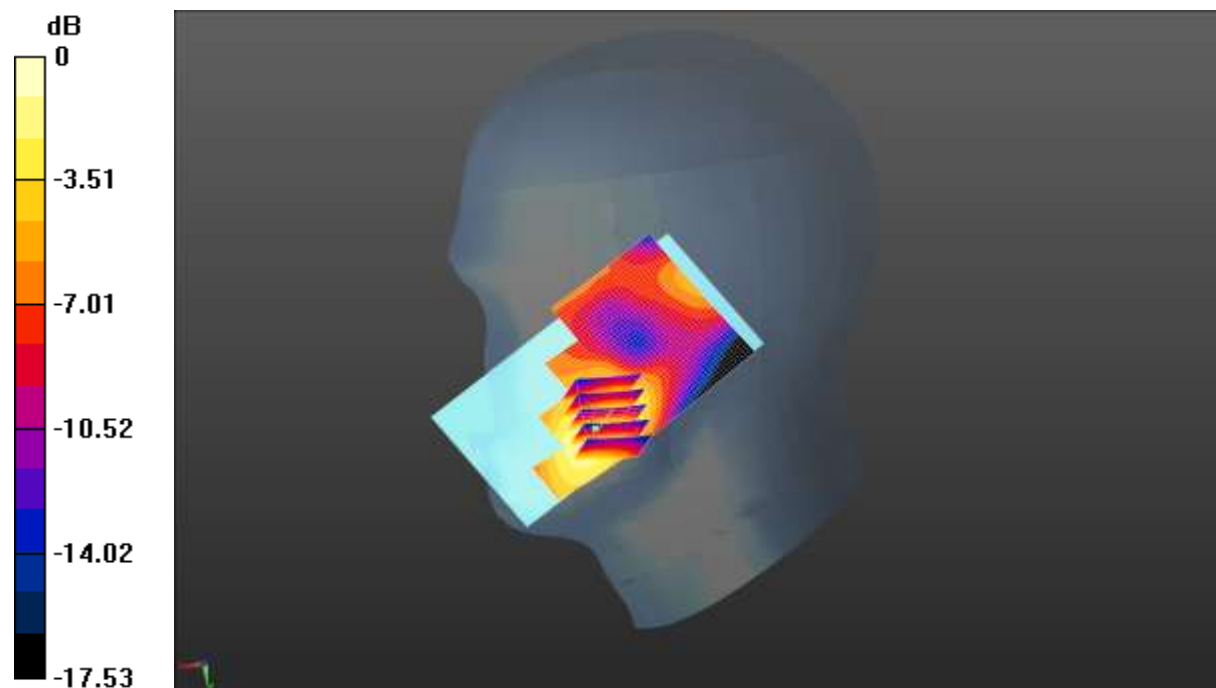

0 dB = 0.202 W/kg = -6.95 dBW/kg

Test Laboratory: CCIS

Date/Time: 07.07.2016 17:10:58

DUT: MOBILE PHONE; Type: Kinzo A5QL; Serial: 1#

Communication System: UID 0, LTE-FDD(USA) 20MHz 50%RB QPSK (0); Frequency: 2510 MHz

Medium parameters used: $f = 2510 \text{ MHz}$; $\sigma = 1.91 \text{ S/m}$; $\epsilon_r = 38.325$; $\rho = 1000 \text{ kg/m}^3$

Phantom section: Left Section

Measurement Standard: DASYS (IEEE/IEC/ANSI C63.19-2007)

DASY Configuration:

- Probe: EX3DV4 - SN3924; ConvF(7.17, 7.17, 7.17); Calibrated: 07.10.2015;
- Sensor-Surface: 1.4mm (Mechanical Surface Detection), $z = 1.0, 31.0$
- Electronics: DAE4 Sn1373; Calibrated: 02.11.2016
- Phantom: SAM 5.0; Type: QD000P40CD; Serial: TP:1765
- DASYS2 52.8.8(1222); SEMCAD X 14.6.10(7331)

LTE Band 7 50%RB(20MHz) Left Cheek/Low Channel/Area Scan (41x61x1):

Interpolated grid: $dx=1.200 \text{ mm}$, $dy=1.200 \text{ mm}$

Maximum value of SAR (interpolated) = 0.326 W/kg

LTE Band 7 50%RB(20MHz) Left Cheek/Low Channel/Zoom Scan

(5x5x7)/Cube 0: Measurement grid: $dx=5\text{mm}$, $dy=5\text{mm}$, $dz=5\text{mm}$

Reference Value = 4.372 V/m; Power Drift = 0.11 dB

Peak SAR (extrapolated) = 0.568 W/kg

SAR(1 g) = 0.283 W/kg; SAR(10 g) = 0.142 W/kg

Maximum value of SAR (measured) = 0.465 W/kg

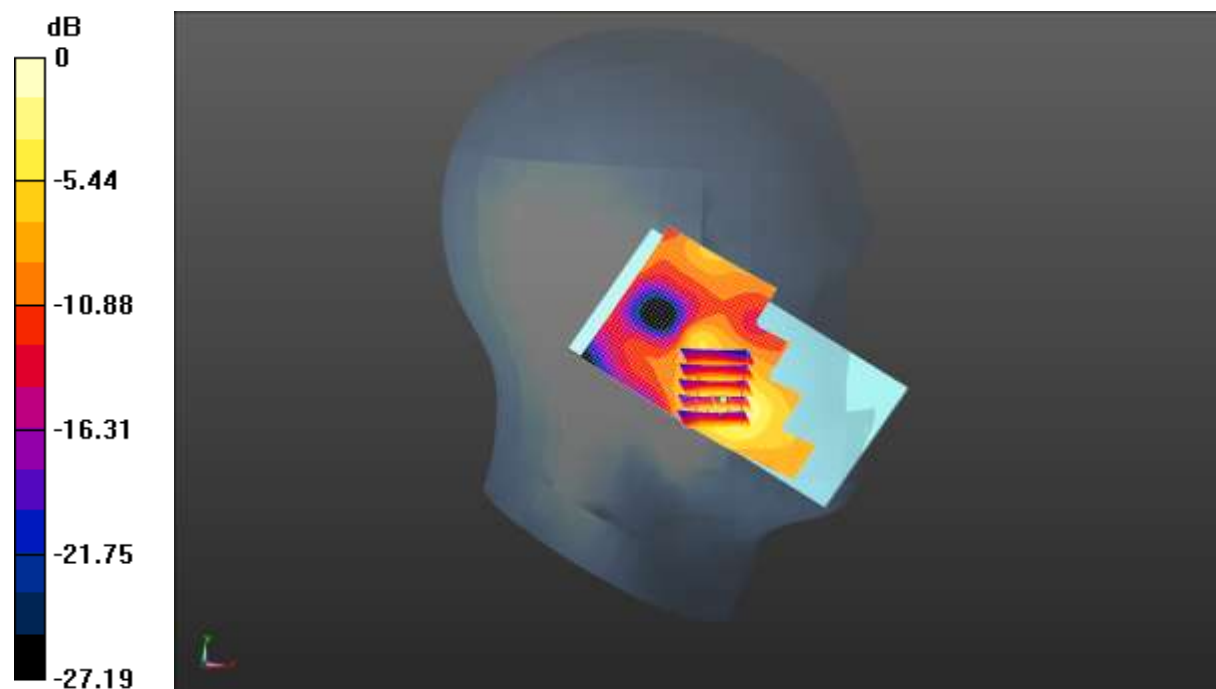

0 dB = 0.465 W/kg = -3.33 dBW/kg

Test Laboratory: CCIS

Date/Time: 07.03.2016 09:56:15

DUT: MOBILE PHONE; Type: Kinzo A5QL; Serial: 1#

Communication System: UID 0, LTE-FDD (USA) 10MHz 50%RB QPSK (0); Frequency: 710 MHz

Medium parameters used (interpolated): $f = 710 \text{ MHz}$; $\sigma = 0.86 \text{ S/m}$; $\epsilon_r = 42.412$; $\rho = 1000 \text{ kg/m}^3$

Phantom section: Left Section

Measurement Standard: DASYS (IEEE/IEC/ANSI C63.19-2007)

DASY Configuration:

- Probe: EX3DV4 - SN3924; ConvF(9.95, 9.95, 9.95); Calibrated: 07.10.2015;
- Sensor-Surface: 1.4mm (Mechanical Surface Detection), $z = 31.0$
- Electronics: DAE4 Sn1373; Calibrated: 02.11.2016
- Phantom: SAM 5.0; Type: QD000P40CD; Serial: TP:1765
- DASYS2 52.8.8(1222); SEMCAD X 14.6.10(7331)

LTE Band 17 50%RB(10MHz) Left Cheek/Middle Channel/Zoom Scan

(5x5x7)/Cube 0: Measurement grid: $dx=8\text{mm}$, $dy=8\text{mm}$, $dz=5\text{mm}$

Reference Value = 2.804 V/m; Power Drift = -0.10 dB

Peak SAR (extrapolated) = 0.0490 W/kg

SAR(1 g) = 0.038 W/kg; SAR(10 g) = 0.030 W/kg

Maximum value of SAR (measured) = 0.0451 W/kg

LTE Band 17 50%RB(10MHz) Left Cheek/Middle Channel/Area Scan

(41x61x1): Interpolated grid: $dx=1.500 \text{ mm}$, $dy=1.500 \text{ mm}$

Maximum value of SAR (interpolated) = 0.0460 W/kg

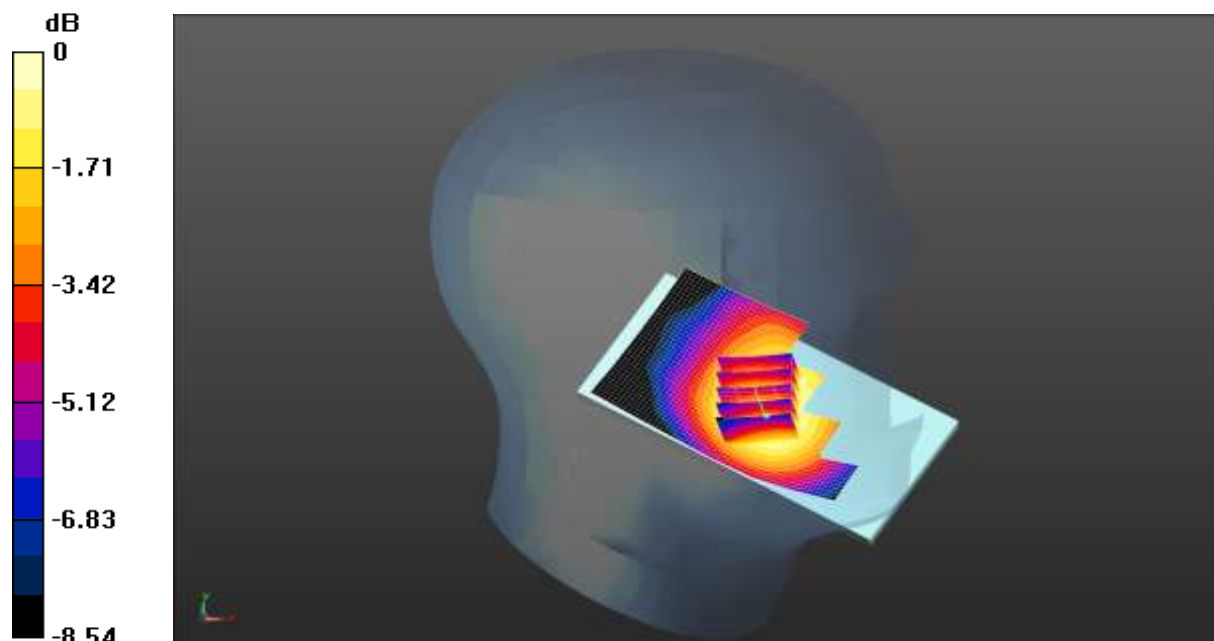

0 dB = 0.0460 W/kg = -13.37 dBW/kg

Test Laboratory: CCIS

Date/Time: 07.07.2016 13:45:42

DUT: MOBILE PHONE; Type: Kinzo A5QL; Serial: 1#

Communication System: UID 0, IEEE 802.11b WiFi 2.4 GHz (DSSS, 1 Mbps) (0);

Frequency: 2437 MHz

Medium parameters used (interpolated): $f = 2437$ MHz; $\sigma = 1.883$ S/m; $\epsilon_r = 38.021$; $\rho = 1000$ kg/m³

Phantom section: Right Section

Measurement Standard: DASYS5 (IEEE/IEC/ANSI C63.19-2007)

DASY Configuration:

- Probe: EX3DV4 - SN3924; ConvF(7.17, 7.17, 7.17); Calibrated: 07.10.2015;
- Sensor-Surface: 1.4mm (Mechanical Surface Detection), $z = 1.0, 31.0$
- Electronics: DAE4 Sn1373; Calibrated: 02.11.2016
- Phantom: SAM 5.0; Type: QD000P40CD; Serial: TP:1765
- DASYS5 52.8.8(1222); SEMCAD X 14.6.10(7331)

WIFI Right Cheek/Middle Channel/Area Scan (41x61x1): Interpolated grid:

$dx=1.200$ mm, $dy=1.200$ mm

Maximum value of SAR (interpolated) = 0.858 W/kg

WIFI Right Cheek/Middle Channel/Zoom Scan (5x5x7)/Cube 0: Measurement

grid: $dx=5$ mm, $dy=5$ mm, $dz=5$ mm

Reference Value = 8.055 V/m; Power Drift = 0.15 dB

Peak SAR (extrapolated) = 1.25 W/kg

SAR(1 g) = 0.451 W/kg; SAR(10 g) = 0.155 W/kg

Maximum value of SAR (measured) = 0.970 W/kg

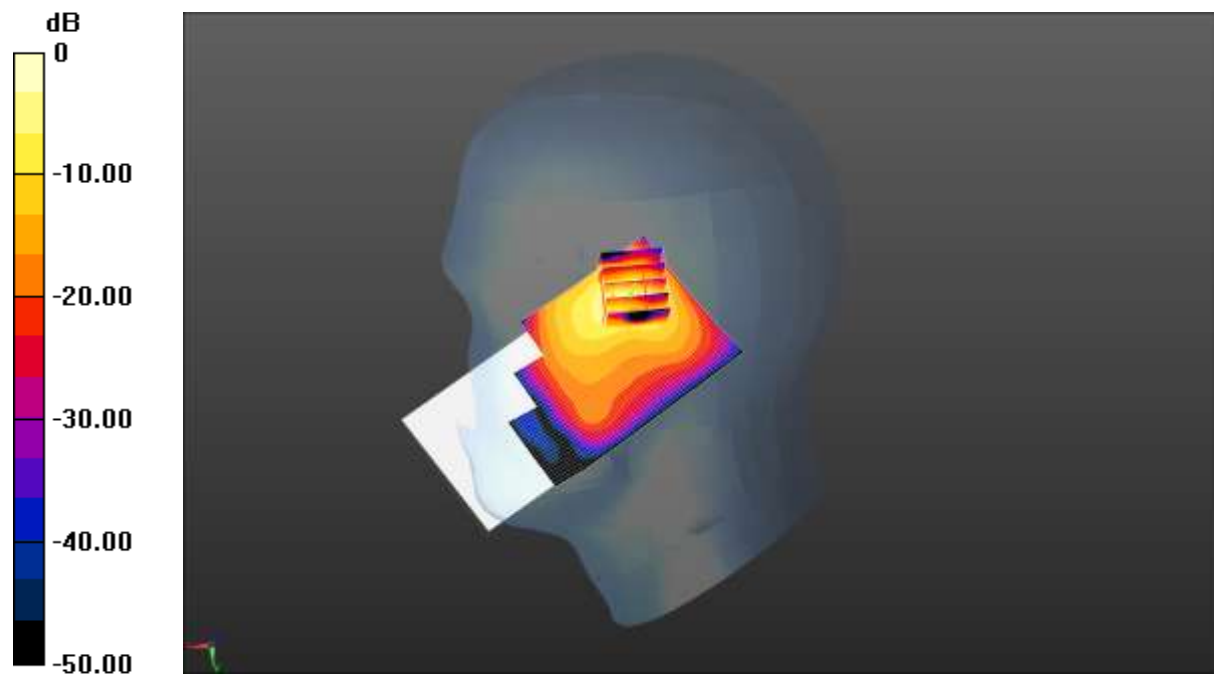

0 dB = 0.970 W/kg = -0.13 dBW/kg

Test Laboratory: CCIS

Date/Time: 07.02.2016 14:21:41

DUT: MOBILE PHONE; Type: Kinzo A5QL; Serial: 1#

Communication System: UID 0, GSM (0); Frequency: 836.6 MHz

Medium parameters used (extrapolated): $f = 836.6 \text{ MHz}$; $\sigma = 1.039 \text{ S/m}$; $\epsilon_r = 56.886$; $\rho = 1000 \text{ kg/m}^3$

Phantom section: Flat Section

Measurement Standard: DASY5 (IEEE/IEC/ANSI C63.19-2007)

DASY Configuration:

- Probe: EX3DV4 - SN3924; ConvF(9.74, 9.74, 9.74); Calibrated: 07.10.2015;
- Sensor-Surface: 1.4mm (Mechanical Surface Detection), $z = 31.0$
- Electronics: DAE4 Sn1373; Calibrated: 02.11.2016
- Phantom: ELI v5.0; Type: QDOVA002AA; Serial: TP:1208
- DASY52 52.8.8(1222); SEMCAD X 14.6.10(7331)

GSM 850 Body Back/Middle Channel/Zoom Scan (5x5x7)/Cube 0: Measurement grid: $dx=8\text{mm}$, $dy=8\text{mm}$, $dz=5\text{mm}$

Reference Value = 17.10 V/m; Power Drift = 0.04 dB

Peak SAR (extrapolated) = 0.378 W/kg

SAR(1 g) = 0.253 W/kg; SAR(10 g) = 0.178 W/kg

Maximum value of SAR (measured) = 0.329 W/kg

GSM 850 Body Back/Middle Channel/Area Scan (41x61x1): Interpolated grid:

$dx=1.500 \text{ mm}$, $dy=1.500 \text{ mm}$

Maximum value of SAR (interpolated) = 0.326 W/kg

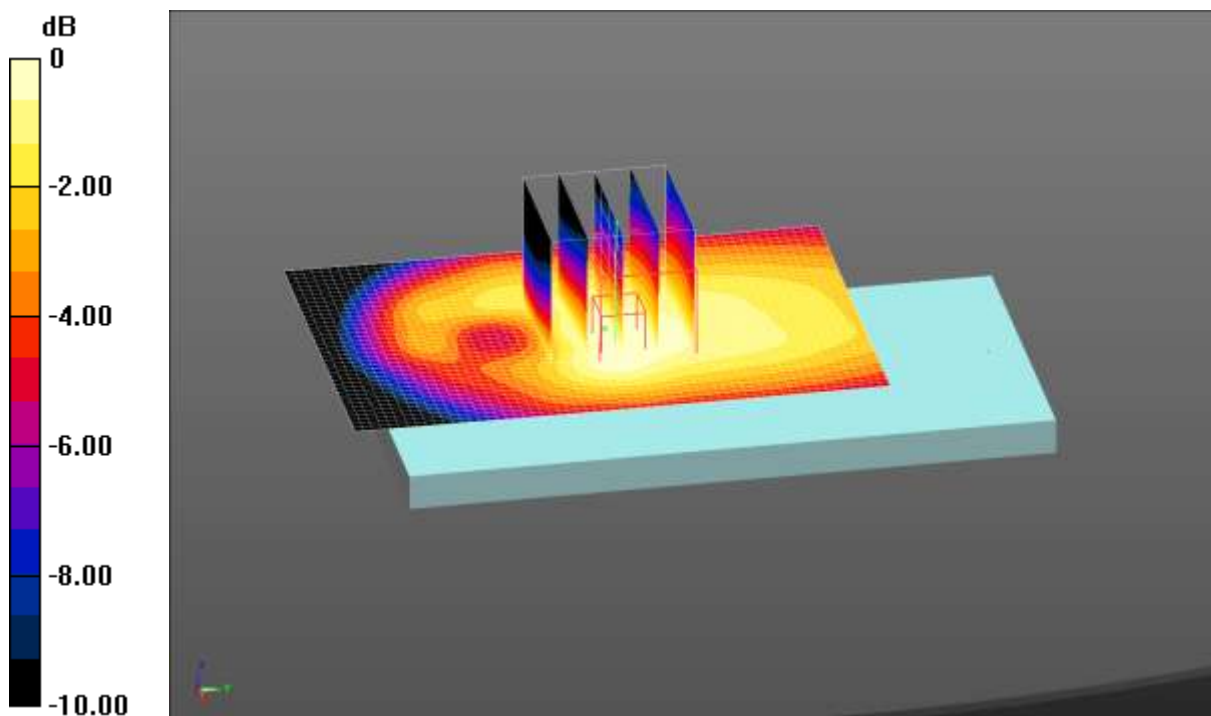

0 dB = 0.326 W/kg = -4.87 dBW/kg

Test Laboratory: CCIS

Date/Time: 07.04.2016 19:13:19

DUT: MOBILE PHONE; Type: Kinzo A5QL; Serial: 1#

Communication System: UID 0, GSM (0); Frequency: 1850.2 MHz

Medium parameters used (interpolated): $f = 1850.2$ MHz; $\sigma = 1.53$ S/m; $\epsilon_r = 52.63$; $\rho = 1000$ kg/m³

Phantom section: Flat Section

Measurement Standard: DASY5 (IEEE/IEC/ANSI C63.19-2007)

DASY Configuration:

- Probe: EX3DV4 - SN3924; ConvF(7.65, 7.65, 7.65); Calibrated: 07.10.2015;
- Sensor-Surface: 1.4mm (Mechanical Surface Detection), $z = 1.0, 31.0$
- Electronics: DAE4 Sn1373; Calibrated: 02.11.2016
- Phantom: ELI v5.0; Type: QDOVA002AA; Serial: TP:1208
- DASY52 52.8.8(1222); SEMCAD X 14.6.10(7331)

GSM 1900 Body Back/Low Channel/Area Scan (41x61x1): Interpolated grid:

$dx=1.500$ mm, $dy=1.500$ mm

Maximum value of SAR (interpolated) = 0.621 W/kg

GSM 1900 Body Back/Low Channel/Zoom Scan (5x5x7)/Cube 0: Measurement

grid: $dx=8$ mm, $dy=8$ mm, $dz=5$ mm

Reference Value = 10.22 V/m; Power Drift = 0.01 dB

Peak SAR (extrapolated) = 0.899 W/kg

SAR(1 g) = 0.497 W/kg; SAR(10 g) = 0.273 W/kg

Maximum value of SAR (measured) = 0.739 W/kg

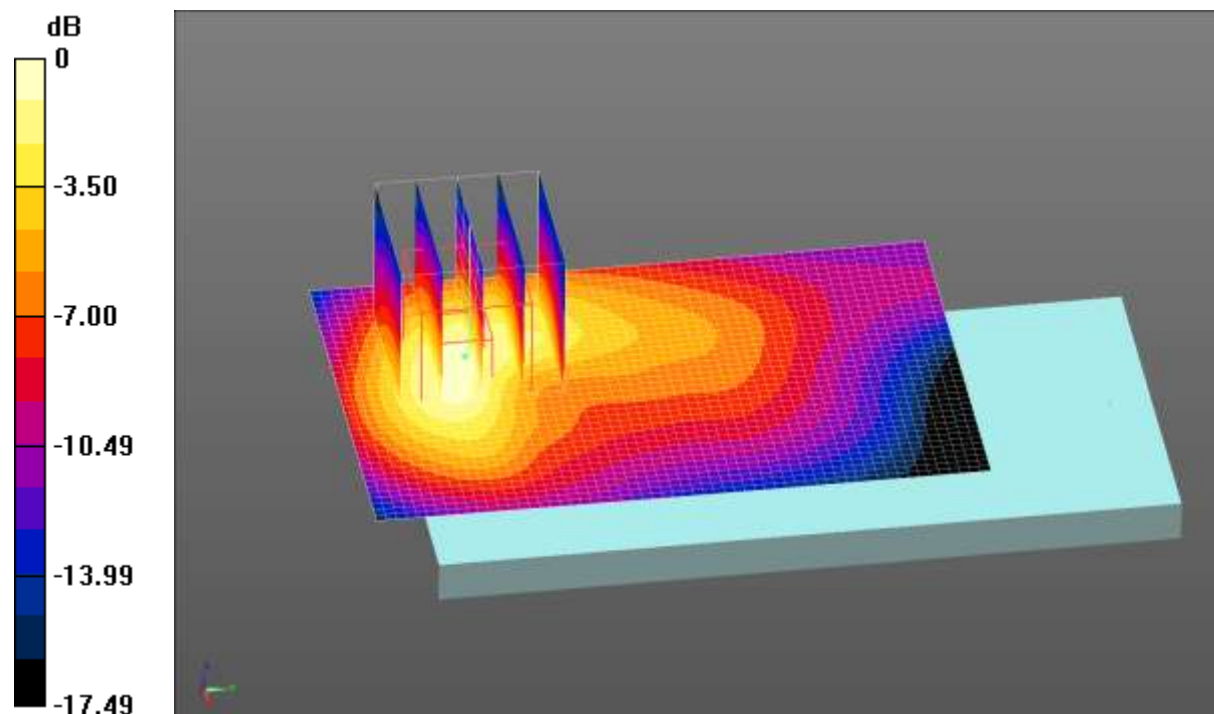

0 dB = 0.739 W/kg = -1.31 dBW/kg