



# TEST REPORT

**Report Reference No.**..... : **TRE1805016603** R/C.....: 83276

**FCC ID**..... : **QRP-AZUMIKA5QP**

**Applicant's name**..... : **Azumi S.A**

**Address**.....: Avenida Aquilino de la Guardia con Calle 47, PH Ocean Plaza, Piso 16 of. 16-01, Marbella, Ciudad de Panama, Panama

**Manufacturer**.....: AZUMI HK LTD

**Address**.....: FLAT/RM 18 BLK 1 14/F GOLDEN INDUSTRIAL BUILDING  
16-26 KWAI TAK STREET KWAI CHUNG,HK

**Test item description** ..... : **Mobile Phone**

**Trade Mark** .....: AZUMI

**Model/Type reference**.....: KIREI A5Q PLUS

**Listed Model(s)** .....: -

**Standard** ..... : **FCC CFR Title 47 Part 15 Subpart C Section 15.247**

**Date of receipt of test sample**.....: May.18,2018

**Date of testing**.....: May.19,2018- May.31,2018

**Date of issue**.....: Jun.01,2018

**Result**.....: **PASS**

Compiled by  
( position+printedname+signature)....: File administrators Candy Liu

Supervised by  
( position+printed name+signature)...: Project Engineer Aaron Fang

Approved by  
(position+printedname+signature).....: RF Manager Hans Hu

**Testing Laboratory Name** ..... : **Shenzhen Huatongwei International Inspection Co., Ltd.**

**Address**.....: 1/F, Bldg 3, Hongfa Hi-tech Industrial Park, Genyu Road, Tianliao, Gongming, Shenzhen, China

**Shenzhen Huatongwei International Inspection Co., Ltd. All rights reserved.**

This publication may be reproduced in whole or in part for non-commercial purposes as long as the Shenzhen Huatongwei International Inspection Co., Ltd. is acknowledged as copyright owner and source of the material. Shenzhen Huatongwei International Inspection Co., Ltd. takes no responsibility for and will not assume liability for damages resulting from the reader's interpretation of the reproduced material due to its placement and context.

*The test report merely correspond to the test sample.*

## Contents

<b>1.</b>	<b><u>TEST STANDARDS AND REPORT VERSION</u></b>	<b>3</b>
1.1.	Test Standards	3
1.2.	Report version	3
<b>2.</b>	<b><u>TEST DESCRIPTION</u></b>	<b>4</b>
<b>3.</b>	<b><u>SUMMARY</u></b>	<b>5</b>
3.1.	Client Information	5
3.2.	Product Description	5
3.3.	Operation state	6
3.4.	EUT configuration	6
3.5.	Modifications	6
<b>4.</b>	<b><u>TEST ENVIRONMENT</u></b>	<b>7</b>
4.1.	Address of the test laboratory	7
4.2.	Test Facility	7
4.3.	Environmental conditions	8
4.4.	Statement of the measurement uncertainty	8
4.5.	Equipments Used during the Test	9
<b>5.</b>	<b><u>TEST CONDITIONS AND RESULTS</u></b>	<b>11</b>
5.1.	Antenna requirement	11
5.2.	Conducted Emissions (AC Main)	12
5.3.	Conducted Peak Output Power	15
5.4.	Power Spectral Density	16
5.5.	6dB bandwidth	20
5.6.	Restricted band	24
5.7.	Band edge and Spurious Emissions (conducted)	28
5.8.	Spurious Emissions (radiated)	41
<b>6.</b>	<b><u>TEST SETUP PHOTOS</u></b>	<b>50</b>
<b>7.</b>	<b><u>EXTERANAL AND INTERNAL PHOTOS</u></b>	<b>51</b>

# **1. TEST STANDARDS AND REPORT VERSION**

## **1.1. Test Standards**

The tests were performed according to following standards:

[FCC Rules Part 15.247](#): Frequency Hopping, Direct Spread Spectrum and Hybrid Systems that are in operation within the bands of 902-928 MHz, 2400-2483.5 MHz, and 5725-5850 MHz.

[ANSI C63.10:2013](#): American National Standard for Testing Unlicensed Wireless Devices

[KDB 558074 D01 DTS Meas Guidance v04](#): Guidance for Performing Compliance Measurements on Digital Transmission Systems (DTS) Operating under §15.247

## **1.2. Report version**

Version No.	Date of issue	Description
00	Jun.01,2018	Original

## 2. TEST DESCRIPTION

Test Item	FCC Rule	Result	Test Engineer
Antenna requirement	15.203/15.247(c)	PASS	Xiaokang tan
Line Conducted Emissions (AC Main)	15.207	PASS	Tony Duan
Conducted Peak Output Power	15.247(b)(3)	PASS	Xiaokang tan
Power Spectral Density	15.247(e)	PASS	Xiaokang tan
6dB Bandwidth	15.247(a)(2)	PASS	Xiaokang tan
Restricted band	15.247(d)/15.205	PASS	Xiaokang tan
Spurious Emissions	15.247(d)/15.209	PASS	Jiuru Pan

Note: The measurement uncertainty is not included in the test result.

### 3. SUMMARY

#### 3.1. Client Information

Applicant:	Azumi S.A
Address:	Avenida Aquilino de la Guardia con Calle 47, PH Ocean Plaza, Piso 16 of. 16-01, Marbella, Ciudad de Panama, Panama
Manufacturer:	AZUMI HK LTD
Address:	FLAT/RM 18 BLK 1 14/F GOLDEN INDUSTRIAL BUILDING 16-26 KWAI TAK STREET KWAI CHUNG, HK

#### 3.2. Product Description

Name of EUT:	Mobile Phone
Trade Mark:	AZUMI
Model No.:	KIREI A5Q PLUS
Listed Model(s):	-
IMEI:	Conducted: 358798898788979 Radiated: 353018030000082
Power supply:	DC 3.7V
Adapter information:	Input: 100-240Va.c., 50/60Hz, 0.2A Output: 5Vd.c., 0.7A
Hardware version:	S511_MB_V1.3
Software version:	Azumi_s5015_base_v001(20180416)
<b>WIFI</b>	
Supported type:	802.11b/802.11g/802.11n(HT20)
Modulation:	DSSS for 802.11b OFDM for 802.11g/802.11n(HT20)
Operation frequency:	2412MHz~2462MHz
Channel number:	11
Channel separation:	5MHz
Antenna type:	PIFA Antenna
Antenna gain:	1.0dBi

### 3.3. Operation state

➤ **Test frequency list**

According to section 15.31(m), regards to the operating frequency range over 10 MHz, must select three channel which were tested. the Lowest frequency, the middle frequency, and the highest frequency of channel were selected to perform the test, please see the above gray bottom.

802.11b/g/n(HT20)	
Channel	Frequency (MHz)
01	2412
02	2417
...	...
06	2437
...	...
10	2457
11	2462

➤ **Test mode**

For RF test items
The engineering test program was provided and enabled to make EUT continuous transmit (duty cycle>98%).
For AC power line conducted emissions:
The EUT was set to connect with the WLAN AP under large package sizes transmission.
For Radiated suprious emissions test item:
The engineering test program was provided and enabled to make EUT continuous transmit(duty cycle>98%). The EUT in each of three orthogonal axis emissions had been tested ,but only the worst case (X axis) data Recorded in the report.

### 3.4. EUT configuration

The following peripheral devices and interface cables were connected during the measurement:

- - supplied by the manufacturer
- - supplied by the lab

○ /	Manufacturer:	/
	Model No.:	/
○ /	Manufacturer:	/
	Model No.:	/

### 3.5. Modifications

No modifications were implemented to meet testing criteria.

## **4. TEST ENVIRONMENT**

### **4.1. Address of the test laboratory**

Laboratory: Shenzhen Huatongwei International Inspection Co., Ltd.

Address: 1/F, Bldg 3, Hongfa Hi-tech Industrial Park, Genyu Road, Tianliao, Gongming, Shenzhen, China

### **4.2. Test Facility**

#### **CNAS-Lab Code: L1225**

Shenzhen Huatongwei International Inspection Co., Ltd. has been assessed and proved to be in compliance with CNAS-CL01 Accreditation Criteria for Testing and Calibration Laboratories (identical to ISO/IEC17025: 2005 General Requirements) for the Competence of Testing and Calibration Laboratories.

#### **A2LA-Lab Cert. No.: 3902.01**

Shenzhen Huatongwei International Inspection Co., Ltd. EMC Laboratory has been accredited by A2LA for technical competence in the field of electrical testing, and proved to be in compliance with ISO/IEC 17025: 2005 General Requirements for the Competence of Testing and Calibration Laboratories and any additional program requirements in the identified field of testing.

#### **FCC-Registration No.: 762235**

Shenzhen Huatongwei International Inspection Co., Ltd. EMC Laboratory has been registered and fully described in a report filed with the FCC (Federal Communications Commission). The acceptance letter from the FCC is maintained in our files.

#### **IC-Registration No.:5377B-1**

Two 3m Alternate Test Site of Shenzhen Huatongwei International Inspection Co., Ltd. has been registered by Certification and Engineering Bureau of Industry Canada for the performance of radiated measurements with Registration No.: 5377B-1.

#### **ACA**

Shenzhen Huatongwei International Inspection Co., Ltd. EMC Laboratory can also perform testing for the Australian C-Tick mark as a result of our A2LA accreditation.

### 4.3. Environmental conditions

During the measurement the environmental conditions were within the listed ranges:

Temperature:	15~35°C
Relative Humidity:	30~60 %
Air Pressure:	950~1050mba

### 4.4. Statement of the measurement uncertainty

The data and results referenced in this document are true and accurate. The reader is cautioned that there may be errors in calibration limits of the equipment and facilities. The measurement uncertainty was calculated for all measurements listed in this test report according to TR-100028-01 "Electromagnetic compatibility and Radio spectrum Matters (ERM); Uncertainties in the measurement of mobile radio equipment characteristics; Part 1" and TR-100028-02 "Electromagnetic compatibility and Radio spectrum Matters (ERM); Uncertainties in the measurement of mobile radio equipment characteristics; Part 2" and is documented in the Shenzhen Huatongwei International Inspection Co., Ltd. quality system according to ISO/IEC 17025. Furthermore, component and process variability of devices similar to that tested may result in additional deviation. The manufacturer has the sole responsibility of continued compliance of the device.

Here after the best measurement capability for Shenzhen Huatongwei International Inspection Co., Ltd. is reported:

Test Items	Measurement Uncertainty	Notes
Transmitter power conducted	0.57 dB	(1)
Transmitter power Radiated	2.20 dB	(1)
Conducted spurious emissions 9kHz~40GHz	1.60 dB	(1)
Radiated spurious emissions 9kHz~40GHz	2.20 dB	(1)
Conducted Emissions 9kHz~30MHz	3.39 dB	(1)
Radiated Emissions 30~1000MHz	4.24 dB	(1)
Radiated Emissions 1~18GHz	5.16 dB	(1)
Radiated Emissions 18~40GHz	5.54 dB	(1)

(1) This uncertainty represents an expanded uncertainty expressed at approximately the 95% confidence level using a coverage factor of  $k=1.96$ .



#### 4.5. Equipments Used during the Test

Conducted Emissions						
Item	Test Equipment	Manufacturer	Model No.	Serial No.	Last Cal. (mm-dd-yy)	Next Cal. (mm-dd-yy)
1	EMI Test Receiver	R&S	ESCI	101247	11/11/2017	11/10/2018
2	Artificial Mains	SCHWARZBECK	NNLK 8121	573	11/11/2017	11/10/2018
3	2-Line V-Network	R&S	ESH3-Z5	100049	11/11/2017	11/10/2018
4	Pulse Limiter	R&S	ESH3-Z2	101488	11/11/2017	11/10/2018
5	RF Connection Cable	HUBER+SUHNER	EF400	N/A	11/21/2017	11/20/2018
6	Test Software	R&S	ES-K1	N/A	N/A	N/A

Radiated Emissions						
Item	Test Equipment	Manufacturer	Model No.	Serial No.	Last Cal. (mm-dd-yy)	Next Cal. (mm-dd-yy)
1	Semi-Anechoic Chamber	Albatross projects	SAC-3m-01	C11121	10/16/2016	10/15/2019
2	EMI Test Receiver	R&S	ESCI	100900	11/11/2017	11/10/2018
3	Loop Antenna	R&S	HFH2-Z2	100020	11/20/2017	11/19/2020
4	Ultra-Broadband Antenna	SCHWARZBECK	VULB9163	538	4/5/2017	4/4/2020
5	Horn Antenna	SCHWARZBECK	9120D	1011	3/27/2017	3/26/2020
6	Broadband Horn Antenna	SCHWARZBECK	BBHA9170	BBHA9170 472	3/27/2017	3/26/2020
7	Pre-amplifier	SCHWARZBECK	BBV 9743	9743-0022	10/18/2017	10/17/2018
8	Broadband Pre-amplifier	SCHWARZBECK	BBV 9718	9718-248	10/18/2017	10/17/2018
9	Spectrum Analyzer	R&S	FSP40	100597	11/11/2017	11/10/2018
10	RF Connection Cable	HUBER+SUHNER	RE-7-FL	N/A	11/21/2017	11/20/2018
11	RF Connection Cable	HUBER+SUHNER	RE-7-FH	N/A	11/21/2017	11/20/2018
12	Test Software	Audix	E3	N/A	N/A	N/A
13	Test Software	R&S	ES-K1	N/A	N/A	N/A
14	Turntable	Maturo Germany	TT2.0-1T	N/A	N/A	N/A
15	Antenna Mast	Maturo Germany	CAM-4.0-P-12	N/A	N/A	N/A

<b>RF Conducted Test</b>						
Item	Test Equipment	Manufacturer	Model No.	Serial No.	Last Cal. (mm-dd-yy)	Next Cal. (mm-dd-yy)
1	Spectrum Analyzer	R&S	FSV40	100048	11/11/2017	11/10/2018
2	EXA Signal Analyzer	Agilent	N9020A	184247	9/22/2017	9/21/2018
3	Power Meter	Anritsu	ML249A	N/A	9/22/2017	9/21/2018
4	OSP	R&S	OSP120	101317	N/A	N/A

## 5. TEST CONDITIONS AND RESULTS

### 5.1. Antenna requirement

#### REQUIREMENT:

#### **FCC CFR Title 47 Part 15 Subpart C Section 15.203:**

An intentional radiator shall be designed to ensure that no antenna other than that furnished by the responsible party shall be used with the device. The use of a permanently attached antenna or of an antenna that uses a unique coupling to the intentional radiator, the manufacturer may design the unit so that a broken antenna can be replaced by the user, but the use of a standard antenna jack or electrical connector is prohibited.

#### **FCC CFR Title 47 Part 15 Subpart C Section 15.247(c) (1)(i):**

(i) Systems operating in the 2400~2483.5 MHz band that is used exclusively for fixed. Point-to-point operations may employ transmitting antennas with directional gain greater than 6 dBi provided the maximum conducted output power of the intentional radiator is reduced by 1 dB for every 3 dB that the directional gain of the antenna exceeds 6 dBi.

#### TEST RESULTS

Passed       Not Applicable

The directional gain of the antenna less than 6 dBi, please refer to the below antenna photo.

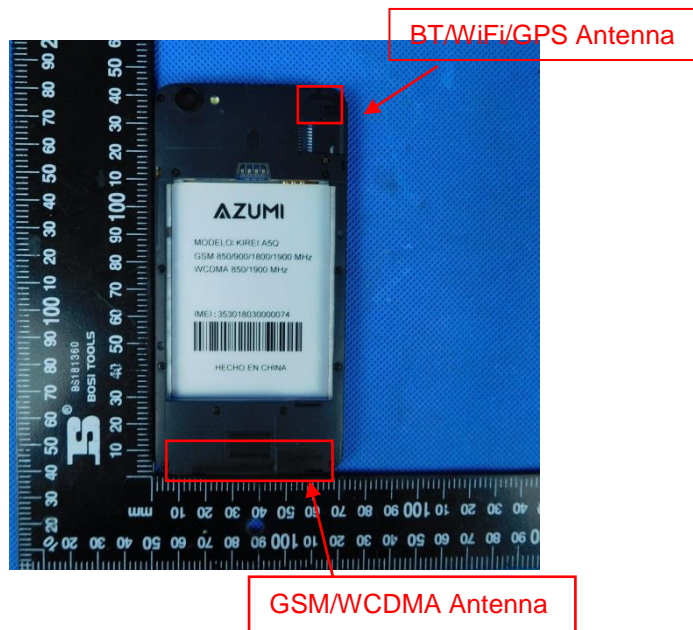

## 5.2. Conducted Emissions (AC Main)

### LIMIT

FCC CFR Title 47 Part 15 Subpart C Section 15.207:

Frequency range (MHz)	Limit (dBuV)	
	Quasi-peak	Average
0.15-0.5	66 to 56*	56 to 46*
0.5-5	56	46
5-30	60	50

\* Decreases with the logarithm of the frequency.

### TEST CONFIGURATION

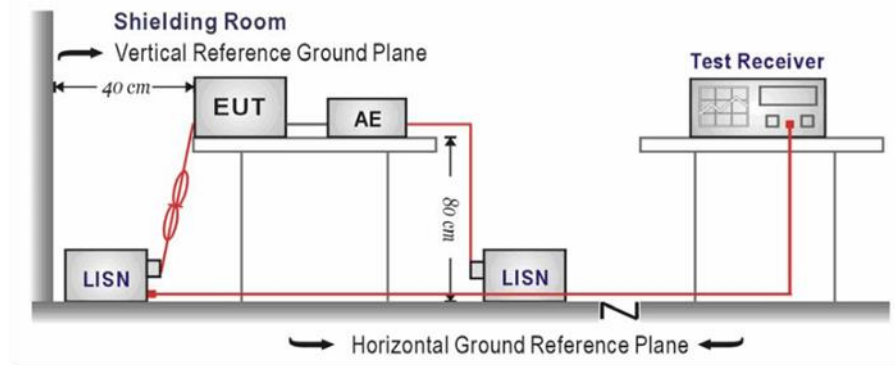

### TEST PROCEDURE

1. The EUT was setup according to ANSI C63.10:2013 requirements.
2. The EUT was placed on a platform of nominal size, 1 m by 1.5 m, raised 80 cm above the conducting ground plane. The vertical conducting plane was located 40 cm to the rear of the EUT. All other surfaces of EUT were at least 80 cm from any other grounded conducting surface.
3. The EUT and simulators are connected to the main power through a line impedances stabilization network (LISN). The LISN provides a 50 ohm /50uH coupling impedance for the measuring equipment.
4. The peripheral devices are also connected to the main power through a LISN. (Please refer to the block diagram of the test setup and photographs)
5. Each current-carrying conductor of the EUT power cord, except the ground (safety) conductor, was individually connected through a LISN to the input power source.
6. The excess length of the power cord between the EUT and the LISN receptacle were folded back and forth at the center of the lead to form a bundle not exceeding 40 cm in length.
7. Conducted Emissions were investigated over the frequency range from 0.15MHz to 30MHz using a receiver bandwidth of 9 kHz.
8. During the above scans, the emissions were maximized by cable manipulation.

### TEST MODE:

Please refer to the clause 3.3

### TEST RESULTS

Passed       Not Applicable

Note:

- 1) Transd=Cable lose+ Pulse Limiter Factor + Artificial Mains Factor
- 2) Margin= Limit -Level

Test Line:

L

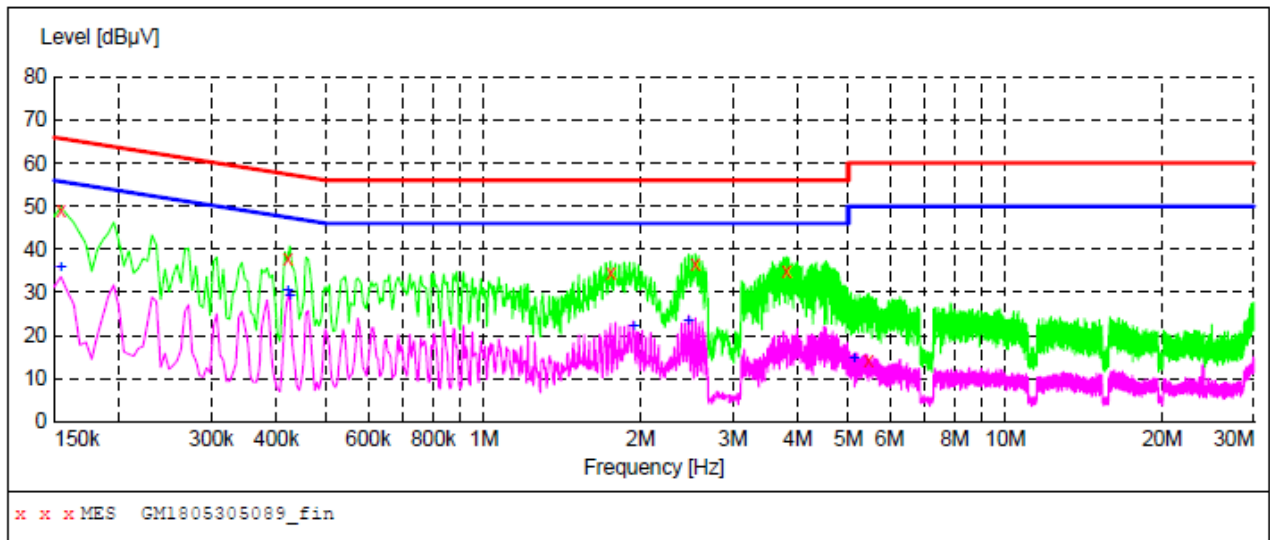

**MEASUREMENT RESULT: "GM1805305089\_fin"**

5/30/2018 8:09PM

Frequency MHz	Level dBµV	Transd dB	Limit dBµV	Margin dB	Detector	Line	PE
0.154500	49.20	10.0	66	16.6	QP	L1	GND
0.420000	38.00	9.9	57	19.4	QP	L1	GND
1.747500	34.70	10.1	56	21.3	QP	L1	GND
2.544000	36.40	10.1	56	19.6	QP	L1	GND
3.804000	35.10	10.1	56	20.9	QP	L1	GND
5.478000	14.30	10.2	60	45.7	QP	L1	GND

**MEASUREMENT RESULT: "GM1805305089\_fin2"**

5/30/2018 8:09PM

Frequency MHz	Level dBµV	Transd dB	Limit dBµV	Margin dB	Detector	Line	PE
0.154500	35.90	10.0	56	19.9	AV	L1	GND
0.420000	30.30	9.9	47	17.1	AV	L1	GND
0.424500	28.90	9.9	47	18.5	AV	L1	GND
1.936500	22.00	10.1	46	24.0	AV	L1	GND
2.472000	23.50	10.1	46	22.5	AV	L1	GND
5.122500	14.50	10.2	50	35.5	AV	L1	GND

Test Line:

N

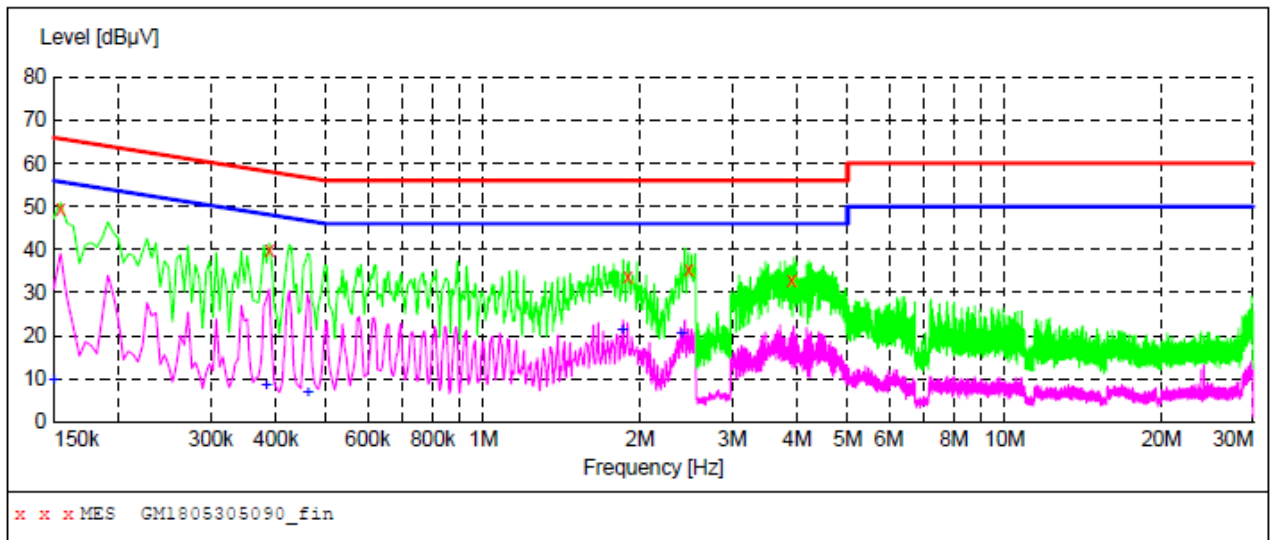

**MEASUREMENT RESULT: "GM1805305090\_fin"**

5/30/2018 8:12PM

Frequency MHz	Level dBµV	Transd dB	Limit dBµV	Margin dB	Detector	Line	PE
0.154500	49.30	10.0	66	16.5	QP	N	GND
0.388500	39.80	9.9	58	18.3	QP	N	GND
1.896000	33.50	10.1	56	22.5	QP	N	GND
2.476500	35.50	10.1	56	20.5	QP	N	GND
3.907500	32.70	10.1	56	23.3	QP	N	GND

**MEASUREMENT RESULT: "GM1805305090\_fin2"**

5/30/2018 8:12PM

Frequency MHz	Level dBµV	Transd dB	Limit dBµV	Margin dB	Detector	Line	PE
0.150000	9.70	10.0	56	46.3	AV	N	GND
0.384000	8.30	9.9	48	39.9	AV	N	GND
0.460500	6.90	9.9	47	39.8	AV	N	GND
1.851000	21.20	10.1	46	24.8	AV	N	GND
2.400000	20.40	10.1	46	25.6	AV	N	GND

### 5.3. Conducted Peak Output Power

#### LIMIT

FCC CFR Title 47 Part 15 Subpart C Section 15.247 (b)(3): 30dBm

#### TEST CONFIGURATION

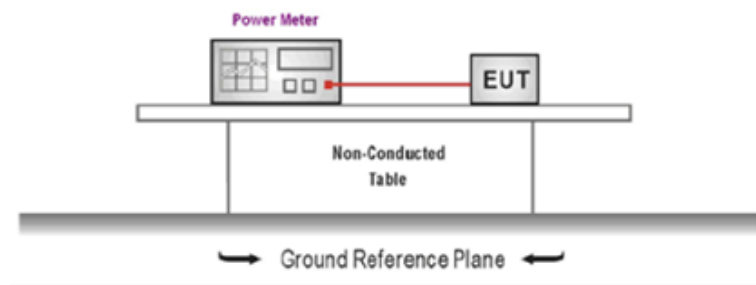

#### TEST PROCEDURE

1. The EUT was tested according to ANSI C63.10: 2013 and KDB 558074 D01 for compliance to FCC 47 CFR 15.247 requirements.
2. The maximum peak conducted output power may be measured using a broadband peak RF power meter.
3. The power meter shall have a video bandwidth that is greater than or equal to the DTS bandwidth and shall utilize a fast-responding diode detector
4. Record the measurement data.

#### TEST MODE:

Please refer to the clause 3.3

#### TEST RESULTS

Passed       Not Applicable

Type	Channel	Output power (dBm)	Limit (dBm)	Result
802.11b	01	18.24	≤30.00	Pass
	06	17.99		
	11	17.27		
802.11g	01	15.44	≤30.00	Pass
	06	15.57		
	11	14.62		
802.11n(HT20)	01	14.80	≤30.00	Pass
	06	14.63		
	11	13.21		

### 5.4. Power Spectral Density

#### LIMIT

#### **FCC CFR Title 47 Part 15 Subpart C Section 15.247 (e):**

For digitally modulated systems, the power spectral density conducted from the intentional radiator to the antenna shall not be greater than 8 dBm in any 3 kHz band during any time interval of continuous transmission.

#### TEST CONFIGURATION

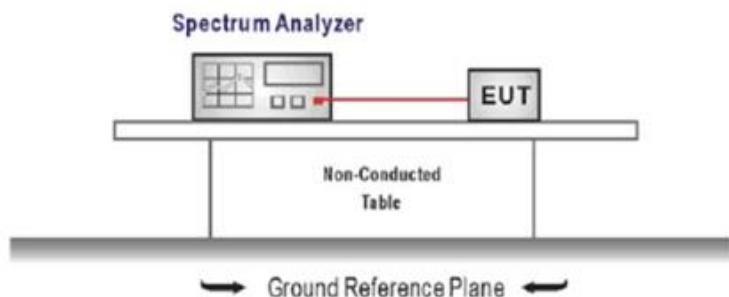

#### TEST PROCEDURE

1. Connect the antenna port(s) to the spectrum analyzer input,
2. Configure the spectrum analyzer as shown below:  
 Center frequency=DTS channel center frequency  
 Span =1.5 times the DTS bandwidth  
 RBW = 3 kHz ≤ RBW ≤ 100 kHz, VBW ≥ 3 × RBW  
 Sweep time = auto couple  
 Detector = peak  
 Trace mode = max hold
3. Place the radio in continuous transmit mode, allow the trace to stabilize, view the transmitter wave form on the spectrum analyzer.
4. Use the peak marker function to determine the maximum amplitude level within the RBW.
5. If measured value exceeds limit, reduce RBW (no less than 3 kHz) and repeat.

#### TEST MODE:

Please refer to the clause 3.3

#### TEST RESULTS

Passed       Not Applicable

Type	Channel	Power Spectral Density (dBm/30KHz)	Power Spectral Density (dBm/3KHz)	Limit (dBm/3KHz)	Result
802.11b	01	1.75	-8.25	≤8.00	Pass
	06	0.52	-9.48		
	11	1.65	-8.35		
802.11g	01	-8.79	-18.79	≤8.00	Pass
	06	-8.86	-18.86		
	11	-9.47	-19.47		
802.11n(HT20)	01	-9.32	-19.32	≤8.00	Pass
	06	-9.69	-19.69		
	11	-10.77	-20.77		

Test plot as follows:

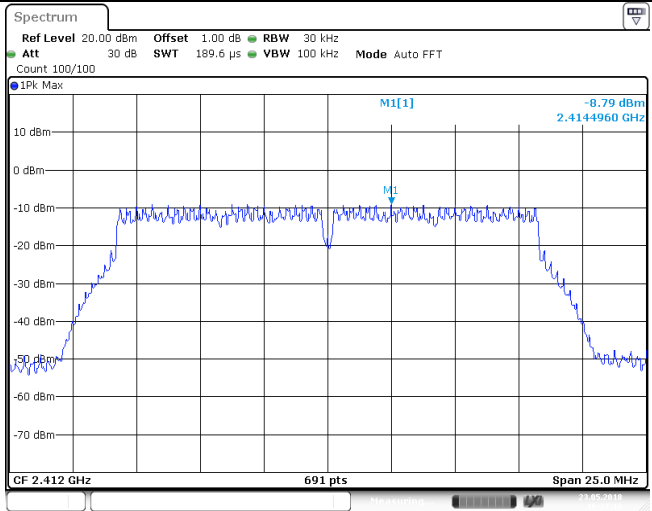
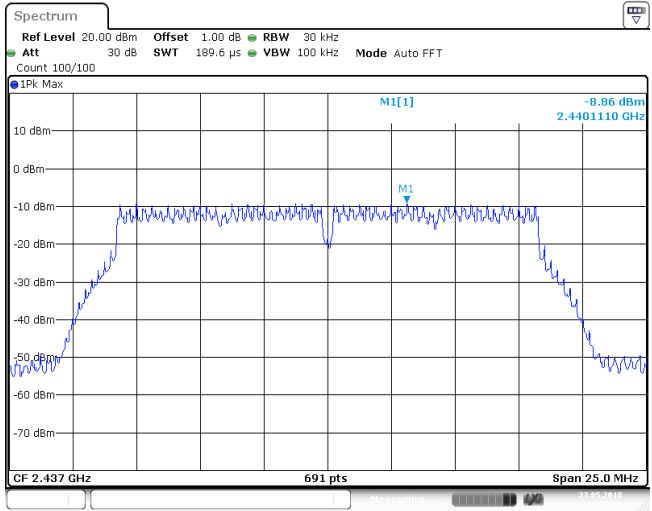
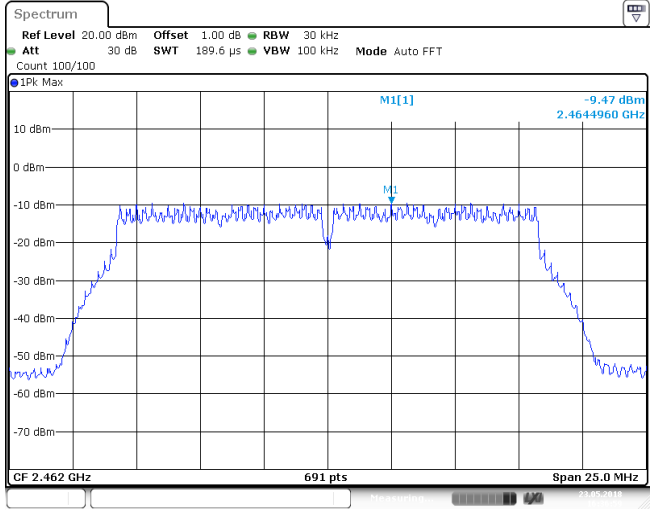

Type:		802.11 b
CH01	<p><b>Spectrum</b>                      Ref Level 20.00 dBm Offset 1.00 dB RBW 30 kHz                      Att 30 dB SWT 126.4 μs VBW 100 kHz Mode Auto FFT                      Count 100/100                      1PK Max                      1.75 dBm                      2.4127870 GHz                      CF 2.412 GHz 691 pts Span 16.0 MHz</p>	
CH06	<p><b>Spectrum</b>                      Ref Level 20.00 dBm Offset 1.00 dB RBW 30 kHz                      Att 30 dB SWT 126.4 μs VBW 100 kHz Mode Auto FFT                      Count 100/100                      1PK Max                      0.52 dBm                      2.4361660 GHz                      CF 2.437 GHz 691 pts Span 16.0 MHz</p>	
CH11	<p><b>Spectrum</b>                      Ref Level 20.00 dBm Offset 1.00 dB RBW 30 kHz                      Att 30 dB SWT 126.4 μs VBW 100 kHz Mode Auto FFT                      Count 100/100                      1PK Max                      1.65 dBm                      2.4610040 GHz                      CF 2.462 GHz 691 pts Span 16.0 MHz</p>	

Type:		802.11 g
CH01		
CH06		
CH11		

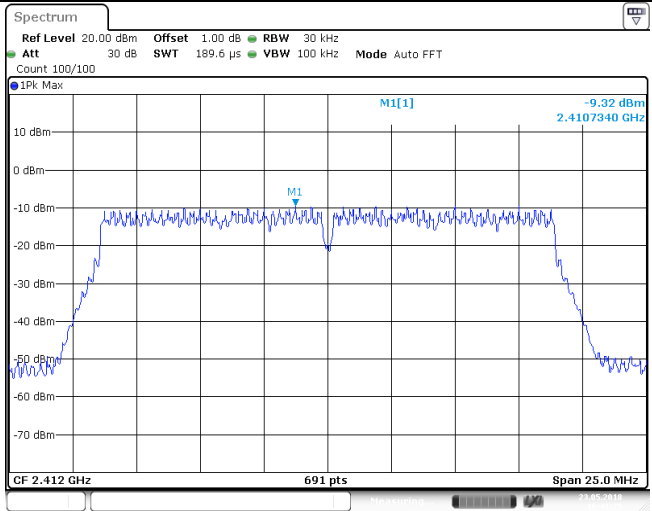
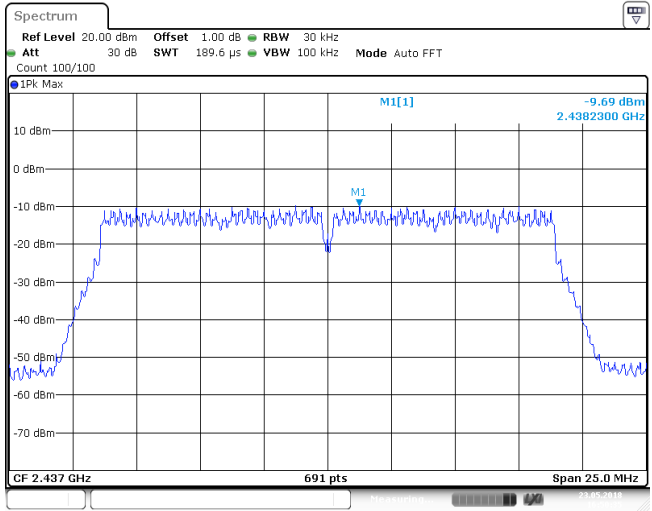
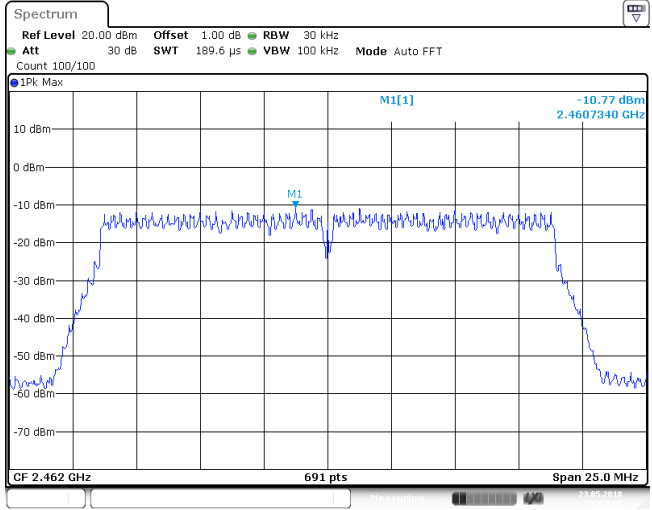
Type:		802.11n(HT20)
CH01	 <p>Spectrum plot for CH01. The plot shows a signal centered at 2.412 GHz. The peak level is -9.32 dBm. The plot includes a grid and various measurement parameters: Ref Level 20.00 dBm, Att 30 dB, Offset 1.00 dB, RBW 30 kHz, Mode Auto FFT, Count 100/100, SWT 189.6 μs, and VBW 100 kHz. The signal is labeled M1[1] and M1. The plot also shows a span of 25.0 MHz and 691 points.</p>	
CH06	 <p>Spectrum plot for CH06. The plot shows a signal centered at 2.437 GHz. The peak level is -9.69 dBm. The plot includes a grid and various measurement parameters: Ref Level 20.00 dBm, Att 30 dB, Offset 1.00 dB, RBW 30 kHz, Mode Auto FFT, Count 100/100, SWT 189.6 μs, and VBW 100 kHz. The signal is labeled M1[1] and M1. The plot also shows a span of 25.0 MHz and 691 points.</p>	
CH11	 <p>Spectrum plot for CH11. The plot shows a signal centered at 2.462 GHz. The peak level is -10.77 dBm. The plot includes a grid and various measurement parameters: Ref Level 20.00 dBm, Att 30 dB, Offset 1.00 dB, RBW 30 kHz, Mode Auto FFT, Count 100/100, SWT 189.6 μs, and VBW 100 kHz. The signal is labeled M1[1] and M1. The plot also shows a span of 25.0 MHz and 691 points.</p>	

**5.5. 6dB bandwidth**

**LIMIT**

**FCC CFR Title 47 Part 15 Subpart C Section 15.247 (a)(2):**

For digital modulation systems, the minimum 6 dB bandwidth shall be at least 500 kHz.

**TEST CONFIGURATION**

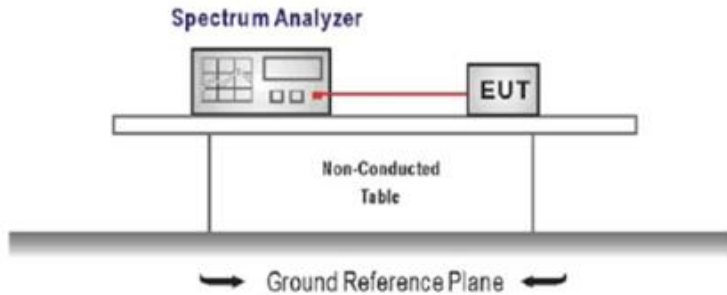

**TEST PROCEDURE**

1. Connect the antenna port(s) to the spectrum analyzer input.
2. Configure the spectrum analyzer as shown below (enter all losses between the transmitter output and the spectrum analyzer).  
 Center Frequency =DTS channel center frequency  
 Span=2 x DTS bandwidth  
 RBW = 100 kHz, VBW ≥ 3 × RBW  
 Sweep time= auto couple  
 Detector = Peak  
 Trace mode = max hold
3. Place the radio in continuous transmit mode, allow the trace to stabilize, view the transmitter wave form on the spectrum analyzer.
4. Measure the maximum width of the emission that is constrained by the frequencies associated with the two outermost amplitude points (upper and lower frequencies) that are attenuated by 6 dB relative to the maximum level measured in the fundamental emission, and record the pertinent measurements.

**TEST MODE:**

Please refer to the clause 3.3

**TEST RESULTS**

Passed       Not Applicable

Type	Channel	6dB Bandwidth (MHz)	Limit (kHz)	Result
802.11b	01	10.08	≥500	Pass
	06	10.08		
	11	9.15		
802.11g	01	16.41	≥500	Pass
	06	16.41		
	11	16.38		
802.11n(HT20)	01	17.67	≥500	Pass
	06	17.64		
	11	17.64		

Test plot as follows:

Type:	802.11 b																												
CH01	<p>Spectrum</p> <p>Ref Level 20.50 dBm Offset 1.00 dB RBW 100 kHz          Att 30 dB SWT 75.9 μs VBW 300 kHz Mode Auto FFT          Count 500/500</p> <p>1PK View</p> <p>10 dBm          0 dBm          -10 dBm          -20 dBm          -30 dBm          -40 dBm          -50 dBm          -60 dBm          -70 dBm</p> <p>CF 2.412 GHz 1001 pts Span 30.0 MHz</p> <p>Marker</p> <table border="1"> <thead> <tr> <th>Type</th> <th>Ref</th> <th>Trc</th> <th>X-value</th> <th>Y-value</th> <th>Function</th> <th>Function Result</th> </tr> </thead> <tbody> <tr> <td>M1</td> <td></td> <td>1</td> <td>2.40696 GHz</td> <td>0.19 dBm</td> <td></td> <td></td> </tr> <tr> <td>M2</td> <td></td> <td>1</td> <td>2.41299 GHz</td> <td>6.36 dBm</td> <td></td> <td></td> </tr> <tr> <td>D3</td> <td>M1</td> <td>1</td> <td>10.08 MHz</td> <td>-0.63 dB</td> <td></td> <td></td> </tr> </tbody> </table>	Type	Ref	Trc	X-value	Y-value	Function	Function Result	M1		1	2.40696 GHz	0.19 dBm			M2		1	2.41299 GHz	6.36 dBm			D3	M1	1	10.08 MHz	-0.63 dB		
Type	Ref	Trc	X-value	Y-value	Function	Function Result																							
M1		1	2.40696 GHz	0.19 dBm																									
M2		1	2.41299 GHz	6.36 dBm																									
D3	M1	1	10.08 MHz	-0.63 dB																									
CH06	<p>Spectrum</p> <p>Ref Level 20.50 dBm Offset 1.00 dB RBW 100 kHz          Att 30 dB SWT 75.9 μs VBW 300 kHz Mode Auto FFT          Count 500/500</p> <p>1PK View</p> <p>10 dBm          0 dBm          -10 dBm          -20 dBm          -30 dBm          -40 dBm          -50 dBm          -60 dBm          -70 dBm</p> <p>CF 2.437 GHz 1001 pts Span 30.0 MHz</p> <p>Marker</p> <table border="1"> <thead> <tr> <th>Type</th> <th>Ref</th> <th>Trc</th> <th>X-value</th> <th>Y-value</th> <th>Function</th> <th>Function Result</th> </tr> </thead> <tbody> <tr> <td>M1</td> <td></td> <td>1</td> <td>2.43196 GHz</td> <td>-0.42 dBm</td> <td></td> <td></td> </tr> <tr> <td>M2</td> <td></td> <td>1</td> <td>2.43799 GHz</td> <td>5.68 dBm</td> <td></td> <td></td> </tr> <tr> <td>D3</td> <td>M1</td> <td>1</td> <td>10.08 MHz</td> <td>-0.70 dB</td> <td></td> <td></td> </tr> </tbody> </table>	Type	Ref	Trc	X-value	Y-value	Function	Function Result	M1		1	2.43196 GHz	-0.42 dBm			M2		1	2.43799 GHz	5.68 dBm			D3	M1	1	10.08 MHz	-0.70 dB		
Type	Ref	Trc	X-value	Y-value	Function	Function Result																							
M1		1	2.43196 GHz	-0.42 dBm																									
M2		1	2.43799 GHz	5.68 dBm																									
D3	M1	1	10.08 MHz	-0.70 dB																									
CH11	<p>Spectrum</p> <p>Ref Level 20.50 dBm Offset 1.00 dB RBW 100 kHz          Att 30 dB SWT 75.9 μs VBW 300 kHz Mode Auto FFT          Count 500/500</p> <p>1PK View</p> <p>10 dBm          0 dBm          -10 dBm          -20 dBm          -30 dBm          -40 dBm          -50 dBm          -60 dBm          -70 dBm</p> <p>CF 2.462 GHz 1001 pts Span 30.0 MHz</p> <p>Marker</p> <table border="1"> <thead> <tr> <th>Type</th> <th>Ref</th> <th>Trc</th> <th>X-value</th> <th>Y-value</th> <th>Function</th> <th>Function Result</th> </tr> </thead> <tbody> <tr> <td>M1</td> <td></td> <td>1</td> <td>2.45741 GHz</td> <td>-2.02 dBm</td> <td></td> <td></td> </tr> <tr> <td>M2</td> <td></td> <td>1</td> <td>2.46149 GHz</td> <td>5.72 dBm</td> <td></td> <td></td> </tr> <tr> <td>D3</td> <td>M1</td> <td>1</td> <td>9.15 MHz</td> <td>0.54 dB</td> <td></td> <td></td> </tr> </tbody> </table>	Type	Ref	Trc	X-value	Y-value	Function	Function Result	M1		1	2.45741 GHz	-2.02 dBm			M2		1	2.46149 GHz	5.72 dBm			D3	M1	1	9.15 MHz	0.54 dB		
Type	Ref	Trc	X-value	Y-value	Function	Function Result																							
M1		1	2.45741 GHz	-2.02 dBm																									
M2		1	2.46149 GHz	5.72 dBm																									
D3	M1	1	9.15 MHz	0.54 dB																									

Type:		802.11 g																												
CH01	<p><b>Spectrum</b>                      Ref Level 20.50 dBm Offset 1.00 dB RBW 100 kHz                      Att 30 dB SWT 75.9 μs VBW 300 kHz Mode Auto FFT                      Count 500/500</p> <p>CF 2.412 GHz 1001 pts Span 30.0 MHz</p> <table border="1"> <thead> <tr> <th>Type</th> <th>Ref</th> <th>Trc</th> <th>X-value</th> <th>Y-value</th> <th>Function</th> <th>Function Result</th> </tr> </thead> <tbody> <tr> <td>M1</td> <td>1</td> <td></td> <td>2.40378 GHz</td> <td>-10.95 dBm</td> <td></td> <td></td> </tr> <tr> <td>M2</td> <td>1</td> <td></td> <td>2.41698 GHz</td> <td>-4.17 dBm</td> <td></td> <td></td> </tr> <tr> <td>D3</td> <td>M1</td> <td>1</td> <td>16.41 MHz</td> <td>0.51 dB</td> <td></td> <td></td> </tr> </tbody> </table>		Type	Ref	Trc	X-value	Y-value	Function	Function Result	M1	1		2.40378 GHz	-10.95 dBm			M2	1		2.41698 GHz	-4.17 dBm			D3	M1	1	16.41 MHz	0.51 dB		
Type	Ref	Trc	X-value	Y-value	Function	Function Result																								
M1	1		2.40378 GHz	-10.95 dBm																										
M2	1		2.41698 GHz	-4.17 dBm																										
D3	M1	1	16.41 MHz	0.51 dB																										
CH06	<p><b>Spectrum</b>                      Ref Level 20.50 dBm Offset 1.00 dB RBW 100 kHz                      Att 30 dB SWT 75.9 μs VBW 300 kHz Mode Auto FFT                      Count 500/500</p> <p>CF 2.437 GHz 1001 pts Span 30.0 MHz</p> <table border="1"> <thead> <tr> <th>Type</th> <th>Ref</th> <th>Trc</th> <th>X-value</th> <th>Y-value</th> <th>Function</th> <th>Function Result</th> </tr> </thead> <tbody> <tr> <td>M1</td> <td>1</td> <td></td> <td>2.42878 GHz</td> <td>-11.25 dBm</td> <td></td> <td></td> </tr> <tr> <td>M2</td> <td>1</td> <td></td> <td>2.44198 GHz</td> <td>-4.24 dBm</td> <td></td> <td></td> </tr> <tr> <td>D3</td> <td>M1</td> <td>1</td> <td>16.41 MHz</td> <td>0.45 dB</td> <td></td> <td></td> </tr> </tbody> </table>		Type	Ref	Trc	X-value	Y-value	Function	Function Result	M1	1		2.42878 GHz	-11.25 dBm			M2	1		2.44198 GHz	-4.24 dBm			D3	M1	1	16.41 MHz	0.45 dB		
Type	Ref	Trc	X-value	Y-value	Function	Function Result																								
M1	1		2.42878 GHz	-11.25 dBm																										
M2	1		2.44198 GHz	-4.24 dBm																										
D3	M1	1	16.41 MHz	0.45 dB																										
CH11	<p><b>Spectrum</b>                      Ref Level 20.50 dBm Offset 1.00 dB RBW 100 kHz                      Att 30 dB SWT 75.9 μs VBW 300 kHz Mode Auto FFT                      Count 500/500</p> <p>CF 2.462 GHz 1001 pts Span 30.0 MHz</p> <table border="1"> <thead> <tr> <th>Type</th> <th>Ref</th> <th>Trc</th> <th>X-value</th> <th>Y-value</th> <th>Function</th> <th>Function Result</th> </tr> </thead> <tbody> <tr> <td>M1</td> <td>1</td> <td></td> <td>2.45381 GHz</td> <td>-11.07 dBm</td> <td></td> <td></td> </tr> <tr> <td>M2</td> <td>1</td> <td></td> <td>2.46698 GHz</td> <td>-4.93 dBm</td> <td></td> <td></td> </tr> <tr> <td>D3</td> <td>M1</td> <td>1</td> <td>16.38 MHz</td> <td>-0.34 dB</td> <td></td> <td></td> </tr> </tbody> </table>		Type	Ref	Trc	X-value	Y-value	Function	Function Result	M1	1		2.45381 GHz	-11.07 dBm			M2	1		2.46698 GHz	-4.93 dBm			D3	M1	1	16.38 MHz	-0.34 dB		
Type	Ref	Trc	X-value	Y-value	Function	Function Result																								
M1	1		2.45381 GHz	-11.07 dBm																										
M2	1		2.46698 GHz	-4.93 dBm																										
D3	M1	1	16.38 MHz	-0.34 dB																										

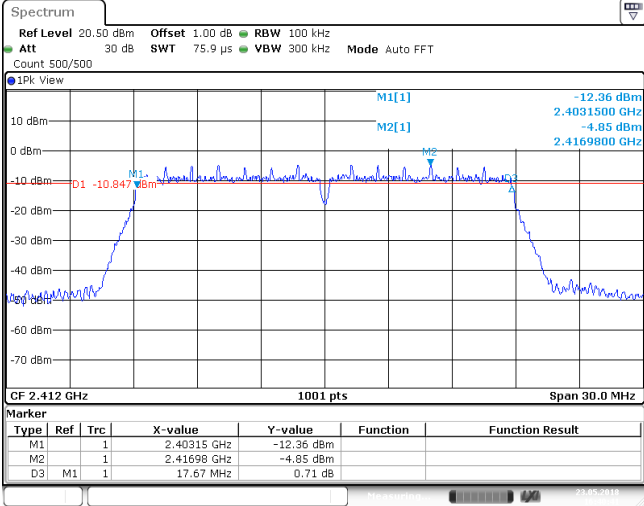
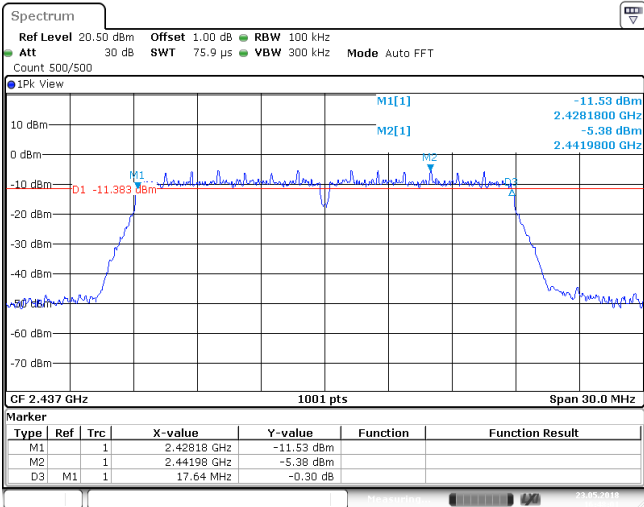
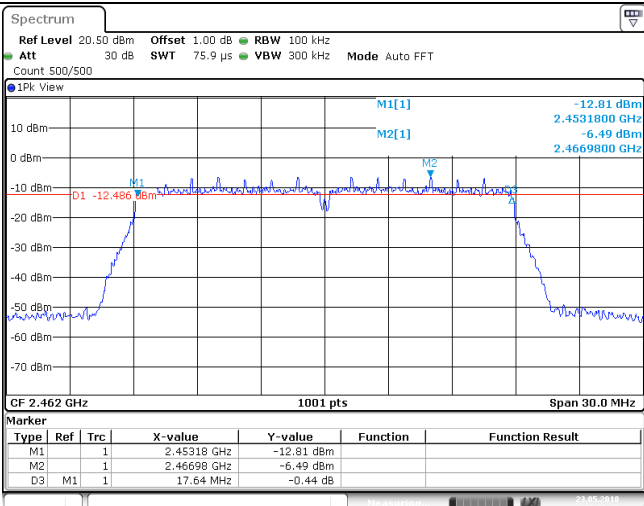
Type:	802.11n(HT20)																												
CH01	 <p>Spectrum</p> <p>Ref Level 20.50 dBm Offset 1.00 dB RBW 100 kHz          Att 30 dB SWT 75.9 μs VBW 300 kHz Mode Auto FFT          Count 500/500</p> <p>1PK View</p> <p>CF 2.412 GHz 1001 pts Span 30.0 MHz</p> <table border="1"> <thead> <tr> <th>Type</th> <th>Ref</th> <th>Trc</th> <th>X-value</th> <th>Y-value</th> <th>Function</th> <th>Function Result</th> </tr> </thead> <tbody> <tr> <td>M1</td> <td></td> <td>1</td> <td>2.40315 GHz</td> <td>-12.36 dBm</td> <td></td> <td></td> </tr> <tr> <td>M2</td> <td></td> <td>1</td> <td>2.41698 GHz</td> <td>-4.85 dBm</td> <td></td> <td></td> </tr> <tr> <td>D3</td> <td>M1</td> <td>1</td> <td>17.67 MHz</td> <td>0.71 dB</td> <td></td> <td></td> </tr> </tbody> </table>	Type	Ref	Trc	X-value	Y-value	Function	Function Result	M1		1	2.40315 GHz	-12.36 dBm			M2		1	2.41698 GHz	-4.85 dBm			D3	M1	1	17.67 MHz	0.71 dB		
Type	Ref	Trc	X-value	Y-value	Function	Function Result																							
M1		1	2.40315 GHz	-12.36 dBm																									
M2		1	2.41698 GHz	-4.85 dBm																									
D3	M1	1	17.67 MHz	0.71 dB																									
CH06	 <p>Spectrum</p> <p>Ref Level 20.50 dBm Offset 1.00 dB RBW 100 kHz          Att 30 dB SWT 75.9 μs VBW 300 kHz Mode Auto FFT          Count 500/500</p> <p>1PK View</p> <p>CF 2.437 GHz 1001 pts Span 30.0 MHz</p> <table border="1"> <thead> <tr> <th>Type</th> <th>Ref</th> <th>Trc</th> <th>X-value</th> <th>Y-value</th> <th>Function</th> <th>Function Result</th> </tr> </thead> <tbody> <tr> <td>M1</td> <td></td> <td>1</td> <td>2.42818 GHz</td> <td>-11.53 dBm</td> <td></td> <td></td> </tr> <tr> <td>M2</td> <td></td> <td>1</td> <td>2.44198 GHz</td> <td>-5.38 dBm</td> <td></td> <td></td> </tr> <tr> <td>D3</td> <td>M1</td> <td>1</td> <td>17.64 MHz</td> <td>-0.30 dB</td> <td></td> <td></td> </tr> </tbody> </table>	Type	Ref	Trc	X-value	Y-value	Function	Function Result	M1		1	2.42818 GHz	-11.53 dBm			M2		1	2.44198 GHz	-5.38 dBm			D3	M1	1	17.64 MHz	-0.30 dB		
Type	Ref	Trc	X-value	Y-value	Function	Function Result																							
M1		1	2.42818 GHz	-11.53 dBm																									
M2		1	2.44198 GHz	-5.38 dBm																									
D3	M1	1	17.64 MHz	-0.30 dB																									
CH11	 <p>Spectrum</p> <p>Ref Level 20.50 dBm Offset 1.00 dB RBW 100 kHz          Att 30 dB SWT 75.9 μs VBW 300 kHz Mode Auto FFT          Count 500/500</p> <p>1PK View</p> <p>CF 2.462 GHz 1001 pts Span 30.0 MHz</p> <table border="1"> <thead> <tr> <th>Type</th> <th>Ref</th> <th>Trc</th> <th>X-value</th> <th>Y-value</th> <th>Function</th> <th>Function Result</th> </tr> </thead> <tbody> <tr> <td>M1</td> <td></td> <td>1</td> <td>2.45318 GHz</td> <td>-12.81 dBm</td> <td></td> <td></td> </tr> <tr> <td>M2</td> <td></td> <td>1</td> <td>2.46698 GHz</td> <td>-6.49 dBm</td> <td></td> <td></td> </tr> <tr> <td>D3</td> <td>M1</td> <td>1</td> <td>17.64 MHz</td> <td>-0.44 dB</td> <td></td> <td></td> </tr> </tbody> </table>	Type	Ref	Trc	X-value	Y-value	Function	Function Result	M1		1	2.45318 GHz	-12.81 dBm			M2		1	2.46698 GHz	-6.49 dBm			D3	M1	1	17.64 MHz	-0.44 dB		
Type	Ref	Trc	X-value	Y-value	Function	Function Result																							
M1		1	2.45318 GHz	-12.81 dBm																									
M2		1	2.46698 GHz	-6.49 dBm																									
D3	M1	1	17.64 MHz	-0.44 dB																									

**5.6. Restricted band**

**LIMIT**

**FCC CFR Title 47 Part 15 Subpart C Section 15.247 (d):**

In any 100 kHz bandwidth outside the frequency band in which the spread spectrum or digitally modulated intentional radiator is operating, Radiated Emissions which fall in the restricted bands, as defined in §15.205(a), must also comply with the Radiated Emissions limits specified in §15.209(a) (see §15.205(c)).

**TEST CONFIGURATION**

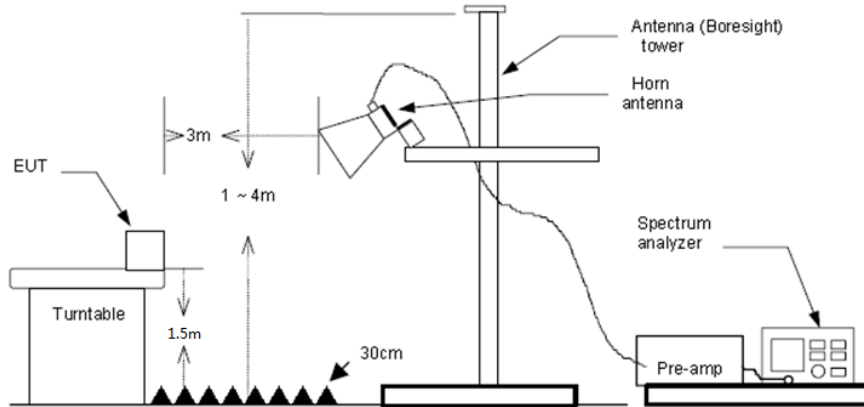

**TEST PROCEDURE**

- 1) The EUT was setup and tested according to ANSI C63.10:2013 for compliance to FCC 47CFR 15.247 requirements.
- 2) The EUT is placed on a turn table which is 1.5 meter above ground. The turn table is rotated 360 degrees to determine the position of the maximum emission level.
- 3) The EUT was positioned such that the distance from antenna to the EUT was 3 meters.
- 4) The antenna is scanned from 1 meter to 4 meters to find out the maximum emission level. This is repeated for both horizontal and vertical polarization of the antenna. In order to find the maximum emission, all of the interface cables were manipulated according to ANSI C63.10:2013 on radiated measurement.
- 5) The receiver set as follow:  
 RBW=1MHz, VBW=3MHz PEAK detector for Peak value.  
 RBW=1MHz, VBW=3MHz RMS detector for Average value.

**TEST MODE:**

Please refer to the clause 3.3

**TEST RESULTS**

Passed       Not Applicable

Note:

- 1) Final level= Read level + Antenna Factor+ Cable Loss- Preamp Factor



802.11b					CH01				
Frequency (MHz)	Read Level (dBuV)	Antenna Factor (dB/m)	Cable Loss (dB)	Preamp Factor (dB)	Level (dBuV/m)	Limit Line (dBuV/m)	Over Limit (dB)	Polarization	Test value
2310.00	14.13	28.05	6.62	0.00	48.80	74.00	-25.20	Vertical	Peak
2390.01	13.52	27.65	6.75	0.00	47.92	74.00	-26.08	Vertical	Peak
2310.00	14.04	28.05	6.62	0.00	48.71	74.00	-25.29	Horizontal	Peak
2390.01	13.95	27.65	6.75	0.00	48.35	74.00	-25.65	Horizontal	Peak

802.11b					CH11				
Frequency (MHz)	Read Level (dBuV)	Antenna Factor (dB/m)	Cable Loss (dB)	Preamp Factor (dB)	Level (dBuV/m)	Limit Line (dBuV/m)	Over Limit (dB)	Polarization	Test value
2483.49	16.51	27.26	6.83	0.00	50.60	74.00	-23.40	Vertical	Peak
2500.00	13.75	27.20	6.84	0.00	47.79	74.00	-26.21	Vertical	Peak
2483.49	17.70	27.26	6.83	0.00	51.79	74.00	-22.21	Horizontal	Peak
2500.00	13.62	27.20	6.84	0.00	47.66	74.00	-26.34	Horizontal	Peak

802.11g					CH01				
Frequency (MHz)	Read Level (dBuV)	Antenna Factor (dB/m)	Cable Loss (dB)	Preamp Factor (dB)	Level (dBuV/m)	Limit Line (dBuV/m)	Over Limit (dB)	Polarization	Test value
2310.00	13.92	28.05	6.62	0.00	48.59	74.00	-25.41	Vertical	Peak
2390.12	16.63	27.65	6.75	0.00	51.03	74.00	-22.97	Vertical	Peak
2310.00	14.40	28.05	6.62	0.00	49.07	74.00	-24.93	Horizontal	Peak
2390.12	21.03	27.65	6.75	0.00	55.43	74.00	-18.57	Horizontal	Peak
2310.00	10.76	28.05	6.62	0.00	45.43	54.00	-8.57	Vertical	Average
2390.01	12.13	27.65	6.75	0.00	46.53	54.00	-7.47	Vertical	Average
2310.00	10.78	28.05	6.62	0.00	45.45	54.00	-8.55	Horizontal	Average
2390.01	16.24	27.65	6.75	0.00	50.64	54.00	-3.36	Horizontal	Average

802.11g					CH11				
Frequency (MHz)	Read Level (dBuV)	Antenna Factor (dB/m)	Cable Loss (dB)	Preamp Factor (dB)	Level (dBuV/m)	Limit Line (dBuV/m)	Over Limit (dB)	Polarization	Test value
2483.49	20.37	27.26	6.83	0.00	54.46	74.00	-19.54	Vertical	Peak
2500.00	15.34	27.20	6.84	0.00	49.38	74.00	-24.62	Vertical	Peak
2483.62	25.33	27.26	6.83	0.00	59.42	74.00	-14.58	Horizontal	Peak
2500.00	14.47	27.20	6.84	0.00	48.51	74.00	-25.49	Horizontal	Peak
2483.49	16.28	27.26	6.83	0.00	50.37	54.00	-3.63	Vertical	Average
2500.00	8.76	27.20	6.84	0.00	42.80	54.00	-11.20	Vertical	Average
2483.49	15.98	27.26	6.83	0.00	50.07	54.00	-3.93	Horizontal	Average
2500.00	7.02	27.20	6.84	0.00	41.06	54.00	-12.94	Horizontal	Average

802.11n(HT20)					CH01				
Frequency (MHz)	Read Level (dBuV)	Antenna Factor (dB/m)	Cable Loss (dB)	Preamp Factor (dB)	Level (dBuV/m)	Limit Line (dBuV/m)	Over Limit (dB)	Polarization	Test value
2310.00	13.14	28.05	6.62	0.00	47.81	74.00	-26.19	Vertical	Peak
2390.12	18.39	27.65	6.75	0.00	52.79	74.00	-21.21	Vertical	Peak
2310.00	14.79	28.05	6.62	0.00	49.46	74.00	-24.54	Horizontal	Peak
2390.01	20.15	27.65	6.75	0.00	54.55	74.00	-19.45	Horizontal	Peak
2310.00	10.76	28.05	6.62	0.00	45.43	54.00	-8.57	Vertical	Average
2390.12	13.67	27.65	6.75	0.00	48.07	54.00	-5.93	Vertical	Average
2310.00	9.80	28.05	6.62	0.00	44.47	54.00	-9.53	Horizontal	Average
2390.01	15.56	27.65	6.75	0.00	49.96	54.00	-4.04	Horizontal	Average

802.11n(HT20)					CH11				
Frequency (MHz)	Read Level (dBuV)	Antenna Factor (dB/m)	Cable Loss (dB)	Preamp Factor (dB)	Level (dBuV/m)	Limit Line (dBuV/m)	Over Limit (dB)	Polarization	Test value
2483.49	24.70	27.26	6.83	0.00	58.79	74.00	-15.21	Vertical	Peak
2500.00	18.35	27.20	6.84	0.00	52.39	74.00	-21.61	Vertical	Peak
2483.49	26.10	27.26	6.83	0.00	60.19	74.00	-13.81	Horizontal	Peak
2500.00	16.41	27.20	6.84	0.00	50.45	74.00	-23.55	Horizontal	Peak
2483.49	16.12	27.26	6.83	0.00	50.21	54.00	-3.79	Vertical	Average
2500.00	10.13	27.20	6.84	0.00	44.17	54.00	-9.83	Vertical	Average
2483.49	12.34	27.26	6.83	0.00	46.43	54.00	-7.57	Horizontal	Average
2500.00	7.60	27.20	6.84	0.00	41.64	54.00	-12.36	Horizontal	Average

## 5.7. Band edge and Spurious Emissions (conducted)

### LIMIT

#### **FCC CFR Title 47 Part 15 Subpart C Section 15.247 (d):**

In any 100 kHz bandwidth outside the frequency band in which the spread spectrum intentional radiator is operating, the radio frequency power that is produced by the intentional radiator shall be at least 20 dB below that in the 100 kHz bandwidth within the band that contains the highest level of the desired power, based on either an RF conducted or a radiated measurement.

### TEST CONFIGURATION

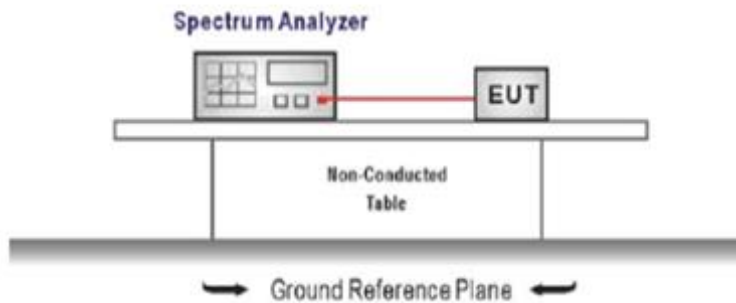

### TEST PROCEDURE

1. Connect the antenna port(s) to the spectrum analyzer input.
2. Establish a reference level by using the following procedure  
Center frequency=DTS channel center frequency  
The span = 1.5 times the DTS bandwidth.  
RBW = 100 kHz, VBW  $\geq$  3 x RBW  
Detector = peak, Sweep time = auto couple, Trace mode = max hold  
Allow trace to fully stabilize  
Use the peak marker function to determine the maximum PSD level  
  
Note: the channel found to contain the maximum PSD level can be used to establish the reference level.
3. Emission level measurement  
Set the center frequency and span to encompass frequency range to be measured  
RBW = 100 kHz, VBW  $\geq$  3 x RBW  
Detector = peak, Sweep time = auto couple, Trace mode = max hold  
Allow trace to fully stabilize  
Use the peak marker function to determine the maximum amplitude level.
4. Place the radio in continuous transmit mode, allow the trace to stabilize, view the transmitter waveform on the spectrum analyzer.
5. Ensure that the amplitude of all unwanted emission outside of the authorized frequency band excluding restricted frequency bands) are attenuated by at least the minimum requirements specified (at least 20 dB relative to the maximum in-band peak PSD level in 100 kHz). Report the three highest emission relative to the limit.

### TEST MODE:

Please refer to the clause 3.3

### TEST RESULTS

Passed       Not Applicable

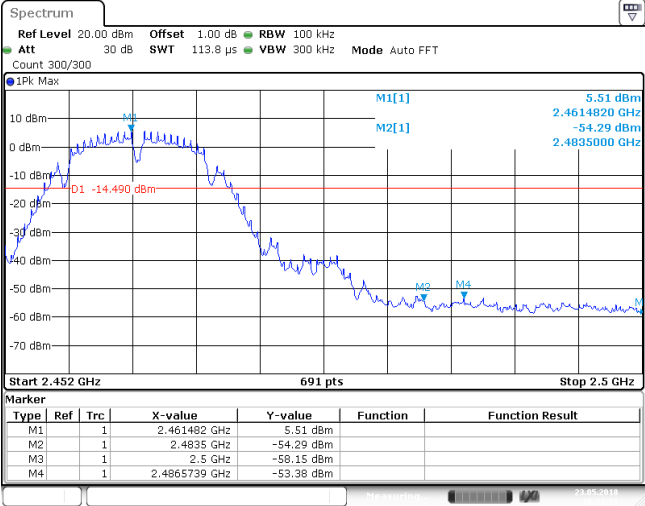
Test Item:	Bandedge	Type:	802.11 b																																										
CH01	 <p>                     Spectrum                      Ref Level 20.00 dBm Offset 1.00 dB RBW 100 kHz                      Att 30 dB SWT 246.5 <math>\mu</math>s VBW 300 kHz Mode Auto FFT                      Count 300/300                      1Pk Max                      Start 2.31 GHz 691 pts Stop 2.422 GHz                      Marker  <table border="1"> <thead> <tr> <th>Type</th> <th>Ref</th> <th>Trc</th> <th>X-value</th> <th>Y-value</th> <th>Function</th> <th>Function Result</th> </tr> </thead> <tbody> <tr> <td>M1</td> <td>1</td> <td></td> <td>2.41106 GHz</td> <td>6.23 dBm</td> <td></td> <td></td> </tr> <tr> <td>M2</td> <td>1</td> <td></td> <td>2.4 GHz</td> <td>-43.50 dBm</td> <td></td> <td></td> </tr> <tr> <td>M3</td> <td>1</td> <td></td> <td>2.39 GHz</td> <td>-51.49 dBm</td> <td></td> <td></td> </tr> <tr> <td>M4</td> <td>1</td> <td></td> <td>2.31 GHz</td> <td>-59.35 dBm</td> <td></td> <td></td> </tr> <tr> <td>M5</td> <td>1</td> <td></td> <td>2.39703 GHz</td> <td>-33.88 dBm</td> <td></td> <td></td> </tr> </tbody> </table> </p>			Type	Ref	Trc	X-value	Y-value	Function	Function Result	M1	1		2.41106 GHz	6.23 dBm			M2	1		2.4 GHz	-43.50 dBm			M3	1		2.39 GHz	-51.49 dBm			M4	1		2.31 GHz	-59.35 dBm			M5	1		2.39703 GHz	-33.88 dBm		
Type	Ref	Trc	X-value	Y-value	Function	Function Result																																							
M1	1		2.41106 GHz	6.23 dBm																																									
M2	1		2.4 GHz	-43.50 dBm																																									
M3	1		2.39 GHz	-51.49 dBm																																									
M4	1		2.31 GHz	-59.35 dBm																																									
M5	1		2.39703 GHz	-33.88 dBm																																									
CH11	 <p>                     Spectrum                      Ref Level 20.00 dBm Offset 1.00 dB RBW 100 kHz                      Att 30 dB SWT 113.8 <math>\mu</math>s VBW 300 kHz Mode Auto FFT                      Count 300/300                      1Pk Max                      Start 2.452 GHz 691 pts Stop 2.5 GHz                      Marker  <table border="1"> <thead> <tr> <th>Type</th> <th>Ref</th> <th>Trc</th> <th>X-value</th> <th>Y-value</th> <th>Function</th> <th>Function Result</th> </tr> </thead> <tbody> <tr> <td>M1</td> <td>1</td> <td></td> <td>2.461482 GHz</td> <td>5.51 dBm</td> <td></td> <td></td> </tr> <tr> <td>M2</td> <td>1</td> <td></td> <td>2.4835 GHz</td> <td>-54.29 dBm</td> <td></td> <td></td> </tr> <tr> <td>M3</td> <td>1</td> <td></td> <td>2.5 GHz</td> <td>-58.15 dBm</td> <td></td> <td></td> </tr> <tr> <td>M4</td> <td>1</td> <td></td> <td>2.4865739 GHz</td> <td>-53.38 dBm</td> <td></td> <td></td> </tr> </tbody> </table> </p>			Type	Ref	Trc	X-value	Y-value	Function	Function Result	M1	1		2.461482 GHz	5.51 dBm			M2	1		2.4835 GHz	-54.29 dBm			M3	1		2.5 GHz	-58.15 dBm			M4	1		2.4865739 GHz	-53.38 dBm									
Type	Ref	Trc	X-value	Y-value	Function	Function Result																																							
M1	1		2.461482 GHz	5.51 dBm																																									
M2	1		2.4835 GHz	-54.29 dBm																																									
M3	1		2.5 GHz	-58.15 dBm																																									
M4	1		2.4865739 GHz	-53.38 dBm																																									

Test Item:	Bandedge	Type:	802.11 g																																										
CH01	<p>Spectrum</p> <p>Ref Level 20.00 dBm Offset 1.00 dB RBW 100 kHz          Att 30 dB SWT 246.5 μs VBW 300 kHz Mode Auto FFT          Count 300/300</p> <p>1Pk Max</p> <p>M1[1] -4.22 dBm          2.407010 GHz          M2[1] -46.53 dBm          2.400000 GHz</p> <p>D1 -24.220 dBm</p> <p>Start 2.31 GHz 691 pts Stop 2.422 GHz</p> <p>Marker</p> <table border="1"> <thead> <tr> <th>Type</th> <th>Ref</th> <th>Trc</th> <th>X-value</th> <th>Y-value</th> <th>Function</th> <th>Function Result</th> </tr> </thead> <tbody> <tr> <td>M1</td> <td>1</td> <td></td> <td>2.40701 GHz</td> <td>-4.22 dBm</td> <td></td> <td></td> </tr> <tr> <td>M2</td> <td>1</td> <td></td> <td>2.4 GHz</td> <td>-46.53 dBm</td> <td></td> <td></td> </tr> <tr> <td>M3</td> <td>1</td> <td></td> <td>2.39 GHz</td> <td>-54.25 dBm</td> <td></td> <td></td> </tr> <tr> <td>M4</td> <td>1</td> <td></td> <td>2.31 GHz</td> <td>-58.57 dBm</td> <td></td> <td></td> </tr> <tr> <td>M5</td> <td>1</td> <td></td> <td>2.399762 GHz</td> <td>-45.52 dBm</td> <td></td> <td></td> </tr> </tbody> </table>			Type	Ref	Trc	X-value	Y-value	Function	Function Result	M1	1		2.40701 GHz	-4.22 dBm			M2	1		2.4 GHz	-46.53 dBm			M3	1		2.39 GHz	-54.25 dBm			M4	1		2.31 GHz	-58.57 dBm			M5	1		2.399762 GHz	-45.52 dBm		
Type	Ref	Trc	X-value	Y-value	Function	Function Result																																							
M1	1		2.40701 GHz	-4.22 dBm																																									
M2	1		2.4 GHz	-46.53 dBm																																									
M3	1		2.39 GHz	-54.25 dBm																																									
M4	1		2.31 GHz	-58.57 dBm																																									
M5	1		2.399762 GHz	-45.52 dBm																																									
CH11	<p>Spectrum</p> <p>Ref Level 20.00 dBm Offset 1.00 dB RBW 100 kHz          Att 30 dB SWT 113.8 μs VBW 300 kHz Mode Auto FFT          Count 300/300</p> <p>1Pk Max</p> <p>M1[1] -4.74 dBm          2.4669700 GHz          M2[1] -56.13 dBm          2.4835000 GHz</p> <p>D1 -24.740 dBm</p> <p>Start 2.452 GHz 691 pts Stop 2.5 GHz</p> <p>Marker</p> <table border="1"> <thead> <tr> <th>Type</th> <th>Ref</th> <th>Trc</th> <th>X-value</th> <th>Y-value</th> <th>Function</th> <th>Function Result</th> </tr> </thead> <tbody> <tr> <td>M1</td> <td>1</td> <td></td> <td>2.46697 GHz</td> <td>-4.74 dBm</td> <td></td> <td></td> </tr> <tr> <td>M2</td> <td>1</td> <td></td> <td>2.4835 GHz</td> <td>-56.13 dBm</td> <td></td> <td></td> </tr> <tr> <td>M3</td> <td>1</td> <td></td> <td>2.5 GHz</td> <td>-57.36 dBm</td> <td></td> <td></td> </tr> <tr> <td>M4</td> <td>1</td> <td></td> <td>2.484487 GHz</td> <td>-51.73 dBm</td> <td></td> <td></td> </tr> </tbody> </table>			Type	Ref	Trc	X-value	Y-value	Function	Function Result	M1	1		2.46697 GHz	-4.74 dBm			M2	1		2.4835 GHz	-56.13 dBm			M3	1		2.5 GHz	-57.36 dBm			M4	1		2.484487 GHz	-51.73 dBm									
Type	Ref	Trc	X-value	Y-value	Function	Function Result																																							
M1	1		2.46697 GHz	-4.74 dBm																																									
M2	1		2.4835 GHz	-56.13 dBm																																									
M3	1		2.5 GHz	-57.36 dBm																																									
M4	1		2.484487 GHz	-51.73 dBm																																									

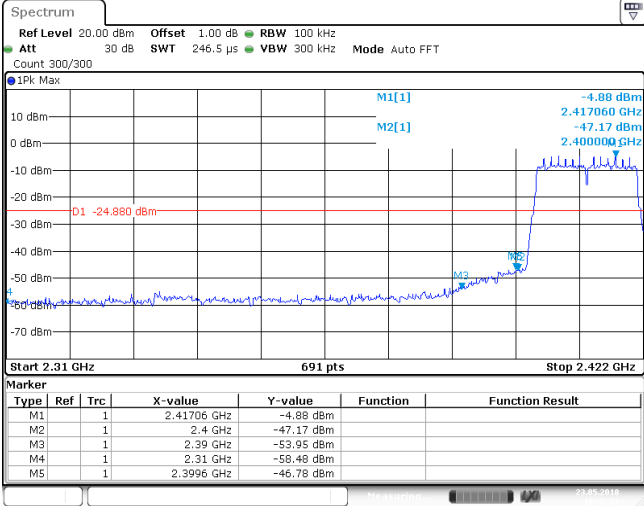
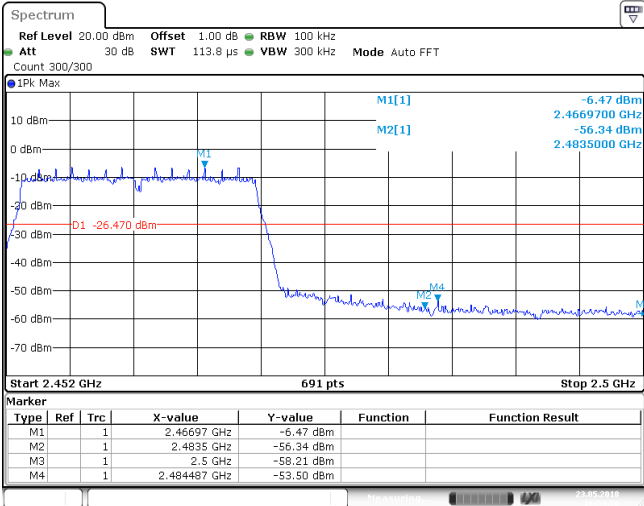
Test Item:	Bandedge	Type:	802.11 n(HT20)																																										
CH01	 <p><b>Spectrum</b>            Ref Level 20.00 dBm Offset 1.00 dB RBW 100 kHz            Att 30 dB SWT 246.5 μs VBW 300 kHz Mode Auto FFT            Count 300/300</p> <p>1Pk Max</p> <p>M1[1] -4.88 dBm 2.417060 GHz            M2[1] -47.17 dBm 2.400000 GHz</p> <p>D1 -24.880 dBm</p> <p>Start 2.31 GHz 691 pts Stop 2.422 GHz</p> <p><b>Marker</b></p> <table border="1"> <thead> <tr> <th>Type</th> <th>Ref</th> <th>Trc</th> <th>X-value</th> <th>Y-value</th> <th>Function</th> <th>Function Result</th> </tr> </thead> <tbody> <tr> <td>M1</td> <td>1</td> <td></td> <td>2.41706 GHz</td> <td>-4.88 dBm</td> <td></td> <td></td> </tr> <tr> <td>M2</td> <td>1</td> <td></td> <td>2.4 GHz</td> <td>-47.17 dBm</td> <td></td> <td></td> </tr> <tr> <td>M3</td> <td>1</td> <td></td> <td>2.39 GHz</td> <td>-53.95 dBm</td> <td></td> <td></td> </tr> <tr> <td>M4</td> <td>1</td> <td></td> <td>2.31 GHz</td> <td>-58.48 dBm</td> <td></td> <td></td> </tr> <tr> <td>M5</td> <td>1</td> <td></td> <td>2.3996 GHz</td> <td>-46.78 dBm</td> <td></td> <td></td> </tr> </tbody> </table>			Type	Ref	Trc	X-value	Y-value	Function	Function Result	M1	1		2.41706 GHz	-4.88 dBm			M2	1		2.4 GHz	-47.17 dBm			M3	1		2.39 GHz	-53.95 dBm			M4	1		2.31 GHz	-58.48 dBm			M5	1		2.3996 GHz	-46.78 dBm		
Type	Ref	Trc	X-value	Y-value	Function	Function Result																																							
M1	1		2.41706 GHz	-4.88 dBm																																									
M2	1		2.4 GHz	-47.17 dBm																																									
M3	1		2.39 GHz	-53.95 dBm																																									
M4	1		2.31 GHz	-58.48 dBm																																									
M5	1		2.3996 GHz	-46.78 dBm																																									
CH11	 <p><b>Spectrum</b>            Ref Level 20.00 dBm Offset 1.00 dB RBW 100 kHz            Att 30 dB SWT 113.8 μs VBW 300 kHz Mode Auto FFT            Count 300/300</p> <p>1Pk Max</p> <p>M1[1] -6.47 dBm 2.4669700 GHz            M2[1] -56.34 dBm 2.4835000 GHz</p> <p>D1 -26.470 dBm</p> <p>Start 2.452 GHz 691 pts Stop 2.5 GHz</p> <p><b>Marker</b></p> <table border="1"> <thead> <tr> <th>Type</th> <th>Ref</th> <th>Trc</th> <th>X-value</th> <th>Y-value</th> <th>Function</th> <th>Function Result</th> </tr> </thead> <tbody> <tr> <td>M1</td> <td>1</td> <td></td> <td>2.46697 GHz</td> <td>-6.47 dBm</td> <td></td> <td></td> </tr> <tr> <td>M2</td> <td>1</td> <td></td> <td>2.4835 GHz</td> <td>-56.34 dBm</td> <td></td> <td></td> </tr> <tr> <td>M3</td> <td>1</td> <td></td> <td>2.5 GHz</td> <td>-58.21 dBm</td> <td></td> <td></td> </tr> <tr> <td>M4</td> <td>1</td> <td></td> <td>2.484487 GHz</td> <td>-53.50 dBm</td> <td></td> <td></td> </tr> </tbody> </table>			Type	Ref	Trc	X-value	Y-value	Function	Function Result	M1	1		2.46697 GHz	-6.47 dBm			M2	1		2.4835 GHz	-56.34 dBm			M3	1		2.5 GHz	-58.21 dBm			M4	1		2.484487 GHz	-53.50 dBm									
Type	Ref	Trc	X-value	Y-value	Function	Function Result																																							
M1	1		2.46697 GHz	-6.47 dBm																																									
M2	1		2.4835 GHz	-56.34 dBm																																									
M3	1		2.5 GHz	-58.21 dBm																																									
M4	1		2.484487 GHz	-53.50 dBm																																									

Test Item:	SE	Type:	802.11 b
<p>CH01 Reference level</p>			
<p>CH01 30MHz~1000MHz</p>			
<p>CH01 1GHz~26GHz</p>			



CH06  
Reference level

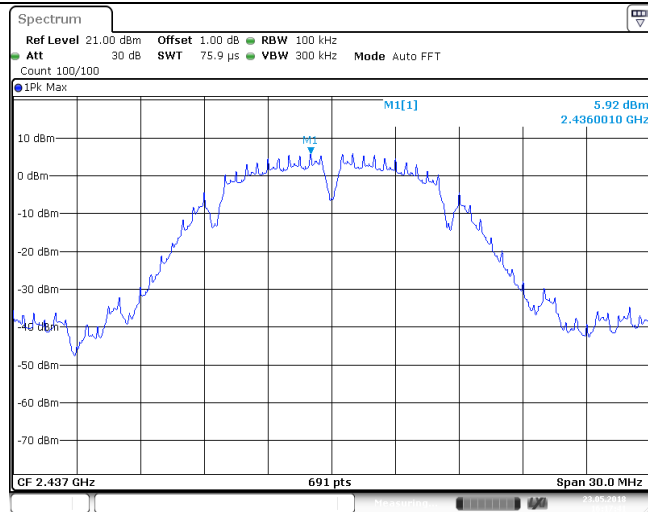

CH06  
30MHz~1000MHz

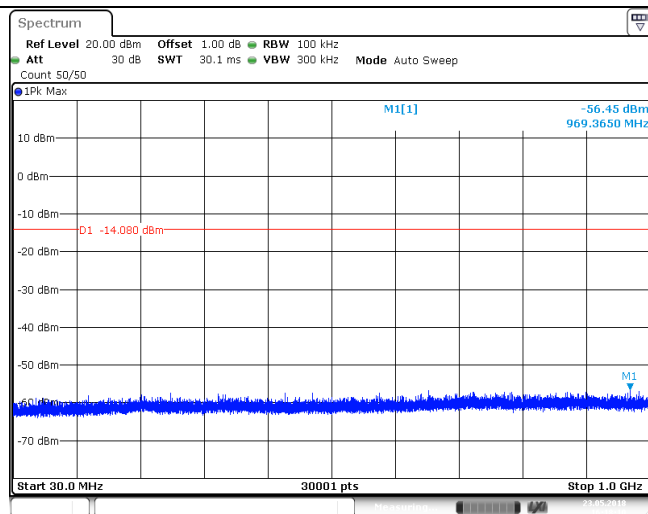

CH06  
1GHz~26GHz

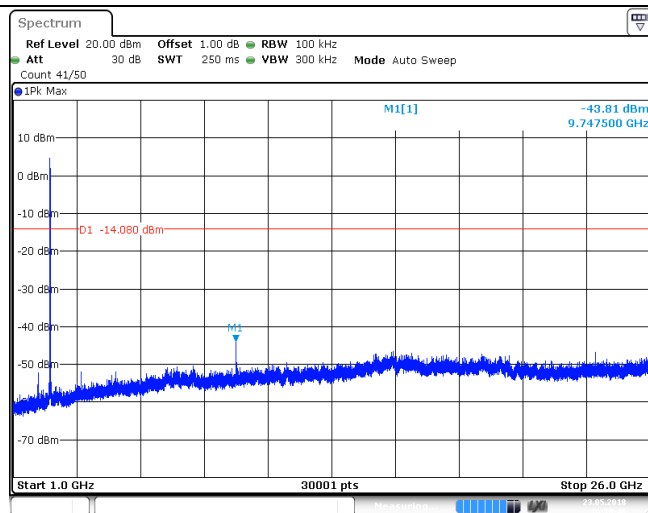

CH11  
Reference level

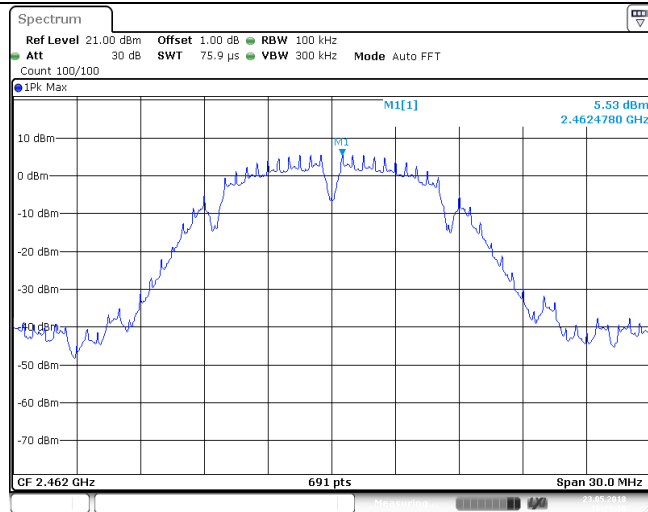

CH11  
30MHz~1000MHz

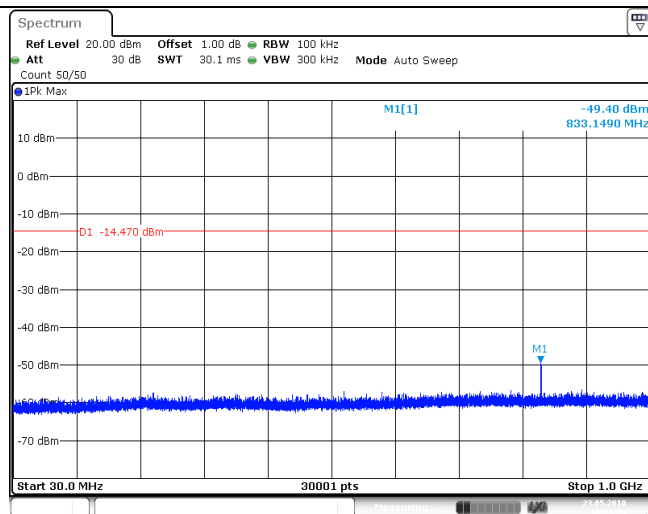

CH11  
1GHz~26GHz

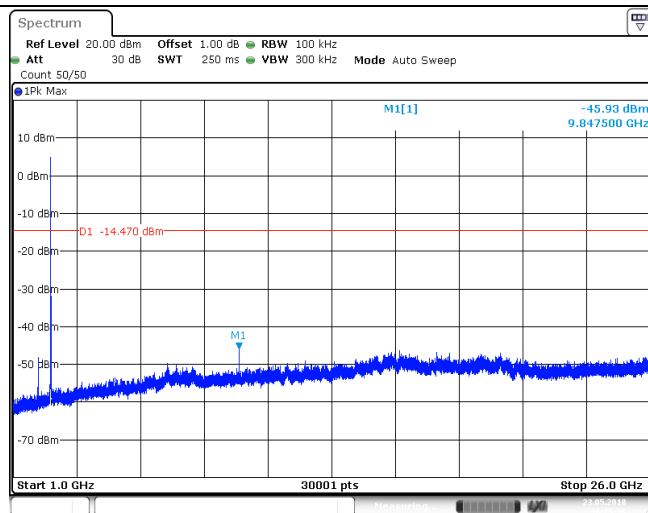

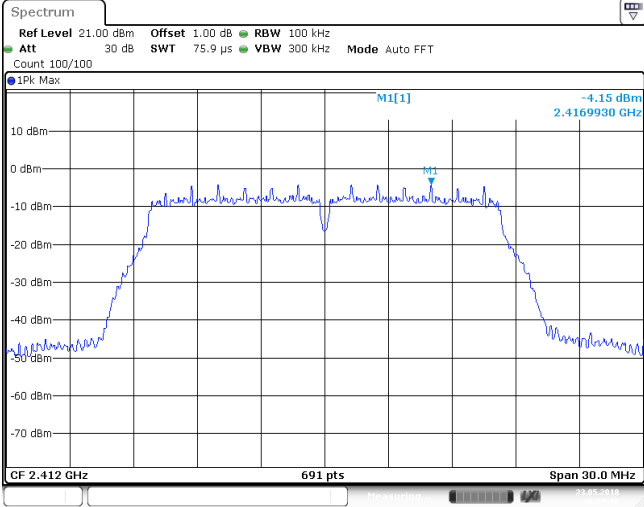
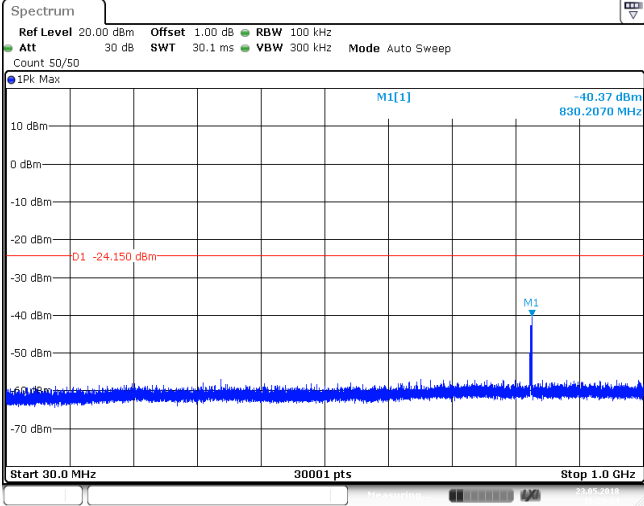
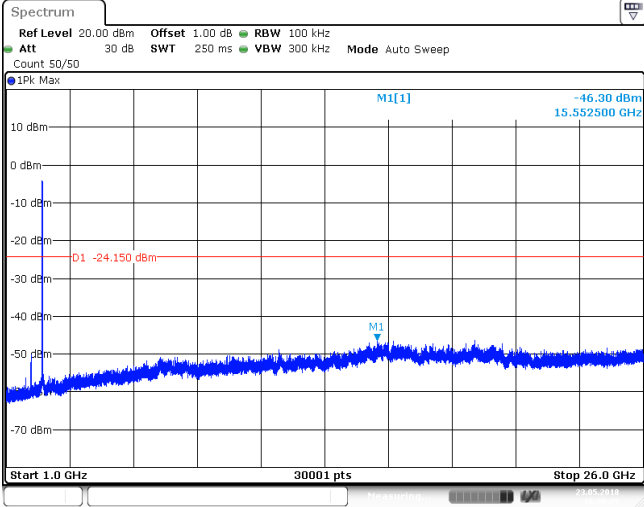
Test Item:	SE	Type:	802.11 g
CH01 Reference level			
CH01 30MHz~1000MHz			
CH01 1GHz~26GHz			

CH06  
Reference level

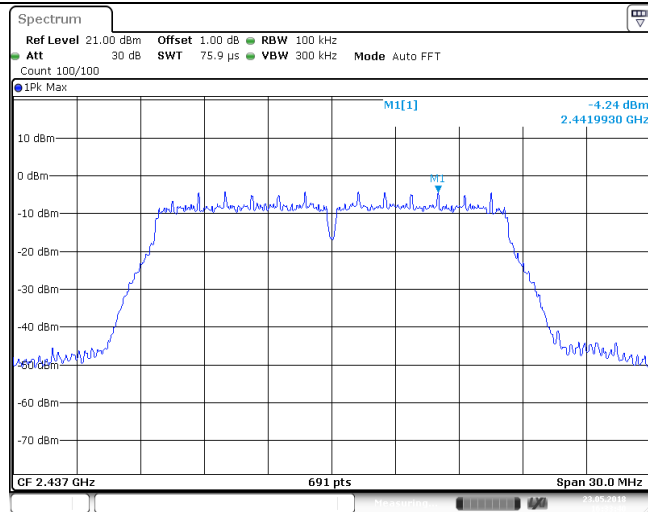

CH06  
30MHz~1000MHz

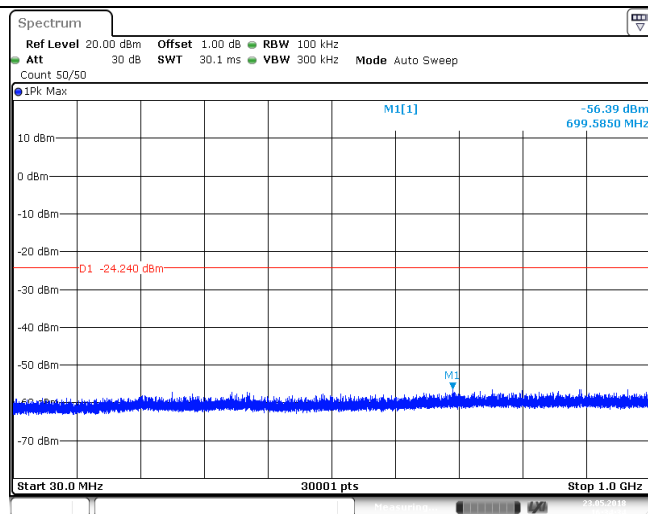

CH06  
1GHz~26GHz

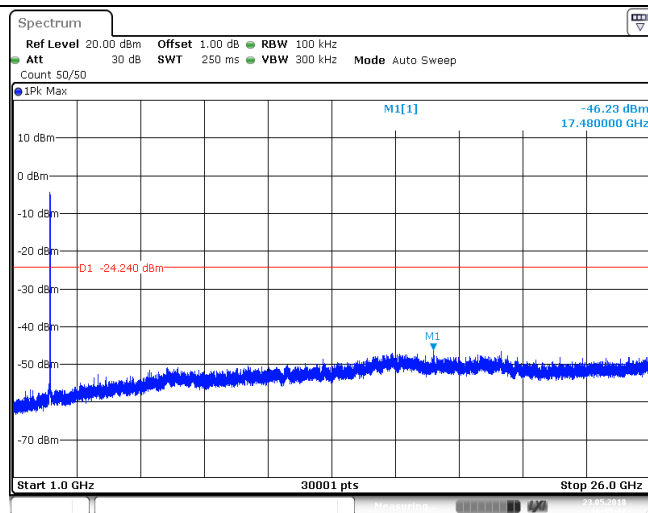

CH11  
Reference level

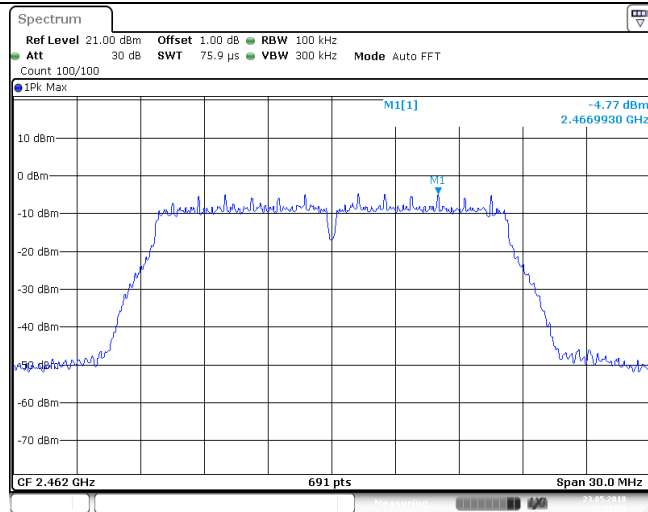

CH11  
30MHz~1000MHz

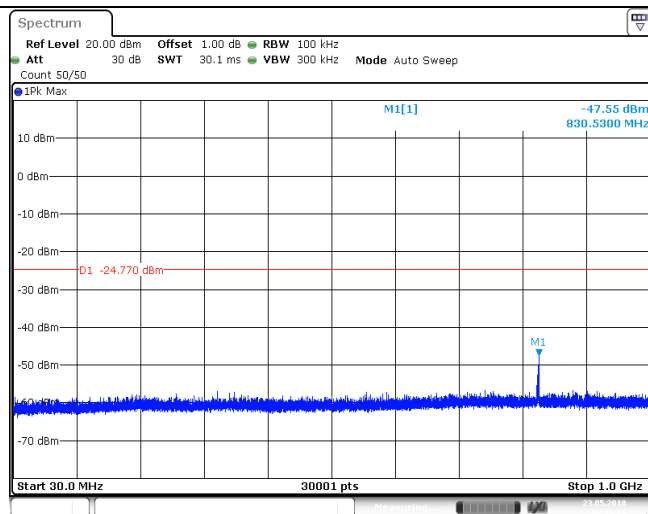

CH11  
1GHz~26GHz

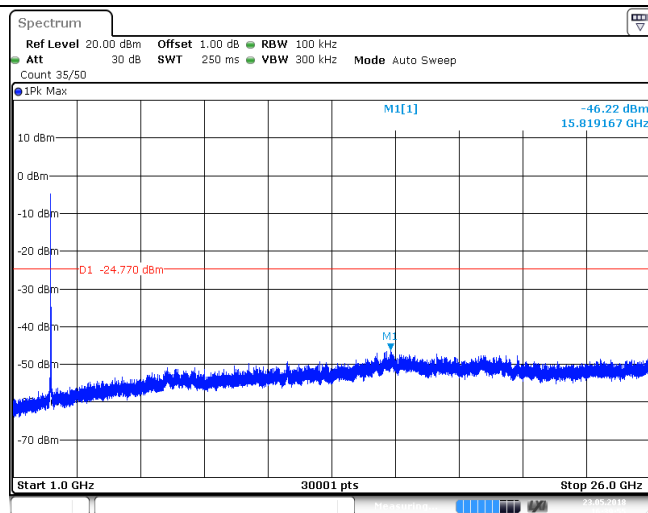

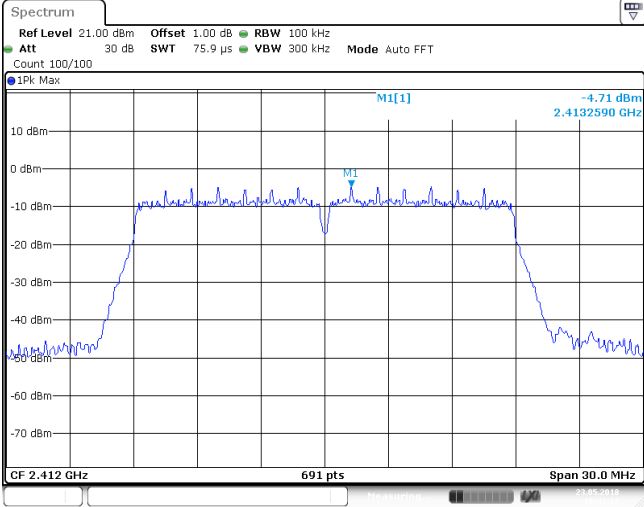
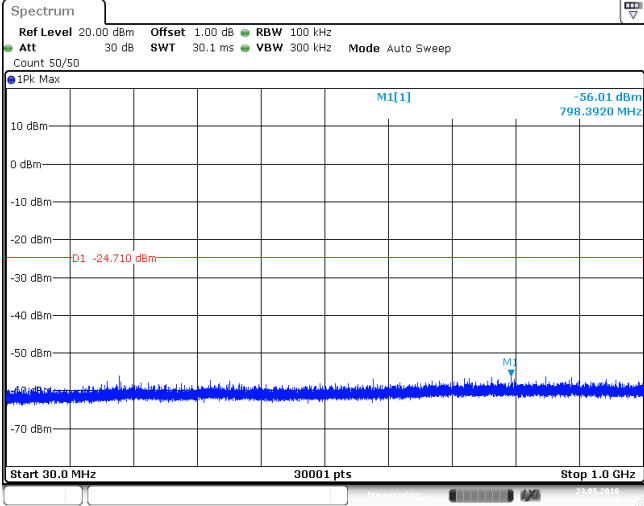
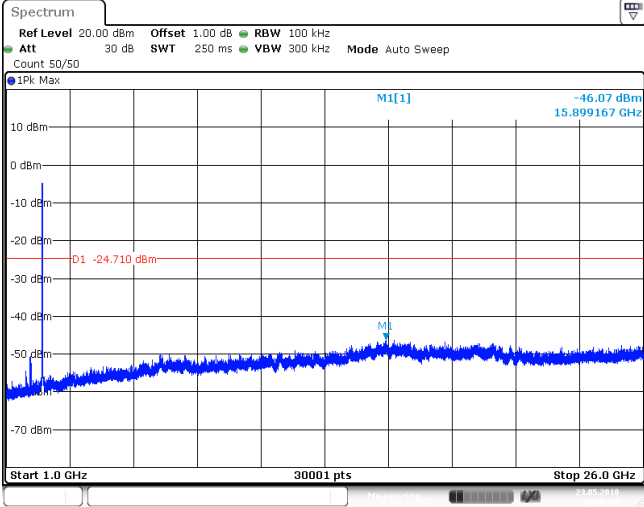
Test Item:	SE	Type:	802.11 n(HT20)
CH01 Reference level			
CH01 30MHz~1000MHz			
CH01 1GHz~26GHz			

CH06  
Reference level

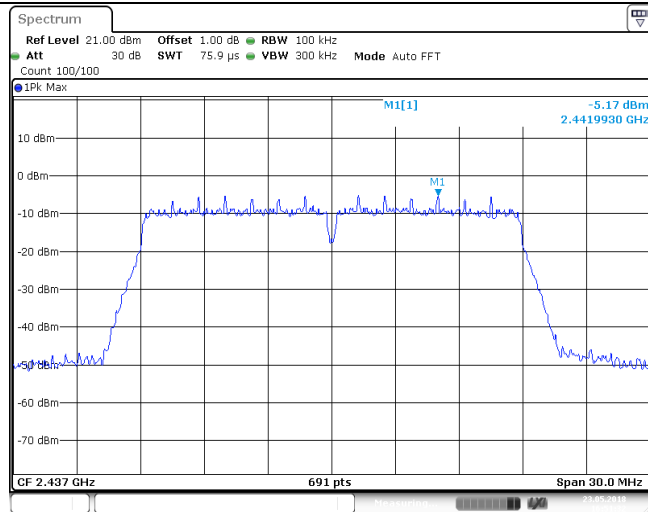

CH06  
30MHz~1000MHz

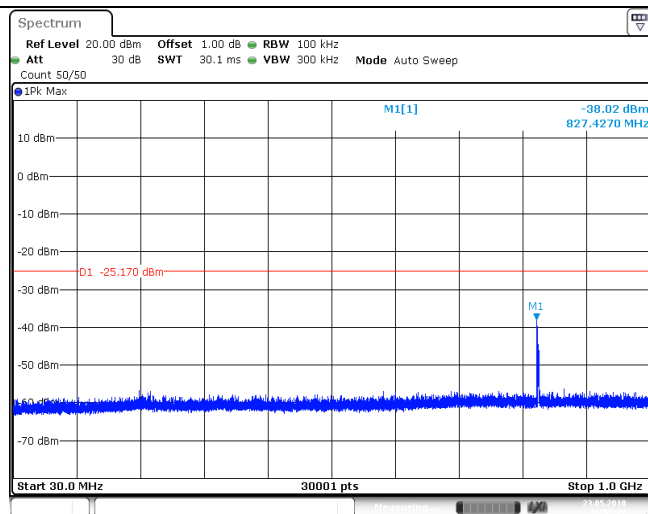

CH06  
1GHz~26GHz

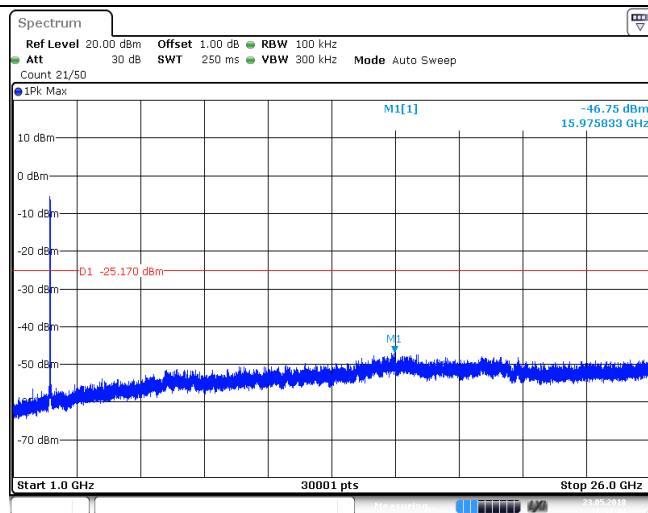

CH11  
Reference level

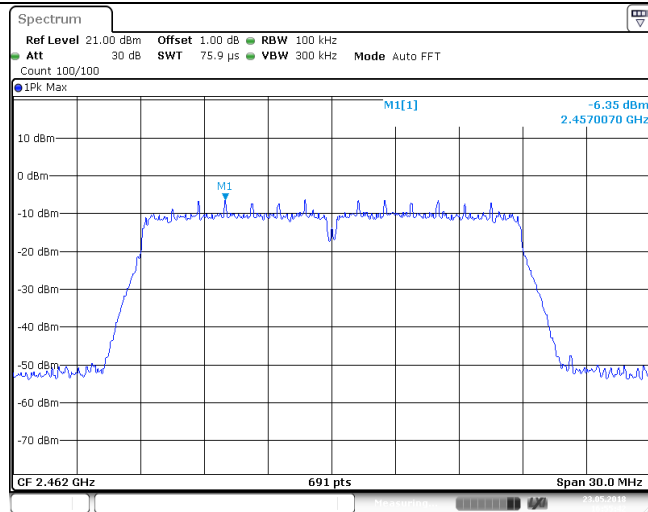

CH11  
30MHz~1000MHz

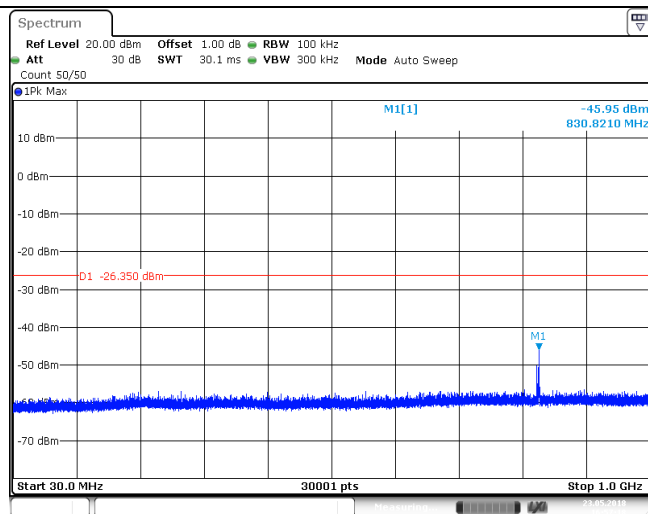

CH11  
1GHz~26GHz

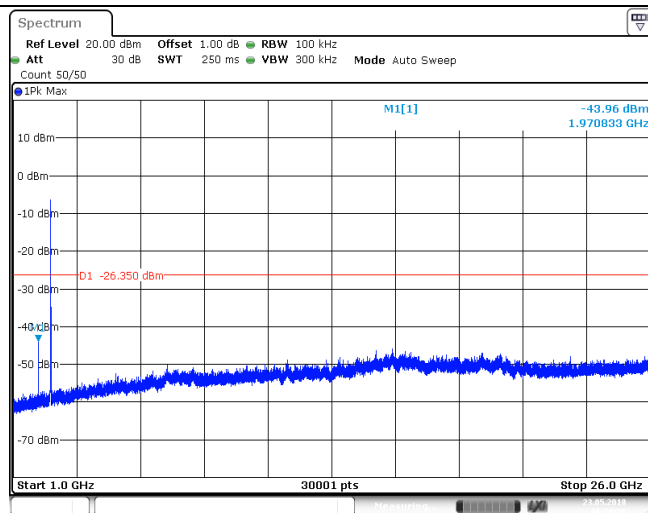



### 5.8. Spurious Emissions (radiated)

#### LIMIT

#### FCC CFR Title 47 Part 15 Subpart C Section 15.209

Frequency	Limit (dBuV/m @3m)	Value
30MHz-88MHz	40.00	Quasi-peak
88MHz-216MHz	43.50	Quasi-peak
216MHz-960MHz	46.00	Quasi-peak
960MHz-1GHz	54.00	Quasi-peak
Above 1GHz	54.00	Average
	74.00	Peak

#### TEST CONFIGURATION

➤ 9kHz ~30MHz

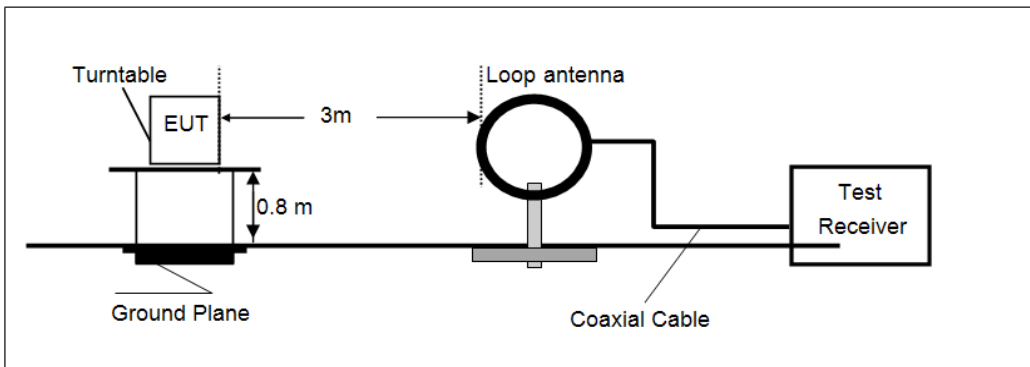

➤ 30MHz ~ 1GHz

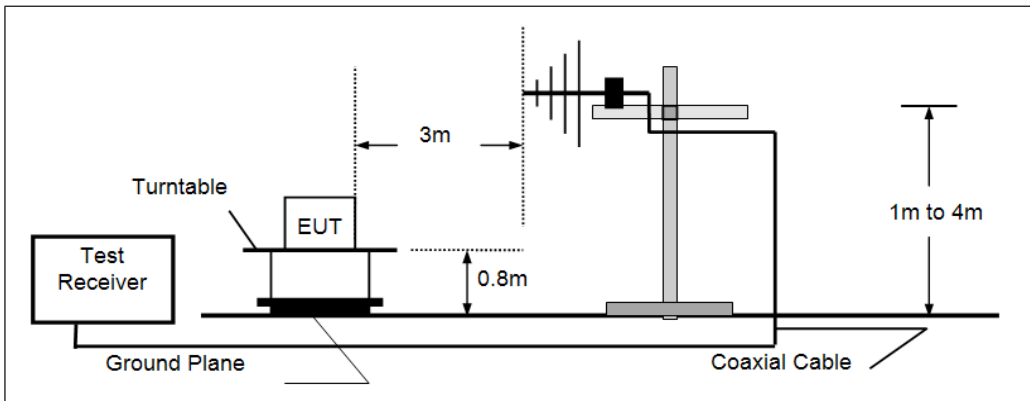

➤ Above 1GHz

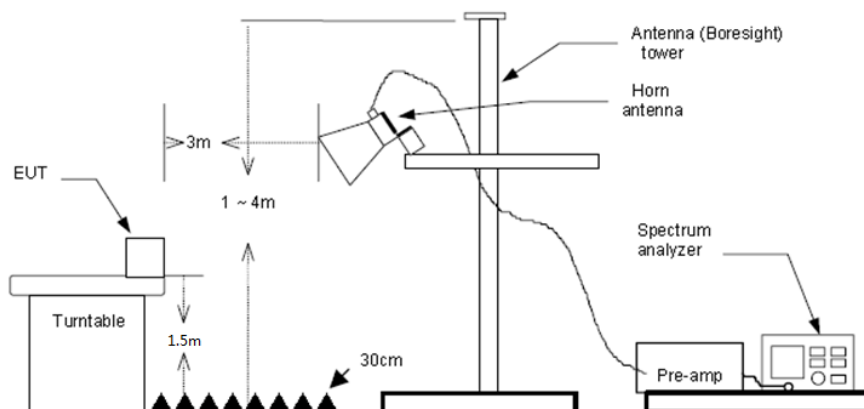

## **TEST PROCEDURE**

1. The EUT was setup and tested according to ANSI C63.10:2013 for compliance to FCC 47CFR 15.247 requirements.
2. The EUT is placed on a turn table which is 0.8 meter above ground for below 1 GHz, and 1.5 m for above 1 GHz. The turn table is rotated 360 degrees to determine the position of the maximum emission level.
3. The EUT was set 3 meters from the receiving antenna, which was mounted on the top of a variable height antenna tower.
4. For each suspected emission, the EUT was arranged to its worst case and then tune the Antenna tower (from 1 m to 4 m) and turntable (from 0 degree to 360 degrees) to find the maximum reading. A pre-amp and a high pass filter are used for the test in order to get better signal level to comply with the guidelines.
5. Set to the maximum power setting and enable the EUT transmit continuously.
6. Use the following spectrum analyzer settings
  - (1) Span shall wide enough to fully capture the emission being measured;
  - (2) Below 1 GHz:  
RBW=120 kHz, VBW=300 kHz, Sweep=auto, Detector function=peak, Trace=max hold;  
If the emission level of the EUT measured by the peak detector is 3 dB lower than the applicable limit, the peak emission level will be reported. Otherwise, the emission measurement will be repeated using the quasi-peak detector and reported.
  - (3) From 1 GHz to 10<sup>th</sup> harmonic:  
RBW=1MHz, VBW=3MHz Peak detector for Peak value.  
RBW=1MHz, VBW=3MHz RMS detector for Average value.

## **TEST MODE:**

Please refer to the clause 3.3

## **TEST RESULTS**

**Passed**       **Not Applicable**

Note:

- 1) Final Level =Receiver Read level + Antenna Factor + Cable Loss – Preamplifier Factor
- 2) The emission levels of other frequencies are very lower than the limit and not show in test report.

### ➤ **9kHz ~ 30MHz**

The EUT was pre-scanned the frequency band (9kHz~30MHz), found the radiated level lower than the limit, so don't show on the report.

### ➤ **30MHz ~1000MHz**

Have pre-scan all modulation mode, found the 802.11b mode CH01 which it was worst case, so only the worst case's data on the test report.

➤ 30MHz ~ 1GHz

Polarization: Vertical

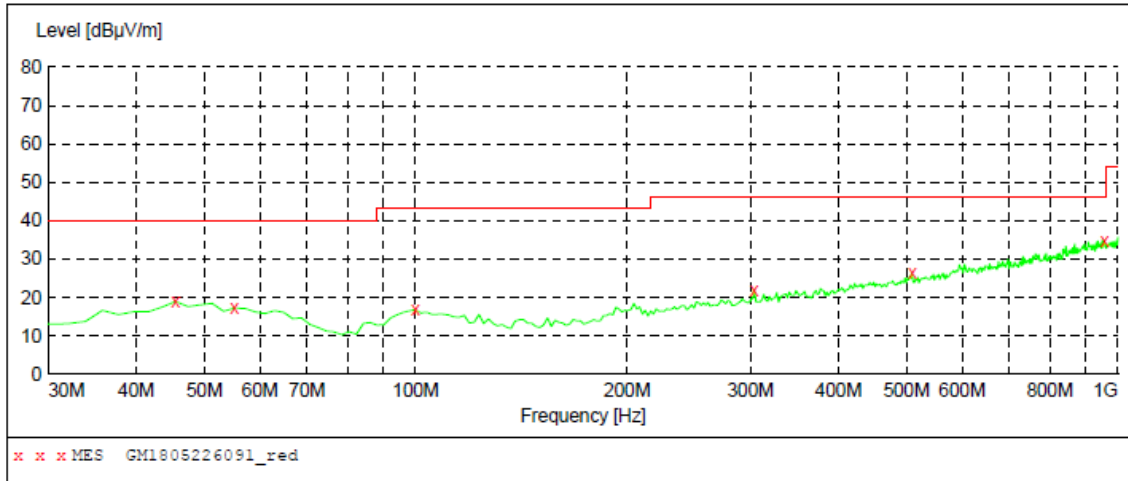

**MEASUREMENT RESULT: "GM1805226091\_red"**

5/22/2018 5:28PM

Frequency MHz	Level dBµV/m	Transd dB	Limit dBµV/m	Margin dB	Det.	Height cm	Azimuth deg	Polarization
45.520000	19.00	-8.8	40.0	21.0	QP	100.0	92.00	VERTICAL
55.220000	17.30	-9.2	40.0	22.7	QP	100.0	213.00	VERTICAL
99.840000	16.90	-10.6	43.5	26.6	QP	100.0	68.00	VERTICAL
303.540000	21.90	-7.2	46.0	24.1	QP	100.0	119.00	VERTICAL
509.180000	26.30	-1.5	46.0	19.7	QP	100.0	41.00	VERTICAL
955.380000	34.90	7.3	46.0	11.1	QP	100.0	92.00	VERTICAL

Polarization: Horizontal

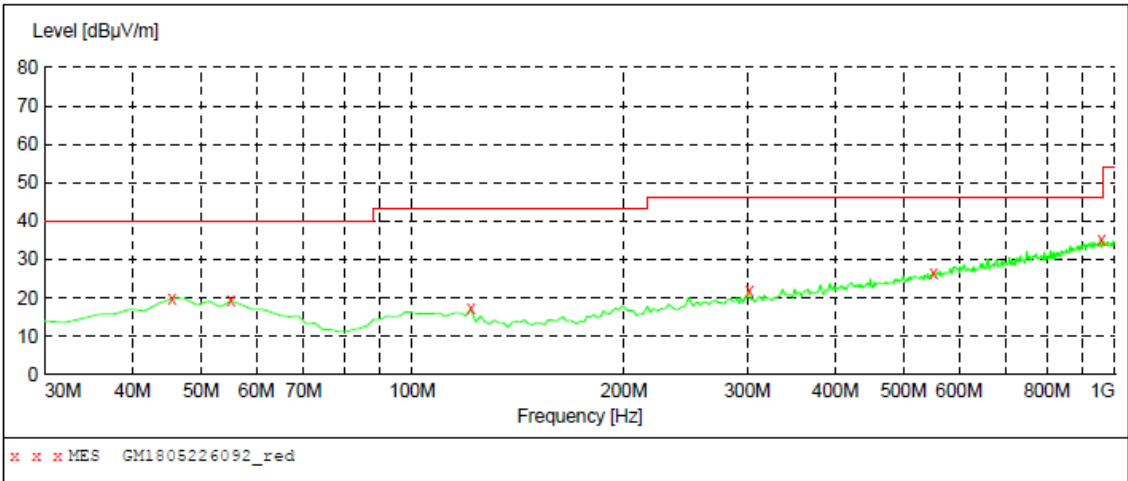

**MEASUREMENT RESULT: "GM1805226092\_red"**

5/22/2018 5:32PM

Frequency MHz	Level dBµV/m	Transd dB	Limit dBµV/m	Margin dB	Det.	Height cm	Azimuth deg	Polarization
45.520000	19.90	-8.8	40.0	20.1	QP	300.0	132.00	HORIZONTAL
55.220000	19.30	-9.2	40.0	20.7	QP	100.0	149.00	HORIZONTAL
121.180000	17.20	-12.5	43.5	26.3	QP	100.0	282.00	HORIZONTAL
301.600000	21.90	-7.2	46.0	24.1	QP	300.0	252.00	HORIZONTAL
551.860000	26.60	-0.7	46.0	19.4	QP	100.0	200.00	HORIZONTAL
955.380000	35.30	7.3	46.0	10.7	QP	100.0	282.00	HORIZONTAL

## ➤ 1 GHz ~ 25 GHz

802.11b					CH01				
Frequency (MHz)	Read Level (dBuV)	Antenna Factor (dB/m)	Cable Loss (dB)	Preamp Factor (dB)	Level (dBuV/m)	Limit Line (dBuV/m)	Over Limit (dB)	Polarization	Test value
1176.94	33.74	26.12	4.61	37.24	27.23	74.00	-46.77	Vertical	Peak
3616.45	35.46	29.30	8.29	37.05	36.00	74.00	-38.00	Vertical	Peak
5125.52	30.90	31.80	9.77	35.13	37.34	74.00	-36.66	Vertical	Peak
7245.81	33.72	36.25	11.91	33.45	48.43	74.00	-25.57	Vertical	Peak
3096.33	35.26	28.79	7.60	37.49	34.16	74.00	-39.84	Horizontal	Peak
3616.45	38.91	29.30	8.29	37.05	39.45	74.00	-34.55	Horizontal	Peak
7245.81	43.35	36.25	11.91	33.45	58.06	74.00	-15.94	Horizontal	Peak
9660.72	33.50	39.09	13.71	33.96	52.34	74.00	-21.66	Horizontal	Peak
9660.72	22.74	39.09	13.71	33.96	41.58	54.00	-12.42	Horizontal	Average
7245.82	32.50	36.25	11.91	33.45	47.21	54.00	-6.79	Horizontal	Average

802.11b					CH06				
Frequency (MHz)	Read Level (dBuV)	Antenna Factor (dB/m)	Cable Loss (dB)	Preamp Factor (dB)	Level (dBuV/m)	Limit Line (dBuV/m)	Over Limit (dB)	Polarization	Test value
1495.10	32.78	25.80	5.27	37.07	26.78	74.00	-47.22	Vertical	Peak
3653.46	41.52	29.30	8.33	37.02	42.13	74.00	-31.87	Vertical	Peak
4871.10	36.37	31.46	9.59	35.61	41.81	74.00	-32.19	Vertical	Peak
7319.96	42.36	36.30	11.99	33.32	57.33	74.00	-16.67	Vertical	Peak
7319.97	31.59	36.30	11.99	33.32	46.56	54.00	-7.44	Vertical	Average
4871.10	24.31	31.46	9.59	35.61	29.75	54.00	-24.25	Vertical	Average
1286.61	34.35	26.21	4.81	37.18	28.19	74.00	-45.81	Horizontal	Peak
3653.46	38.71	29.30	8.33	37.02	39.32	74.00	-34.68	Horizontal	Peak
5406.96	31.76	31.53	10.13	34.59	38.83	74.00	-35.17	Horizontal	Peak
7319.96	42.59	36.30	11.99	33.32	57.56	74.00	-16.44	Horizontal	Peak
7319.97	31.26	36.30	11.99	33.32	46.23	54.00	-7.77	Horizontal	Average

802.11b					CH11				
Frequency (MHz)	Read Level (dBuV)	Antenna Factor (dB/m)	Cable Loss (dB)	Preamplifier Factor (dB)	Level (dBuV/m)	Limit Line (dBuV/m)	Over Limit (dB)	Polarization	Test value
1192.01	35.06	26.24	4.64	37.23	28.71	74.00	-45.29	Vertical	Peak
3690.85	41.79	29.30	8.37	36.99	42.47	74.00	-31.53	Vertical	Peak
4920.96	38.26	31.42	9.62	35.52	43.78	74.00	-30.22	Vertical	Peak
7394.88	40.18	36.30	12.06	33.20	55.34	74.00	-18.66	Vertical	Peak
7394.88	29.64	36.30	12.06	33.20	44.80	54.00	-9.20	Vertical	Average
4920.96	24.56	31.42	9.62	35.52	30.08	54.00	-23.92	Vertical	Average
3690.85	38.66	29.30	8.37	36.99	39.34	74.00	-34.66	Horizontal	Peak
4920.96	33.92	31.42	9.62	35.52	39.44	74.00	-34.56	Horizontal	Peak
7394.88	41.48	36.30	12.06	33.20	56.64	74.00	-17.36	Horizontal	Peak
9859.47	35.60	39.10	13.61	34.12	54.19	74.00	-19.81	Horizontal	Peak
9859.47	22.46	39.10	13.61	34.12	41.05	54.00	-12.95	Horizontal	Average
7394.88	30.19	36.30	12.06	33.20	45.35	54.00	-8.65	Horizontal	Average

## Remark:

1. Final Level = Receiver Read level + Antenna Factor + Cable Loss – Preamplifier Factor
2. The peak level is lower than average limit(54 dBuV/m), this data is the too weak instrument of signal is unable to test.
3. The emission levels of other frequencies(test frequency band is 1GHz to 25GHz) are very lower than the limit and not show in test report.

802.11g					CH01				
Frequency (MHz)	Read Level (dBuV)	Antenna Factor (dB/m)	Cable Loss (dB)	Preamp Factor (dB)	Level (dBuV/m)	Limit Line (dBuV/m)	Over Limit (dB)	Polarization	Test value
3616.45	39.28	29.30	8.29	37.05	39.82	74.00	-34.18	Vertical	Peak
4821.76	33.15	31.56	9.55	35.69	38.57	74.00	-35.43	Vertical	Peak
7245.81	42.40	36.25	11.91	33.45	57.11	74.00	-16.89	Vertical	Peak
9660.72	33.83	39.09	13.71	33.96	52.67	74.00	-21.33	Vertical	Peak
9660.72	22.36	39.09	13.71	33.96	41.20	54.00	-12.80	Vertical	Average
7245.82	30.45	36.25	11.91	33.45	45.16	54.00	-8.84	Vertical	Average
3616.45	37.61	29.30	8.29	37.05	38.15	74.00	-35.85	Horizontal	Peak
5125.52	32.69	31.80	9.77	35.13	39.13	74.00	-34.87	Horizontal	Peak
7245.81	40.79	36.25	11.91	33.45	55.50	74.00	-18.50	Horizontal	Peak
9660.72	40.71	39.09	13.71	33.96	59.55	74.00	-14.45	Horizontal	Peak
9660.72	25.30	39.09	13.71	33.96	44.14	54.00	-9.86	Horizontal	Average
7245.82	28.95	36.25	11.91	33.45	43.66	54.00	-10.34	Horizontal	Average

802.11g					CH06				
Frequency (MHz)	Read Level (dBuV)	Antenna Factor (dB/m)	Cable Loss (dB)	Preamp Factor (dB)	Level (dBuV/m)	Limit Line (dBuV/m)	Over Limit (dB)	Polarization	Test value
3653.46	39.04	29.30	8.33	37.02	39.65	74.00	-34.35	Vertical	Peak
4883.52	34.55	31.43	9.59	35.58	39.99	74.00	-34.01	Vertical	Peak
7301.36	39.49	36.30	11.97	33.35	54.41	74.00	-19.59	Vertical	Peak
9759.59	34.25	39.10	13.66	34.04	52.97	74.00	-21.03	Vertical	Peak
9759.59	21.94	39.10	13.66	34.04	40.66	54.00	-13.34	Vertical	Average
7301.36	28.99	36.30	11.97	33.35	43.91	54.00	-10.09	Vertical	Average
3653.46	38.49	29.30	8.33	37.02	39.10	74.00	-34.90	Horizontal	Peak
5660.47	32.21	31.68	10.37	34.33	39.93	74.00	-34.07	Horizontal	Peak
7319.96	38.43	36.30	11.99	33.32	53.40	74.00	-20.60	Horizontal	Peak
9759.59	38.72	39.10	13.66	34.04	57.44	74.00	-16.56	Horizontal	Peak
9759.59	24.47	39.10	13.66	34.04	43.19	54.00	-10.81	Horizontal	Average
7319.97	28.10	36.30	11.99	33.32	43.07	54.00	-10.93	Horizontal	Average

802.11g					CH11				
Frequency (MHz)	Read Level (dBuV)	Antenna Factor (dB/m)	Cable Loss (dB)	Preamplifier Factor (dB)	Level (dBuV/m)	Limit Line (dBuV/m)	Over Limit (dB)	Polarization	Test value
2597.56	33.52	27.79	6.91	37.59	30.63	74.00	-43.37	Vertical	Peak
3795.66	35.03	29.59	8.50	36.91	36.21	74.00	-37.79	Vertical	Peak
7394.88	38.39	36.30	12.06	33.20	53.55	74.00	-20.45	Vertical	Peak
9859.47	33.39	39.10	13.61	34.12	51.98	74.00	-22.02	Vertical	Peak
9859.47	21.43	39.10	13.61	34.12	40.02	54.00	-13.98	Vertical	Average
7394.88	27.42	36.30	12.06	33.20	42.58	54.00	-11.42	Vertical	Average
3690.85	37.42	29.30	8.37	36.99	38.10	74.00	-35.90	Horizontal	Peak
5925.86	31.49	32.35	10.64	34.19	40.29	74.00	-33.71	Horizontal	Peak
7394.88	36.40	36.30	12.06	33.20	51.56	74.00	-22.44	Horizontal	Peak
9859.47	35.62	39.10	13.61	34.12	54.21	74.00	-19.79	Horizontal	Peak
9859.47	23.50	39.10	13.61	34.12	42.09	54.00	-11.91	Horizontal	Average
7394.88	25.49	36.30	12.06	33.20	40.65	54.00	-13.35	Horizontal	Average

## Remark:

1. Final Level = Receiver Read level + Antenna Factor + Cable Loss – Preamplifier Factor
2. The peak level is lower than average limit(54 dBuV/m), this data is the too weak instrument of signal is unable to test.
3. The emission levels of other frequencies(test frequency band is 1GHz to 25GHz) are very lower than the limit and not show in test report.

802.11n(HT20)					CH01				
Frequency (MHz)	Read Level (dBuV)	Antenna Factor (dB/m)	Cable Loss (dB)	Preamp Factor (dB)	Level (dBuV/m)	Limit Line (dBuV/m)	Over Limit (dB)	Polarization	Test value
1235.26	34.54	26.26	4.72	37.20	28.32	74.00	-45.68	Vertical	Peak
3616.45	38.07	29.30	8.29	37.05	38.61	74.00	-35.39	Vertical	Peak
7245.81	40.65	36.25	11.91	33.45	55.36	74.00	-18.64	Vertical	Peak
9660.72	36.93	39.09	13.71	33.96	55.77	74.00	-18.23	Vertical	Peak
9660.72	20.73	39.09	13.71	33.96	39.57	54.00	-14.43	Vertical	Average
7245.82	28.19	36.25	11.91	33.45	42.90	54.00	-11.10	Vertical	Average
3616.45	37.57	29.30	8.29	37.05	38.11	74.00	-35.89	Horizontal	Peak
4748.67	33.31	31.40	9.52	35.83	38.40	74.00	-35.60	Horizontal	Peak
7245.81	40.38	36.25	11.91	33.45	55.09	74.00	-18.91	Horizontal	Peak
9660.72	38.92	39.09	13.71	33.96	57.76	74.00	-16.24	Horizontal	Peak
9660.72	23.07	39.09	13.71	33.96	41.91	54.00	-12.09	Horizontal	Average
7245.82	27.68	36.25	11.91	33.45	42.39	54.00	-11.61	Horizontal	Average

802.11n(HT20)					CH06				
Frequency (MHz)	Read Level (dBuV)	Antenna Factor (dB/m)	Cable Loss (dB)	Preamp Factor (dB)	Level (dBuV/m)	Limit Line (dBuV/m)	Over Limit (dB)	Polarization	Test value
1207.28	34.30	26.29	4.67	37.22	28.04	74.00	-45.96	Vertical	Peak
3653.46	38.08	29.30	8.33	37.02	38.69	74.00	-35.31	Vertical	Peak
7319.96	40.72	36.30	11.99	33.32	55.69	74.00	-18.31	Vertical	Peak
9759.59	41.02	39.10	13.66	34.04	59.74	74.00	-14.26	Vertical	Peak
9759.59	25.63	39.10	13.66	34.04	44.35	54.00	-9.65	Vertical	Average
7319.97	29.18	36.30	11.99	33.32	44.15	54.00	-9.85	Vertical	Average
1219.64	34.50	26.28	4.69	37.21	28.26	74.00	-45.74	Horizontal	Peak
3653.46	38.02	29.30	8.33	37.02	38.63	74.00	-35.37	Horizontal	Peak
7301.36	40.15	36.30	11.97	33.35	55.07	74.00	-18.93	Horizontal	Peak
9759.59	43.85	39.10	13.66	34.04	62.57	74.00	-11.43	Horizontal	Peak
9759.59	25.63	39.10	13.66	34.04	44.35	54.00	-9.65	Horizontal	Average
7301.36	29.23	36.30	11.97	33.35	44.15	54.00	-9.85	Horizontal	Average



802.11n(HT20)					CH11				
Frequency (MHz)	Read Level (dBuV)	Antenna Factor (dB/m)	Cable Loss (dB)	Preamp Factor (dB)	Level (dBuV/m)	Limit Line (dBuV/m)	Over Limit (dB)	Polarization	Test value
3700.26	39.13	29.30	8.39	36.98	39.84	74.00	-34.16	Vertical	Peak
5151.68	32.46	31.69	9.79	35.08	38.86	74.00	-35.14	Vertical	Peak
7394.88	40.01	36.30	12.06	33.20	55.17	74.00	-18.83	Vertical	Peak
9859.47	33.24	39.10	13.61	34.12	51.83	74.00	-22.17	Vertical	Peak
9859.47	20.99	39.10	13.61	34.12	39.58	54.00	-14.42	Vertical	Average
7394.88	26.09	36.30	12.06	33.20	41.25	54.00	-12.75	Vertical	Average
3690.85	37.81	29.30	8.37	36.99	38.49	74.00	-35.51	Horizontal	Peak
5646.08	32.05	31.71	10.34	34.34	39.76	74.00	-34.24	Horizontal	Peak
7394.88	39.07	36.30	12.06	33.20	54.23	74.00	-19.77	Horizontal	Peak
9859.47	36.83	39.10	13.61	34.12	55.42	74.00	-18.58	Horizontal	Peak
9859.47	22.44	39.10	13.61	34.12	41.03	54.00	-12.97	Horizontal	Average
7394.88	26.49	36.30	12.06	33.20	41.65	54.00	-12.35	Horizontal	Average

## Remark:

1. Final Level = Receiver Read level + Antenna Factor + Cable Loss – Pre-amplifier Factor
2. The peak level is lower than average limit(54 dBuV/m), this data is the too weak instrument of signal is unable to test.
3. The emission levels of other frequencies(test frequency band is 1GHz to 25GHz) are very lower than the limit and not show in test report.

## 6. TEST SETUP PHOTOS

Conducted Emissions (AC Mains)



Radiated Emissions





## 7. EXTERANAL AND INTERNAL PHOTOS

Reference to the test report No.: TRE1805016601.

-----End of Report-----