



TEST REPORT

Report Reference No...... : **TRE1805016604** R/C.....: 83276

FCC ID..... : **QRP-AZUMIKA5QP**

Applicant's name..... : **Azumi S.A**

Address.....: Avenida Aquilino de la Guardia con Calle 47, PH Ocean Plaza, Piso 16 of. 16-01, Marbella, Ciudad de Panama, Panama

Manufacturer.....: AZUMI HK LTD

Address.....: FLAT/RM 18 BLK 1 14/F GOLDEN INDUSTRIAL BUILDING
16-26 KWAI TAK STREET KWAI CHUNG,HK

Test item description : **Mobile Phone**

Trade Mark: AZUMI

Model/Type reference.....: KIREI A5Q PLUS

Listed Model(s): -

Standard : **FCC CFR Title 47 Part 15 Subpart C Section 15.247**

Date of receipt of test sample.....: May.18,2018

Date of testing.....: May.19,2018- May.31,2018

Date of issue.....: Jun.01,2018

Result.....: **PASS**

Compiled by
(position+printedname+signature)....: File administrators Candy Liu *Candy Liu*

Supervised by
(position+printed name+signature)...: Project Engineer Aaron Fang *Aaron.Fang*

Approved by
(Position+Printed name+Signature): RF Manager Hans Hu *Hans Hu*

Testing Laboratory Name : **Shenzhen Huatongwei International Inspection Co., Ltd.**

Address.....: 1/F, Bldg 3, Hongfa Hi-tech Industrial Park, Genyu Road, Tianliao, Gongming, Shenzhen, China

Shenzhen Huatongwei International Inspection Co., Ltd. All rights reserved.

This publication may be reproduced in whole or in part for non-commercial purposes as long as the Shenzhen Huatongwei International Inspection Co., Ltd. is acknowledged as copyright owner and source of the material. Shenzhen Huatongwei International Inspection Co., Ltd. takes no responsibility for and will not assume liability for damages resulting from the reader's interpretation of the reproduced material due to its placement and context.

The test report merely correspond to the test sample.

Contents

1.	<u>TEST STANDARDS AND REPORT VERSION</u>	3
1.1.	Test Standards	3
1.2.	Report version	3
2.	<u>TEST DESCRIPTION</u>	4
3.	<u>SUMMARY</u>	5
3.1.	Client Information	5
3.2.	Product Description	5
3.3.	Operation state	6
3.4.	EUT configuration	6
3.5.	Modifications	6
4.	<u>TEST ENVIRONMENT</u>	7
4.1.	Address of the test laboratory	7
4.2.	Test Facility	7
4.3.	Environmental conditions	8
4.4.	Statement of the measurement uncertainty	8
4.5.	Equipments Used during the Test	9
5.	<u>TEST CONDITIONS AND RESULTS</u>	11
5.1.	Antenna requirement	11
5.2.	Conducted Emissions (AC Main)	12
5.3.	Conducted Peak Output Power	15
5.4.	20 dB Bandwidth	19
5.5.	Carrier Frequencies Separation	23
5.6.	Hopping Channel Number	25
5.7.	Dwell Time	27
5.8.	Pseudorandom Frequency Hopping Sequence	34
5.9.	Restricted band (radiated)	35
5.10.	Band edge and Spurious Emissions (conducted)	37
5.11.	Spurious Emissions (radiated)	53
6.	<u>TEST SETUP PHOTOS</u>	57
7.	<u>EXTERANAL AND INTERNAL PHOTOS</u>	58

1. TEST STANDARDS AND REPORT VERSION

1.1. Test Standards

The tests were performed according to following standards:

[FCC Rules Part 15.247](#): Frequency Hopping, Direct Spread Spectrum and Hybrid Systems that are in operation within the bands of 902-928 MHz, 2400-2483.5 MHz, and 5725-5850 MHz

[ANSI C63.10-2013](#): American National Standard for Testing Unlicensed Wireless Devices

1.2. Report version

Version No.	Date of issue	Description
N/A	Jun.01,2018	Original

2. TEST DESCRIPTION

Test Item	Section in CFR 47	Result	Test Engineer
Antenna Requirement	15.203/15.247 (c)	PASS	Xiaokang tan
AC Power Line Conducted Emissions	15.207	PASS	Tony Duan
Conducted Peak Output Power	15.247 (b)(1)	PASS	Xiaokang tan
20 dB Bandwidth	15.247 (a)(1)	PASS	Xiaokang tan
Carrier Frequencies Separation	15.247 (a)(1)	PASS	Xiaokang tan
Hopping Channel Number	15.247 (a)(1)	PASS	Xiaokang tan
Dwell Time	15.247 (a)(1)	PASS	Xiaokang tan
Pseudorandom Frequency Hopping Sequence	15.247(b)(4)	PASS	Xiaokang tan
Restricted band	15.247(d)/15.205	PASS	Xiaokang tan
Radiated Emissions	15.247(d)/15.209	PASS	Jiuru Pan

Note: The measurement uncertainty is not included in the test result.

3. SUMMARY

3.1. Client Information

Applicant:	Azumi S.A
Address:	Avenida Aquilino de la Guardia con Calle 47, PH Ocean Plaza, Piso 16 of. 16-01, Marbella, Ciudad de Panama, Panama
Manufacturer:	AZUMI HK LTD
Address:	FLAT/RM 18 BLK 1 14/F GOLDEN INDUSTRIAL BUILDING 16-26 KWAI TAK STREET KWAI CHUNG, HK

3.2. Product Description

Name of EUT:	Mobile Phone
Trade Mark:	AZUMI
Model No.:	KIREI A5Q PLUS
Listed Model(s):	-
IMEI:	Conducted: 358798898788979 Radiated: 353018030000082
Power supply:	DC 3.7V
Adapter information:	Input: 100-240Va.c., 50/60Hz, 0.2A Output: 5Vd.c.,0.7A
Hardware version:	S511_MB_V1.3
Software version:	Azumi_s5015_base_v001(20180416)
Bluetooth	
Version:	Supported BT4.0+EDR
Modulation:	GFSK, $\pi/4$ DQPSK, 8DPSK
Operation frequency:	2402MHz~2480MHz
Channel number:	79
Channel separation:	1MHz
Antenna type:	PIFA Antenna
Antenna gain:	1.0dBi

3.3. Operation state

➤ **Test frequency list**

According to section 15.31(m), regards to the operating frequency range over 10 MHz, must select three channel which were tested. the Lowest frequency, the middle frequency, and the highest frequency of channel were selected to perform the test, please see the above gray bottom.

Channel	Frequency (MHz)
00	2402
01	2403
⋮	⋮
39	2441
⋮	⋮
77	2479
78	2480

➤ **TEST MODE**

For RF test items:
The engineering test program was provided and enabled to make EUT continuous transmit
For AC power line conducted emissions:
The EUT was set to connect with the Bluetooth instrument under large package sizes transmission.
For Radiated suprious emissions test item:
The engineering test program was provided and enabled to make EUT continuous transmit. The EUT in each of three orthogonal axis emissions had been tested ,but only the worst case (X axis) data recorded in the report.

3.4. EUT configuration

The following peripheral devices and interface cables were connected during the measurement:

- - supplied by the manufacturer
- - supplied by the lab

/	Manufacturer:	/
	Model No.:	/
/	Manufacturer:	/
	Model No.:	/

3.5. Modifications

No modifications were implemented to meet testing criteria.

4. TEST ENVIRONMENT

4.1. Address of the test laboratory

Laboratory: Shenzhen Huatongwei International Inspection Co., Ltd.

Address: 1/F, Bldg 3, Hongfa Hi-tech Industrial Park, Genyu Road, Tianliao, Gongming, Shenzhen, China

4.2. Test Facility

CNAS-Lab Code: L1225

Shenzhen Huatongwei International Inspection Co., Ltd. has been assessed and proved to be in compliance with CNAS-CL01 Accreditation Criteria for Testing and Calibration Laboratories (identical to ISO/IEC17025: 2005 General Requirements) for the Competence of Testing and Calibration Laboratories.

A2LA-Lab Cert. No.: 3902.01

Shenzhen Huatongwei International Inspection Co., Ltd. EMC Laboratory has been accredited by A2LA for technical competence in the field of electrical testing, and proved to be in compliance with ISO/IEC 17025: 2005 General Requirements for the Competence of Testing and Calibration Laboratories and any additional program requirements in the identified field of testing.

FCC-Registration No.: 762235

Shenzhen Huatongwei International Inspection Co., Ltd. EMC Laboratory has been registered and fully described in a report filed with the FCC (Federal Communications Commission). The acceptance letter from the FCC is maintained in our files.

IC-Registration No.:5377B-1

Two 3m Alternate Test Site of Shenzhen Huatongwei International Inspection Co., Ltd. has been registered by Certification and Engineering Bureau of Industry Canada for the performance of radiated measurements with Registration No.: 5377B-1.

ACA

Shenzhen Huatongwei International Inspection Co., Ltd. EMC Laboratory can also perform testing for the Australian C-Tick mark as a result of our A2LA accreditation.

4.3. Environmental conditions

During the measurement the environmental conditions were within the listed ranges:

Temperature:	15~35°C
Relative Humidity:	30~60 %
Air Pressure:	950~1050mba

4.4. Statement of the measurement uncertainty

The data and results referenced in this document are true and accurate. The reader is cautioned that there may be errors in calibration limits of the equipment and facilities. The measurement uncertainty was calculated for all measurements listed in this test report according to TR-100028-01 "Electromagnetic compatibility and Radio spectrum Matters (ERM); Uncertainties in the measurement of mobile radio equipment characteristics; Part 1" and TR-100028-02 "Electromagnetic compatibility and Radio spectrum Matters (ERM); Uncertainties in the measurement of mobile radio equipment characteristics; Part 2" and is documented in the Shenzhen Huatongwei International Inspection Co., Ltd. quality system according to ISO/IEC 17025. Furthermore, component and process variability of devices similar to that tested may result in additional deviation. The manufacturer has the sole responsibility of continued compliance of the device.

Here after the best measurement capability for Shenzhen Huatongwei International Inspection Co., Ltd. is reported:

Test Items	Measurement Uncertainty	Notes
Transmitter power conducted	0.57 dB	(1)
Transmitter power Radiated	2.20 dB	(1)
Conducted spurious emissions 9kHz~40GHz	1.60 dB	(1)
Radiated spurious emissions 9kHz~40GHz	2.20 dB	(1)
Conducted Emissions 9kHz~30MHz	3.39 dB	(1)
Radiated Emissions 30~1000MHz	4.24 dB	(1)
Radiated Emissions 1~18GHz	5.16 dB	(1)
Radiated Emissions 18~40GHz	5.54 dB	(1)
Occupied Bandwidth	-----	(1)

(1) This uncertainty represents an expanded uncertainty expressed at approximately the 95% confidence level using a coverage factor of k=1.96.

4.5. Equipments Used during the Test

Conducted Emissions						
Item	Test Equipment	Manufacturer	Model No.	Serial No.	Last Cal. (mm-dd-yy)	Next Cal. (mm-dd-yy)
1	EMI Test Receiver	R&S	ESCI	101247	11/11/2017	11/10/2018
2	Artificial Mains	SCHWARZBECK	NNLK 8121	573	11/11/2017	11/10/2018
3	2-Line V-Network	R&S	ESH3-Z5	100049	11/11/2017	11/10/2018
4	Pulse Limiter	R&S	ESH3-Z2	101488	11/11/2017	11/10/2018
5	RF Connection Cable	HUBER+SUHNER	EF400	N/A	11/21/2017	11/20/2018
6	Test Software	R&S	ES-K1	N/A	N/A	N/A

Radiated Emissions						
Item	Test Equipment	Manufacturer	Model No.	Serial No.	Last Cal. (mm-dd-yy)	Next Cal. (mm-dd-yy)
1	Semi-Anechoic Chamber	Albatross projects	SAC-3m-01	C11121	10/16/2016	10/15/2019
2	EMI Test Receiver	R&S	ESCI	100900	11/11/2017	11/10/2018
3	Loop Antenna	R&S	HFH2-Z2	100020	11/20/2017	11/19/2020
4	Ultra-Broadband Antenna	SCHWARZBECK	VULB9163	538	4/5/2017	4/4/2020
5	Horn Antenna	SCHWARZBECK	9120D	1011	3/27/2017	3/26/2020
6	Broadband Horn Antenna	SCHWARZBECK	BBHA9170	BBHA9170 472	3/27/2017	3/26/2020
7	Pre-amplifier	SCHWARZBECK	BBV 9743	9743-0022	10/18/2017	10/17/2018
8	Broadband Pre-amplifier	SCHWARZBECK	BBV 9718	9718-248	10/18/2017	10/17/2018
9	Spectrum Analyzer	R&S	FSP40	100597	11/11/2017	11/10/2018
10	RF Connection Cable	HUBER+SUHNER	RE-7-FL	N/A	11/21/2017	11/20/2018
11	RF Connection Cable	HUBER+SUHNER	RE-7-FH	N/A	11/21/2017	11/20/2018
12	Test Software	Audix	E3	N/A	N/A	N/A
13	Test Software	R&S	ES-K1	N/A	N/A	N/A
14	Turntable	Maturo Germany	TT2.0-1T	N/A	N/A	N/A
15	Antenna Mast	Maturo Germany	CAM-4.0-P-12	N/A	N/A	N/A

RF Conducted Test						
Item	Test Equipment	Manufacturer	Model No.	Serial No.	Last Cal. (mm-dd-yy)	Next Cal. (mm-dd-yy)
1	Spectrum Analyzer	R&S	FSV40	100048	11/11/2017	11/10/2018
2	EXA Signal Analyzer	Agilent	N9020A	184247	9/22/2017	9/21/2018
3	Power Meter	Anritsu	ML249A	N/A	9/22/2017	9/21/2018
4	OSP	R&S	OSP120	101317	N/A	N/A

5. TEST CONDITIONS AND RESULTS

5.1. Antenna requirement

Requirement

FCC CFR Title 47 Part 15 Subpart C Section 15.203:

An intentional radiator shall be designed to ensure that no antenna other than that furnished by the responsible party shall be used with the device. The use of a permanently attached antenna or of an antenna that uses a unique coupling to the intentional radiator, the manufacturer may design the unit so that a broken antenna can be replaced by the user, but the use of a standard antenna jack or electrical connector is prohibited.

FCC CFR Title 47 Part 15 Subpart C Section 15.247(c) (1)(i):

(i) Systems operating in the 2400~2483.5 MHz band that is used exclusively for fixed. Point-to-point operations may employ transmitting antennas with directional gain greater than 6 dBi provided the maximum conducted output power of the intentional radiator is reduced by 1 dB for every 3 dB that the directional gain of the antenna exceeds 6 dBi.

Test Result:

Passed **Not Applicable**

The directional gain of the antenna less than 6 dBi, please refer to the below antenna photo.

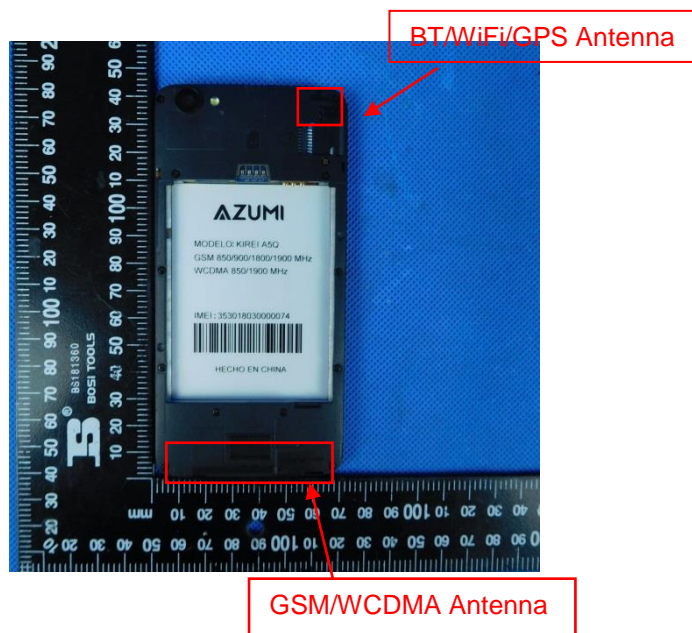

5.2. Conducted Emissions (AC Main)

LIMIT

FCC CFR Title 47 Part 15 Subpart C Section 15.207

Frequency range (MHz)	Limit (dBuV)	
	Quasi-peak	Average
0.15-0.5	66 to 56*	56 to 46*
0.5-5	56	46
5-30	60	50

* Decreases with the logarithm of the frequency.

TEST CONFIGURATION

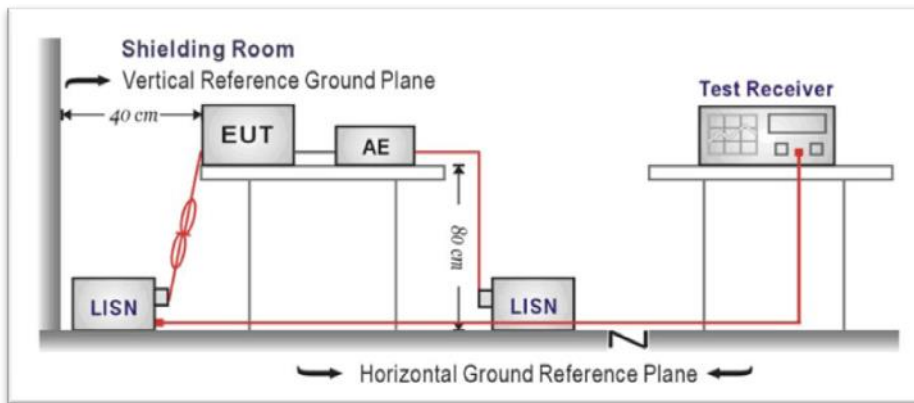

TEST PROCEDURE

1. The EUT was setup according to ANSI C63.10:2013 requirements.
2. The EUT was placed on a platform of nominal size, 1 m by 1.5 m, raised 80 cm above the conducting ground plane. The vertical conducting plane was located 40 cm to the rear of the EUT. All other surfaces of EUT were at least 80 cm from any other grounded conducting surface.
3. The EUT and simulators are connected to the main power through a line impedances stabilization network (LISN). The LISN provides a 50 ohm /50uH coupling impedance for the measuring equipment.
4. The peripheral devices are also connected to the main power through a LISN. (Please refer to the block diagram of the test setup and photographs)
5. Each current-carrying conductor of the EUT power cord, except the ground (safety) conductor, was individually connected through a LISN to the input power source.
6. The excess length of the power cord between the EUT and the LISN receptacle were folded back and forth at the center of the lead to form a bundle not exceeding 40 cm in length.
7. Conducted emissions were investigated over the frequency range from 0.15MHz to 30MHz using a receiver bandwidth of 9 kHz.
8. During the above scans, the emissions were maximized by cable manipulation.

TEST RESULTS

Passed Not Applicable

Note:

- 1) Transd= Cable lose + Pulse Limiter Factor + Artificial Mains Factor
- 2) Margin= Limit - Level

Test Line:

L

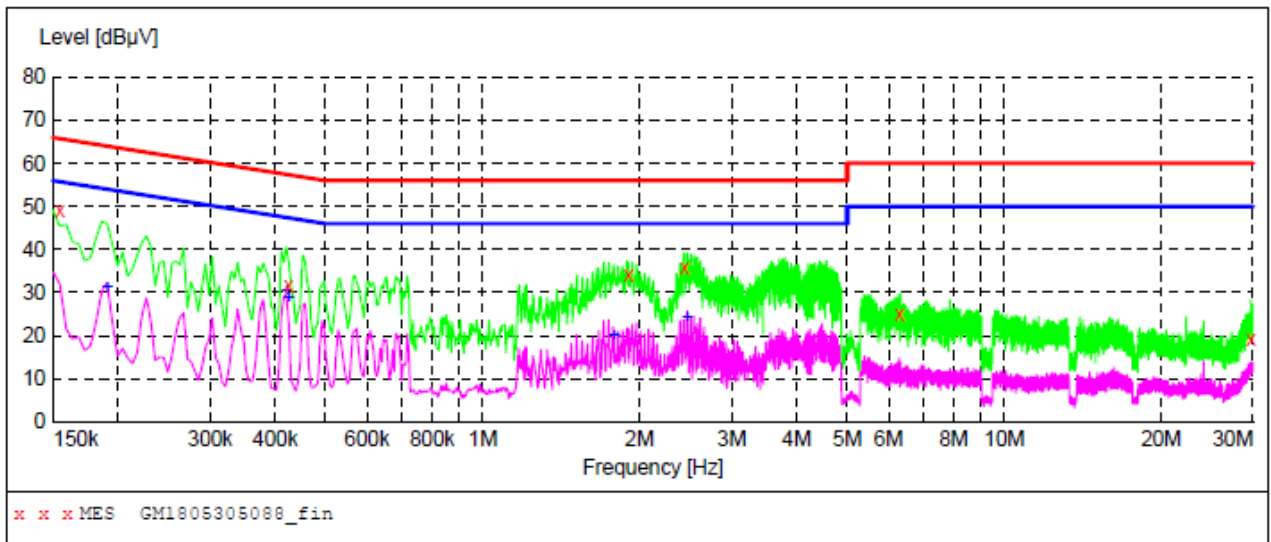

MEASUREMENT RESULT: "GM1805305088_fin"

5/30/2018 8:06PM

Frequency MHz	Level dBµV	Transd dB	Limit dBµV	Margin dB	Detector	Line	PE
0.154500	49.10	10.0	66	16.7	QP	L1	GND
0.424500	31.50	9.9	57	25.9	QP	L1	GND
1.900500	33.90	10.1	56	22.1	QP	L1	GND
2.436000	35.80	10.1	56	20.2	QP	L1	GND
6.297000	24.90	10.2	60	35.1	QP	L1	GND
29.746500	19.20	10.9	60	40.8	QP	L1	GND

MEASUREMENT RESULT: "GM1805305088_fin2"

5/30/2018 8:06PM

Frequency MHz	Level dBµV	Transd dB	Limit dBµV	Margin dB	Detector	Line	PE
0.190500	31.20	10.0	54	22.8	AV	L1	GND
0.420000	30.40	9.9	47	17.0	AV	L1	GND
0.424500	28.60	9.9	47	18.8	AV	L1	GND
1.788000	20.10	10.1	46	25.9	AV	L1	GND
2.472000	24.00	10.1	46	22.0	AV	L1	GND

Test Line:

N

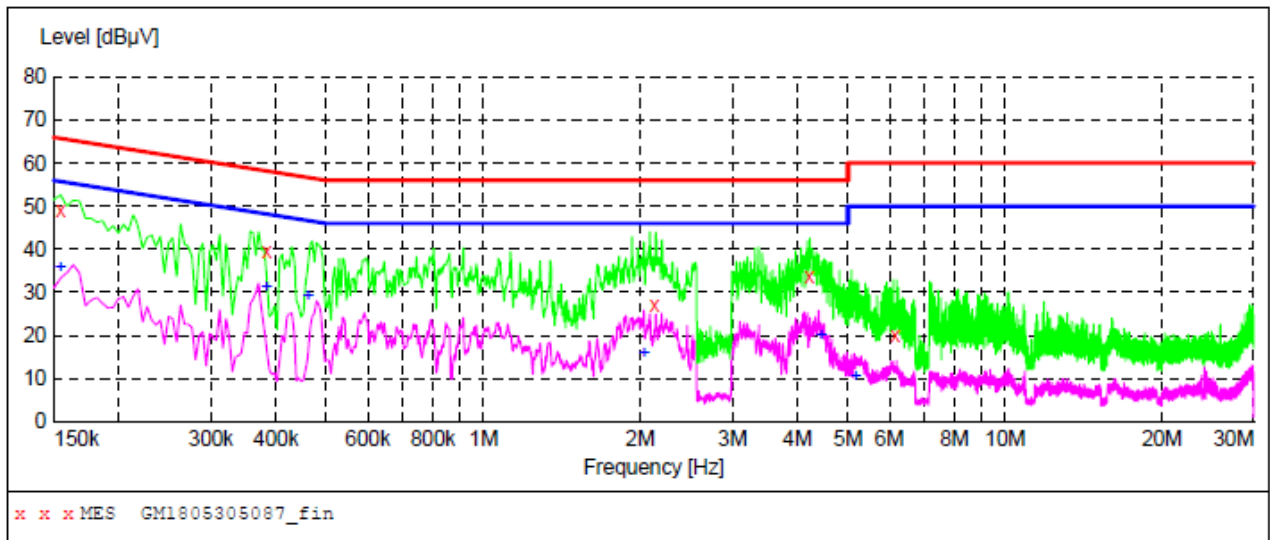

MEASUREMENT RESULT: "GM1805305087_fin"

5/30/2018 8:03PM

Frequency MHz	Level dBµV	Transd dB	Limit dBµV	Margin dB	Detector	Line	PE
0.154500	49.10	10.0	66	16.7	QP	N	GND
0.384000	39.50	9.9	58	18.7	QP	N	GND
2.125500	27.10	10.1	56	28.9	QP	N	GND
4.209000	33.70	10.1	56	22.3	QP	N	GND
6.144000	20.00	10.2	60	40.0	QP	N	GND

MEASUREMENT RESULT: "GM1805305087_fin2"

5/30/2018 8:03PM

Frequency MHz	Level dBµV	Transd dB	Limit dBµV	Margin dB	Detector	Line	PE
0.154500	35.60	10.0	56	20.2	AV	N	GND
0.384000	31.30	9.9	48	16.9	AV	N	GND
0.460500	29.00	9.9	47	17.7	AV	N	GND
2.031000	15.70	10.1	46	30.3	AV	N	GND
4.434000	20.10	10.2	46	25.9	AV	N	GND
5.163000	10.30	10.2	50	39.7	AV	N	GND

5.3. Conducted Peak Output Power

LIMIT

FCC CFR Title 47 Part 15 Subpart C Section 15.247 (b)(1):

For frequency hopping systems operating in the 2400-2483.5 MHz band employing at least 75 non-overlapping hopping channels, and all frequency hopping systems in the 5725-5850 MHz band: 1 watt.
For all other frequency hopping systems in the 2400-2483.5 MHz band: 0.125 watts.

TEST CONFIGURATION

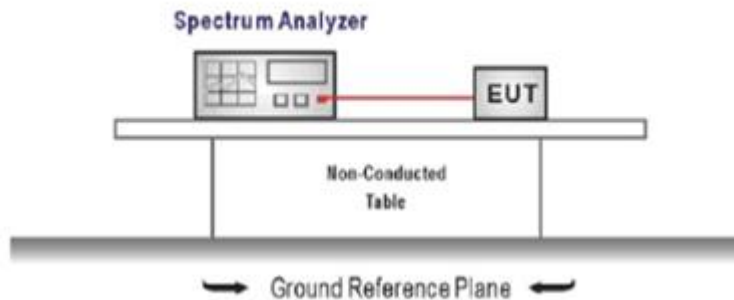

TEST PROCEDURE

1. The transmitter output was connected to the spectrum analyzer through an attenuator, the pathloss was compensated to the results for each measurement.
2. Set to the maximum power setting and enable the EUT transmit continuously
3. Use the following spectrum analyzer settings:
Span = approximately 5 times the 20 dB bandwidth, centered on a hopping channel
RBW \geq the 20 dB bandwidth of the emission being measured, VBW \geq RBW
Sweep = auto, Detector function = peak, Trace = max hold
4. Measure and record the results in the test report.

TEST MODE:

Please refer to the clause 3.3

TEST RESULTS

Passed Not Applicable

Modulation type	Channel	Output power (dBm)	Limit (dBm)	Result
GFSK	00	4.35	≤ 30.00	Pass
	39	3.98		
	78	3.85		
$\pi/4$ DQPSK	00	4.20	≤ 21.00	Pass
	39	3.85		
	78	3.70		
8DPSK	00	4.33	≤ 21.00	Pass
	39	3.99		
	78	3.57		

Modulation Type: GFSK	
CH00	<p>Spectrum plot for CH00. The plot shows a peak at 2.40207240 GHz with a power of 4.35 dBm. The y-axis ranges from -70 dBm to 10 dBm, and the x-axis shows a center frequency of 2.402 GHz and a span of 5.0 MHz. The plot includes parameters: Ref Level 20.00 dBm, Att 30 dB, Offset 1.00 dB, RBW 1 MHz, Count 500/500, SWT 1 ms, VBW 3 MHz, Mode Auto Sweep. A peak marker M1[1] is visible at the top of the curve.</p>
CH39	<p>Spectrum plot for CH39. The plot shows a peak at 2.44097830 GHz with a power of 3.98 dBm. The y-axis ranges from -70 dBm to 10 dBm, and the x-axis shows a center frequency of 2.441 GHz and a span of 5.0 MHz. The plot includes parameters: Ref Level 20.00 dBm, Att 30 dB, Offset 1.00 dB, RBW 1 MHz, Count 500/500, SWT 1 ms, VBW 3 MHz, Mode Auto Sweep. A peak marker M1[1] is visible at the top of the curve.</p>
CH78	<p>Spectrum plot for CH78. The plot shows a peak at 2.47983360 GHz with a power of 3.85 dBm. The y-axis ranges from -70 dBm to 10 dBm, and the x-axis shows a center frequency of 2.48 GHz and a span of 5.0 MHz. The plot includes parameters: Ref Level 20.00 dBm, Att 30 dB, Offset 1.00 dB, RBW 1 MHz, Count 500/500, SWT 1 ms, VBW 3 MHz, Mode Auto Sweep. A peak marker M1[1] is visible at the top of the curve.</p>

Modulation Type: $\pi/4$ DQPSK	
CH00	<p>Spectrum</p> <p>Ref Level 20.00 dBm Offset 1.00 dB RBW 2 MHz Att 30 dB SWF 1 ms VBW 5 MHz Mode Auto Sweep Count 500/500</p> <p>IPK View</p> <p>M1[1] 4.20 dBm 2.40208680 GHz</p> <p>CF 2.402 GHz 691 pts Span 5.0 MHz</p>
CH39	<p>Spectrum</p> <p>Ref Level 20.00 dBm Offset 1.00 dB RBW 2 MHz Att 30 dB SWF 1 ms VBW 5 MHz Mode Auto Sweep Count 500/500</p> <p>IPK View</p> <p>M1[1] 3.85 dBm 2.44107960 GHz</p> <p>CF 2.441 GHz 691 pts Span 5.0 MHz</p>
CH78	<p>Spectrum</p> <p>Ref Level 20.00 dBm Offset 1.00 dB RBW 2 MHz Att 30 dB SWF 1 ms VBW 5 MHz Mode Auto Sweep Count 500/500</p> <p>IPK View</p> <p>M1[1] 3.70 dBm 2.48015920 GHz</p> <p>CF 2.48 GHz 691 pts Span 5.0 MHz</p>

Modulation Type: 8DPSK	
CH00	<p>Spectrum plot for CH00. The plot shows a signal peak at 2.40195660 GHz with a power of 4.33 dBm. The y-axis represents power in dBm, ranging from -70 to 10. The x-axis represents frequency in GHz, with a center frequency (CF) of 2.402 GHz and a span of 5.0 MHz. The plot includes a grid and a peak marker labeled M1[1].</p> <p>Ref Level 20.00 dBm Offset 1.00 dB RBW 2 MHz Att 30 dB SWF 1 ms VBW 5 MHz Mode Auto Sweep Count 500/500 CF 2.402 GHz 691 pts Span 5.0 MHz</p>
CH39	<p>Spectrum plot for CH39. The plot shows a signal peak at 2.44098550 GHz with a power of 3.99 dBm. The y-axis represents power in dBm, ranging from -70 to 10. The x-axis represents frequency in GHz, with a center frequency (CF) of 2.441 GHz and a span of 5.0 MHz. The plot includes a grid and a peak marker labeled M1[1].</p> <p>Ref Level 20.00 dBm Offset 1.00 dB RBW 2 MHz Att 30 dB SWF 1 ms VBW 5 MHz Mode Auto Sweep Count 500/500 CF 2.441 GHz 691 pts Span 5.0 MHz</p>
CH78	<p>Spectrum plot for CH78. The plot shows a signal peak at 2.47997830 GHz with a power of 3.57 dBm. The y-axis represents power in dBm, ranging from -70 to 10. The x-axis represents frequency in GHz, with a center frequency (CF) of 2.48 GHz and a span of 5.0 MHz. The plot includes a grid and a peak marker labeled M1[1].</p> <p>Ref Level 20.00 dBm Offset 1.00 dB RBW 2 MHz Att 30 dB SWF 1 ms VBW 5 MHz Mode Auto Sweep Count 500/500 CF 2.48 GHz 691 pts Span 5.0 MHz</p>

5.4. 20 dB Bandwidth

LIMIT

N/A

TEST CONFIGURATION

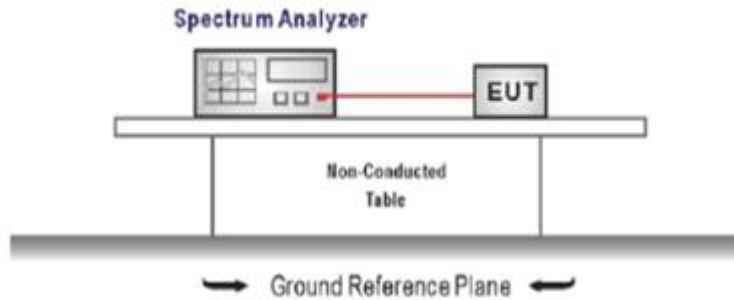

TEST PROCEDURE

1. The transmitter output was connected to the spectrum analyzer through an attenuator, the path loss was compensated to the results for each measurement.
2. Set to the maximum power setting and enable the EUT transmit continuously
3. Use the following spectrum analyzer settings:
Span = approximately 2 to 3 times the 20 dB bandwidth, centered on a hopping channel
RBW \geq 1% of the 20 dB bandwidth, VBW \geq RBW
Sweep = auto, Detector function = peak, Trace = max hold
4. Measure and record the results in the test report.

TEST MODE:

Please refer to the clause 3.3

TEST RESULTS

 Passed Not Applicable

Modulation type	Channel	20 dB Bandwidth (MHz)	Limit (MHz)	Result
GFSK	00	0.93	-	Pass
	39	0.93		
	78	0.93		
$\pi/4$ DQPSK	00	1.29	-	Pass
	39	1.29		
	78	1.29		
8DPSK	00	1.28	-	Pass
	39	1.28		
	78	1.28		

Modulation Type:		GFSK																												
CH00	<p>Spectrum Ref Level 20.00 dBm Offset 1.00 dB RBW 10 kHz Att 30 dB SWT 189.6 μs VBW 30 kHz Mode Auto FFT Count 500/500 IPK View</p> <p>CF 2.402 GHz 1001 pts Span 2.5 MHz</p> <table border="1"> <thead> <tr> <th>Type</th> <th>Ref</th> <th>Trc</th> <th>X-value</th> <th>Y-value</th> <th>Function</th> <th>Function Result</th> </tr> </thead> <tbody> <tr> <td>M1</td> <td>1</td> <td></td> <td>2.401545 GHz</td> <td>-21.99 dBm</td> <td></td> <td></td> </tr> <tr> <td>M2</td> <td>1</td> <td></td> <td>2.402055 GHz</td> <td>-1.35 dBm</td> <td></td> <td></td> </tr> <tr> <td>D3</td> <td>M1</td> <td>1</td> <td>925.0 kHz</td> <td>0.43 db</td> <td></td> <td></td> </tr> </tbody> </table>		Type	Ref	Trc	X-value	Y-value	Function	Function Result	M1	1		2.401545 GHz	-21.99 dBm			M2	1		2.402055 GHz	-1.35 dBm			D3	M1	1	925.0 kHz	0.43 db		
Type	Ref	Trc	X-value	Y-value	Function	Function Result																								
M1	1		2.401545 GHz	-21.99 dBm																										
M2	1		2.402055 GHz	-1.35 dBm																										
D3	M1	1	925.0 kHz	0.43 db																										
CH39	<p>Spectrum Ref Level 20.00 dBm Offset 1.00 dB RBW 10 kHz Att 30 dB SWT 189.6 μs VBW 30 kHz Mode Auto FFT Count 500/500 IPK View</p> <p>CF 2.441 GHz 1001 pts Span 2.5 MHz</p> <table border="1"> <thead> <tr> <th>Type</th> <th>Ref</th> <th>Trc</th> <th>X-value</th> <th>Y-value</th> <th>Function</th> <th>Function Result</th> </tr> </thead> <tbody> <tr> <td>M1</td> <td>1</td> <td></td> <td>2.440545 GHz</td> <td>-22.41 dBm</td> <td></td> <td></td> </tr> <tr> <td>M2</td> <td>1</td> <td></td> <td>2.441055 GHz</td> <td>-1.75 dBm</td> <td></td> <td></td> </tr> <tr> <td>D3</td> <td>M1</td> <td>1</td> <td>925.0 kHz</td> <td>0.37 db</td> <td></td> <td></td> </tr> </tbody> </table>		Type	Ref	Trc	X-value	Y-value	Function	Function Result	M1	1		2.440545 GHz	-22.41 dBm			M2	1		2.441055 GHz	-1.75 dBm			D3	M1	1	925.0 kHz	0.37 db		
Type	Ref	Trc	X-value	Y-value	Function	Function Result																								
M1	1		2.440545 GHz	-22.41 dBm																										
M2	1		2.441055 GHz	-1.75 dBm																										
D3	M1	1	925.0 kHz	0.37 db																										
CH78	<p>Spectrum Ref Level 20.00 dBm Offset 1.00 dB RBW 10 kHz Att 30 dB SWT 189.6 μs VBW 30 kHz Mode Auto FFT Count 500/500 IPK View</p> <p>CF 2.48 GHz 1001 pts Span 2.5 MHz</p> <table border="1"> <thead> <tr> <th>Type</th> <th>Ref</th> <th>Trc</th> <th>X-value</th> <th>Y-value</th> <th>Function</th> <th>Function Result</th> </tr> </thead> <tbody> <tr> <td>M1</td> <td>1</td> <td></td> <td>2.479545 GHz</td> <td>-22.44 dBm</td> <td></td> <td></td> </tr> <tr> <td>M2</td> <td>1</td> <td></td> <td>2.480055 GHz</td> <td>-1.87 dBm</td> <td></td> <td></td> </tr> <tr> <td>D3</td> <td>M1</td> <td>1</td> <td>925.0 kHz</td> <td>0.26 db</td> <td></td> <td></td> </tr> </tbody> </table>		Type	Ref	Trc	X-value	Y-value	Function	Function Result	M1	1		2.479545 GHz	-22.44 dBm			M2	1		2.480055 GHz	-1.87 dBm			D3	M1	1	925.0 kHz	0.26 db		
Type	Ref	Trc	X-value	Y-value	Function	Function Result																								
M1	1		2.479545 GHz	-22.44 dBm																										
M2	1		2.480055 GHz	-1.87 dBm																										
D3	M1	1	925.0 kHz	0.26 db																										

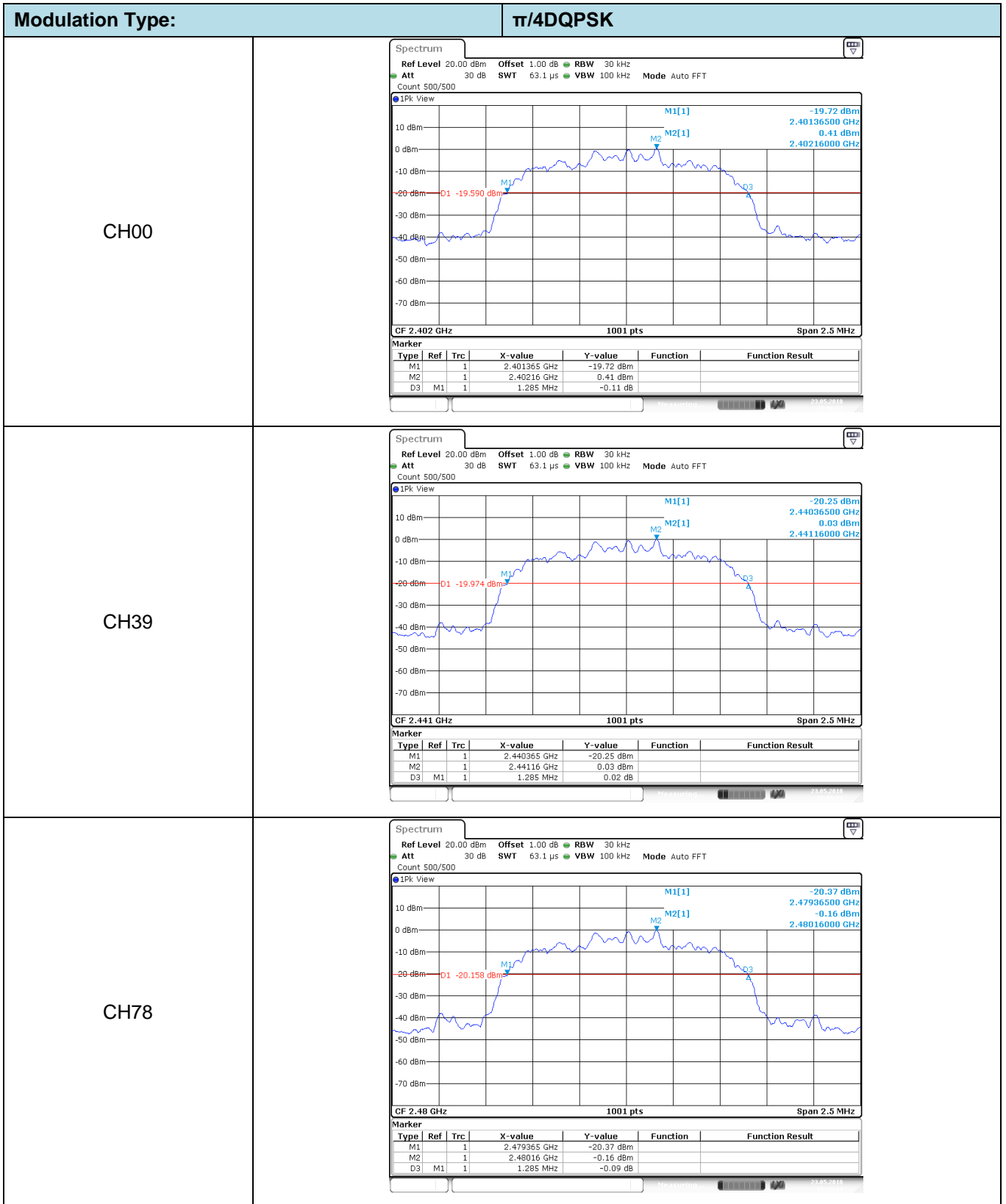

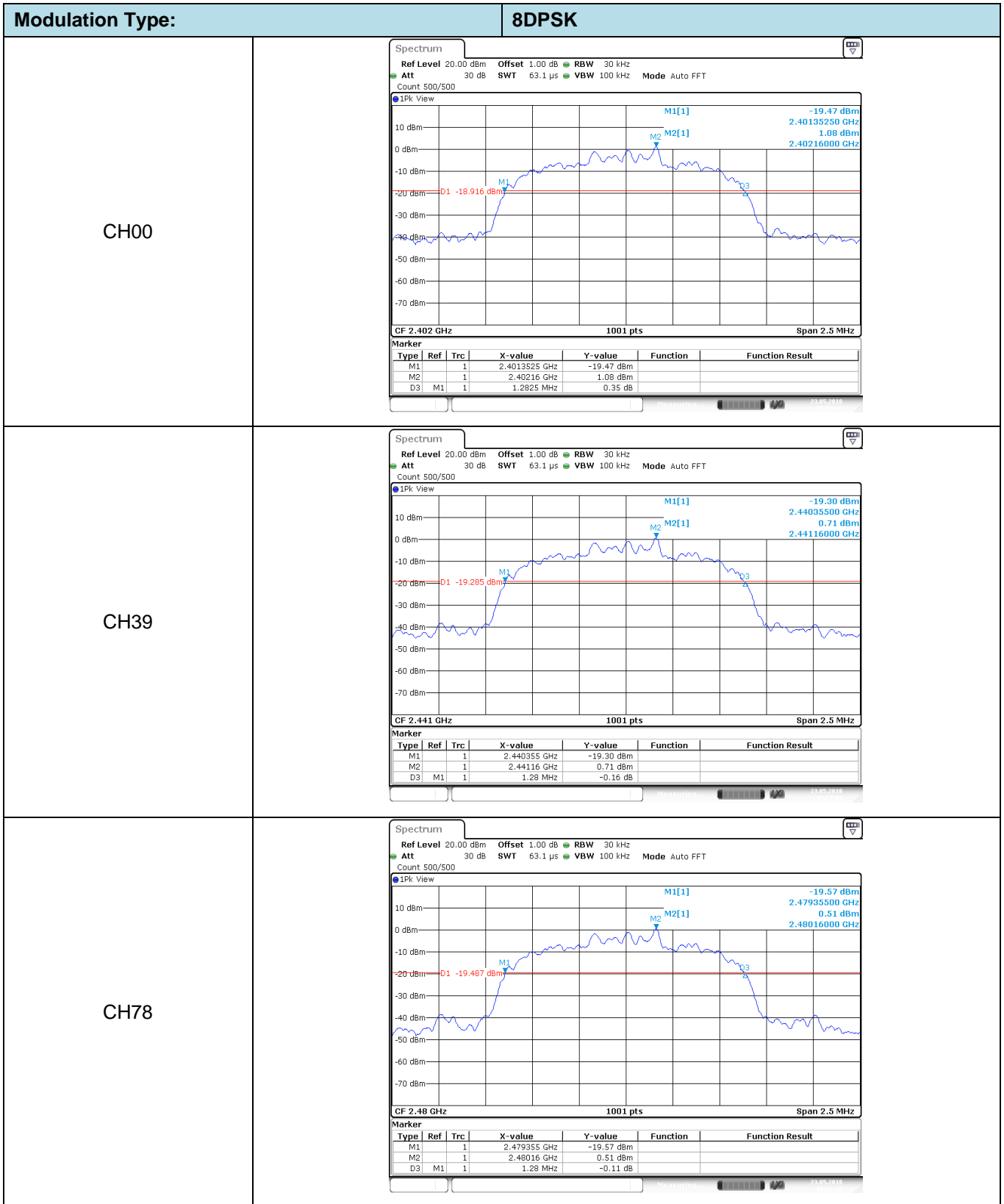

5.5. Carrier Frequencies Separation

LIMIT

FCC CFR Title 47 Part 15 Subpart C Section 15.247 (a)(1):

Frequency hopping systems shall have hopping channel carrier frequencies separated by a minimum of 25 kHz or the 20 dB bandwidth of the hopping channel, whichever is greater. Alternatively, Frequency hopping systems operating in the 2400-2483.5 MHz band may have hopping channel carrier frequencies that are separated by 25 kHz or two-thirds of the 20 dB bandwidth of the hopping channel, whichever is greater, provided the systems operate with an output power no greater than 125 mW.

TEST CONFIGURATION

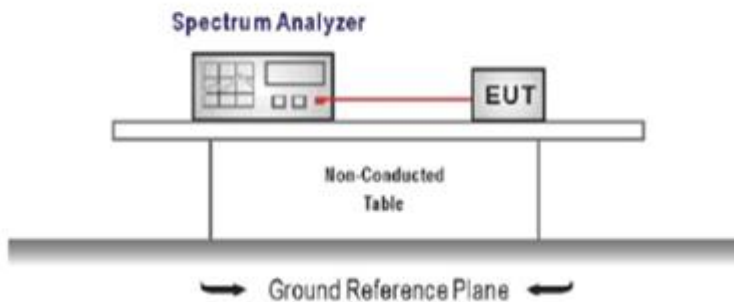

TEST PROCEDURE

1. The transmitter output was connected to the spectrum analyzer through an attenuator, the path loss was compensated to the results for each measurement.
2. Set to the maximum power setting and enable the EUT transmit continuously
3. Use the following spectrum analyzer settings:
 Span = wide enough to capture the peaks of two adjacent channels
 RBW ≥ 1% of the span, VBW ≥ RBW
 Sweep = auto, Detector function = peak, Trace = max hold
4. Measure and record the results in the test report.

TEST MODE:

Please refer to the clause 3.3

TEST RESULTS

Passed Not Applicable

Modulation type	Channel	Carrier Frequencies Separation (MHz)	Limit (MHz) *	Result
GFSK	39	1.00	≥0.93	Pass
π/4DQPSK	39	1.00	≥0.86	Pass
8DPSK	39	1.00	≥0.85	Pass

Note:

*: GFSK limit = The maximum 20 dB Bandwidth for GFSK modulation on the section 5.4.

π/4DQPSK limit = 2/3 * The maximum 20 dB Bandwidth for π/4DQPSK modulation on the section 5.4.

8DPSK limit = 2/3 * The maximum 20 dB Bandwidth for 8DPSK modulation on the section 5.4

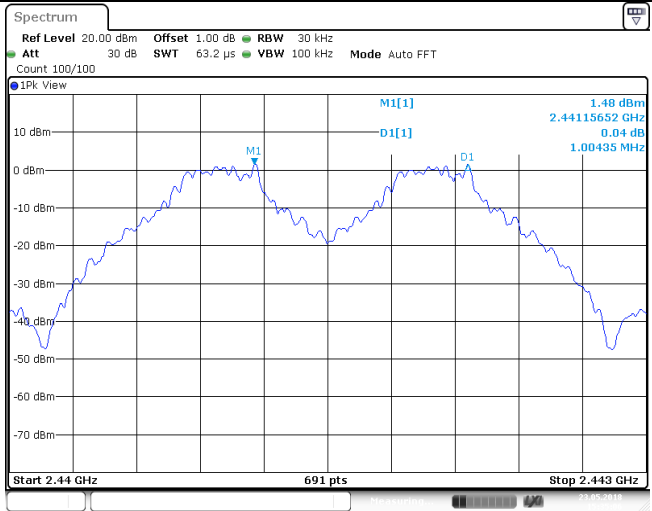
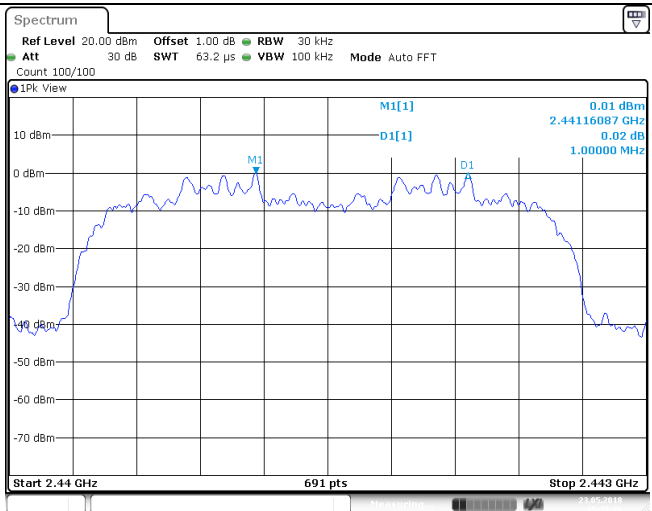
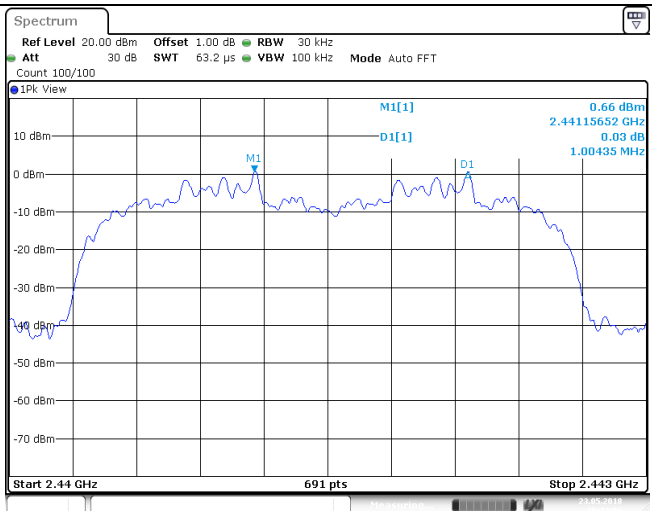
<p>GFSK</p>	
<p>$\pi/4$DQPSK</p>	
<p>8DPSK</p>	

5.6. Hopping Channel Number

LIMIT

FCC CFR Title 47 Part 15 Subpart C Section 15.247 (a)(1): Frequency hopping systems in the 2400–2483.5 MHz band shall use at least **15** channels.

TEST CONFIGURATION

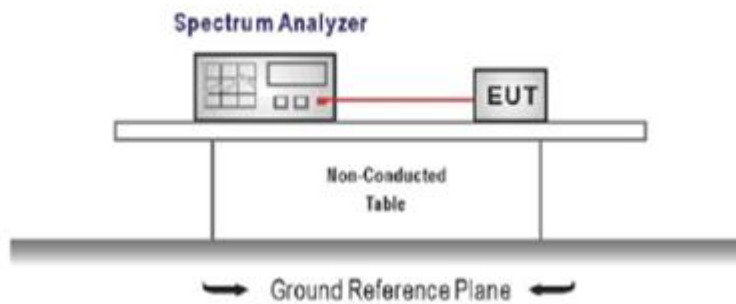

TEST PROCEDURE

1. The transmitter output was connected to the spectrum analyzer through an attenuator, the path loss was compensated to the results for each measurement.
2. Set to the maximum power setting and enable the EUT transmit continuously
3. Use the following spectrum analyzer settings:
 Span = the frequency band of operation
 RBW \geq 1% of the span, VBW \geq RBW
 Sweep = auto, Detector function = peak, Trace = max hold
4. Measure and record the results in the test report.

TEST MODE:

Please refer to the clause 3.3

TEST RESULTS

Passed Not Applicable

Modulation type	Channel number	Limit	Result
GFSK	79	≥ 15.00	Pass
$\pi/4$ DQPSK	79		
8DPSK	79		

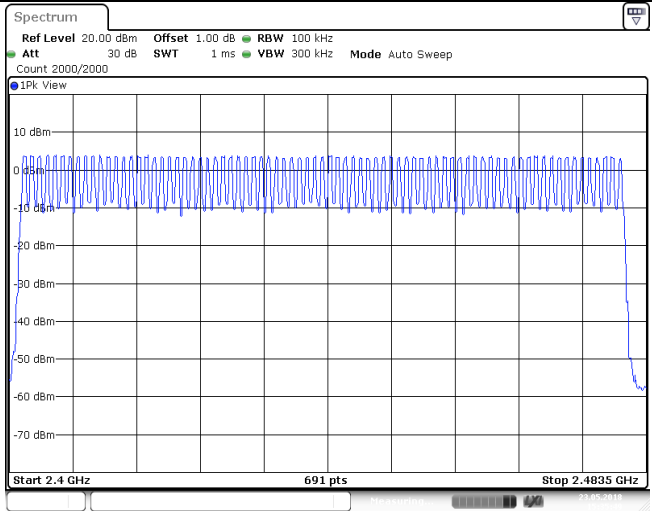
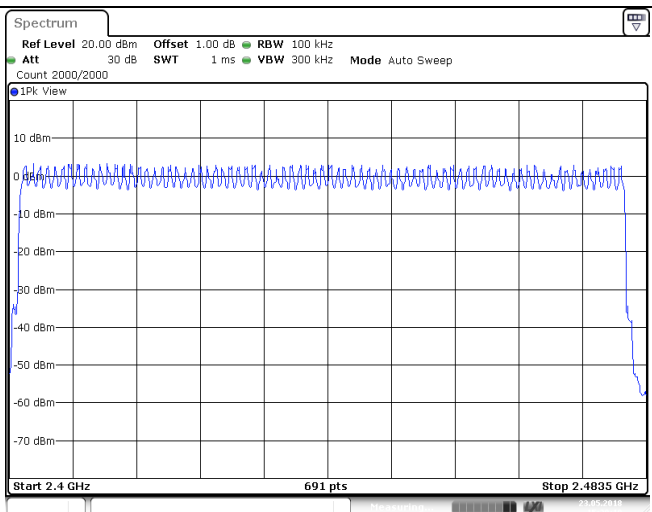
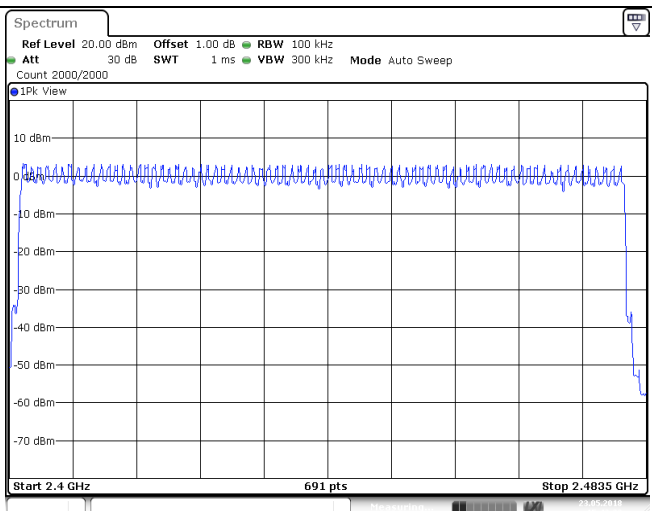
<p>GFSK</p>	
<p>$\pi/4$DQPSK</p>	
<p>8DPSK</p>	

5.7. Dwell Time

LIMIT

FCC CFR Title 47 Part 15 Subpart C Section 15.247 (a)(1):The average time of occupancy on any channel shall not be greater than 0.4 seconds within a pe-riod of 0.4 seconds multiplied by the number of hopping channels employed.

TEST CONFIGURATION

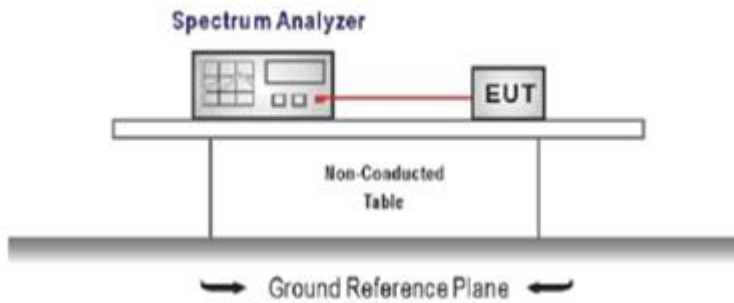

TEST PROCEDURE

1. The transmitter output was connected to the spectrum analyzer through an attenuator, the path loss was compensated to the results for each measurement.
2. Set to the maximum power setting and enable the EUT transmit continuously
3. Use the following spectrum analyzer settings:
 Span = zero span, centered on a hopping channel, RBW= 1 MHz, VBW ≥ RBW
 Sweep = as necessary to capture the entire dwell time per hopping channel,
 Detector function = peak, Trace = max hold
4. Measure and record the results in the test report.

TEST MODE:

Please refer to the clause 3.3

TEST RESULTS

Passed Not Applicable

Modulation type	Channel	Burst Width [ms/hop/ch]	Total Hops[hop*ch]	Dwell time (Second)	Limit (Second)	Result
GFSK	DH1	0.38	316.00	0.12	≤ 0.40	Pass
	DH3	1.63	163.00	0.27		
	DH5	2.88	102.00	0.29		
π/4DQPSK	2DH1	0.38	315.00	0.12	≤ 0.40	Pass
	2DH3	1.64	158.00	0.26		
	2DH5	2.89	103.00	0.30		
8DPSK	3DH1	0.39	314.00	0.12	≤ 0.40	Pass
	3DH3	1.63	158.00	0.26		
	3DH5	2.89	116.00	0.34		

Modulation Type: GFSK	
DH1 Burst width	
DH1 Burst number	
DH3 Burst width	

DH3
Burst number

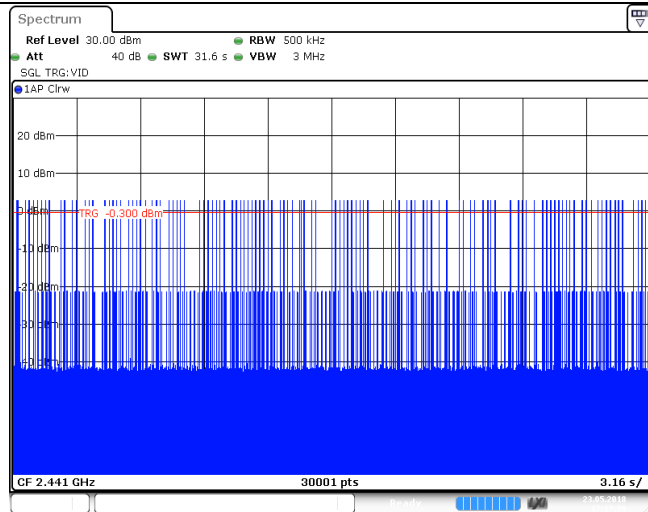

DH5
Burst width

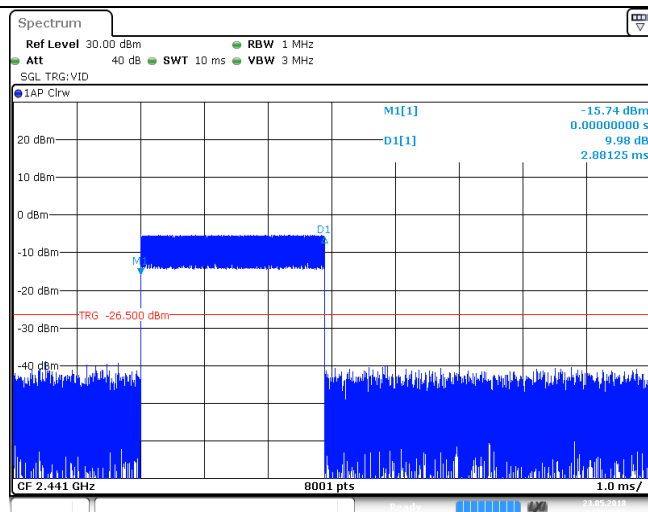

DH5
Burst number

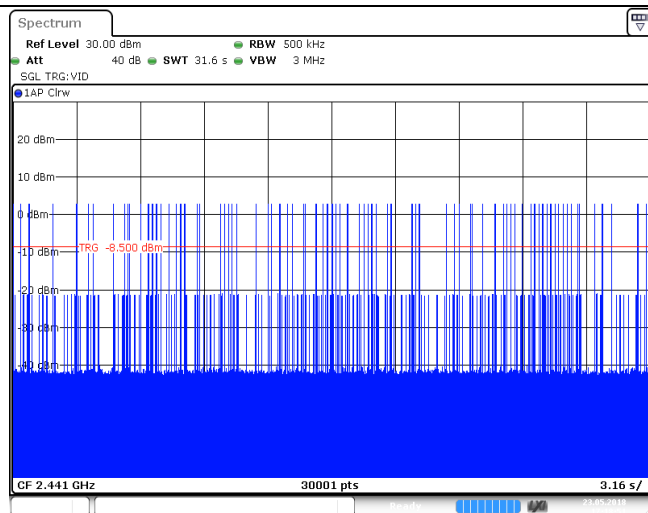

Modulation Type:		$\pi/4$ DQPSK
2DH1 Burst width		
2DH1 Burst number		
2DH3 Burst width		

2DH3
Burst number

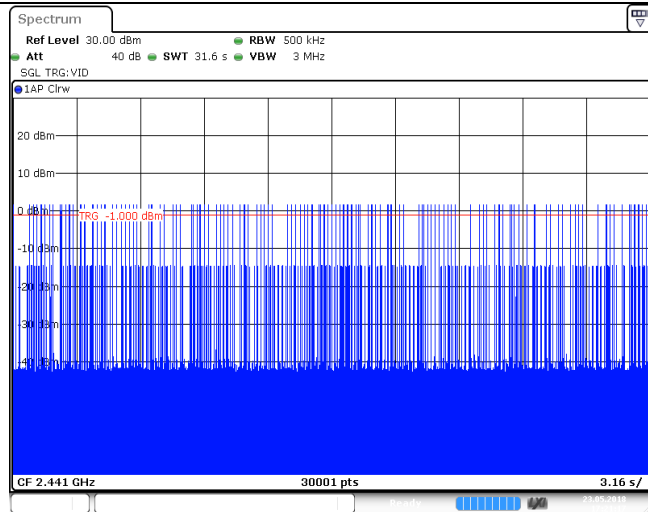

2DH5
Burst width

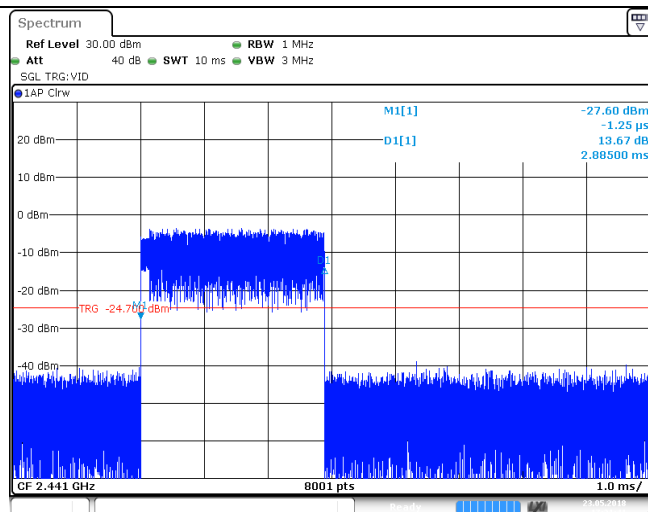

2DH5
Burst number

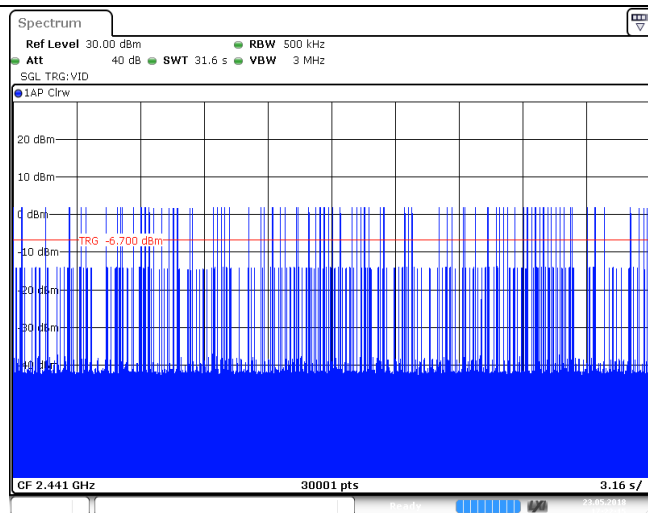

Modulation Type:		$\pi/4$ DQPSK
3DH1 Burst width		
3DH1 Burst number		
3DH3 Burst width		

3DH3
Burst number

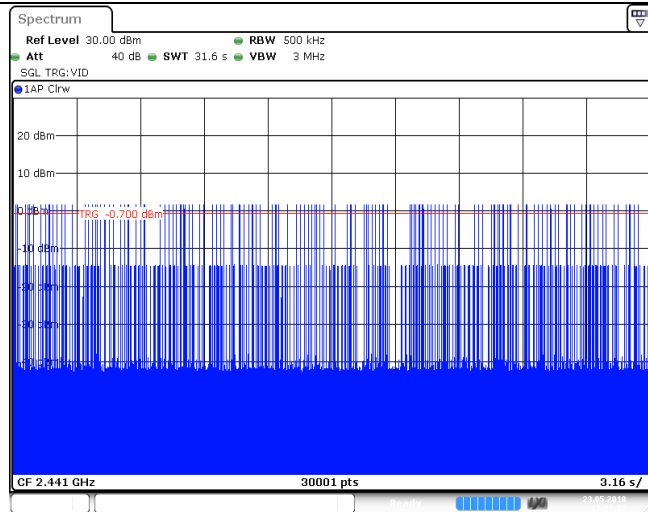

3DH5
Burst width

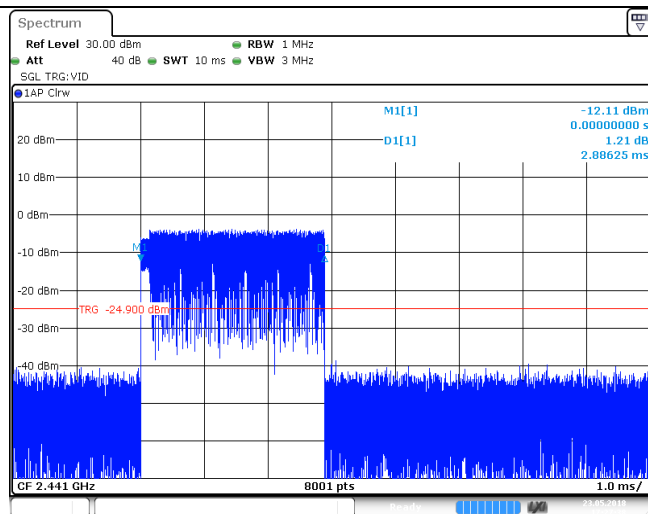

3DH5
Burst number

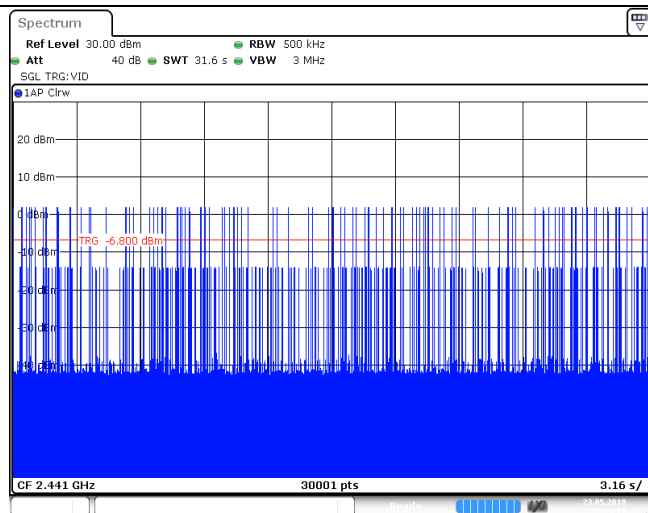

5.8. Pseudorandom Frequency Hopping Sequence

LIMIT

FCC CFR Title 47 Part 15 Subpart C Section 15.247 (a)(1):Frequency hopping systems shall have hopping channel carrier frequencies separated by a minimum of 25 kHz or the 20 dB bandwidth of the hopping channel, whichever is greater. Alternatively, frequency hopping systems operating in the 2400–2483.5 MHz band may have hopping channel carrier frequencies that are separated by 25 kHz or two-thirds of the 20 dB bandwidth of the hopping channel, whichever is greater, provided the systems operate with an output power no greater than 125 mW. The system shall hop to channel frequencies that are selected at the system hopping rate from a pseudo randomly ordered list of hopping frequencies. Each frequency must be used equally on the average by each transmitter. The system receivers shall have input bandwidths that match the hopping channel bandwidths of their corresponding transmitters and shall shift frequencies in synchronization with the transmitted signals.

TEST RESULTS

The pseudorandom frequency hopping sequence may be generated in a nine-stage shift register whose 5th and 9th stage outputs are added in a modulo-two addition stage. And the result is fed back to the input of the first stage. The sequence begins with the first one of 9 consecutive ones, for example: the shift register is initialized with nine ones.

- Number of shift register stages: 9
- Length of pseudo-random sequence: $2^9 - 1 = 511$ bits
- Longest sequence of zeros: 8 (non-inverted signal)

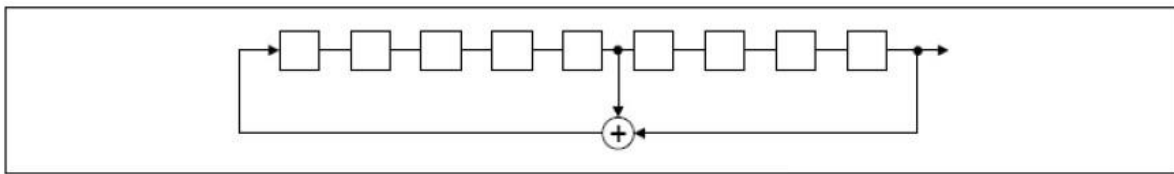

Linear Feedback Shift Register for Generation of the PRBS sequence

An example of pseudorandom frequency hopping sequence as follows:

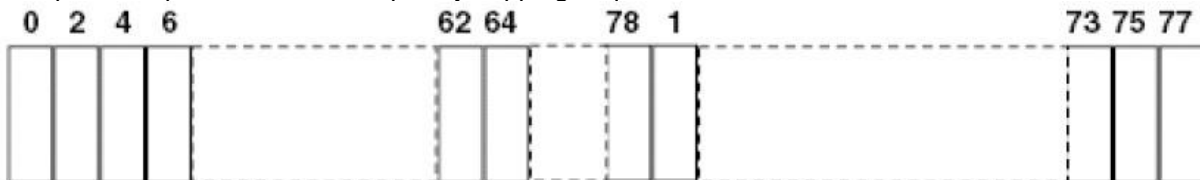

Each frequency used equally on the average by each transmitter. The system receiver has input bandwidths that match the hopping channel bandwidths of their corresponding transmitter and shift frequencies in synchronization with the transmitted signals.

5.9. Restricted band (radiated)

LIMIT

FCC CFR Title 47 Part 15 Subpart C Section 15.247 (d):

In any 100 kHz bandwidth outside the frequency band in which the spread spectrum or digitally modulated intentional radiator is operating, Radiated Emissions which fall in the restricted bands, as defined in §15.205(a), must also comply with the Radiated Emissions limits specified in §15.209(a) (see §15.205(c)).

TEST CONFIGURATION

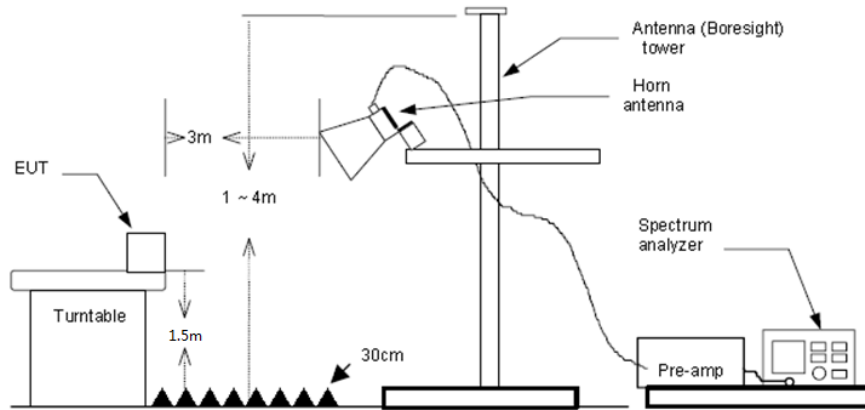

TEST PROCEDURE

1. The EUT was setup and tested according to ANSI C63.10:2013 for compliance to FCC 47CFR 15.247 requirements.
2. The EUT is placed on a turn table which is 1.5 meter above ground. The turn table is rotated 360 degrees to determine the position of the maximum emission level.
3. The EUT was positioned such that the distance from antenna to the EUT was 3 meters.
4. The antenna is scanned from 1 meter to 4 meters to find out the maximum emission level. This is repeated for both horizontal and vertical polarization of the antenna. In order to find the maximum emission, all of the interface cables were manipulated according to ANSI C63.10:2013 on radiated measurement.
5. The receiver set as follow:
 RBW=1 MHz, VBW=3 MHz Peak detector for Peak value
 RBW=1 MHz, VBW=10 Hz Peak detector for Average value.

TEST MODE:

Please refer to the clause 3.3

TEST RESULTS

Passed Not Applicable

Note:

- 1) Final level= Read level + Antenna Factor+ Cable Loss- Preamp Factor
- 2) Have pre-scan all modulation mode, found the GFSK modulation which it was worst case, so only the worst case's data on the test report.
- 3) The peak level is lower than average limit(54 dBuV/m), this data is the too weak instrument of signal is unable to test.

Test channel:					CH00				
Frequency (MHz)	Read Level (dBuV)	Antenna Factor (dB/m)	Cable Loss (dB)	Preamp Factor (dB)	Level (dBuV/m)	Limit Line (dBuV/m)	Over Limit (dB)	Polarization	Test value
2310.00	34.03	28.05	6.62	37.59	31.11	74.00	-42.89	Vertical	Peak
2389.83	62.44	27.65	6.75	37.59	59.25	74.00	-14.75	Vertical	Peak
2310.00	32.15	28.05	6.62	37.59	29.23	74.00	-44.77	Horizontal	Peak
2390.13	61.54	27.65	6.75	37.59	58.35	74.00	-15.65	Horizontal	Peak
2310.00	21.78	28.05	6.62	37.59	18.86	54.00	-35.14	Vertical	Average
2390.03	21.66	27.65	6.75	37.59	18.47	54.00	-35.53	Vertical	Average
2310.00	20.27	28.05	6.62	37.59	17.35	54.00	-36.65	Horizontal	Average
2390.03	20.45	27.65	6.75	37.59	17.26	54.00	-36.74	Horizontal	Average

Test channel:					CH78				
Frequency (MHz)	Read Level (dBuV)	Antenna Factor (dB/m)	Cable Loss (dB)	Preamp Factor (dB)	Level (dBuV/m)	Limit Line (dBuV/m)	Over Limit (dB)	Polarization	Test value
2483.47	60.94	27.26	6.83	37.59	57.44	74.00	-16.56	Vertical	Peak
2500.00	32.58	27.20	6.84	37.59	29.03	74.00	-44.97	Vertical	Peak
2483.47	56.55	27.26	6.83	37.59	53.05	74.00	-20.95	Horizontal	Peak
2500.00	32.93	27.20	6.84	37.59	29.38	74.00	-44.62	Horizontal	Peak
2483.47	26.50	27.26	6.83	37.59	23.00	54.00	-31.00	Vertical	Average
2500.00	20.38	27.20	6.84	37.59	16.83	54.00	-37.17	Vertical	Average
2483.47	25.66	27.26	6.83	37.59	22.16	54.00	-31.84	Horizontal	Average
2500.00	20.08	27.20	6.84	37.59	16.53	54.00	-37.47	Horizontal	Average

5.10. Band edge and Spurious Emissions (conducted)

LIMIT

FCC CFR Title 47 Part 15 Subpart C Section 15.247 (d): In any 100 kHz bandwidth outside the frequency band in which the spread spectrum intentional radiator is operating, the radio frequency power that is produced by the intentional radiator shall be at least 20 dB below that in the 100 kHz bandwidth within the band that contains the highest level of the desired power, based on either an RF conducted or a radiated measurement.

TEST CONFIGURATION

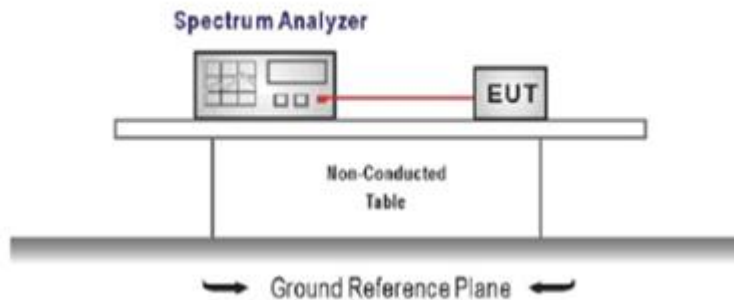

TEST PROCEDURE

1. The transmitter output was connected to the spectrum analyzer through an attenuator, the path loss was compensated to the results for each measurement.
2. Set to the maximum power setting and enable the EUT transmit continuously
3. Use the following spectrum analyzer settings:
RBW = 100 kHz, VBW \geq RBW, scan up through 10th harmonic.
Sweep = auto, Detector function = peak, Trace = max hold
4. Measure and record the results in the test report.

TEST MODE:

Please refer to the clause 3.3

TEST RESULTS

Passed Not Applicable

Test Item:	Band edge	Modulation type:	GFSK																																										
<p>CH00 No hopping mode</p>	<p>Ref Level 20.00 dBm Offset 1.00 dB RBW 100 kHz Att 30 dB SWT 1.1 ms VBW 300 kHz Mode Auto Sweep Count 500/500</p> <p>Start 2.31 GHz 691 pts Stop 2.405 GHz</p> <table border="1"> <thead> <tr> <th>Type</th> <th>Ref</th> <th>Trc</th> <th>X-value</th> <th>Y-value</th> <th>Function</th> <th>Function Result</th> </tr> </thead> <tbody> <tr> <td>M1</td> <td>1</td> <td></td> <td>2.40218 GHz</td> <td>3.84 dBm</td> <td></td> <td></td> </tr> <tr> <td>M2</td> <td>1</td> <td></td> <td>2.4 GHz</td> <td>-53.00 dBm</td> <td></td> <td></td> </tr> <tr> <td>M3</td> <td>1</td> <td></td> <td>2.39 GHz</td> <td>-59.17 dBm</td> <td></td> <td></td> </tr> <tr> <td>M4</td> <td>1</td> <td></td> <td>2.31 GHz</td> <td>-59.57 dBm</td> <td></td> <td></td> </tr> <tr> <td>M5</td> <td>1</td> <td></td> <td>2.399906 GHz</td> <td>-56.60 dBm</td> <td></td> <td></td> </tr> </tbody> </table>			Type	Ref	Trc	X-value	Y-value	Function	Function Result	M1	1		2.40218 GHz	3.84 dBm			M2	1		2.4 GHz	-53.00 dBm			M3	1		2.39 GHz	-59.17 dBm			M4	1		2.31 GHz	-59.57 dBm			M5	1		2.399906 GHz	-56.60 dBm		
Type	Ref	Trc	X-value	Y-value	Function	Function Result																																							
M1	1		2.40218 GHz	3.84 dBm																																									
M2	1		2.4 GHz	-53.00 dBm																																									
M3	1		2.39 GHz	-59.17 dBm																																									
M4	1		2.31 GHz	-59.57 dBm																																									
M5	1		2.399906 GHz	-56.60 dBm																																									
<p>CH00 Hopping mode</p>	<p>Ref Level 20.00 dBm Offset 1.00 dB RBW 100 kHz Att 30 dB SWT 1.1 ms VBW 300 kHz Mode Auto Sweep Count 500/500</p> <p>Start 2.31 GHz 691 pts Stop 2.405 GHz</p> <table border="1"> <thead> <tr> <th>Type</th> <th>Ref</th> <th>Trc</th> <th>X-value</th> <th>Y-value</th> <th>Function</th> <th>Function Result</th> </tr> </thead> <tbody> <tr> <td>M1</td> <td>1</td> <td></td> <td>2.40287 GHz</td> <td>3.53 dBm</td> <td></td> <td></td> </tr> <tr> <td>M2</td> <td>1</td> <td></td> <td>2.4 GHz</td> <td>-58.00 dBm</td> <td></td> <td></td> </tr> <tr> <td>M3</td> <td>1</td> <td></td> <td>2.39 GHz</td> <td>-59.49 dBm</td> <td></td> <td></td> </tr> <tr> <td>M4</td> <td>1</td> <td></td> <td>2.31 GHz</td> <td>-59.11 dBm</td> <td></td> <td></td> </tr> <tr> <td>M5</td> <td>1</td> <td></td> <td>2.349652 GHz</td> <td>-56.89 dBm</td> <td></td> <td></td> </tr> </tbody> </table>			Type	Ref	Trc	X-value	Y-value	Function	Function Result	M1	1		2.40287 GHz	3.53 dBm			M2	1		2.4 GHz	-58.00 dBm			M3	1		2.39 GHz	-59.49 dBm			M4	1		2.31 GHz	-59.11 dBm			M5	1		2.349652 GHz	-56.89 dBm		
Type	Ref	Trc	X-value	Y-value	Function	Function Result																																							
M1	1		2.40287 GHz	3.53 dBm																																									
M2	1		2.4 GHz	-58.00 dBm																																									
M3	1		2.39 GHz	-59.49 dBm																																									
M4	1		2.31 GHz	-59.11 dBm																																									
M5	1		2.349652 GHz	-56.89 dBm																																									
<p>CH78 No hopping mode</p>	<p>Ref Level 20.00 dBm Offset 1.00 dB RBW 100 kHz Att 30 dB SWT 56.9 μs VBW 300 kHz Mode Auto FFT Count 500/500</p> <p>Start 2.478 GHz 691 pts Stop 2.5 GHz</p> <table border="1"> <thead> <tr> <th>Type</th> <th>Ref</th> <th>Trc</th> <th>X-value</th> <th>Y-value</th> <th>Function</th> <th>Function Result</th> </tr> </thead> <tbody> <tr> <td>M1</td> <td>1</td> <td></td> <td>2.480149 GHz</td> <td>3.69 dBm</td> <td></td> <td></td> </tr> <tr> <td>M2</td> <td>1</td> <td></td> <td>2.4835 GHz</td> <td>-58.79 dBm</td> <td></td> <td></td> </tr> <tr> <td>M3</td> <td>1</td> <td></td> <td>2.5 GHz</td> <td>-60.23 dBm</td> <td></td> <td></td> </tr> <tr> <td>M4</td> <td>1</td> <td></td> <td>2.4987884 GHz</td> <td>-57.12 dBm</td> <td></td> <td></td> </tr> </tbody> </table>			Type	Ref	Trc	X-value	Y-value	Function	Function Result	M1	1		2.480149 GHz	3.69 dBm			M2	1		2.4835 GHz	-58.79 dBm			M3	1		2.5 GHz	-60.23 dBm			M4	1		2.4987884 GHz	-57.12 dBm									
Type	Ref	Trc	X-value	Y-value	Function	Function Result																																							
M1	1		2.480149 GHz	3.69 dBm																																									
M2	1		2.4835 GHz	-58.79 dBm																																									
M3	1		2.5 GHz	-60.23 dBm																																									
M4	1		2.4987884 GHz	-57.12 dBm																																									

CH78
Hopping mode

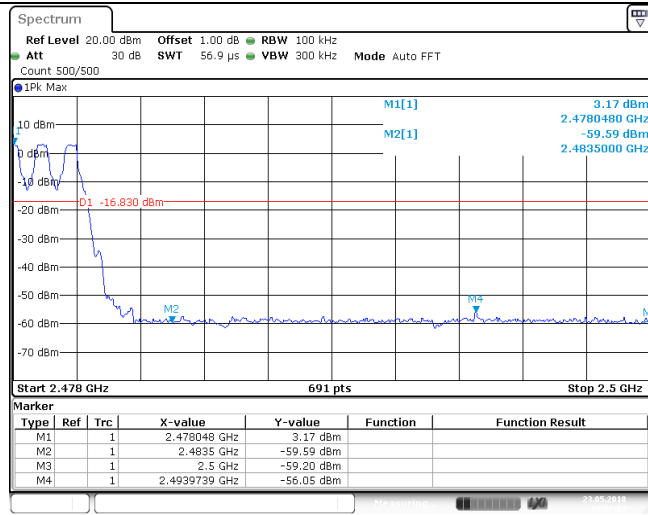

Test Item:	Band edge	Modulation type:	$\pi/4$ DQPSK																																										
<p>CH00 No hopping mode</p>	<p>Spectrum</p> <p>Ref Level 20.00 dBm Offset 1.00 dB RBW 100 kHz Att 30 dB SWT 1.1 ms VBW 300 kHz Mode Auto Sweep Count 500/500</p> <p>IPK Max</p> <p>M1[1] 2.95 dBm 2.401770 GHz M2[1] -50.92 dBm 2.400000 GHz</p> <p>D1 -17.050 dBm</p> <p>Start 2.31 GHz 691 pts Stop 2.405 GHz</p> <table border="1"> <thead> <tr> <th>Type</th> <th>Ref</th> <th>Trc</th> <th>X-value</th> <th>Y-value</th> <th>Function</th> <th>Function Result</th> </tr> </thead> <tbody> <tr> <td>M1</td> <td>1</td> <td></td> <td>2.40177 GHz</td> <td>2.95 dBm</td> <td></td> <td></td> </tr> <tr> <td>M2</td> <td>1</td> <td></td> <td>2.4 GHz</td> <td>-50.92 dBm</td> <td></td> <td></td> </tr> <tr> <td>M3</td> <td>1</td> <td></td> <td>2.39 GHz</td> <td>-58.55 dBm</td> <td></td> <td></td> </tr> <tr> <td>M4</td> <td>1</td> <td></td> <td>2.31 GHz</td> <td>-57.85 dBm</td> <td></td> <td></td> </tr> <tr> <td>M5</td> <td>1</td> <td></td> <td>2.399906 GHz</td> <td>-51.43 dBm</td> <td></td> <td></td> </tr> </tbody> </table>			Type	Ref	Trc	X-value	Y-value	Function	Function Result	M1	1		2.40177 GHz	2.95 dBm			M2	1		2.4 GHz	-50.92 dBm			M3	1		2.39 GHz	-58.55 dBm			M4	1		2.31 GHz	-57.85 dBm			M5	1		2.399906 GHz	-51.43 dBm		
Type	Ref	Trc	X-value	Y-value	Function	Function Result																																							
M1	1		2.40177 GHz	2.95 dBm																																									
M2	1		2.4 GHz	-50.92 dBm																																									
M3	1		2.39 GHz	-58.55 dBm																																									
M4	1		2.31 GHz	-57.85 dBm																																									
M5	1		2.399906 GHz	-51.43 dBm																																									
<p>CH00 Hopping mode</p>	<p>Spectrum</p> <p>Ref Level 20.00 dBm Offset 1.00 dB RBW 100 kHz Att 30 dB SWT 1.1 ms VBW 300 kHz Mode Auto Sweep Count 500/500</p> <p>IPK Max</p> <p>M1[1] 2.40 dBm 2.402870 GHz M2[1] -51.75 dBm 2.400000 GHz</p> <p>D1 -17.600 dBm</p> <p>Start 2.31 GHz 691 pts Stop 2.405 GHz</p> <table border="1"> <thead> <tr> <th>Type</th> <th>Ref</th> <th>Trc</th> <th>X-value</th> <th>Y-value</th> <th>Function</th> <th>Function Result</th> </tr> </thead> <tbody> <tr> <td>M1</td> <td>1</td> <td></td> <td>2.40287 GHz</td> <td>2.40 dBm</td> <td></td> <td></td> </tr> <tr> <td>M2</td> <td>1</td> <td></td> <td>2.4 GHz</td> <td>-51.75 dBm</td> <td></td> <td></td> </tr> <tr> <td>M3</td> <td>1</td> <td></td> <td>2.39 GHz</td> <td>-58.60 dBm</td> <td></td> <td></td> </tr> <tr> <td>M4</td> <td>1</td> <td></td> <td>2.31 GHz</td> <td>-58.97 dBm</td> <td></td> <td></td> </tr> <tr> <td>M5</td> <td>1</td> <td></td> <td>2.399906 GHz</td> <td>-53.27 dBm</td> <td></td> <td></td> </tr> </tbody> </table>			Type	Ref	Trc	X-value	Y-value	Function	Function Result	M1	1		2.40287 GHz	2.40 dBm			M2	1		2.4 GHz	-51.75 dBm			M3	1		2.39 GHz	-58.60 dBm			M4	1		2.31 GHz	-58.97 dBm			M5	1		2.399906 GHz	-53.27 dBm		
Type	Ref	Trc	X-value	Y-value	Function	Function Result																																							
M1	1		2.40287 GHz	2.40 dBm																																									
M2	1		2.4 GHz	-51.75 dBm																																									
M3	1		2.39 GHz	-58.60 dBm																																									
M4	1		2.31 GHz	-58.97 dBm																																									
M5	1		2.399906 GHz	-53.27 dBm																																									
<p>CH78 No hopping mode</p>	<p>Spectrum</p> <p>Ref Level 20.00 dBm Offset 1.00 dB RBW 100 kHz Att 30 dB SWT 56.9 μs VBW 300 kHz Mode Auto FFT Count 500/500</p> <p>IPK Max</p> <p>M1[1] 2.54 dBm 2.479831 GHz M2[1] -59.34 dBm 2.4835000 GHz</p> <p>D1 -17.460 dBm</p> <p>Start 2.478 GHz 691 pts Stop 2.5 GHz</p> <table border="1"> <thead> <tr> <th>Type</th> <th>Ref</th> <th>Trc</th> <th>X-value</th> <th>Y-value</th> <th>Function</th> <th>Function Result</th> </tr> </thead> <tbody> <tr> <td>M1</td> <td>1</td> <td></td> <td>2.479831 GHz</td> <td>2.54 dBm</td> <td></td> <td></td> </tr> <tr> <td>M2</td> <td>1</td> <td></td> <td>2.4835 GHz</td> <td>-59.34 dBm</td> <td></td> <td></td> </tr> <tr> <td>M3</td> <td>1</td> <td></td> <td>2.5 GHz</td> <td>-58.36 dBm</td> <td></td> <td></td> </tr> <tr> <td>M4</td> <td>1</td> <td></td> <td>2.4857797 GHz</td> <td>-56.94 dBm</td> <td></td> <td></td> </tr> </tbody> </table>			Type	Ref	Trc	X-value	Y-value	Function	Function Result	M1	1		2.479831 GHz	2.54 dBm			M2	1		2.4835 GHz	-59.34 dBm			M3	1		2.5 GHz	-58.36 dBm			M4	1		2.4857797 GHz	-56.94 dBm									
Type	Ref	Trc	X-value	Y-value	Function	Function Result																																							
M1	1		2.479831 GHz	2.54 dBm																																									
M2	1		2.4835 GHz	-59.34 dBm																																									
M3	1		2.5 GHz	-58.36 dBm																																									
M4	1		2.4857797 GHz	-56.94 dBm																																									

CH78
Hopping mode

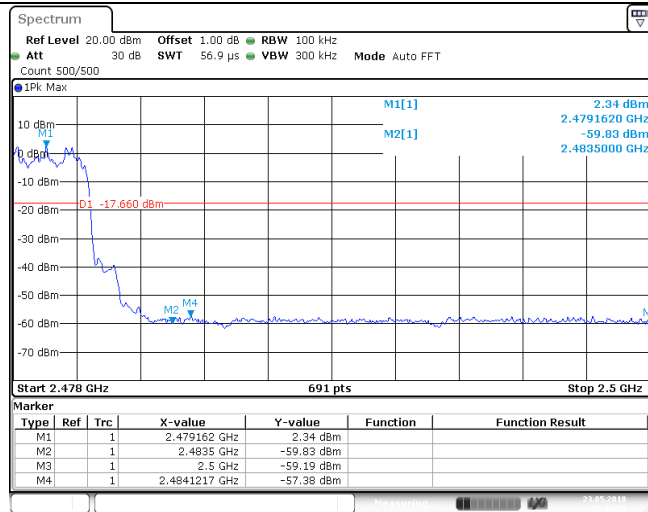

Test Item:	Band edge	Modulation type:	8DPSK																																										
<p>CH00 No hopping mode</p>	<table border="1"> <thead> <tr> <th>Type</th> <th>Ref</th> <th>Trc</th> <th>X-value</th> <th>Y-value</th> <th>Function</th> <th>Function Result</th> </tr> </thead> <tbody> <tr> <td>M1</td> <td>1</td> <td></td> <td>2.40218 GHz</td> <td>3.07 dBm</td> <td></td> <td></td> </tr> <tr> <td>M2</td> <td>1</td> <td></td> <td>2.4 GHz</td> <td>-51.18 dBm</td> <td></td> <td></td> </tr> <tr> <td>M3</td> <td>1</td> <td></td> <td>2.39 GHz</td> <td>-58.57 dBm</td> <td></td> <td></td> </tr> <tr> <td>M4</td> <td>1</td> <td></td> <td>2.31 GHz</td> <td>-58.59 dBm</td> <td></td> <td></td> </tr> <tr> <td>M5</td> <td>1</td> <td></td> <td>2.399768 GHz</td> <td>-50.02 dBm</td> <td></td> <td></td> </tr> </tbody> </table>			Type	Ref	Trc	X-value	Y-value	Function	Function Result	M1	1		2.40218 GHz	3.07 dBm			M2	1		2.4 GHz	-51.18 dBm			M3	1		2.39 GHz	-58.57 dBm			M4	1		2.31 GHz	-58.59 dBm			M5	1		2.399768 GHz	-50.02 dBm		
Type	Ref	Trc	X-value	Y-value	Function	Function Result																																							
M1	1		2.40218 GHz	3.07 dBm																																									
M2	1		2.4 GHz	-51.18 dBm																																									
M3	1		2.39 GHz	-58.57 dBm																																									
M4	1		2.31 GHz	-58.59 dBm																																									
M5	1		2.399768 GHz	-50.02 dBm																																									
<p>CH00 Hopping mode</p>	<table border="1"> <thead> <tr> <th>Type</th> <th>Ref</th> <th>Trc</th> <th>X-value</th> <th>Y-value</th> <th>Function</th> <th>Function Result</th> </tr> </thead> <tbody> <tr> <td>M1</td> <td>1</td> <td></td> <td>2.40314 GHz</td> <td>3.01 dBm</td> <td></td> <td></td> </tr> <tr> <td>M2</td> <td>1</td> <td></td> <td>2.4 GHz</td> <td>-53.57 dBm</td> <td></td> <td></td> </tr> <tr> <td>M3</td> <td>1</td> <td></td> <td>2.39 GHz</td> <td>-59.23 dBm</td> <td></td> <td></td> </tr> <tr> <td>M4</td> <td>1</td> <td></td> <td>2.31 GHz</td> <td>-58.15 dBm</td> <td></td> <td></td> </tr> <tr> <td>M5</td> <td>1</td> <td></td> <td>2.399768 GHz</td> <td>-52.00 dBm</td> <td></td> <td></td> </tr> </tbody> </table>			Type	Ref	Trc	X-value	Y-value	Function	Function Result	M1	1		2.40314 GHz	3.01 dBm			M2	1		2.4 GHz	-53.57 dBm			M3	1		2.39 GHz	-59.23 dBm			M4	1		2.31 GHz	-58.15 dBm			M5	1		2.399768 GHz	-52.00 dBm		
Type	Ref	Trc	X-value	Y-value	Function	Function Result																																							
M1	1		2.40314 GHz	3.01 dBm																																									
M2	1		2.4 GHz	-53.57 dBm																																									
M3	1		2.39 GHz	-59.23 dBm																																									
M4	1		2.31 GHz	-58.15 dBm																																									
M5	1		2.399768 GHz	-52.00 dBm																																									
<p>CH78 No hopping mode</p>	<table border="1"> <thead> <tr> <th>Type</th> <th>Ref</th> <th>Trc</th> <th>X-value</th> <th>Y-value</th> <th>Function</th> <th>Function Result</th> </tr> </thead> <tbody> <tr> <td>M1</td> <td>1</td> <td></td> <td>2.480149 GHz</td> <td>2.69 dBm</td> <td></td> <td></td> </tr> <tr> <td>M2</td> <td>1</td> <td></td> <td>2.4835 GHz</td> <td>-59.00 dBm</td> <td></td> <td></td> </tr> <tr> <td>M3</td> <td>1</td> <td></td> <td>2.5 GHz</td> <td>-60.19 dBm</td> <td></td> <td></td> </tr> <tr> <td>M4</td> <td>1</td> <td></td> <td>2.4857159 GHz</td> <td>-57.39 dBm</td> <td></td> <td></td> </tr> </tbody> </table>			Type	Ref	Trc	X-value	Y-value	Function	Function Result	M1	1		2.480149 GHz	2.69 dBm			M2	1		2.4835 GHz	-59.00 dBm			M3	1		2.5 GHz	-60.19 dBm			M4	1		2.4857159 GHz	-57.39 dBm									
Type	Ref	Trc	X-value	Y-value	Function	Function Result																																							
M1	1		2.480149 GHz	2.69 dBm																																									
M2	1		2.4835 GHz	-59.00 dBm																																									
M3	1		2.5 GHz	-60.19 dBm																																									
M4	1		2.4857159 GHz	-57.39 dBm																																									

CH78
Hoppig mode

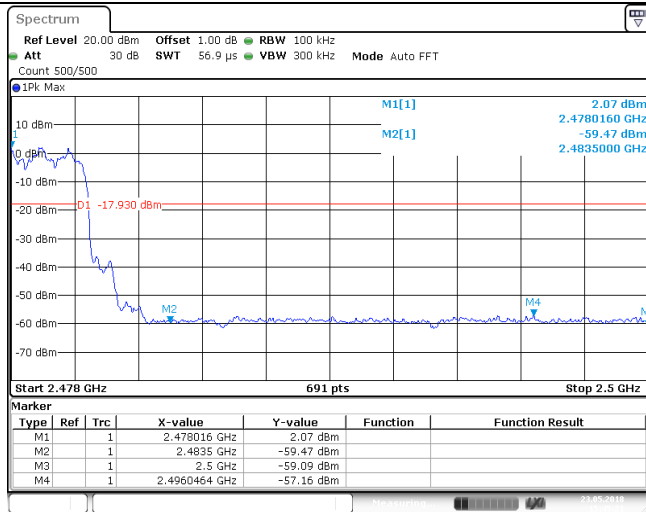

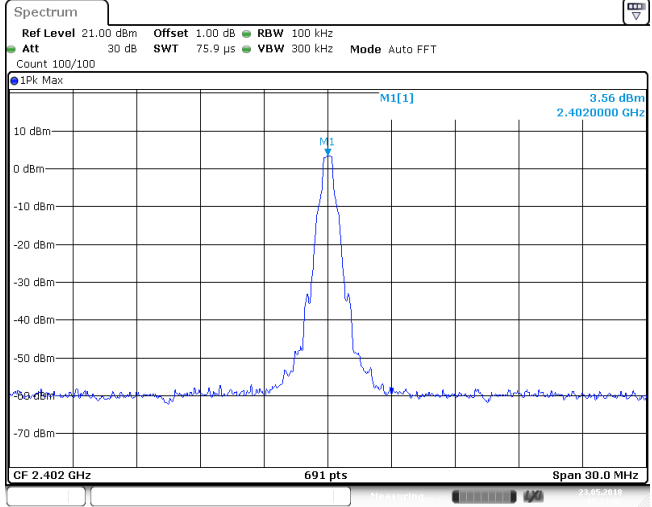
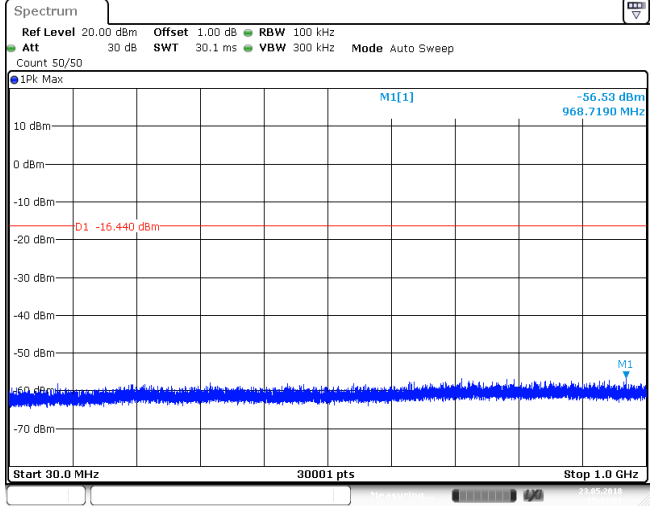
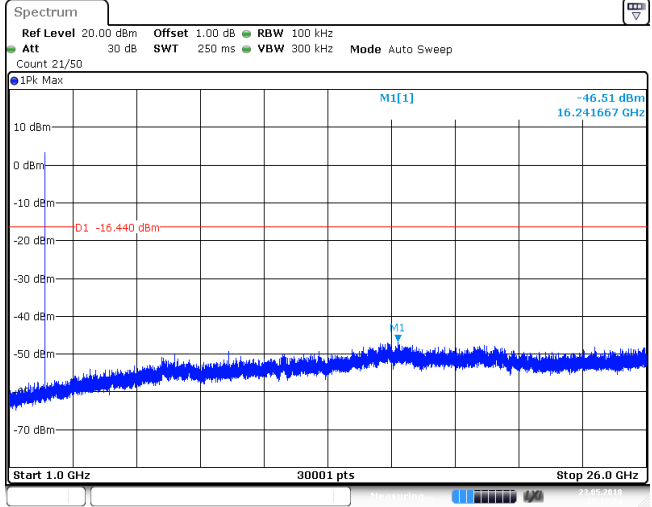
Test Item:	SE	Modulation type:	GFSK
CH00 Reference level			
CH00 30MHz~1000MHz			
CH00 1GHz~26GHz			

CH39
Reference level

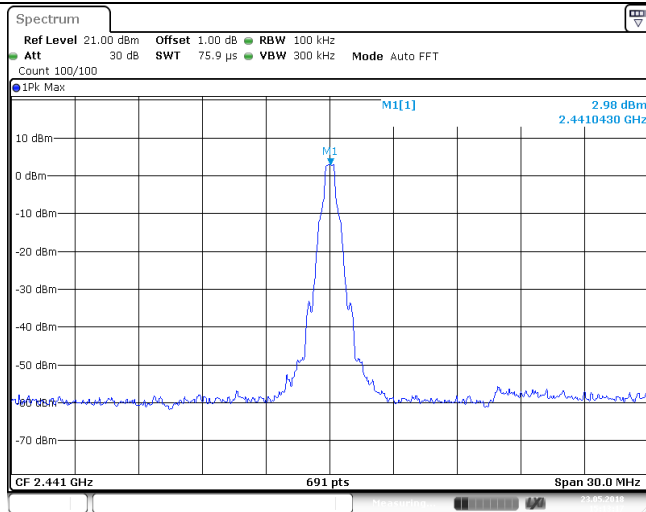

CH39
30MHz~1000MHz

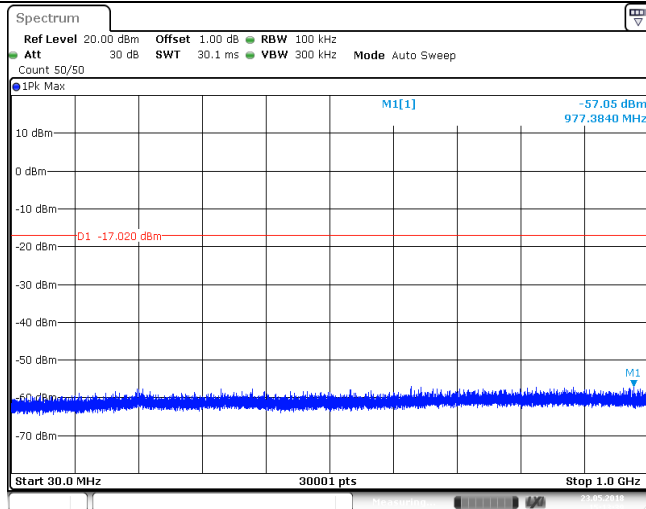

CH39
1GHz~26GHz

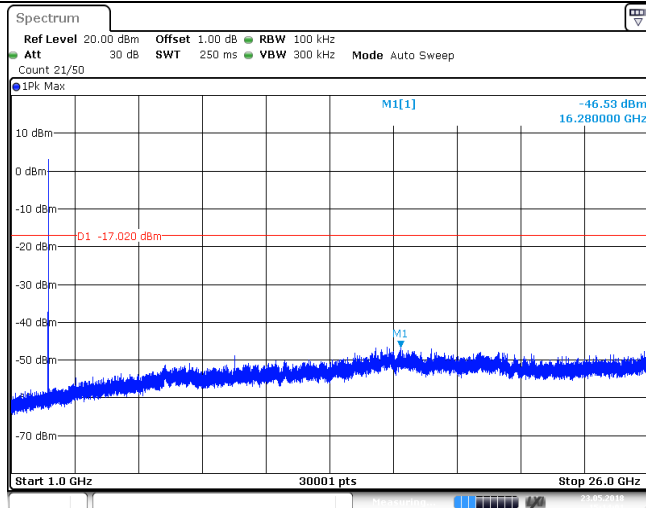

CH78
Reference level

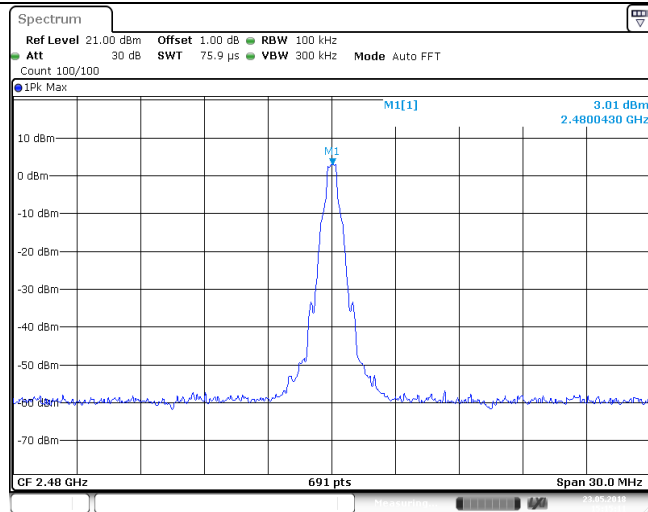

CH78
30MHz~1000MHz

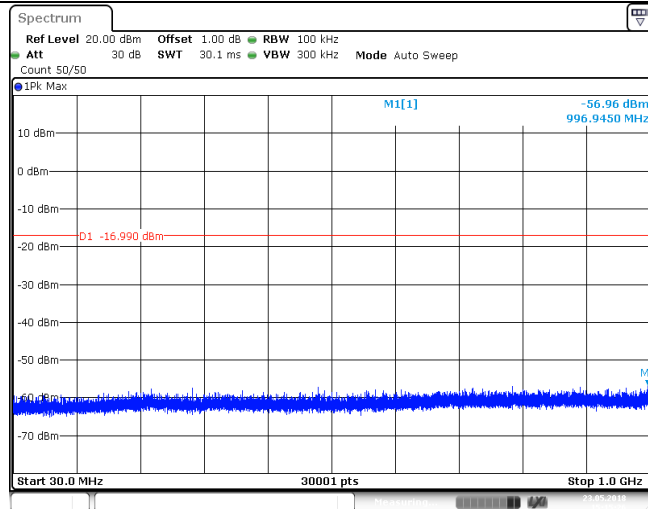

CH78
1GHz~26GHz

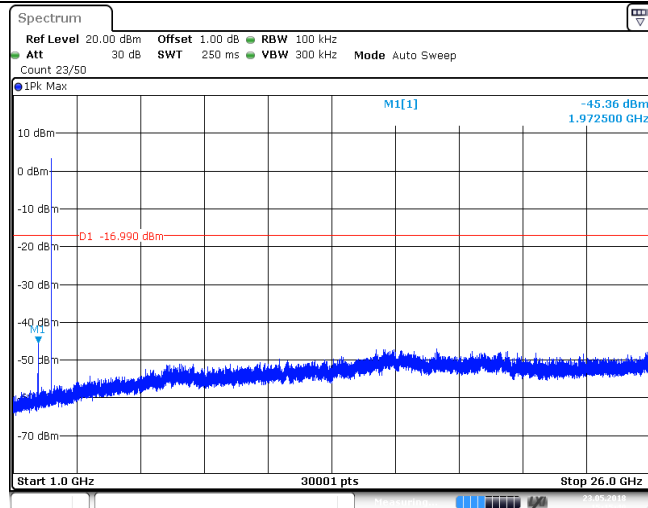

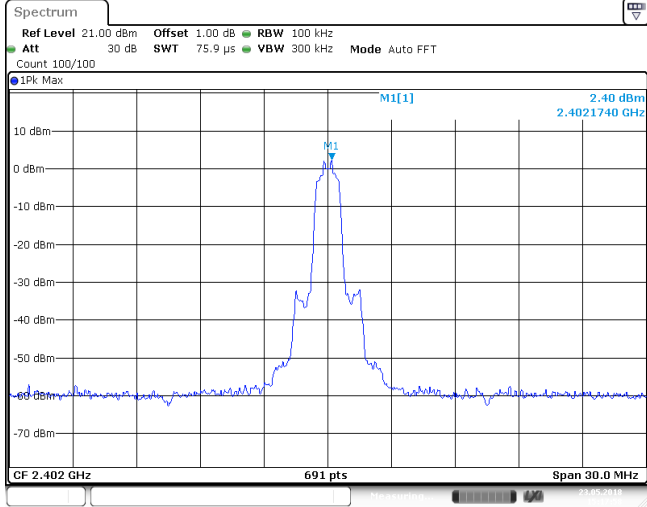
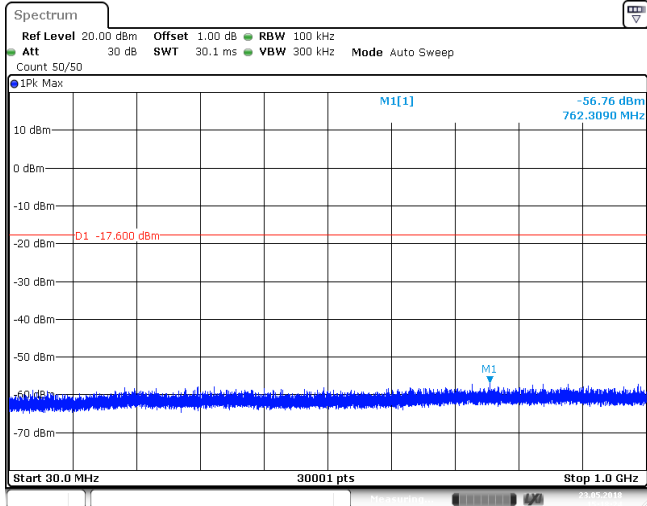
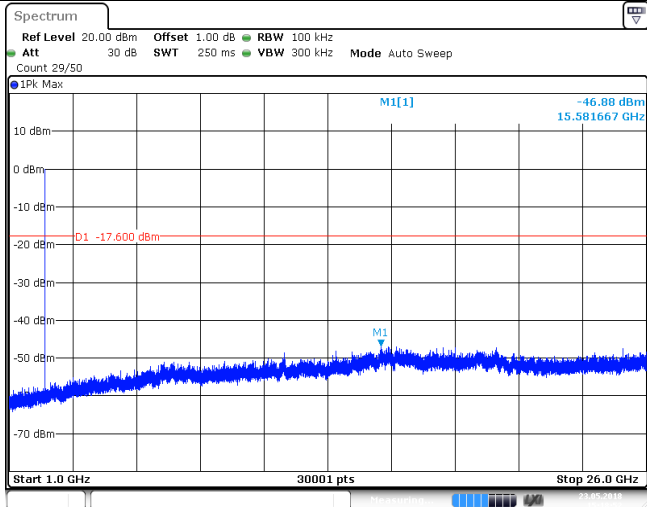
Test Item:	SE	Modulation type:	$\pi/4$ DQPSK
CH00 Reference level			
CH00 30MHz~1000MHz			
CH00 1GHz~26GHz			

CH39
Reference level

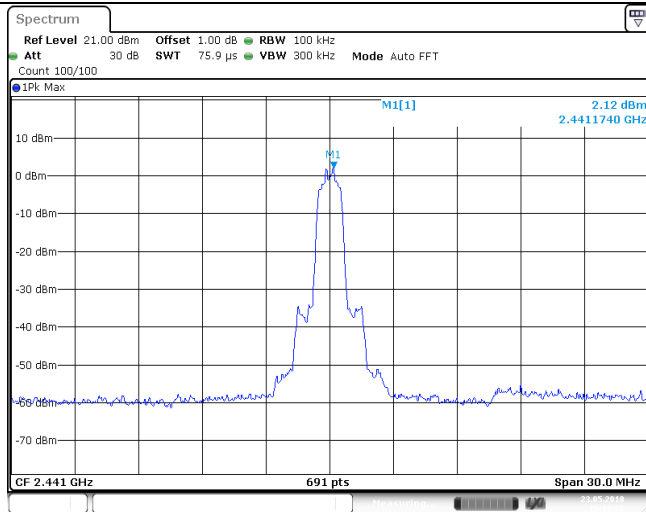

CH39
30MHz~1000MHz

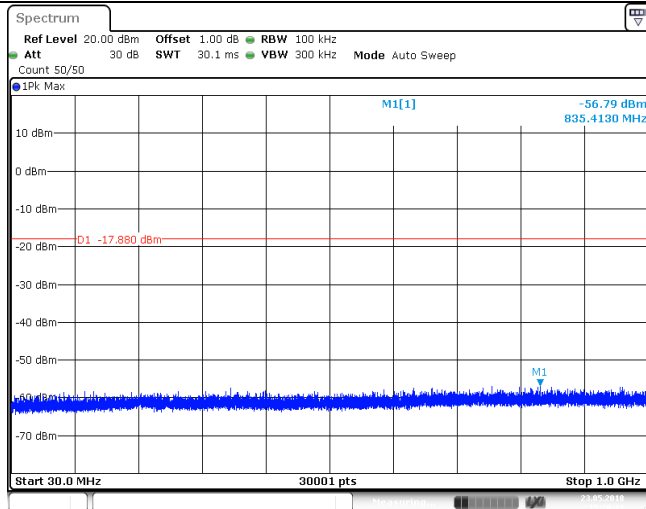

CH39
1GHz~26GHz

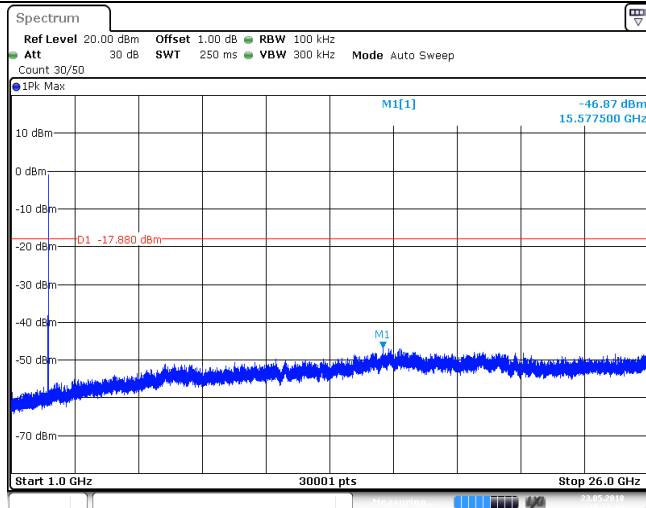

CH78
Reference level

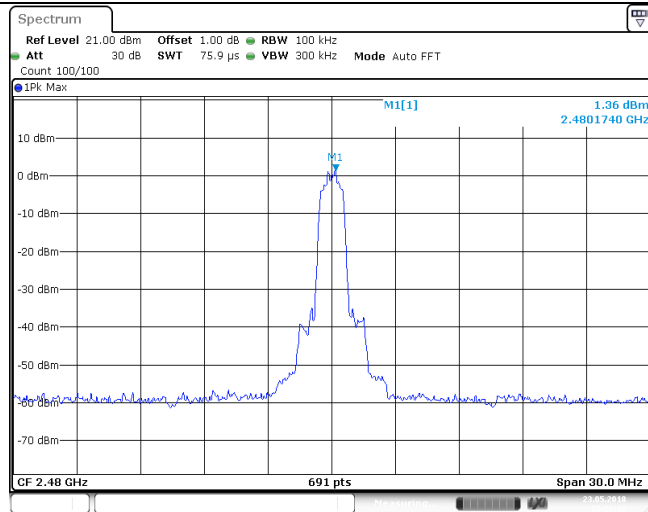

CH78
30MHz~1000MHz

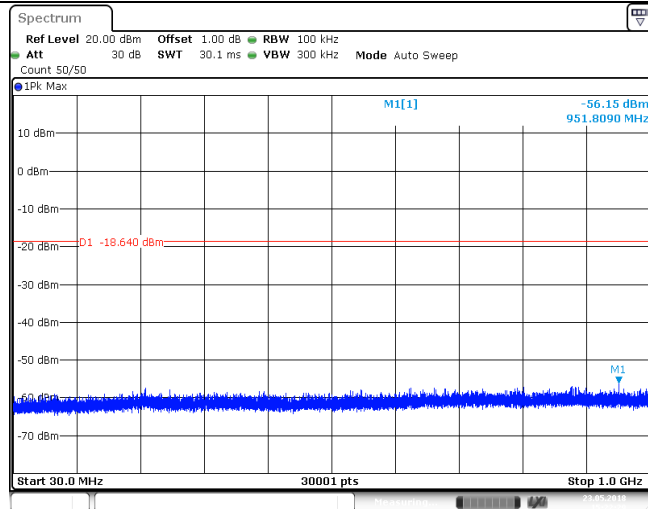

CH78
1GHz~26GHz

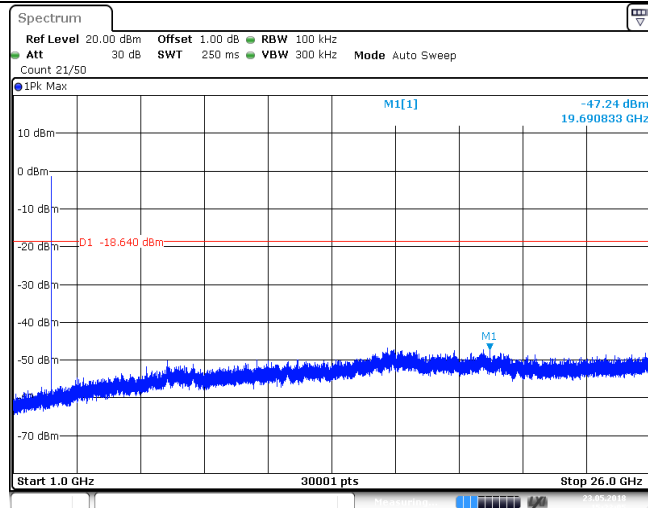

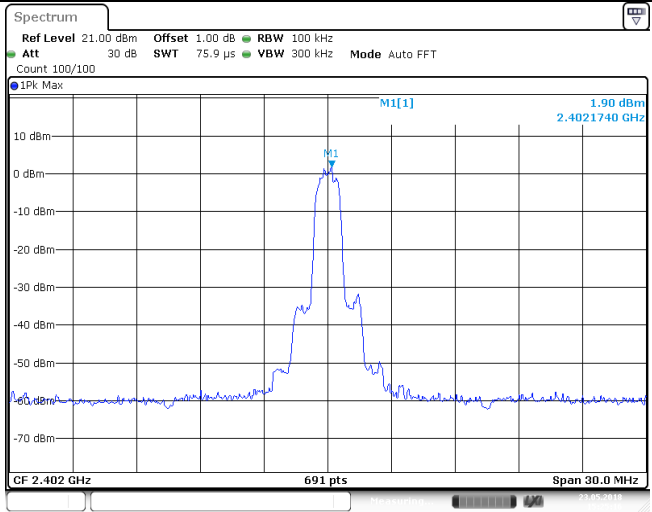
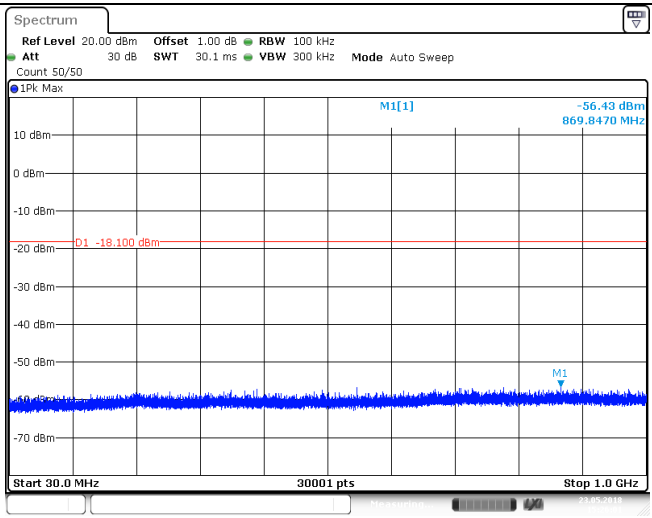
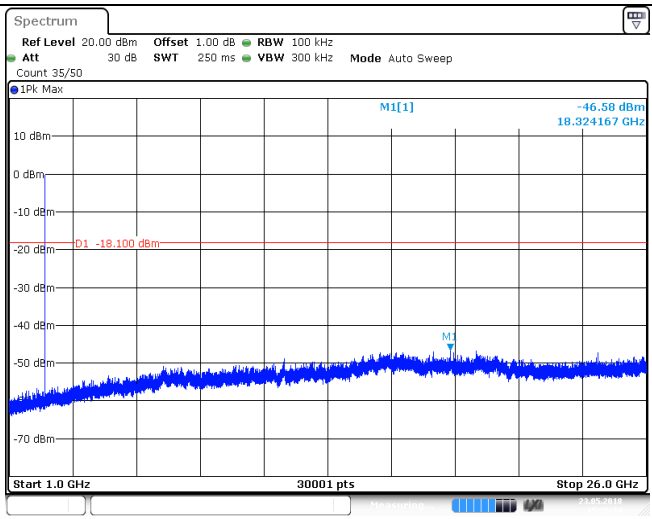
Test Item:	SE	Modulation type:	8DPSK
CH00 Reference level			
CH00 30MHz~1000MHz			
CH00 1GHz~26GHz			

CH39
Reference level

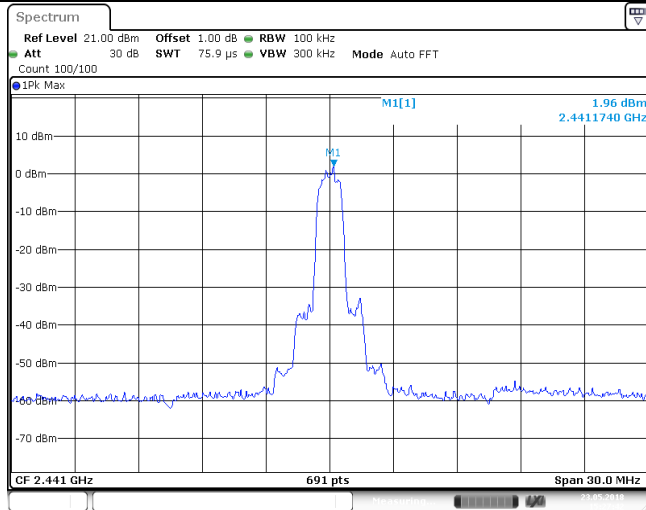

CH39
30MHz~1000MHz

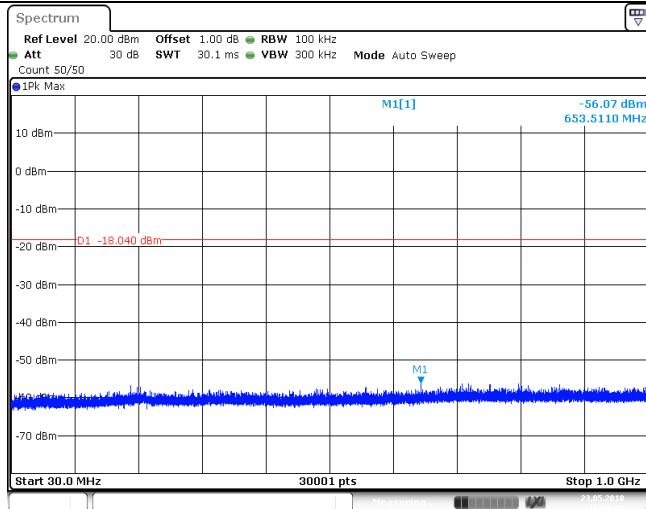

CH39
1GHz~26GHz

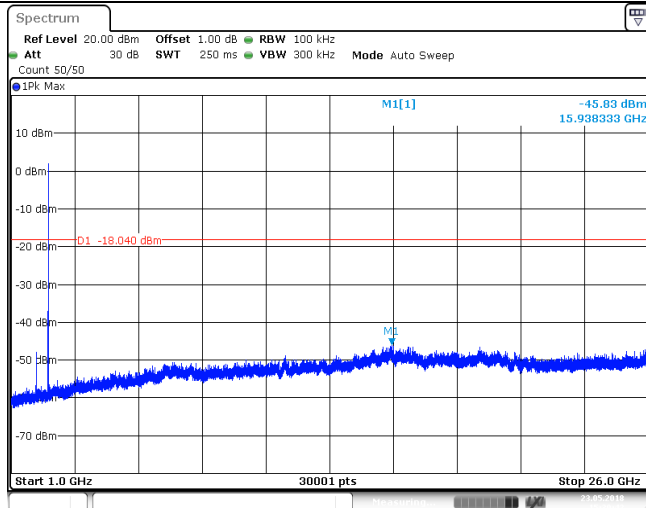

CH78
Reference level

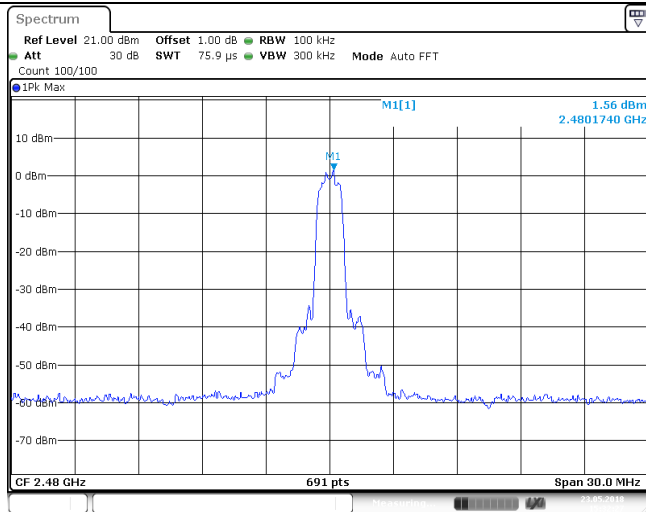

CH78
30MHz~1000MHz

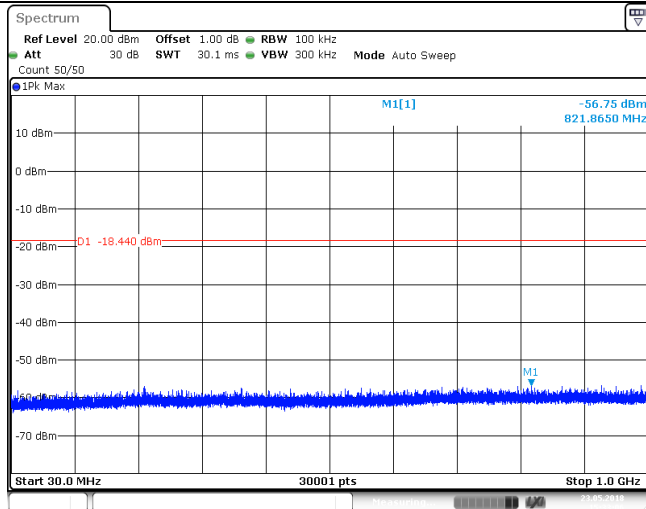

CH78
1GHz~26GHz

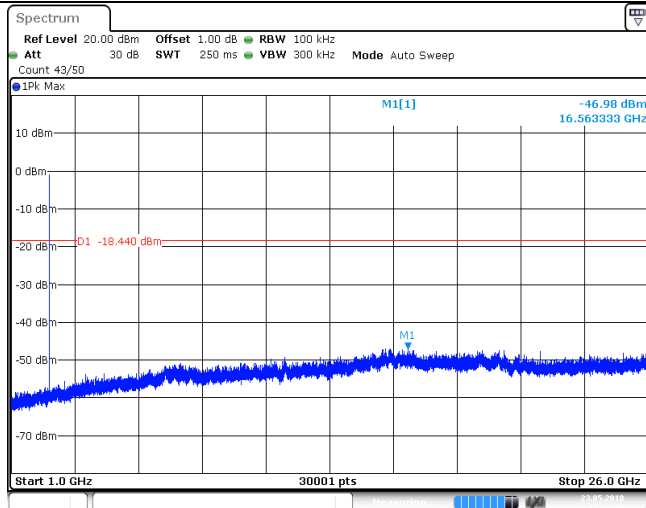

5.11. Spurious Emissions (radiated)

LIMIT

FCC CFR Title 47 Part 15 Subpart C Section 15.209

Frequency	Limit (dBuV/m @3m)	Value
30 MHz ~ 88 MHz	40.00	Quasi-peak
88 MHz ~ 216 MHz	43.50	Quasi-peak
216 MHz ~ 960 MHz	46.00	Quasi-peak
960 MHz ~ 1 GHz	54.00	Quasi-peak
Above 1 GHz	54.00	Average
	74.00	Peak

TEST CONFIGURATION

- Below 30 MHz

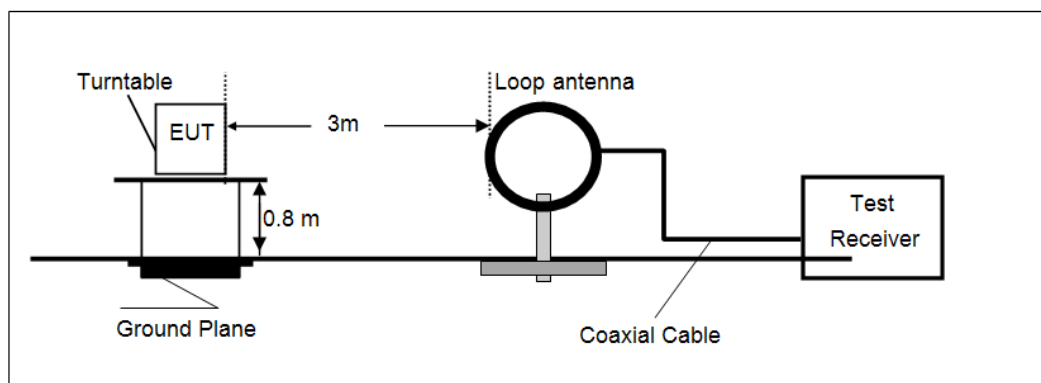

- 30 MHz ~1000 MHz

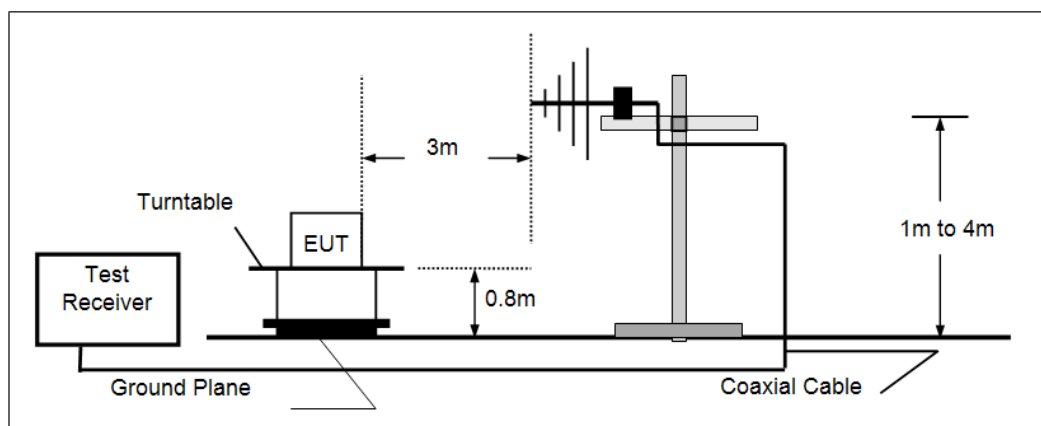

- Above 1 GHz

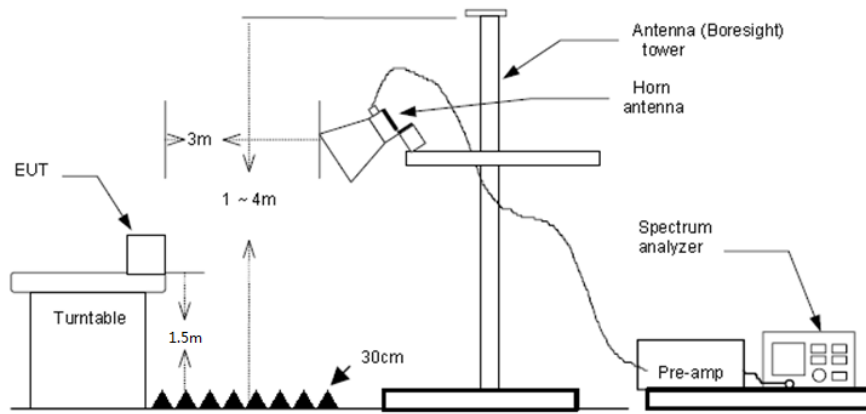

TEST PROCEDURE

1. The EUT was tested according to ANSI C63.10:2013.
2. The EUT is placed on a turn table with 0.8 meter above ground for below 1GHz, 1.5 meter above ground for above 1GHz.
3. The EUT was set 3 meters from the receiving antenna, which was mounted on the top of a variable height antenna tower.
4. For each suspected emission, the EUT was arranged to its worst case and then tune the Antenna tower (from 1 m to 4 m) and turntable (from 0 degree to 360 degrees) to find the maximum reading. A pre-amp and a high pass filter are used for the test in order to get better signal level to comply with the guidelines.
5. Set to the maximum power setting and enable the EUT transmit continuously.
6. Use the following spectrum analyzer settings
 - (1) Span shall wide enough to fully capture the emission being measured;
 - (2) Below 1 GHz:
 - RBW=120 kHz, VBW=300 kHz, Sweep=auto, Detector function=peak, Trace=max hold;
 - If the emission level of the EUT measured by the peak detector is 3 dB lower than the applicable limit, the peak emission level will be reported. Otherwise, the emission measurement will be repeated using the quasi-peak detector and reported.
 - (3) From 1 GHz to 10th harmonic:
 - RBW=1 MHz, VBW=3 MHz Peak detector for Peak value
 - RBW=1 MHz, VBW=10 Hz Peak detector for Average value.

TEST MODE:

Please refer to the clause 3.3

TEST RESULTS

Passed **Not Applicable**

Note:

- 1) Final Level = Receiver Read level + Antenna Factor + Cable Loss – Preamplifier Factor
- 2) The emission levels of other frequencies are very lower than the limit and not show in test report.
- 3) Below 1 GHz, Have pre-scan all modulation mode, found the GFSK modulation High channel which it was worst case, so only the worst case's data on the test report.
- 4) Above 1 GHz, Have pre-scan all modulation mode, found the GFSK modulation which it was worst case, so only the worst case's data on the test report
- 5) The peak level is lower than average limit(54 dBuV/m), this data is the too weak instrument of signal is unable to test.

➤ **9 kHz ~ 30 MHz**

The low frequency, which started from 9 kHz to 30 MHz, was pre-scanned and the result which was 20 dB lower than the limit line per 15.31(o) was not reported.

➤ 30 MHz ~ 1 GHz

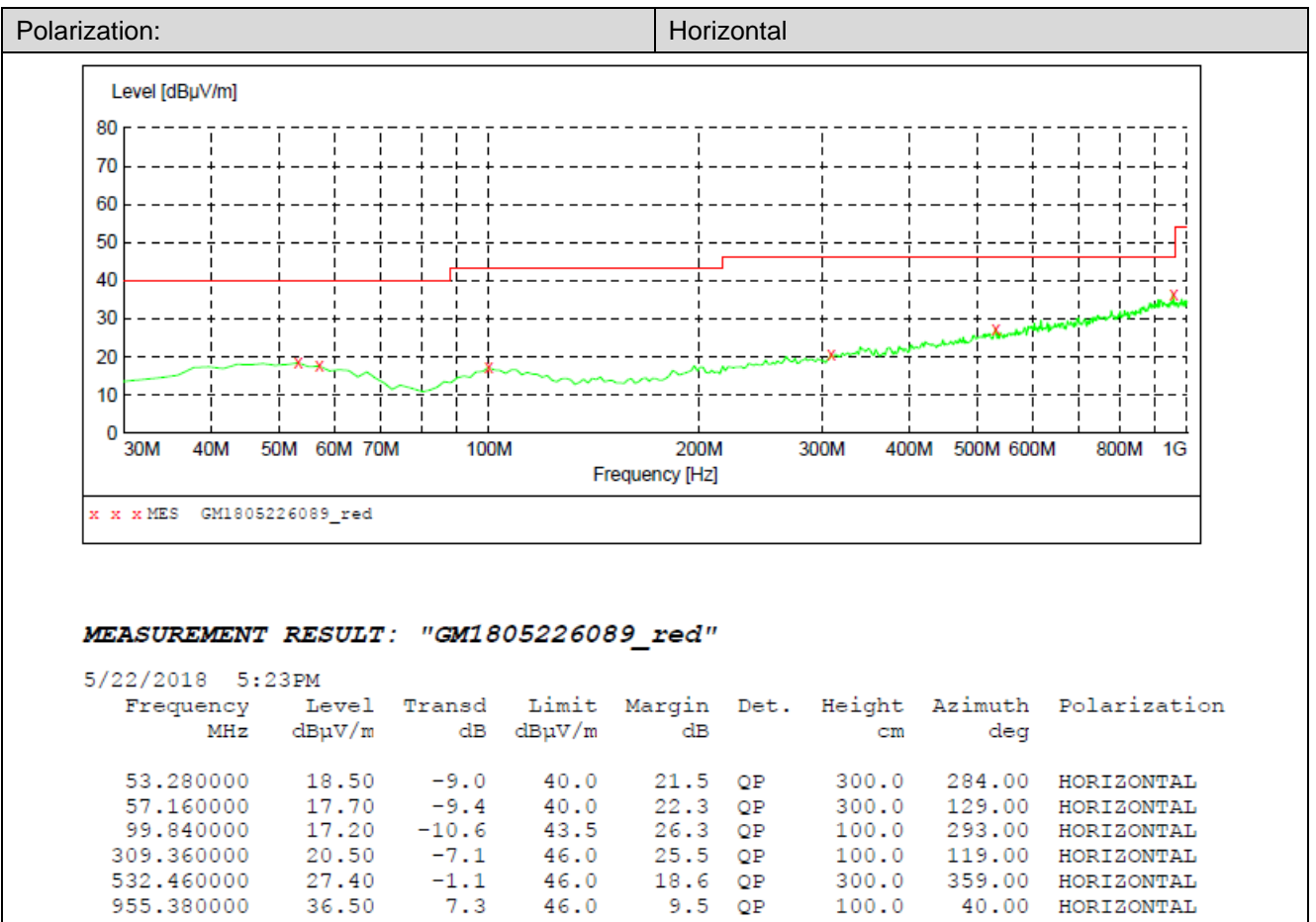
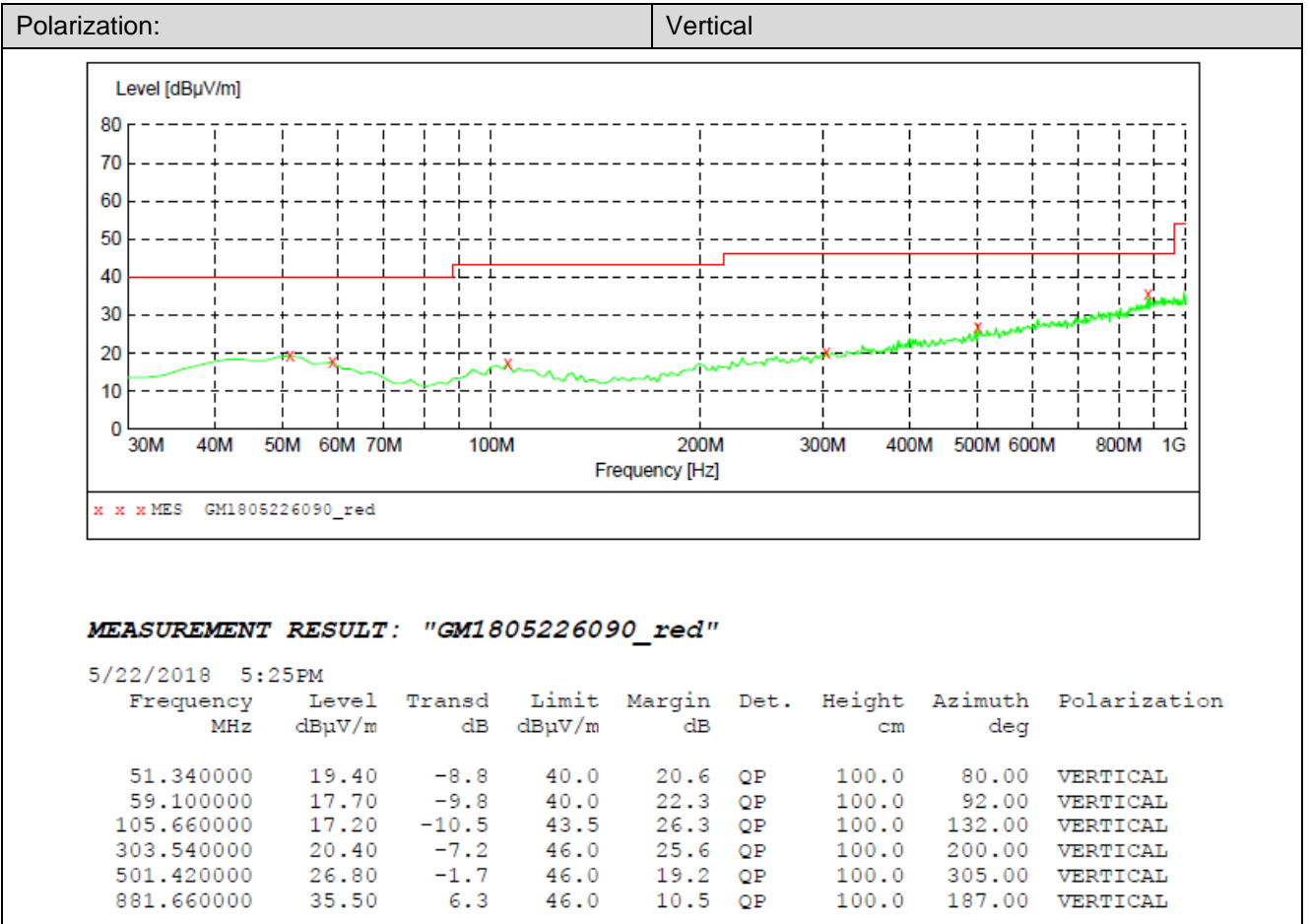

➤ 1 GHz ~ 25 GHz

CH00									
Frequency (MHz)	Read Level (dBuV)	Antenna Factor (dB/m)	Cable Loss (dB)	Preamp Factor (dB)	Level (dBuV/m)	Limit Line (dBuV/m)	Over Limit (dB)	Polarization	Test value
1201.15	35.49	26.30	4.66	37.22	29.23	74.00	-44.77	Vertical	Peak
1777.65	37.24	25.36	5.92	37.38	31.14	74.00	-42.86	Vertical	Peak
4883.52	32.02	31.43	9.59	35.58	37.46	74.00	-36.54	Vertical	Peak
7527.83	32.01	36.13	12.49	33.02	47.61	74.00	-26.39	Vertical	Peak
1286.61	34.33	26.21	4.81	37.18	28.17	74.00	-45.83	Horizontal	Peak
3128.01	34.87	28.80	7.63	37.46	33.84	74.00	-40.16	Horizontal	Peak
4933.50	31.73	31.43	9.63	35.50	37.29	74.00	-36.71	Horizontal	Peak
6544.35	31.20	34.09	11.26	33.64	42.91	74.00	-31.09	Horizontal	Peak

CH39									
Frequency (MHz)	Read Level (dBuV)	Antenna Factor (dB/m)	Cable Loss (dB)	Preamp Factor (dB)	Level (dBuV/m)	Limit Line (dBuV/m)	Over Limit (dB)	Polarization	Test value
1182.94	35.50	26.17	4.62	37.23	29.06	74.00	-44.94	Vertical	Peak
3057.17	34.82	28.72	7.55	37.53	33.56	74.00	-40.44	Vertical	Peak
5086.52	32.44	31.85	9.74	35.21	38.82	74.00	-35.18	Vertical	Peak
6678.99	31.28	34.20	11.45	33.72	43.21	74.00	-30.79	Vertical	Peak
1207.28	35.28	26.29	4.67	37.22	29.02	74.00	-44.98	Horizontal	Peak
3681.47	34.52	29.30	8.36	37.00	35.18	74.00	-38.82	Horizontal	Peak
6219.51	31.17	32.94	11.01	33.91	41.21	74.00	-32.79	Horizontal	Peak
7981.72	31.96	37.03	12.39	33.07	48.31	74.00	-25.69	Horizontal	Peak

CH78									
Frequency (MHz)	Read Level (dBuV)	Antenna Factor (dB/m)	Cable Loss (dB)	Preamp Factor (dB)	Level (dBuV/m)	Limit Line (dBuV/m)	Over Limit (dB)	Polarization	Test value
1241.56	34.38	26.26	4.73	37.20	28.17	74.00	-45.83	Vertical	Peak
3143.98	34.65	28.80	7.65	37.45	33.65	74.00	-40.35	Vertical	Peak
5603.13	31.44	31.79	10.28	34.36	39.15	74.00	-34.85	Vertical	Peak
7663.17	31.64	36.14	12.89	33.04	47.63	74.00	-26.37	Vertical	Peak
1263.88	35.73	26.24	4.77	37.19	29.55	74.00	-44.45	Horizontal	Peak
3507.65	35.06	29.02	8.13	37.13	35.08	74.00	-38.92	Horizontal	Peak
5244.30	32.27	31.41	9.90	34.90	38.68	74.00	-35.32	Horizontal	Peak
6527.71	30.89	34.06	11.23	33.63	42.55	74.00	-31.45	Horizontal	Peak

Remark:

1. Final Level = Receiver Read level + Antenna Factor + Cable Loss – Preamplifier Factor
2. The peak level is lower than average limit (54 dBuV/m), this data is the too weak instrument of signal is unable to test.
3. The emission levels of other frequencies are very lower than the limit and not show in test report.

6. TEST SETUP PHOTOS

Conducted Emissions (AC Mains)



Radiated Emissions





7. EXTERANAL AND INTERNAL PHOTOS

Reference to the test report No.: TRE1805016601.

-----End of Report-----