



# TEST REPORT

**Report Reference No.**..... : **TRE1706030405** R/C.....: 34055

**FCC ID**..... : **QRP-AZUMIIROA45QL**

**Applicant's name**..... : **Azumi S.A**

**Address**.....: Avenida Aquilino de la Guardia con Calle 47, PH Ocean Plaza, Piso 16 of. 16-01, Marbella, Ciudad de Panama, Panama

**Manufacturer**.....: AZUMI HK LTD

**Address**.....: FLAT/RM 18 BLK 1 14/F GOLDEN INDUSTRIAL BUILDING 16-26 KWAI TAK STREET KWAI CHUNG, HK

**Test item description** ..... : **4G Mobile Phone**

**Trade Mark** .....: Azumi

**Model/Type reference**.....: IRO A45 QL

**Listed Model(s)** .....: -

**Standard** ..... : **FCC CFR Title 47 Part 15 Subpart C Section 15.247**

**Date of receipt of test sample**.....: Jun.29, 2017

**Date of testing**.....: Jun.30, 2017 - Jul.16, 2017

**Date of issue**.....: Jul.17, 2017

**Result**.....: **PASS**

**Compiled by**  
( position+printedname+signature)...: File administrators Candy Liu *Candy Liu*

**Supervised by**  
( position+printed name+signature)...: Project Engineer Lion Cai *Lion Cai*

**Approved by**  
( position+printed name+signature)...: RF Manager Hans Hu *Hans Hu*

**Testing Laboratory Name** ..... : **Shenzhen Huatongwei International Inspection Co., Ltd.**

**Address**.....: 1/F, Bldg 3, Hongfa Hi-tech Industrial Park, Genyu Road, Tianliao, Gongming, Shenzhen, China

**Shenzhen Huatongwei International Inspection Co., Ltd. All rights reserved.**

This publication may be reproduced in whole or in part for non-commercial purposes as long as the Shenzhen Huatongwei International Inspection Co., Ltd. is acknowledged as copyright owner and source of the material. Shenzhen Huatongwei International Inspection Co., Ltd. takes no responsibility for and will not assume liability for damages resulting from the reader's interpretation of the reproduced material due to its placement and context.

## Contents

|           |   |           |
|-----------|---|-----------|
| <b>1.</b> | <b><u>TEST STANDARDS AND REPORT VERSION</u></b>       | <b>3</b>  |
| 1.1.      | Applicable Standards                                  | 3         |
| 1.2.      | Report version  | 3         |
| <b>2.</b> | <b><u>TEST DESCRIPTION</u></b>                        | <b>4</b>  |
| <b>3.</b> | <b><u>SUMMARY</u></b>                                 | <b>5</b>  |
| 3.1.      | Client Information                                    | 5         |
| 3.2.      | Product Description                                   | 5         |
| 3.3.      | Operation state                                       | 6         |
| 3.4.      | EUT configuration                                     | 6         |
| 3.5.      | Modifications   | 6         |
| <b>4.</b> | <b><u>TEST ENVIRONMENT</u></b>                        | <b>7</b>  |
| 4.1.      | Address of the test laboratory                        | 7         |
| 4.2.      | Test Facility   | 7         |
| 4.3.      | Equipments Used during the Test                       | 8         |
| 4.4.      | Environmental conditions                              | 9         |
| 4.5.      | Statement of the measurement uncertainty              | 9         |
| <b>5.</b> | <b><u>TEST CONDITIONS AND RESULTS</u></b>             | <b>10</b> |
| 5.1.      | Antenna requirement                                   | 10        |
| 5.2.      | Conducted Emission (AC Main)                          | 11        |
| 5.3.      | Conducted Peak Output Power                           | 14        |
| 5.4.      | Power Spectral Density                                | 15        |
| 5.5.      | 6dB bandwidth   | 17        |
| 5.6.      | Restricted band                                       | 19        |
| 5.7.      | Band edge and Spurious Emission (conducted)           | 21        |
| 5.8.      | Spurious Emission (radiated)                          | 23        |
| <b>6.</b> | <b><u>TEST SETUP PHOTOS OF THE EUT</u></b>            | <b>27</b> |
| <b>7.</b> | <b><u>EXTERNAL AND INTERNAL PHOTOS OF THE EUT</u></b> | <b>28</b> |

## 1. Test standards and Report version

### 1.1. Applicable Standards

The tests were performed according to following standards:

[FCC Rules Part 15.247](#): Frequency Hopping, Direct Spread Spectrum and Hybrid Systems that are in operation within the bands of 902-928 MHz, 2400-2483.5 MHz, and 5725-5850 MHz

[ANSI C63.10:2013](#): American National Standard for Testing Unlicensed Wireless Devices

[KDB 558074 D01 DTS Meas Guidance v03r05](#): Guidance for Performing Compliance Measurements on Digital Transmission Systems (DTS) Operating under § 15.247

### 1.2. Report version

| Version No. | Date of issue | Description |
|-------------|---------------|-------------|
| 00          | Jul.17, 2017  | Original    |
|             |               |             |
|             |               |             |
|             |               |             |
|             |               |             |

## 2. Test Description

| Test Item                         | FCC Rule          | Result |
|-----------------------------------|-------------------|--------|
| Antenna requirement               | 15.203/15.247 (c) | Pass   |
| Line Conducted Emission (AC Main) | 15.207            | Pass   |
| Conducted Peak Output Power       | 15.247 (b)(3)     | Pass   |
| Power Spectral Density            | 15.247 (e)        | Pass   |
| 6dB Bandwidth                     | 15.247 (a)(2)     | Pass   |
| Restricted band                   | 15.247(d)/15.205  | Pass   |
| Spurious Emission                 | 15.247(d)/15.209  | Pass   |

Note: The measurement uncertainty is not included in the test result.

### 3. SUMMARY

#### 3.1. Client Information

|               |  |
|---------------|--|
| Applicant:    | Azumi S.A  |
| Address:      | Avenida Aquilino de la Guardia con Calle 47, PH Ocean Plaza, Piso 16 of. 16-01, Marbella, Ciudad de Panama, Panama |
| Manufacturer: | AZUMI HK LTD   |
| Address:      | FLAT/RM 18 BLK 1 14/F GOLDEN INDUSTRIAL BUILDING 16-26 KWAI TAK STREET KWAI CHUNG,HK                               |

#### 3.2. Product Description

|                      |  |
|----------------------|--|
| Name of EUT:         | 4G Mobile Phone  |
| Trade Mark:          | Azumi  |
| Model No.:           | IRO A45 QL   |
| Listed Model(s):     | -  |
| IMEI:                | 357836080000462  |
| Power supply:        | DC 3.7V From internal battery                                |
| Adapter information: | Input: 100-240Va.c., 50/60Hz, 0.15A<br>Output: 5Vd.c., 700mA |
| Hardware version:    | AZUMI_IRO_A45_QL_Hardware_V1.0                               |
| Software version:    | AZUMI_IRO_A45_QL_OM_V01                                      |
| <b>Bluetooth</b>     |  |
| Version:             | Supported BT4.0+BLE  |
| Modulation:          | GFSK   |
| Operation frequency: | 2402MHz~2480MHz  |
| Channel number:      | 40   |
| Channel separation:  | 2MHz   |
| Antenna type:        | Integral Antenna   |
| Antenna gain:        | -2.0dBi  |

### 3.3. Operation state

➤ **Test frequency list**

According to section 15.31(m), regards to the operating frequency range over 10 MHz, must select three channel which were tested. the Lowest frequency, the middle frequency, and the highest frequency of channel were selected to perform the test, please see the above gray bottom.

| Channel | Frequency (MHz) |
|---------|-----------------|
| 00      | 2402            |
| 02      | 2404            |
| ⋮       | ⋮               |
| 19      | 2440            |
| ⋮       | ⋮               |
| 38      | 2478            |
| 39      | 2480            |

➤ **Test mode**

|   |
|---|
| For RF test items   |
| The engineering test program was provided and enabled to make EUT continuous transmit (duty cycle>98%).                       |
| For AC power line conducted emissions:  |
| The EUT was set to connect with the Bluetooth instrument under large package sizes transmission.                              |
| For RF test axis  |
| EUT in each of three orthogonal axis emissions had been tested ,but only the worst case (X axis) data Recorded in the report. |

### 3.4. EUT configuration

The following peripheral devices and interface cables were connected during the measurement:

- - supplied by the manufacturer
- - supplied by the lab

|  |               |   |
|--|---------------|---|
|  | Length (m):   | / |
|  | Shield:       | / |
|  | Detachable:   | / |
|  | Manufacturer: | / |
|  | Model No.:    | / |

### 3.5. Modifications

No modifications were implemented to meet testing criteria.

## **4. TEST ENVIRONMENT**

### **4.1. Address of the test laboratory**

Laboratory: Shenzhen Huatongwei International Inspection Co., Ltd.

Address: 1/F, Bldg 3, Hongfa Hi-tech Industrial Park, Genyu Road, Tianliao, Gongming, Shenzhen, China

Phone: 86-755-26748019 Fax: 86-755-26748089

### **4.2. Test Facility**

The test facility is recognized, certified, or accredited by the following organizations:

#### **CNAS-Lab Code: L1225**

Shenzhen Huatongwei International Inspection Co., Ltd. has been assessed and proved to be in compliance with CNAS-CL01 Accreditation Criteria for Testing and Calibration Laboratories (identical to ISO/IEC17025: 2005 General Requirements) for the Competence of Testing and Calibration Laboratories.

#### **A2LA-Lab Cert. No.: 3902.01**

Shenzhen Huatongwei International Inspection Co., Ltd. EMC Laboratory has been accredited by A2LA for technical competence in the field of electrical testing, and proved to be in compliance with ISO/IEC 17025: 2005 General Requirements for the Competence of Testing and Calibration Laboratories and any additional program requirements in the identified field of testing.

#### **FCC-Registration No.: 317478**

Shenzhen Huatongwei International Inspection Co., Ltd. EMC Laboratory has been registered and fully described in a report filed with the FCC (Federal Communications Commission). The acceptance letter from the FCC is maintained in our files. Registration 317478.

#### **IC-Registration No.: 5377B**

Two 3m Alternate Test Site of Shenzhen Huatongwei International Inspection Co., Ltd. has been registered by Certification and Engineering Bureau of Industry Canada for the performance of radiated measurements with Registration No. 5377B.

#### **ACA**

Shenzhen Huatongwei International Inspection Co., Ltd. EMC Laboratory can also perform testing for the Australian C-Tick mark as a result of our A2LA accreditation.

### 4.3. Equipments Used during the Test

| Conducted Emission (AC Main) |                   |               |             |            |            |
|------------------------------|-------------------|---------------|-------------|------------|------------|
| Item                         | Test Equipment    | Manufacturer  | Model No.   | Serial No. | Last Cal.  |
| 1                            | Artificial Mains  | Rohde&Schwarz | ESH2-Z5     | 100028     | 2016/11/13 |
| 2                            | EMI Test Receiver | Rohde&Schwarz | ESCI3       | 100038     | 2016/11/13 |
| 3                            | Pulse Limiter     | Rohde&Schwarz | ESHSZ2      | 100044     | 2016/11/13 |
| 4                            | EMI Test Software | Rohde&Schwarz | ES-K1 V1.71 | N/A        | N/A        |

| Radiated Emission |                         |                              |                    |            |            |
|-------------------|-------------------------|------------------------------|--------------------|------------|------------|
| Item              | Test Equipment          | Manufacturer                 | Model No.          | Serial No. | Last Cal.  |
| 1                 | Ultra-Broadband Antenna | ShwarzBeck                   | VULB9163           | 538        | 2016/11/13 |
| 2                 | EMI TEST RECEIVER       | Rohde&Schwarz                | ESI 26             | 100009     | 2016/11/13 |
| 3                 | EMI TEST Software       | Audix                        | E3                 | N/A        | N/A        |
| 4                 | TURNTABLE               | ETS                          | 2088               | 2149       | N/A        |
| 5                 | ANTENNA MAST            | ETS                          | 2075               | 2346       | N/A        |
| 6                 | EMI TEST Software       | Rohde&Schwarz                | ESK1               | N/A        | N/A        |
| 7                 | HORNANTENNA             | ShwarzBeck                   | 9120D              | 1011       | 2016/11/13 |
| 8                 | Amplifer                | Sonoma                       | 310N               | E009-13    | 2016/11/13 |
| 9                 | JS amplifer             | Rohde&Schwarz                | JS4-00101800-28-5A | F201504    | 2016/11/13 |
| 10                | High pass filter        | Compliance Direction systems | BSU-6              | 34202      | 2016/11/13 |
| 11                | HORNANTENNA             | ShwarzBeck                   | 9120D              | 1012       | 2016/11/13 |
| 12                | Amplifer                | Compliance Direction systems | PAP1-4060          | 120        | 2016/11/13 |
| 13                | Loop Antenna            | Rohde&Schwarz                | HFH2-Z2            | 100020     | 2016/11/13 |
| 14                | TURNTABLE               | MATURO                       | TT2.0              | ----       | N/A        |
| 15                | ANTENNA MAST            | MATURO                       | TAM-4.0-P          | ----       | N/A        |
| 16                | Horn Antenna            | SCHWARZBECK                  | BBHA9170           | 25841      | 2016/11/13 |
| 17                | ULTRA-BROADBAND ANTENNA | Rohde&Schwarz                | HL562              | 100015     | 2016/11/13 |

| Maximum Peak Output Power / Power Spectral Density / 6dB Bandwidth / Band Edge Compliance of RF Emission / Spurious RF Conducted Emission |                   |               |           |              |            |
|---|-------------------|---------------|-----------|--------------|------------|
| Item  | Test Equipment    | Manufacturer  | Model No. | Serial No.   | Last Cal.  |
| 1   | Spectrum Analyzer | Rohde&Schwarz | FSP       | 1164.4391.40 | 2016/11/13 |
| 2   | Power Meter       | Anritsu       | ML2480B   | 100798       | 2016/11/13 |
| 3   | Power Sensor      | Anritsu       | MA2411B   | 100258       | 2016/11/13 |

The Cal. Interval was one year.



#### 4.4. Environmental conditions

During the measurement the environmental conditions were within the listed ranges:

|                    |              |
|--------------------|--------------|
| Temperature:       | 15~35°C      |
| Relative Humidity: | 30~60 %      |
| Air Pressure:      | 950~1050 mba |

#### 4.5. Statement of the measurement uncertainty

The data and results referenced in this document are true and accurate. The reader is cautioned that there may be errors within the calibration limits of the equipment and facilities. The measurement uncertainty was calculated for all measurements listed in this test report acc. to TR-100028-01 "Electromagnetic compatibility and Radio spectrum Matters (ERM); Uncertainties in the measurement of mobile radio equipment characteristics; Part 1" and TR-100028-02 "Electromagnetic compatibility and Radio spectrum Matters (ERM); Uncertainties in the measurement of mobile radio equipment characteristics; Part 2" and is documented in the Shenzhen Huatongwei International Inspection Co., Ltd quality system acc. to DIN EN ISO/IEC 17025. Furthermore, component and process variability of devices similar to that tested may result in additional deviation. The manufacturer has the sole responsibility of continued compliance of the device.

Hereafter the best measurement capability for Shenzhen Huatongwei laboratory is reported:

| Test Items                                 | Measurement Uncertainty | Notes |
|--|-------------------------|-------|
| Transmitter Power Conducted                | 0.57 dB                 | (1)   |
| Transmitter Power Radiated                 | 2.20 dB                 | (1)   |
| Conducted Spurious Emission 9 kHz ~ 40 GHz | 1.60 dB                 | (1)   |
| Radiated Spurious Emission 9 kHz ~ 40 GHz  | 2.20 dB                 | (1)   |
| Conducted Emission 9 kHz ~ 30 MHz          | 3.39 dB                 | (1)   |
| Radiated Emission 30 ~ 1000 MHz            | 4.24 dB                 | (1)   |
| Radiated Emission 1 ~ 18 GHz               | 5.16 dB                 | (1)   |
| Radiated Emission 18 ~ 40 GHz              | 5.54 dB                 | (1)   |
| Occupied Bandwidth                         | -----                   | (1)   |

(1) This uncertainty represents an expanded uncertainty expressed at approximately the 95% confidence level using a coverage factor of  $k=1.96$ .

## 5. TEST CONDITIONS AND RESULTS

### 5.1. Antenna requirement

#### Requirement

##### **FCC CFR Title 47 Part 15 Subpart C Section 15.203:**

An intentional radiator shall be designed to ensure that no antenna other than that furnished by the responsible party shall be used with the device. The use of a permanently attached antenna or of an antenna that uses a unique coupling to the intentional radiator, the manufacturer may design the unit so that a broken antenna can be replaced by the user, but the use of a standard antenna jack or electrical connector is prohibited.

##### **FCC CFR Title 47 Part 15 Subpart C Section 15.247(c) (1)(i):**

(i) Systems operating in the 2400-2483.5 MHz band that is used exclusively for fixed. Point-to-point operations may employ transmitting antennas with directional gain greater than 6 dBi provided the maximum conducted output power of the intentional radiator is reduced by 1 dB for every 3 dB that the directional gain of the antenna exceeds 6 dBi.

#### TEST RESULTS

**Passed**       **Not Applicable**

The antenna is integral antenna, the best case gain of the antenna is -2.0dBi, please refer to the below antenna photo.

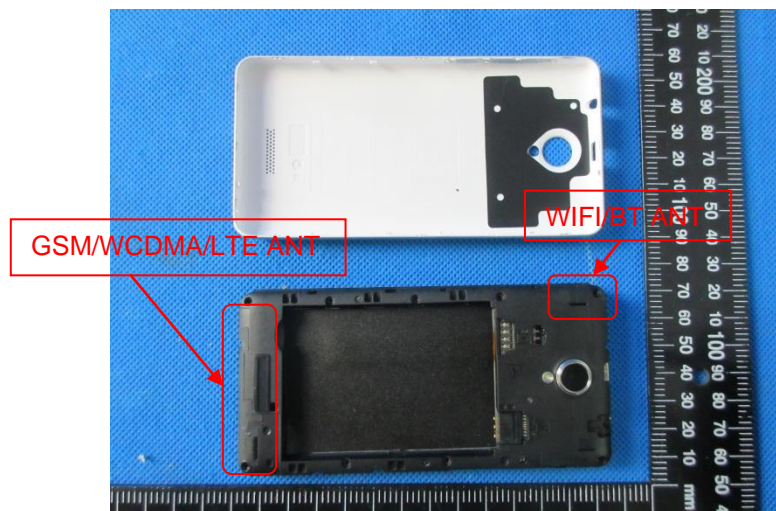

## 5.2. Conducted Emission (AC Main)

### LIMIT

FCC CFR Title 47 Part 15 Subpart C Section 15.207

| Frequency range (MHz) | Limit (dBuV) |           |
|-----------------------|--------------|-----------|
|                       | Quasi-peak   | Average   |
| 0.15-0.5              | 66 to 56*    | 56 to 46* |
| 0.5-5                 | 56           | 46        |
| 5-30                  | 60           | 50        |

\* Decreases with the logarithm of the frequency.

### TEST CONFIGURATION

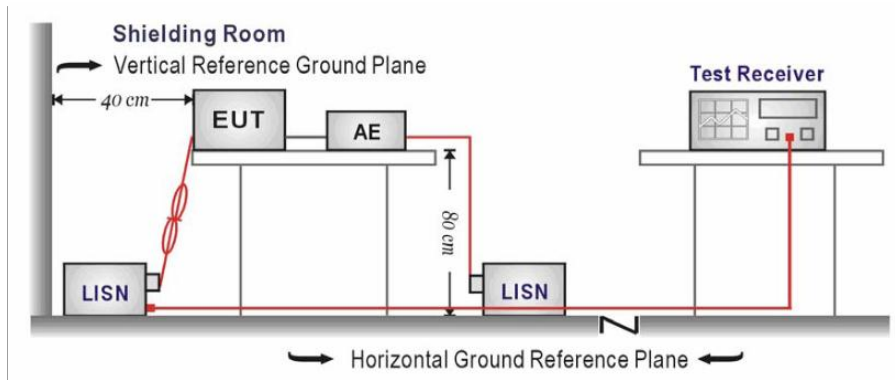

### TEST PROCEDURE

1. The EUT was setup according to ANSI C63.10:2013 for compliance to FCC 47CFR 15.247 requirements.
2. The EUT was placed on a platform of nominal size, 1 m by 1.5 m, raised 80 cm above the conducting ground plane. The vertical conducting plane was located 40 cm to the rear of the EUT. All other surfaces of EUT were at least 80 cm from any other grounded conducting surface.
3. The EUT and simulators are connected to the main power through a line impedance stabilization network (LISN). The LISN provides a 50 ohm /50uH coupling impedance for the measuring equipment.
4. The peripheral devices are also connected to the main power through a LISN. (Please refer to the block diagram of the test setup and photographs)
5. Each current-carrying conductor of the EUT power cord, except the ground (safety) conductor, was individually connected through a LISN to the input power source.
6. The excess length of the power cord between the EUT and the LISN receptacle were folded back and forth at the center of the lead to form a bundle not exceeding 40 cm in length.
7. Conducted emissions were investigated over the frequency range from 0.15 MHz to 30 MHz using a receiver bandwidth of 9 kHz.
8. During the above scans, the emissions were maximized by cable manipulation.

### TEST MODE:

Please refer to the clause 3.3

### TEST RESULTS

Passed       Not Applicable

Note:

- 1) Transd = Cable lose + Pulse Limiter Factor + Artificial Mains Factor
- 2) Margin = Limit - Level

Test Line: L

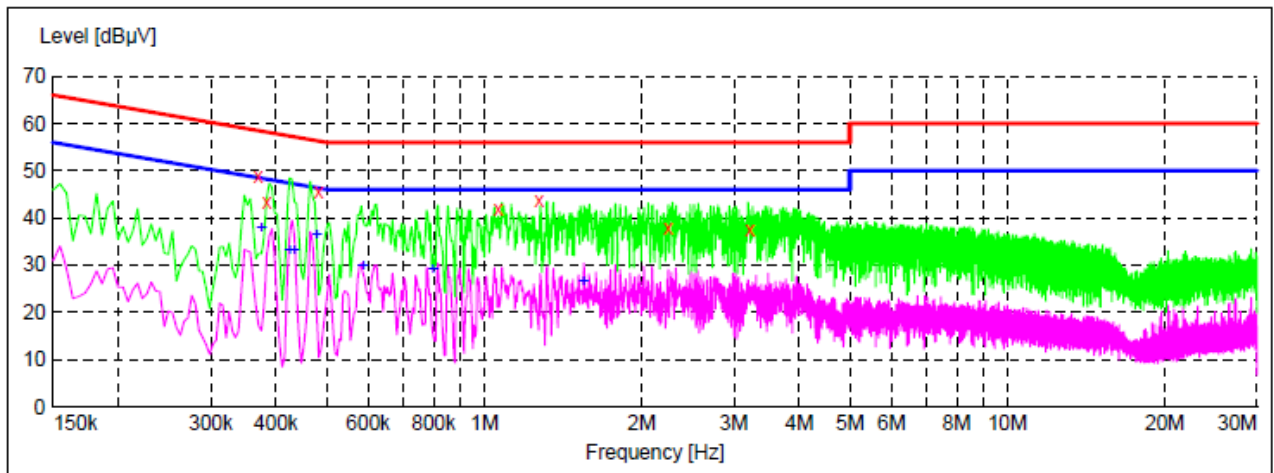

x x x MES GM1707065090\_fin

**MEASUREMENT RESULT: "GM1707065090\_fin"**

7/6/2017 7:17PM

| Frequency<br>MHz | Level<br>dBµV | Transd<br>dB | Limit<br>dBµV | Margin<br>dB | Detector | Line | PE  |
|------------------|---------------|--------------|---------------|--------------|----------|------|-----|
| 0.370500         | 49.00         | 10.2         | 59            | 9.5          | QP       | L1   | GND |
| 0.384000         | 43.30         | 10.2         | 58            | 14.9         | QP       | L1   | GND |
| 0.483000         | 45.60         | 10.2         | 56            | 10.7         | QP       | L1   | GND |
| 1.063500         | 41.90         | 10.2         | 56            | 14.1         | QP       | L1   | GND |
| 1.275000         | 43.80         | 10.2         | 56            | 12.2         | QP       | L1   | GND |
| 2.247000         | 38.00         | 10.2         | 56            | 18.0         | QP       | L1   | GND |
| 3.219000         | 37.60         | 10.2         | 56            | 18.4         | QP       | L1   | GND |

**MEASUREMENT RESULT: "GM1707065090\_fin2"**

7/6/2017 7:17PM

| Frequency<br>MHz | Level<br>dBµV | Transd<br>dB | Limit<br>dBµV | Margin<br>dB | Detector | Line | PE  |
|------------------|---------------|--------------|---------------|--------------|----------|------|-----|
| 0.375000         | 37.80         | 10.2         | 48            | 10.6         | AV       | L1   | GND |
| 0.424500         | 33.10         | 10.2         | 47            | 14.3         | AV       | L1   | GND |
| 0.433500         | 33.00         | 10.2         | 47            | 14.2         | AV       | L1   | GND |
| 0.478500         | 36.50         | 10.2         | 46            | 9.9          | AV       | L1   | GND |
| 0.586500         | 29.90         | 10.2         | 46            | 16.1         | AV       | L1   | GND |
| 0.798000         | 29.10         | 10.2         | 46            | 16.9         | AV       | L1   | GND |
| 1.545000         | 26.40         | 10.2         | 46            | 19.6         | AV       | L1   | GND |

Test Line: N

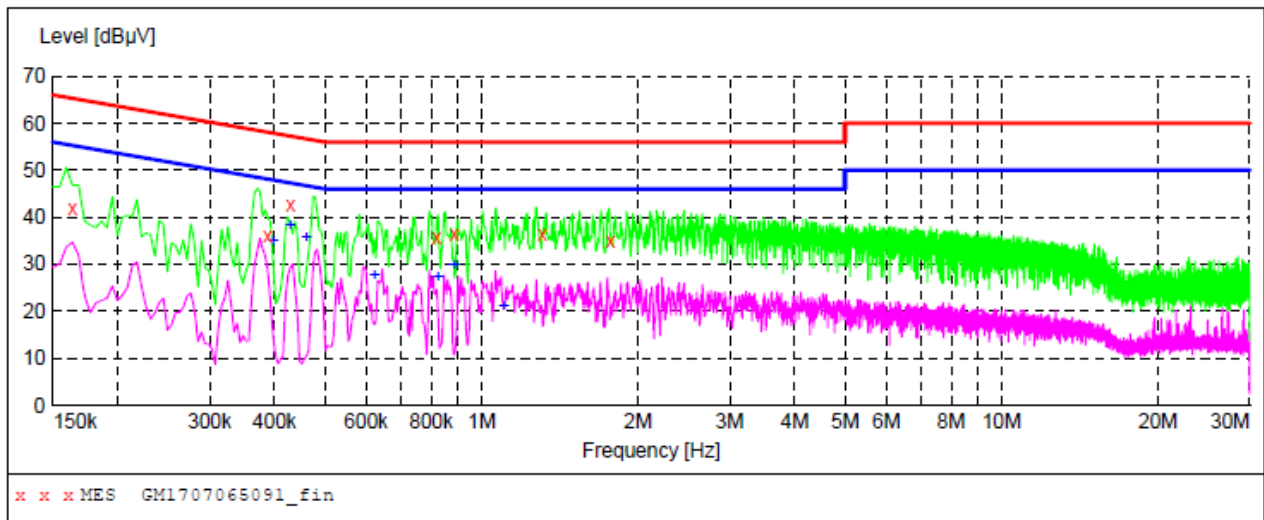

**MEASUREMENT RESULT: "GM1707065091\_fin"**

7/6/2017 7:20PM

| Frequency<br>MHz | Level<br>dBµV | Transd<br>dB | Limit<br>dBµV | Margin<br>dB | Detector | Line | PE  |
|------------------|---------------|--------------|---------------|--------------|----------|------|-----|
| 0.163500         | 42.00         | 10.4         | 65            | 23.3         | QP       | N    | GND |
| 0.388500         | 36.20         | 10.2         | 58            | 21.9         | QP       | N    | GND |
| 0.429000         | 42.60         | 10.2         | 57            | 14.7         | QP       | N    | GND |
| 0.820500         | 35.60         | 10.2         | 56            | 20.4         | QP       | N    | GND |
| 0.888000         | 36.50         | 10.1         | 56            | 19.5         | QP       | N    | GND |
| 1.311000         | 36.40         | 10.2         | 56            | 19.6         | QP       | N    | GND |
| 1.770000         | 34.90         | 10.2         | 56            | 21.1         | QP       | N    | GND |

**MEASUREMENT RESULT: "GM1707065091\_fin2"**

7/6/2017 7:20PM

| Frequency<br>MHz | Level<br>dBµV | Transd<br>dB | Limit<br>dBµV | Margin<br>dB | Detector | Line | PE  |
|------------------|---------------|--------------|---------------|--------------|----------|------|-----|
| 0.397500         | 34.90         | 10.2         | 48            | 13.0         | AV       | N    | GND |
| 0.429000         | 38.30         | 10.2         | 47            | 9.0          | AV       | N    | GND |
| 0.460500         | 35.60         | 10.2         | 47            | 11.1         | AV       | N    | GND |
| 0.622500         | 27.60         | 10.2         | 46            | 18.4         | AV       | N    | GND |
| 0.825000         | 27.40         | 10.2         | 46            | 18.6         | AV       | N    | GND |
| 0.888000         | 29.70         | 10.1         | 46            | 16.3         | AV       | N    | GND |
| 1.104000         | 20.90         | 10.2         | 46            | 25.1         | AV       | N    | GND |

### 5.3. Conducted Peak Output Power

#### LIMIT

FCC CFR Title 47 Part 15 Subpart C Section 15.247 (b)(3): **30 dBm**

#### TEST CONFIGURATION

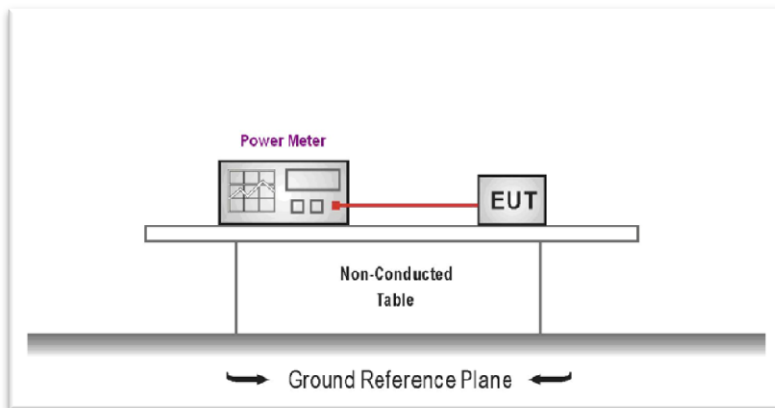

#### TEST PROCEDURE

1. The EUT was tested according to KDB 558074 D01 V03R03 for compliance to FCC 47CFR 15.247 requirements.
2. The maximum peak conducted output power may be measured using a broadband peak RF power meter.
3. The power meter shall have a video bandwidth that is greater than or equal to the DTS bandwidth and shall utilize a fast-responding diode detector.
4. Record the measurement data.

#### TEST MODE:

Please refer to the clause 3.3

#### TEST RESULTS

**Passed**       **Not Applicable**

| Type   | Channel | Output power (dBm) | Limit (dBm) | Result |
|--------|---------|--------------------|-------------|--------|
| BT-BLE | 00      | -1.85              | 30.00       | Pass   |
|        | 19      | -1.21              |             |        |
|        | 39      | -5.51              |             |        |

### 5.4. Power Spectral Density

**LIMIT**

FCC CFR Title 47 Part 15 Subpart C Section 15.247 (e): **8dBm/3KHz**

For digitally modulated systems, the power spectral density conducted from the intentional radiator to the antenna shall not be greater than 8 dBm in any 3 kHz band during any time interval of continuous transmission.

**TEST CONFIGURATION**

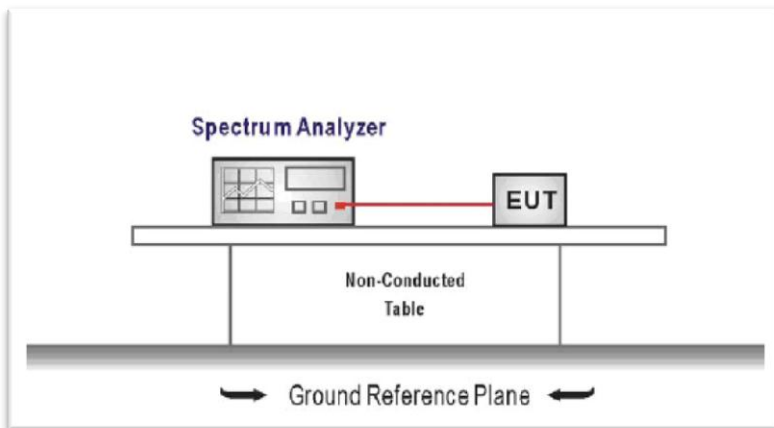

**TEST PROCEDURE**

1. Connect the antenna port(s) to the spectrum analyzer input,
2. Configure the spectrum analyzer as shown below:  
 Center frequency=DTS channel center frequency  
 Span =1.5 times the DTS bandwidth  
 RBW = 3 kHz ≤ RBW ≤ 100 kHz, VBW ≥ 3 × RBW  
 Sweep time = auto couple  
 Detector = peak  
 Trace mode = max hold
3. Place the radio in continuous transmit mode, allow the trace to stabilize, view the transmitter waveform on the spectrum analyzer.
4. Use the peak marker function to determine the maximum amplitude level within the RBW.
5. If measured value exceeds limit, reduce RBW (no less than 3 kHz) and repeat.

**TEST MODE:**

Please refer to the clause 3.3

**TEST RESULTS**

**Passed**       **Not Applicable**

| Type   | Channel | Power Spectral Density(dBm/3kHz) | Limit (dBm/3kHz) | Result |
|--------|---------|----------------------------------|------------------|--------|
| BT-BLE | 00      | -17.38                           | 8.00             | Pass   |
|        | 19      | -16.79                           |                  |        |
|        | 39      | -21.12                           |                  |        |

Test plot as follows:

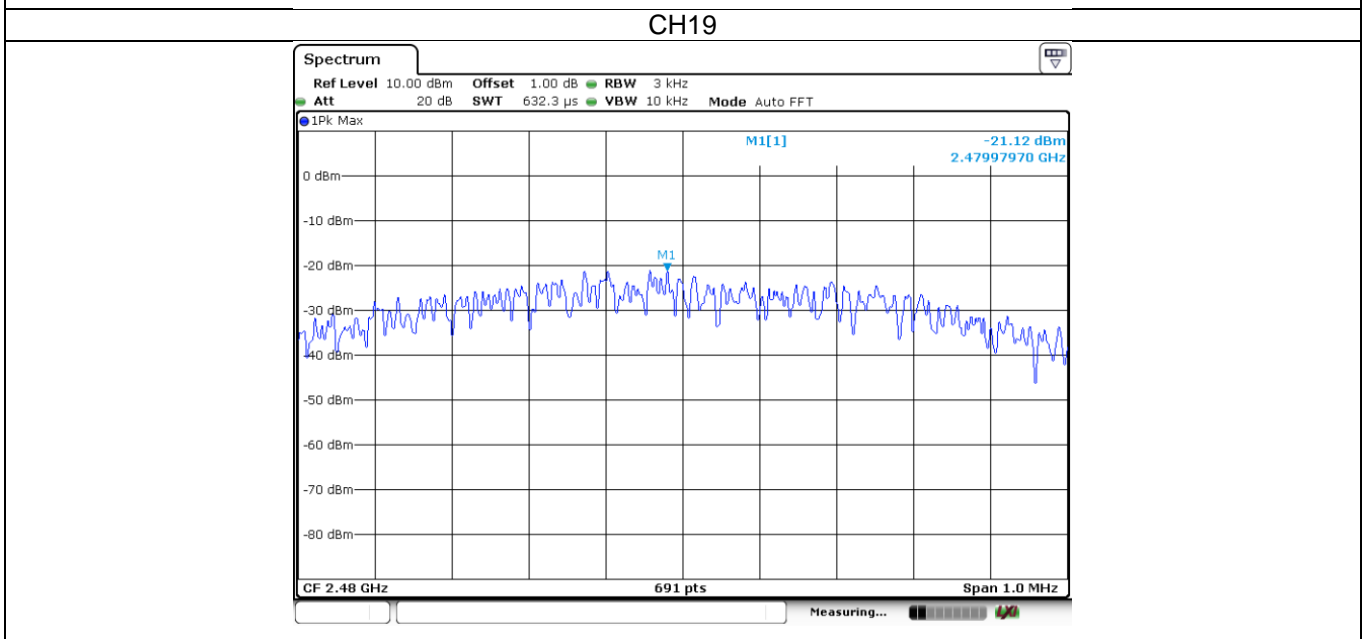
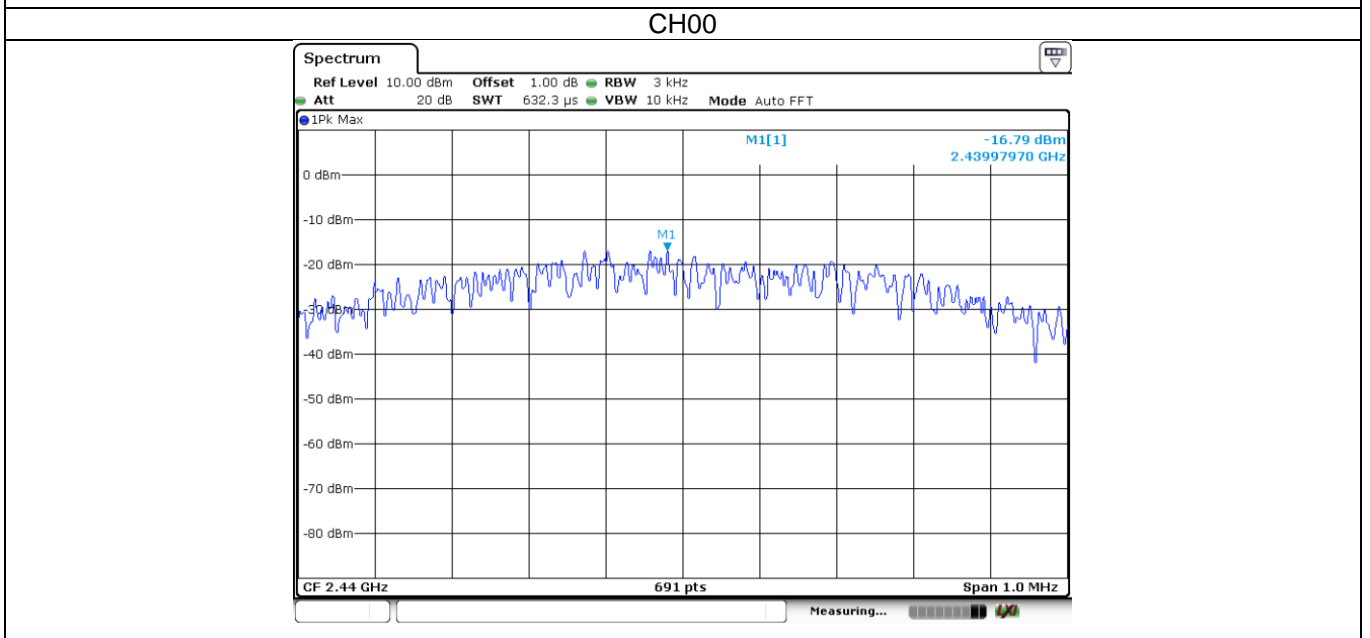
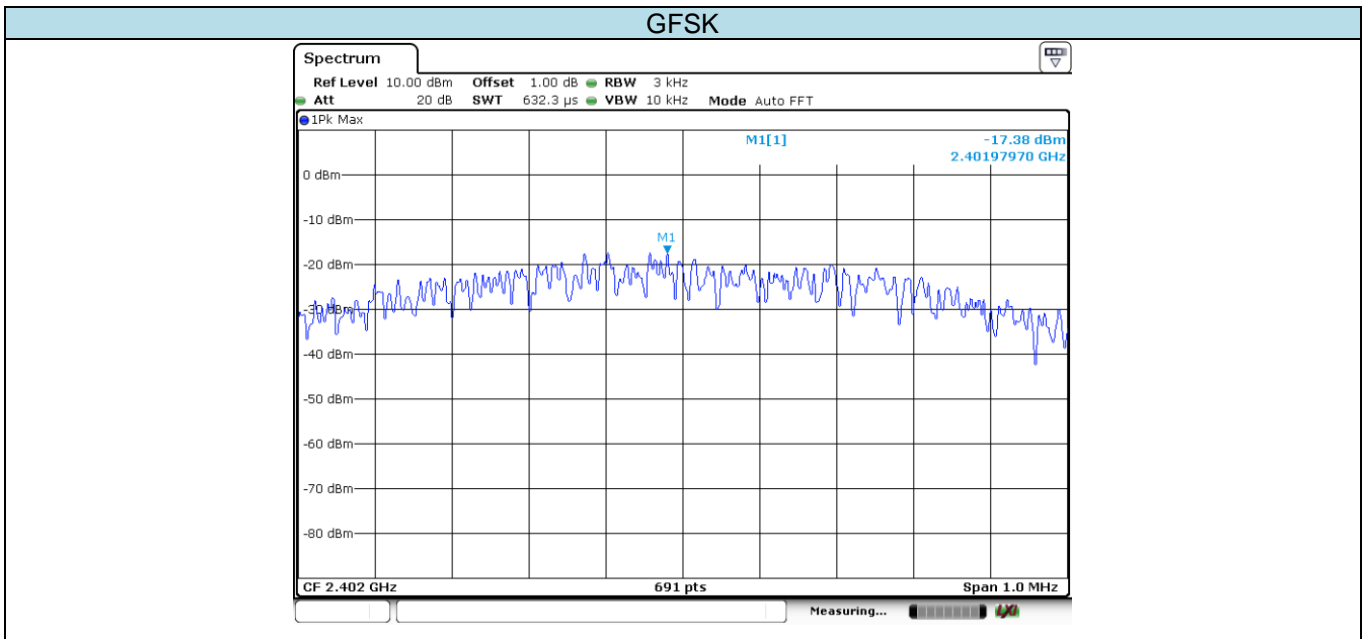

CH39



**5.5. 6dB bandwidth**

**LIMIT**

**FCC CFR Title 47 Part 15 Subpart C Section 15.247 (a)(2):**

For digital modulation systems, the minimum 6 dB bandwidth shall be at least 500 kHz.

**TEST CONFIGURATION**

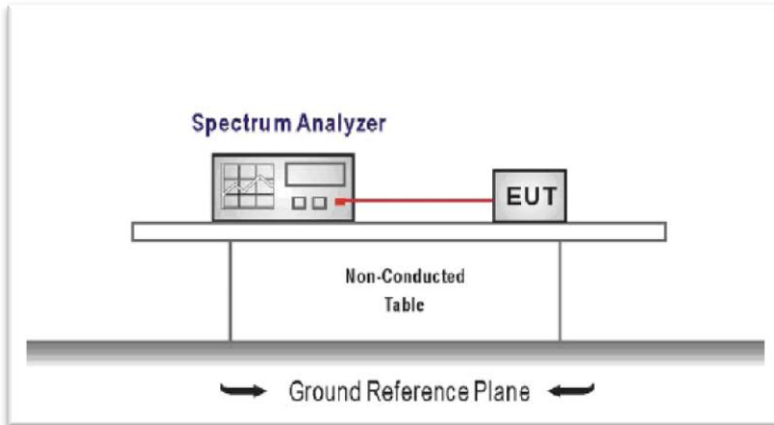

**TEST PROCEDURE**

1. Connect the antenna port(s) to the spectrum analyzer input.
2. Configure the spectrum analyzer as shown below (enter all losses between the transmitter output and the spectrum analyzer).  
 Center Frequency = DTS channel center frequency  
 Span = 2 x DTS bandwidth  
 RBW = 100 kHz, VBW ≥ 3 x RBW  
 Sweep time = auto couple  
 Detector = Peak  
 Trace mode = max hold
3. Place the radio in continuous transmit mode, allow the trace to stabilize, view the transmitter waveform on the spectrum analyzer.
4. Measure the maximum width of the emission that is constrained by the frequencies associated with the two outermost amplitude points (upper and lower frequencies) that are attenuated by 6 dB relative to the maximum level measured in the fundamental emission, and record the pertinent measurements.

**TEST MODE:**

Please refer to the clause 3.3

**TEST RESULTS**

**Passed**       **Not Applicable**

| Type   | Channel | 6dB Bandwidth(kHz) | Limit (kHz) | Result |
|--------|---------|--------------------|-------------|--------|
| BT-BLE | 00      | 720.70             | ≥500        | Pass   |
|        | 19      | 717.80             |             |        |
|        | 39      | 723.60             |             |        |

Test plot as follows:

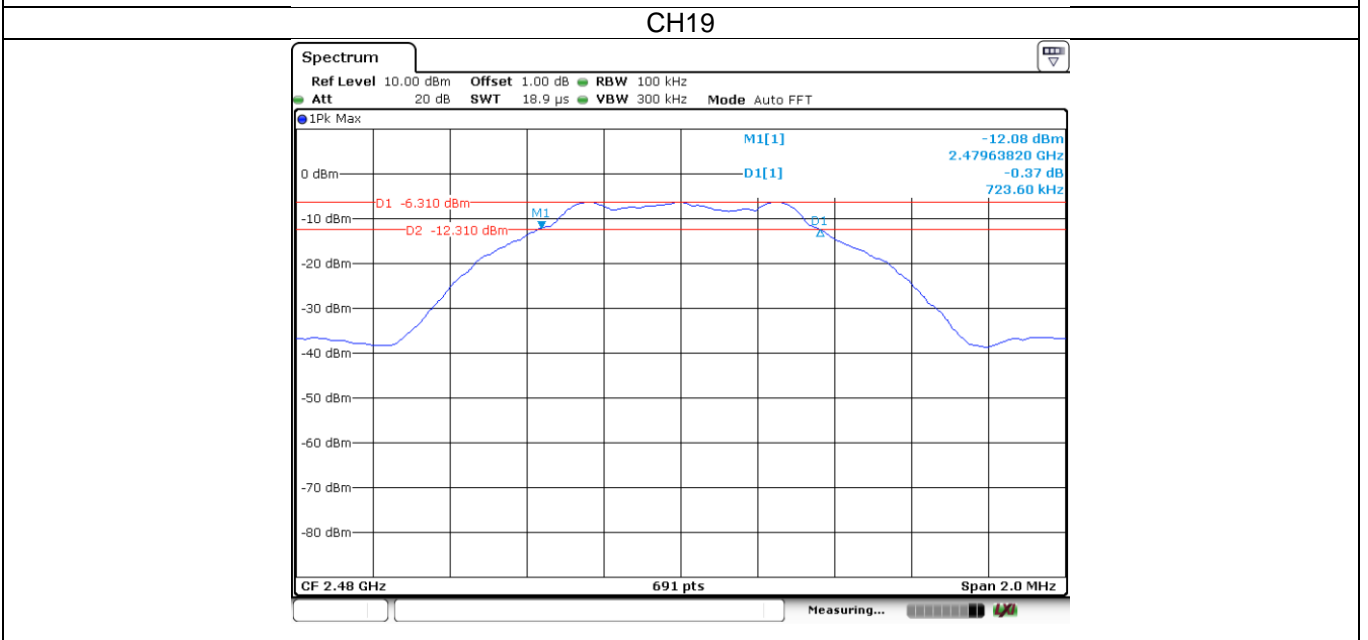
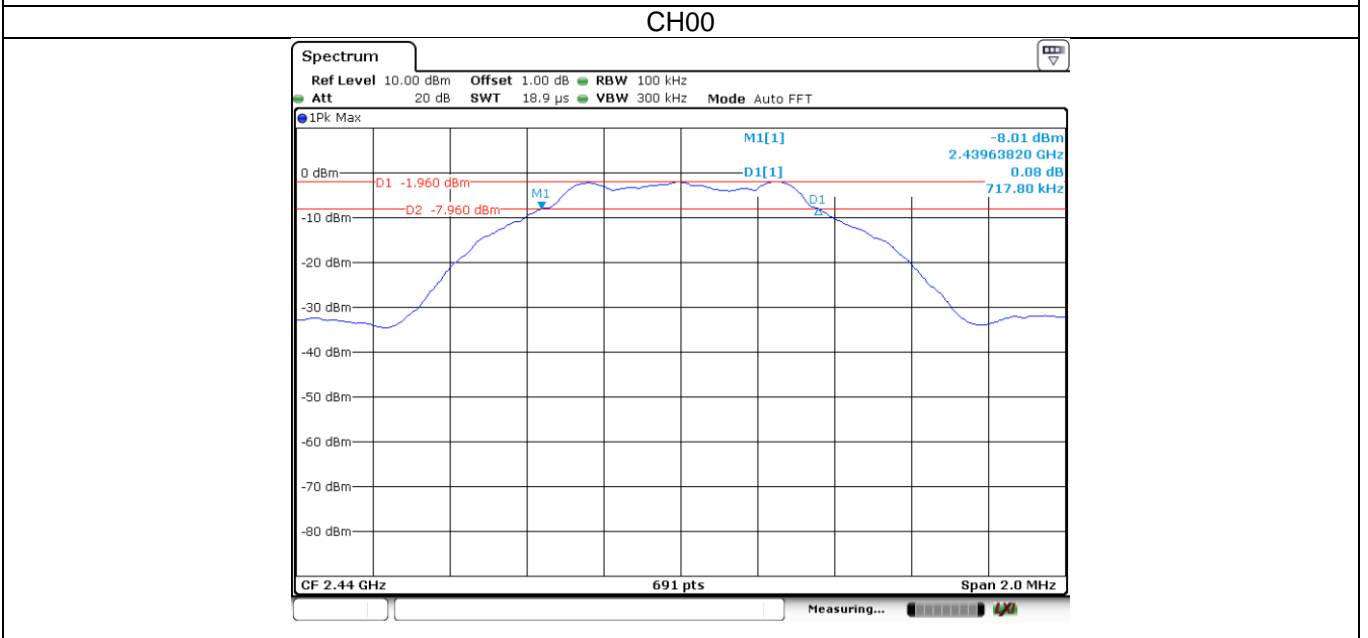
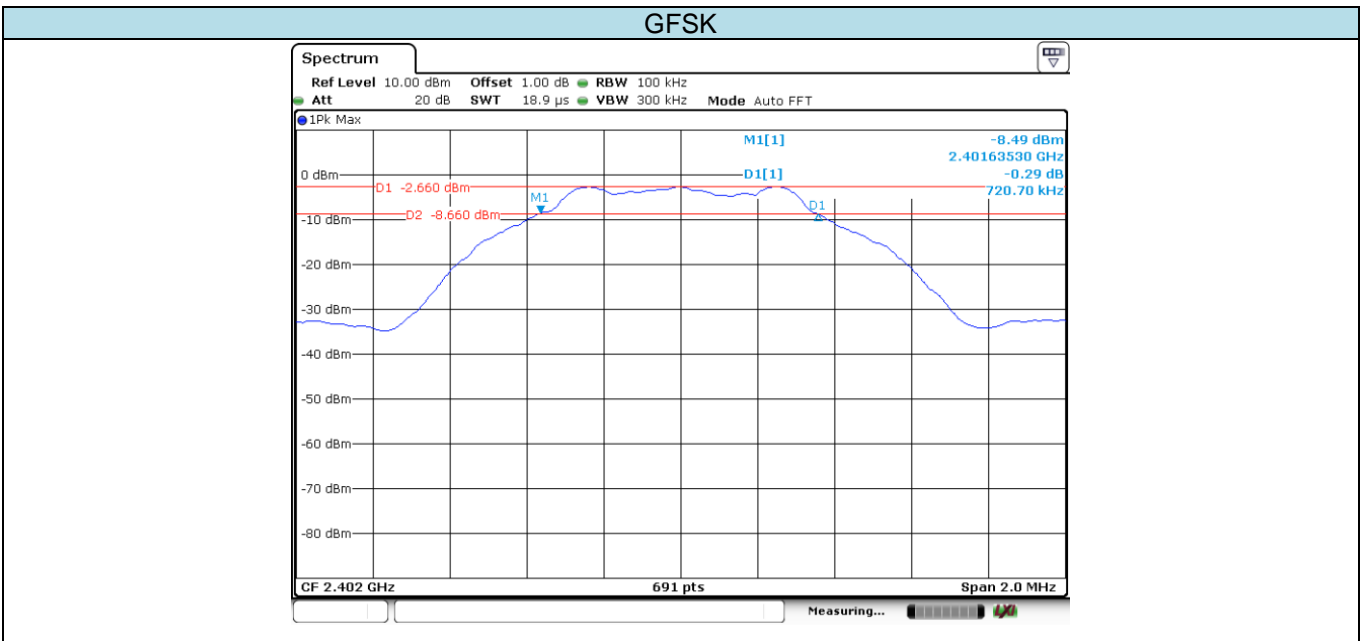

CH39

## 5.6. Restricted band

### LIMIT

#### **FCC CFR Title 47 Part 15 Subpart C Section 15.247 (d):**

In any 100 kHz bandwidth outside the frequency band in which the spread spectrum or digitally modulated intentional radiator is operating, radiated emissions which fall in the restricted bands, as defined in §15.205(a), must also comply with the radiated emission limits specified in §15.209(a) (see §15.205(c)).

### TEST CONFIGURATION

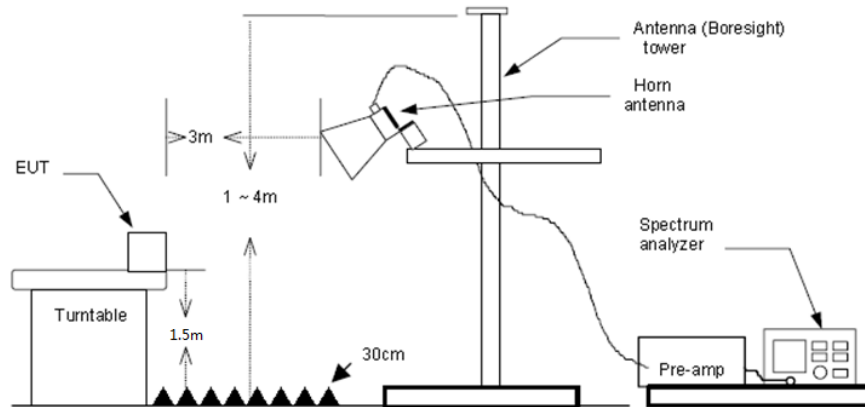

### TEST PROCEDURE

1. The EUT was setup and tested according to ANSI C63.10:2013 for compliance to FCC 47CFR 15.247 requirements.
2. The EUT is placed on a turn table which is 1.5 meter above ground. The turn table is rotated 360 degrees to determine the position of the maximum emission level.
3. The EUT was positioned such that the distance from antenna to the EUT was 3 meters.
4. The antenna is scanned from 1 meter to 4 meters to find out the maximum emission level. This is repeated for both horizontal and vertical polarization of the antenna. In order to find the maximum emission, all of the interface cables were manipulated according to ANSI C63.10:2013 on radiated measurement.
5. The receiver set as follow:  
 RBW=1 MHz, VBW=3 MHz for Peak value  
 RBW=1 MHz, VBW=3 MHz RMS detector for Average value.

### TEST MODE:

Please refer to the clause 3.3

### TEST RESULTS

**Passed**       **Not Applicable**

Note:

- 1) Final level= Read level + Antenna Factor+ Cable Loss- Preamp Factor
- 2) The peak level is lower than average limit(54 dBuV/m), this data is the too weak instrument of signal is unable to test.

| BT-BLE          |                   |                       |                 |                    | CH00           |                     |                   |              |            |
|-----------------|-------------------|-----------------------|-----------------|--------------------|----------------|---------------------|-------------------|--------------|------------|
| Frequency (MHz) | Read Level (dBuV) | Antenna Factor (dB/m) | Cable Loss (dB) | Preamp Factor (dB) | Level (dBuV/m) | Limit Line (dBuV/m) | Margin Limit (dB) | Polarization | Test value |
| 2310.00         | 34.17             | 28.05                 | 6.62            | 37.65              | 31.19          | 74.00               | -42.81            | Vertical     | Peak       |
| 2390.03         | 34.23             | 27.65                 | 6.75            | 37.87              | 30.76          | 74.00               | -43.24            | Vertical     |            |
| 2310.00         | 33.10             | 28.05                 | 6.62            | 37.65              | 30.12          | 74.00               | -43.88            | Horizontal   |            |
| 2390.03         | 33.82             | 27.65                 | 6.75            | 37.87              | 30.35          | 74.00               | -43.65            | Horizontal   |            |

| BT-BLE          |                   |                       |                 |                    | CH39           |                     |                   |              |            |
|-----------------|-------------------|-----------------------|-----------------|--------------------|----------------|---------------------|-------------------|--------------|------------|
| Frequency (MHz) | Read Level (dBuV) | Antenna Factor (dB/m) | Cable Loss (dB) | Preamp Factor (dB) | Level (dBuV/m) | Limit Line (dBuV/m) | Margin Limit (dB) | Polarization | Test value |
| 2483.50         | 51.96             | 27.26                 | 6.83            | 37.87              | 48.18          | 74.00               | -25.82            | Vertical     | Peak       |
| 2500.00         | 31.84             | 27.20                 | 6.84            | 37.87              | 28.01          | 74.00               | -45.99            | Vertical     |            |
| 2483.50         | 50.01             | 27.26                 | 6.83            | 37.87              | 46.23          | 74.00               | -27.77            | Horizontal   |            |
| 2500.00         | 32.05             | 27.20                 | 6.84            | 37.87              | 28.22          | 74.00               | -45.78            | Horizontal   |            |

## 5.7. Band edge and Spurious Emission (conducted)

### LIMIT

#### **FCC CFR Title 47 Part 15 Subpart C Section 15.247 (d):**

In any 100 kHz bandwidth outside the frequency band in which the spread spectrum intentional radiator is operating, the radio frequency power that is produced by the intentional radiator shall be at least 20 dB below that in the 100 kHz bandwidth within the band that contains the highest level of the desired power, based on either an RF conducted or a radiated measurement.

### TEST CONFIGURATION

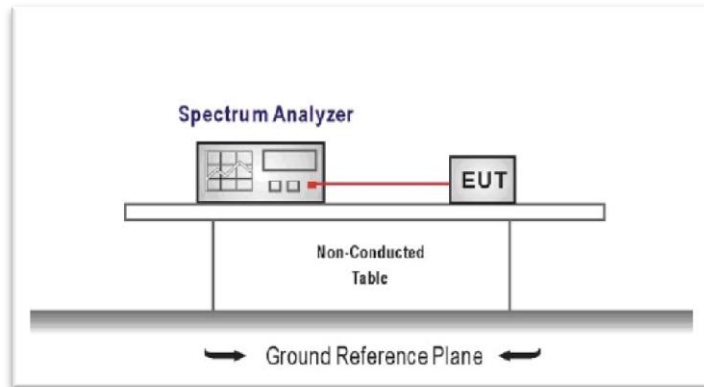

### TEST PROCEDURE

1. Connect the antenna port(s) to the spectrum analyzer input.
2. Establish a reference level by using the following procedure  
Center frequency=DTS channel center frequency  
The span = 1.5 times the DTS bandwidth.  
RBW = 100 kHz, VBW  $\geq 3 \times$  RBW  
Detector = peak, Sweep time = auto couple, Trace mode = max hold  
Allow trace to fully stabilize  
Use the peak marker function to determine the maximum PSD level

Note that the channel found to contain the maximum PSD level can be used to establish the reference level.

3. Emission level measurement  
Set the center frequency and span to encompass frequency range to be measured  
RBW = 100 kHz, VBW  $\geq 3 \times$  RBW  
Detector = peak, Sweep time = auto couple, Trace mode = max hold  
Allow trace to fully stabilize  
Use the peak marker function to determine the maximum amplitude level.
4. Place the radio in continuous transmit mode, allow the trace to stabilize, view the transmitter waveform on the spectrum analyzer.
5. Ensure that the amplitude of all unwanted emissions outside of the authorized frequency band excluding restricted frequency bands) are attenuated by at least the minimum requirements specified (at least 20 dB relative to the maximum in-band peak PSD level in 100 kHz). Report the three highest emissions relative to the limit.

### TEST MODE:

Please refer to the clause 3.3

### TEST RESULTS

Passed       Not Applicable

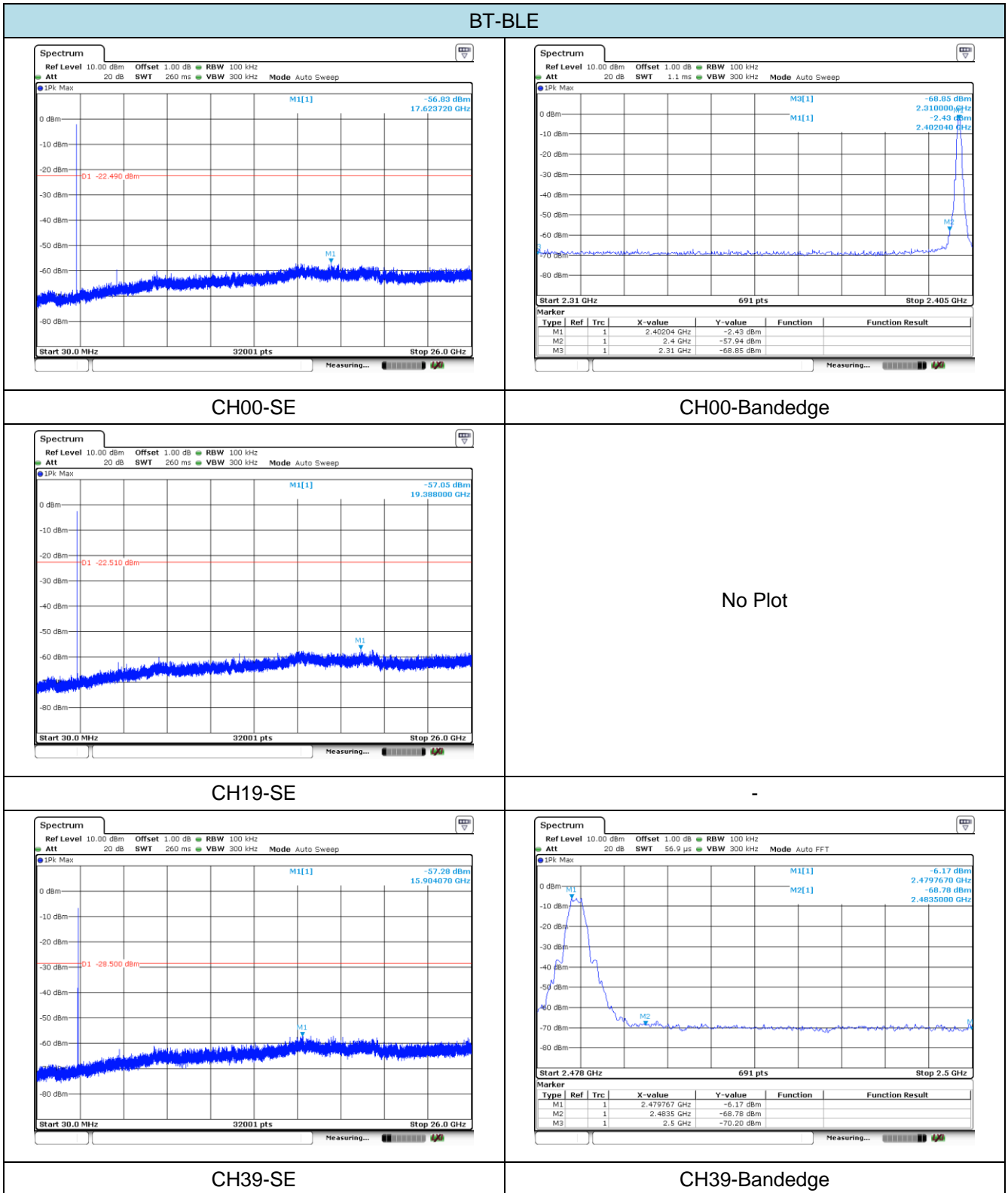

### 5.8. Spurious Emission (radiated)

**LIMIT**

**FCC CFR Title 47 Part 15 Subpart C Section 15.209**

| Frequency     | Limit (dBuV/m @3m) | Value      |
|---------------|--------------------|------------|
| 30MHz-88MHz   | 40.00              | Quasi-peak |
| 88MHz-216MHz  | 43.50              | Quasi-peak |
| 216MHz-960MHz | 46.00              | Quasi-peak |
| 960MHz-1GHz   | 54.00              | Quasi-peak |
| Above 1GHz    | 54.00              | Average    |
|               | 74.00              | Peak       |

**TEST CONFIGURATION**

- 9 kHz ~ 30 MHz

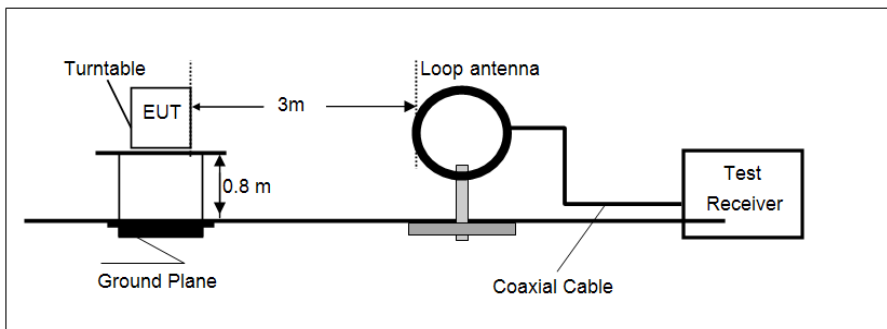

- 30 MHz ~ 1 GHz

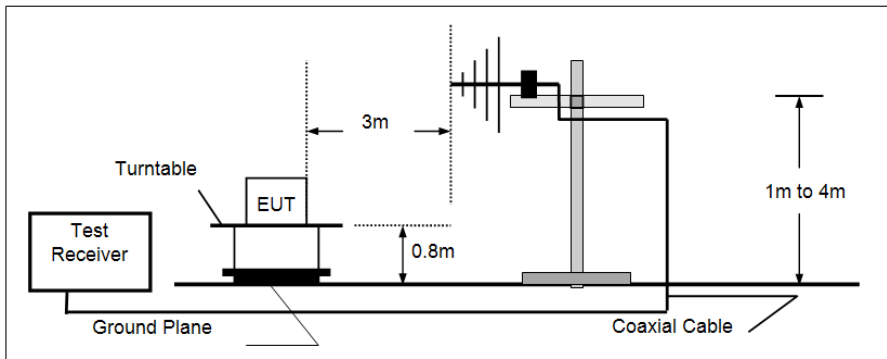

- Above 1 GHz

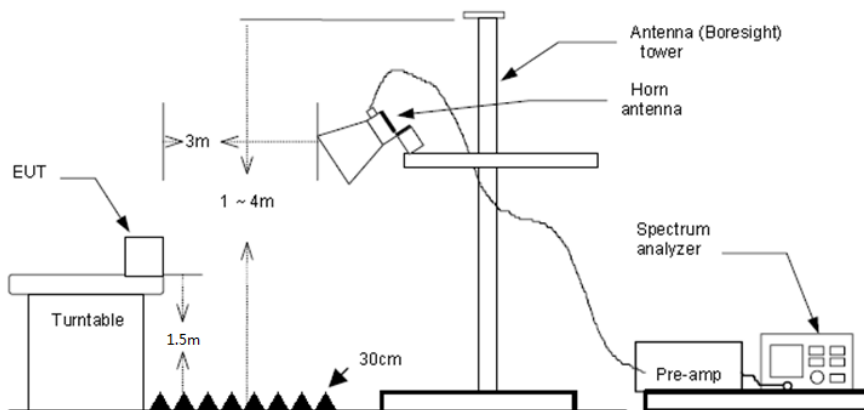

### TEST PROCEDURE

1. The EUT was setup and tested according to ANSI C63.10:2013 for compliance to FCC 47CFR 15.247 requirements.
2. The EUT is placed on a turn table which is 0.8 meter above ground for below 1 GHz, and 1.5 m for above 1 GHz. The turn table is rotated 360 degrees to determine the position of the maximum emission level.
3. The EUT was positioned such that the distance from antenna to the EUT was 3 meters.
4. The antenna is scanned from 1 meter to 4 meters to find out the maximum emission level. This is repeated for both horizontal and vertical polarization of the antenna. In order to find the maximum emission, all of the interface cables were manipulated according to ANSI C63.10:2013 on radiated measurement.
5. Use the following spectrum analyzer settings
  - (1) Span shall wide enough to fully capture the emission being measured;
  - (2) Below 1 GHz, RBW=120 kHz, VBW=300 kHz, Sweep=auto, Detector function=peak, Trace=max hold; If the emission level of the EUT measured by the peak detector is 3 dB lower than the applicable limit, the peak emission level will be reported. Otherwise, the emission measurement will be repeated using the quasi-peak detector and reported.
  - (3) Above 1 GHz, RBW=1 MHz, VBW=3 MHz for Peak value  
RBW=1 MHz, VBW=3 MHz RMS detector for Average value.

### TEST MODE:

Please refer to the clause 3.3

### TEST RESULTS

**Passed**       **Not Applicable**

Note:

- 1) Above 1GHz Final Level =Receiver Read level + Antenna Factor + Cable Loss – Preamplifier Factor
  - 2) The emission levels of other frequencies are very lower than the limit and not show in test report.
- **9 kHz ~ 30 MHz**  
The EUT was pre-scanned the frequency band (9 kHz ~ 30 MHz), found the radiated level lower than the limit, so don't show on the report.
- **30 MHz ~ 1000 MHz**  
Have pre-scan all modulation mode, found the BT-BLE mode CH39 which it was worst case, so only the worst case's data on the test report.



➤ 30 MHz ~ 1 GHz

Polarization: Vertical

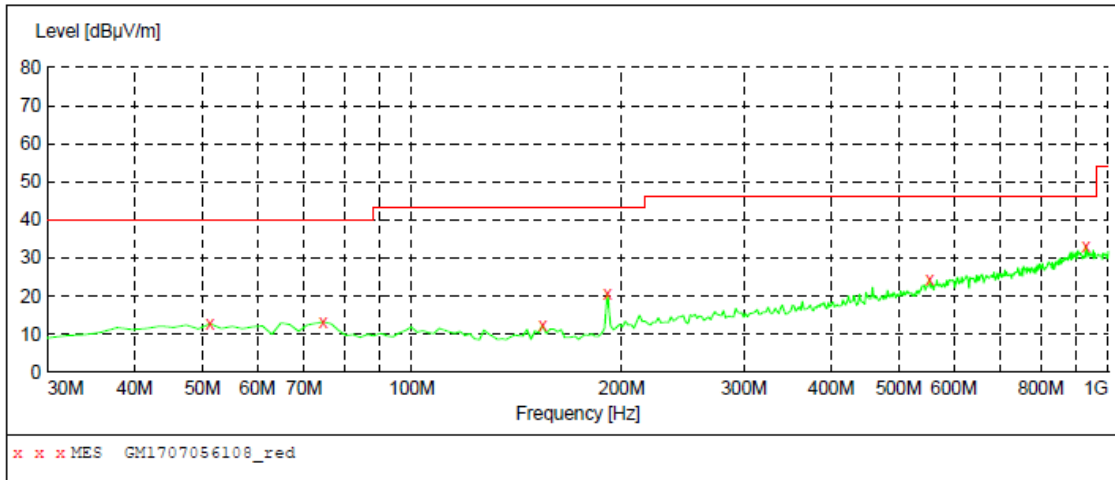

**MEASUREMENT RESULT: "GM1707056108\_red"**

7/5/2017 11:22PM

| Frequency<br>MHz | Level<br>dBµV/m | Transd<br>dB | Limit<br>dBµV/m | Margin<br>dB | Det. | Height<br>cm | Azimuth<br>deg | Polarization |
|------------------|-----------------|--------------|-----------------|--------------|------|--------------|----------------|--------------|
| 51.340000        | 12.80           | -16.3        | 40.0            | 27.2         | QP   | 100.0        | 219.00         | VERTICAL     |
| 74.620000        | 13.20           | -20.0        | 40.0            | 26.8         | QP   | 100.0        | 160.00         | VERTICAL     |
| 154.160000       | 12.40           | -19.8        | 43.5            | 31.1         | QP   | 100.0        | 242.00         | VERTICAL     |
| 191.020000       | 20.70           | -17.0        | 43.5            | 22.8         | QP   | 100.0        | 5.00           | VERTICAL     |
| 553.800000       | 24.50           | -6.1         | 46.0            | 21.5         | QP   | 100.0        | 219.00         | VERTICAL     |
| 928.220000       | 33.20           | 1.4          | 46.0            | 12.8         | QP   | 100.0        | 97.00          | VERTICAL     |

Polarization: Horizontal

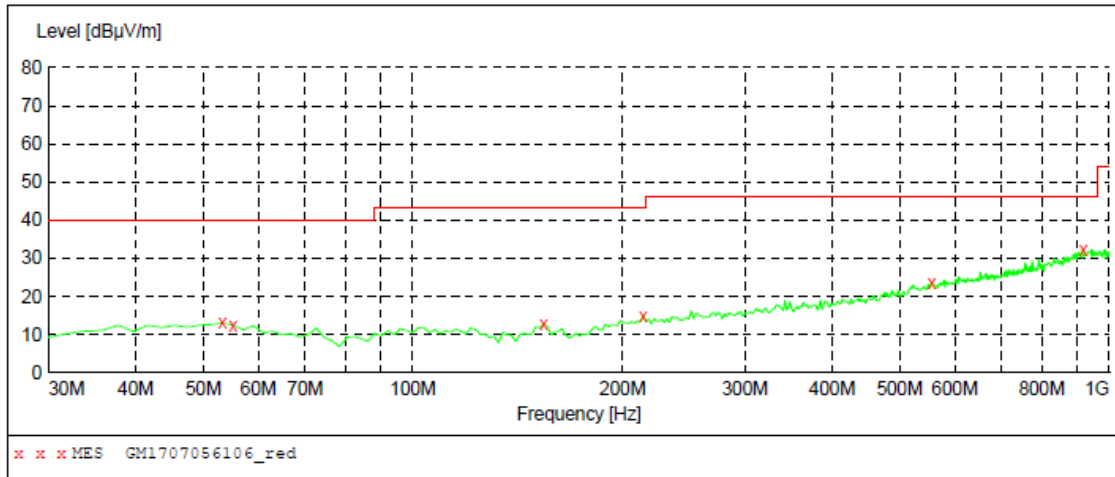

**MEASUREMENT RESULT: "GM1707056106\_red"**

7/5/2017 11:17PM

| Frequency<br>MHz | Level<br>dBµV/m | Transd<br>dB | Limit<br>dBµV/m | Margin<br>dB | Det. | Height<br>cm | Azimuth<br>deg | Polarization |
|------------------|-----------------|--------------|-----------------|--------------|------|--------------|----------------|--------------|
| 53.280000        | 13.10           | -16.5        | 40.0            | 26.9         | QP   | 100.0        | 307.00         | HORIZONTAL   |
| 55.220000        | 12.50           | -16.7        | 40.0            | 27.5         | QP   | 300.0        | 31.00          | HORIZONTAL   |
| 154.160000       | 12.70           | -19.8        | 43.5            | 30.8         | QP   | 300.0        | 253.00         | HORIZONTAL   |
| 214.300000       | 14.90           | -15.5        | 43.5            | 28.6         | QP   | 100.0        | 290.00         | HORIZONTAL   |
| 555.740000       | 23.50           | -6.0         | 46.0            | 22.5         | QP   | 300.0        | 195.00         | HORIZONTAL   |
| 916.580000       | 32.40           | 1.3          | 46.0            | 13.6         | QP   | 100.0        | 84.00          | HORIZONTAL   |

## ➤ Above 1 GHz

| BT-BLE          |                   |                       |                 |                    | CH00           |                     |                   |              |            |
|-----------------|-------------------|-----------------------|-----------------|--------------------|----------------|---------------------|-------------------|--------------|------------|
| Frequency (MHz) | Read Level (dBuV) | Antenna Factor (dB/m) | Cable Loss (dB) | Preamp Factor (dB) | Level (dBuV/m) | Limit Line (dBuV/m) | Margin Limit (dB) | Polarization | Test value |
| 1280.07         | 36.56             | 26.22                 | 4.80            | 36.53              | 31.05          | 74.00               | -42.95            | Vertical     | Peak       |
| 3266.35         | 36.21             | 28.40                 | 7.80            | 38.32              | 34.09          | 74.00               | -39.91            | Vertical     |            |
| 5086.52         | 33.14             | 31.85                 | 9.74            | 36.31              | 38.42          | 74.00               | -35.58            | Vertical     |            |
| 7209.02         | 33.94             | 36.21                 | 11.87           | 35.07              | 46.95          | 74.00               | -27.05            | Vertical     |            |
| 1280.07         | 37.58             | 26.22                 | 4.80            | 36.53              | 32.07          | 74.00               | -41.93            | Horizontal   | Peak       |
| 2241.03         | 34.95             | 27.75                 | 6.51            | 37.45              | 31.76          | 74.00               | -42.24            | Horizontal   |            |
| 4809.50         | 40.39             | 31.58                 | 9.55            | 36.93              | 44.59          | 74.00               | -29.41            | Horizontal   |            |
| 7921.00         | 33.24             | 36.78                 | 12.68           | 34.74              | 47.96          | 74.00               | -26.04            | Horizontal   |            |

| BT-BLE          |                   |                       |                 |                    | CH19           |                     |                   |              |            |
|-----------------|-------------------|-----------------------|-----------------|--------------------|----------------|---------------------|-------------------|--------------|------------|
| Frequency (MHz) | Read Level (dBuV) | Antenna Factor (dB/m) | Cable Loss (dB) | Preamp Factor (dB) | Level (dBuV/m) | Limit Line (dBuV/m) | Margin Limit (dB) | Polarization | Test value |
| 1948.25         | 36.24             | 25.79                 | 6.19            | 37.26              | 30.96          | 74.00               | -43.04            | Vertical     | Peak       |
| 3616.45         | 35.78             | 29.30                 | 8.29            | 38.27              | 35.10          | 74.00               | -38.90            | Vertical     |            |
| 4883.52         | 44.73             | 31.43                 | 9.59            | 36.73              | 49.02          | 74.00               | -24.98            | Vertical     |            |
| 8022.46         | 32.43             | 37.08                 | 12.35           | 34.53              | 47.33          | 74.00               | -26.67            | Vertical     |            |
| 4883.52         | 28.53             | 31.43                 | 9.59            | 36.73              | 32.82          | 54.00               | -21.18            | Vertical     | Average    |
| 1413.67         | 36.58             | 25.89                 | 5.04            | 36.48              | 31.03          | 74.00               | -42.97            | Horizontal   | Peak       |
| 3854.08         | 35.67             | 29.65                 | 8.58            | 38.20              | 35.70          | 74.00               | -38.30            | Horizontal   |            |
| 4883.52         | 54.46             | 31.43                 | 9.59            | 36.73              | 58.75          | 74.00               | -15.25            | Horizontal   |            |
| 7319.96         | 39.87             | 36.30                 | 11.99           | 34.92              | 53.24          | 74.00               | -20.76            | Horizontal   |            |
| 4883.52         | 34.73             | 31.43                 | 9.59            | 36.73              | 39.02          | 54.00               | -14.98            | Horizontal   | Average    |
| 7319.96         | 22.88             | 36.30                 | 11.99           | 34.92              | 36.25          | 54.00               | -17.75            | Horizontal   |            |

| BT-BLE          |                   |                       |                 |                    | CH39           |                     |                   |              |            |
|-----------------|-------------------|-----------------------|-----------------|--------------------|----------------|---------------------|-------------------|--------------|------------|
| Frequency (MHz) | Read Level (dBuV) | Antenna Factor (dB/m) | Cable Loss (dB) | Preamp Factor (dB) | Level (dBuV/m) | Limit Line (dBuV/m) | Margin Limit (dB) | Polarization | Test value |
| 1732.97         | 35.23             | 25.27                 | 5.83            | 37.00              | 29.33          | 74.00               | -44.67            | Vertical     | Peak       |
| 3795.66         | 34.75             | 29.59                 | 8.50            | 38.23              | 34.61          | 74.00               | -39.39            | Vertical     |            |
| 4958.68         | 42.93             | 31.46                 | 9.64            | 36.52              | 47.51          | 74.00               | -26.49            | Vertical     |            |
| 7451.57         | 33.61             | 36.20                 | 12.24           | 34.86              | 47.19          | 74.00               | -26.81            | Vertical     |            |
| 1476.19         | 34.89             | 25.82                 | 5.22            | 36.56              | 29.37          | 74.00               | -44.63            | Horizontal   |            |
| 3534.54         | 34.25             | 29.10                 | 8.17            | 38.36              | 33.16          | 74.00               | -40.84            | Horizontal   |            |
| 4958.68         | 42.57             | 31.46                 | 9.64            | 36.52              | 47.15          | 74.00               | -26.85            | Horizontal   |            |
| 7451.57         | 36.09             | 36.20                 | 12.24           | 34.86              | 49.67          | 74.00               | -24.33            | Horizontal   |            |

Remark:

1. Final Level = Receiver Read level + Antenna Factor + Cable Loss – Preamplifier Factor
2. The peak level is lower than average limit (54 dBuV/m), this data is the too weak instrument of signal is unable to test.
3. The emission levels of other frequencies are very lower than the limit and not show in test report.

## 6. Test Setup Photos of the EUT

Radiated Emission

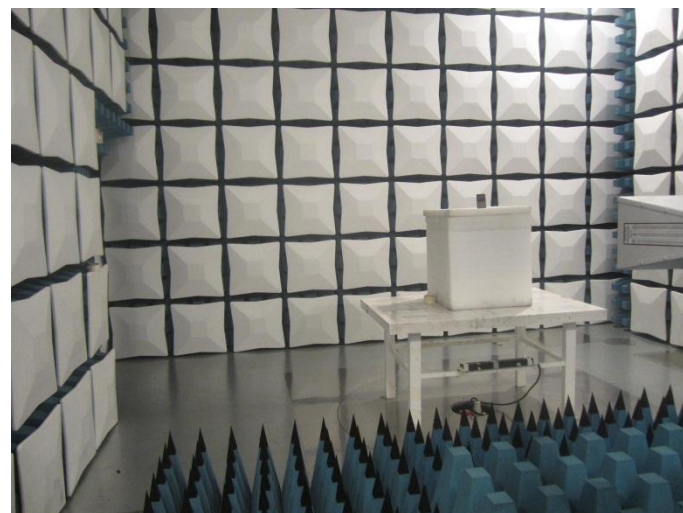

Conducted Emission (AC Mains)



## 7. External and Internal Photos of the EUT

Reference to Test Report No.: TRE1706030401.

.....**End of Report**.....