



FCC REPORT

Report Reference No...... : **TRE1706030401** R/C.....: 34055
FCC ID..... : **QRP-AZUMIROA45QL**
Applicant's name..... : **Azumi S.A**
 Address.....: Avenida Aquilino de la Guarcia con Calle 47, PH Ocean Plaza, Piso 16 of. 16-01, Marbella, Ciudad de Panama, Panama
 Manufacturer.....: AZUMI HK LTD
 Address.....: FLAT/RM 18 BLK 1 14/F GOLDEN INDUSTRIAL BUILDING 16-26 KWAI TAK STREET KWAI CHUNG,HK
Test item description : **4G Mobile Phone**
 Trade Mark: Azumi
 Model/Type reference.....: IRO A45 QL
 Listed Model(s): -
Standard : **FCC Part 22: PUBLIC MOBILE SERVICES**
FCC Part 24: PERSONAL COMMUNICATIONS SERVICES
 Date of receipt of test sample.....: Jun.29, 2017
 Date of testing.....: Jun.30, 2017 - Jul.16, 2017
 Date of issue.....: Jul.17, 2017
Result.....: **Pass**

Compiled by
 (position+printedname+signature)....: File administrators Candy Liu

Candy Liu

Supervised by
 (position+printedname+signature)....: Project Engineer Lion Cai

Lion Cai

Approved by
 (position+printedname+signature)....: Manager Hans Hu

Hans Hu

Testing Laboratory Name : **Shenzhen Huatongwei International Inspection Co., Ltd.**
 Address.....: 1/F, Bldg 3, Hongfa Hi-tech Industrial Park, Genyu Road, Tianliao, Gongming, Shenzhen, China

Shenzhen Huatongwei International Inspection Co., Ltd. All rights reserved.

This publication may be reproduced in whole or in part for non-commercial purposes as long as the Shenzhen Huatongwei International Inspection Co., Ltd. is acknowledged as copyright owner and source of the material. Shenzhen Huatongwei International Inspection Co., Ltd. takes no responsibility for and will not assume liability for damages resulting from the reader's interpretation of the reproduced material due to its placement and context.

Contents

1.	<u>TEST STANDARDS AND REPORT VERSION</u>	3
1.1.	Applicable Standards	3
1.2.	Report version	3
2.	<u>TEST DESCRIPTION</u>	4
3.	<u>SUMMARY</u>	5
3.1.	Client Information	5
3.2.	Product Description	5
3.3.	Operation state	6
3.4.	EUT configuration	6
3.5.	Modifications	6
4.	<u>TEST ENVIRONMENT</u>	7
4.1.	Address of the test laboratory	7
4.2.	Test Facility	7
4.3.	Equipments Used during the Test	8
4.4.	Environmental conditions	9
4.5.	Statement of the measurement uncertainty	9
5.	<u>TEST CONDITIONS AND RESULTS</u>	10
5.1.	Conducted Output Power	10
5.2.	99% & -26 dB Occupied Bandwidth	12
5.3.	Conducted Spurious Emissions	22
5.4.	Band Edge	27
5.5.	ERP and EIRP	37
5.6.	Radiated Spurious Emission	40
5.7.	Frequency stability V.S. Temperature measurement	46
5.8.	Frequency stability V.S. Voltage measurement	48
5.9.	Peak-Average Ratio	50
6.	<u>TEST SETUP PHOTOS OF THE EUT</u>	53
7.	<u>EXTERNAL AND INTERNAL PHOTOS OF THE EUT</u>	54

1. Test standards and Report version

1.1. Applicable Standards

The tests were performed according to following standards:

[FCC Part 22](#):PRIVATE LAND MOBILE RADIO SERVICES.

[FCC Part 24](#):PUBLIC MOBILE SERVICES

[TIA/EIA 603 D June 2010](#):Land Mobile FM or PM Communications Equipment Measurement and Performance Standards.

[FCC Part 2](#):FREQUENCY ALLOCA-TIONS AND RADIO TREATY MAT-TERS; GENERAL RULES AND REG-ULATIONS

[971168 D01 Power Meas License Digital Systems v02r02](#):provides a methodology for fully characterizing the fundamental power of wideband (> 1 MHz) digitally modulated RF signals acceptable to the FCC for demonstrating compliance for licensed transmitters.

1.2. Report version

Version No.	Date of issue	Description
00	Jul.17, 2017	Original

2. Test Description

Test Item	Section in CFR 47	Result
RF Output Power	Part 2.1046 Part 22.913(a) Part 24.232(c)	Pass
99% & -26 dB Occupied Bandwidth	Part 2.1049 Part 22.917(b) Part 24.238(b)	Pass
Conducted Spurious Emissions	Part 2.1051 Part 22.917 Part 24.238	Pass
Band Edge	Part 2.1051 Part 22.917 Part 24.238	Pass
ERP and EIRP	Part 22.913(a) Part 24.232(b)	Pass
Radiated Spurious Emissions	Part 2.1053 Part 22.917 Part 24.238	Pass
Frequency stability vs. temperature	Part 2.1055(a)(1)(b) Part 22.255 Part 24.235	Pass
Frequency stability vs. voltage	Part 2.1055(d)(1)(2) Part 22.255 Part 24.235	Pass
Peak-Average Ratio	Part 24.232	Pass

Note: The measurement uncertainty is not included in the test result.

3. SUMMARY

3.1. Client Information

Applicant:	Azumi S.A
Address:	Avenida Aquilino de la Guardia con Calle 47, PH Ocean Plaza, Piso 16 of. 16-01, Marbella, Ciudad de Panama, Panama
Manufacturer:	AZUMI HK LTD
Address:	FLAT/RM 18 BLK 1 14/F GOLDEN INDUSTRIAL BUILDING 16-26 KWAI TAK STREET KWAI CHUNG,HK

3.2. Product Description

Name of EUT:	4G Mobile Phone
Trade Mark:	Azumi
Model No.:	IRO A45 QL
Listed Model(s):	-
IMEI:	357836080000462
Power supply:	DC 3.7V From internal battery
Adapter information:	Input: 100-240Va.c., 50/60Hz, 0.15A Output: 5Vd.c., 700mA
Hardware version:	AZUMI_IRO_A45_QL_Hardware_V1.0
Software version:	AZUMI_IRO_A45_QL_OM_V01
2G:	
Support Network:	GSM, GPRS, EGPRS
Support Band:	GSM850, PCS1900
Modulation:	GSM/GPRS/EGPRS: GMSK EGPRS: 8PSK
Transmit Frequency:	GSM850: 824.20MHz-848.80MHz PCS1900: 1850.20MHz-1909.80MHz
Receive Frequency:	GSM850: 869.20MHz-893.80MHz PCS1900: 1930.20MHz-1989.80MHz
GPRS Class:	12
EGPRS Class:	12
Antenna type:	Integral Antenna
Antenna gain:	GSM850: -3.0dBi PCS1900: -3.0dBi
3G:	
Operation Band:	FDD Band II and FDD Band V
Power Class:	Power Class 3
Modulation Type:	QPSK/16QAM/64QAM/HSUPA/HSDPA
DC-HSUPA Release Version:	Not Supported
Antenna type:	Integral Antenna
Antenna gain:	Band II: -3.0dBi, Band V: -3.0dBi

3.3. Operation state

➤ Test frequency list

GSM850		PCS1900	
Channel	Frequency (MHz)	Channel	Frequency (MHz)
128	824.20	512	1850.20
190	836.60	661	1880.00
251	848.80	810	1909.80

FDD Band II		FDD Band V	
Channel	Frequency (MHz)	Channel	Frequency (MHz)
9262	1852.4	4132	826.40
9400	1880.0	4183	836.60
9538	1907.6	4233	846.60

➤ Test mode

For RF test items

The EUT has been tested under typical operating condition. The Applicant provides software to control the EUT for staying in continuous transmitting and receiving mode for testing.

3.4. EUT configuration

The following peripheral devices and interface cables were connected during the measurement:

- - supplied by the manufacturer
- - supplied by the lab

	Length (m): /
	Shield: /
	Detachable: /
	Manufacturer: /
	Model No.: /

3.5. Modifications

No modifications were implemented to meet testing criteria.

4. TEST ENVIRONMENT

4.1. Address of the test laboratory

Laboratory: Shenzhen Huatongwei International Inspection Co., Ltd.

Address: 1/F, Bldg 3, Hongfa Hi-tech Industrial Park, Genyu Road, Tianliao, Gongming, Shenzhen, China

Phone: 86-755-26748019 Fax: 86-755-26748089

4.2. Test Facility

The test facility is recognized, certified, or accredited by the following organizations:

CNAS-Lab Code: L1225

Shenzhen Huatongwei International Inspection Co., Ltd. has been assessed and proved to be in compliance with CNAS-CL01 Accreditation Criteria for Testing and Calibration Laboratories (identical to ISO/IEC17025: 2005 General Requirements) for the Competence of Testing and Calibration Laboratories.

A2LA-Lab Cert. No.: 3902.01

Shenzhen Huatongwei International Inspection Co., Ltd. EMC Laboratory has been accredited by A2LA for technical competence in the field of electrical testing, and proved to be in compliance with ISO/IEC 17025: 2005 General Requirements for the Competence of Testing and Calibration Laboratories and any additional program requirements in the identified field of testing.

FCC-Registration No.: 317478

Shenzhen Huatongwei International Inspection Co., Ltd. EMC Laboratory has been registered and fully described in a report filed with the FCC (Federal Communications Commission). The acceptance letter from the FCC is maintained in our files. Registration 317478.

IC-Registration No.: 5377B

Two 3m Alternate Test Site of Shenzhen Huatongwei International Inspection Co., Ltd. has been registered by Certification and Engineering Bureau of Industry Canada for the performance of radiated measurements with Registration No. 5377B.

ACA

Shenzhen Huatongwei International Inspection Co., Ltd. EMC Laboratory can also perform testing for the Australian C-Tick mark as a result of our A2LA accreditation.

4.3. Equipments Used during the Test

Output Power(Conducted) & Occupied Bandwidth & Emission Bandwidth & Band Edge Compliance & Conducted Spurious Emission					
No.	Equipment	Manufacturer	Model No.	SerialNo.	Last Cal.
1	UNIVERSAL RADIO COMMUNICATION	Rohde&Schwarz	CMU200	112012	2016/11/13
2	Spectrum Analyzer	Rohde&Schwarz	FSU26	201141	2016/11/13
3	Splitter	Mini-Circuit	ZAPD-4	400059	2016/11/13

Frequency Stability					
No.	Equipment	Manufacturer	Model No.	SerialNo.	Last Cal.
1	UNIVERSAL RADIO COMMUNICATION	Rohde&Schwarz	CMU200	112012	2016/11/13
2	Spectrum Analyzer	Rohde&Schwarz	FSU26	201141	2016/11/13
3	Climate Chamber	ESPEC	EL-10KA	05107008	2016/11/13
4	Splitter	Mini-Circuit	ZAPD-4	400059	2016/11/13

Output Power (Radiated) & Radiated Spurious Emission					
No.	Equipment	Manufacturer	Model No.	SerialNo.	Last Cal.
1	UNIVERSAL RADIO COMMUNICATION	Rohde&Schwarz	CMU200	112012	2016/11/13
2	Spectrum Analyzer	Rohde&Schwarz	FSU26	201141	2016/11/13
3	HORNANTENNA	ShwarzBeck	9120D	1012	2016/11/13
4	HORNANTENNA	ShwarzBeck	9120D	1011	2016/11/13
5	Ultra-Broadband Antenna	ShwarzBeck	VULB9163	538	2016/11/13
6	Ultra-Broadband Antenna	ShwarzBeck	VULB9163	539	2016/11/13
7	TURNTABLE	MATURO	TT2.0	----	N/A
8	ANTENNA MAST	MATURO	TAM-4.0-P	----	N/A
9	EMI Test Software	Audix	E3	N/A	N/A
10	EMI Test Receiver	Rohde&Schwarz	ESIB 26	100009	2016/11/13
11	RF Test Panel	Rohde&Schwarz	TS / RSP	335015/ 0017	2016/11/13
12	High pass filter	Compliance Direction systems	BSU-6	34202	2016/11/13
13	Splitter	Mini-Circuit	ZAPD-4	400059	2016/11/13
14	Horn Antenna	SCHWARZBECK	BBHA9170	25841	2016/11/13
15	Horn Antenna	SCHWARZBECK	BBHA9170	25842	2016/11/13
16	Preamplifier	ShwarzBeck	BBV 9718	BBV 9718	2016/11/13
17	Broadband Preamplifier	ShwarzBeck	BBV743	9743-0079	2016/11/13
18	Signal Generator	Rohde&Schwarz	SMF100A	101932	2016/11/13
19	Amplifier	Compliance Direction systems	PAP1-4060	120	2016/11/13
20	TURNTABLE	ETS	2088	2149	2016/11/13
21	ANTENNA MAST	ETS	2075	2346	2016/11/13
22	HORNANTENNA	Rohde&Schwarz	HF906	100068	2016/11/13
23	HORNANTENNA	Rohde&Schwarz	HF906	100039	2016/11/13

The calibration interval was one year.

4.4. Environmental conditions

During the measurement the environmental conditions were within the listed ranges:

Normal Temperature/Tnor:	15~35°C
Relative Humidity	30~60 %
Air Pressure	950-1050 hPa

4.5. Statement of the measurement uncertainty

The data and results referenced in this document are true and accurate. The reader is cautioned that there may be errors within the calibration limits of the equipment and facilities. The measurement uncertainty was calculated for all measurements listed in this test report acc. to TR-100028-01 "Electromagnetic compatibility and Radio spectrum Matters (ERM); Uncertainties in the measurement of mobile radio equipment characteristics; Part 1" and TR-100028-02 "Electromagnetic compatibility and Radio spectrum Matters (ERM); Uncertainties in the measurement of mobile radio equipment characteristics; Part 2" and is documented in the Shenzhen Huatongwei International Inspection Co., Ltd quality system acc. to DIN EN ISO/IEC 17025. Furthermore, component and process variability of devices similar to that tested may result in additional deviation. The manufacturer has the sole responsibility of continued compliance of the device.

Hereafter the best measurement capability for Shenzhen Huatongwei laboratory is reported:

Test Items	Measurement Uncertainty	Notes
Frequency stability	25 Hz	(1)
Transmitter power conducted	0.57 dB	(1)
Transmitter power Radiated	2.20 dB	(1)
Conducted spurious emission 9KHz-12.75 GHz	1.60 dB	(1)
Conducted Emission 9KHz-30MHz	3.39 dB	(1)
Radiated Emission 30~1000MHz	4.24 dB	(1)
Radiated Emission 1~18GHz	5.16 dB	(1)
Radiated Emission 18-40GHz	5.54 dB	(1)
Occupied Bandwidth	-----	(1)
Emission Mask	-----	(1)
Modulation Characteristic	-----	(1)
Transmitter Frequency Behavior	-----	(1)

(1) This uncertainty represents an expanded uncertainty expressed at approximately the 95% confidence level using a coverage factor of $k=1.96$.

5. TEST CONDITIONS AND RESULTS

5.1. Conducted Output Power

LIMIT

N/A

TEST CONFIGURATION

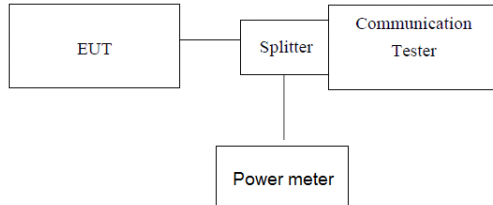

Note: Measurement setup for testing on Antenna connector

TEST PROCEDURE

1. The transmitter output port was connected to base station.
2. The RF output of EUT was connected to the power meter by RF cable and attenuator, the path loss was compensated to the results for each measurement.
3. Set EUT at maximum power through base station.
4. Select lowest, middle, and highest channels for each band and different modulation.
5. Measure the maximum burst average power.

TEST MODE:

Please refer to the clause 3.3

TEST RESULTS

Passed **Not Applicable**

EUT Mode	Channel	Frequency (MHz)	Power (dBm)
GSM 850 (GMSK)	128	824.20	32.48
	190	836.60	32.42
	251	848.80	32.29
GPRS850 (GMSK,1Slot)	128	824.20	32.01
	190	836.60	32.94
	251	848.80	32.82
EGPRS850 (8PSK,1Slot)	128	824.20	26.13
	190	836.60	25.97
	251	848.80	25.75
PCS1900 (GMSK)	512	1850.20	30.94
	661	1880.00	30.35
	810	1909.80	29.94
GPRS1900 (GMSK,1Slot)	512	1850.20	30.93
	661	1880.00	30.37
	810	1909.80	29.96
EGPRS1900 (8PSK,1Slot)	512	1850.20	26.56
	661	1880.00	26.94
	810	1909.80	26.23
WCDMA Band II	9262	1852.40	21.92
	9400	1880.00	21.53
	9538	1907.60	21.48
WCDMA Band V	4132	826.40	21.21
	4183	836.60	21.15
	4233	846.60	21.18

5.2. 99% & -26 dB Occupied Bandwidth

LIMIT

N/A

TEST CONFIGURATION

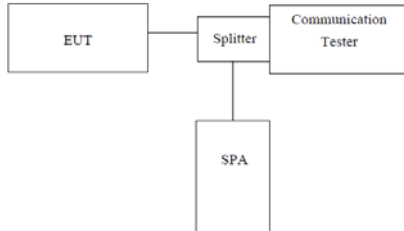

Note: Measurement setup for testing on Antenna connector

TEST PROCEDURE

1. The EUT's output RF connector was connected with a short cable to the spectrum analyzer
2. RBW was set to about 1% of emission BW, VBW= 3 times RBW.
3. -26dBc display line was placed on the screen (or 99% bandwidth), the occupied bandwidth is the delta frequency between the two points where the display line intersects the signal trace.

TEST MODE:

Please refer to the clause 3.3

TEST RESULTS

Passed **Not Applicable**

EUT Mode	Channel	Frequency (MHz)	99% Occupy bandwidth (KHz)	-26dB bandwidth (KHz)
GSM 850 (GMSK)	128	824.20	244.75	321.50
	190	836.60	243.75	318.70
	251	848.80	244.75	323.10
GPRS850 (GMSK,1Slot)	128	824.20	243.75	319.60
	190	836.60	243.75	324.20
	251	848.80	246.75	320.10
EGPRS850 (8PSK,1Slot)	128	824.20	242.75	322.90
	190	836.60	241.75	319.30
	251	848.80	243.75	320.70
PCS1900 (GMSK)	512	1850.20	244.75	317.00
	661	1880.00	245.75	320.10
	810	1909.80	244.75	321.50
GPRS1900 (GMSK,1Slot)	512	1850.20	243.75	318.10
	661	1880.00	244.75	323.30
	810	1909.80	243.75	320.20
EGPRS1900 (8PSK,1Slot)	512	1850.20	257.74	331.90
	661	1880.00	250.74	323.30
	810	1909.80	246.75	322.10
WCDMA Band II	9262	1852.40	4195.80	4863.00
	9400	1880.00	4205.79	4864.00
	9538	1907.60	4185.81	4859.00
WCDMA Band V	4132	826.40	4205.79	4929.00
	4183	836.60	4205.79	4883.00
	4233	846.60	4195.80	4891.00

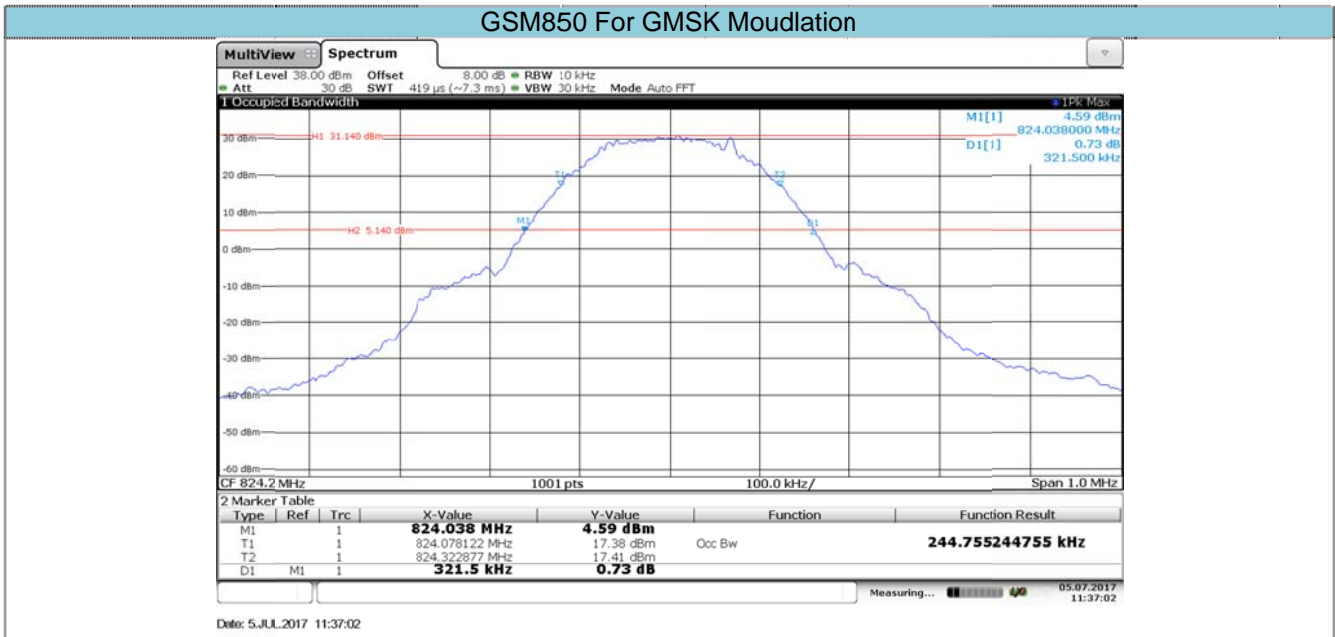

Channel 128

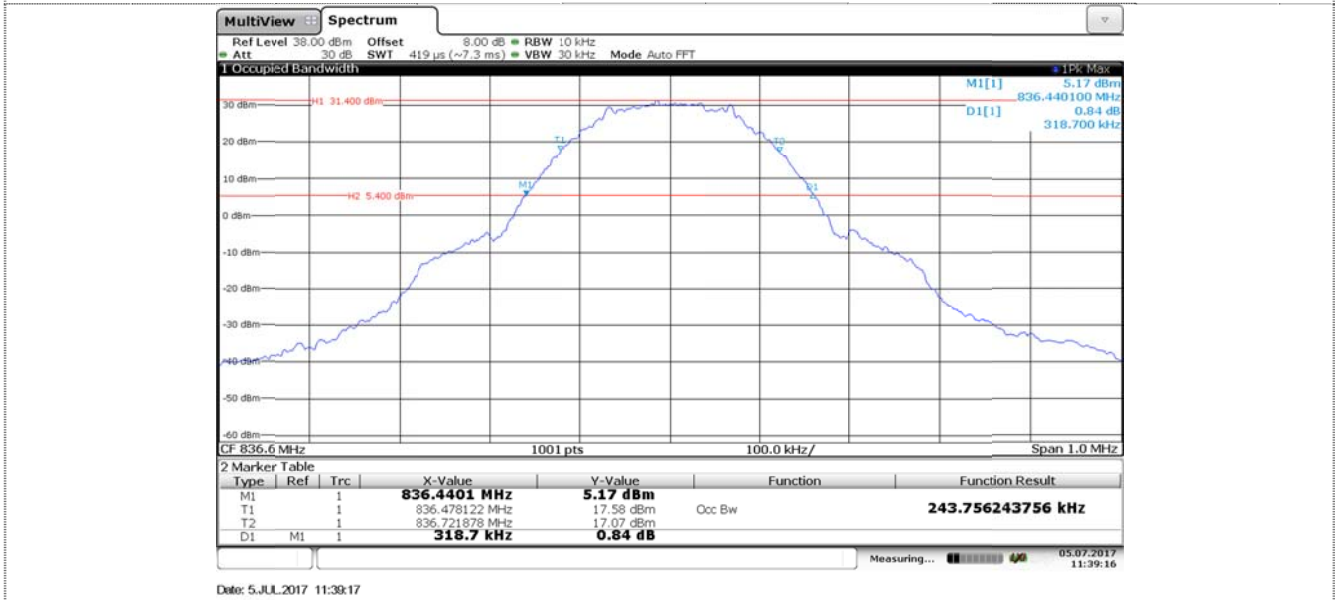

Channel 190

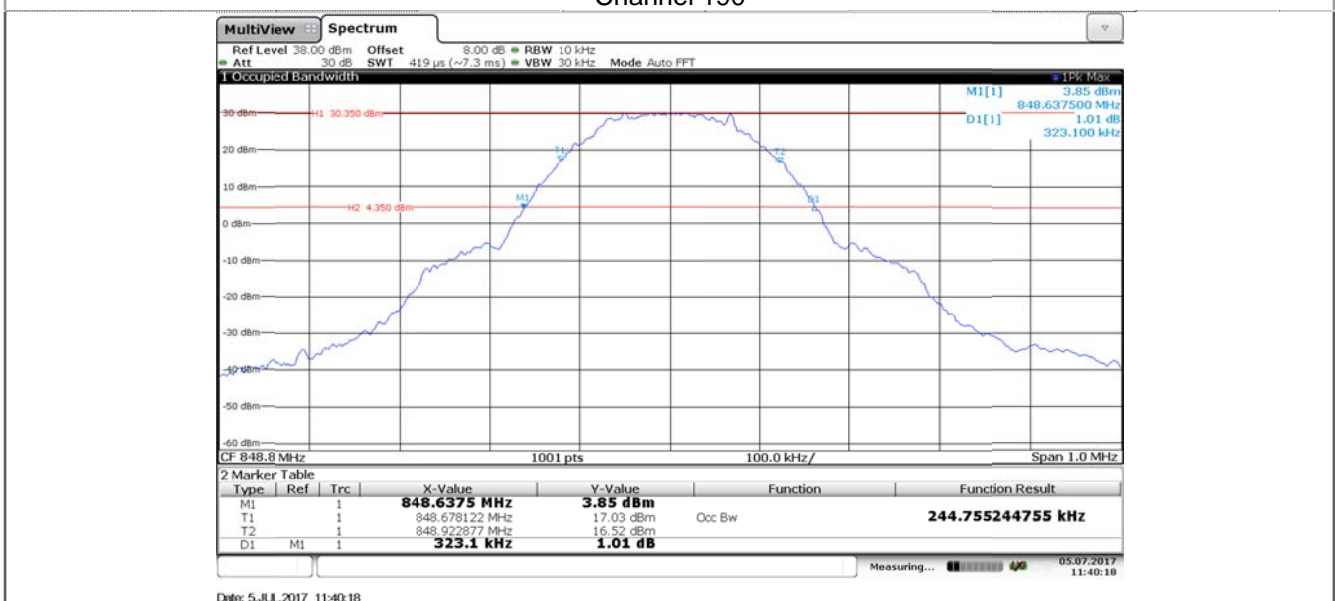

Channel 251

GPRS850 For GMSK Modulation

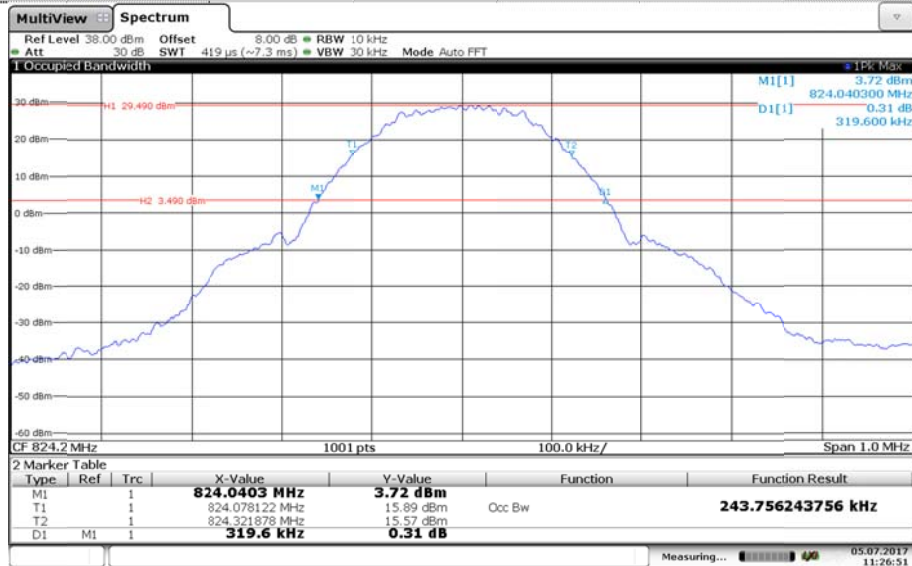

Channel 128

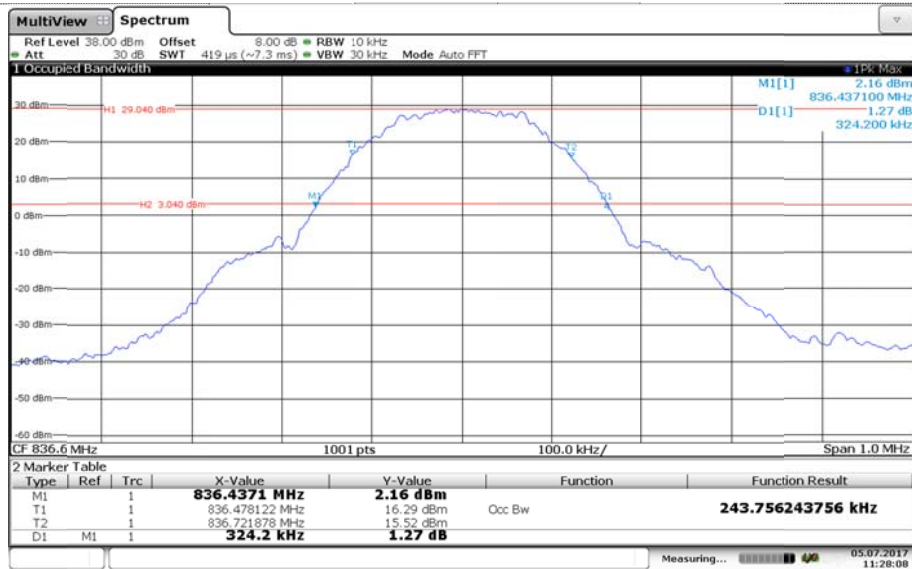

Channel 190

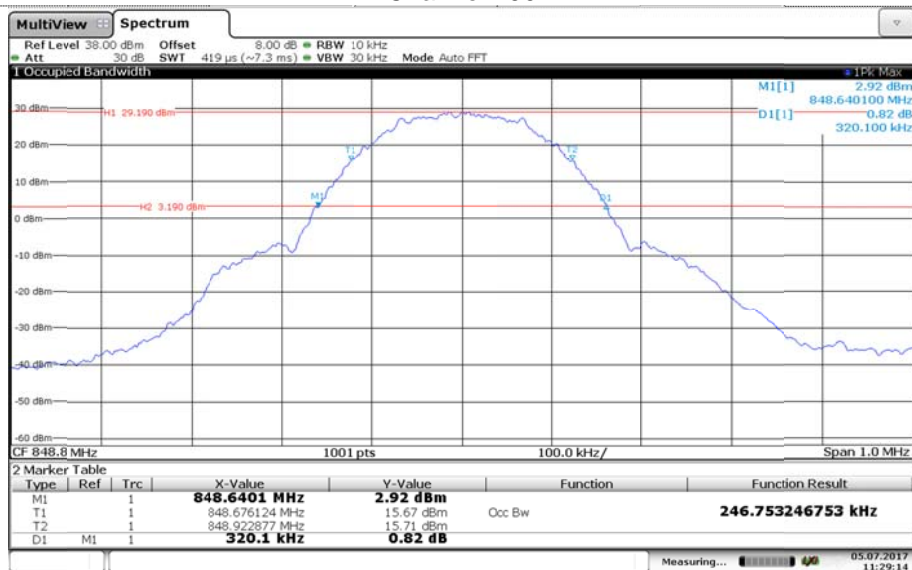

Channel 251

EGPRS850 For 8PSK Modulation

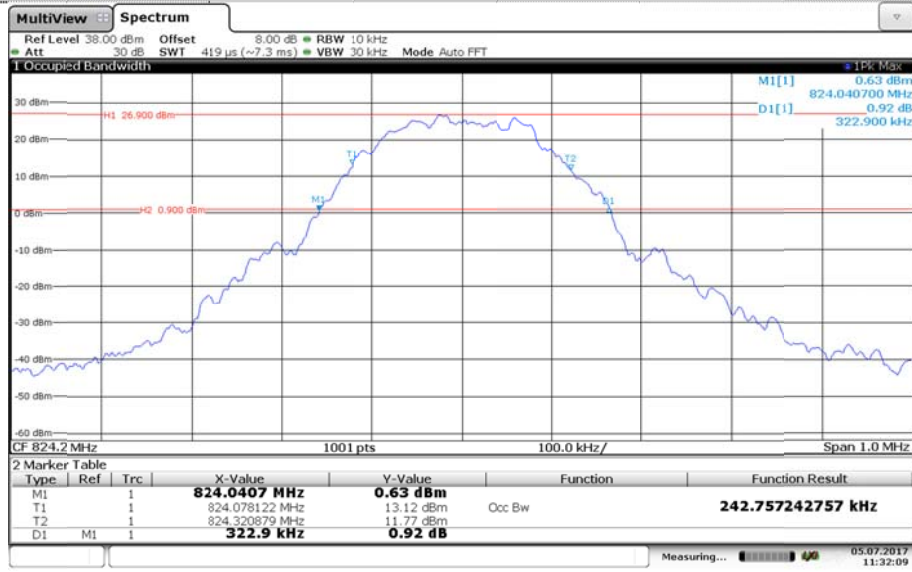

Channel 128

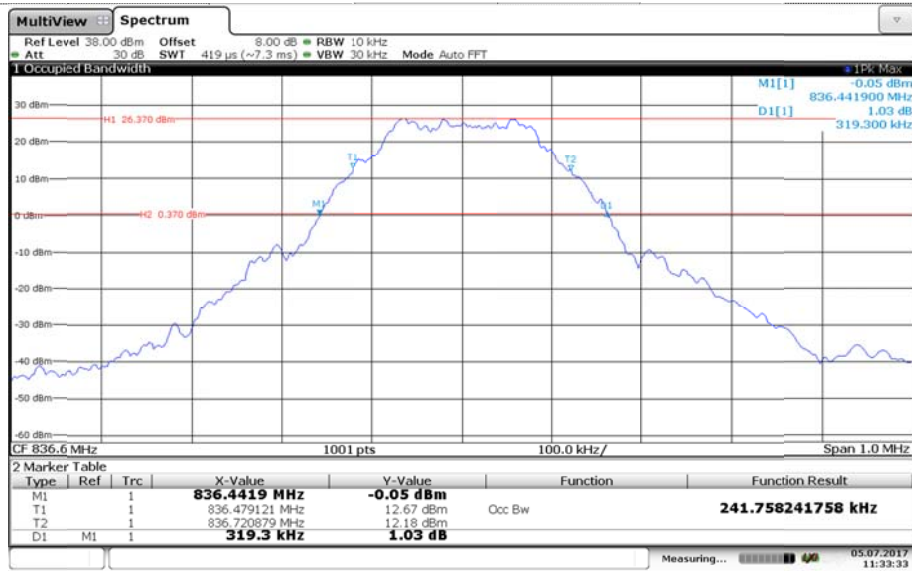

Channel 190

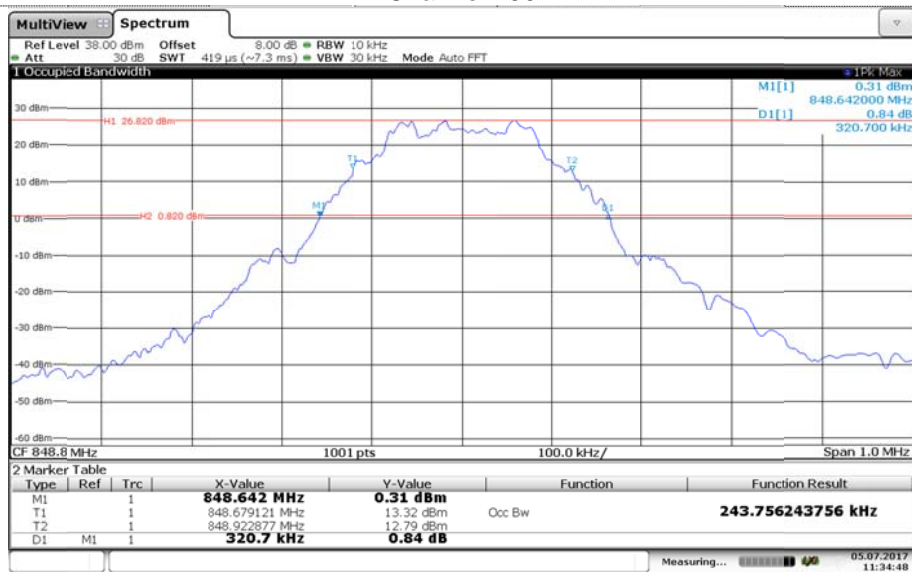

Channel 251

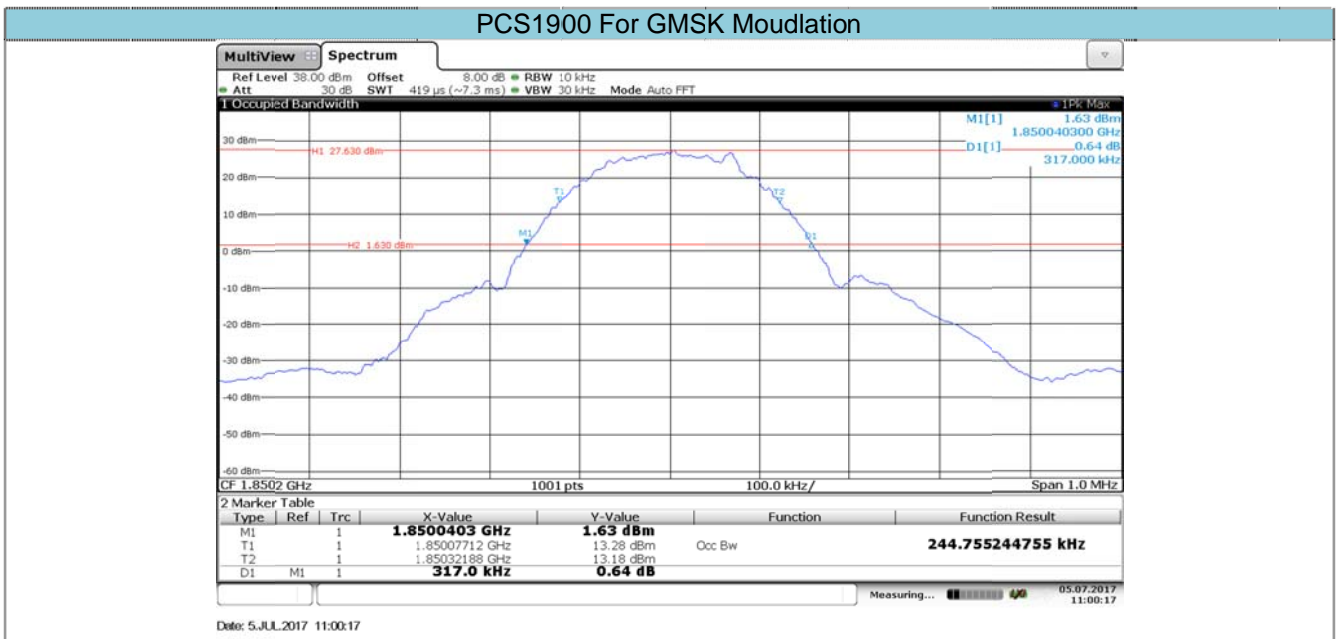

Channel 512

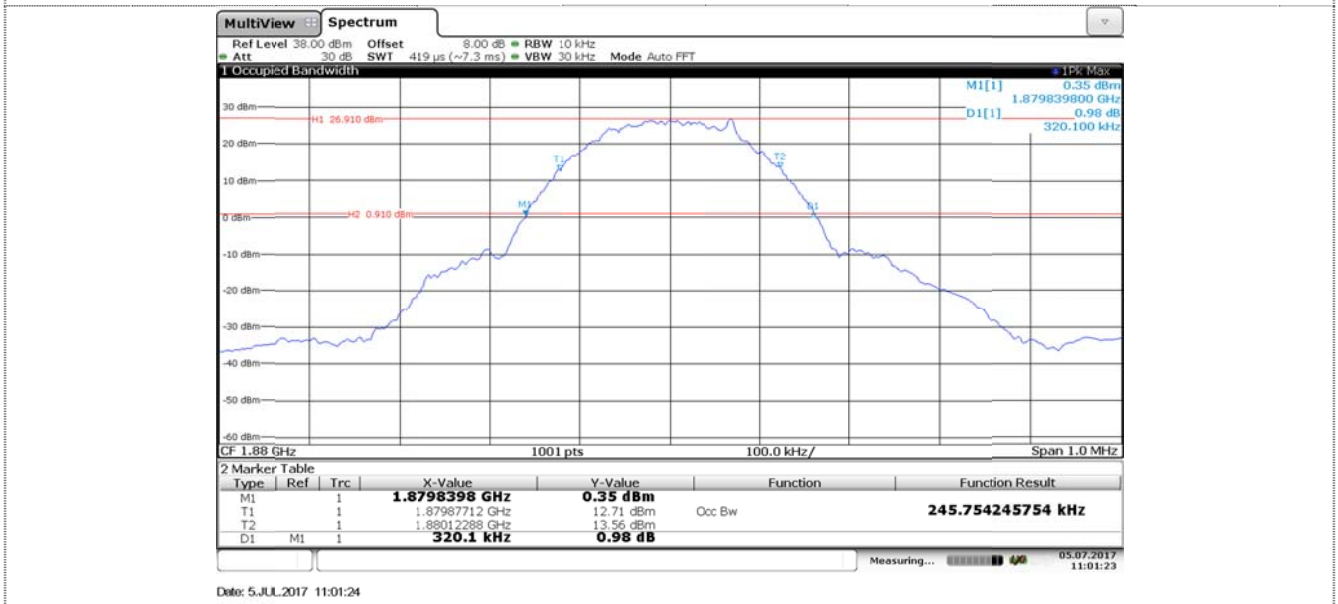

Channel 661



Channel 810

GPRS1900 For GMSK Modulation

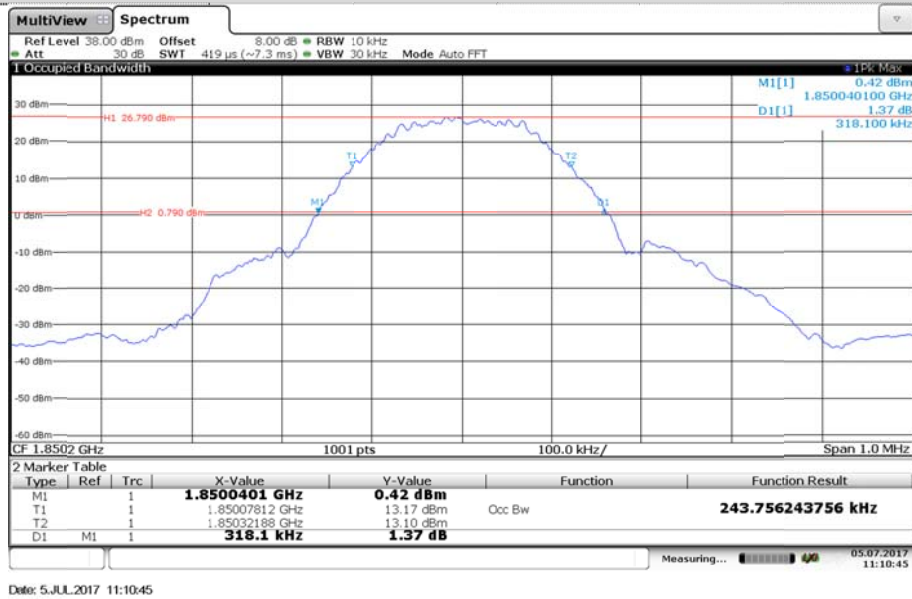

Channel 512



Channel 661

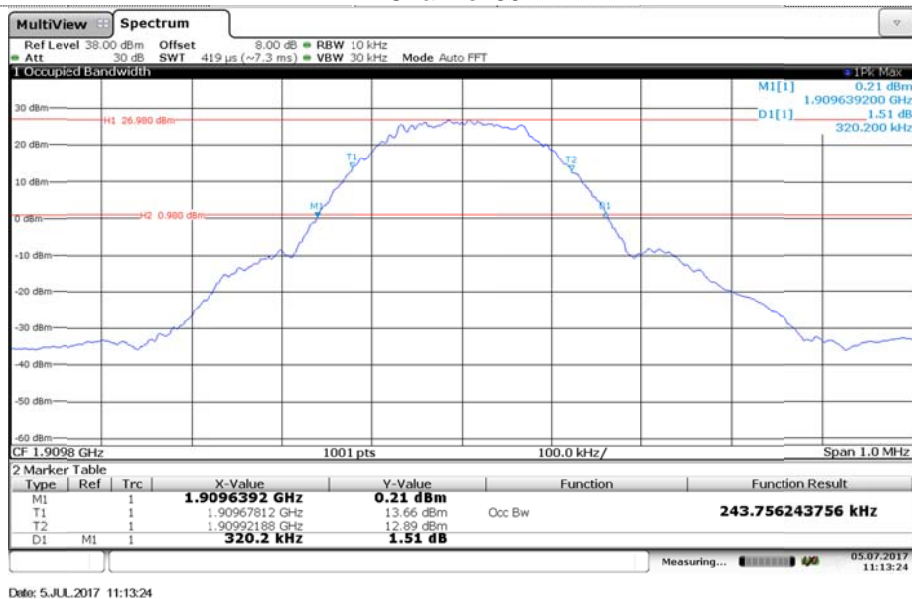

Channel 810

EGPRS1900 For 8PSK Moudlation

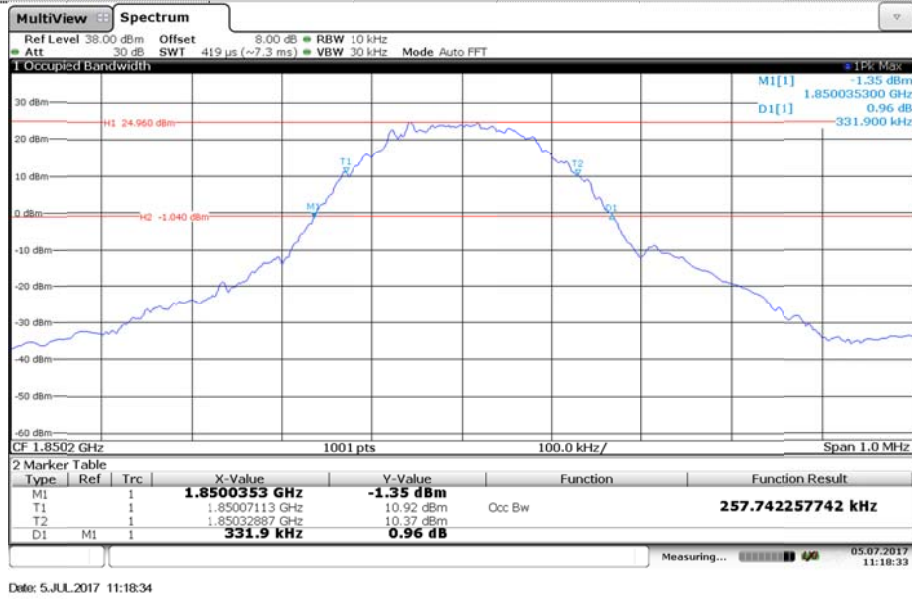

Channel 512

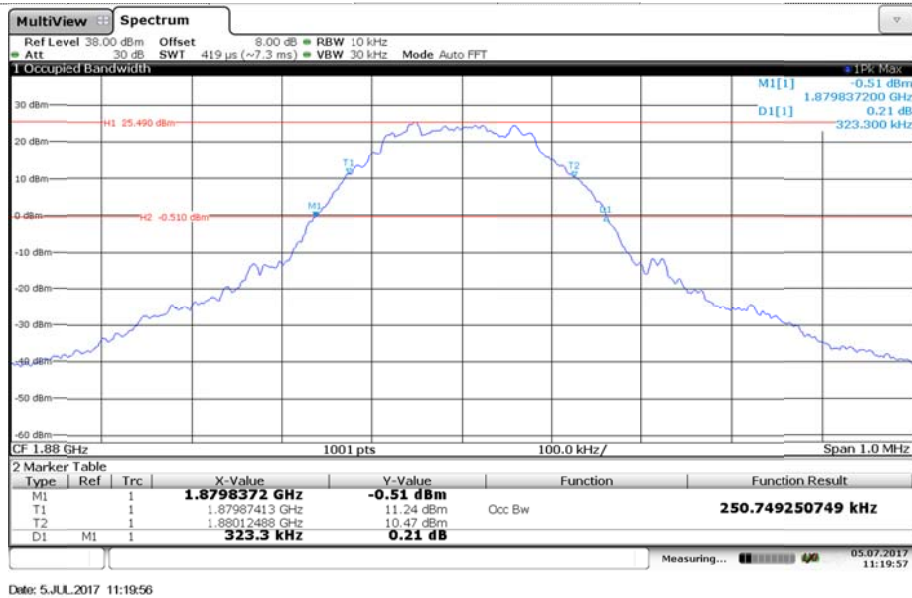

Channel 661

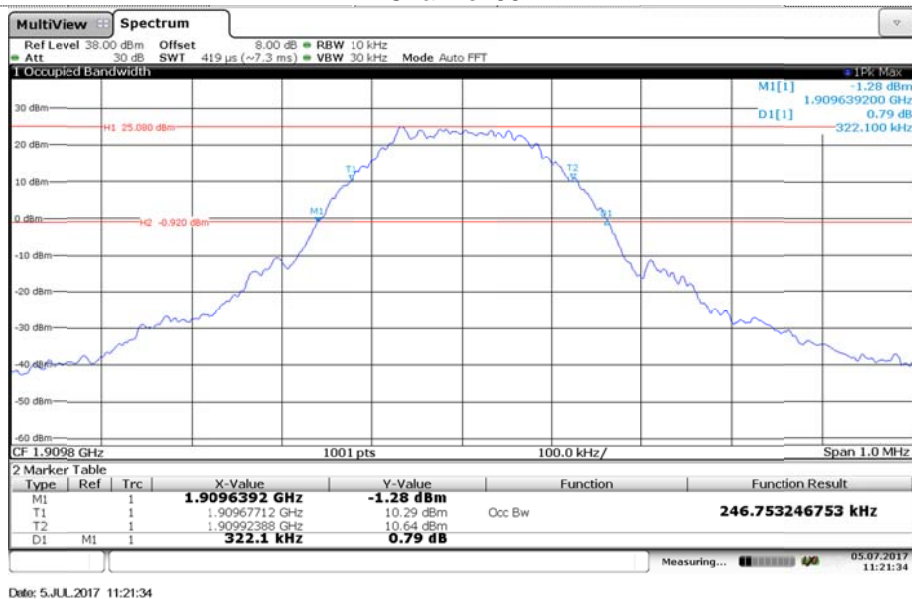

Channel 810

WCDMA Band II

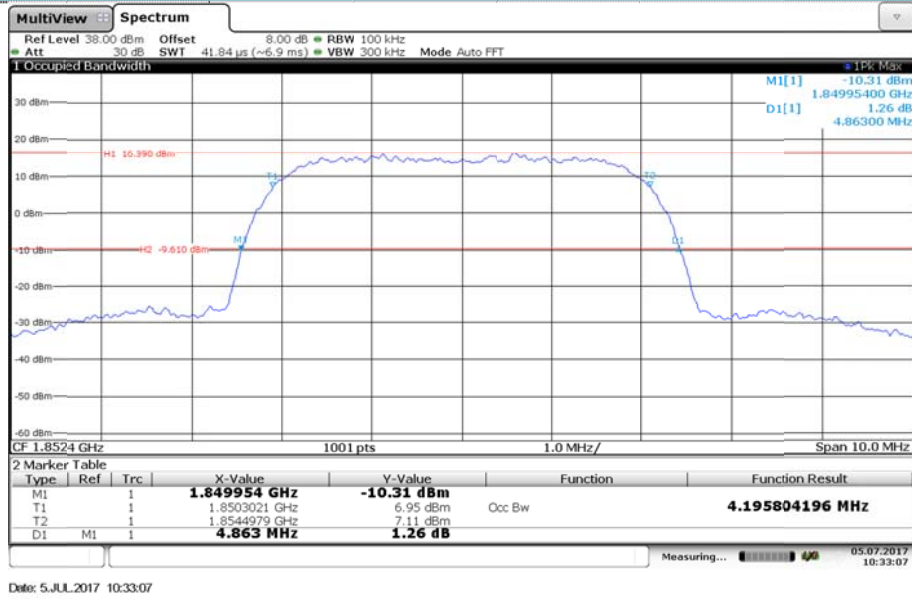

Channel 9262

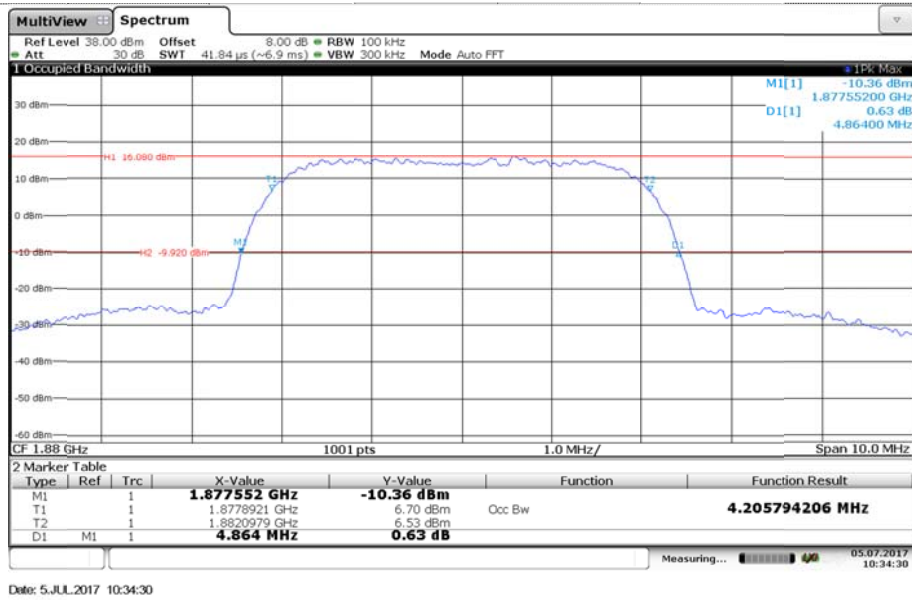

Channel 9400

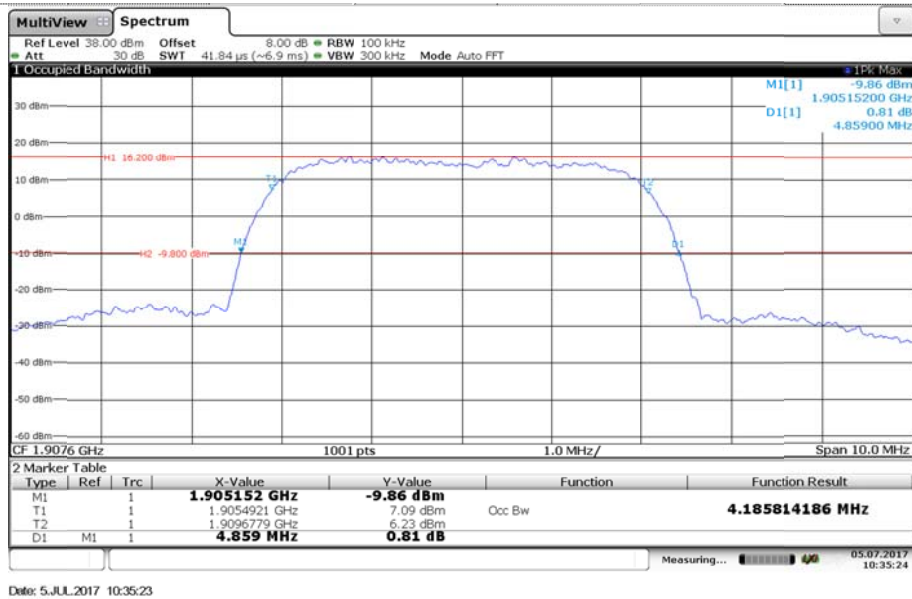

Channel 9538

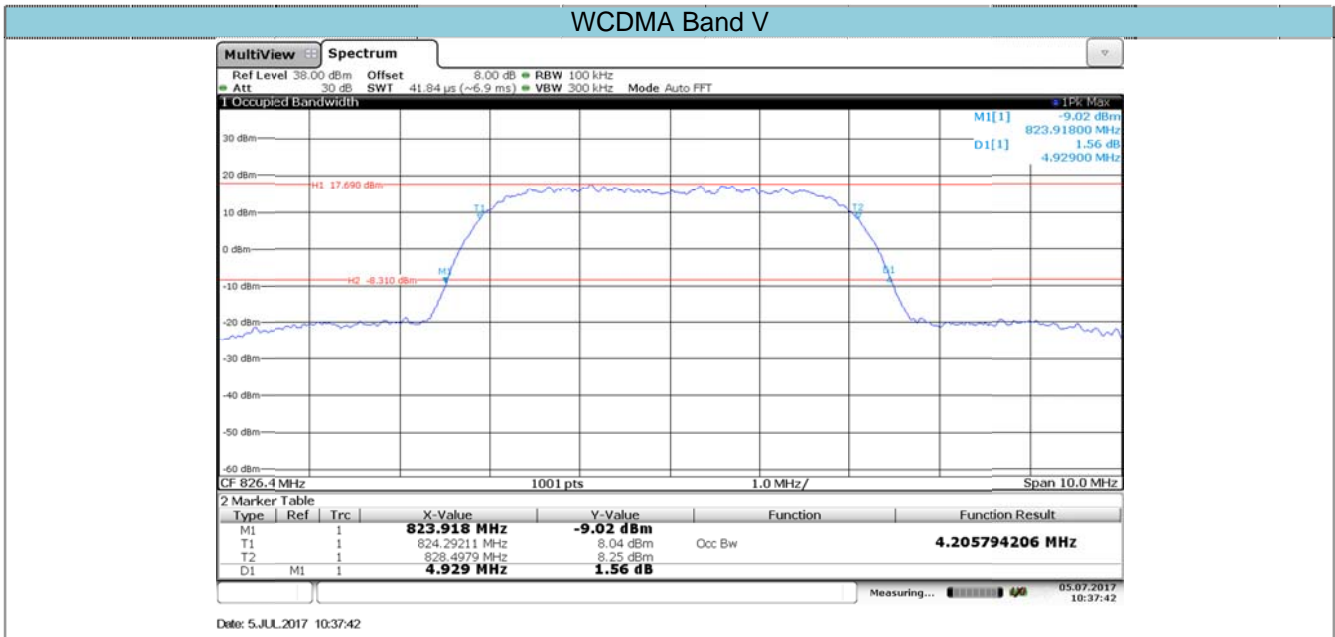

Channel 4132

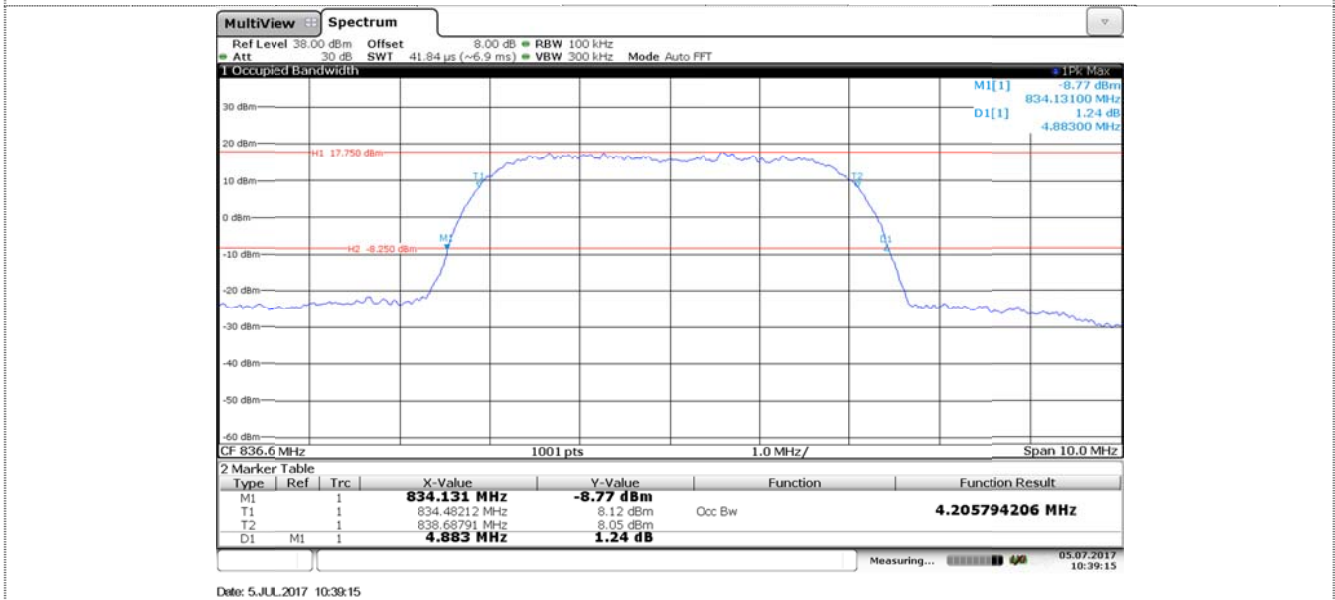

Channel 4183

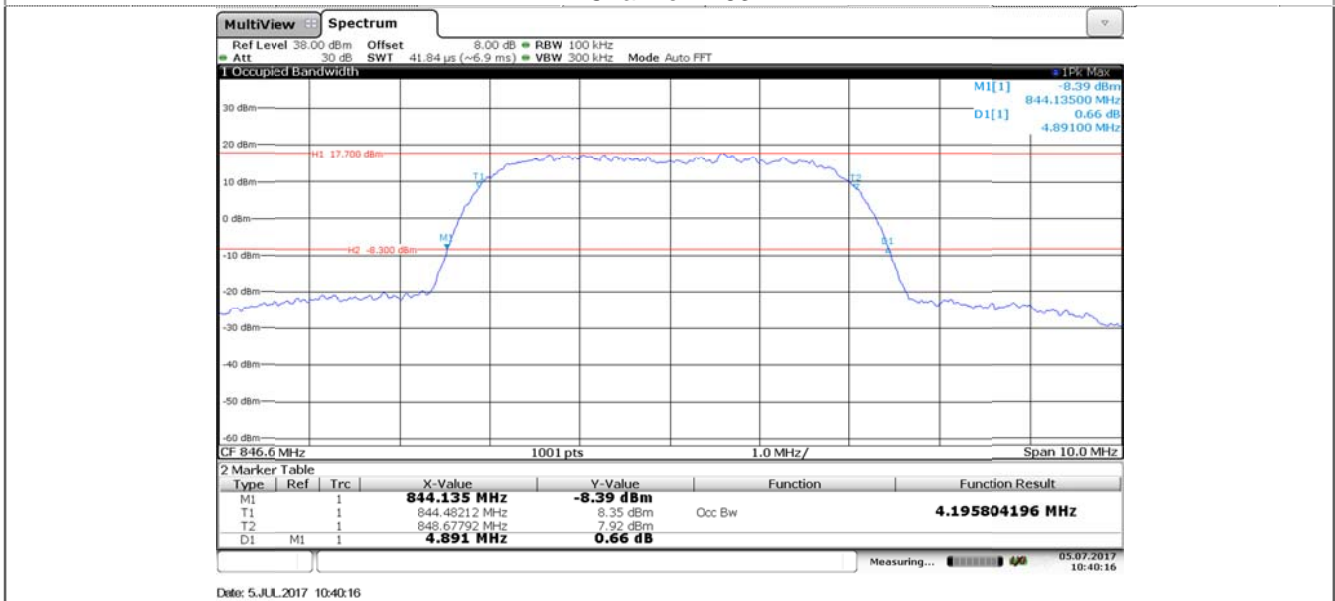

Channel 4233

5.3. Conducted Spurious Emissions

LIMIT

Part 24.238 and Part 22.917 specify that the power of any emission outside of the authorized operating frequency ranges must be attenuated below the transmitting power (P) by a factor of at least $43 + 10 \log(P)$ dB.

The specification that emissions shall be attenuated below the transmitter power (P) by at least $43 + 10 \log(P)$ dB, translates in the relevant power range (1 to 0.001 W) to -13 dBm. At 1 W the specified minimum attenuation becomes 43 dB and relative to a 30 dBm (1 W) carrier becomes a limit of -13 dBm. At 0.001 W (0 dBm) the minimum attenuation is 13 dB, which again yields a limit of -13 dBm. In this way a translation of the specification from relative to absolute terms is carried out.

TEST CONFIGURATION

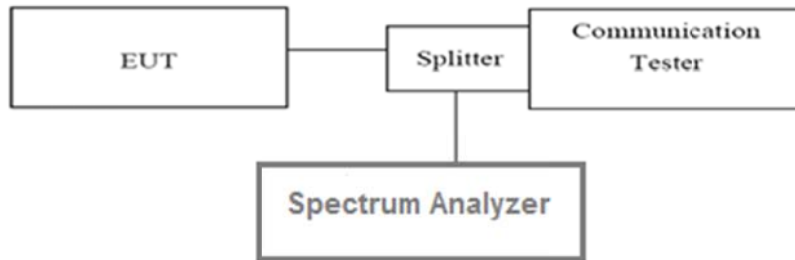

TEST PROCEDURE

1. The RF output of the transceiver was connected to a spectrum analyzer through appropriate attenuation.
2. The resolution bandwidth of the spectrum analyzer was set at 1MHz, sufficient scans were taken to show the out of band Emissions if any up to 10th harmonic.
3. For the out of band: Set the RBW= 1MHz, VBW = 3MHz, Start=30MHz, Stop= 10th harmonic.

TEST MODE:

Please refer to the clause 3.3

TEST RESULTS

Passed **Not Applicable**

Note: Worst case at GSM850/PCS1900

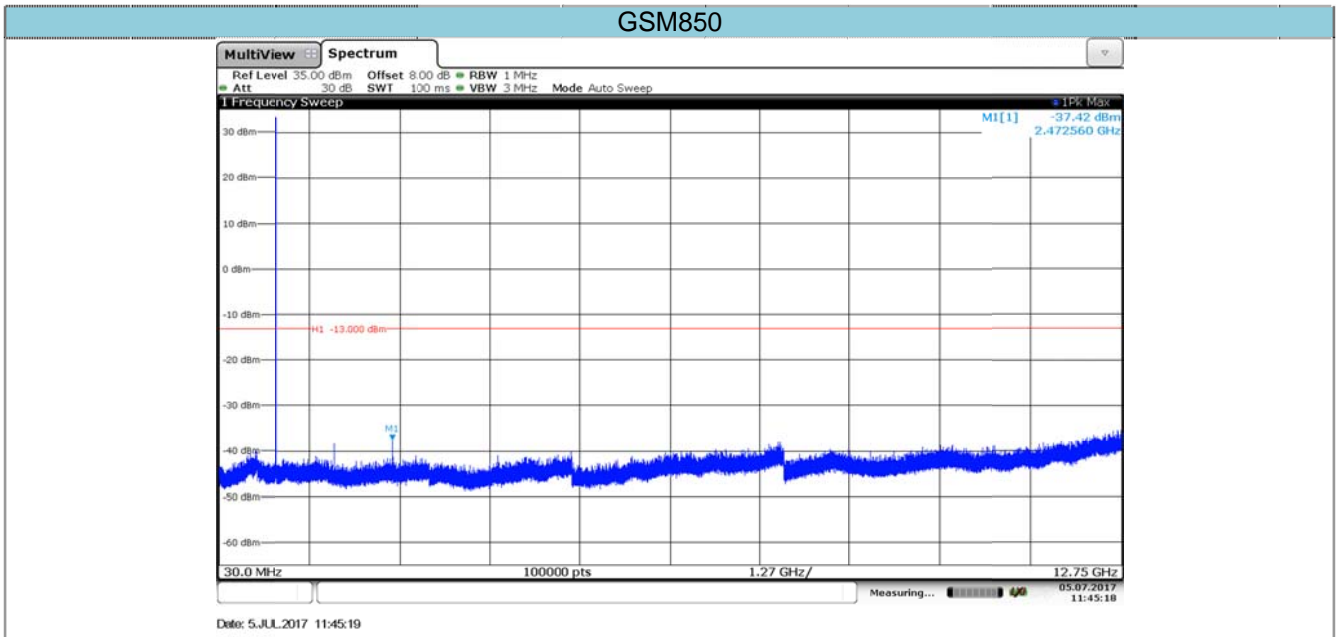

Channel 128

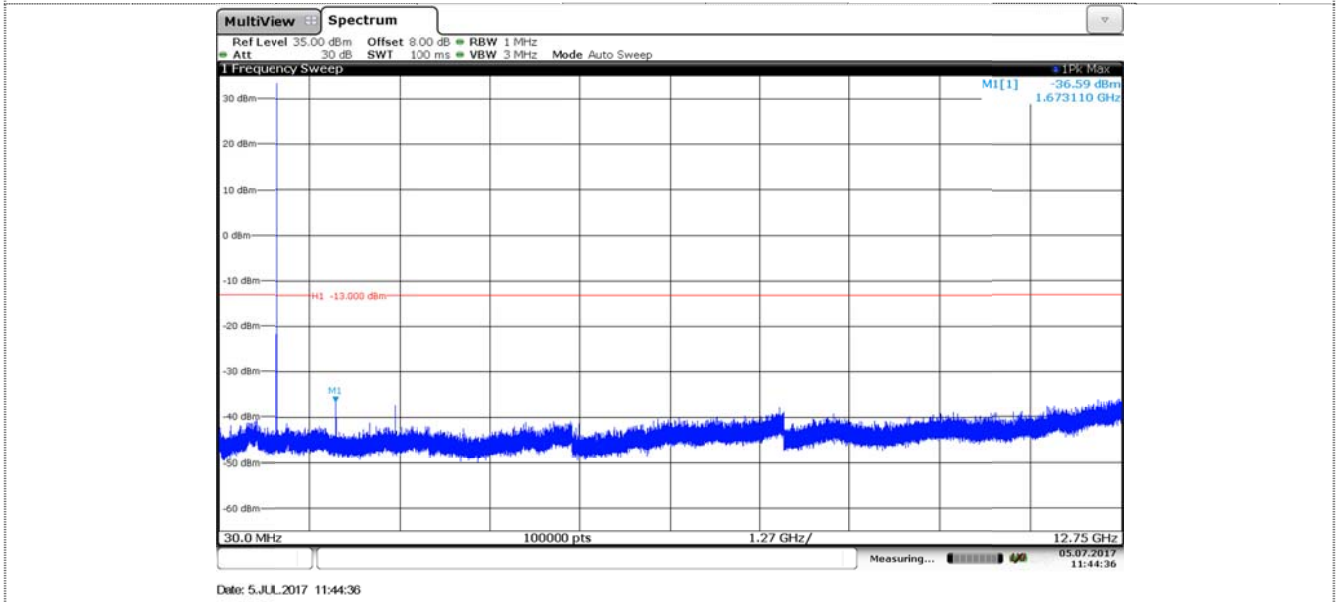

Channel 190

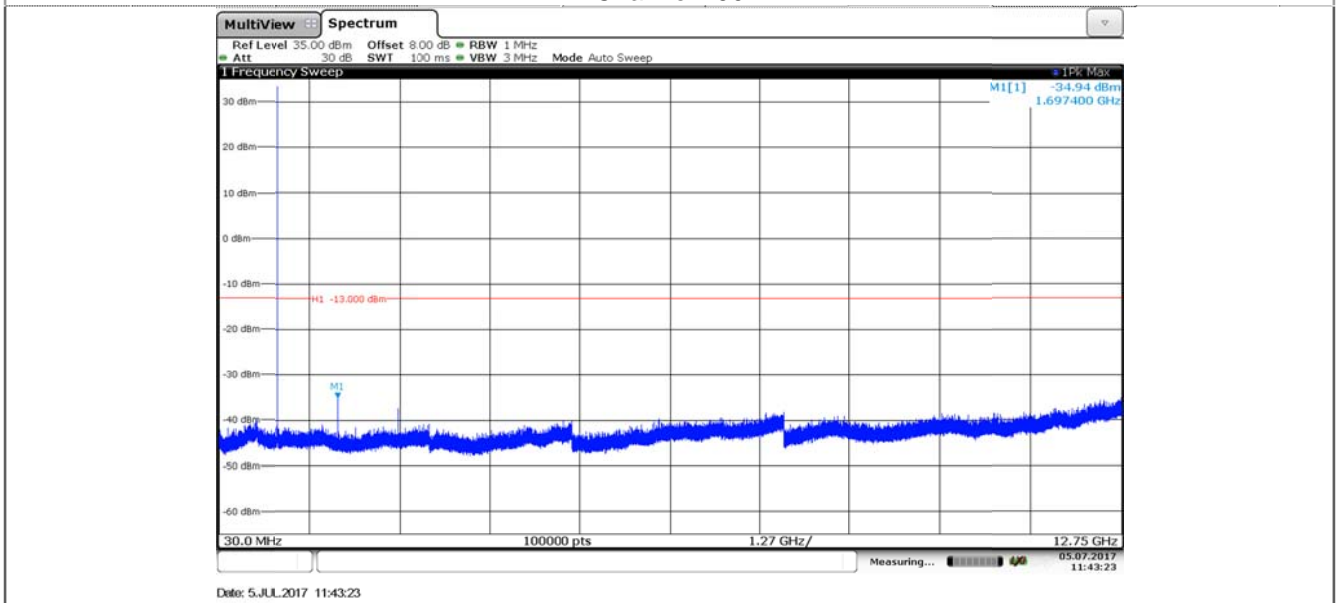

Channel 251

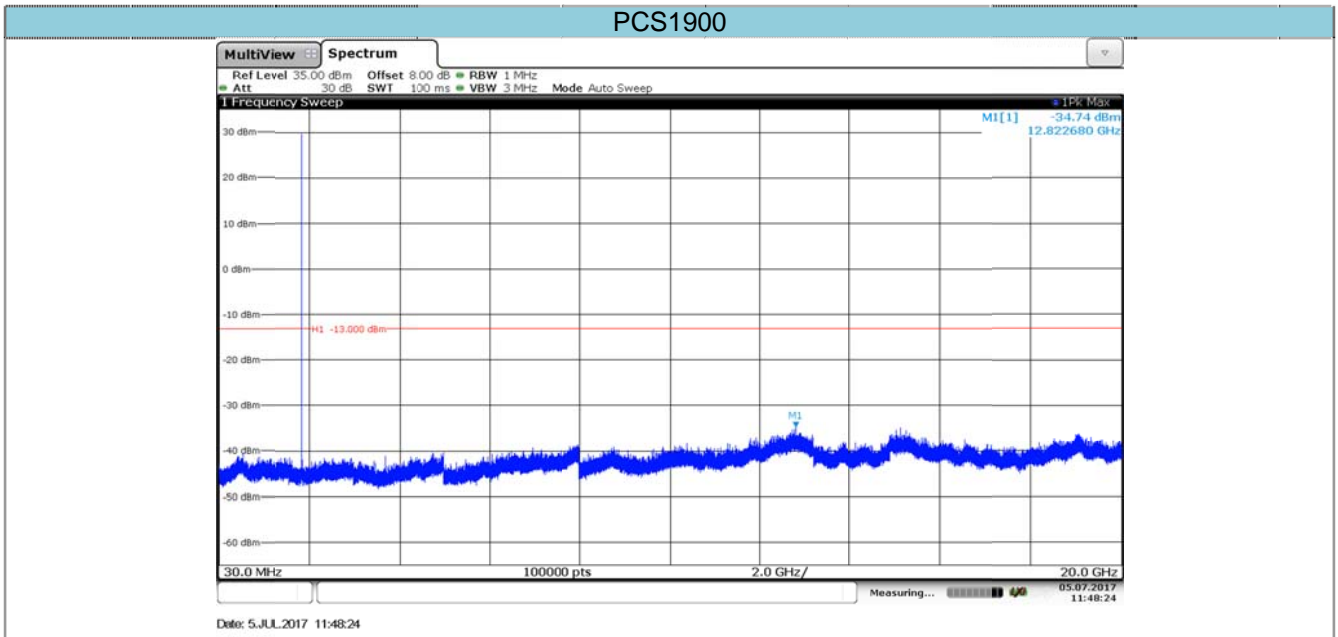

Channel 512

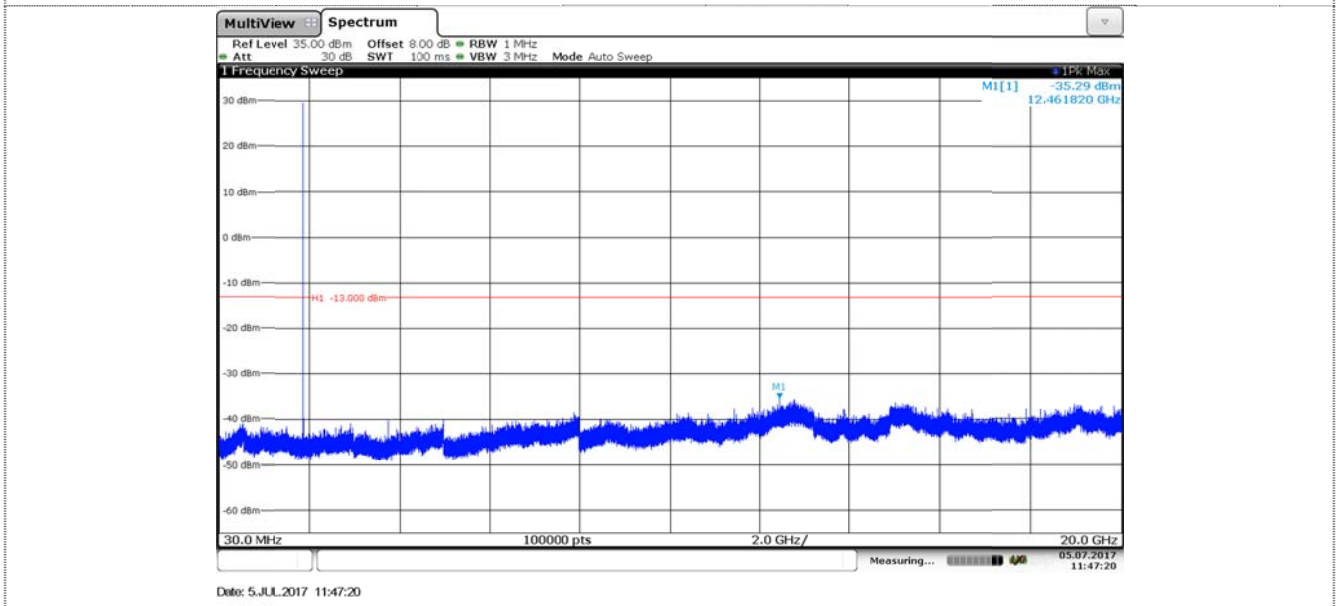

Channel 661

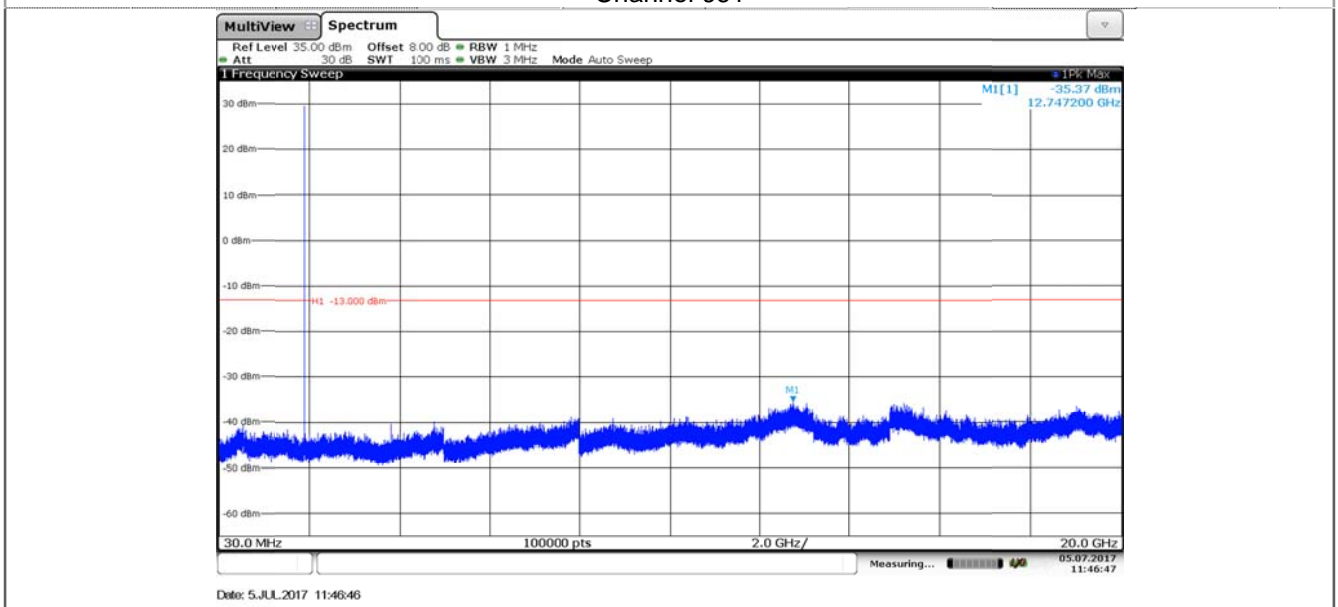

Channel 810

WCDMA Band II

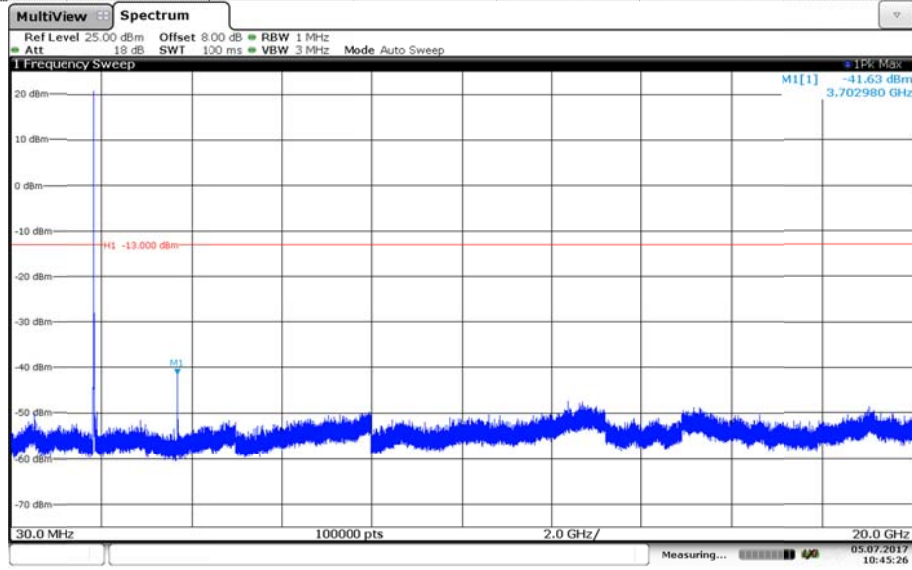

Date: 5.JUL.2017 10:45:26

Channel 9262

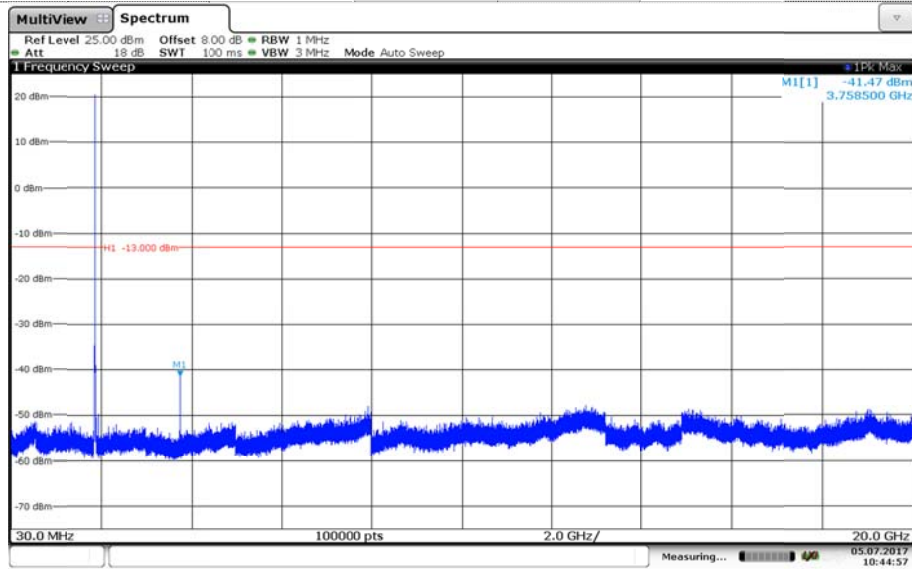

Date: 5.JUL.2017 10:44:58

Channel 9400

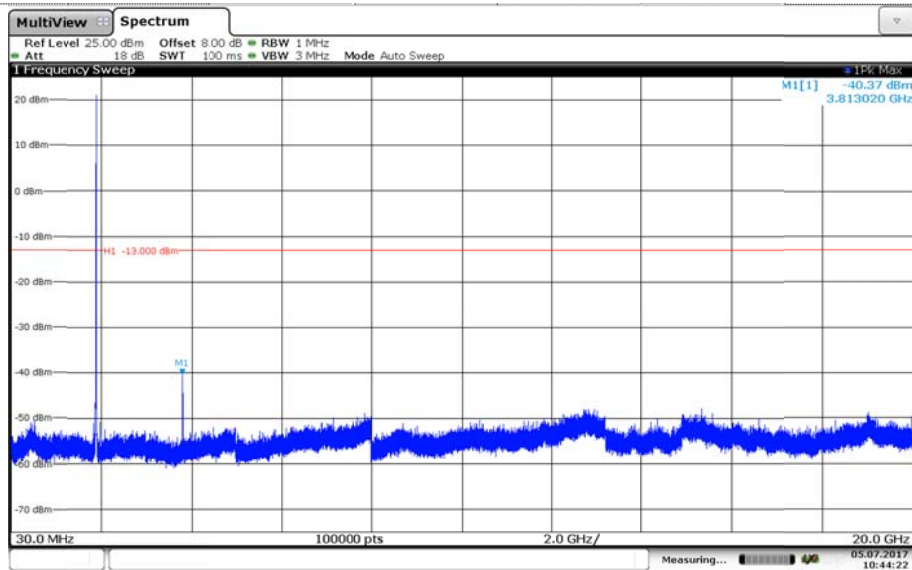

Date: 5.JUL.2017 10:44:22

Channel 9538

WCDMA Band V

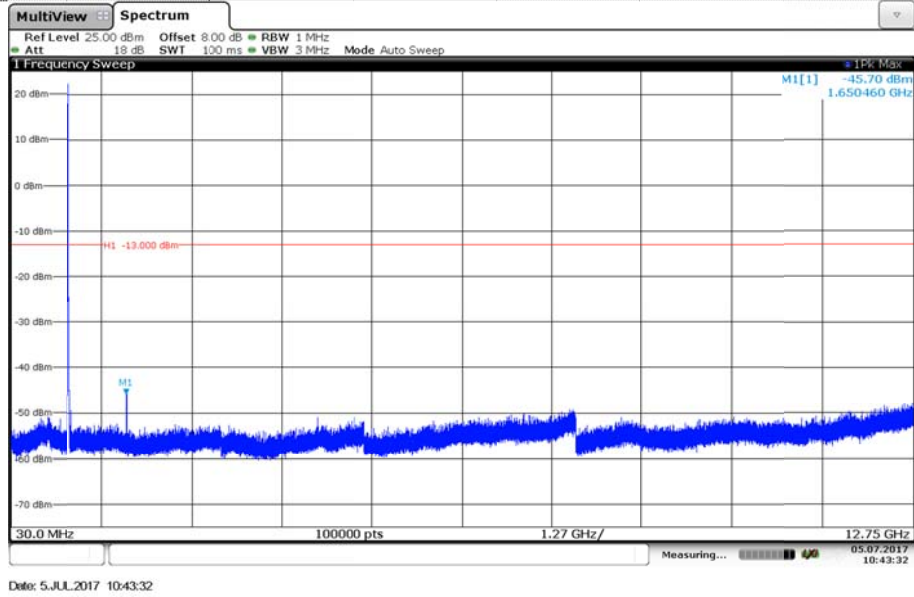

Channel 4132

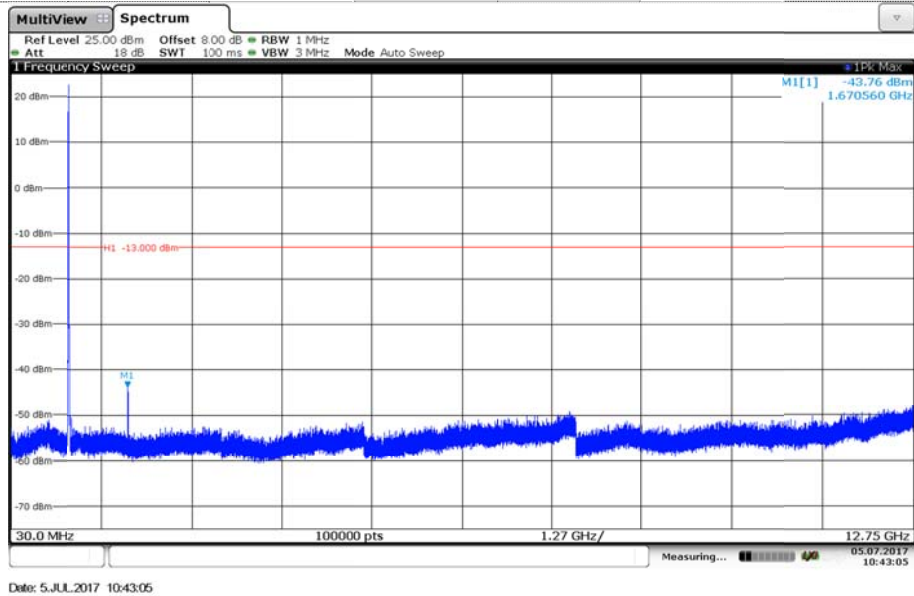

Channel 4183

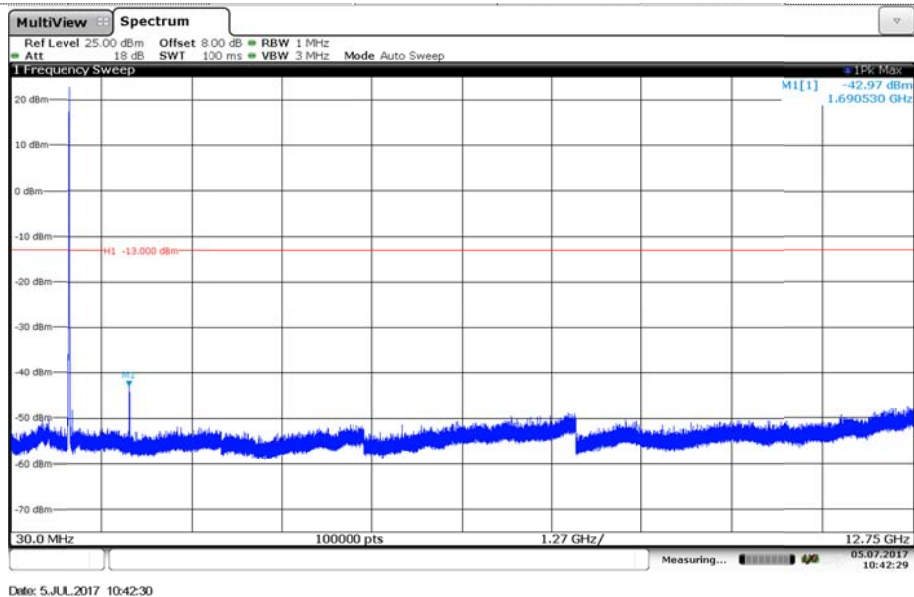

Channel 4233

5.4. Band Edge

LIMIT

Part 24.238 and Part 22.917 specify that the power of any emission outside of the authorized operating frequency ranges must be attenuated below the transmitting power (P) by a factor of at least $43 + 10 \log(P)$ dB.

The specification that emissions shall be attenuated below the transmitter power (P) by at least $43 + 10 \log(P)$ dB, translates in the relevant power range (1 to 0.001 W) to -13 dBm. At 1 W the specified minimum attenuation becomes 43 dB and relative to a 30 dBm (1 W) carrier becomes a limit of -13 dBm. At 0.001 W (0 dBm) the minimum attenuation is 13 dB, which again yields a limit of -13 dBm. In this way a translation of the specification from relative to absolute terms is carried out.

TEST CONFIGURATION

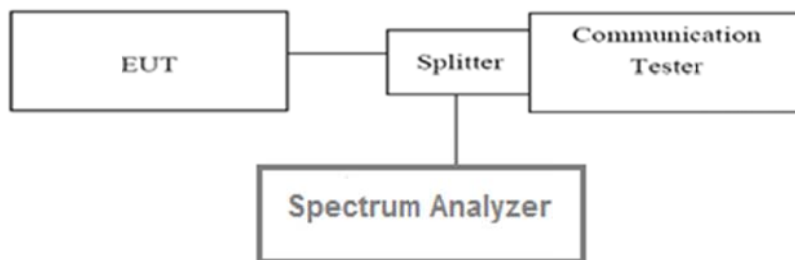

TEST PROCEDURE

1. The RF output of the transceiver was connected to a spectrum analyzer through appropriate attenuation.
2. For the bandedge: 2G: Set the RBW=3KHz, VBW = 10KHz, Sweep time= Auto
3G: Set the RBW=100KHz, VBW = 300KHz, Sweep time= Auto

TEST MODE:

Please refer to the clause 3.3

TEST RESULTS

Passed **Not Applicable**

GSM850					
Channel Number	Frequency (MHz)	Measurement Results		Limit (dBm)	Verdict
		Frequency(MHz)	Values(dBm)		
128	824.2	824	-13.54	-13.00	Pass
251	848.8	849	-14.45	-13.00	Pass

GPRS850					
Channel Number	Frequency (MHz)	Measurement Results		Limit (dBm)	Verdict
		Frequency(MHz)	Values(dBm)		
128	824.2	824	-13.26	-13.00	Pass
251	848.8	849	-13.76	-13.00	Pass

EGPRS850					
Channel Number	Frequency (MHz)	Measurement Results		Limit (dBm)	Verdict
		Frequency(MHz)	Values(dBm)		
128	824.2	824	-18.84	-13.00	Pass
251	848.8	849	-21.52	-13.00	Pass

PCS1900					
Channel Number	Frequency (MHz)	Measurement Results		Limit (dBm)	Verdict
		Frequency(MHz)	Values(dBm)		
512	1850.2	1850	-14.70	-13.00	Pass
810	1909.8	1910	-14.41	-13.00	Pass

GPRS1900					
Channel Number	Frequency (MHz)	Measurement Results		Limit (dBm)	Verdict
		Frequency(MHz)	Values(dBm)		
512	1850.2	1850	-17.63	-13.00	Pass
810	1909.8	1910	-17.81	-13.00	Pass

EGPRS1900					
Channel Number	Frequency (MHz)	Measurement Results		Limit (dBm)	Verdict
		Frequency(MHz)	Values(dBm)		
512	1850.2	1850	-21.05	-13.00	Pass
810	1909.8	1910	-22.47	-13.00	Pass

WCDMA Band II					
Channel Number	Frequency (MHz)	Measurement Results		Limit (dBm)	Verdict
		Frequency(MHz)	Values(dBm)		
9262	1852.4	1850	-15.42	-13.00	Pass
9538	1907.6	1910	-16.16	-13.00	Pass

WCDMA Band V					
Channel Number	Frequency (MHz)	Measurement Results		Limit (dBm)	Verdict
		Frequency(MHz)	Values(dBm)		
4132	826.4	824	-13.35	-13.00	Pass
4233	846.6	849	-14.61	-13.00	Pass

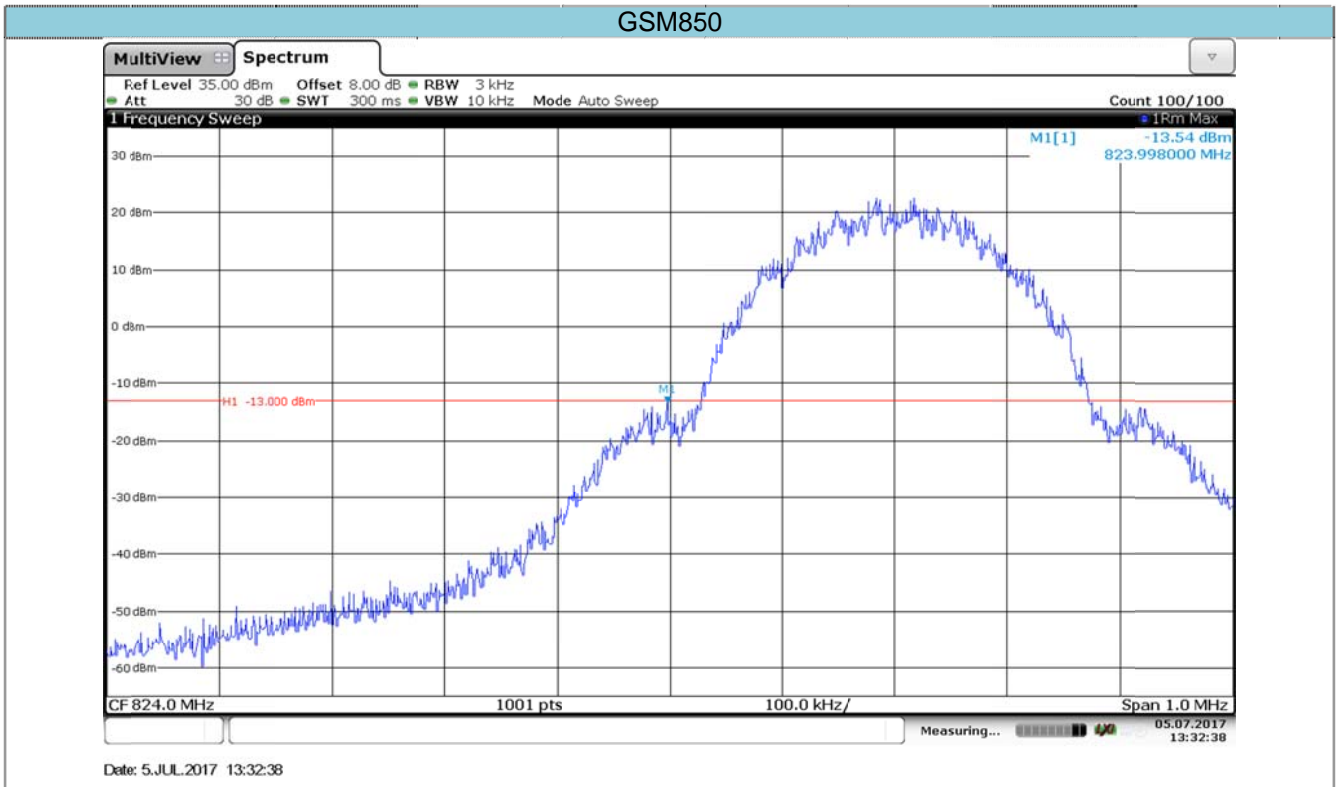

Channel 128

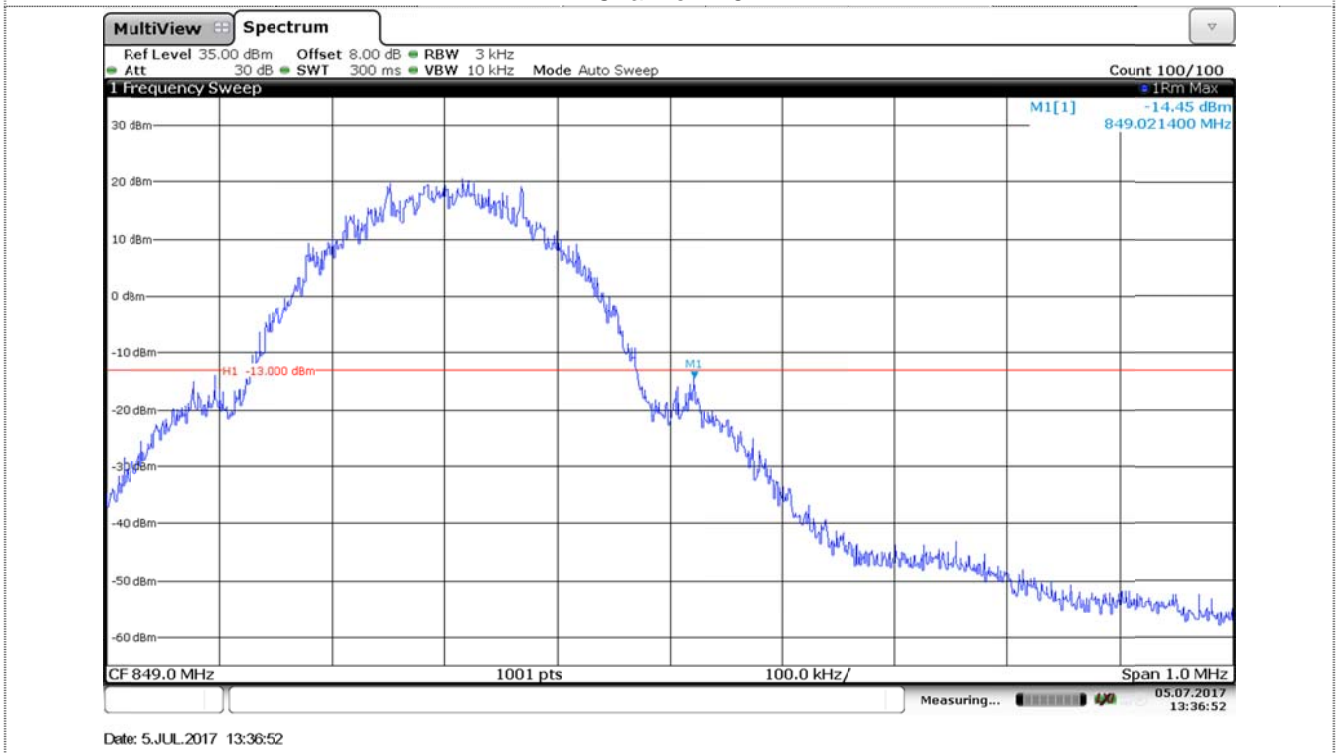

Channel 251

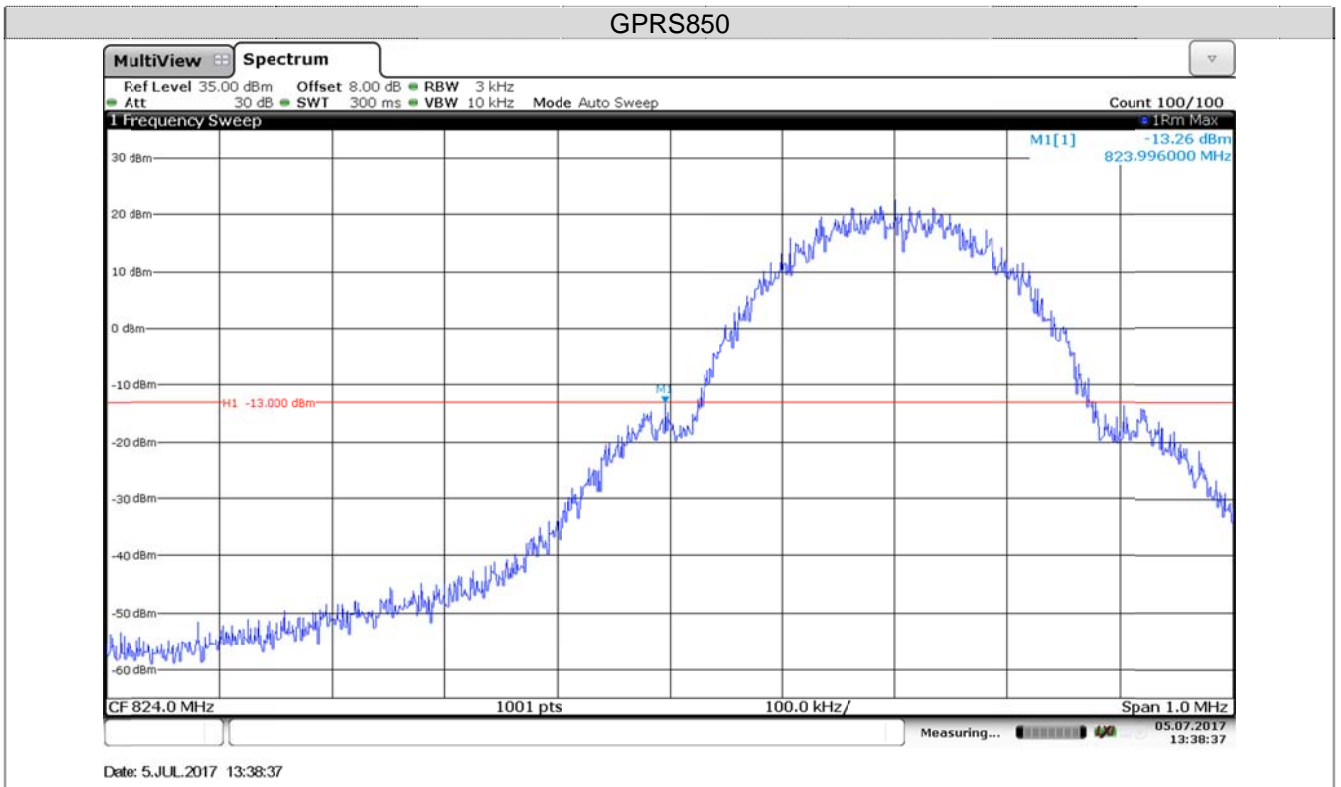

Channel 128

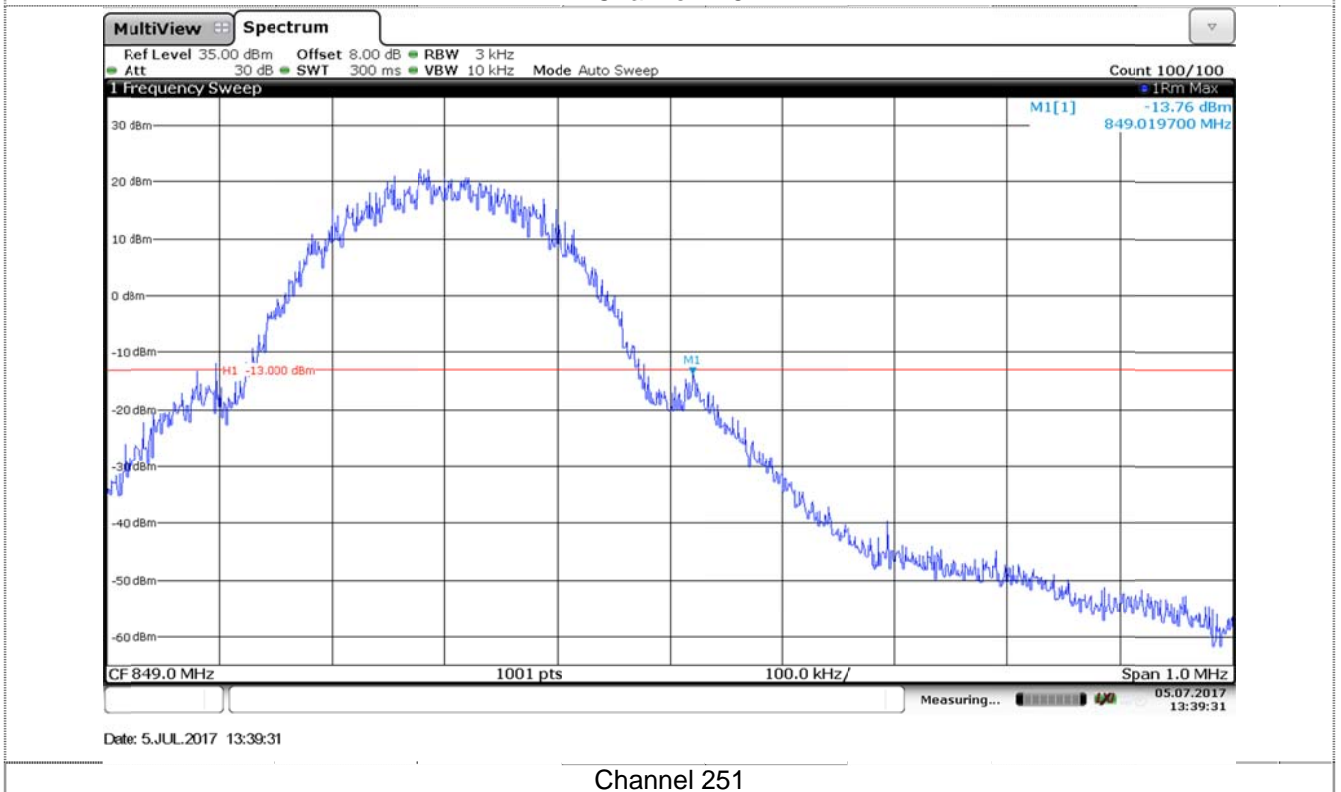

Channel 251

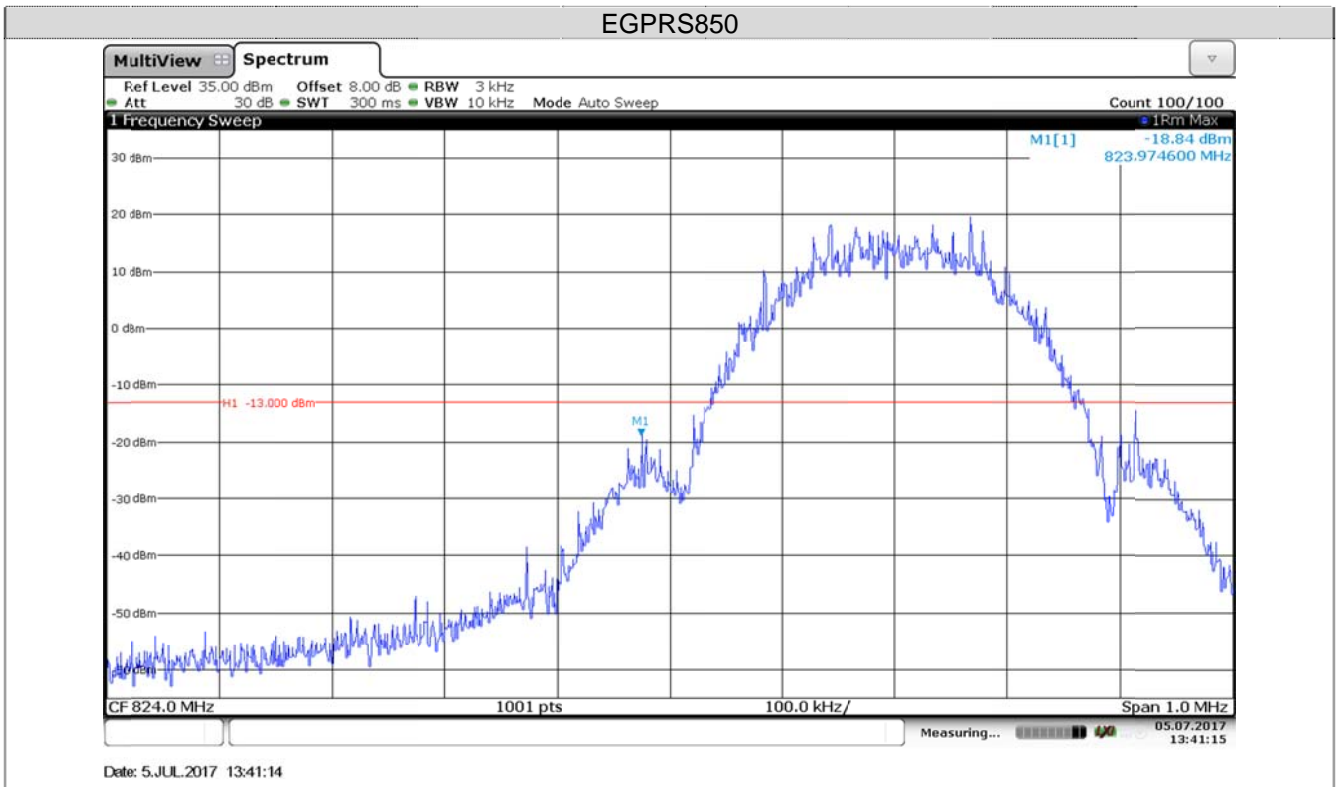

Channel 128

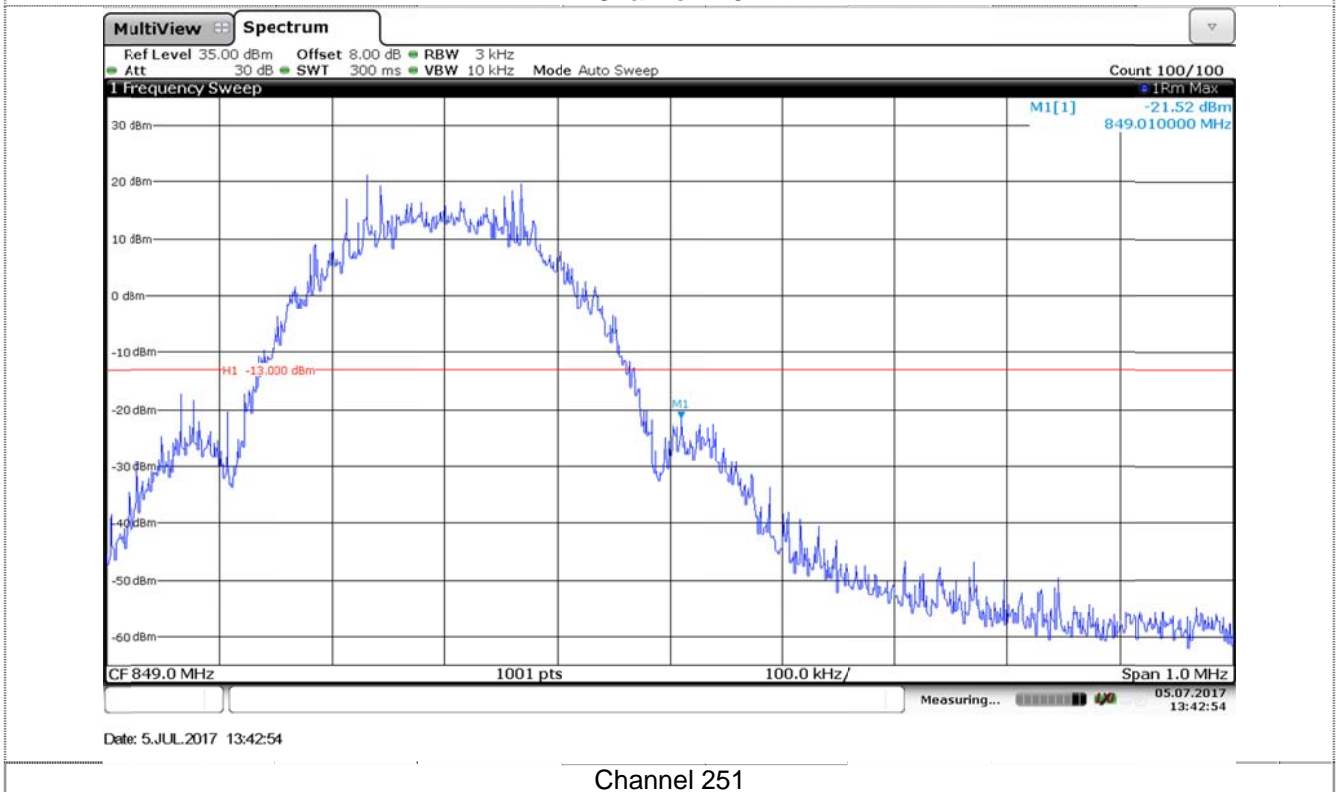

Channel 251

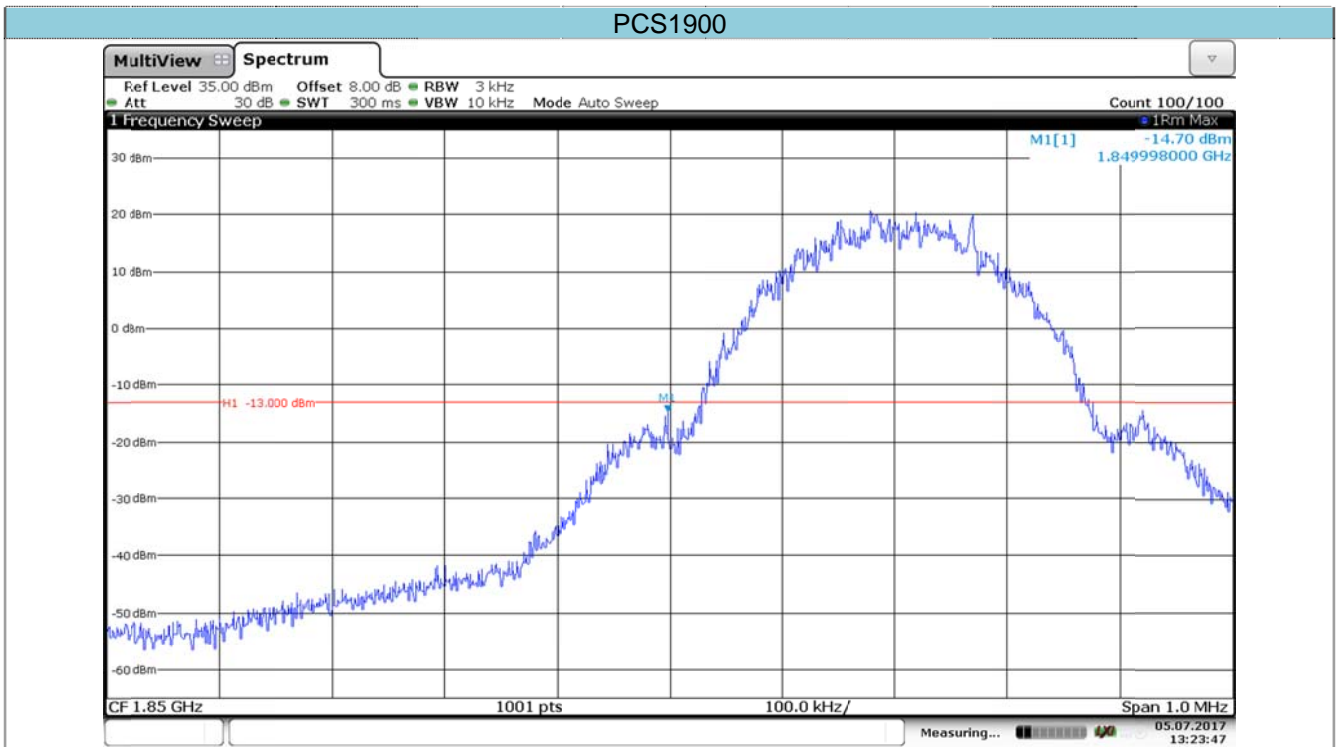

Date: 5.JUL.2017 13:23:47

Channel 512

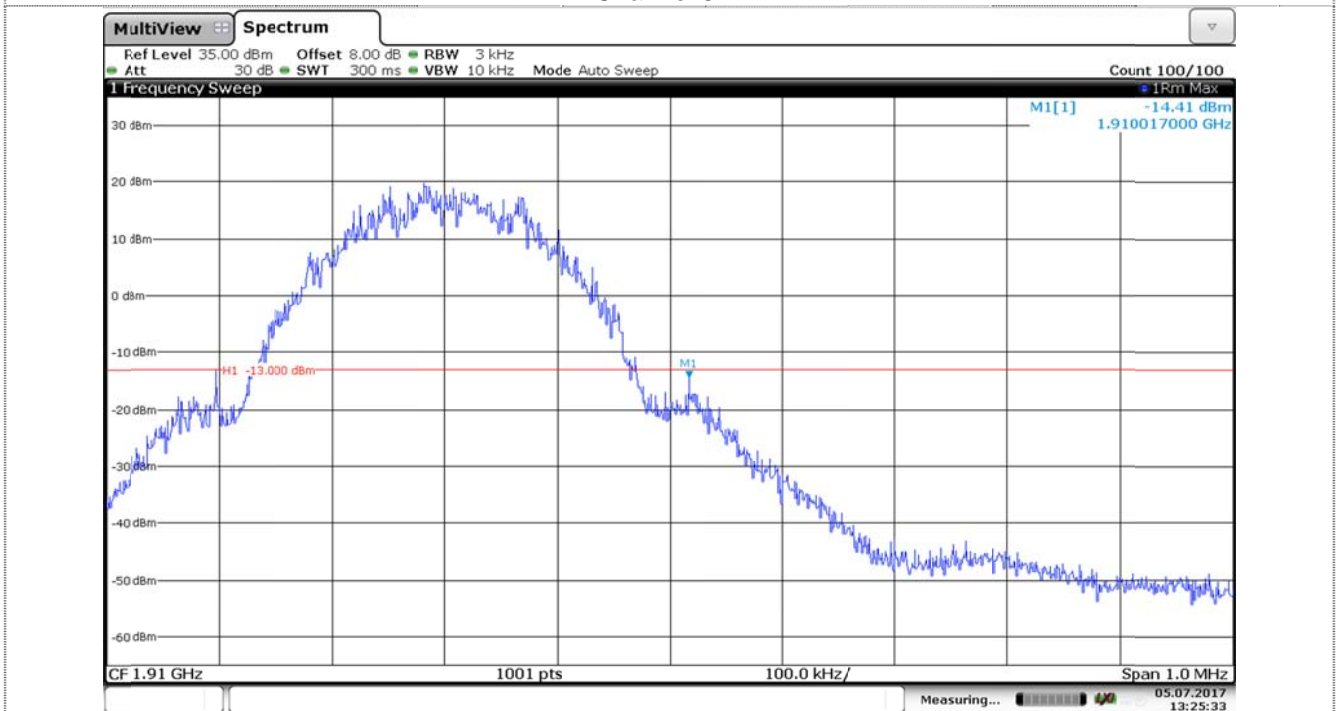

Date: 5.JUL.2017 13:25:33

Channel 810

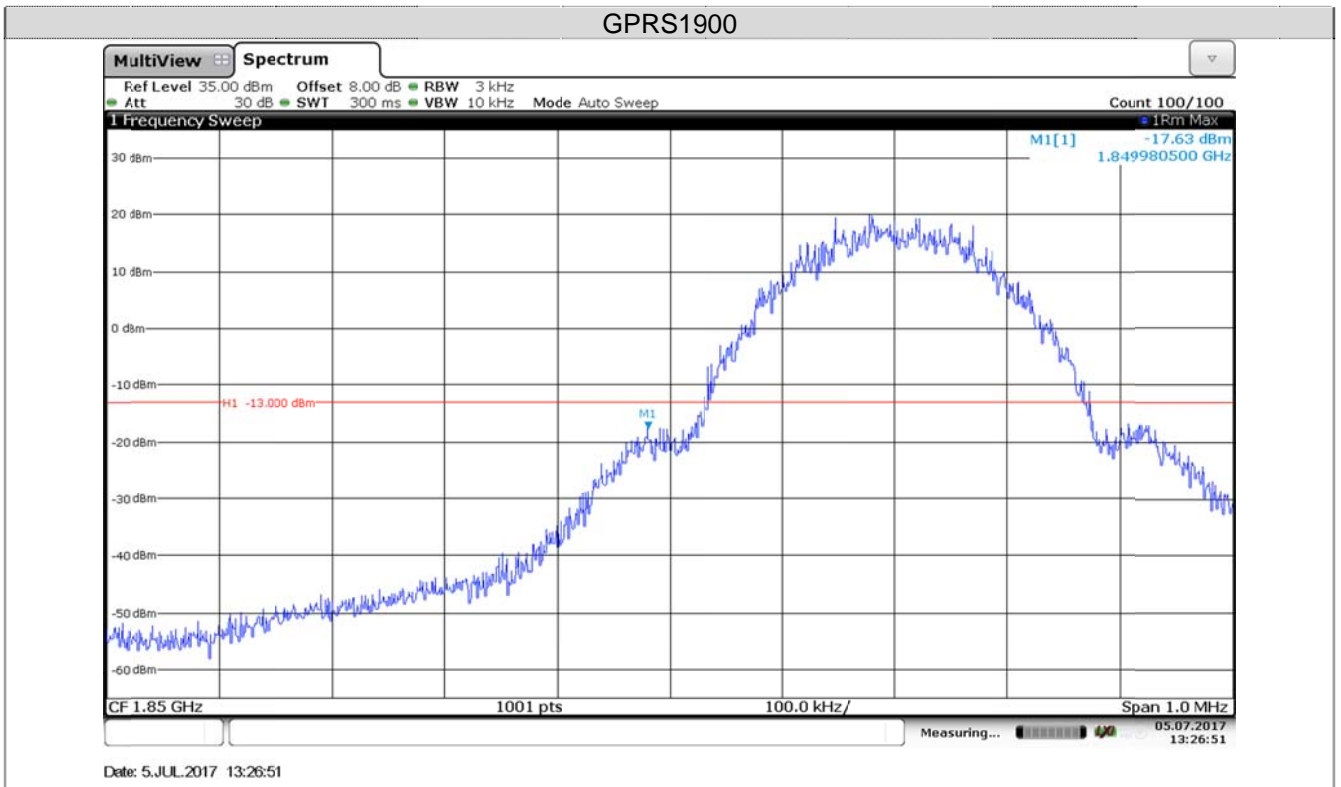

Channel 512

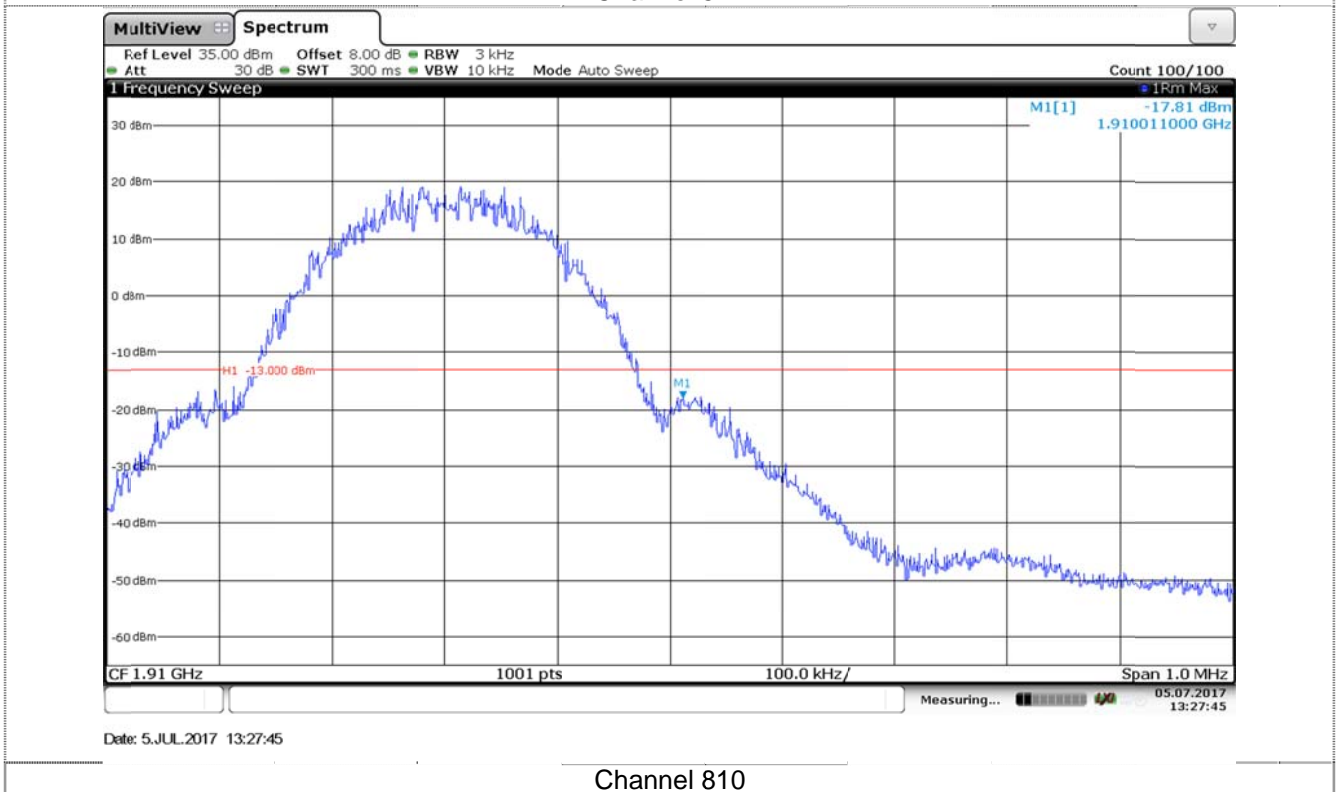

Channel 810

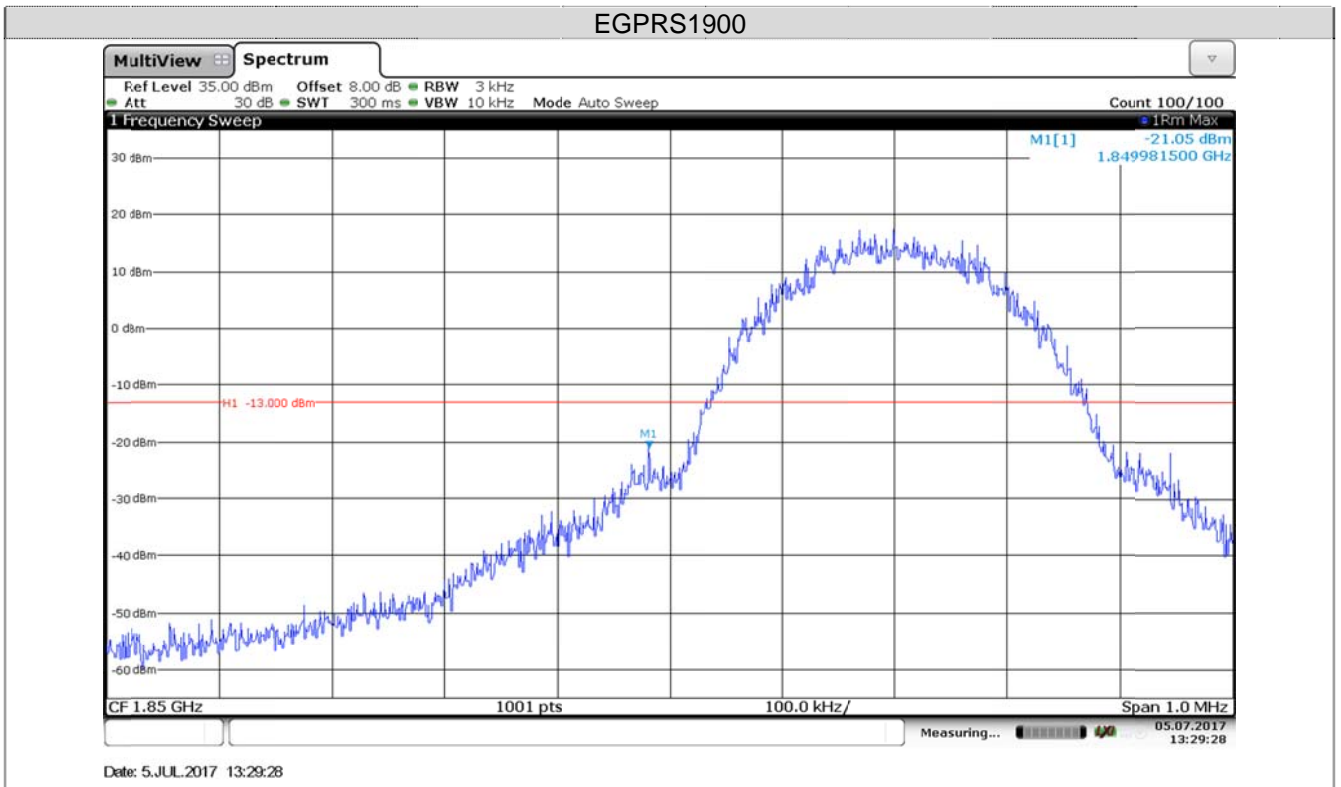

Channel 512

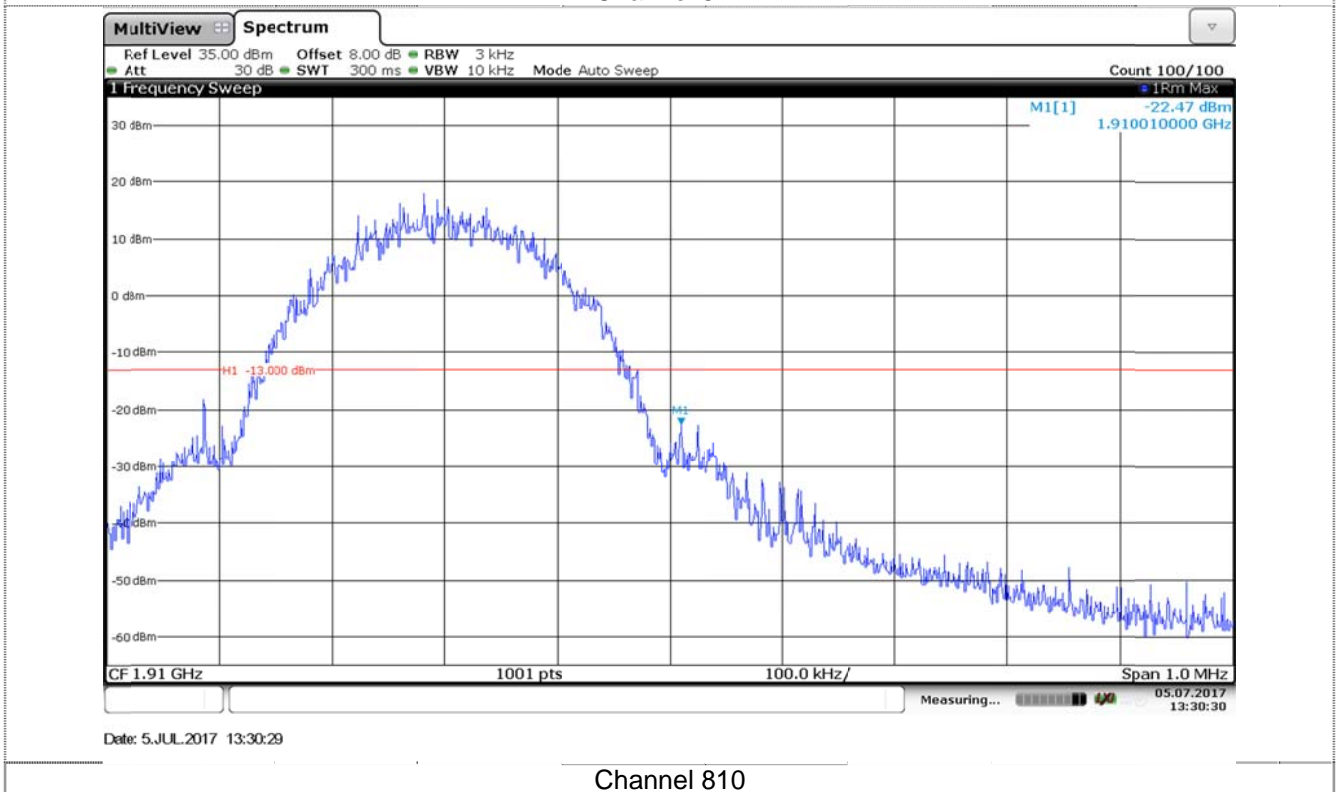

Channel 810

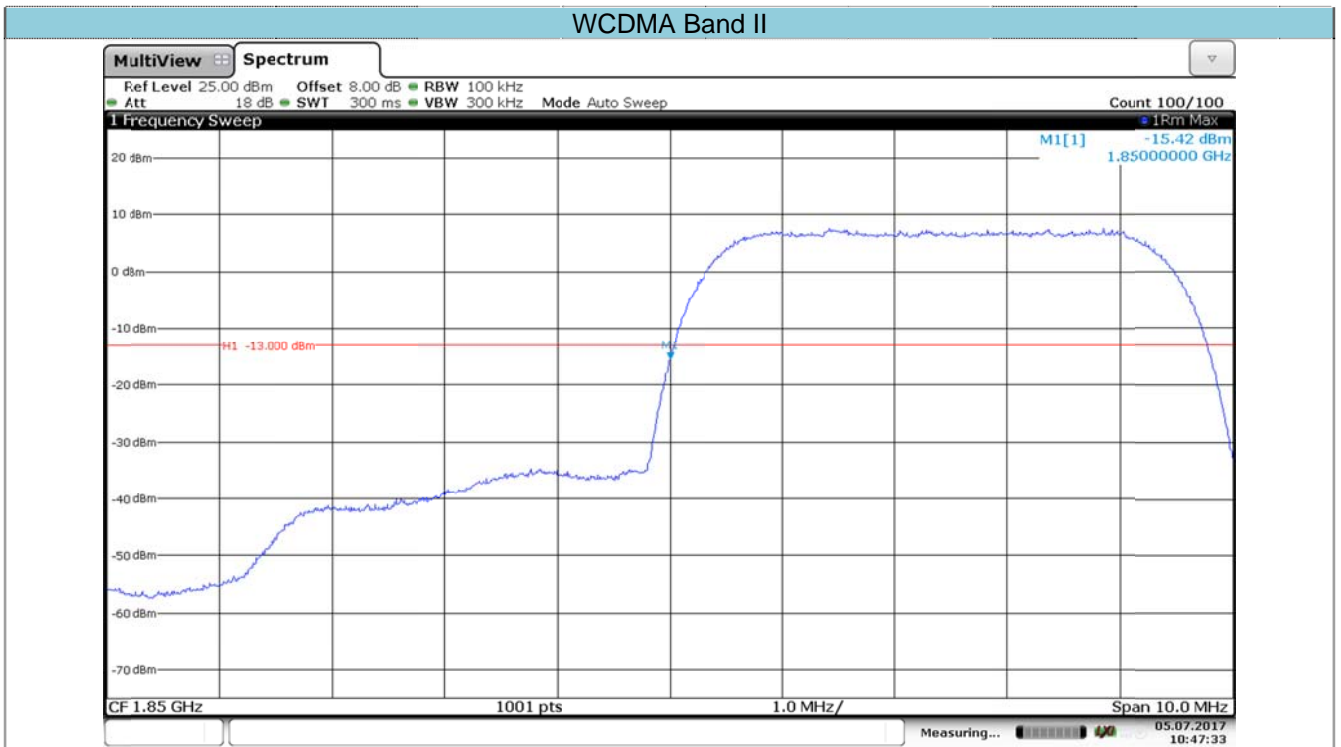

Date: 5.JUL.2017 10:47:33

Channel 9262

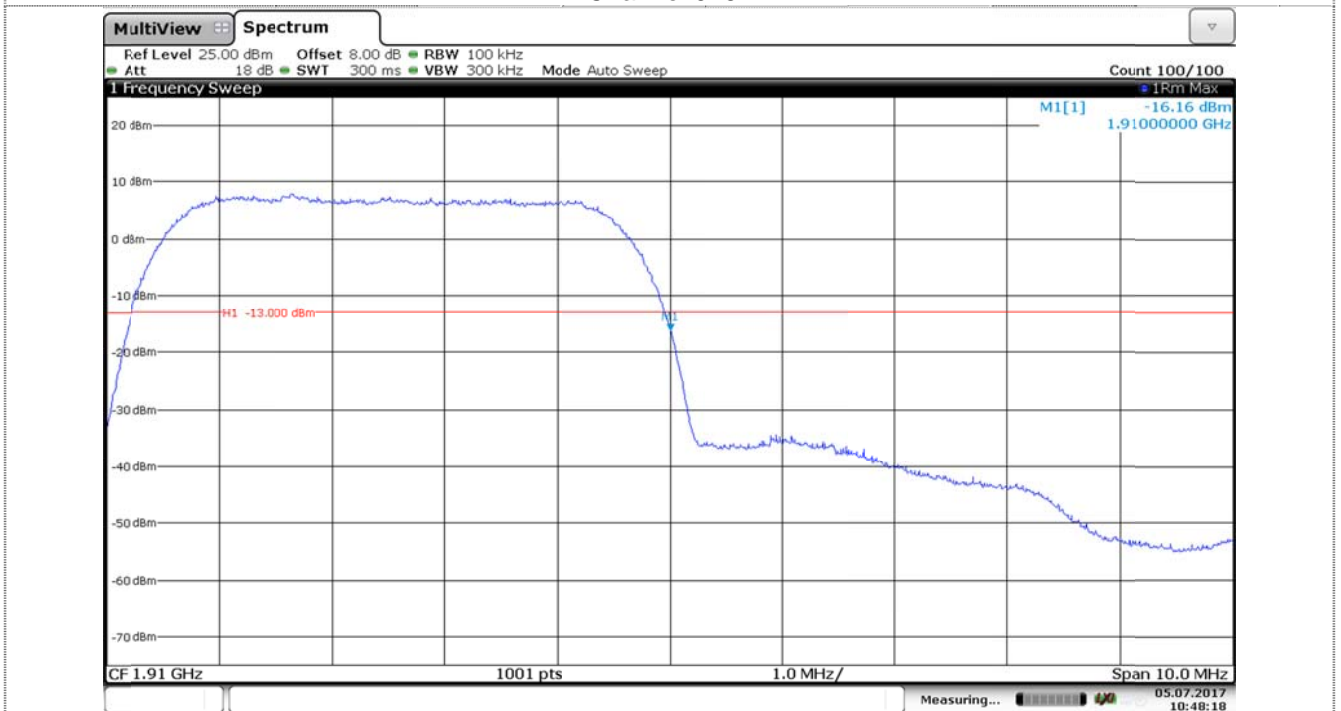

Date: 5.JUL.2017 10:48:18

Channel 9538

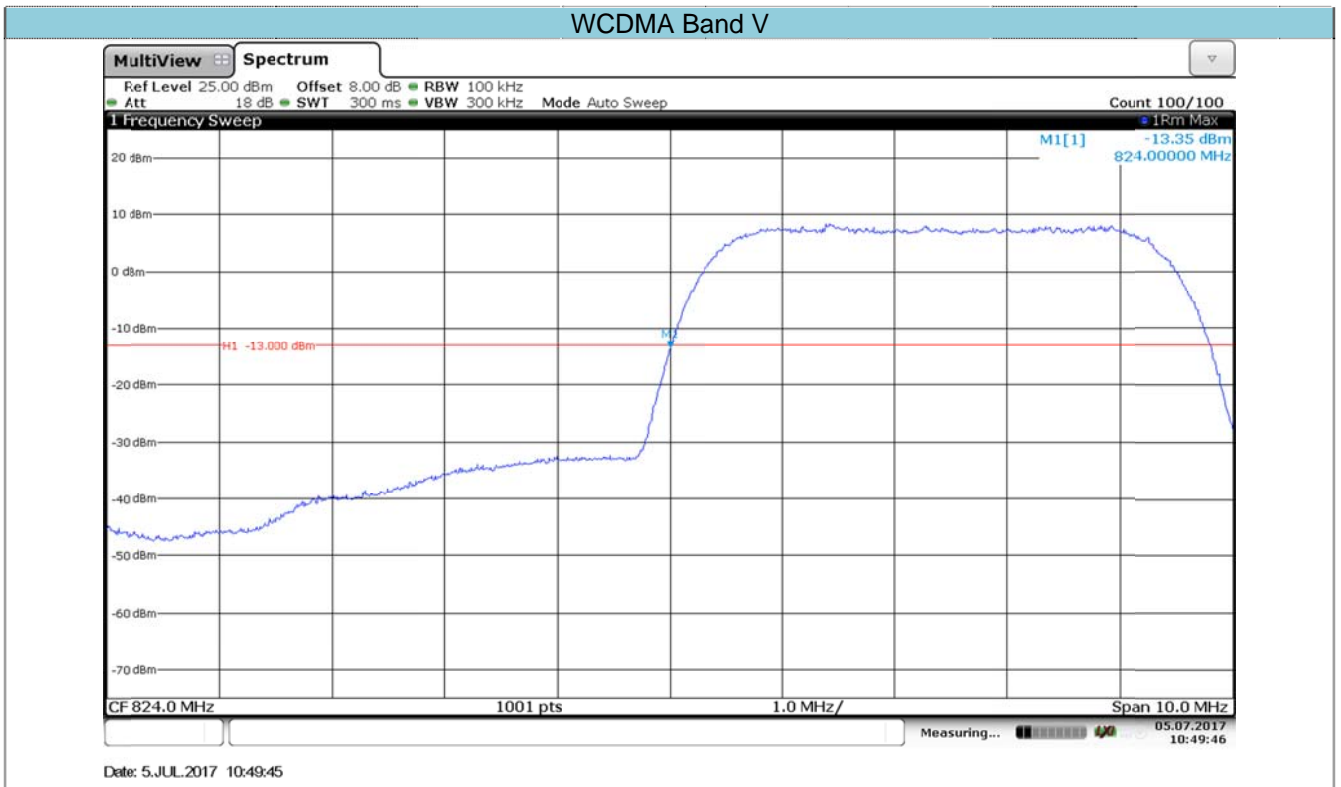

Channel 4132

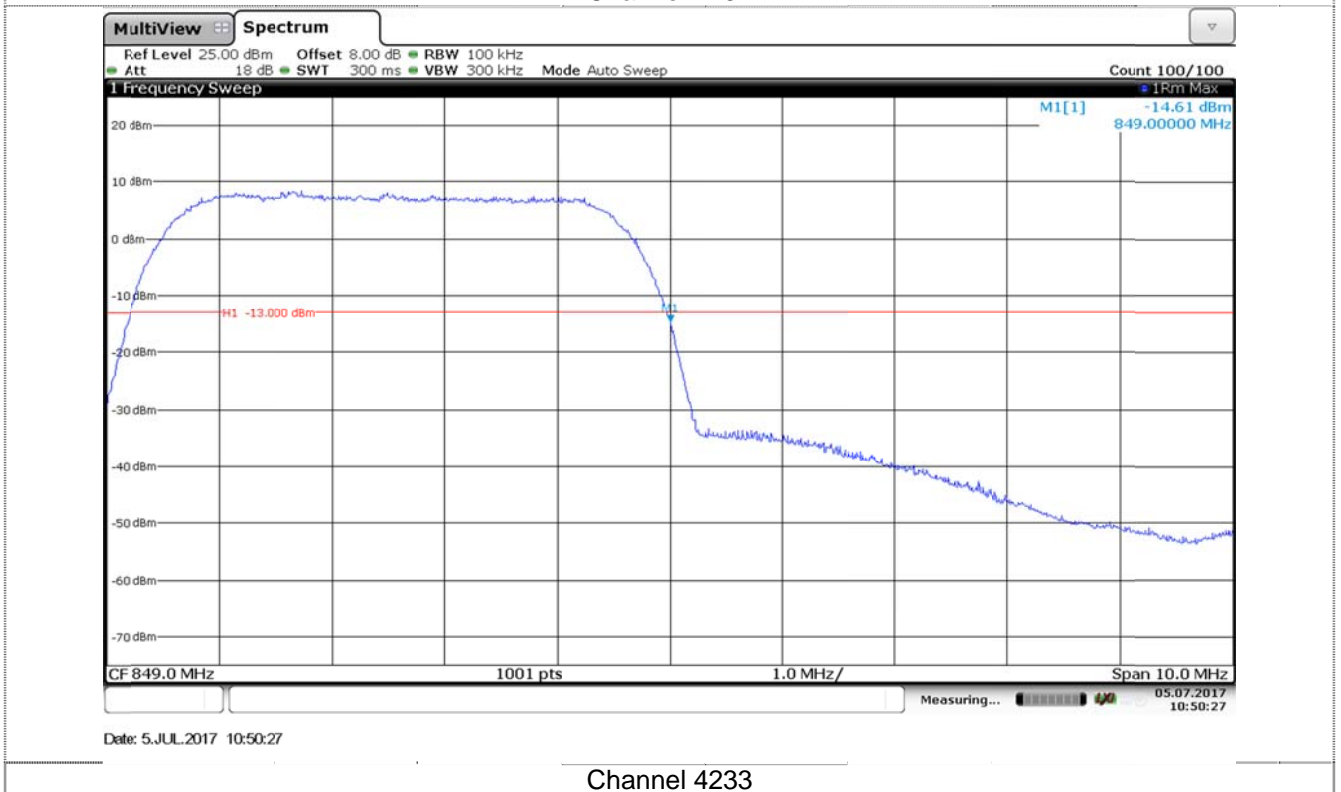

5.5. ERP and EIRP

LIMIT

GSM850/WCDMA Band V: 7W ERP

PCS1900/WCDMA Band II: 2W EIRP

TEST CONFIGURATION

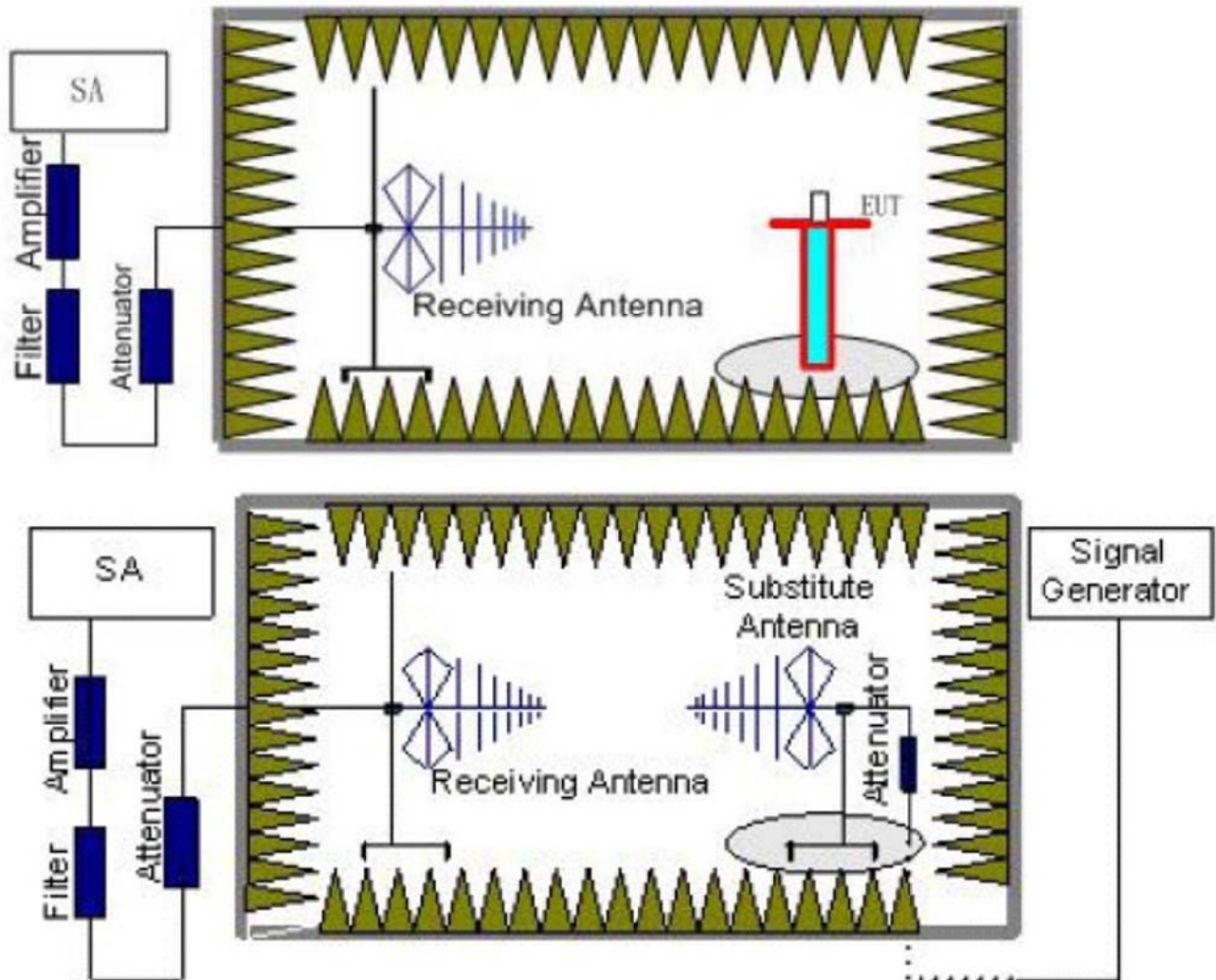

TEST PROCEDURE

1. EUT was placed on a 0.8 meter high non-conductive stand at a 3 meter test distance from the receive antenna. A receiving antenna was placed on the antenna mast 3 meters from the EUT for emission measurements. The height of receiving antenna is 1.0m. Detected emissions were maximized at each frequency by rotating the EUT through 360° and adjusting the receiving antenna polarization. The radiated emission measurements of all transmit frequencies in three channels (High, Middle, Low) were measured with peak detector.
2. A log-periodic antenna or double-ridged waveguide horn antenna shall be substituted in place of the EUT. The log-periodic antenna will be driven by a signal generator and the level will be adjusted till the same power value on the spectrum analyzer or receiver. The level of the spurious emissions can be calculated through the level of the signal generator, cable loss, the gain of the substitution antenna and the reading of the spectrum analyzer or receiver.
3. The EUT is then put into continuously transmitting mode at its maximum power level during the test. Set Test Receiver or Spectrum RBW=1MHz, VBW=3MHz for above 1GHz and RBW=100kHz, VBW=300kHz for 30MHz to 1GHz,, And the maximum value of the receiver should be recorded as (Pr).
4. The EUT shall be replaced by a substitution antenna. In the chamber, an substitution antenna for the frequency band of interest is placed at the reference point of the chamber. An RF Signal source for the

frequency band of interest is connected to the substitution antenna with a cable that has been constructed to not interfere with the radiation pattern of the antenna. A power (P_{Mea}) is applied to the input of the substitution antenna, and adjust the level of the signal generator output until the value of the receiver reach the previously recorded (P_r). The power of signal source (P_{Mea}) is recorded. The test should be performed by rotating the test item and adjusting the receiving antenna polarization.

5. A amplifier should be connected to the Signal Source output port. And the cable should be connect between the Amplifier and the Substitution Antenna. The cable loss (P_{cl}), the Substitution Antenna Gain (G_a) and the Amplifier Gain (P_{Ag}) should be recorded after test.
6. The measurement results are obtained as described below:
 $Power(EIRP) = P_{Mea} - P_{Ag} - P_{cl} + G_a$
 We used SMF100A microwave signal generator which signal level can up to 33dBm, so we not used power Amplifier for substitution test; The measurement results are amend as described below:
 $Power(EIRP) = P_{Mea} - P_{cl} + G_a$
7. This value is EIRP since the measurement is calibrated using an antenna of known gain (2.15 dBi) and known input power.
 ERP can be calculated from EIRP by subtracting the gain of the dipole, $ERP = EIRP - 2.15dBi$.

TEST MODE:

Please refer to the clause 3.3

TEST RESULTS

Passed **Not Applicable**

Mode	Channel	Antenna Pol.	ERP	Limit (dBm)	Result
GSM850	128	V	27.52	38.45	Pass
		H	25.43		
	190	V	27.66		
		H	25.85		
	251	V	27.46		
		H	25.84		
GPRS850	128	V	27.52	38.45	Pass
		H	25.66		
	190	V	27.46		
		H	25.25		
	251	V	27.36		
		H	25.66		
EGPRS850	128	V	24.38	38.45	Pass
		H	22.52		
	190	V	24.66		
		H	22.18		
	251	V	24.55		
		H	22.37		

Mode	Channel	Antenna Pol.	EIRP	Limit (dBm)	Result
PCS1900	512	V	25.65	33.00	Pass
		H	23.66		
	661	V	25.34		
		H	23.38		
	810	V	25.88		
		H	23.66		
GPRS1900	512	V	25.25	33.00	Pass
		H	23.74		
	661	V	25.88		
		H	23.26		
	810	V	25.66		
		H	22.16		
EGPRS1900	512	V	23.85	33.00	Pass
		H	20.14		
	661	V	23.36		
		H	20.66		
	810	V	23.25		
		H	20.52		

Mode	Channel	Antenna Pol.	EIRP	Limit (dBm)	Result
WCDMA Band II	9262	V	18.45	33.00	Pass
		H	15.36		
	9400	V	18.36		
		H	15.43		
	9538	V	18.22		
		H	15.36		

Mode	Channel	Antenna Pol.	ERP	Limit (dBm)	Result
WCDMA Band V	4132	V	17.88	38.45	Pass
		H	15.25		
	4183	V	18.14		
		H	15.36		
	4233	V	18.33		
		H	15.24		

5.6. Radiated Spurious Emission

LIMIT

-13dBm

TEST CONFIGURATION

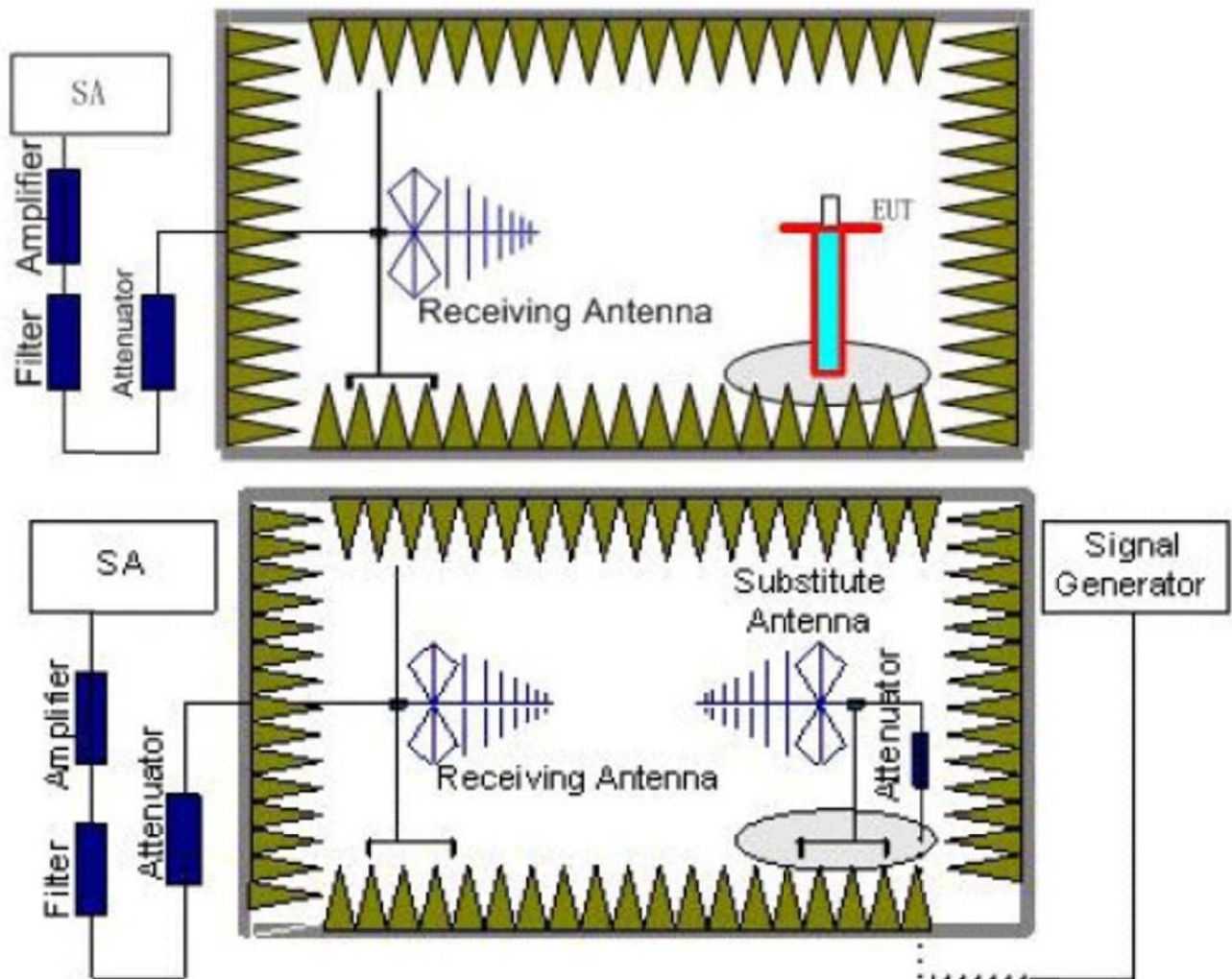

TEST RESULTS

1. EUT was placed on a 0.8 meter high non-conductive stand at a 3 meter test distance from the receive antenna. A receiving antenna was placed on the antenna mast 3 meters from the EUT for emission measurements. The height of receiving antenna is 1.0m. Detected emissions were maximized at each frequency by rotating the EUT through 360° and adjusting the receiving antenna polarization. The radiated emission measurements of all transmit frequencies in three channels (High, Middle, Low) were measured with peak detector.
2. A log-periodic antenna or double-ridged waveguide horn antenna shall be substituted in place of the EUT. The log-periodic antenna will be driven by a signal generator and the level will be adjusted till the same power value on the spectrum analyzer or receiver. The level of the spurious emissions can be calculated through the level of the signal generator, cable loss, the gain of the substitution antenna and the reading of the spectrum analyzer or receiver.
3. The EUT is then put into continuously transmitting mode at its maximum power level during the test. Set Test Receiver or Spectrum RBW=1MHz, VBW=3MHz for above 1GHz and RBW=100kHz, VBW=300kHz for 30MHz to 1GHz, And the maximum value of the receiver should be recorded as (Pr).
4. The EUT shall be replaced by a substitution antenna. In the chamber, an substitution antenna for the frequency band of interest is placed at the reference point of the chamber. An RF Signal source for the frequency band of interest is connected to the substitution antenna with a cable that has been constructed to not interfere with the radiation pattern of the antenna. A power (PMea) is applied to the input of the

substitution antenna, and adjust the level of the signal generator output until the value of the receiver reach the previously recorded (Pr). The power of signal source (PMea) is recorded. The test should be performed by rotating the test item and adjusting the receiving antenna polarization.

5. A amplifier should be connected to the Signal Source output port. And the cable should be connect between the Amplifier and the Substitution Antenna. The cable loss (Pcl) ,the Substitution Antenna Gain (Ga) and the Amplifier Gain (PAg) should be recorded after test.
6. The measurement results are obtained as described below:
Power(EIRP)=PMea- PAg - Pcl + Ga
We used SMF100A micowave signal generator which signal level can up to 33dBm,so we not used power Amplifier for substitution test; The measurement results are amend as described below:
Power(EIRP)=PMea- Pcl + Ga
7. This value is EIRP since the measurement is calibrated using an antenna of known gain (2.15 dBi) and known input power.
ERP can be calculated from EIRP by subtracting the gain of the dipole, ERP = EIRP-2.15dBi.

TEST MODE:

Please refer to the clause 3.3

TEST RESULTS

Passed **Not Applicable**

Note: Worst case at GSM850/PCS1900/WCDMA B2/B5

GSM850					
Channel	Frequency (MHz)	Spurious Emission		Limit (dBm)	Result
		Polarization	Level (dBm)		
128	156.09	Vertical	-73.49	-13.00	Pass
	259.91	V	-70.21		
	1648.51	V	-48.99		
	1887.02	V	-50.01		
	3295.11	V	-52.08		
	8156.80	V	-48.24		
	182.21	Horizontal	-68.40	-13.00	Pass
	312.06	H	-67.47		
	1648.51	H	-45.29		
	1895.33	H	-44.36		
	3104.90	H	-59.46		
	7730.65	H	-49.21		
190	89.87	Vertical	-77.60	-13.00	Pass
	259.91	V	-58.56		
	1672.22	V	-45.60		
	2510.89	V	-48.08		
	3343.25	V	-54.13		
	7832.21	V	-48.55		
	45.75	Horizontal	-79.27	-13.00	Pass
	233.89	H	-64.66		
	1672.22	H	-45.60		
	2060.37	H	-49.83		
	3343.25	H	-54.13		
	6687.01	H	-50.83		
251	182.21	Vertical	-71.52	-13.00	Pass
	312.06	V	-70.83		
	1698.14	V	-44.11		
	2547.01	V	-49.73		
	3392.09	V	-51.87		
	4487.72	V	-56.87		
	99.87	Horizontal	-82.26	-13.00	Pass
	259.91	H	-65.86		
	1698.14	H	-43.25		
	2459.02	H	-43.62		
	3392.09	H	-56.18		
	8519.52	H	-46.87		

Remark:

1. The emission behaviour belongs to narrowband spurious emission.
2. The emission levels of not record in the report are very lower than the limit and not show in test report.

PCS1900					
Channel	Frequency (MHz)	Spurious Emission		Limit (dBm)	Result
		Polarization	Level (dBm)		
512	156.09	Vertical	-72.83	-13.00	Pass
	414.90	V	-65.49		
	1616.23	V	-54.10		
	2284.52	V	-50.84		
	4119.70	V	-52.83		
	5554.08	V	-49.77		
	182.21	Horizontal	-70.86	-13.00	Pass
	414.90	H	-65.49		
	1467.29	H	-54.27		
	2274.50	H	-51.03		
	4119.70	H	-55.12		
	7401.51	H	-47.42		
661	89.87	Vertical	-77.84	-13.00	Pass
	414.90	V	-64.99		
	1382.77	V	-54.58		
	2317.38	V	-51.06		
	4119.70	V	-53.80		
	5643.40	V	-47.13		
	233.89	Horizontal	-69.22	-13.00	Pass
	414.90	H	-64.99		
	1355.70	H	-54.91		
	2060.37	H	-48.56		
	3759.98	H	-54.72		
	5643.40	H	-49.93		
810	182.21	Vertical	-74.18	-13.00	Pass
	312.06	V	-77.53		
	1364.66	V	-54.59		
	1909.96	V	-46.37		
	3820.45	V	-51.41		
	5659.79	V	-53.67		
	182.21	Horizontal	-71.98	-13.00	Pass
	259.91	H	-65.08		
	1301.70	H	-54.62		
	2060.37	H	-51.18		
	4346.80	H	-56.48		
	5725.84	H	-49.31		

Remark:

1. The emission behaviour belongs to narrowband spurious emission.
2. The emission levels of not record in the report are very lower than the limit and not show in test report.

WCDMA Band II					
Channel	Frequency (MHz)	Spurious Emission		Limit (dBm)	Result
		Polarization	Level (dBm)		
9262	159.981	Vertical	-74.71	-13.00	Pass
	414.90	V	-67.54		
	1933.18	V	-36.58		
	2597.88	V	-33.42		
	3700.48	V	-51.55		
	7981.27	V	-48.29		
	159.98	Horizontal	-75.47	-13.00	Pass
	307.70	H	-67.10		
	1137.16	H	-56.93		
	1899.50	H	-39.26		
	3700.48	H	-51.90		
	7412.26	H	-49.05		
9400	94.40	Vertical	-79.68	-13.00	Pass
	307.70	V	-69.95		
	1337.94	V	-57.13		
	1960.99	V	-40.61		
	3754.53	V	-44.45		
	5643.40	V	-49.50		
	84.65	Horizontal	-71.48	-13.00	Pass
	266.39	H	-62.55		
	1348.27	H	-54.72		
	1952.39	H	-46.30		
	3759.98	H	-54.92		
	7498.75	H	-48.92		
9538	83.47	Vertical	-71.22	-13.00	Pass
	266.39	V	-59.80		
	1369.17	V	-54.56		
	1989.20	V	-41.29		
	3809.38	V	-45.81		
	5725.84	V	-48.71		
	83.77	Horizontal	-73.71	-13.00	Pass
	239.72	H	-69.73		
	1722.56	H	-53.38		
	2058.11	H	-49.99		
	3809.38	H	-48.31		
	6784.69	H	-51.36		

Remark:

1. The emission behaviour belongs to narrowband spurious emission.
2. The emission levels of not record in the report are very lower than the limit and not show in test report.

WCDMA Band V					
Channel	Frequency (MHz)	Spurious Emission		Limit (dBm)	Result
		Polarization	Level (dBm)		
4132	84.36	Vertical	-72.84	-13.00	Pass
	414.90	V	-63.35		
	1301.70	V	-56.32		
	1652.13	V	-50.62		
	3304.69	V	-57.71		
	4113.73	V	-53.95		
	83.77	Horizontal	-72.18	-13.00	Pass
	245.69	H	-65.91		
	1280.42	H	-56.34		
	1655.77	H	-47.06		
	5792.66	H	-54.09		
	7969.71	H	-48.28		
4183	266.39	Vertical	-70.04	-13.00	Pass
	414.90	V	-67.08		
	1672.22	V	-52.22		
	2254.60	V	-52.18		
	3338.41	V	-54.30		
	7719.44	V	-48.75		
	85.25	Horizontal	-74.18	-13.00	Pass
	266.39	H	-63.91		
	1043.78	H	-55.85		
	1672.22	H	-52.22		
	3338.41	H	-55.01		
	8062.71	H	-49.23		
4233	83.77	Vertical	-71.61	-13.00	Pass
	266.39	V	-63.37		
	1340.89	V	-54.96		
	2461.72	V	-50.75		
	3377.36	V	-51.88		
	6725.91	V	-51.39		
	84.06	Horizontal	-73.71	-13.00	Pass
	266.39	H	-61.28		
	2055.85	H	-51.01		
	2519.18	H	-47.11		
	4673.71	H	-56.38		
	9964.09	H	-44.05		

Remark:

1. The emission behaviour belongs to narrowband spurious emission.
2. The emission levels of not record in the report are very lower than the limit and not show in test report.

5.7. Frequency stability V.S. Temperature measurement

LIMIT

2.5ppm

TEST CONFIGURATION

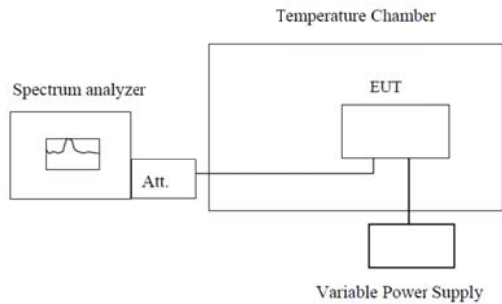

Note : Measurement setup for testing on Antenna connector

TEST PROCEDURE

1. The equipment under test was connected to an external DC power supply and input rated voltage.
2. RF output was connected to a frequency counter or spectrum analyzer via feed through attenuators.
3. The EUT was placed inside the temperature chamber.
4. Set the spectrum analyzer RBW low enough to obtain the desired frequency resolution and measure EUT 25°C operating frequency as reference frequency.
5. Turn EUT off and set the chamber temperature to -30°C. After the temperature stabilized for approximately 30 minutes recorded the frequency.
6. Repeat step measure with 10°C increased per stage until the highest temperature of +50°C reached.

TEST MODE:

Please refer to the clause 3.3

TEST RESULTS

Passed **Not Applicable**

Note: Worst case at GSM850/PCS1900/WCDMA B2/B5 mid channel

Reference Frequency: GSM850 Middle channel=190 channel=836.6MHz					
Power supplied (Vdc)	Temperature (°C)	Frequency error		Limit (ppm)	Result
		Hz	ppm		
3.70	-30	27	0.032	2.50	Pass
	-20	28	0.033		
	-10	26	0.031		
	0	28	0.033		
	10	27	0.032		
	20	28	0.033		
	30	29	0.035		
	40	26	0.031		
	50	25	0.030		
Reference Frequency: PCS1900 Middle channel=661 channel=1880MHz					
Power supplied (Vdc)	Temperature (°C)	Frequency error		Limit (ppm)	Result
		Hz	ppm		
3.70	-30	28	0.015	2.50	Pass
	-20	29	0.015		
	-10	26	0.014		
	0	26	0.014		
	10	28	0.015		
	20	25	0.013		
	30	28	0.015		
	40	27	0.014		
	50	29	0.015		

Reference Frequency: WCDMA Band II Middle channel=9400 channel=1880MHz					
Power supplied (Vdc)	Temperature (°C)	Frequency error		Limit (ppm)	Result
		Hz	ppm		
3.70	-30	11	0.006	2.50	Pass
	-20	13	0.007		
	-10	12	0.006		
	0	14	0.007		
	10	12	0.006		
	20	14	0.007		
	30	11	0.006		
	40	13	0.007		
	50	10	0.005		
Reference Frequency: WCDMA Band V Middle channel=4183 channel=836.6MHz					
Power supplied (Vdc)	Temperature (°C)	Frequency error		Limit (ppm)	Result
		Hz	ppm		
3.70	-30	15	0.018	2.50	Pass
	-20	17	0.020		
	-10	17	0.020		
	0	16	0.019		
	10	18	0.022		
	20	16	0.019		
	30	19	0.023		
	40	16	0.019		
	50	18	0.022		

5.8. Frequency stability V.S. Voltage measurement

LIMIT

2.5ppm

TEST CONFIGURATION

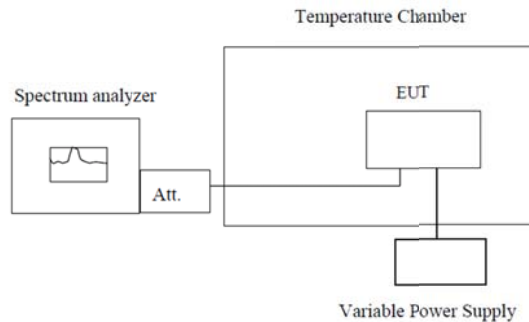

Note : Measurement setup for testing on Antenna connector

TEST PROCEDURE

1. Set chamber temperature to 25°C. Use a variable DC power source to power the EUT and set the voltage to rated voltage.
2. Set the spectrum analyzer RBW low enough to obtain the desired frequency resolution and record the frequency.
3. Reduce the input voltage to specified extreme voltage variation (+/- 15%) and endpoint, record the maximum frequency change.

TEST MODE:

Please refer to the clause 3.3

TEST RESULTS

Passed **Not Applicable**

Note: Worst case at GSM850/PCS1900/WCDMA B2/B5 mid channel

Reference Frequency: GSM850 (GSM link) Middle channel=190 channel=836.6MHz					
Temperature (°C)	Power supplied (Vdc)	Frequency error		Limit (ppm)	Result
		Hz	ppm		
25	4.20	14	0.017	2.50	Pass
	3.70	13	0.016		
	3.50	16	0.019		
Reference Frequency: PCS1900 (GSM link) Middle channel=661 channel=1880MHz					
Temperature (°C)	Power supplied (Vdc)	Frequency error		Limit (ppm)	Result
		Hz	ppm		
25	4.20	18	0.010	2.50	Pass
	3.70	20	0.011		
	3.50	18	0.010		
Reference Frequency: WCDMA Band II Middle channel=9400 channel=1880MHz					
Temperature (°C)	Power supplied (Vdc)	Frequency error		Limit (ppm)	Result
		Hz	ppm		
25	4.20	11	0.006	2.50	Pass
	3.70	12	0.006		
	3.50	10	0.005		
Reference Frequency: WCDMA Band VMiddle channel=4183 channel=836.6MHz					
Temperature (°C)	Power supplied (Vdc)	Frequency error		Limit (ppm)	Result
		Hz	ppm		
25	4.20	25	0.030	2.50	Pass
	3.70	26	0.031		
	3.50	28	0.033		

5.9. Peak-Average Ratio

LIMIT

13dB

TEST CONFIGURATION

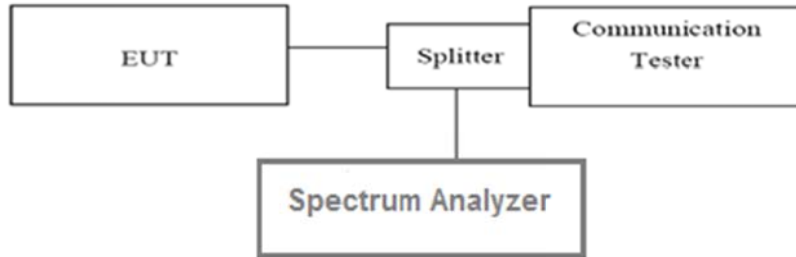

TEST PROCEDURE

According with KDB 971168

1. The signal analyzer' s CCDF measurement profile is enabled
2. Frequency = carrier center frequency
3. Measurement BW > Emission bandwidth of signal
4. The signal analyzer was set to collect one million samples to generate the CCDF curve
5. The measurement interval was set depending on the type of signal analyzed. For continuous signals (>98% duty cycle), the measurement interval was set to 1ms. For burst transmissions, the spectrum analyzer is set to use an internal " RF Burst" trigger that is synced with an incoming pulse and the measurement interval is set to less than the duration of the " on time" of one burst to ensure that energy is only captured during a time in which the transmitter is operating at maximum power

TEST MODE:

Please refer to the clause 3.3

TEST RESULTS

Passed **Not Applicable**

Note: Worst case PCS1900, WCDMA BAND1900

Band	Channel	Frequency(MHz)	PAR	Limit(dB)	Result
PCS1900	512	1850.2	9.66	13.00	Pass
	661	1880.0	9.52	13.00	Pass
	810	1909.8	9.46	13.00	Pass

Band	Channel	Frequency(MHz)	PAR	Limit(dB)	Result
WCDMA BAND II	9262	1852.4	2.90	13.00	Pass
	9400	1880.0	2.96	13.00	Pass
	9538	1907.6	2.88	13.00	Pass

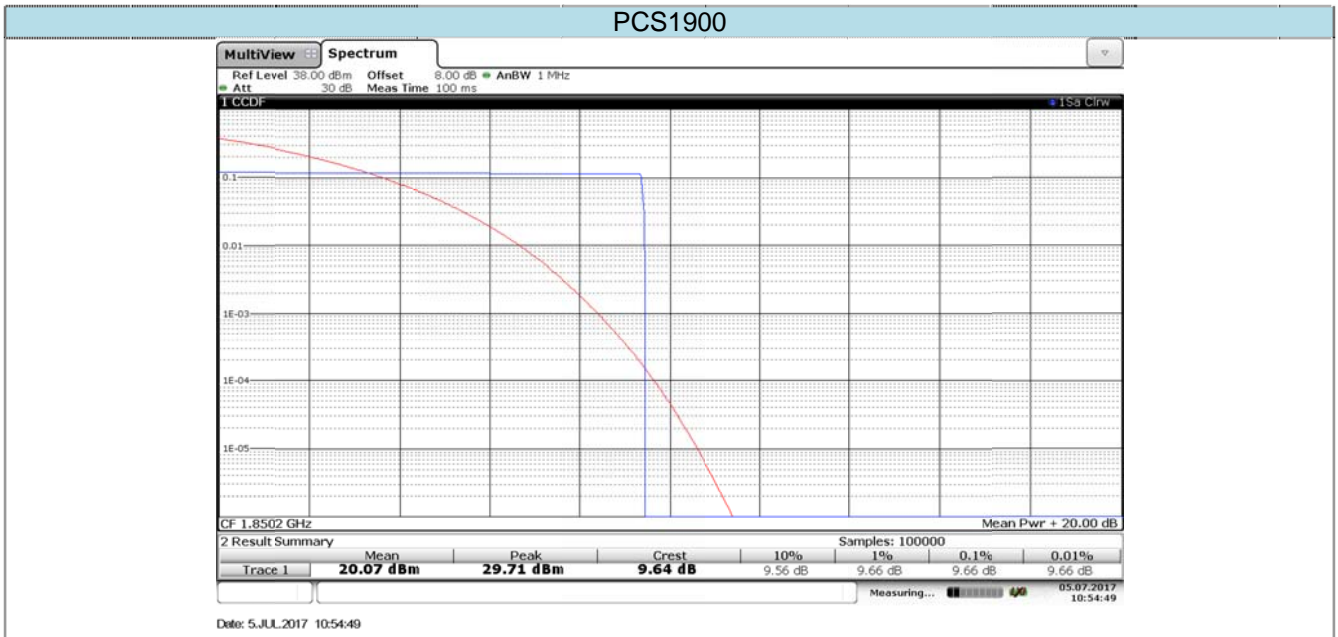

Channel 512

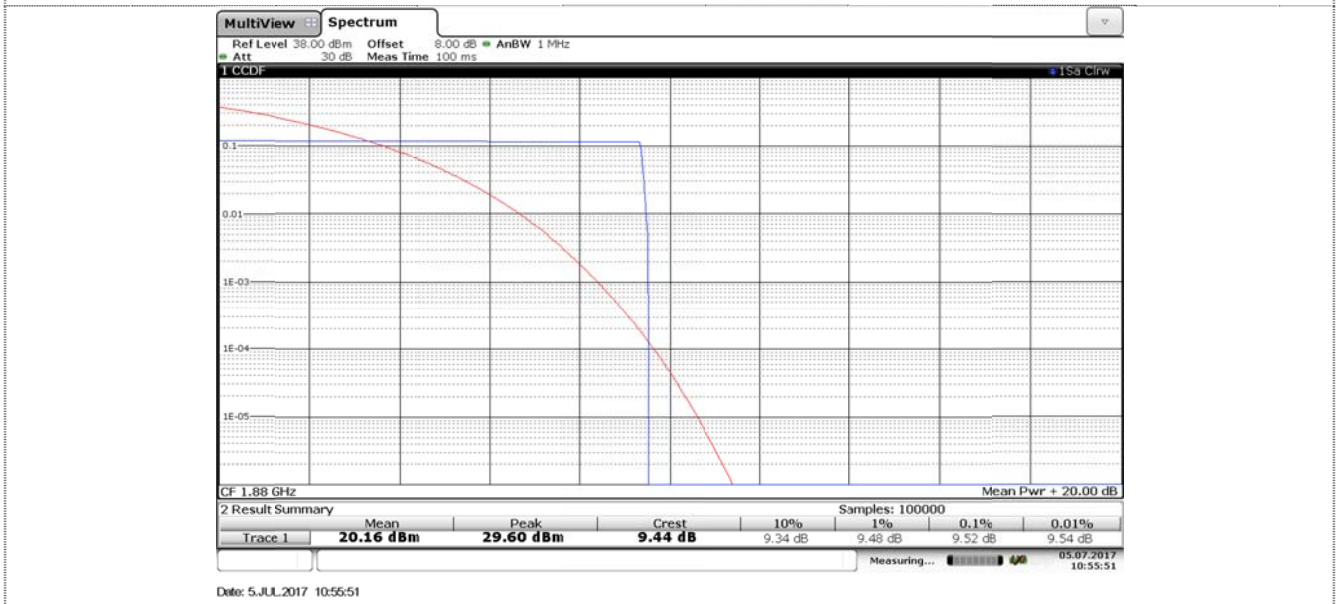

Channel 661

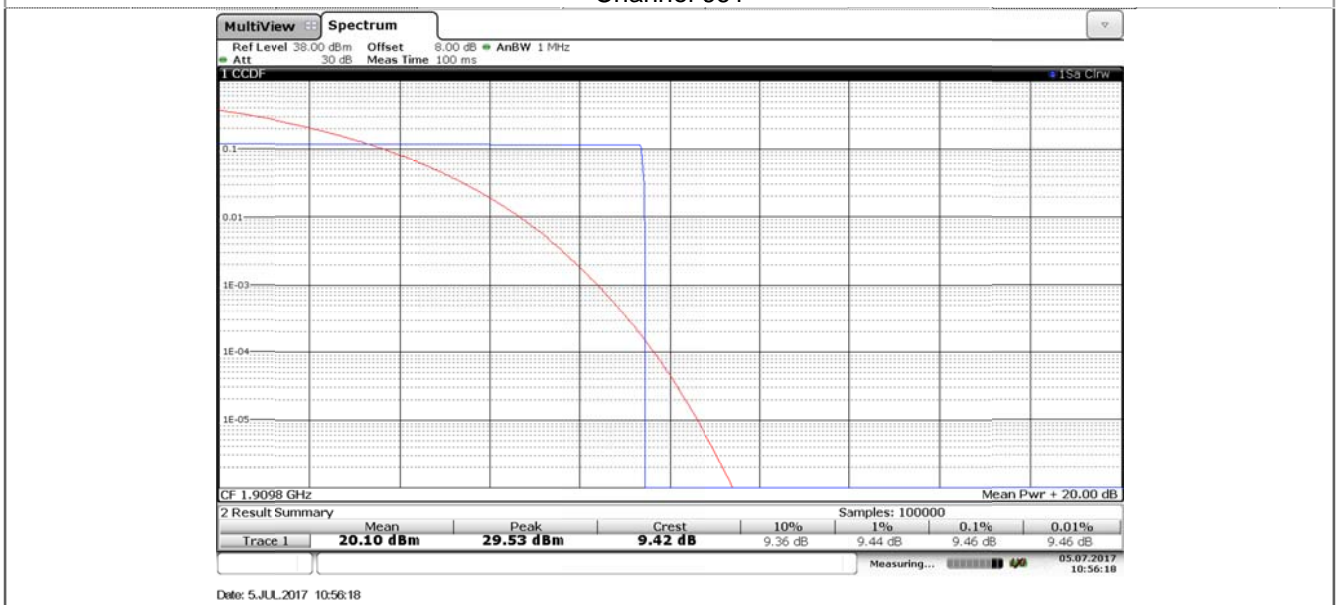

Channel 810

WCDMA BAND II

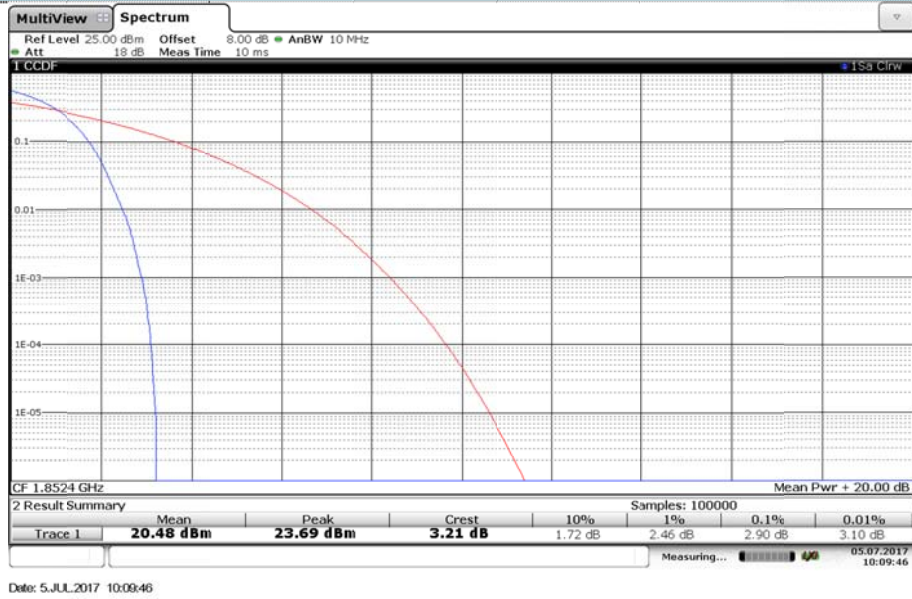

Channel 9262

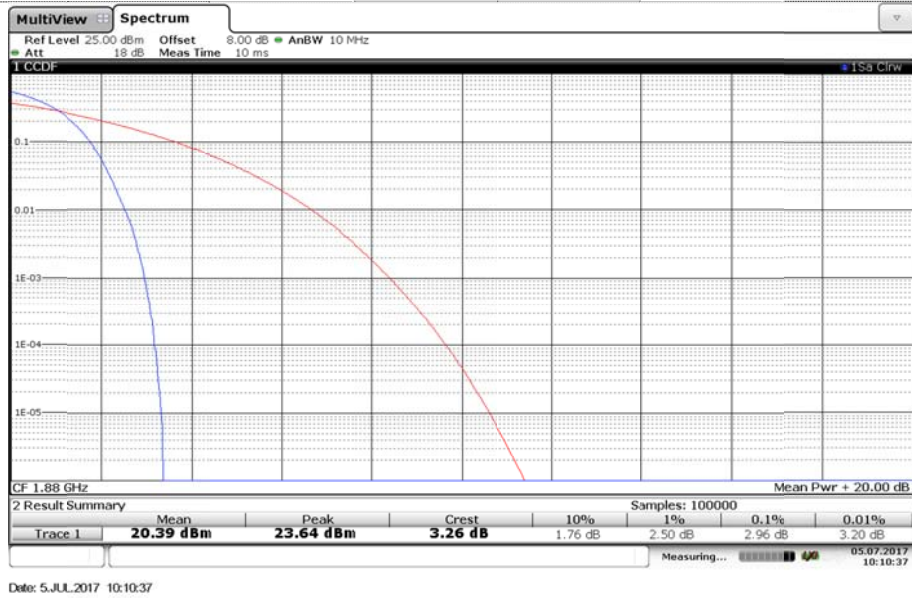

Channel 9400

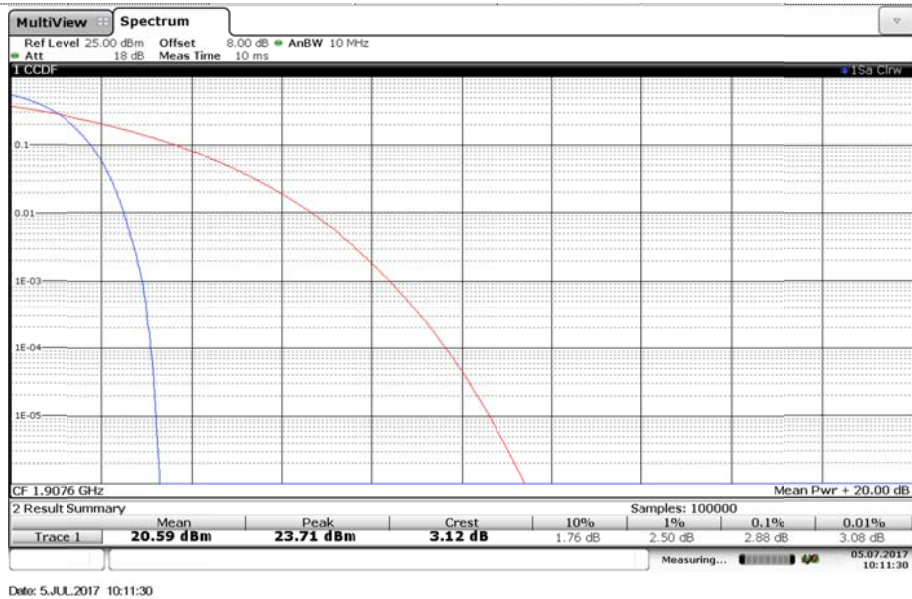

Channel 9538

6. Test Setup Photos of the EUT

Radiated emission:

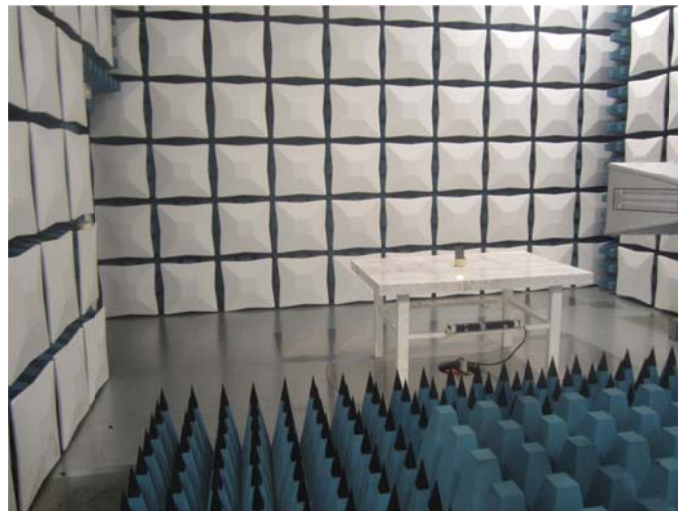
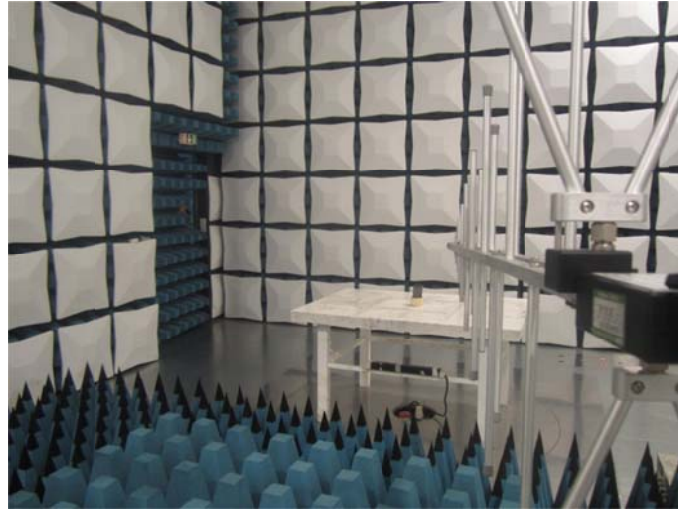

7. External and Internal Photos of the EUT

External photos of the EUT

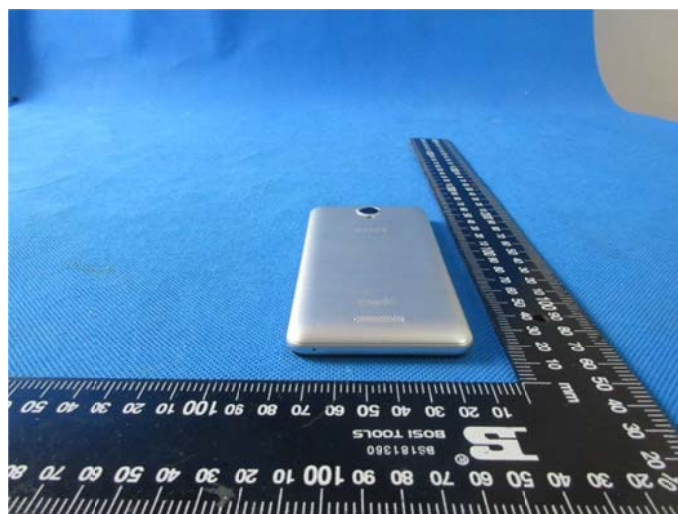
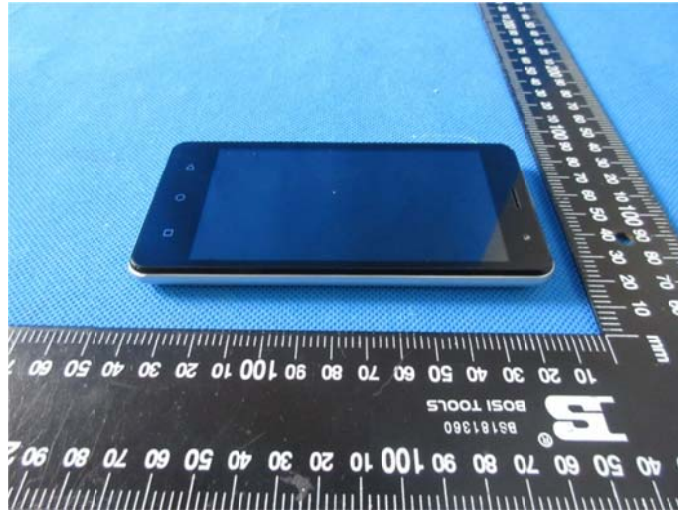

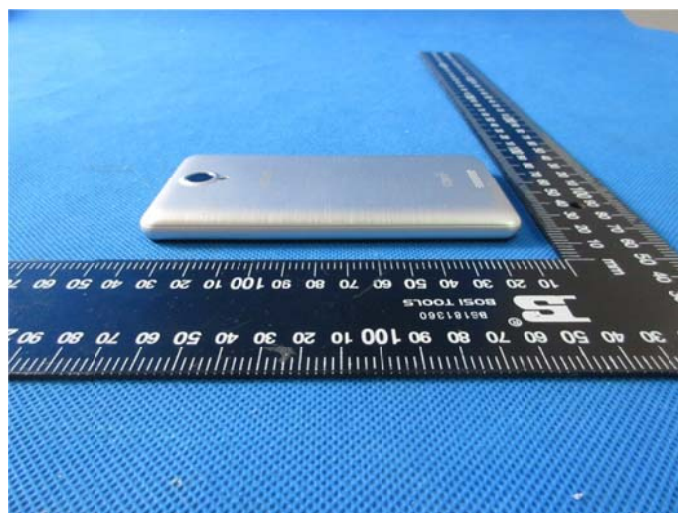
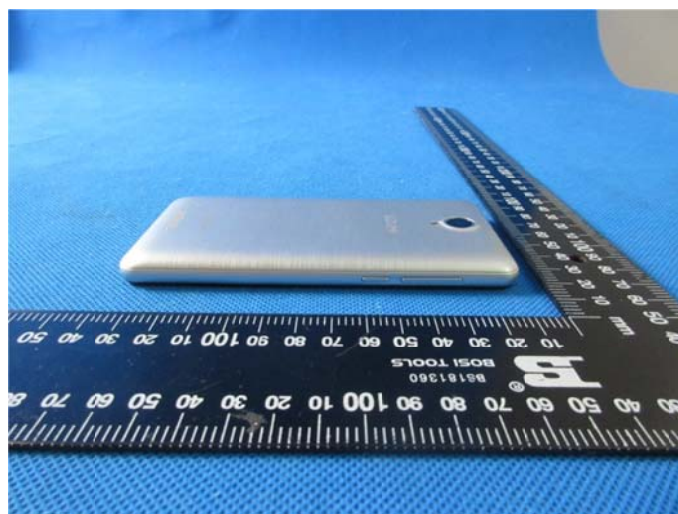
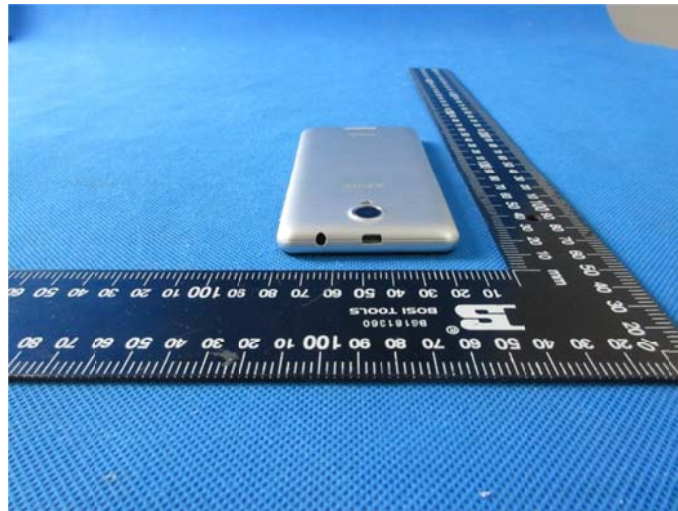

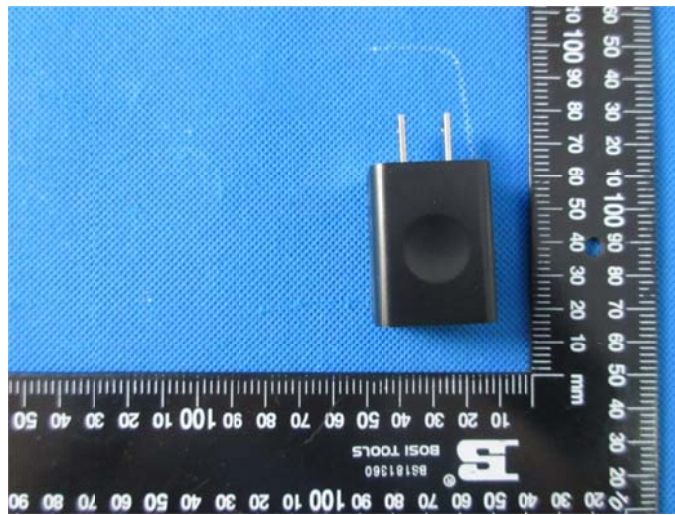

Internal photos of the EUT

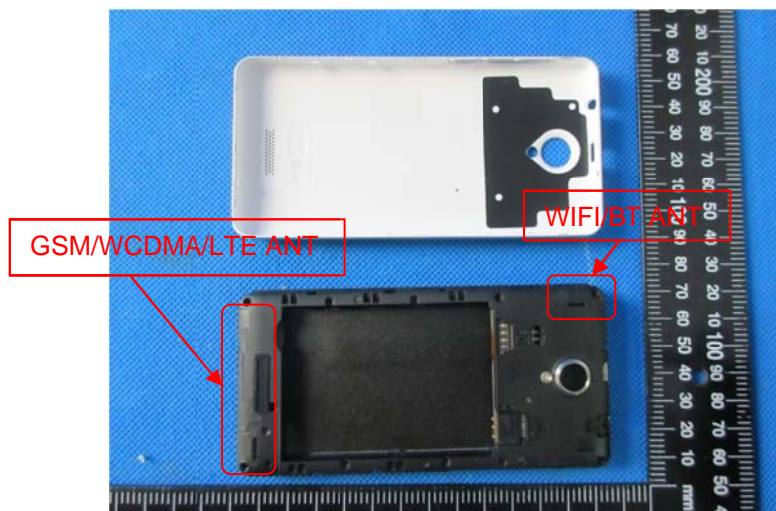
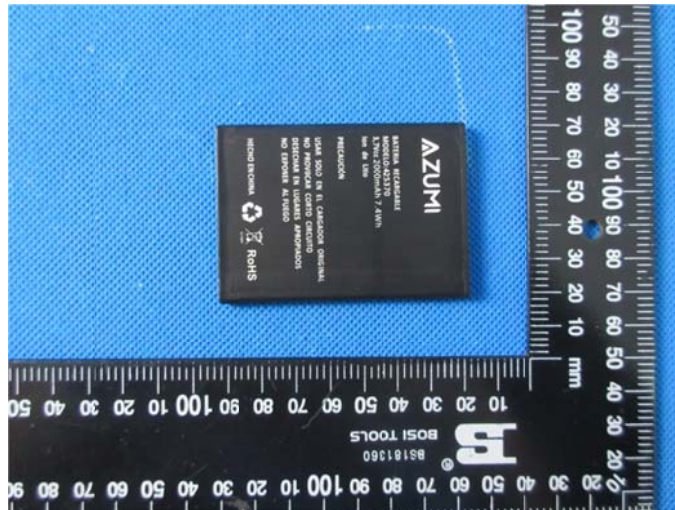

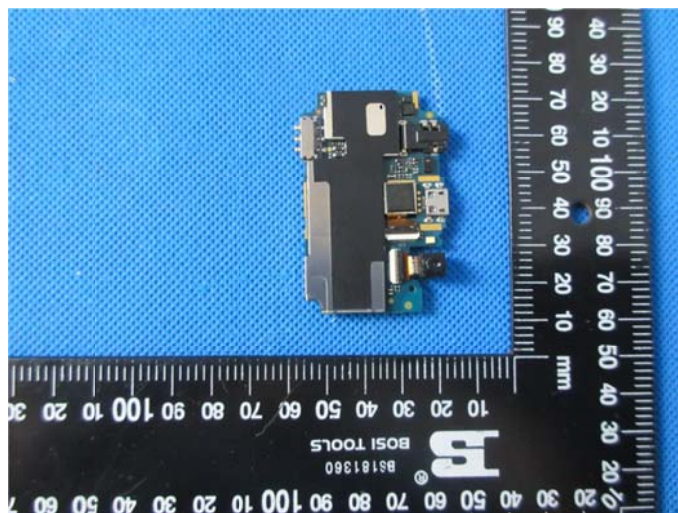
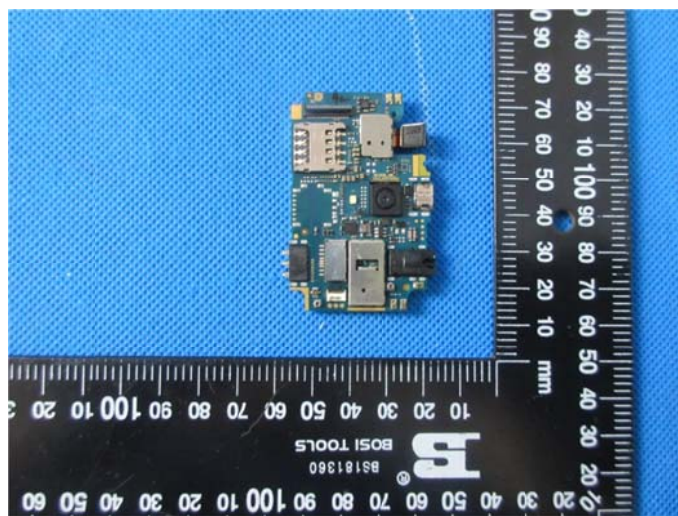
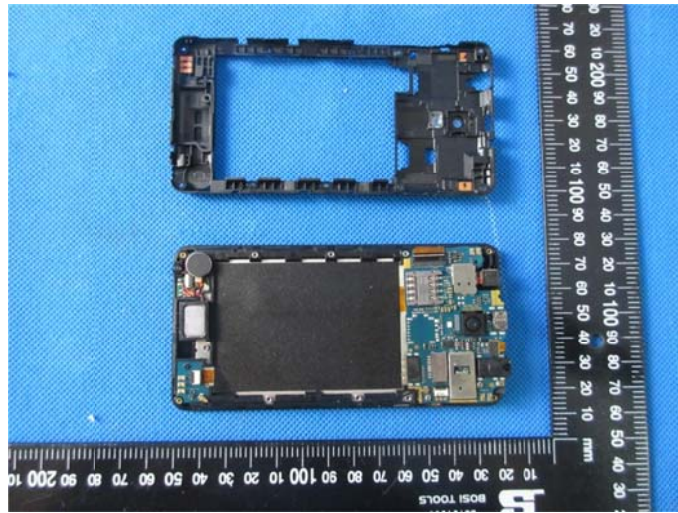

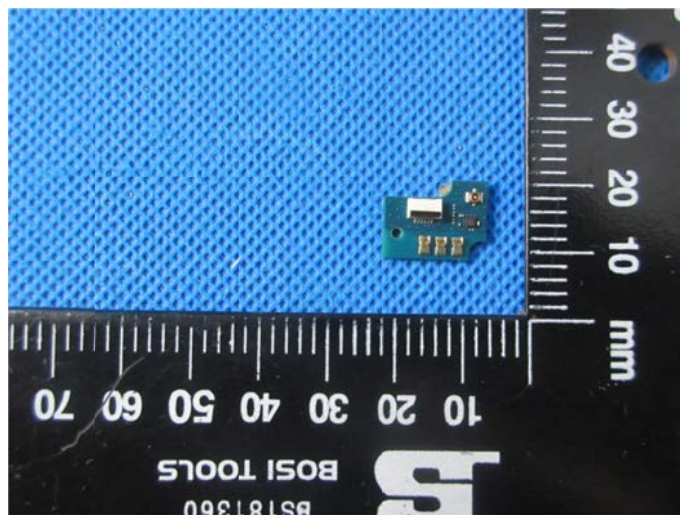
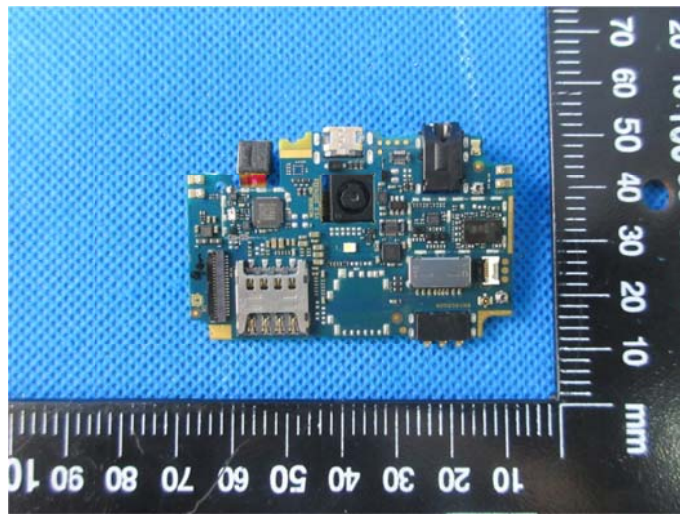
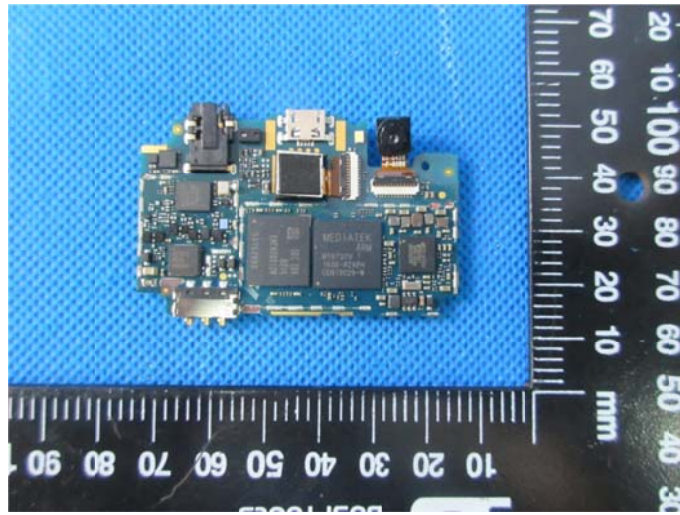

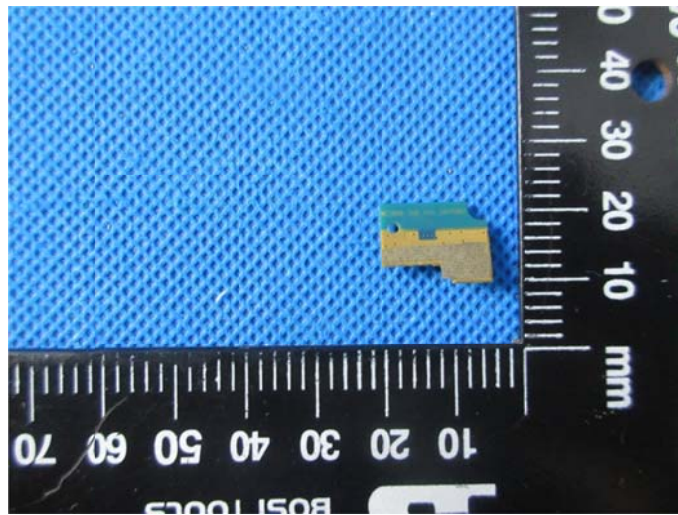

.....End of Report.....