

# FCC Hearing Aid Compatibility (HAC) T-Coil Test Report

Product Name : Mobile Phone  
Model No. : AC24G

Applicant : AZUMI S.A

Address : Avenida Aquilino de la Guardia con Calle 47, PH Ocean Plaza,  
Piso 16 of. 16-01, Marbella, Ciudad de Panamá

Date of Receipt : 2016/05/13

Issued Date : 2016/06/16

Report No. : 1650339R-SAUSP01V00-A

Report Version : V1.0



The test results relate only to the samples tested.

The test results shown in the test report are traceable to the national/international standard through the calibration of the equipment and evaluated measurement uncertainty herein.

This report must not be used to claim product endorsement by TAF or any agency of the government.

The test report shall not be reproduced without the written approval of QuieTek Corporation.

# Test Report

Issued Date: 2016/06/16

Report No.:1650339R-SAUSP01V00-A



Product Name : Mobile Phone  
 Applicant : AZUMI S.A  
 Address : Avenida Aquilino de la Guardia con Calle 47, PH Ocean Plaza,  
 Piso 16 of. 16-01, Marbella, Ciudad de Panamá  
 Manufacturer : AZUMI HK LTD  
 Model No. : AC24G  
 FCC ID : QRP-AZUMIAC24G  
 Applicable Standard : 47CFR § 20.19  
 ANSI C63.19 2011  
 KDB 285076 D01  
 Test Result : T4  
 Application Type : Certification

Documented By : Elephant Chen  
 ( Adm. Assistant / Elephant Chen )

Tested By : Vorana Chen  
 ( Senior Engineer / Vorana Chen )

Approved By :   
 ( Director / Vincent Lin )

## TABLE OF CONTENTS

Description	Page
<b>1. General Information .....</b>	<b>4</b>
1.1 EUT Description .....	4
1.2 Test Environment .....	5
<b>2. HAC T-Coil Measurement System .....</b>	<b>6</b>
2.1 DASY5 System Description .....	6
2.2 Audio Magnetic Field Probe .....	7
2.3 Audio Magnetic Measurement Instrument (AMMI) .....	8
2.4 Helmholtz Calibration Coil (AMCC) .....	8
2.5 Boundary Detection Unit and Probe Mounting Device .....	9
2.6 DATA Acquisition Electronics (DAE) and Measurement Server .....	9
2.7 Robot.....	10
2.8 Light Beam Unit.....	10
2.9 Device Holder .....	10
2.10 Test Arch Phantom.....	11
<b>3. System Validation &amp; Calibration.....</b>	<b>12</b>
3.1 Input Channel Calibration.....	12
3.2 Probe Calibration in AMCC .....	12
3.3 Reference Input Level.....	13
3.4 Reference Input of Audio Signal Spectrum .....	14
<b>4. Measurement Description.....</b>	<b>15</b>
4.1 T-Coil Test Flowchart.....	15
4.2 Test Positions .....	16
4.3 T-Coil Test Procedure Description .....	16
<b>5. T-Coil Signal Quality Categories .....</b>	<b>18</b>
5.1 Axial Field Intensity.....	18
5.2 Frequency Response .....	18
5.3 Signal Quality .....	19
<b>6. Test Equipment List .....</b>	<b>20</b>
<b>7. Measurement Uncertainty .....</b>	<b>21</b>
<b>8. Test Results .....</b>	<b>22</b>
8.1 T-Coil Test Results Summary.....	22
Appendix.....	24
Appendix A. Probe Calibration in AMCC	
Appendix B. T-Coil Measurement Data	
Appendix C. Test Setup Photographs & EUT Photographs	
Appendix D. Audio Magnetic 1D Field Probe	

## 1. General Information

### 1.1 EUT Description

Product Name	Mobile Phone
Model No.	AC24G
FCC ID	QRP-AZUMIAC24G
TX Frequency	GSM 850/WCDMA Band V : 824MHz~849MHz PCS 1900/WCDMA Band II : 1850MHz~1910MHz
RX Frequency	GSM 850/WCDMA Band V : 869MHz~894MHz PCS 1900/WCDMA Band II : 1930MHz~1990MHz
Device Category	Portable
RF Exposure Environment	Uncontrolled
Max. Output Power (Conducted)	GSM 850: 31.33dBm; PCS 1900: 28.57dBm WCDMA Band II: 21.5dBm; WCDMA Band V: 22.49dBm

Note: Air interface as below

Air interface	frequency	Type	C63.19	Simultaneous	VoIP	VoLTE	Additional GSM power Reduction
GSM	850	VO	Yes (2011)	BT	N/A	N/A	N/A
GSM	1900	VO	Yes (2011)	BT	N/A	N/A	N/A
WCDMA	II-850	VO	Yes (2011)	BT	N/A	N/A	N/A
WCDMA	V-1900	VO	Yes (2011)	BT	N/A	N/A	N/A
GSM	850	DT	N/A	BT	Yes	N/A	N/A
GSM	1900	DT	N/A	BT	Yes	N/A	N/A
WCDMA	II-850	DT	N/A	BT	Yes	N/A	N/A
WCDMA	V-1900	DT	N/A	BT	Yes	N/A	N/A
BT	2.4G	DT	N/A	WWAN	Yes	N/A	N/A

## 1.2 Test Environment

Ambient conditions in the laboratory:

Items	Required	Actual
Temperature (°C)	18-25	22.4± 2
Humidity (%RH)	30-70	53

Site Description:

Accredited by TAF  
Accredited Number: 3023  
Effective through: December 12, 2017

Site Name: Quietek Corporation

Site Address: No.5-22, Ruishukeng, Linkou Dist.,  
New Taipei City 24451,  
Taiwan. R.O.C.  
TEL: 886-2-8601-3788 / FAX: 886-2-8601-3789  
E-Mail: [service@quietek.com](mailto:service@quietek.com)

## 2. HAC T-Coil Measurement System

### 2.1 DASY5 System Description

The measurements were performed with Dasy5 automated near-field scanning system comprised of high precision robot, robot controller, computer, Magnetic probe, probe alignment sensor, non-conductive phone holder. Test Arch and software extension. The following figure shows the setup and cabling.

The principal cabling of the T-Coil setup is shown as below. All cables provided with the basic setup have a length of approximately 5 m. The probe is connected to the AMMI with a thin, highly flexible 3-wire shielded cable for the signal and supply. As the shield of the probe cable must have good contact to the connector at all times, no stress should be applied to the cable in any position. Therefore, only connect the probe cable after the DAE with probe is mounted in the DAE holder of the robot arm.

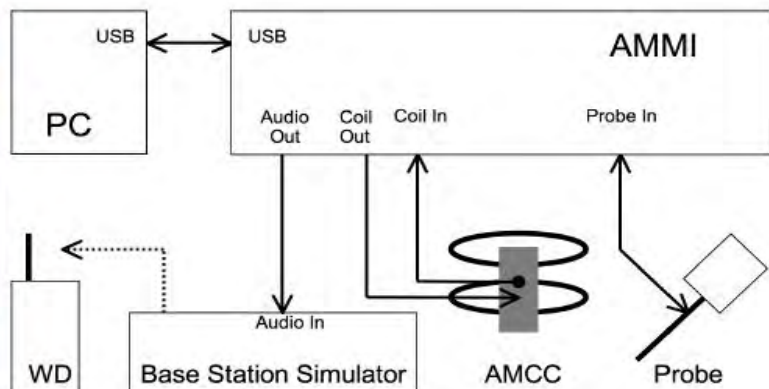

The DASY5 system for performing compliance tests consists of the following items:

- A standard high precision 6-axis robot with controller, teach pendant and software.
- A data acquisition electronics (DAE) which performs the signal amplification, signal multiplexing, AD-conversion, offset measurements, mechanical surface detection, collision detection, etc. The unit is battery powered with standard or rechargeable batteries. The signal is optically transmitted to the EOC.
- The Electro-optical converter (EOC) performs the conversion from optical to electrical signals for the digital communication to the DAE. To use optical surface detection, a special version of the EOC is required. The EOC signal is transmitted to the measurement server.

- The Light Beam used is for probe alignment. This improves the (absolute) accuracy of the probe positioning.
- A computer running WinXP and the DASY5 software.
- Remote control and teach pendant as well as additional circuitry for robot safety such as warning lamps, etc.
- The Arch phantom, the device holder and other accessories according to the targeted measurement.

## 2.2 Audio Magnetic Field Probe

The AM1D probe is an active probe with a single sensor. It is fully RF-shielded and has a rounded tip 6mm in diameter incorporating a pickup coil with its center offset 3mm from the tip and the sides. The symmetric signal preamplifier in the probe is fed via the shielded symmetric output cable from the AMMI with a 48V “phantom” voltage supply. The 7-pin connector on the back in the axis of the probe does not carry any signals. It is mounted to the DAE for the correct orientation of the sensor. If the probe axis is tilted 54.7 degree from the vertical, the sensor is approximately vertical when the signal connector is at the underside of the probe (cable hanging downwards). The probe/system complies with the frequency response and linearity requirements in C63.19 according to the Speag’s calibrated report as shown in appendix C.

### Specification:

<b>Model</b>	AM1D	
<b>Frequency Range</b>	0.1 - 20 kHz (RF sensitivity <-100 dB, fully RF shielded)	
<b>Sensitivity</b>	<-50 dB A/m @ 1 kHz	
<b>Pre-amplifier</b>	40 dB, symmetric	
<b>Dimensions</b>	Tip diameter / length: 6 / 290 mm, sensor according to ANSI-PC63.19	

### 2.3 Audio Magnetic Measurement Instrument (AMMI)

The Audio Magnetic Measuring Instrument (AMMI) is a desktop 19-inch unit containing a sampling unit, a waveform generator for test and calibration signals, and a USB interface.

**Specification:**

<b>Model</b>	AMMI
<b>Sampling rate</b>	48 kHz/24 bit
<b>Dynamic range</b>	85 dB
<b>Test signal generation</b>	User selectable and predefined (via PC)
<b>Calibration</b>	Auto-calibration/full system calibration using AMCC with monitor output
<b>Connection:</b>	Audio Out - audio signal to the base station simulator Coil Out - test and calibration signal to the AMCC Coil In - monitor signal from the AMCC BNC connector Probe In - probe signal
<b>Dimensions</b>	482 x 65 x 270 mm



### 2.4 Helmholtz Calibration Coil (AMCC)

The Audio Magnetic Calibration coil is a Helmholtz Coil designed according to ANSI C63.19-2007 section D.9, for calibration of the AM1D probe. The two horizontal coils generate a homogeneous magnetic field in the z direction. The DC input resistance is adjusted to approximately 50 Ohm by a series resistor, and a shunt resistor of 10 Ohm allows monitoring the current with a scale of 1:10. The AMCC coil is qualified according to certificate report that shown in appendix C.

**Specification:**

<b>Model</b>	Helmholtz Calibration Coil (AMCC)	
<b>Coil In</b>	typically 50 Ohm	
<b>Coil Monitor</b>	100ohm ±1%(100mV corresponding to 1 A/m)	
<b>Dimensions</b>	370 x 370 x 196 mm	



## 2.5 Boundary Detection Unit and Probe Mounting Device

The DASY probes use a precise connector and an additional holder for the probe, consisting of a plastic tube and a flexible silicon ring to center the probe. The connector at the DAE is flexibly mounted and held in the default position with magnets and springs. Two switching systems in the connector mount detect frontal and lateral probe collisions and trigger the necessary software response.



## 2.6 DATA Acquisition Electronics (DAE) and Measurement Server

The data acquisition electronics (DAE) consists of a highly sensitive electrometer-grade preamplifier with auto-zeroing, a channel and gain-switching multiplexer, a fast 16 bit AD-converter and a command decoder and control logic unit.

Transmission to the measurement server is accomplished through an optical downlink for data and status information as well as an optical uplink for commands and the clock.

The input impedance of the DAE4 is 200M Ohm; the inputs are symmetrical and floating. Common mode rejection is above 80dB.



The DASY5 measurement server is based on a PC/104 CPU board with a 400MHz intel ULV Celeron, 128MB chipdisk and 128MB RAM. The necessary circuits for communication with the DAE electronics box, as well as the 16 bit AD converter system for optical detection and digital I/O interface are contained on the DASY5 I/O board, which is directly connected to the PC/104 bus of the CPU board.



## 2.7 Robot

The DASY5 system uses the high precision robots TX60L type out of the newer series from Stäubli SA (France). For the 6-axis controller DASY5 system, the CS8C robot controller version from Stäubli is used.

The XL robot series have many features that are important for our application:

- High precision (repeatability 0.02 mm)
- High reliability (industrial design)
- Jerk-free straight movements
- Low ELF interference (the closed metallic construction shields against motor control fields)
- 6-axis controller



## 2.8 Light Beam Unit

The light beam switch allows automatic "tooling" of the probe. During the process, the actual position of the probe tip with respect to the robot arm is measured, as well as the probe length and the horizontal probe offset. The software then corrects all movements, such that the robot coordinates are valid for the probe tip.

The repeatability of this process is better than 0.1 mm. If a position has been taught with an aligned probe, the same position will be reached with another aligned probe within 0.1 mm, even if the other probe has different dimensions. During probe rotations, the probe tip will keep its actual position.



## 2.9 Device Holder

The HAC device holder is made from SPEAG. The holder supports accurate and reliable positioning of any phone effect on near field  $\pm 0.5$  dB. It is used to adjust DUT to suitable position.

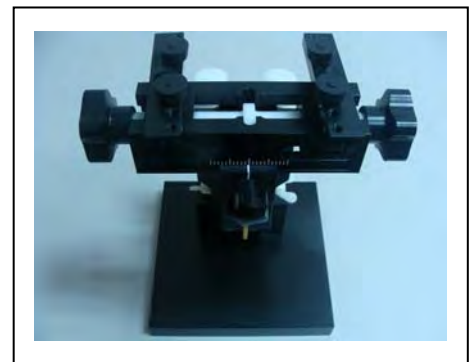

### 2.10 Test Arch Phantom

The HAC Test Arch phantom is used with several sections, each considering the different vertical distances of the DUT or the dipole as well as the different sensor offsets of the E- and H-Field probes. The Test Arch phantom V4.8 includes a single predefined RF phantom section (V4.9 also a TCoil section).



<b>Model</b>	Arch Phantom V 4.9
<b>Dimensions</b>	370 x 370 x 370mm

### **3. System Validation & Calibration**

At the beginning of the HAC T-coil measurement, a 3-phase calibration was performed per Speag instruction to ensure accurate measurement of the voltages and ABM field. Reference input level was also validated and calibrated per C63.19.

#### **3.1 Input Channel Calibration**

Phase 1: The AMMI audio output was switched off, and a 200 mV<sub>pp</sub> symmetric rectangular signal of 1 kHz was generated and internally connected directly to both channels of the sampling unit (coil in, probe in).

Phase 2: The AMMI audio output was off, and a 20 mV<sub>pp</sub> symmetric 100 Hz signal was internally connected.

The signals during phases 1 and 2 were available at the output on the rear panel of the AMMI. The output must however not be loaded in order not to influence the calibration. After the first two phases, the two input channels were both calibrated for absolute measurements of voltages. The resulting factors were displayed above the multi-meter window.

After phases 1 and 2, the input channels were calibrated to measure exact voltages.

#### **3.2 Probe Calibration in AMCC**

Phase 3: a multi-sine signal covering each third-octave band from 50 Hz to 10 kHz was generated and applied to both audio outputs. The probe should be positioned in the center of the AMCC (user point “coil center”) and aligned in the z-direction, the field orientation of the AMCC. The Coil In channel was measuring the voltage over the AMCC internal shunt, which is proportional to the magnetic field in the AMCC. At the same time, the probe in channel samples the amplified signal picked up by the probe coil. The ratio of the two voltages – in each third-octave filter – leads to the calibration factor of the probe over the frequency band of interest. The Coil signal is scaled in dBV, and the Probe signal is normalized to show dBV at a frequency of 1 kHz. The sensitivity is the ratio at 1 kHz. The frequency response of the probe (subject to an integrator) can be calculated from the difference of the two curves. The probe sensitivity at 1 kHz was calibrated by AMCC coil for verification of setup performance, and the frequency response and sensitivity was shown in appendix A.

### 3.3 Reference Input Level

According to ANSI C63.19:2011 section 7.4.2.1, the normal speech input level for HAC T-coil tests shall be set to -16dBm0 for GSM and UMTS (WCDMA), and to -18 dBm0 for CDMA. This technical note shows a possibility to evaluate and set the correct level with the HAC T-Coil setup with a Rohde & Schwarz communication tester CMU200 with audio option B52 and B85. Establish a call from the CMU200 to a wireless device. The calibration signals are only available while the call is connected. Select CMU200 Network Bitstream "Decoder Cal" to have a 1kHz signal with a level of 3.14dBm0 at the speech output. Run the measurement job and read the voltage level at the multi-meter display "Coil signal". Read the RMS voltage corresponding to 3.14dBm0 and note it. Calculate the desired signal levels of -16dBm0:

$$3.14 \text{ dBm0} = -2.46 \text{ dBV}$$

$$-16 \text{ dBm0} = -21.6 \text{ dBV}$$

Determine the 1kHz input level to generate the desired signal level of -16 dBm0 Select CMU200 Network Bitstream "Codec Cal" to loop the input via the codec to the output.

Run the measurement job (AMMI 1kHz signal with gain 10 inserted) and read the voltage level at the multi-meter display "Coil signal". Calculate the required gain setting for the above levels:

$$\text{Gain } 10 = -19.98 \text{ dBV}$$

$$\text{Difference for } -16 \text{ dBm0} = -21.6 - (-19.98) = -1.62 \text{ dB}$$

$$\text{Gain factor } 10^{[(-1.65) / 20]} = 0.830$$

$$\text{Resulting gain } 10 \times 0.827 = 8.30$$

The predefined signal types have the following differences / factors compared to the 1kHz sine signal:

Signal Type	Duration[s]	Peak-to-RMS [dB]	RMS [dB]	Gain factor	Gain setting
48k_voice_1kHz_1s.wav	1	16.2	-12.7	4.33	35.93
48k_voice_300-3000_2s.wav	2	21.6	-18.6	8.48	70.37

### 3.4 Reference Input of Audio Signal Spectrum

With the reference job "use as reference" in the beginning of a procedure, measure the spectrum of the current when applied to the AMCC, i.e. the input magnetic field spectrum, as shown below. For this, the delay of the window shall be set to a multiple of the signal period and at least 2s. From the measurement on the device, using the same signal, the postprocessor deducts the input spectrum, so the result represents the net DUT response.



48KHz\_Voice\_300-3000\_2S

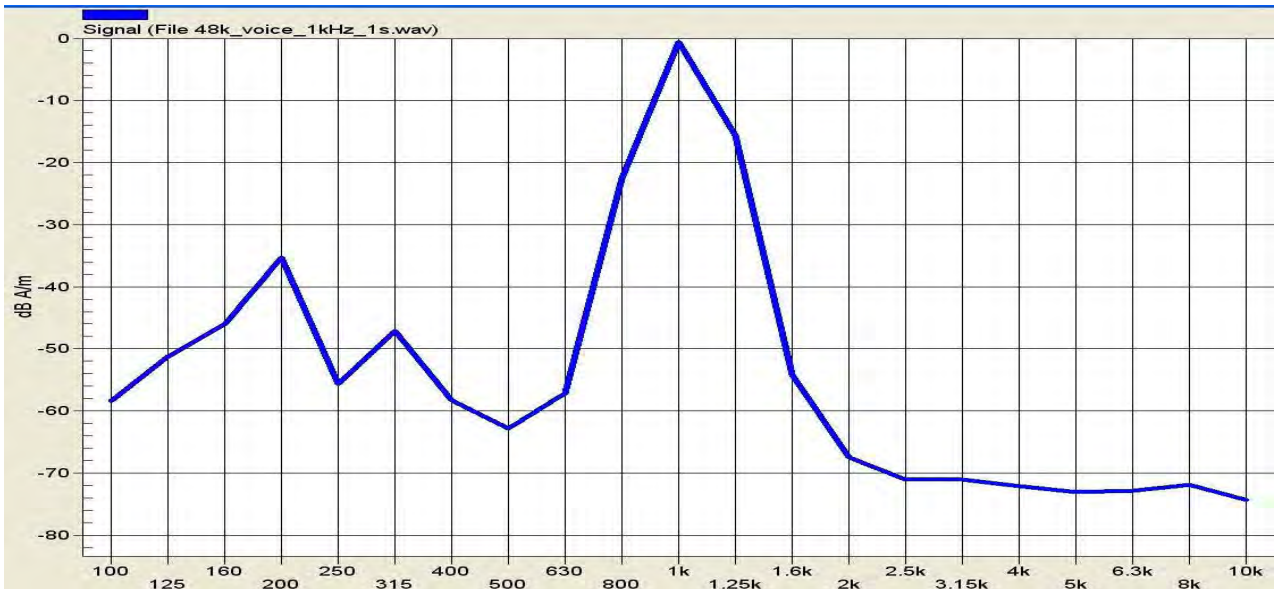

48KHz\_Voice\_1KHz\_1S



## 4. Measurement Description

### 4.1 T-Coil Test Flowchart

The device was positioned and setup according to ANSI C63.19-2011. The following shows the T-Coil Signal measurement flowchart:

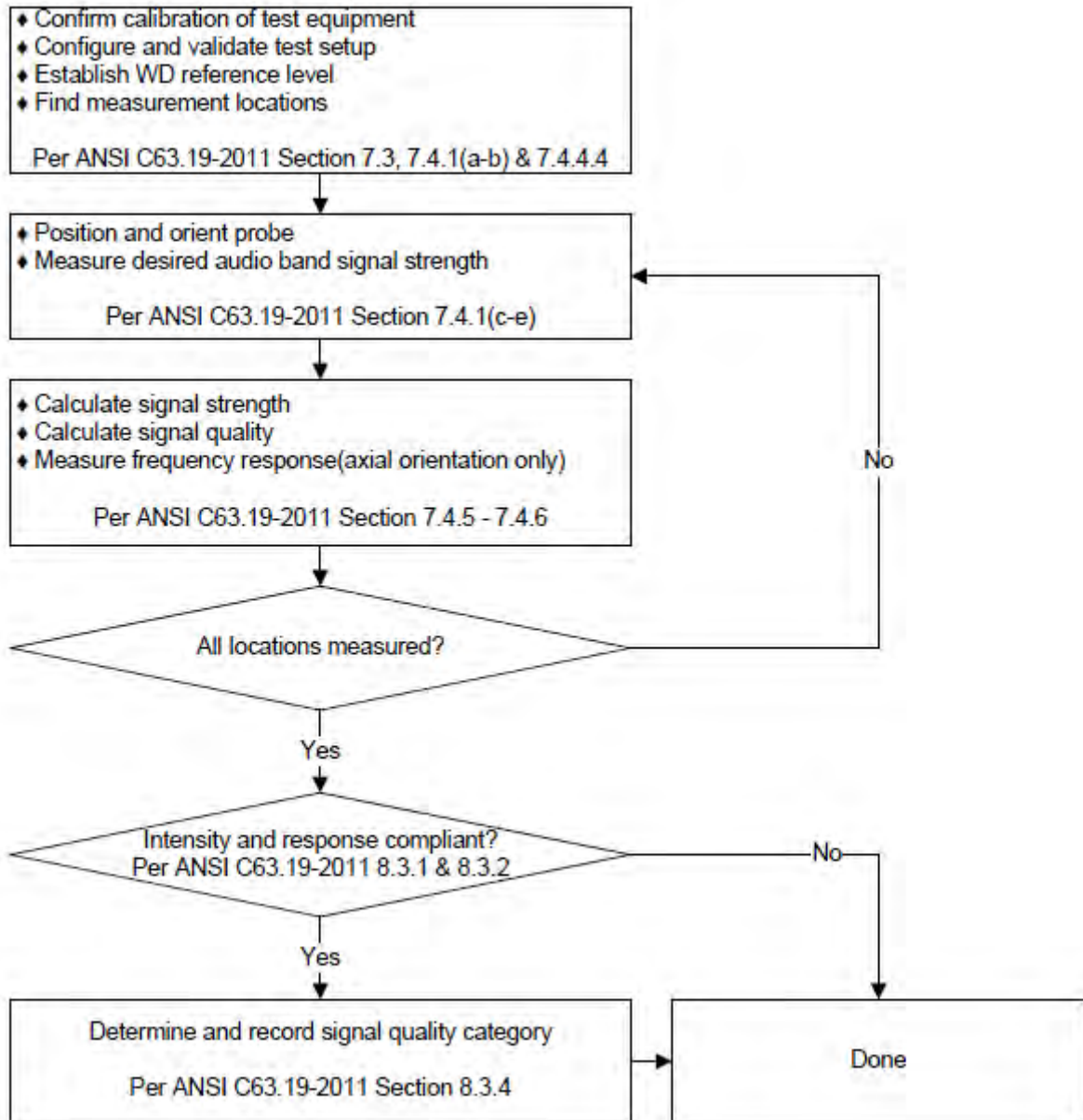

### 4.2 Test Positions

The device was positioned such that Device Reference Plane was touching the bottom of the Test Arch. The acoustic output is aligned with the intersection of the Test Arch's middle bar and dielectric wire. The WD is positioned always this way to ensure repeatability of the measurements. Coordinate system depicted below is used to define exact locations of measurement points relative to the center of the acoustic output.

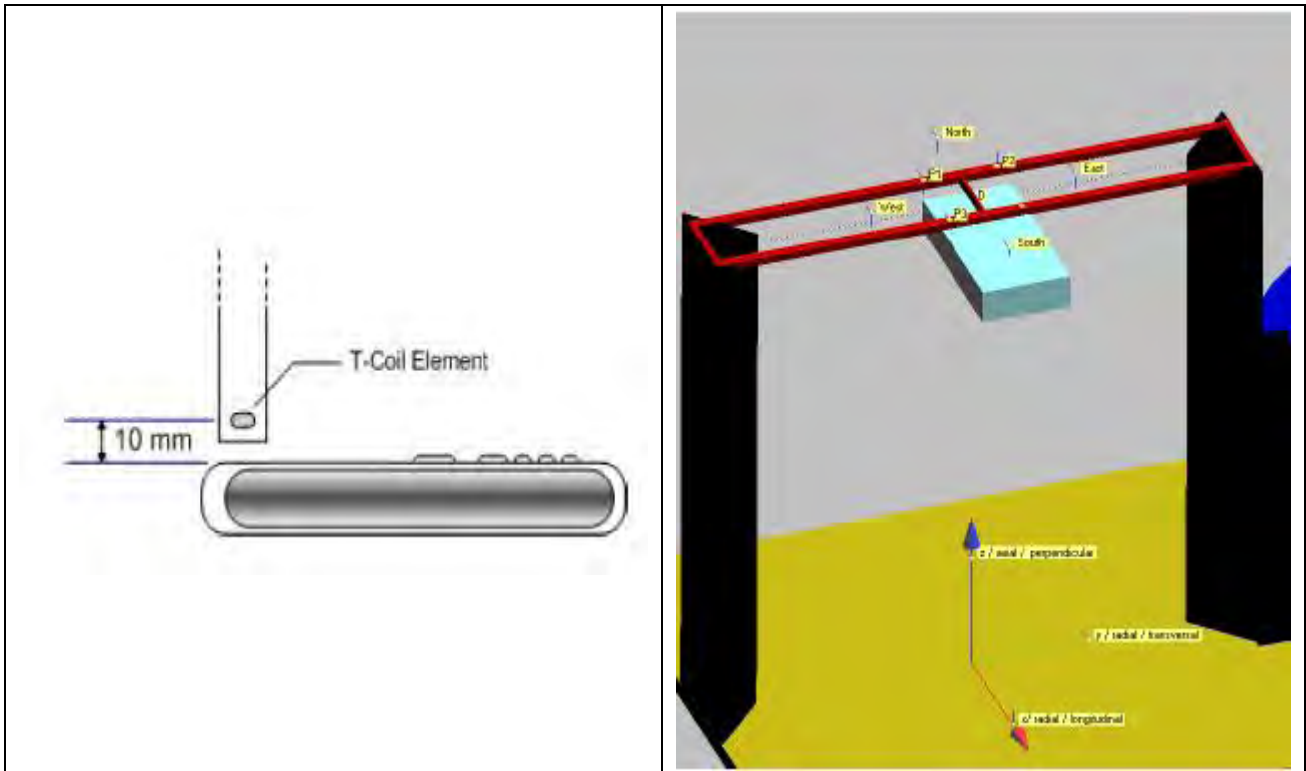

### 4.3 T-Coil Test Procedure Description

The following steps were a typical test scan for the wireless communications device:

1. Geometry and signal check system probe alignment, proper operation of the field probe, probe measurement system, other instrumentation, and the positioning system was confirmed.
2. A surface calibration was performed before each setup change to ensure repeatable spacing and proper maintenance of the measurement plane using the test Arch.
3. The DUT was positioned in its intended test position, acoustic output point of the device perpendicular to the field probe.



4. Determined the optimal measurement locations for the DUT by following the three steps, coarse resolution scan, fine resolution scans, and point measurement, as described in C63.19 per 7.4.4.4. At each measurement locations, samples in the measurement window duration were evaluated to get ABM1 and the signal spectrum. The noise measurement was performed after the scan with the signal, the same happened, just with the voice signal switched off. The ABM2 was calculated from this second scan.
  - (1) Coarse resolution scans (1 KHz signal at 50 x 50 mm grid area with 10 mm spacing). Only ABM1 was measured in order to find the location of T-Coil source.
  - (2) Fine resolution scans (1 KHz signal at 8 x 8 mm grid area with 2 mm spacing). The positioned appropriately based on optimal AMB1 of coarse resolution scan. Both ABM1 and ABM2 were measured in order to find the location of the SNR point.
  - (3) Point measurement (1 KHz signal) for ABM1 and ABM2 in axial, radial transverse and radial longitudinal. The positioned appropriately based on optimal SNR of fine resolution scan. The SNR was calculated for axial, radial transverse and radial longitudinal orientation.
  - (4) Point measurement (300Hz to 3 KHz signal) for frequency response in axial. The positioned appropriately based on optimal SNR of fine resolution axial scan.
5. All results resulting from a measurement point in a T-Coil job were calculated from the signal samples during this window interval. ABM values were averaged over the sequence of these samples.
6. At an optimal point measurement, the SNR(ABM1/ABM2) was calculated for axial, radial transverse and radial longitudinal orientation, and the frequency response was measured in axial axis.
7. Classified the signal quality based on the T-Coil Signal Quality Categories.

## 5. T-Coil Signal Quality Categories

### 5.1 Axial Field Intensity

The minimum limits of ABM1 field intensity shall be  $\geq -18$  dB (A/m) at 1 kHz, in a 1/3 octave band filter for all orientations.

### 5.2 Frequency Response

The frequency response of the axial component must follow the frequency curve specified in ANSI C63.19-2011 section 8.3.2, over the frequency range 300-3000 Hz. The plots of frequency response were shown as below.

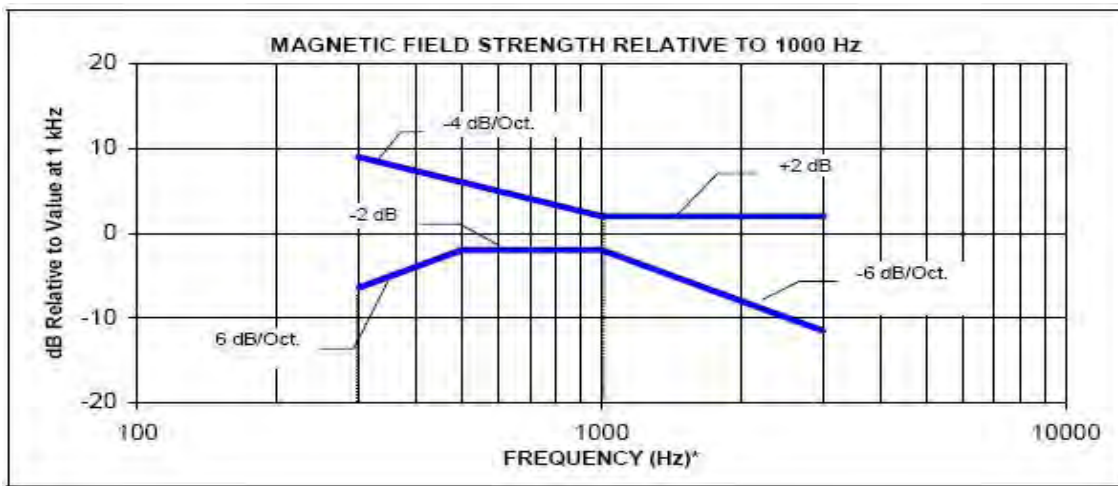

Magnetic field frequency response for WDs with a field  $\leq -15$  dB (A/m) at 1 kHz

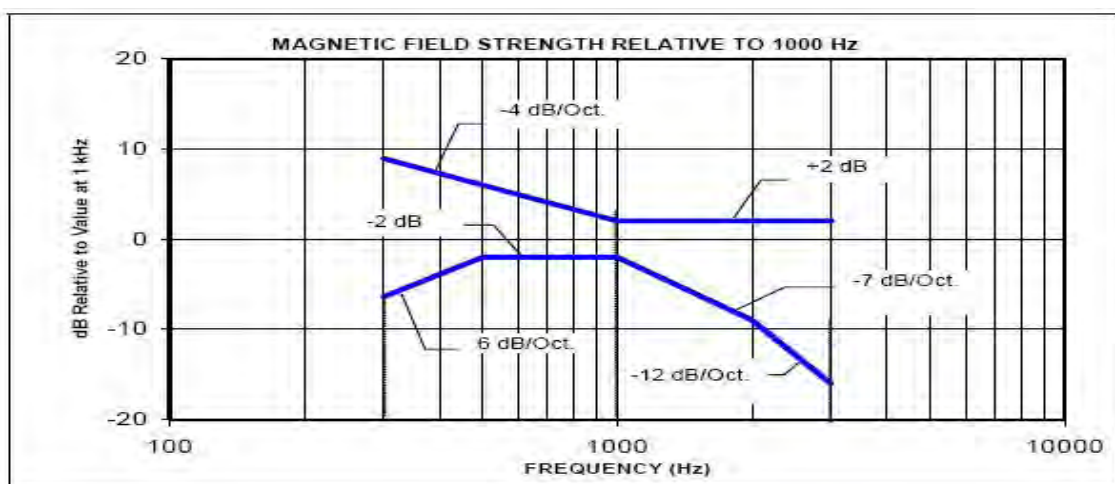

Magnetic field frequency response for WDs with a field that exceeds  $-15$  dB(A/m) at 1 kHz

### 5.3 Signal Quality

The table as below provides the signal quality requirement for the intended T-Coil signal from a Wireless Device. The worst Signal Quality of the axial and radial components of the magnetic field was used to determined the T-Coil category

Category	WD Signal Quality ((Signal + Noise) to Noise ratio in dB)
T1	0 to 10 dB
T2	10 to 20 dB
T3	20 to 30 dB
T4	> 30 dB

## 6. Test Equipment List

Instrument	Manufacturer	Model No.	Serial No.	Last Calibration	Next Calibration
Stäubli Robot TX60L	Stäubli	TX60L	F09/5BL1A1/A06	2009/05/18	only once
Controller	Speag	CS8c	N/A	2009/05/18	only once
Audio Magnetic 1D Field Probe	Speag	AM1DV2	1085	2016/05/19	2017/05/17
Audio Magnetic Calibration Coil	Speag	AMMI	1062	N/A	N/A
Test Arch Phantom	Speag	SD HAC P01 BB	1118	N/A	N/A
Audio Measurement Instrument	Speag	SD HAC P02 AB	1083	N/A	N/A
SAM Twin Phantom	Speag	QD000 P40 CA	Tp 1515	N/A	N/A
Device Holder	Speag	N/A	N/A	N/A	N/A
Data Acquisition Electronic	Speag	DAE4	1207	2015/11/20	2016/11/19
SAR Software	Speag	DASY52	V52.8 (8)	N/A	N/A
Aprél Dipole Spaccer	Aprél	ALS-DS-U	QTK-295	N/A	N/A
Power Amplifier	Mini-Circuit	ZHL-42	D051404-20	N/A	N/A
Directional Coupler	Agilent	778D-012	50550	N/A	N/A
Universal Radio Communication Tester	R&S	CMU200	104846	2015/07/11	2016/07/09
Vector Network	Agilent	E5071C	MY46108013	2015/12/02	2016/11/30
Signal Generator	Anritsu	MG3694A	041902	2015/08/14	2016/08/12
Power Meter	Anritsu	ML2487A	6K00001447	2015/09/17	2016/09/15
Wide Bandwidth Sensor	Anritsu	MA2411B	1339194	2015/09/17	2016/09/15

7. Measurement Uncertainty

Uncertainty of Audio Band Magnetic Measurements							
Error Description	Unc. Value	Prob. Dist.	Div.	( $c_1$ ) ABM1	( $c_1$ ) ABM2	Std. Unc. ABM1	Std. Unc. ABM2
<b>Probe Sensitivity</b>							
Reference Level	±3.0%	N	1	1	1	±3.0%	±3.0%
AMCC Geometry	±0.4%	R	√3	1	1	±0.2%	±0.2%
AMCC Current	±1.0%	R	√3	1	1	±0.6%	±0.6%
Probe Positioning during Calibr.	±0.1%	R	√3	1	1	±0.1%	±0.1%
Noise Contribution	±0.7%	R	√3	0.0143	1	±0.0%	±0.4%
Frequency Slope	±5.9%	R	√3	0.1	1.0	±0.3%	±3.5%
<b>Probe System</b>							
Repeatability / Drift	±1.0%	R	√3	1	1	±0.6%	±0.6%
Linearity / Dynamic Range	±0.6%	R	√3	1	1	±0.4%	±0.4%
Acoustic Noise	±1.0%	R	√3	0.1	1	±0.1%	±0.6%
Probe Angle	±2.3%	R	√3	1	1	±1.4%	±1.4%
Spectral Processing	±0.9%	R	√3	1	1	±0.5%	±0.5%
Integration Time	±0.6%	N	1	1	5	±0.6%	±3.0%
Field Disturbance	±0.2%	R	√3	1	1	±0.1%	±0.1%
<b>Test Signal</b>							
Ref. Signal Spectral Response	±0.6%	R	√3	0	1	±0.0%	±0.4%
<b>Positioning</b>							
Probe Positioning	±1.9%	R	√3	1	1	±1.1%	±1.1%
Phantom Thickness	±0.9%	R	√3	1	1	±0.5%	±0.5%
DUT Positioning	±1.9%	R	√3	1	1	±1.1%	±1.1%
<b>External Contributions</b>							
RF Interference	±0.0%	R	√3	1	0.3	±0.0%	±0.0%
Test Signal Variation	±2.0%	R	√3	1	1	±1.2%	±1.2%
<b>Combined Uncertainty</b>							
Combined Std. Uncertainty (ABM Field)						±4.1%	±6.1%
Expanded Std. Uncertainty						±8.1%	±12.3%

## 8. Test Results

### 8.1 T-Coil Test Results Summary

HAC Measurement									
Product: Smart phone					Ambient Temperature ( °C ) : 22.4				
Test Mode: T-Coil					Humidity (%RH): 53				
Test Band	Test Band	Channel	Location	Conducted Power	Ambient Background Noise (dB A/m)	ABM2 (dB A/m)	ABM1 (dB A/m)	SNR dB	Result
X (longitudinal)	850	128	-9,-3,3.7	31.33	-58.59	-41.73	-2.23	39.5	T4
		190	-9,-4.2,3.7	31.12	-58.59	-43.48	-2.88	40.6	T4
		251	-6,-4.2,3.7	31.02	-58.59	-43.17	-2.86	40.31	T4
	1900	512	-9,-4.2,3.7	28.57	-58.59	-44.92	-4.43	40.49	T4
		661	-12,-3,3.7	28.51	-58.59	-45.86	-2.61	43.25	T4
		810	-10.2,-3,3.7	28.14	-58.59	-45.3	-3	42.3	T4
Y (transversal)	850	128	-3,-12,3.7	31.33	-57.95	-54.99	-2.68	52.31	T4
		190	0,-10.2,3.7	31.12	-57.95	-55.23	-3.39	51.84	T4
		251	-3,-10.2,3.7	31.02	-57.95	-54.9	-3.27	51.63	T4
	1900	512	0,-10.2,3.7	28.57	-57.95	-56.22	-4.18	52.04	T4
		661	0,-9,3.7	28.51	-57.95	-55.12	-2.73	52.39	T4
		810	-1.2,-9,3.7	28.14	-57.95	-55.47	-2.76	52.71	T4
Z (axial)	850	128	-2,-4,3.7	31.33	-57.91	-46.31	4.96	51.27	T4
		190	-2,-4.2,3.7	31.12	-57.91	-46.52	5.29	51.81	T4
		251	-2,-4.2,3.7	31.02	-57.91	-46.96	4.74	51.7	T4
	1900	512	2,-2.2,3.7	28.57	-57.91	-47.43	3.99	51.42	T4
		661	4,-4,3.7	28.51	-57.91	-42.81	5.42	48.23	T4
		810	-2.2,0,3.7	28.14	-57.91	-47.61	5.42	53.03	T4

\* Note : Phone condition : Mute on , Backlight Off, Max volume



HAC Measurement									
Product: Smart phone					Ambient Temperature ( °C ) : 22.4				
Test Mode: T-Coil					Humidity (%RH): 53				
Test Band	Test Band	Channel	Location	Conducted Power	Ambient Background Noise (dB A/m)	ABM2 (dB A/m)	ABM1 (dB A/m)	SNR dB	Result
X (longitudinal)	Band II	9262	-12,0,3.7	21.50	-58.59	-54.67	-2.37	52.3	T4
		9400	6,-4.2,3.7	20.53	-58.59	-56.03	-3.74	52.29	T4
		9538	1.8,-4.2,3.7	20.86	-58.59	-54.98	-2.61	52.37	T4
	Band V	4132	-12,-4.2,3.7	22.49	-58.59	-54.91	-3.45	51.46	T4
		4183	6,-4.2,3.7	22.05	-58.59	-54.71	-2.07	52.64	T4
		4233	6,-3,3.7	21.23	-58.59	-54.97	-2.48	52.49	T4
Y (transversal)	Band II	9262	0,-9,3.7	21.50	-57.95	-55.22	-2.89	52.33	T4
		9400	0,-10.2,3.7	20.53	-57.95	-57.11	-4.23	52.88	T4
		9538	-1.2,-10.2,3.7	20.86	-57.95	-55.39	-2.74	52.65	T4
	Band V	4132	0,-10.2,3.7	22.49	-57.95	-56.28	-3.55	52.73	T4
		4183	0,7.8,3.7	22.05	-57.95	-56.19	-3	53.19	T4
		4233	0,-12,3.7	21.23	-57.95	-55.9	-3.39	52.51	T4
Z (axial)	Band II	9262	-2,0,3.7	21.50	-57.91	-51.47	4.86	56.33	T4
		9400	-4,-0.2,3.7	20.53	-57.91	-51.83	4.46	56.29	T4
		9538	-6.2,-2.2,3.7	20.86	-57.91	-49.27	5.29	54.56	T4
	Band V	4132	-2,-8.2,3.7	22.49	-57.91	-50.93	4.41	55.34	T4
		4183	-2,-4.2,3.7	22.05	-57.91	-49.11	5.96	55.07	T4
		4233	-2,0,3.7	21.23	-57.91	-50.51	4.87	55.38	T4

\* Note : Phone condition : Mute on , Backlight Off, Max volume

**Appendix**

**Appendix A. Probe Calibration in AMCC**

**Appendix B. T-Coil Measurement Data**

**Appendix C. Test Setup Photographs & EUT Photographs**

**Appendix D. Audio Magnetic 1D Field Probe**



## Appendix A. Probe Calibration in AMCC

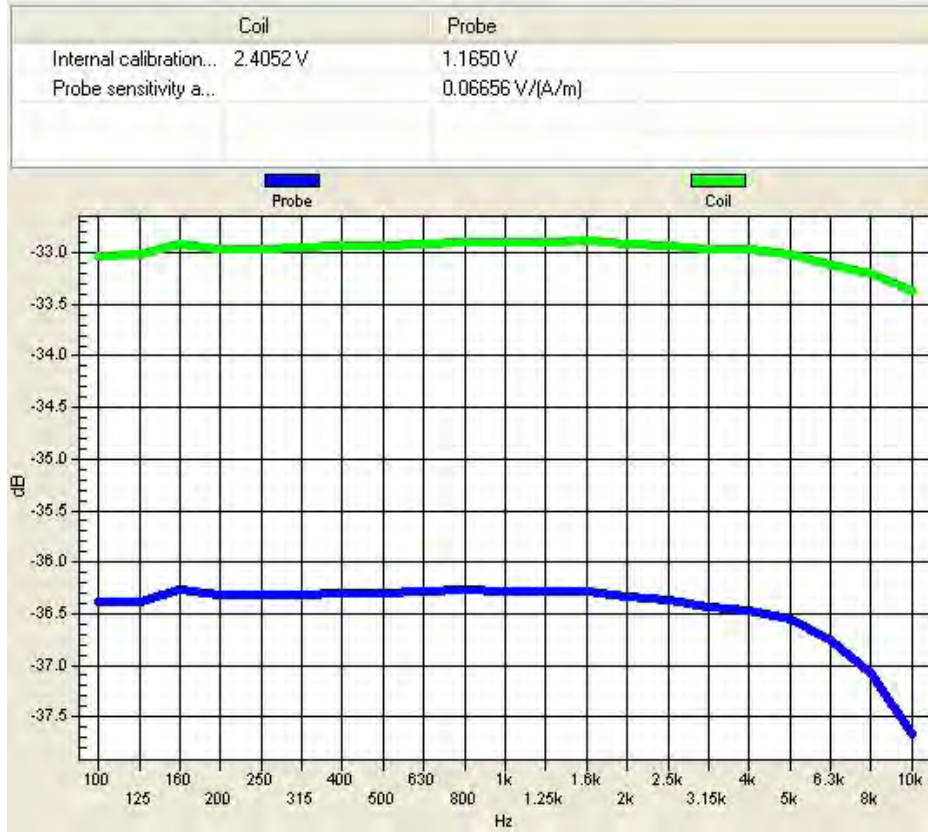

## Appendix B. T-Coil Measurement Data

Test Laboratory: QuieTek-a DEKRA

Date/Time: 2016/06/13

### GSM 850 CH128-X

#### DUT: AC24G; Type: Mobile Phone

Communication System: UID 0, FCC GSM\_850MHz; Frequency: 824.2 MHz;

Communication System PAR: 9.191 dB

Medium parameters used:  $\sigma = 0$  S/m,  $\epsilon_r = 1$ ;  $\rho = 1$  kg/m<sup>3</sup>

Phantom section: TCoil Section

Ambient Temperature (°C) : 22.4, Humidity (%RH) : 53

Measurement Standard: DASYS (IEEE/IEC/ANSI C63.19-2011)

DASY5 Configuration:

- Probe: AM1DV2 - 1085; ; Calibrated: 2016/05/19
- Sensor-Surface: 0mm (Fix Surface)
- Electronics: DAE4 Sn1207; Calibrated: 2015/11/20
- Phantom: HAC Test Arch with AMCC; Type: SD HAC P01 BA;
- Measurement SW: DASYS2, Version 52.8 (8); SEMCAD X Version 14.6.10 (7331)

### Configuration/Scans/x (longitudinal) 4.2mm 50 x 50/ABM Signal(x,y,z)

**(13x13x1)**: Measurement grid: dx=10mm, dy=10mm

Signal Type: Audio File (.wav) 48k\_voice\_1kHz\_1s.wav

Output Gain: 35.93

Measure Window Start: 0ms

Measure Window Length: 1000ms

BWC applied: 0.16 dB

Device Reference Point: 0, 0, -6.3 mm

#### Cursor:

ABM1 comp = -2.62 dBA/m

BWC Factor = 0.16 dB

Location: -8.3, -4.2, 3.7 mm

### Configuration/Scans/x (longitudinal) fine 3mm 42 x 6/ABM Signal(x,y,z)

**(15x3x1)**: Measurement grid: dx=10mm, dy=10mm

Signal Type: Audio File (.wav) 48k\_voice\_1kHz\_1s.wav

Output Gain: 35.93

Measure Window Start: 0ms

Measure Window Length: 1000ms

BWC applied: 0.16 dB

Device Reference Point: 0, 0, -6.3 mm

#### Cursor:

ABM1 comp = -2.23 dBA/m

BWC Factor = 0.16 dB

Location: 6, 0, 3.7 mm

### Configuration/Scans/x (longitudinal) fine 3mm 42 x 6/ABM SNR(x,y,z)

**(15x3x1)**: Measurement grid: dx=10mm, dy=10mm

Signal Type: Audio File (.wav) 48k\_voice\_1kHz\_1s.wav

Output Gain: 35.93

Measure Window Start: 0ms

Measure Window Length: 1000ms

BWC applied: 0.16 dB

Device Reference Point: 0, 0, -6.3 mm

**Cursor:**

ABM1/ABM2 = 39.50 dB  
 ABM1 comp = -3.48 dBA/m  
 BWC Factor = 0.16 dB  
 Location: -9, -3, 3.7 mm

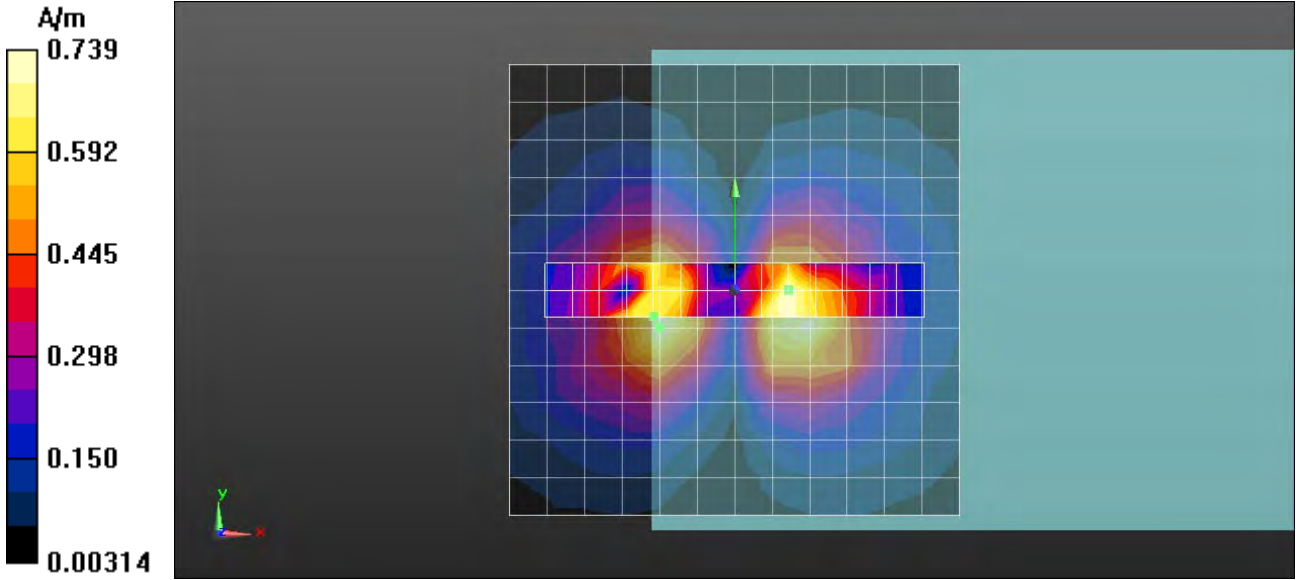

Test Laboratory: QuieTek-a DEKRA

Date/Time: 2016/06/13

**GSM 850 CH128-Y**

**DUT: AC24G; Type: Mobile Phone**

Communication System: UID 0, FCC GSM\_850MHz; Frequency: 824.2 MHz;

Communication System PAR: 9.191 dB

Medium parameters used:  $\sigma = 0$  S/m,  $\epsilon_r = 1$ ;  $\rho = 1$  kg/m<sup>3</sup>

Phantom section: TCoil Section

Ambient Temperature (°C) : 22.4, Humidity (%RH) : 53

Measurement Standard: DASYS (IEEE/IEC/ANSI C63.19-2011)

DASY5 Configuration:

- Probe: AM1DV2 - 1085; ; Calibrated: 2016/05/19
- Sensor-Surface: 0mm (Fix Surface)
- Electronics: DAE4 Sn1207; Calibrated: 2015/11/20
- Phantom: HAC Test Arch with AMCC; Type: SD HAC P01 BA;
- Measurement SW: DASYS2, Version 52.8 (8); SEMCAD X Version 14.6.10 (7331)

**Configuration/Scans/y (transversal) 4.2mm 50 x 50/ABM Signal(x,y,z)**

**(13x13x1):** Measurement grid: dx=10mm, dy=10mm

Signal Type: Audio File (.wav) 48k\_voice\_1kHz\_1s.wav

Output Gain: 35.93

Measure Window Start: 0ms

Measure Window Length: 1000ms

BWC applied: 0.16 dB

Device Reference Point: 0, 0, -6.3 mm

**Cursor:**

ABM1 comp = -3.42 dBA/m

BWC Factor = 0.16 dB

Location: 0, -8.3, 3.7 mm

**Configuration/Scans/y (transversal) fine 3mm 6 x 42/ABM Signal(x,y,z)**

**(3x15x1):** Measurement grid: dx=10mm, dy=10mm

Signal Type: Audio File (.wav) 48k\_voice\_1kHz\_1s.wav

Output Gain: 35.93

Measure Window Start: 0ms

Measure Window Length: 1000ms

BWC applied: 0.16 dB

Device Reference Point: 0, 0, -6.3 mm

**Cursor:**

ABM1 comp = -2.68 dBA/m

BWC Factor = 0.16 dB

Location: 0, 6, 3.7 mm

**Configuration/Scans/y (transversal) fine 3mm 6 x 42/ABM SNR(x,y,z)**

**(3x15x1):** Measurement grid: dx=10mm, dy=10mm

Signal Type: Audio File (.wav) 48k\_voice\_1kHz\_1s.wav

Output Gain: 35.93

Measure Window Start: 0ms

Measure Window Length: 1000ms

BWC applied: 0.16 dB

Device Reference Point: 0, 0, -6.3 mm

**Cursor:**

ABM1/ABM2 = 52.31 dB  
ABM1 comp = -3.46 dBA/m  
BWC Factor = 0.16 dB  
Location: -3, -12, 3.7 mm

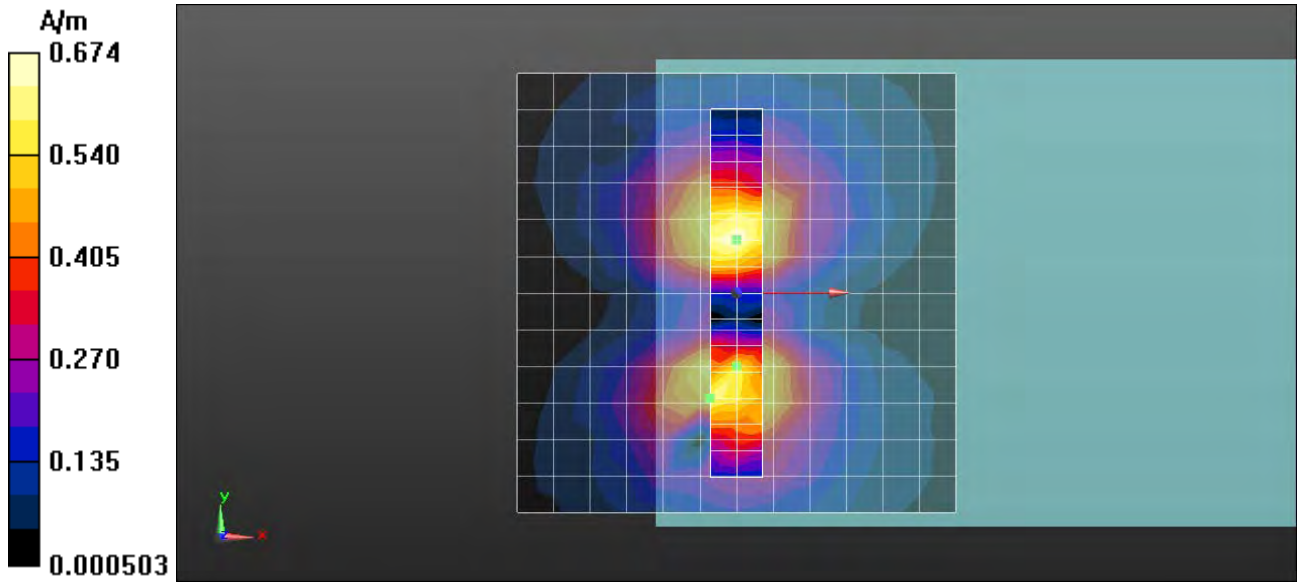

Test Laboratory: QuieTek-a DEKRA

Date/Time: 2016/06/13

**GSM 850 CH128-Z**

**DUT: AC24G; Type: Mobile Phone**

Communication System: UID 0, FCC GSM\_850MHz; Frequency: 824.2 MHz;

Communication System PAR: 9.191 dB

Medium parameters used:  $\sigma = 0$  S/m,  $\epsilon_r = 1$ ;  $\rho = 1$  kg/m<sup>3</sup>

Phantom section: TCoil Section

Ambient Temperature (°C) : 22.4, Humidity (%RH) : 53

Measurement Standard: DASYS (IEEE/IEC/ANSI C63.19-2011)

DASY5 Configuration:

- Probe: AM1DV2 - 1085; ; Calibrated: 2016/05/19
- Sensor-Surface: 0mm (Fix Surface)
- Electronics: DAE4 Sn1207; Calibrated: 2015/11/20
- Phantom: HAC Test Arch with AMCC; Type: SD HAC P01 BA;
- Measurement SW: DASYS2, Version 52.8 (8); SEMCAD X Version 14.6.10 (7331)

**Configuration/Scans/z (axial) 4.2mm 50 x 50/ABM Signal(x,y,z) (13x13x1):**

Measurement grid: dx=10mm, dy=10mm

Signal Type: Audio File (.wav) 48k\_voice\_1kHz\_1s.wav

Output Gain: 35.93

Measure Window Start: 0ms

Measure Window Length: 1000ms

BWC applied: 0.16 dB

Device Reference Point: 0, 0, -6.3 mm

**Cursor:**

ABM1 comp = 4.84 dBA/m

BWC Factor = 0.16 dB

Location: 0, 0, 3.7 mm

**Configuration/Scans/z (axial) fine 2mm 8 x 8/ABM Signal(x,y,z) (5x5x1):**

Measurement grid: dx=10mm, dy=10mm

Signal Type: Audio File (.wav) 48k\_voice\_1kHz\_1s.wav

Output Gain: 35.93

Measure Window Start: 0ms

Measure Window Length: 1000ms

BWC applied: 0.16 dB

Device Reference Point: 0, 0, -6.3 mm

**Cursor:**

ABM1 comp = 4.96 dBA/m

BWC Factor = 0.16 dB

Location: 0, 0, 3.7 mm

**Configuration/Scans/z (axial) fine 2mm 8 x 8/ABM SNR(x,y,z) (5x5x1):**

Measurement grid: dx=10mm, dy=10mm

Signal Type: Audio File (.wav) 48k\_voice\_1kHz\_1s.wav

Output Gain: 35.93

Measure Window Start: 0ms

Measure Window Length: 1000ms

BWC applied: 0.16 dB

Device Reference Point: 0, 0, -6.3 mm

**Cursor:**

ABM1/ABM2 = 51.27 dB  
 ABM1 comp = 4.51 dBA/m  
 BWC Factor = 0.16 dB  
 Location: -2, -4, 3.7 mm

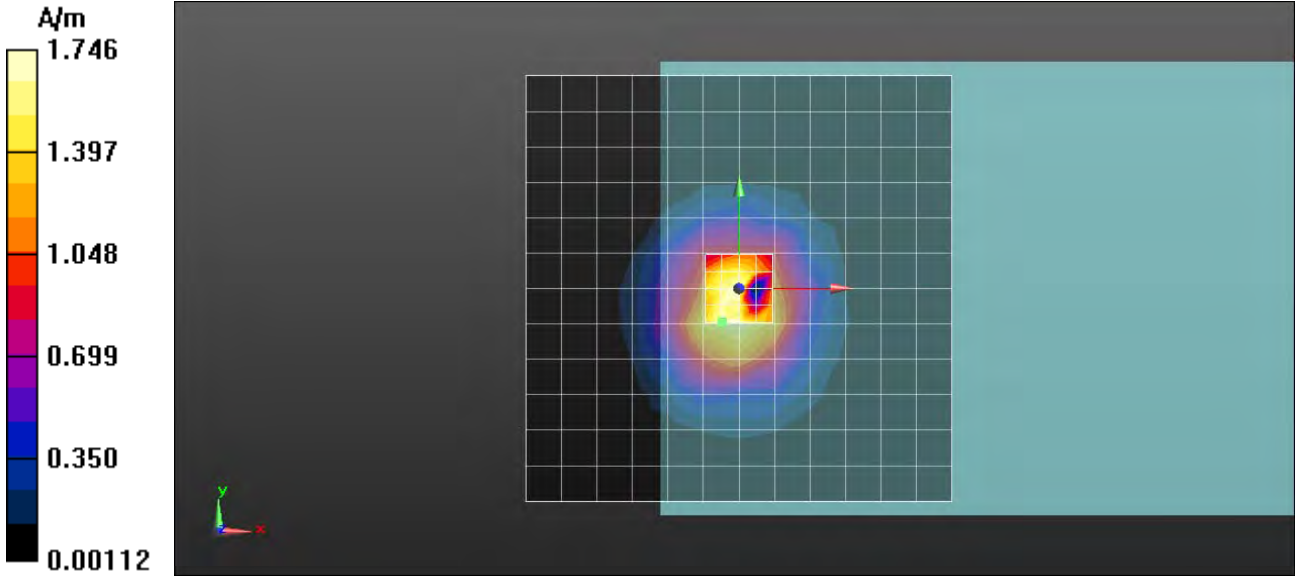



**T-Coil Z Axis plot**  
**Channel: 128**

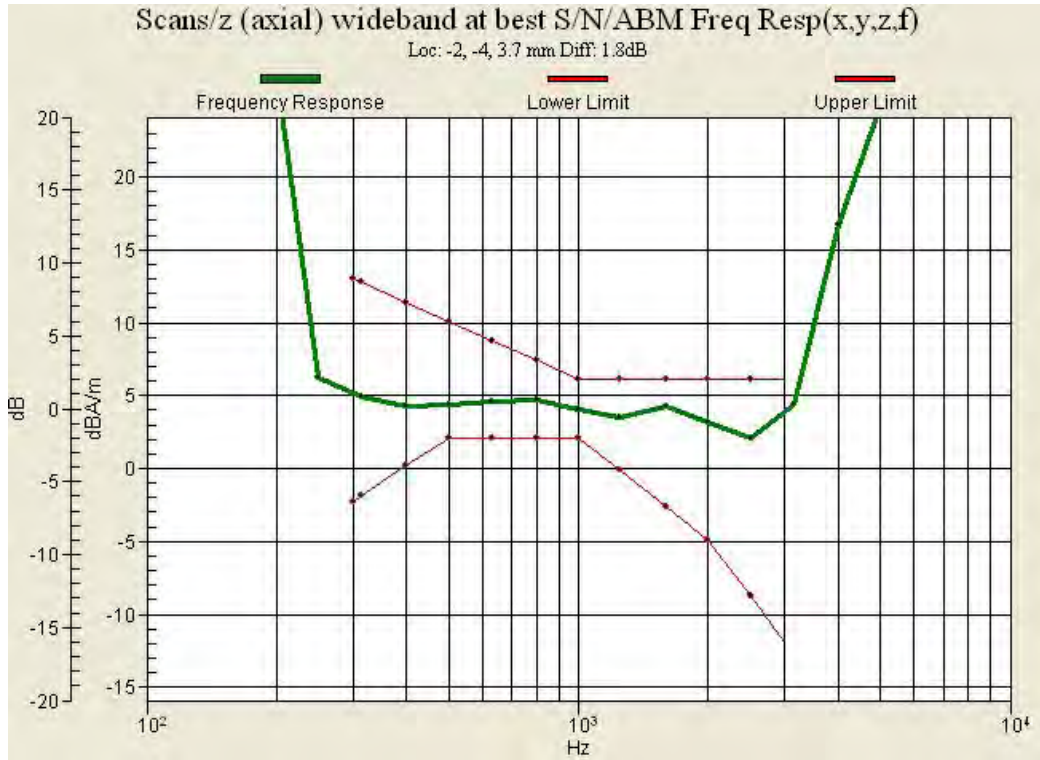



Test Laboratory: QuieTek-a DEKRA

Date/Time: 2016/06/13

**GSM 850 CH190-X**

**DUT: AC24G; Type: Mobile Phone**

Communication System: UID 0, FCC GSM\_850MHz; Frequency: 836.6 MHz;

Communication System PAR: 9.191 dB

Medium parameters used:  $\sigma = 0$  S/m,  $\epsilon_r = 1$ ;  $\rho = 1$  kg/m<sup>3</sup>

Phantom section: TCoil Section

Ambient Temperature (°C) : 22.4, Humidity (%RH) : 53

Measurement Standard: DASYS (IEEE/IEC/ANSI C63.19-2011)

DASY5 Configuration:

- Probe: AM1DV2 - 1085; ; Calibrated: 2016/05/19
- Sensor-Surface: 0mm (Fix Surface)
- Electronics: DAE4 Sn1207; Calibrated: 2015/11/20
- Phantom: HAC Test Arch with AMCC; Type: SD HAC P01 BA;
- Measurement SW: DASYS2, Version 52.8 (8); SEMCAD X Version 14.6.10 (7331)

**Configuration/Scans/x (longitudinal) 4.2mm 50 x 50/ABM Signal(x,y,z)**

**(13x13x1):** Measurement grid: dx=10mm, dy=10mm

Signal Type: Audio File (.wav) 48k\_voice\_1kHz\_1s.wav

Output Gain: 35.93

Measure Window Start: 0ms

Measure Window Length: 1000ms

BWC applied: 0.16 dB

Device Reference Point: 0, 0, -6.3 mm

**Cursor:**

ABM1 comp = -3.19 dBA/m

BWC Factor = 0.16 dB

Location: 4.2, 0, 3.7 mm

**Configuration/Scans/x (longitudinal) fine 3mm 42 x 6/ABM Signal(x,y,z)**

**(15x3x1):** Measurement grid: dx=10mm, dy=10mm

Signal Type: Audio File (.wav) 48k\_voice\_1kHz\_1s.wav

Output Gain: 35.93

Measure Window Start: 0ms

Measure Window Length: 1000ms

BWC applied: 0.16 dB

Device Reference Point: 0, 0, -6.3 mm

**Cursor:**

ABM1 comp = -2.88 dBA/m

BWC Factor = 0.16 dB

Location: 6, -1.2, 3.7 mm

**Configuration/Scans/x (longitudinal) fine 3mm 42 x 6/ABM SNR(x,y,z)**

**(15x3x1):** Measurement grid: dx=10mm, dy=10mm

Signal Type: Audio File (.wav) 48k\_voice\_1kHz\_1s.wav

Output Gain: 35.93

Measure Window Start: 0ms

Measure Window Length: 1000ms

BWC applied: 0.16 dB

Device Reference Point: 0, 0, -6.3 mm

**Cursor:**

ABM1/ABM2 = 40.60 dB  
ABM1 comp = -3.26 dBA/m  
BWC Factor = 0.16 dB  
Location: -9, -4.2, 3.7 mm

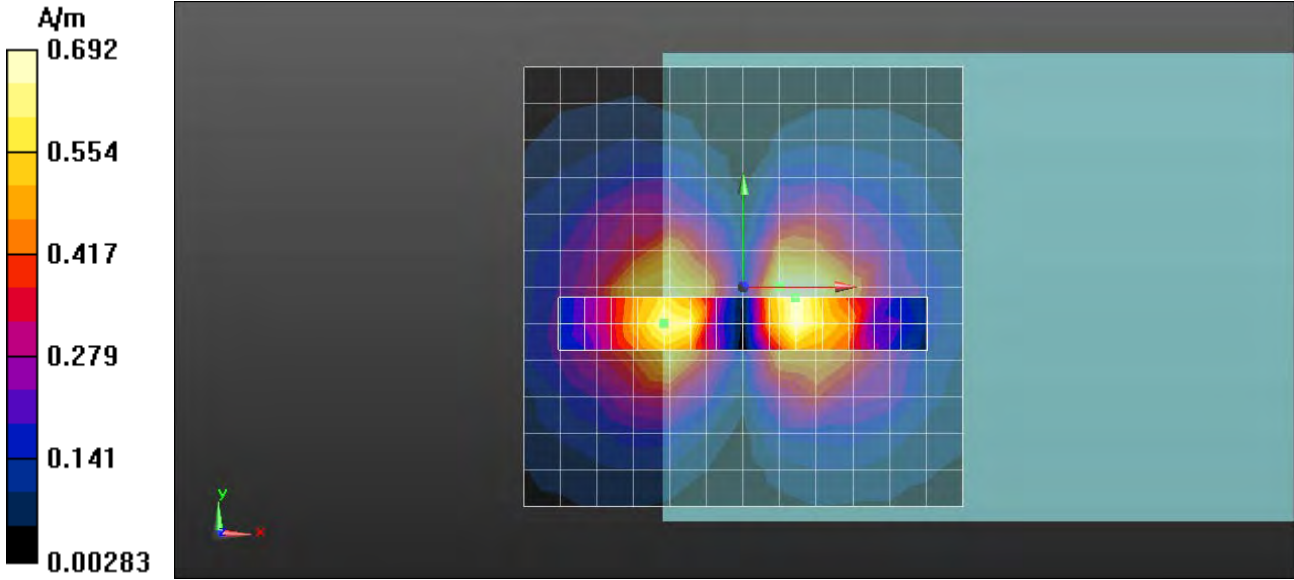

Test Laboratory: QuieTek-a DEKRA

Date/Time: 2016/06/13

**GSM 850 CH190-Y**

**DUT: AC24G; Type: Mobile Phone**

Communication System: UID 0, FCC GSM\_850MHz; Frequency: 836.6 MHz;

Communication System PAR: 9.191 dB

Medium parameters used:  $\sigma = 0$  S/m,  $\epsilon_r = 1$ ;  $\rho = 1$  kg/m<sup>3</sup>

Phantom section: TCoil Section

Ambient Temperature (°C) : 22.4, Humidity (%RH) : 53

Measurement Standard: DASYS (IEEE/IEC/ANSI C63.19-2011)

DASY5 Configuration:

- Probe: AM1DV2 - 1085; ; Calibrated: 2016/05/19
- Sensor-Surface: 0mm (Fix Surface)
- Electronics: DAE4 Sn1207; Calibrated: 2015/11/20
- Phantom: HAC Test Arch with AMCC; Type: SD HAC P01 BA;
- Measurement SW: DASYS2, Version 52.8 (8); SEMCAD X Version 14.6.10 (7331)

**Configuration/Scans/y (transversal) 4.2mm 50 x 50/ABM Signal(x,y,z)**

**(13x13x1):** Measurement grid: dx=10mm, dy=10mm

Signal Type: Audio File (.wav) 48k\_voice\_1kHz\_1s.wav

Output Gain: 35.93

Measure Window Start: 0ms

Measure Window Length: 1000ms

BWC applied: 0.16 dB

Device Reference Point: 0, 0, -6.3 mm

**Cursor:**

ABM1 comp = -2.48 dBA/m

BWC Factor = 0.16 dB

Location: 0, -8.3, 3.7 mm

**Configuration/Scans/y (transversal) fine 3mm 6 x 42/ABM Signal(x,y,z)**

**(3x15x1):** Measurement grid: dx=10mm, dy=10mm

Signal Type: Audio File (.wav) 48k\_voice\_1kHz\_1s.wav

Output Gain: 35.93

Measure Window Start: 0ms

Measure Window Length: 1000ms

BWC applied: 0.16 dB

Device Reference Point: 0, 0, -6.3 mm

**Cursor:**

ABM1 comp = -3.39 dBA/m

BWC Factor = 0.16 dB

Location: 0, 7.8, 3.7 mm

**Configuration/Scans/y (transversal) fine 3mm 6 x 42/ABM SNR(x,y,z)**

**(3x15x1):** Measurement grid: dx=10mm, dy=10mm

Signal Type: Audio File (.wav) 48k\_voice\_1kHz\_1s.wav

Output Gain: 35.93

Measure Window Start: 0ms

Measure Window Length: 1000ms

BWC applied: 0.16 dB

Device Reference Point: 0, 0, -6.3 mm

**Cursor:**

ABM1/ABM2 = 51.84 dB  
 ABM1 comp = -3.60 dBA/m  
 BWC Factor = 0.16 dB  
 Location: 0, -10.2, 3.7 mm

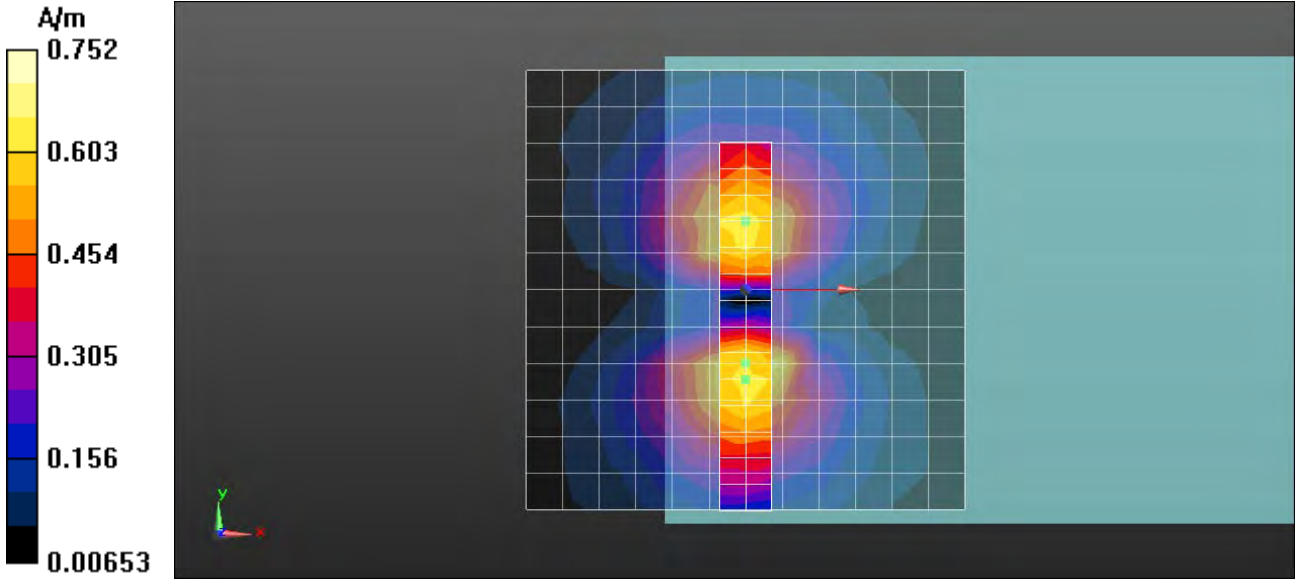

Test Laboratory: QuieTek-a DEKRA

Date/Time: 2016/06/13

**GSM 850 CH190-Z**

**DUT: AC24G; Type: Mobile Phone**

Communication System: UID 0, FCC GSM\_850MHz; Frequency: 836.6 MHz;

Communication System PAR: 9.191 dB

Medium parameters used:  $\sigma = 0$  S/m,  $\epsilon_r = 1$ ;  $\rho = 1$  kg/m<sup>3</sup>

Phantom section: TCoil Section

Ambient Temperature (°C) : 22.4, Humidity (%RH) : 53

Measurement Standard: DASYS (IEEE/IEC/ANSI C63.19-2011)

DASY5 Configuration:

- Probe: AM1DV2 - 1085; ; Calibrated: 2016/05/19
- Sensor-Surface: 0mm (Fix Surface)
- Electronics: DAE4 Sn1207; Calibrated: 2015/11/20
- Phantom: HAC Test Arch with AMCC; Type: SD HAC P01 BA;
- Measurement SW: DASYS2, Version 52.8 (8); SEMCAD X Version 14.6.10 (7331)

**Configuration/Scans/z (axial) 4.2mm 50 x 50/ABM Signal(x,y,z) (13x13x1):**

Measurement grid: dx=10mm, dy=10mm

Signal Type: Audio File (.wav) 48k\_voice\_1kHz\_1s.wav

Output Gain: 35.93

Measure Window Start: 0ms

Measure Window Length: 1000ms

BWC applied: 0.16 dB

Device Reference Point: 0, 0, -6.3 mm

**Cursor:**

ABM1 comp = 5.82 dBA/m

BWC Factor = 0.16 dB

Location: 0, -4.2, 3.7 mm

**Configuration/Scans/z (axial) fine 2mm 8 x 8/ABM Signal(x,y,z) (5x5x1):**

Measurement grid: dx=10mm, dy=10mm

Signal Type: Audio File (.wav) 48k\_voice\_1kHz\_1s.wav

Output Gain: 35.93

Measure Window Start: 0ms

Measure Window Length: 1000ms

BWC applied: 0.16 dB

Device Reference Point: 0, 0, -6.3 mm

**Cursor:**

ABM1 comp = 5.29 dBA/m

BWC Factor = 0.16 dB

Location: -2, -4.2, 3.7 mm

**Configuration/Scans/z (axial) fine 2mm 8 x 8/ABM SNR(x,y,z) (5x5x1):**

Measurement grid: dx=10mm, dy=10mm

Signal Type: Audio File (.wav) 48k\_voice\_1kHz\_1s.wav

Output Gain: 35.93

Measure Window Start: 0ms

Measure Window Length: 1000ms

BWC applied: 0.16 dB

Device Reference Point: 0, 0, -6.3 mm

**Cursor:**

ABM1/ABM2 = 51.81 dB  
 ABM1 comp = 5.29 dBA/m  
 BWC Factor = 0.16 dB  
 Location: -2, -4.2, 3.7 mm

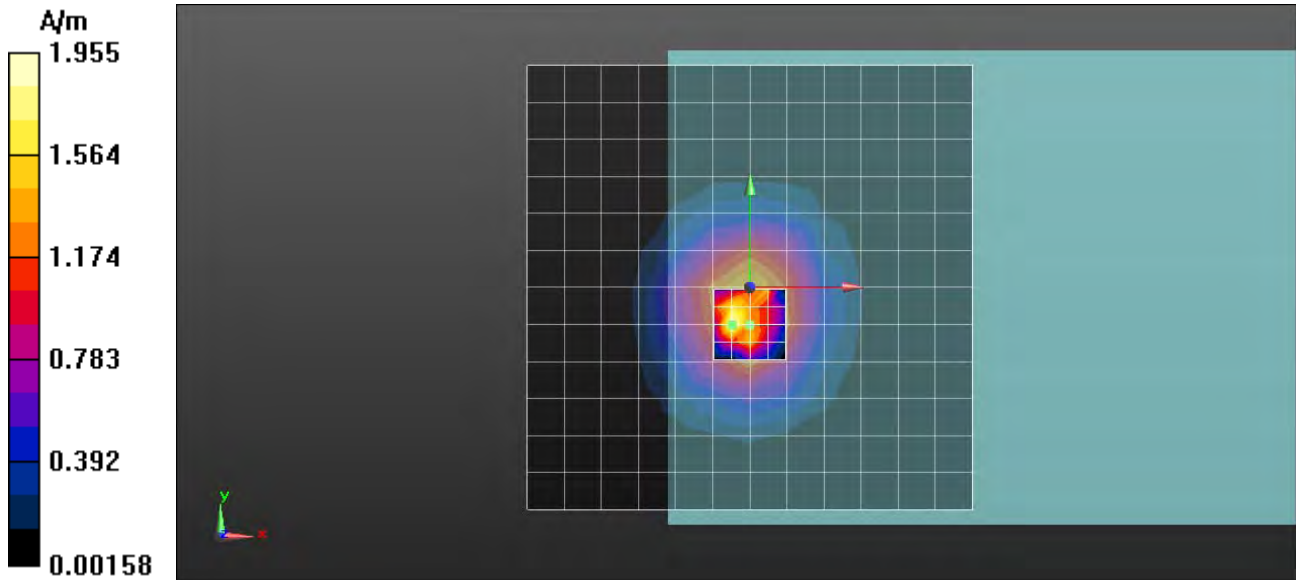

**T-Coil Z Axis plot**  
**Channel: 190**

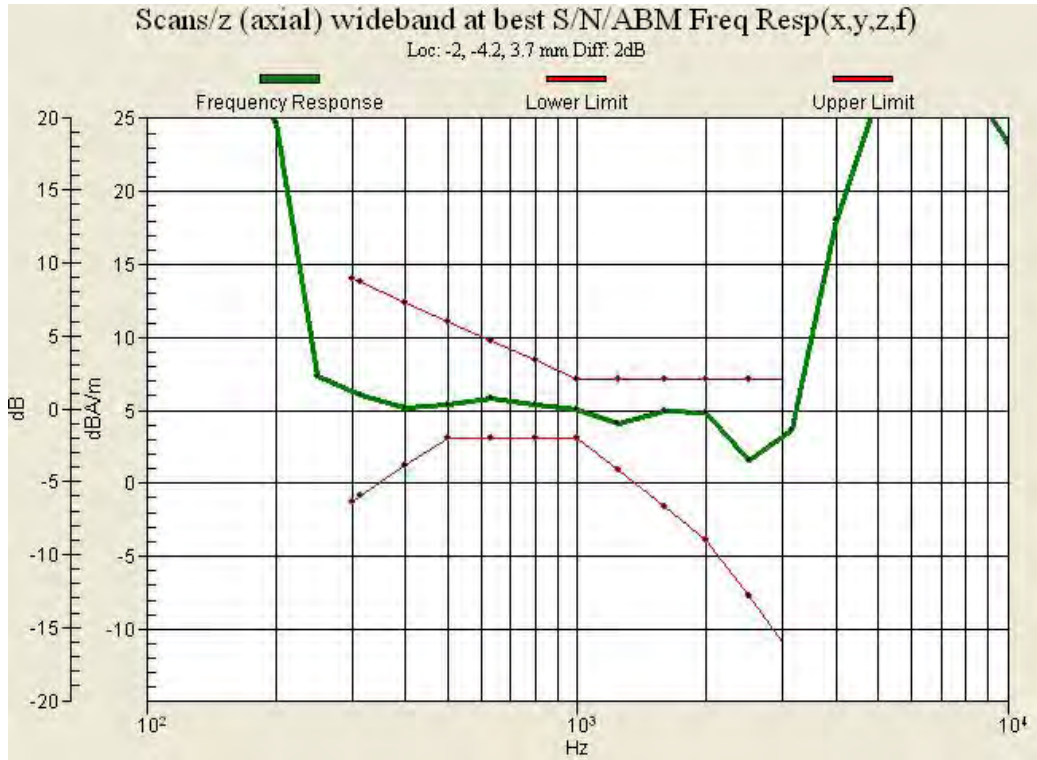



Test Laboratory: QuieTek-a DEKRA

Date/Time: 2016/06/13

**GSM 850 CH251-X**

**DUT: AC24G; Type: Mobile Phone**

Communication System: UID 0, FCC GSM\_850MHz; Frequency: 848.8 MHz;

Communication System PAR: 9.191 dB

Medium parameters used:  $\sigma = 0$  S/m,  $\epsilon_r = 1$ ;  $\rho = 1$  kg/m<sup>3</sup>

Phantom section: TCoil Section

Ambient Temperature (°C) : 22.4, Humidity (%RH) : 53

Measurement Standard: DASYS (IEEE/IEC/ANSI C63.19-2011)

DASY5 Configuration:

- Probe: AM1DV2 - 1085; ; Calibrated: 2016/05/19
- Sensor-Surface: 0mm (Fix Surface)
- Electronics: DAE4 Sn1207; Calibrated: 2015/11/20
- Phantom: HAC Test Arch with AMCC; Type: SD HAC P01 BA;
- Measurement SW: DASYS2, Version 52.8 (8); SEMCAD X Version 14.6.10 (7331)

**Configuration/Scans/x (longitudinal) 4.2mm 50 x 50/ABM Signal(x,y,z)**

**(13x13x1):** Measurement grid: dx=10mm, dy=10mm

Signal Type: Audio File (.wav) 48k\_voice\_1kHz\_1s.wav

Output Gain: 35.93

Measure Window Start: 0ms

Measure Window Length: 1000ms

BWC applied: 0.16 dB

Device Reference Point: 0, 0, -6.3 mm

**Cursor:**

ABM1 comp = -2.97 dBA/m

BWC Factor = 0.16 dB

Location: -8.3, -4.2, 3.7 mm

**Configuration/Scans/x (longitudinal) fine 3mm 42 x 6/ABM Signal(x,y,z)**

**(15x3x1):** Measurement grid: dx=10mm, dy=10mm

Signal Type: Audio File (.wav) 48k\_voice\_1kHz\_1s.wav

Output Gain: 35.93

Measure Window Start: 0ms

Measure Window Length: 1000ms

BWC applied: 0.16 dB

Device Reference Point: 0, 0, -6.3 mm

**Cursor:**

ABM1 comp = -2.86 dBA/m

BWC Factor = 0.16 dB

Location: 6, -1.2, 3.7 mm

**Configuration/Scans/x (longitudinal) fine 3mm 42 x 6/ABM SNR(x,y,z)**

**(15x3x1):** Measurement grid: dx=10mm, dy=10mm

Signal Type: Audio File (.wav) 48k\_voice\_1kHz\_1s.wav

Output Gain: 35.93

Measure Window Start: 0ms

Measure Window Length: 1000ms

BWC applied: 0.16 dB

Device Reference Point: 0, 0, -6.3 mm



**Cursor:**

ABM1/ABM2 = 40.31 dB  
 ABM1 comp = -3.17 dBA/m  
 BWC Factor = 0.16 dB  
 Location: -6, -4.2, 3.7 mm

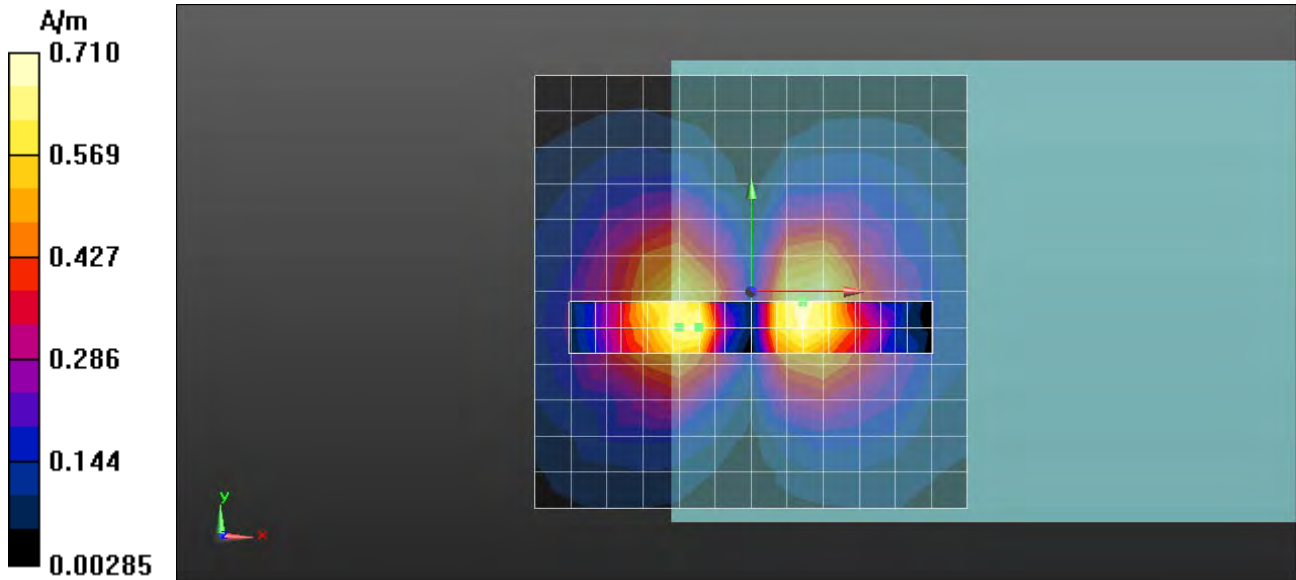

Test Laboratory: QuieTek-a DEKRA

Date/Time: 2016/06/13

**GSM 850 CH251-Y**

**DUT: AC24G; Type: Mobile Phone**

Communication System: UID 0, FCC GSM\_850MHz; Frequency: 848.8 MHz;

Communication System PAR: 9.191 dB

Medium parameters used:  $\sigma = 0$  S/m,  $\epsilon_r = 1$ ;  $\rho = 1$  kg/m<sup>3</sup>

Phantom section: TCoil Section

Ambient Temperature (°C) : 22.4, Humidity (%RH) : 53

Measurement Standard: DASYS (IEEE/IEC/ANSI C63.19-2011)

DASY5 Configuration:

- Probe: AM1DV2 - 1085; ; Calibrated: 2016/05/19
- Sensor-Surface: 0mm (Fix Surface)
- Electronics: DAE4 Sn1207; Calibrated: 2015/11/20
- Phantom: HAC Test Arch with AMCC; Type: SD HAC P01 BA;
- Measurement SW: DASYS2, Version 52.8 (8); SEMCAD X Version 14.6.10 (7331)

**Configuration/Scans/y (transversal) 4.2mm 50 x 50/ABM Signal(x,y,z)**

**(13x13x1):** Measurement grid: dx=10mm, dy=10mm

Signal Type: Audio File (.wav) 48k\_voice\_1kHz\_1s.wav

Output Gain: 35.93

Measure Window Start: 0ms

Measure Window Length: 1000ms

BWC applied: 0.16 dB

Device Reference Point: 0, 0, -6.3 mm

**Cursor:**

ABM1 comp = -3.04 dBA/m

BWC Factor = 0.16 dB

Location: 0, 4.2, 3.7 mm

**Configuration/Scans/y (transversal) fine 3mm 6 x 42/ABM Signal(x,y,z)**

**(3x15x1):** Measurement grid: dx=10mm, dy=10mm

Signal Type: Audio File (.wav) 48k\_voice\_1kHz\_1s.wav

Output Gain: 35.93

Measure Window Start: 0ms

Measure Window Length: 1000ms

BWC applied: 0.16 dB

Device Reference Point: 0, 0, -6.3 mm

**Cursor:**

ABM1 comp = -3.27 dBA/m

BWC Factor = 0.16 dB

Location: 0, 4.8, 3.7 mm

**Configuration/Scans/y (transversal) fine 3mm 6 x 42/ABM SNR(x,y,z)**

**(3x15x1):** Measurement grid: dx=10mm, dy=10mm

Signal Type: Audio File (.wav) 48k\_voice\_1kHz\_1s.wav

Output Gain: 35.93

Measure Window Start: 0ms

Measure Window Length: 1000ms

BWC applied: 0.16 dB

Device Reference Point: 0, 0, -6.3 mm

**Cursor:**

ABM1/ABM2 = 51.63 dB  
 ABM1 comp = -4.10 dBA/m  
 BWC Factor = 0.16 dB  
 Location: -3, -10.2, 3.7 mm

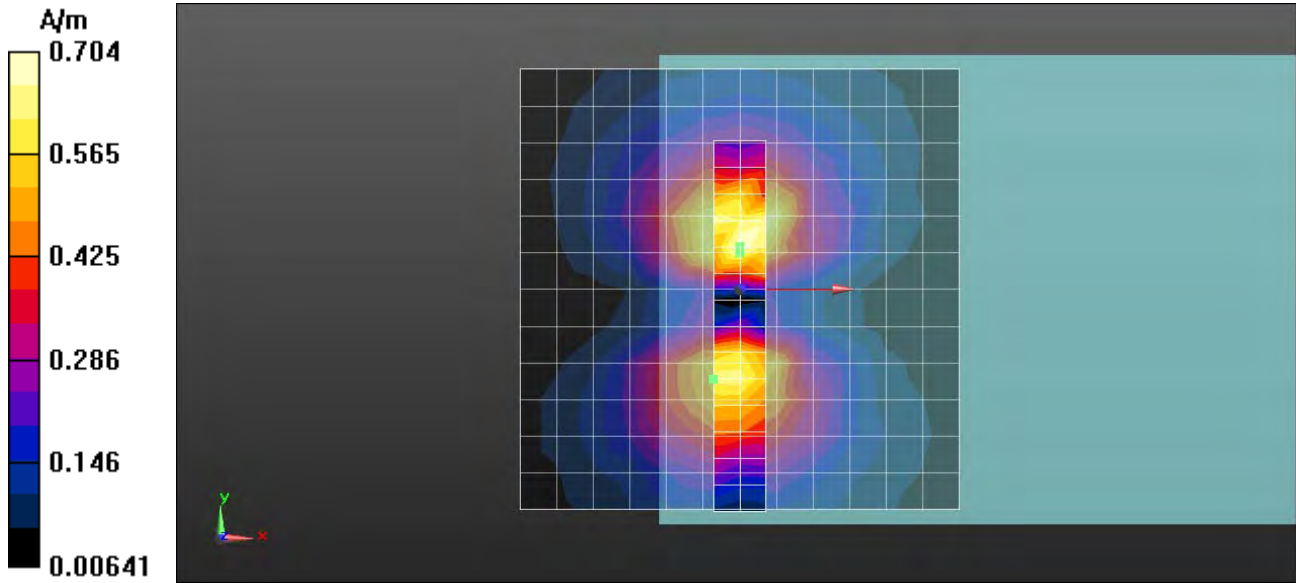

Test Laboratory: QuieTek-a DEKRA

Date/Time: 2016/06/13

**GSM 850 CH251-Z**

**DUT: AC24G; Type: Mobile Phone**

Communication System: UID 0, FCC GSM\_850MHz; Frequency: 848.8 MHz;

Communication System PAR: 9.191 dB

Medium parameters used:  $\sigma = 0$  S/m,  $\epsilon_r = 1$ ;  $\rho = 1$  kg/m<sup>3</sup>

Phantom section: TCoil Section

Ambient Temperature (°C) : 22.4, Humidity (%RH) : 53

Measurement Standard: DASYS (IEEE/IEC/ANSI C63.19-2011)

DASY5 Configuration:

- Probe: AM1DV2 - 1085; ; Calibrated: 2016/05/19
- Sensor-Surface: 0mm (Fix Surface)
- Electronics: DAE4 Sn1207; Calibrated: 2015/11/20
- Phantom: HAC Test Arch with AMCC; Type: SD HAC P01 BA;
- Measurement SW: DASYS2, Version 52.8 (8); SEMCAD X Version 14.6.10 (7331)

**Configuration/Scans/z (axial) 4.2mm 50 x 50/ABM Signal(x,y,z) (13x13x1):**

Measurement grid: dx=10mm, dy=10mm

Signal Type: Audio File (.wav) 48k\_voice\_1kHz\_1s.wav

Output Gain: 35.93

Measure Window Start: 0ms

Measure Window Length: 1000ms

BWC applied: 0.16 dB

Device Reference Point: 0, 0, -6.3 mm

**Cursor:**

ABM1 comp = 3.42 dBA/m

BWC Factor = 0.16 dB

Location: 0, -4.2, 3.7 mm

**Configuration/Scans/z (axial) fine 2mm 8 x 8/ABM Signal(x,y,z) (5x5x1):**

Measurement grid: dx=10mm, dy=10mm

Signal Type: Audio File (.wav) 48k\_voice\_1kHz\_1s.wav

Output Gain: 35.93

Measure Window Start: 0ms

Measure Window Length: 1000ms

BWC applied: 0.16 dB

Device Reference Point: 0, 0, -6.3 mm

**Cursor:**

ABM1 comp = 4.74 dBA/m

BWC Factor = 0.16 dB

Location: 0, -2.2, 3.7 mm

**Configuration/Scans/z (axial) fine 2mm 8 x 8/ABM SNR(x,y,z) (5x5x1):**

Measurement grid: dx=10mm, dy=10mm

Signal Type: Audio File (.wav) 48k\_voice\_1kHz\_1s.wav

Output Gain: 35.93

Measure Window Start: 0ms

Measure Window Length: 1000ms

BWC applied: 0.16 dB

Device Reference Point: 0, 0, -6.3 mm

**Cursor:**

ABM1/ABM2 = 51.70 dB  
 ABM1 comp = 4.51 dBA/m  
 BWC Factor = 0.16 dB  
 Location: -2, -4.2, 3.7 mm

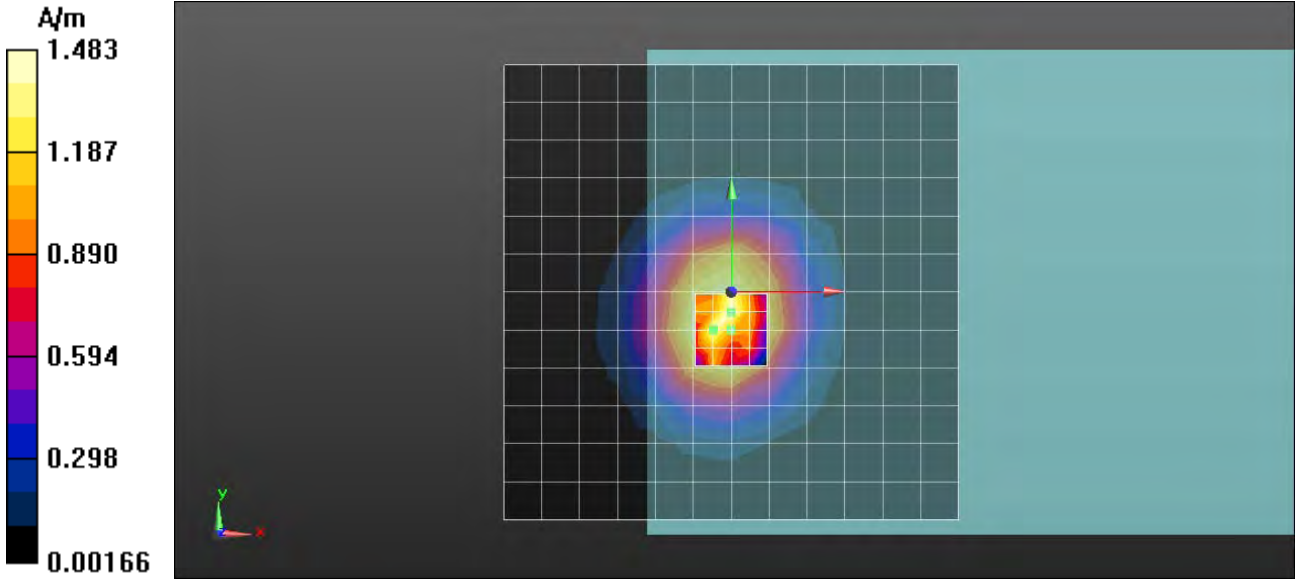

**T-Coil Z Axis plot**  
**Channel: 251**

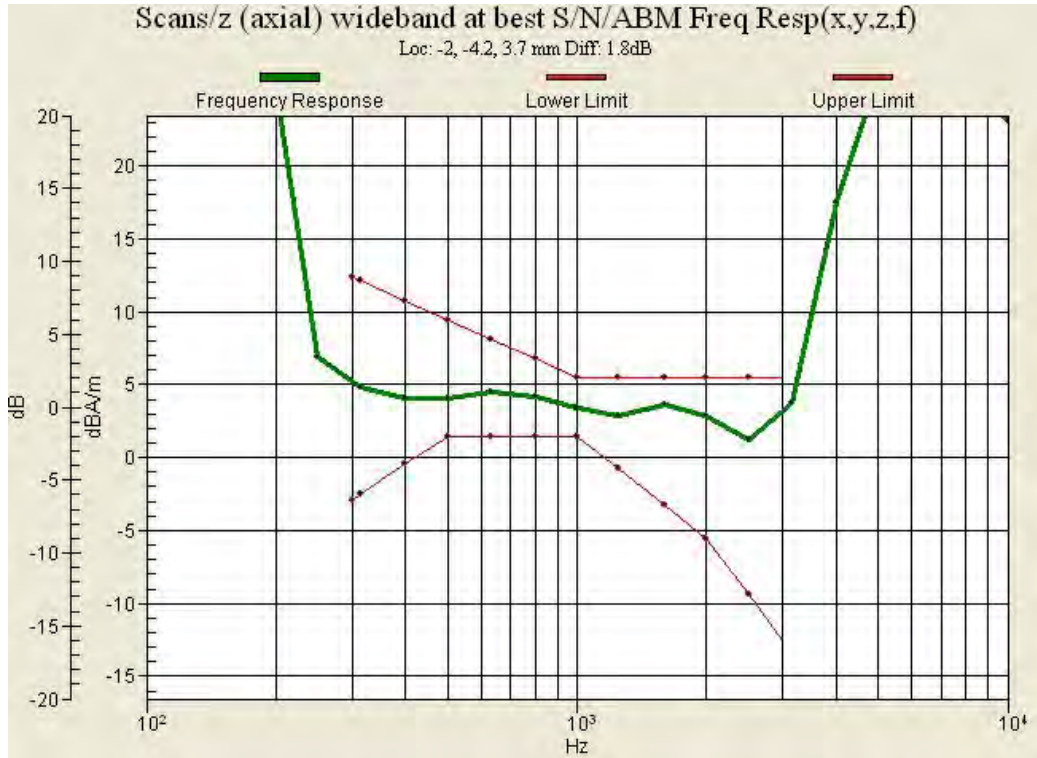

Test Laboratory: QuieTek-a DEKRA

Date/Time: 2016/06/13

**PCS 1900 CH512-X**

**DUT: AC24G; Type: Mobile Phone**

Communication System: UID 0, FCC PCS\_1900MHz; Frequency: 1850.2 MHz;

Communication System PAR: 9.191 dB

Medium parameters used:  $\sigma = 0$  S/m,  $\epsilon_r = 1$ ;  $\rho = 1$  kg/m<sup>3</sup>

Phantom section: TCoil Section

Ambient Temperature (°C) : 22.4, Humidity (%RH) : 53

Measurement Standard: DASYS (IEEE/IEC/ANSI C63.19-2011)

DASY5 Configuration:

- Probe: AM1DV2 - 1085; ; Calibrated: 2016/05/19
- Sensor-Surface: 0mm (Fix Surface)
- Electronics: DAE4 Sn1207; Calibrated: 2015/11/20
- Phantom: HAC Test Arch with AMCC; Type: SD HAC P01 BA;
- Measurement SW: DASYS2, Version 52.8 (8); SEMCAD X Version 14.6.10 (7331)

**Configuration/Scans/x (longitudinal) 4.2mm 50 x 50/ABM Signal(x,y,z)**

**(13x13x1):** Measurement grid: dx=10mm, dy=10mm

Signal Type: Audio File (.wav) 48k\_voice\_1kHz\_1s.wav

Output Gain: 35.93

Measure Window Start: 0ms

Measure Window Length: 1000ms

BWC applied: 0.16 dB

Device Reference Point: 0, 0, -6.3 mm

**Cursor:**

ABM1 comp = -4.19 dBA/m

BWC Factor = 0.16 dB

Location: -8.3, -4.2, 3.7 mm

**Configuration/Scans/x (longitudinal) fine 3mm 42 x 6/ABM Signal(x,y,z)**

**(15x3x1):** Measurement grid: dx=10mm, dy=10mm

Signal Type: Audio File (.wav) 48k\_voice\_1kHz\_1s.wav

Output Gain: 35.93

Measure Window Start: 0ms

Measure Window Length: 1000ms

BWC applied: 0.16 dB

Device Reference Point: 0, 0, -6.3 mm

**Cursor:**

ABM1 comp = -4.43 dBA/m

BWC Factor = 0.16 dB

Location: -9, -4.2, 3.7 mm

**Configuration/Scans/x (longitudinal) fine 3mm 42 x 6/ABM SNR(x,y,z)**

**(15x3x1):** Measurement grid: dx=10mm, dy=10mm

Signal Type: Audio File (.wav) 48k\_voice\_1kHz\_1s.wav

Output Gain: 35.93

Measure Window Start: 0ms

Measure Window Length: 1000ms

BWC applied: 0.16 dB

Device Reference Point: 0, 0, -6.3 mm



**Cursor:**

ABM1/ABM2 = 40.49 dB  
 ABM1 comp = -4.43 dBA/m  
 BWC Factor = 0.16 dB  
 Location: -9, -4.2, 3.7 mm

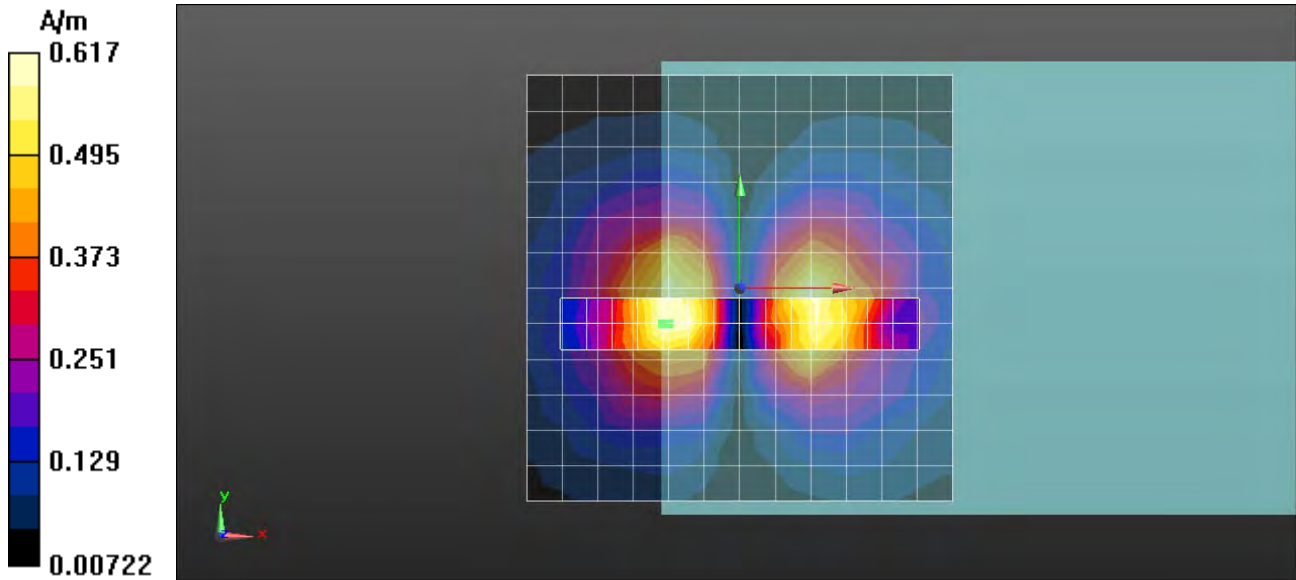

Test Laboratory: QuieTek-a DEKRA

Date/Time: 2016/06/13

**PCS 1900 CH512-Y**

**DUT: AC24G; Type: Mobile Phone**

Communication System: UID 0, FCC PCS\_1900MHz; Frequency: 1850.2 MHz;

Communication System PAR: 9.191 dB

Medium parameters used:  $\sigma = 0$  S/m,  $\epsilon_r = 1$ ;  $\rho = 1$  kg/m<sup>3</sup>

Phantom section: TCoil Section

Ambient Temperature (°C) : 22.4, Humidity (%RH) : 53

Measurement Standard: DASYS (IEEE/IEC/ANSI C63.19-2011)

DASY5 Configuration:

- Probe: AM1DV2 - 1085; ; Calibrated: 2016/05/19
- Sensor-Surface: 0mm (Fix Surface)
- Electronics: DAE4 Sn1207; Calibrated: 2015/11/20
- Phantom: HAC Test Arch with AMCC; Type: SD HAC P01 BA;
- Measurement SW: DASYS2, Version 52.8 (8); SEMCAD X Version 14.6.10 (7331)

**Configuration/Scans/y (transversal) 4.2mm 50 x 50/ABM Signal(x,y,z)**

**(13x13x1):** Measurement grid: dx=10mm, dy=10mm

Signal Type: Audio File (.wav) 48k\_voice\_1kHz\_1s.wav

Output Gain: 35.93

Measure Window Start: 0ms

Measure Window Length: 1000ms

BWC applied: 0.16 dB

Device Reference Point: 0, 0, -6.3 mm

**Cursor:**

ABM1 comp = -4.44 dBA/m

BWC Factor = 0.16 dB

Location: 0, -12.5, 3.7 mm

**Configuration/Scans/y (transversal) fine 3mm 6 x 42/ABM Signal(x,y,z)**

**(3x15x1):** Measurement grid: dx=10mm, dy=10mm

Signal Type: Audio File (.wav) 48k\_voice\_1kHz\_1s.wav

Output Gain: 35.93

Measure Window Start: 0ms

Measure Window Length: 1000ms

BWC applied: 0.16 dB

Device Reference Point: 0, 0, -6.3 mm

**Cursor:**

ABM1 comp = -4.18 dBA/m

BWC Factor = 0.16 dB

Location: 3, 4.8, 3.7 mm

**Configuration/Scans/y (transversal) fine 3mm 6 x 42/ABM SNR(x,y,z)**

**(3x15x1):** Measurement grid: dx=10mm, dy=10mm

Signal Type: Audio File (.wav) 48k\_voice\_1kHz\_1s.wav

Output Gain: 35.93

Measure Window Start: 0ms

Measure Window Length: 1000ms

BWC applied: 0.16 dB

Device Reference Point: 0, 0, -6.3 mm

**Cursor:**

ABM1/ABM2 = 52.04 dB  
 ABM1 comp = -4.33 dBA/m  
 BWC Factor = 0.16 dB  
 Location: 0, -10.2, 3.7 mm

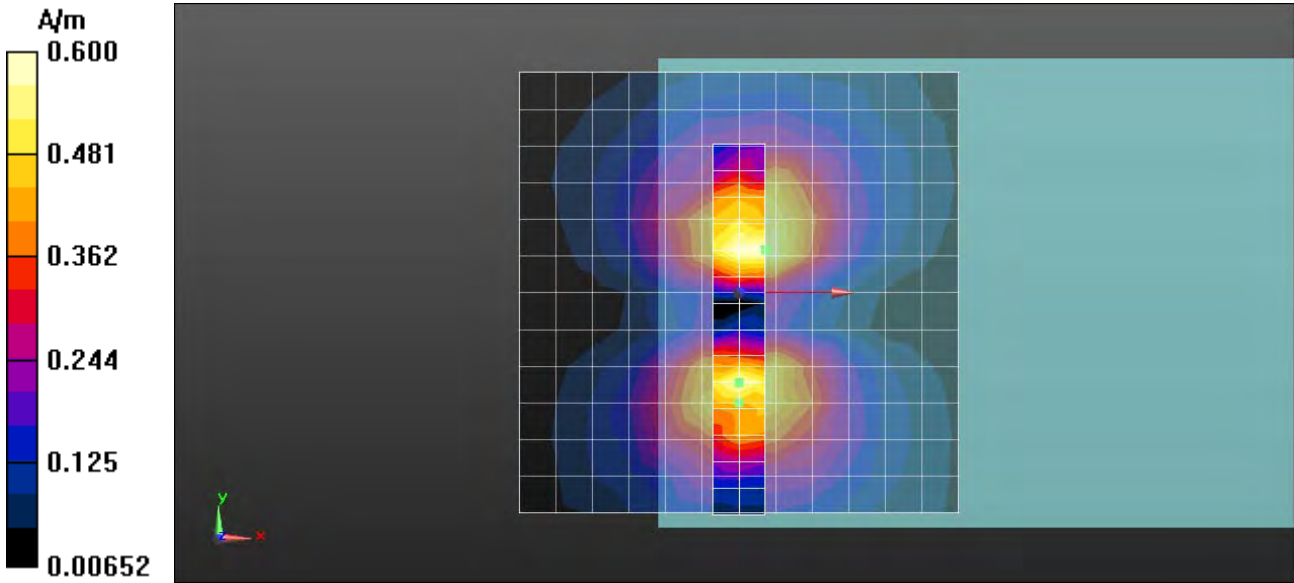

Test Laboratory: QuieTek-a DEKRA

Date/Time: 2016/06/13

**PCS 1900 CH512-Z**

**DUT: AC24G; Type: Mobile Phone**

Communication System: UID 0, FCC PCS\_1900MHz; Frequency: 1850.2 MHz;

Communication System PAR: 9.191 dB

Medium parameters used:  $\sigma = 0$  S/m,  $\epsilon_r = 1$ ;  $\rho = 1$  kg/m<sup>3</sup>

Phantom section: TCoil Section

Ambient Temperature (°C) : 22.4, Humidity (%RH) : 53

Measurement Standard: DASYS (IEEE/IEC/ANSI C63.19-2011)

DASY5 Configuration:

- Probe: AM1DV2 - 1085; ; Calibrated: 2016/05/19
- Sensor-Surface: 0mm (Fix Surface)
- Electronics: DAE4 Sn1207; Calibrated: 2015/11/20
- Phantom: HAC Test Arch with AMCC; Type: SD HAC P01 BA;
- Measurement SW: DASYS2, Version 52.8 (8); SEMCAD X Version 14.6.10 (7331)

**Configuration/Scans/z (axial) 4.2mm 50 x 50/ABM Signal(x,y,z) (13x13x1):**

Measurement grid: dx=10mm, dy=10mm

Signal Type: Audio File (.wav) 48k\_voice\_1kHz\_1s.wav

Output Gain: 35.93

Measure Window Start: 0ms

Measure Window Length: 1000ms

BWC applied: 0.16 dB

Device Reference Point: 0, 0, -6.3 mm

**Cursor:**

ABM1 comp = 3.57 dBA/m

BWC Factor = 0.16 dB

Location: 0, -4.2, 3.7 mm

**Configuration/Scans/z (axial) fine 2mm 8 x 8/ABM Signal(x,y,z) (5x5x1):**

Measurement grid: dx=10mm, dy=10mm

Signal Type: Audio File (.wav) 48k\_voice\_1kHz\_1s.wav

Output Gain: 35.93

Measure Window Start: 0ms

Measure Window Length: 1000ms

BWC applied: 0.16 dB

Device Reference Point: 0, 0, -6.3 mm

**Cursor:**

ABM1 comp = 3.99 dBA/m

BWC Factor = 0.16 dB

Location: 2, -2.2, 3.7 mm

**Configuration/Scans/z (axial) fine 2mm 8 x 8/ABM SNR(x,y,z) (5x5x1):**

Measurement grid: dx=10mm, dy=10mm

Signal Type: Audio File (.wav) 48k\_voice\_1kHz\_1s.wav

Output Gain: 35.93

Measure Window Start: 0ms

Measure Window Length: 1000ms

BWC applied: 0.16 dB

Device Reference Point: 0, 0, -6.3 mm

**Cursor:**

ABM1/ABM2 = 51.42 dB  
 ABM1 comp = 3.99 dBA/m  
 BWC Factor = 0.16 dB  
 Location: 2, -2.2, 3.7 mm

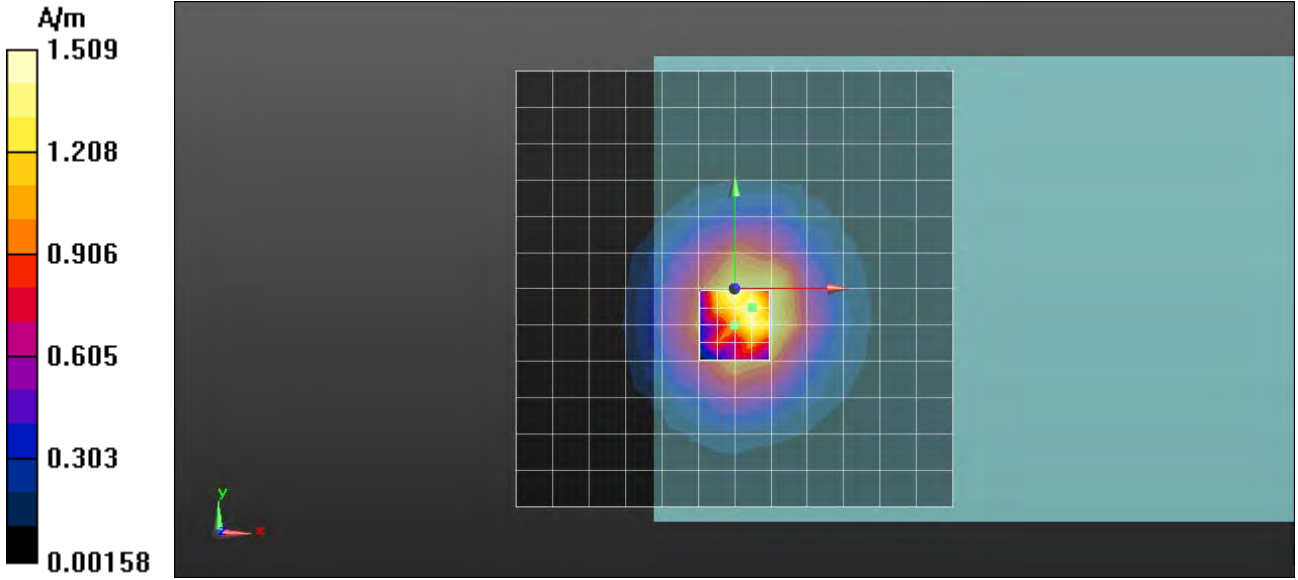

**T-Coil Z Axis plot**  
**Channel: 512**

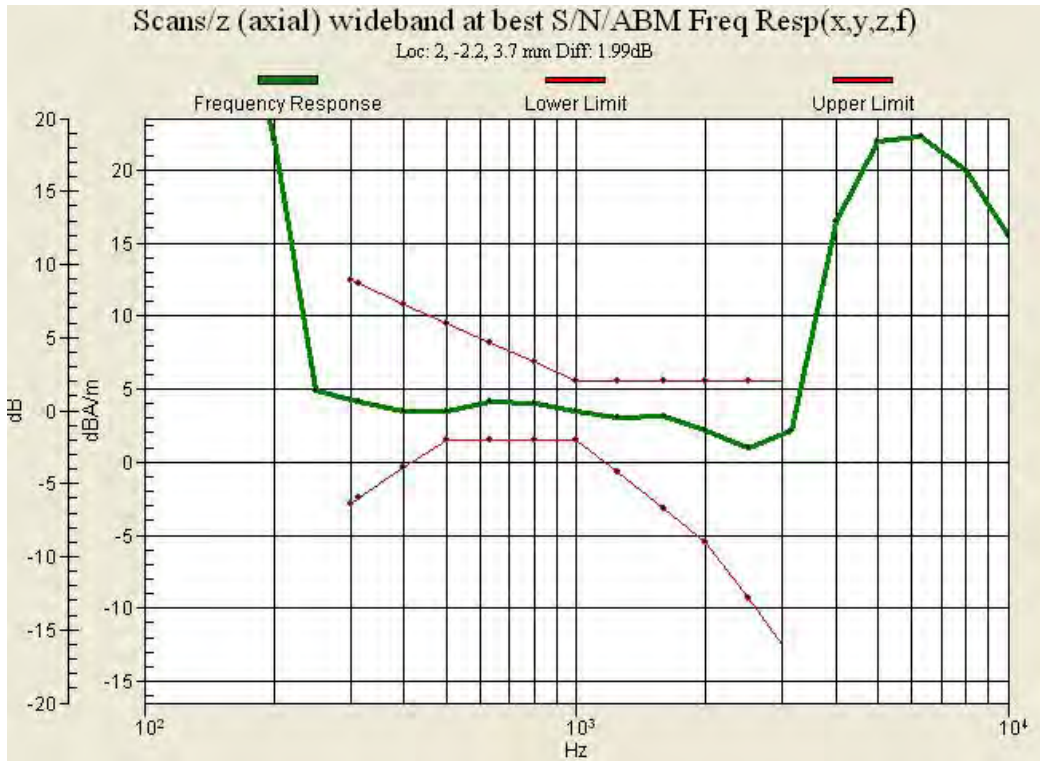

Test Laboratory: QuieTek-a DEKRA

Date/Time: 2016/06/13

**PCS 1900 CH661-X**

**DUT: AC24G; Type: Mobile Phone**

Communication System: UID 0, FCC PCS\_1900MHz; Frequency: 1880 MHz;

Communication System PAR: 9.191 dB

Medium parameters used:  $\sigma = 0$  S/m,  $\epsilon_r = 1$ ;  $\rho = 1$  kg/m<sup>3</sup>

Phantom section: TCoil Section

Ambient Temperature (°C) : 22.4, Humidity (%RH) : 53

Measurement Standard: DASYS (IEEE/IEC/ANSI C63.19-2011)

DASY5 Configuration:

- Probe: AM1DV2 - 1085; ; Calibrated: 2016/05/19
- Sensor-Surface: 0mm (Fix Surface)
- Electronics: DAE4 Sn1207; Calibrated: 2015/11/20
- Phantom: HAC Test Arch with AMCC; Type: SD HAC P01 BA;
- Measurement SW: DASYS2, Version 52.8 (8); SEMCAD X Version 14.6.10 (7331)

**Configuration/Scans/x (longitudinal) 4.2mm 50 x 50/ABM Signal(x,y,z)**

**(13x13x1):** Measurement grid: dx=10mm, dy=10mm

Signal Type: Audio File (.wav) 48k\_voice\_1kHz\_1s.wav

Output Gain: 35.93

Measure Window Start: 0ms

Measure Window Length: 1000ms

BWC applied: 0.16 dB

Device Reference Point: 0, 0, -6.3 mm

**Cursor:**

ABM1 comp = -2.70 dBA/m

BWC Factor = 0.16 dB

Location: -8.3, -4.2, 3.7 mm

**Configuration/Scans/x (longitudinal) fine 3mm 42 x 6/ABM Signal(x,y,z)**

**(15x3x1):** Measurement grid: dx=10mm, dy=10mm

Signal Type: Audio File (.wav) 48k\_voice\_1kHz\_1s.wav

Output Gain: 35.93

Measure Window Start: 0ms

Measure Window Length: 1000ms

BWC applied: 0.16 dB

Device Reference Point: 0, 0, -6.3 mm

**Cursor:**

ABM1 comp = -2.61 dBA/m

BWC Factor = 0.16 dB

Location: -9, 0, 3.7 mm

**Configuration/Scans/x (longitudinal) fine 3mm 42 x 6/ABM SNR(x,y,z)**

**(15x3x1):** Measurement grid: dx=10mm, dy=10mm

Signal Type: Audio File (.wav) 48k\_voice\_1kHz\_1s.wav

Output Gain: 35.93

Measure Window Start: 0ms

Measure Window Length: 1000ms

BWC applied: 0.16 dB

Device Reference Point: 0, 0, -6.3 mm



**Cursor:**

ABM1/ABM2 = 43.25 dB  
 ABM1 comp = -2.69 dBA/m  
 BWC Factor = 0.16 dB  
 Location: -12, -3, 3.7 mm

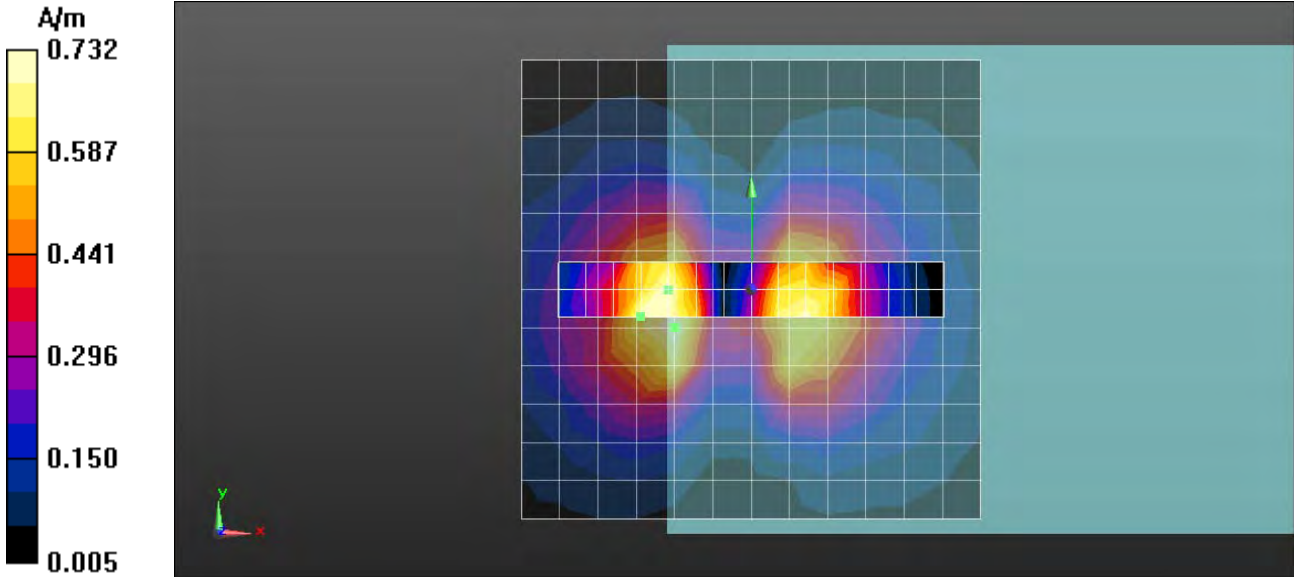

Test Laboratory: QuieTek-a DEKRA

Date/Time: 2016/06/13

**PCS 1900 CH661-Y**

**DUT: AC24G; Type: Mobile Phone**

Communication System: UID 0, FCC PCS\_1900MHz; Frequency: 1880 MHz;

Communication System PAR: 9.191 dB

Medium parameters used:  $\sigma = 0$  S/m,  $\epsilon_r = 1$ ;  $\rho = 1$  kg/m<sup>3</sup>

Phantom section: TCoil Section

Ambient Temperature (°C) : 22.4, Humidity (%RH) : 53

Measurement Standard: DASYS (IEEE/IEC/ANSI C63.19-2011)

DASY5 Configuration:

- Probe: AM1DV2 - 1085; ; Calibrated: 2016/05/19
- Sensor-Surface: 0mm (Fix Surface)
- Electronics: DAE4 Sn1207; Calibrated: 2015/11/20
- Phantom: HAC Test Arch with AMCC; Type: SD HAC P01 BA;
- Measurement SW: DASYS2, Version 52.8 (8); SEMCAD X Version 14.6.10 (7331)

**Configuration/Scans/y (transversal) 4.2mm 50 x 50/ABM Signal(x,y,z)**

**(13x13x1):** Measurement grid: dx=10mm, dy=10mm

Signal Type: Audio File (.wav) 48k\_voice\_1kHz\_1s.wav

Output Gain: 35.93

Measure Window Start: 0ms

Measure Window Length: 1000ms

BWC applied: 0.16 dB

Device Reference Point: 0, 0, -6.3 mm

**Cursor:**

ABM1 comp = -3.18 dBA/m

BWC Factor = 0.16 dB

Location: -4.2, 8.3, 3.7 mm

**Configuration/Scans/y (transversal) fine 3mm 6 x 42/ABM Signal(x,y,z)**

**(3x15x1):** Measurement grid: dx=10mm, dy=10mm

Signal Type: Audio File (.wav) 48k\_voice\_1kHz\_1s.wav

Output Gain: 35.93

Measure Window Start: 0ms

Measure Window Length: 1000ms

BWC applied: 0.16 dB

Device Reference Point: 0, 0, -6.3 mm

**Cursor:**

ABM1 comp = -2.73 dBA/m

BWC Factor = 0.16 dB

Location: 0, 6, 3.7 mm

**Configuration/Scans/y (transversal) fine 3mm 6 x 42/ABM SNR(x,y,z)**

**(3x15x1):** Measurement grid: dx=10mm, dy=10mm

Signal Type: Audio File (.wav) 48k\_voice\_1kHz\_1s.wav

Output Gain: 35.93

Measure Window Start: 0ms

Measure Window Length: 1000ms

BWC applied: 0.16 dB

Device Reference Point: 0, 0, -6.3 mm

**Cursor:**

ABM1/ABM2 = 52.39 dB  
 ABM1 comp = -3.63 dBA/m  
 BWC Factor = 0.16 dB  
 Location: 0, -9, 3.7 mm

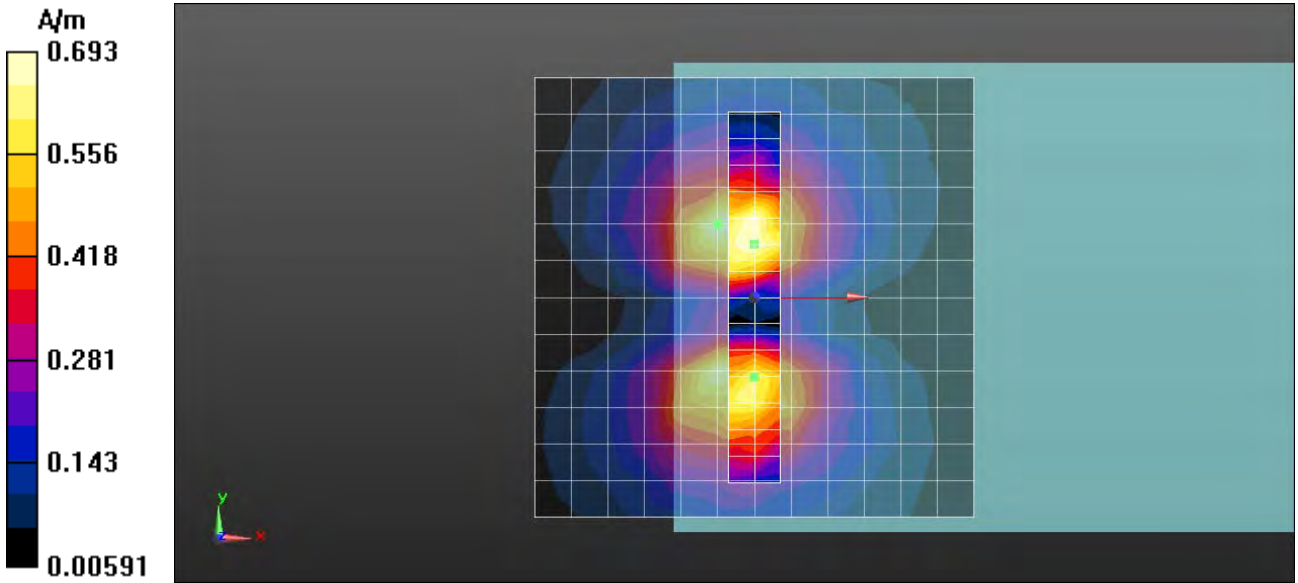

Test Laboratory: QuieTek-a DEKRA

Date/Time: 2016/06/13

**PCS 1900 CH661-Z**

**DUT: AC24G; Type: Mobile Phone**

Communication System: UID 0, FCC PCS\_1900MHz; Frequency: 1880 MHz;

Communication System PAR: 9.191 dB

Medium parameters used:  $\sigma = 0$  S/m,  $\epsilon_r = 1$ ;  $\rho = 1$  kg/m<sup>3</sup>

Phantom section: TCoil Section

Ambient Temperature (°C) : 22.4, Humidity (%RH) : 53

Measurement Standard: DASYS (IEEE/IEC/ANSI C63.19-2011)

DASY5 Configuration:

- Probe: AM1DV2 - 1085; ; Calibrated: 2016/05/19
- Sensor-Surface: 0mm (Fix Surface)
- Electronics: DAE4 Sn1207; Calibrated: 2015/11/20
- Phantom: HAC Test Arch with AMCC; Type: SD HAC P01 BA;
- Measurement SW: DASYS2, Version 52.8 (8); SEMCAD X Version 14.6.10 (7331)

**Configuration/Scans/z (axial) 4.2mm 50 x 50/ABM Signal(x,y,z) (13x13x1):**

Measurement grid: dx=10mm, dy=10mm

Signal Type: Audio File (.wav) 48k\_voice\_1kHz\_1s.wav

Output Gain: 35.93

Measure Window Start: 0ms

Measure Window Length: 1000ms

BWC applied: 0.16 dB

Device Reference Point: 0, 0, -6.3 mm

**Cursor:**

ABM1 comp = 4.91 dBA/m

BWC Factor = 0.16 dB

Location: 0, 0, 3.7 mm

**Configuration/Scans/z (axial) fine 2mm 8 x 8/ABM Signal(x,y,z) (5x5x1):**

Measurement grid: dx=10mm, dy=10mm

Signal Type: Audio File (.wav) 48k\_voice\_1kHz\_1s.wav

Output Gain: 35.93

Measure Window Start: 0ms

Measure Window Length: 1000ms

BWC applied: 0.16 dB

Device Reference Point: 0, 0, -6.3 mm

**Cursor:**

ABM1 comp = 5.42 dBA/m

BWC Factor = 0.16 dB

Location: -2, 0, 3.7 mm

**Configuration/Scans/z (axial) fine 2mm 8 x 8/ABM SNR(x,y,z) (5x5x1):**

Measurement grid: dx=10mm, dy=10mm

Signal Type: Audio File (.wav) 48k\_voice\_1kHz\_1s.wav

Output Gain: 35.93

Measure Window Start: 0ms

Measure Window Length: 1000ms

BWC applied: 0.16 dB

Device Reference Point: 0, 0, -6.3 mm

**Cursor:**

ABM1/ABM2 = 48.23 dB  
 ABM1 comp = 0.64 dBA/m  
 BWC Factor = 0.16 dB  
 Location: 4, -4, 3.7 mm

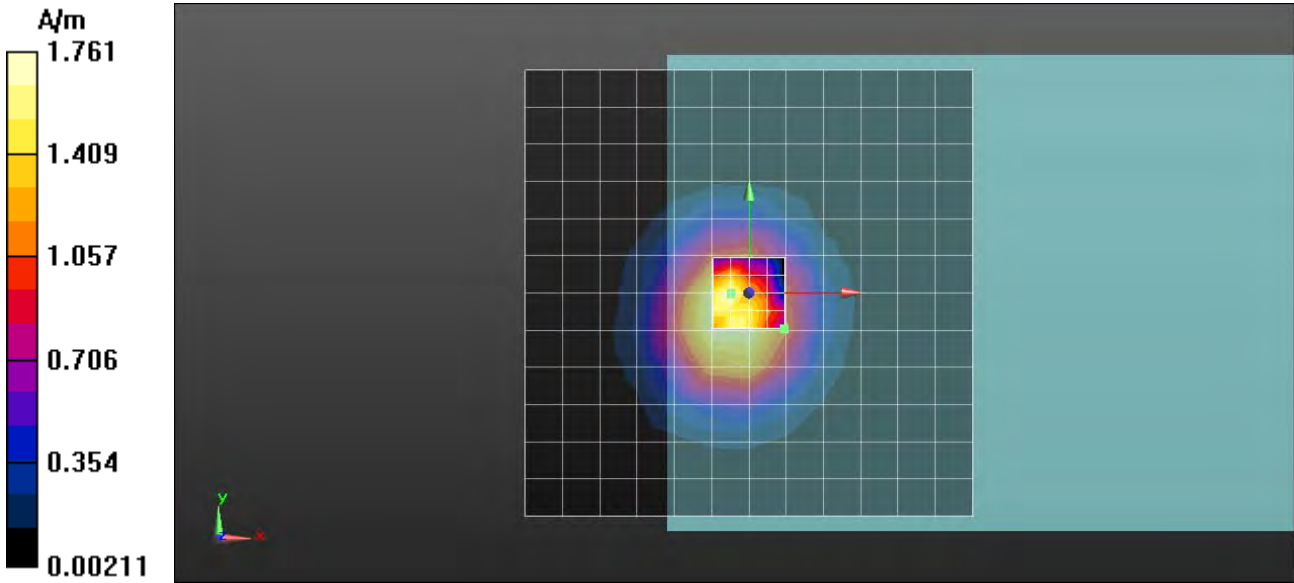

**T-Coil Z Axis plot**  
**Channel: 661**

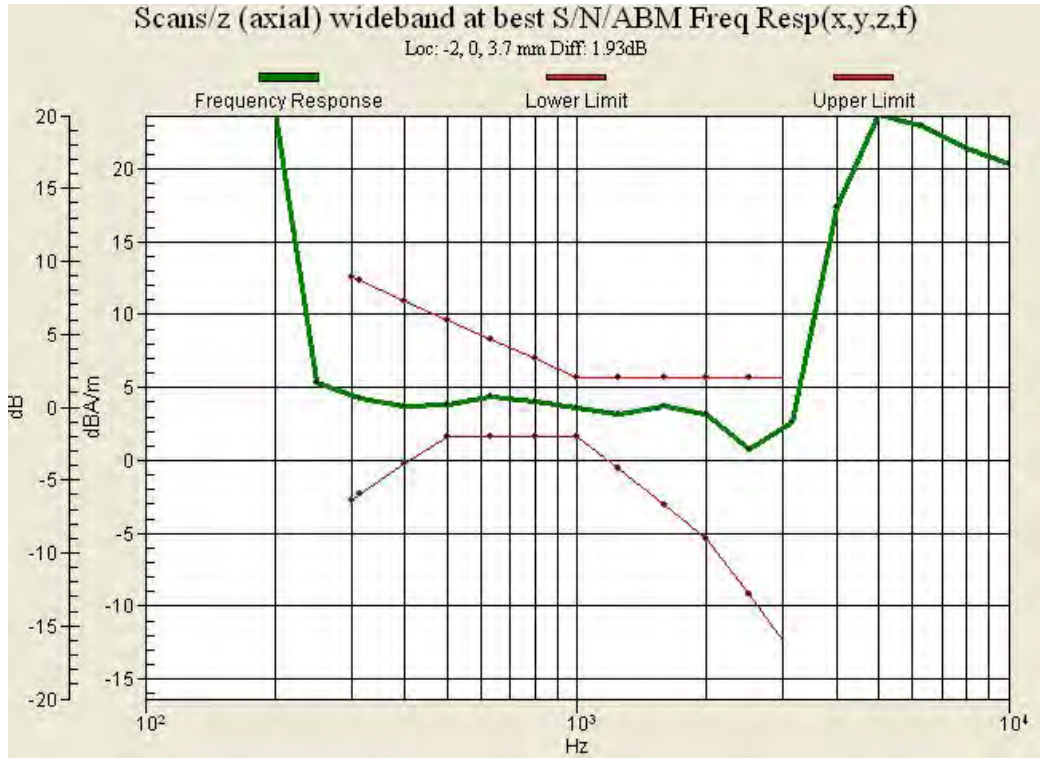

Test Laboratory: QuieTek-a DEKRA

Date/Time: 2016/06/13

**PCS 1900 CH810-X**

**DUT: AC24G; Type: Mobile Phone**

Communication System: UID 0, FCC PCS\_1900MHz; Frequency: 1909.8 MHz;

Communication System PAR: 9.191 dB

Medium parameters used:  $\sigma = 0$  S/m,  $\epsilon_r = 1$ ;  $\rho = 1$  kg/m<sup>3</sup>

Phantom section: TCoil Section

Ambient Temperature (°C) : 22.4, Humidity (%RH) : 53

Measurement Standard: DASYS (IEEE/IEC/ANSI C63.19-2011)

DASY5 Configuration:

- Probe: AM1DV2 - 1085; ; Calibrated: 2016/05/19
- Sensor-Surface: 0mm (Fix Surface)
- Electronics: DAE4 Sn1207; Calibrated: 2015/11/20
- Phantom: HAC Test Arch with AMCC; Type: SD HAC P01 BA;
- Measurement SW: DASYS2, Version 52.8 (8); SEMCAD X Version 14.6.10 (7331)

**Configuration/Scans/x (longitudinal) 4.2mm 50 x 50/ABM Signal(x,y,z)**

**(13x13x1):** Measurement grid: dx=10mm, dy=10mm

Signal Type: Audio File (.wav) 48k\_voice\_1kHz\_1s.wav

Output Gain: 35.93

Measure Window Start: 0ms

Measure Window Length: 1000ms

BWC applied: 0.16 dB

Device Reference Point: 0, 0, -6.3 mm

**Cursor:**

ABM1 comp = -2.92 dBA/m

BWC Factor = 0.16 dB

Location: 4.2, -4.2, 3.7 mm

**Configuration/Scans/x (longitudinal) fine 3mm 42 x 6/ABM Signal(x,y,z)**

**(15x3x1):** Measurement grid: dx=10mm, dy=10mm

Signal Type: Audio File (.wav) 48k\_voice\_1kHz\_1s.wav

Output Gain: 35.93

Measure Window Start: 0ms

Measure Window Length: 1000ms

BWC applied: 0.16 dB

Device Reference Point: 0, 0, -6.3 mm

**Cursor:**

ABM1 comp = -3.00 dBA/m

BWC Factor = 0.16 dB

Location: 7.8, -3, 3.7 mm

**Configuration/Scans/x (longitudinal) fine 3mm 42 x 6/ABM SNR(x,y,z)**

**(15x3x1):** Measurement grid: dx=10mm, dy=10mm

Signal Type: Audio File (.wav) 48k\_voice\_1kHz\_1s.wav

Output Gain: 35.93

Measure Window Start: 0ms

Measure Window Length: 1000ms

BWC applied: 0.16 dB

Device Reference Point: 0, 0, -6.3 mm



**Cursor:**

ABM1/ABM2 = 42.30 dB  
 ABM1 comp = -3.27 dBA/m  
 BWC Factor = 0.16 dB  
 Location: -10.2, -3, 3.7 mm

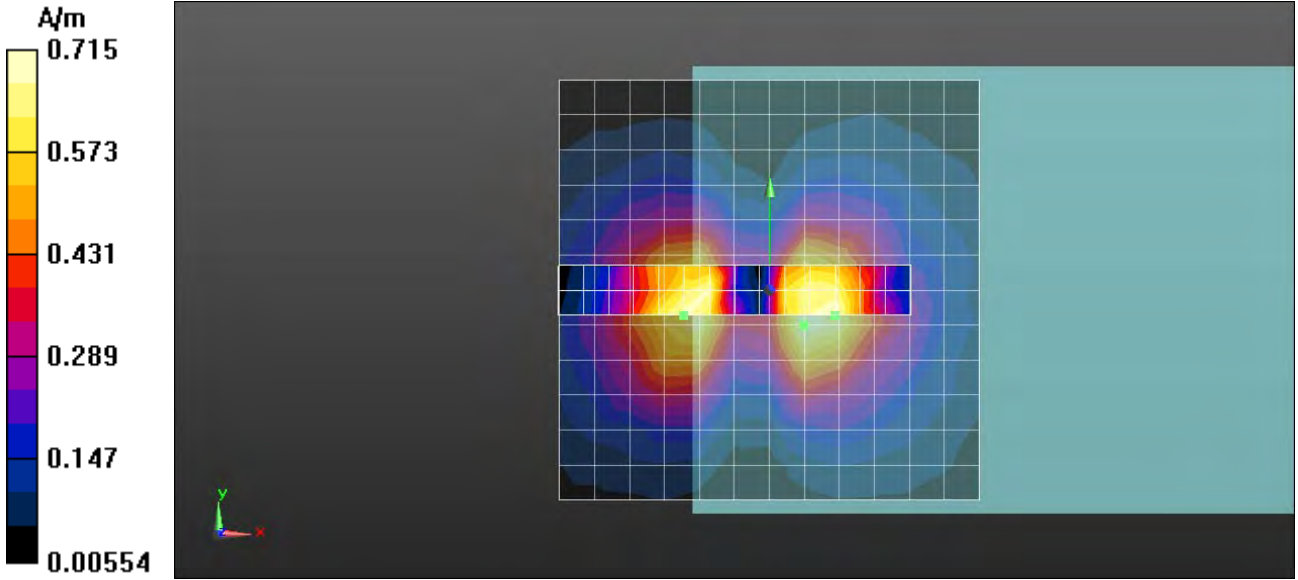

Test Laboratory: QuieTek-a DEKRA

Date/Time: 2016/06/13

**PCS 1900 CH810-Y**

**DUT: AC24G; Type: Mobile Phone**

Communication System: UID 0, FCC PCS\_1900MHz; Frequency: 1909.8 MHz;

Communication System PAR: 9.191 dB

Medium parameters used:  $\sigma = 0$  S/m,  $\epsilon_r = 1$ ;  $\rho = 1$  kg/m<sup>3</sup>

Phantom section: TCoil Section

Ambient Temperature (°C) : 22.4, Humidity (%RH) : 53

Measurement Standard: DASYS (IEEE/IEC/ANSI C63.19-2011)

DASY5 Configuration:

- Probe: AM1DV2 - 1085; ; Calibrated: 2016/05/19
- Sensor-Surface: 0mm (Fix Surface)
- Electronics: DAE4 Sn1207; Calibrated: 2015/11/20
- Phantom: HAC Test Arch with AMCC; Type: SD HAC P01 BA;
- Measurement SW: DASYS2, Version 52.8 (8); SEMCAD X Version 14.6.10 (7331)

**Configuration/Scans/y (transversal) 4.2mm 50 x 50/ABM Signal(x,y,z)**

**(13x13x1):** Measurement grid: dx=10mm, dy=10mm

Signal Type: Audio File (.wav) 48k\_voice\_1kHz\_1s.wav

Output Gain: 35.93

Measure Window Start: 0ms

Measure Window Length: 1000ms

BWC applied: 0.16 dB

Device Reference Point: 0, 0, -6.3 mm

**Cursor:**

ABM1 comp = -2.68 dBA/m

BWC Factor = 0.16 dB

Location: 0, 8.3, 3.7 mm

**Configuration/Scans/y (transversal) fine 3mm 6 x 42/ABM Signal(x,y,z)**

**(3x15x1):** Measurement grid: dx=10mm, dy=10mm

Signal Type: Audio File (.wav) 48k\_voice\_1kHz\_1s.wav

Output Gain: 35.93

Measure Window Start: 0ms

Measure Window Length: 1000ms

BWC applied: 0.16 dB

Device Reference Point: 0, 0, -6.3 mm

**Cursor:**

ABM1 comp = -2.76 dBA/m

BWC Factor = 0.16 dB

Location: -1.2, 6, 3.7 mm

**Configuration/Scans/y (transversal) fine 3mm 6 x 42/ABM SNR(x,y,z)**

**(3x15x1):** Measurement grid: dx=10mm, dy=10mm

Signal Type: Audio File (.wav) 48k\_voice\_1kHz\_1s.wav

Output Gain: 35.93

Measure Window Start: 0ms

Measure Window Length: 1000ms

BWC applied: 0.16 dB

Device Reference Point: 0, 0, -6.3 mm

**Cursor:**

ABM1/ABM2 = 52.71 dB  
 ABM1 comp = -2.86 dBA/m  
 BWC Factor = 0.16 dB  
 Location: -1.2, -9, 3.7 mm

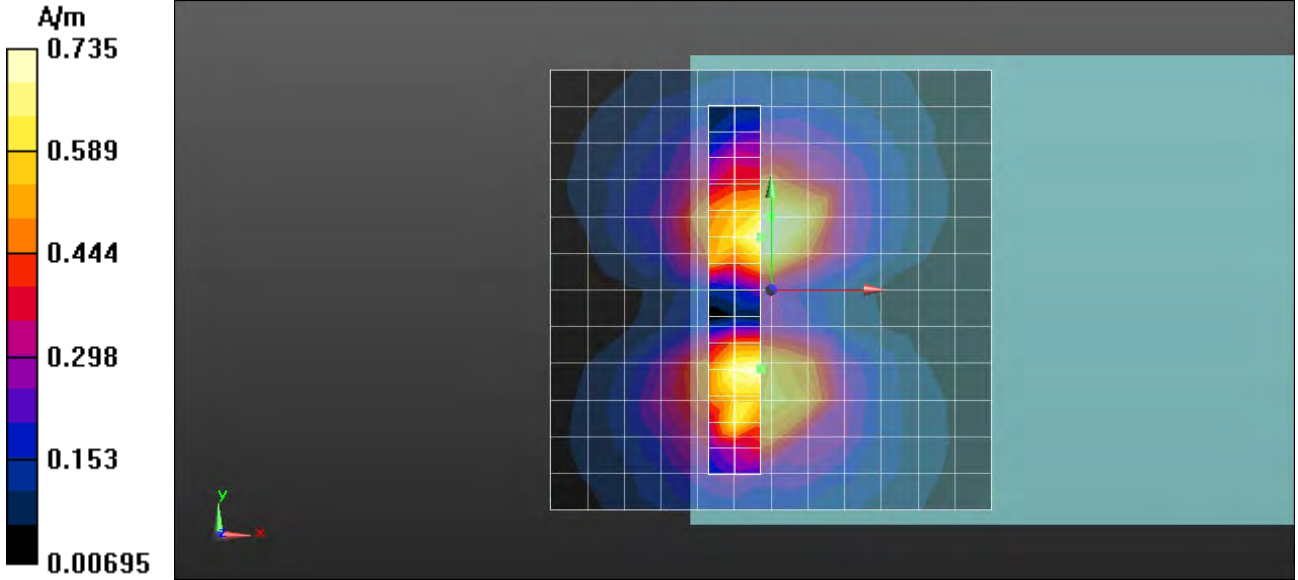

Test Laboratory: QuieTek-a DEKRA

Date/Time: 2016/06/13

**PCS 1900 CH810-Z**

**DUT: AC24G; Type: Mobile Phone**

Communication System: UID 0, FCC PCS\_1900MHz; Frequency: 1909.8 MHz;

Communication System PAR: 9.191 dB

Medium parameters used:  $\sigma = 0$  S/m,  $\epsilon_r = 1$ ;  $\rho = 1$  kg/m<sup>3</sup>

Phantom section: TCoil Section

Ambient Temperature (°C) : 22.4, Humidity (%RH) : 53

Measurement Standard: DASYS (IEEE/IEC/ANSI C63.19-2011)

DASY5 Configuration:

- Probe: AM1DV2 - 1085; ; Calibrated: 2016/05/19
- Sensor-Surface: 0mm (Fix Surface)
- Electronics: DAE4 Sn1207; Calibrated: 2015/11/20
- Phantom: HAC Test Arch with AMCC; Type: SD HAC P01 BA;
- Measurement SW: DASYS2, Version 52.8 (8); SEMCAD X Version 14.6.10 (7331)

**Configuration/Scans/z (axial) 4.2mm 50 x 50/ABM Signal(x,y,z) (13x13x1):**

Measurement grid: dx=10mm, dy=10mm

Signal Type: Audio File (.wav) 48k\_voice\_1kHz\_1s.wav

Output Gain: 35.93

Measure Window Start: 0ms

Measure Window Length: 1000ms

BWC applied: 0.16 dB

Device Reference Point: 0, 0, -6.3 mm

**Cursor:**

ABM1 comp = 4.13 dBA/m

BWC Factor = 0.16 dB

Location: -4.2, 0, 3.7 mm

**Configuration/Scans/z (axial) fine 2mm 8 x 8/ABM Signal(x,y,z) (5x5x1):**

Measurement grid: dx=10mm, dy=10mm

Signal Type: Audio File (.wav) 48k\_voice\_1kHz\_1s.wav

Measure Window Start: 0ms

Measure Window Length: 1000ms

BWC applied: 0.16 dB

Device Reference Point: 0, 0, -6.3 mm

**Cursor:**

ABM1 comp = 5.42 dBA/m

BWC Factor = 0.16 dB

Location: -2.2, -2, 3.7 mm

**Configuration/Scans/z (axial) fine 2mm 8 x 8/ABM SNR(x,y,z) (5x5x1):**

Measurement grid: dx=10mm, dy=10mm

Signal Type: Audio File (.wav) 48k\_voice\_1kHz\_1s.wav

Output Gain: 35.93

Measure Window Start: 0ms

Measure Window Length: 1000ms

BWC applied: 0.16 dB

Device Reference Point: 0, 0, -6.3 mm

**Cursor:**

ABM1/ABM2 = 53.03 dB  
 ABM1 comp = 5.14 dBA/m  
 BWC Factor = 0.16 dB  
 Location: -2.2, 0, 3.7 mm

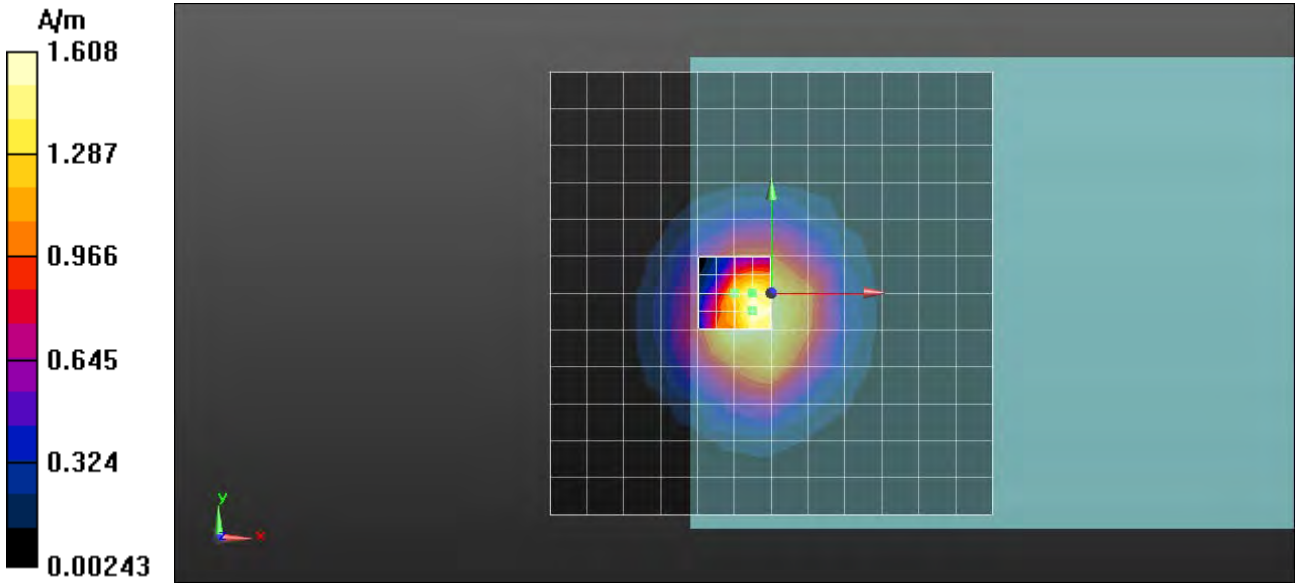

**T-Coil Z Axis plot**  
**Channel: 810**

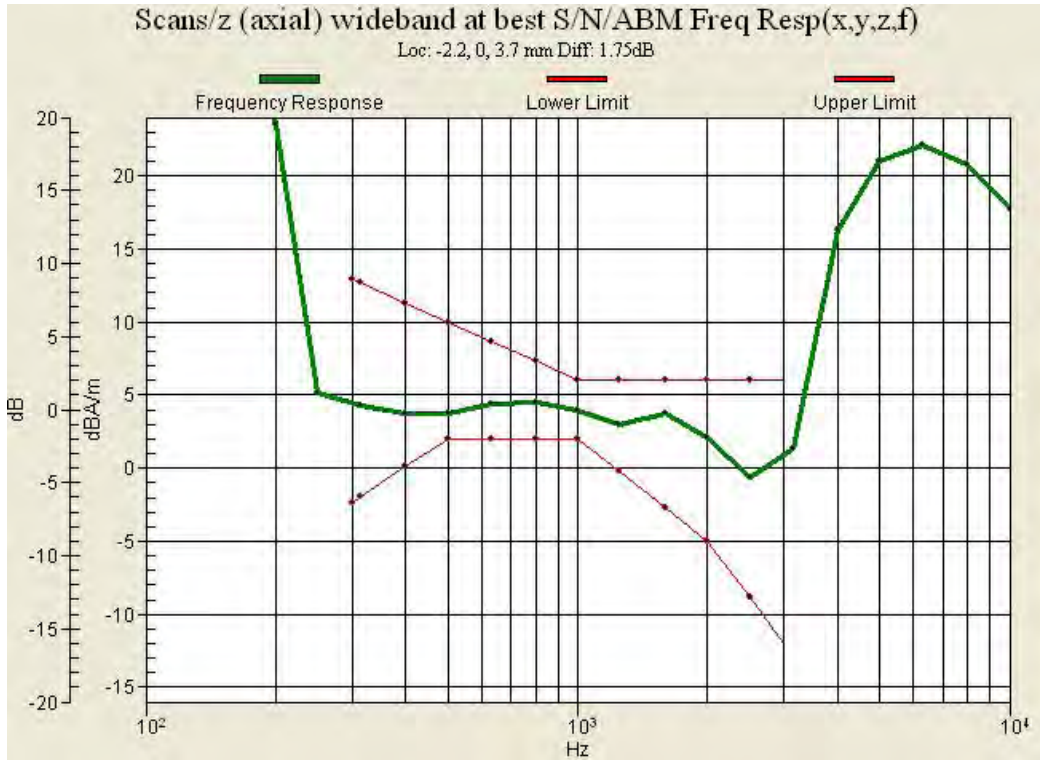

Test Laboratory: QuieTek-a DEKRA

Date/Time: 2016/06/13

**WCDMA Band 2 CH9262-X**

**DUT: AC24G; Type: Mobile Phone**

Communication System: UID 0, FCC WCDMA\_Band-2; Frequency: 1852.4 MHz;

Communication System PAR: 0 dB

Medium parameters used:  $\sigma = 0$  S/m,  $\epsilon_r = 1$ ;  $\rho = 1$  kg/m<sup>3</sup>

Phantom section: TCoil Section

Ambient Temperature (°C) : 22.4, Humidity (%RH) : 53

Measurement Standard: DASYS (IEEE/IEC/ANSI C63.19-2011)

DASY5 Configuration:

- Probe: AM1DV2 - 1085; ; Calibrated: 2016/05/19
- Sensor-Surface: 0mm (Fix Surface)
- Electronics: DAE4 Sn1207; Calibrated: 2015/11/20
- Phantom: HAC Test Arch with AMCC; Type: SD HAC P01 BA;
- Measurement SW: DASYS2, Version 52.8 (8); SEMCAD X Version 14.6.10 (7331)

**Configuration/Scans/x (longitudinal) 4.2mm 50 x 50/ABM Signal(x,y,z)**

**(13x13x1):** Measurement grid: dx=10mm, dy=10mm

Signal Type: Audio File (.wav) 48k\_voice\_1kHz\_1s.wav

Output Gain: 35.93

Measure Window Start: 0ms

Measure Window Length: 1000ms

BWC applied: 0.15 dB

Device Reference Point: 0, 0, -6.3 mm

**Cursor:**

ABM1 comp = -2.65 dBA/m

BWC Factor = 0.15 dB

Location: -8.3, -4.2, 3.7 mm

**Configuration/Scans/x (longitudinal) fine 3mm 42 x 6/ABM Signal(x,y,z)**

**(15x3x1):** Measurement grid: dx=10mm, dy=10mm

Signal Type: Audio File (.wav) 48k\_voice\_1kHz\_1s.wav

Output Gain: 35.93

Measure Window Start: 0ms

Measure Window Length: 1000ms

BWC applied: 0.15 dB

Device Reference Point: 0, 0, -6.3 mm

**Cursor:**

ABM1 comp = -2.37 dBA/m

BWC Factor = 0.15 dB

Location: 6, -3, 3.7 mm

**Configuration/Scans/x (longitudinal) fine 3mm 42 x 6/ABM SNR(x,y,z)**

**(15x3x1):** Measurement grid: dx=10mm, dy=10mm

Signal Type: Audio File (.wav) 48k\_voice\_1kHz\_1s.wav

Output Gain: 35.93

Measure Window Start: 0ms

Measure Window Length: 1000ms

BWC applied: 0.15 dB

Device Reference Point: 0, 0, -6.3 mm



**Cursor:**

ABM1/ABM2 = 52.30 dB  
 ABM1 comp = -4.19 dBA/m  
 BWC Factor = 0.15 dB  
 Location: -12, 0, 3.7 mm

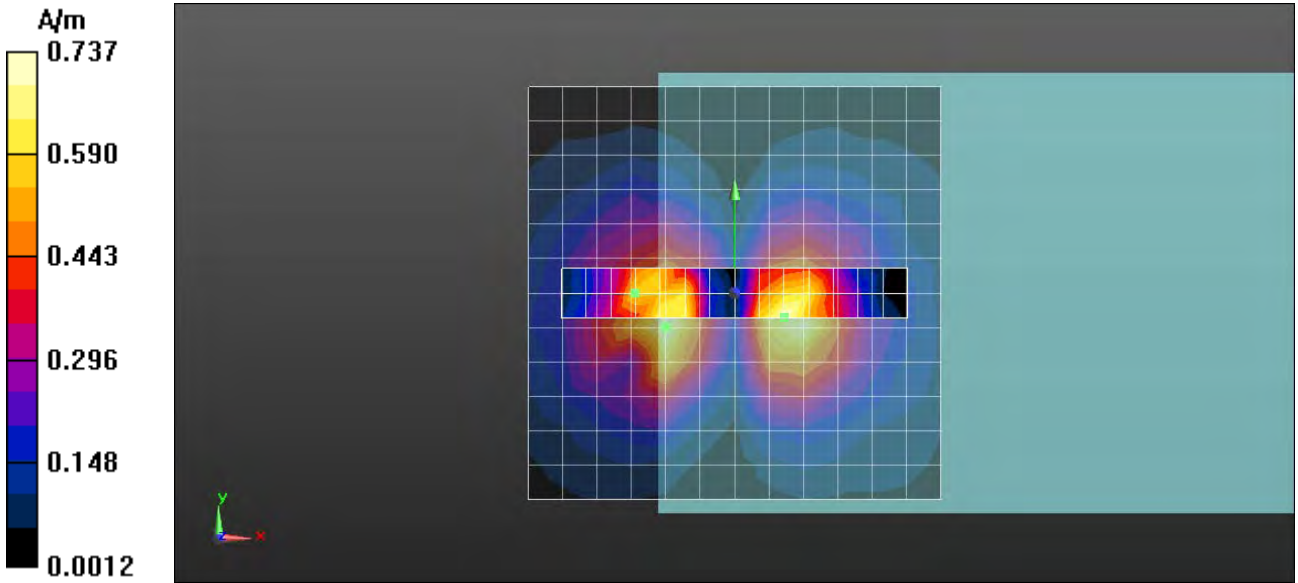

Test Laboratory: QuieTek-a DEKRA

Date/Time: 2016/06/13

**WCDMA Band 2 CH9262-Y**

**DUT: AC24G; Type: Mobile Phone**

Communication System: UID 0, FCC WCDMA\_Band-2; Frequency: 1852.4 MHz;

Communication System PAR: 0 dB

Medium parameters used:  $\sigma = 0$  S/m,  $\epsilon_r = 1$ ;  $\rho = 1$  kg/m<sup>3</sup>

Phantom section: TCoil Section

Ambient Temperature (°C) : 22.4, Humidity (%RH) : 53

Measurement Standard: DASYS (IEEE/IEC/ANSI C63.19-2011)

DASY5 Configuration:

- Probe: AM1DV2 - 1085; ; Calibrated: 2016/05/19
- Sensor-Surface: 0mm (Fix Surface)
- Electronics: DAE4 Sn1207; Calibrated: 2015/11/20
- Phantom: HAC Test Arch with AMCC; Type: SD HAC P01 BA;
- Measurement SW: DASYS2, Version 52.8 (8); SEMCAD X Version 14.6.10 (7331)

**Configuration/Scans/y (transversal) 4.2mm 50 x 50/ABM Signal(x,y,z)**

**(13x13x1):** Measurement grid: dx=10mm, dy=10mm

Signal Type: Audio File (.wav) 48k\_voice\_1kHz\_1s.wav

Output Gain: 35.93

Measure Window Start: 0ms

Measure Window Length: 1000ms

BWC applied: 0.15 dB

Device Reference Point: 0, 0, -6.3 mm

**Cursor:**

ABM1 comp = -3.53 dBA/m

BWC Factor = 0.15 dB

Location: 0, 8.3, 3.7 mm

**Configuration/Scans/y (transversal) fine 3mm 6 x 42/ABM Signal(x,y,z)**

**(3x15x1):** Measurement grid: dx=10mm, dy=10mm

Signal Type: Audio File (.wav) 48k\_voice\_1kHz\_1s.wav

Output Gain: 35.93

Measure Window Start: 0ms

Measure Window Length: 1000ms

BWC applied: 0.15 dB

Device Reference Point: 0, 0, -6.3 mm

**Cursor:**

ABM1 comp = -2.89 dBA/m

BWC Factor = 0.15 dB

Location: 0, 6, 3.7 mm

**Configuration/Scans/y (transversal) fine 3mm 6 x 42/ABM SNR(x,y,z)**

**(3x15x1):** Measurement grid: dx=10mm, dy=10mm

Signal Type: Audio File (.wav) 48k\_voice\_1kHz\_1s.wav

Output Gain: 35.93

Measure Window Start: 0ms

Measure Window Length: 1000ms

BWC applied: 0.15 dB

Device Reference Point: 0, 0, -6.3 mm

**Cursor:**

ABM1/ABM2 = 52.33 dB  
 ABM1 comp = -3.26 dBA/m  
 BWC Factor = 0.15 dB  
 Location: 0, -9, 3.7 mm

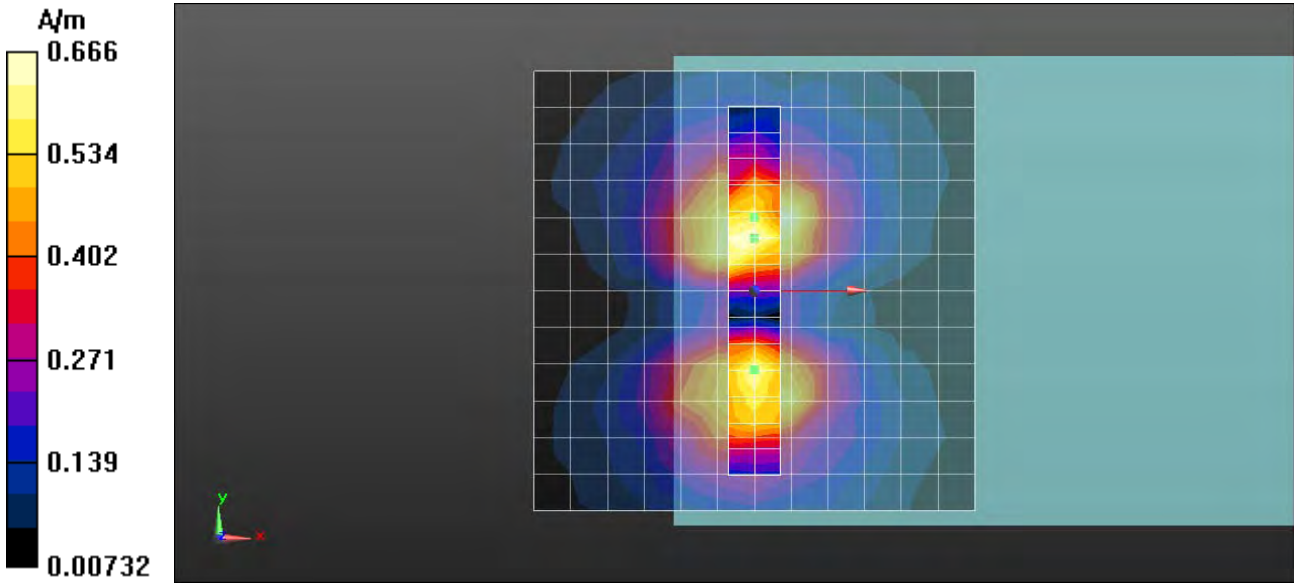

Test Laboratory: QuieTek-a DEKRA

Date/Time: 2016/06/13

**WCDMA Band 2 CH9262-Z**

**DUT: AC24G; Type: Mobile Phone**

Communication System: UID 0, FCC WCDMA\_Band-2; Frequency: 1852.4 MHz;

Communication System PAR: 0 dB

Medium parameters used:  $\sigma = 0$  S/m,  $\epsilon_r = 1$ ;  $\rho = 1$  kg/m<sup>3</sup>

Phantom section: TCoil Section

Ambient Temperature (°C) : 22.4, Humidity (%RH) : 53

Measurement Standard: DASYS (IEEE/IEC/ANSI C63.19-2011)

DASY5 Configuration:

- Probe: AM1DV2 - 1085; ; Calibrated: 2016/05/19
- Sensor-Surface: 0mm (Fix Surface)
- Electronics: DAE4 Sn1207; Calibrated: 2015/11/20
- Phantom: HAC Test Arch with AMCC; Type: SD HAC P01 BA;
- Measurement SW: DASYS2, Version 52.8 (8); SEMCAD X Version 14.6.10 (7331)

**Configuration/Scans/z (axial) 4.2mm 50 x 50/ABM Signal(x,y,z) (13x13x1):**

Measurement grid: dx=10mm, dy=10mm

Signal Type: Audio File (.wav) 48k\_voice\_1kHz\_1s.wav

Output Gain: 35.93

Measure Window Start: 0ms

Measure Window Length: 1000ms

BWC applied: 0.15 dB

Device Reference Point: 0, 0, -6.3 mm

**Cursor:**

ABM1 comp = 3.90 dBA/m

BWC Factor = 0.15 dB

Location: 0, 0, 3.7 mm

**Configuration/Scans/z (axial) fine 2mm 8 x 8/ABM Signal(x,y,z) (5x5x1):**

Measurement grid: dx=10mm, dy=10mm

Signal Type: Audio File (.wav) 48k\_voice\_1kHz\_1s.wav

Output Gain: 35.93

Measure Window Start: 0ms

Measure Window Length: 1000ms

BWC applied: 0.15 dB

Device Reference Point: 0, 0, -6.3 mm

**Cursor:**

ABM1 comp = 4.86 dBA/m

BWC Factor = 0.15 dB

Location: -2, 0, 3.7 mm

**Configuration/Scans/z (axial) fine 2mm 8 x 8/ABM SNR(x,y,z) (5x5x1):**

Measurement grid: dx=10mm, dy=10mm

Signal Type: Audio File (.wav) 48k\_voice\_1kHz\_1s.wav

Output Gain: 35.93

Measure Window Start: 0ms

Measure Window Length: 1000ms

BWC applied: 0.15 dB

Device Reference Point: 0, 0, -6.3 mm

**Cursor:**

ABM1/ABM2 = 56.33 dB  
 ABM1 comp = 4.86 dBA/m  
 BWC Factor = 0.15 dB  
 Location: -2, 0, 3.7 mm

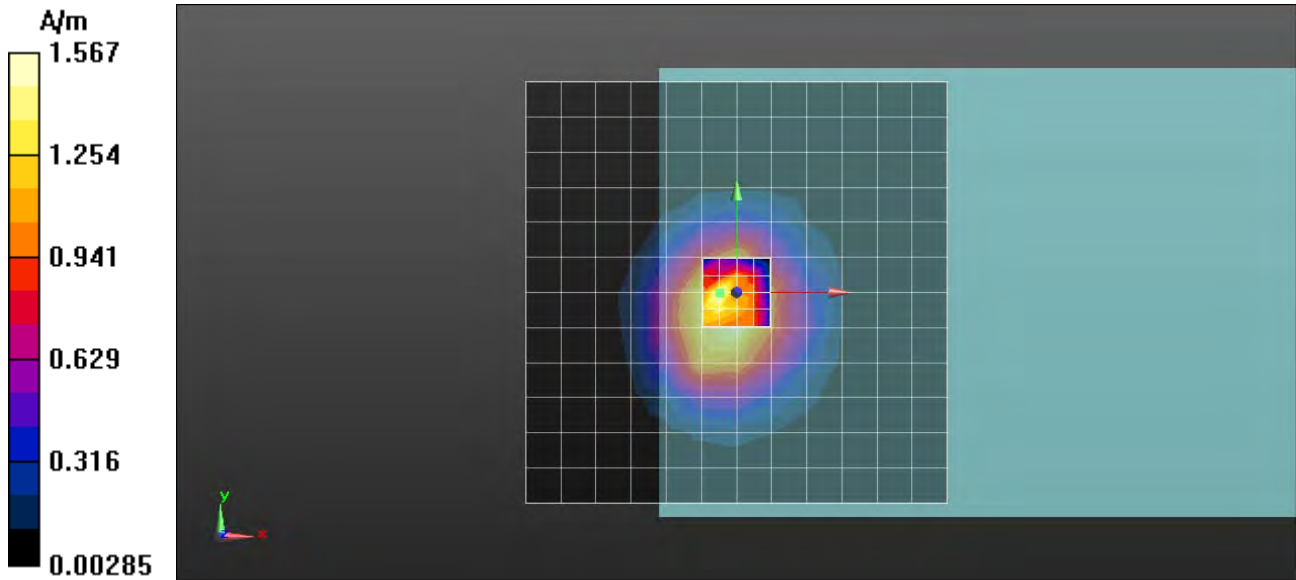

**T-Coil Z Axis plot**  
**Channel: 9262**

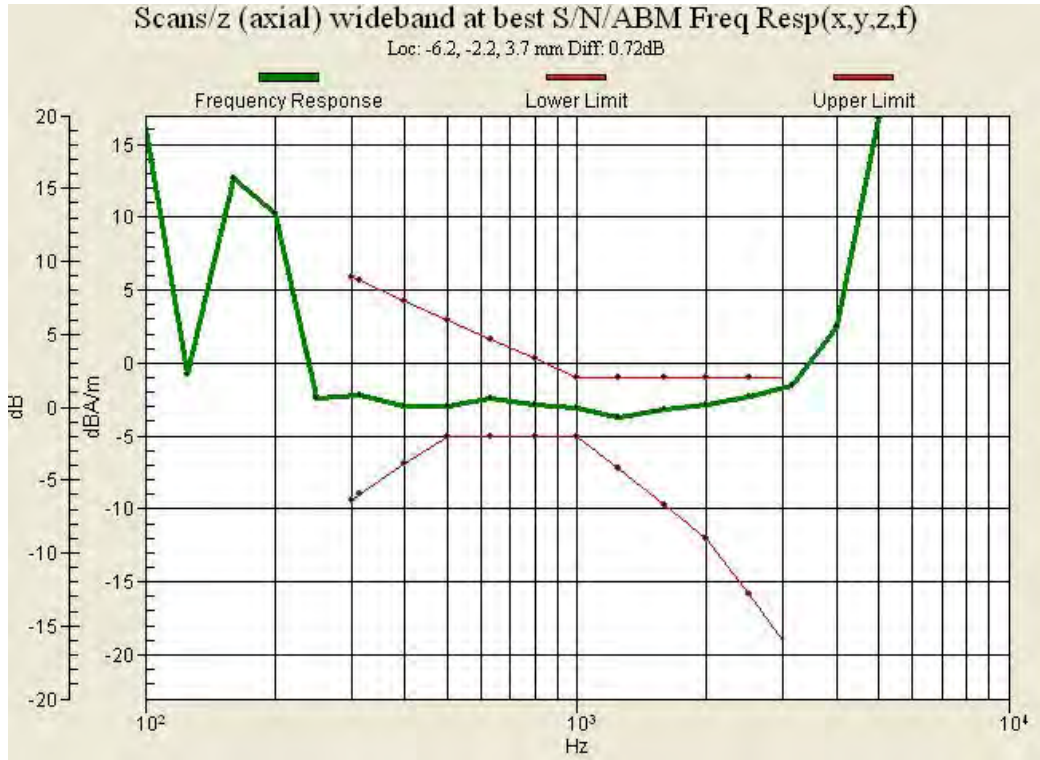

Test Laboratory: QuieTek-a DEKRA

Date/Time: 2016/06/13

**WCDMA Band 2 CH9400-X**

**DUT: AC24G; Type: Mobile Phone**

Communication System: UID 0, FCC WCDMA\_Band-2; Frequency: 1880 MHz;

Communication System PAR: 0 dB

Medium parameters used:  $\sigma = 0$  S/m,  $\epsilon_r = 1$ ;  $\rho = 1$  kg/m<sup>3</sup>

Phantom section: TCoil Section

Ambient Temperature (°C) : 22.4, Humidity (%RH) : 53

Measurement Standard: DASYS (IEEE/IEC/ANSI C63.19-2011)

DASY5 Configuration:

- Probe: AM1DV2 - 1085; ; Calibrated: 2016/05/19
- Sensor-Surface: 0mm (Fix Surface)
- Electronics: DAE4 Sn1207; Calibrated: 2015/11/20
- Phantom: HAC Test Arch with AMCC; Type: SD HAC P01 BA;
- Measurement SW: DASYS2, Version 52.8 (8); SEMCAD X Version 14.6.10 (7331)

**Configuration/Scans/x (longitudinal) 4.2mm 50 x 50/ABM Signal(x,y,z)**

**(13x13x1):** Measurement grid: dx=10mm, dy=10mm

Signal Type: Audio File (.wav) 48k\_voice\_1kHz\_1s.wav

Output Gain: 35.93

Measure Window Start: 0ms

Measure Window Length: 1000ms

BWC applied: 0.15 dB

Device Reference Point: 0, 0, -6.3 mm

**Cursor:**

ABM1 comp = -4.13 dBA/m

BWC Factor = 0.15 dB

Location: -8.3, -4.2, 3.7 mm

**Configuration/Scans/x (longitudinal) fine 3mm 42 x 6/ABM Signal(x,y,z)**

**(15x3x1):** Measurement grid: dx=10mm, dy=10mm

Signal Type: Audio File (.wav) 48k\_voice\_1kHz\_1s.wav

Output Gain: 35.93

Measure Window Start: 0ms

Measure Window Length: 1000ms

BWC applied: 0.15 dB

Device Reference Point: 0, 0, -6.3 mm

**Cursor:**

ABM1 comp = -3.74 dBA/m

BWC Factor = 0.15 dB

Location: 6, -1.2, 3.7 mm

**Configuration/Scans/x (longitudinal) fine 3mm 42 x 6/ABM SNR(x,y,z)**

**(15x3x1):** Measurement grid: dx=10mm, dy=10mm

Signal Type: Audio File (.wav) 48k\_voice\_1kHz\_1s.wav

Output Gain: 35.93

Measure Window Start: 0ms

Measure Window Length: 1000ms

BWC applied: 0.15 dB

Device Reference Point: 0, 0, -6.3 mm



**Cursor:**

ABM1/ABM2 = 52.29 dB  
 ABM1 comp = -3.83 dBA/m  
 BWC Factor = 0.15 dB  
 Location: 6, -4.2, 3.7 mm

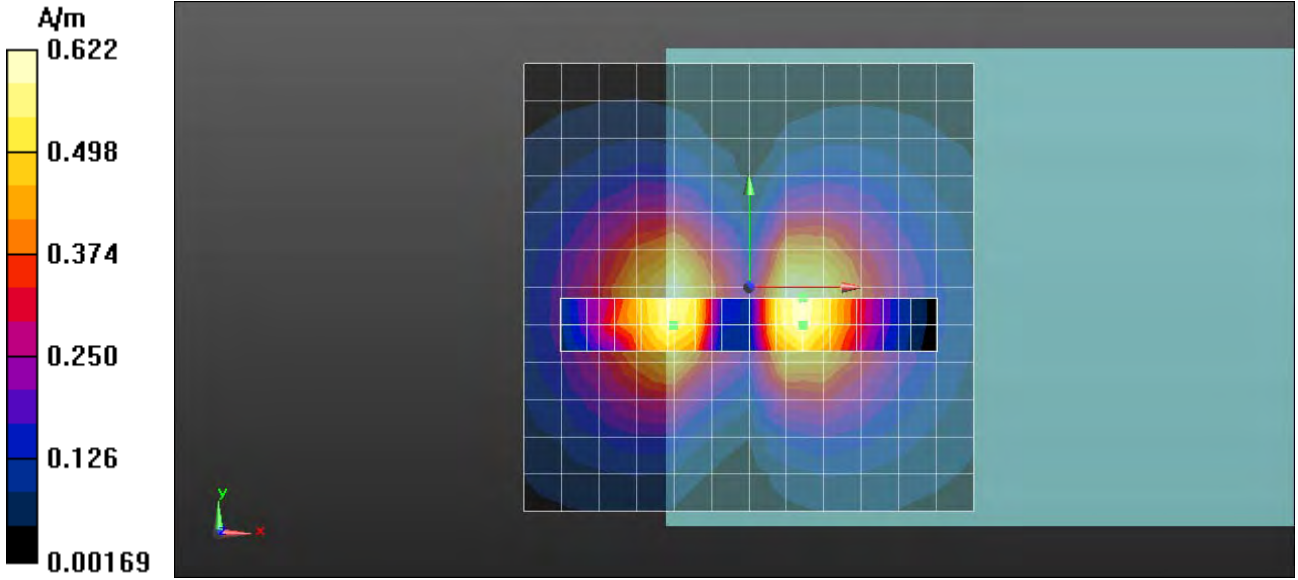

Test Laboratory: QuieTek-a DEKRA

Date/Time: 2016/06/13

**WCDMA Band 2 CH9400-Y**

**DUT: AC24G; Type: Mobile Phone**

Communication System: UID 0, FCC WCDMA\_Band-2; Frequency: 1880 MHz;

Communication System PAR: 0 dB

Medium parameters used:  $\sigma = 0$  S/m,  $\epsilon_r = 1$ ;  $\rho = 1$  kg/m<sup>3</sup>

Phantom section: TCoil Section

Ambient Temperature (°C) : 22.4, Humidity (%RH) : 53

Measurement Standard: DASYS (IEEE/IEC/ANSI C63.19-2011)

DASY5 Configuration:

- Probe: AM1DV2 - 1085; ; Calibrated: 2016/05/19
- Sensor-Surface: 0mm (Fix Surface)
- Electronics: DAE4 Sn1207; Calibrated: 2015/11/20
- Phantom: HAC Test Arch with AMCC; Type: SD HAC P01 BA;
- Measurement SW: DASYS2, Version 52.8 (8); SEMCAD X Version 14.6.10 (7331)

**Configuration/Scans/y (transversal) 4.2mm 50 x 50/ABM Signal(x,y,z)**

**(13x13x1):** Measurement grid: dx=10mm, dy=10mm

Signal Type: Audio File (.wav) 48k\_voice\_1kHz\_1s.wav

Output Gain: 35.93

Measure Window Start: 0ms

Measure Window Length: 1000ms

BWC applied: 0.15 dB

Device Reference Point: 0, 0, -6.3 mm

**Cursor:**

ABM1 comp = -4.60 dBA/m

BWC Factor = 0.15 dB

Location: 0, 4.2, 3.7 mm

**Configuration/Scans/y (transversal) fine 3mm 6 x 42/ABM Signal(x,y,z)**

**(3x15x1):** Measurement grid: dx=10mm, dy=10mm

Signal Type: Audio File (.wav) 48k\_voice\_1kHz\_1s.wav

Output Gain: 35.93

Measure Window Start: 0ms

Measure Window Length: 1000ms

BWC applied: 0.15 dB

Device Reference Point: 0, 0, -6.3 mm

**Cursor:**

ABM1 comp = -4.23 dBA/m

BWC Factor = 0.15 dB

Location: 0, 4.8, 3.7 mm

**Configuration/Scans/y (transversal) fine 3mm 6 x 42/ABM SNR(x,y,z)**

**(3x15x1):** Measurement grid: dx=10mm, dy=10mm

Signal Type: Audio File (.wav) 48k\_voice\_1kHz\_1s.wav

Output Gain: 35.93

Measure Window Start: 0ms

Measure Window Length: 1000ms

BWC applied: 0.15 dB

Device Reference Point: 0, 0, -6.3 mm

**Cursor:**

ABM1/ABM2 = 52.88 dB  
 ABM1 comp = -4.38 dBA/m  
 BWC Factor = 0.15 dB  
 Location: 0, -10.2, 3.7 mm

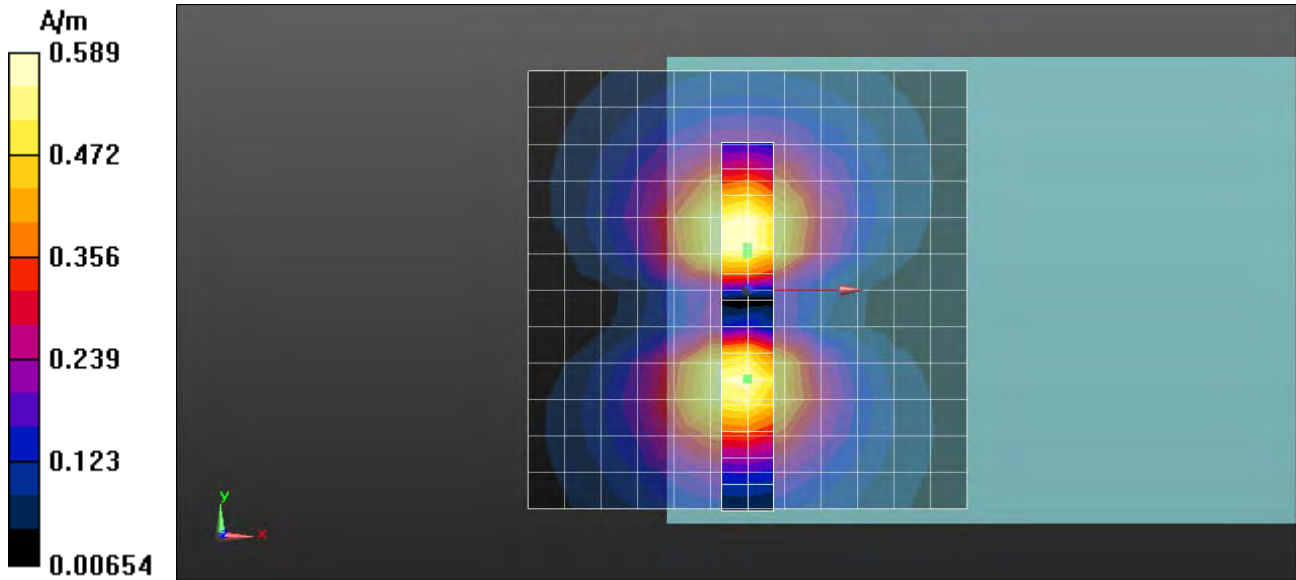

Test Laboratory: QuieTek-a DEKRA

Date/Time: 2016/06/13

**WCDMA Band 2 CH9400-Z**

**DUT: AC24G; Type: Mobile Phone**

Communication System: UID 0, FCC WCDMA\_Band-2; Frequency: 1880 MHz;

Communication System PAR: 0 dB

Medium parameters used:  $\sigma = 0$  S/m,  $\epsilon_r = 1$ ;  $\rho = 1$  kg/m<sup>3</sup>

Phantom section: TCoil Section

Ambient Temperature (°C) : 22.4, Humidity (%RH) : 53

Measurement Standard: DASYS (IEEE/IEC/ANSI C63.19-2011)

DASY5 Configuration:

- Probe: AM1DV2 - 1085; ; Calibrated: 2016/05/19
- Sensor-Surface: 0mm (Fix Surface)
- Electronics: DAE4 Sn1207; Calibrated: 2015/11/20
- Phantom: HAC Test Arch with AMCC; Type: SD HAC P01 BA;
- Measurement SW: DASYS2, Version 52.8 (8); SEMCAD X Version 14.6.10 (7331)

**Configuration/Scans/z (axial) 4.2mm 50 x 50/ABM Signal(x,y,z) (13x13x1):**

Measurement grid: dx=10mm, dy=10mm

Signal Type: Audio File (.wav) 48k\_voice\_1kHz\_1s.wav

Output Gain: 35.93

Measure Window Start: 0ms

Measure Window Length: 1000ms

BWC applied: 0.15 dB

Device Reference Point: 0, 0, -6.3 mm

**Cursor:**

ABM1 comp = 4.20 dBA/m

BWC Factor = 0.15 dB

Location: 0, -4.2, 3.7 mm

**Configuration/Scans/z (axial) fine 2mm 8 x 8/ABM Signal(x,y,z) (5x5x1):**

Measurement grid: dx=10mm, dy=10mm

Signal Type: Audio File (.wav) 48k\_voice\_1kHz\_1s.wav

Output Gain: 35.93

Measure Window Start: 0ms

Measure Window Length: 1000ms

BWC applied: 0.15 dB

Device Reference Point: 0, 0, -6.3 mm

**Cursor:**

ABM1 comp = 4.46 dBA/m

BWC Factor = 0.15 dB

Location: 0, -2.2, 3.7 mm

**Configuration/Scans/z (axial) fine 2mm 8 x 8/ABM SNR(x,y,z) (5x5x1):**

Measurement grid: dx=10mm, dy=10mm

Signal Type: Audio File (.wav) 48k\_voice\_1kHz\_1s.wav

Output Gain: 35.93

Measure Window Start: 0ms

Measure Window Length: 1000ms

BWC applied: 0.15 dB

Device Reference Point: 0, 0, -6.3 mm

**Cursor:**

ABM1/ABM2 = 56.29 dB  
 ABM1 comp = 2.62 dBA/m  
 BWC Factor = 0.15 dB  
 Location: -4, -0.2, 3.7 mm

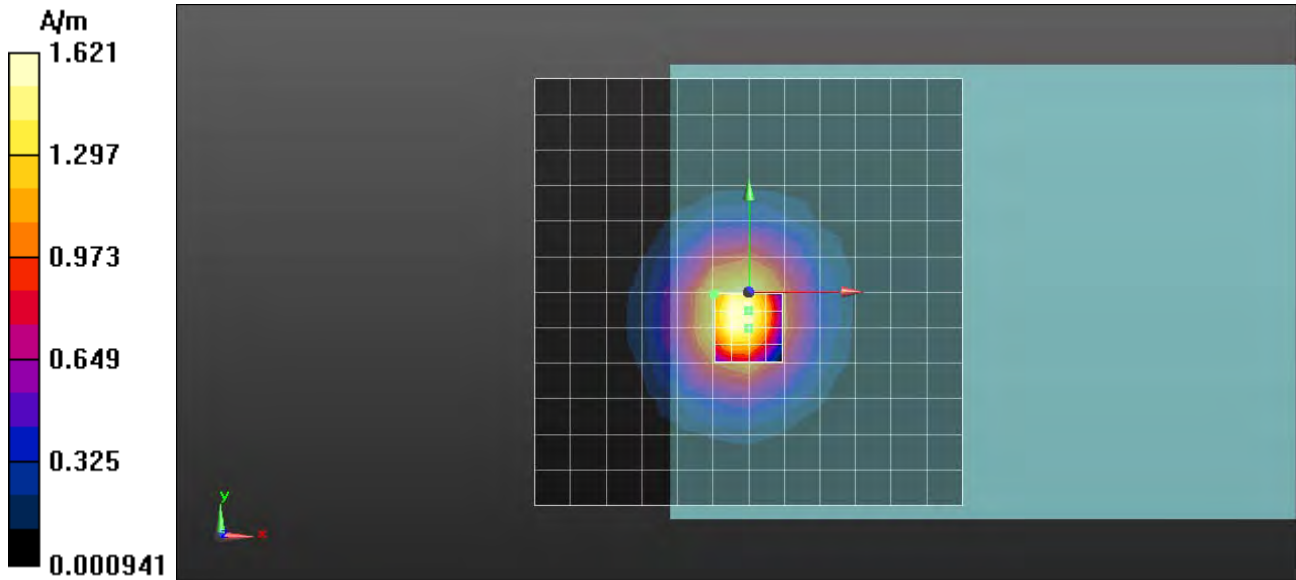

**T-Coil Z Axis plot**  
**Channel: 9400**

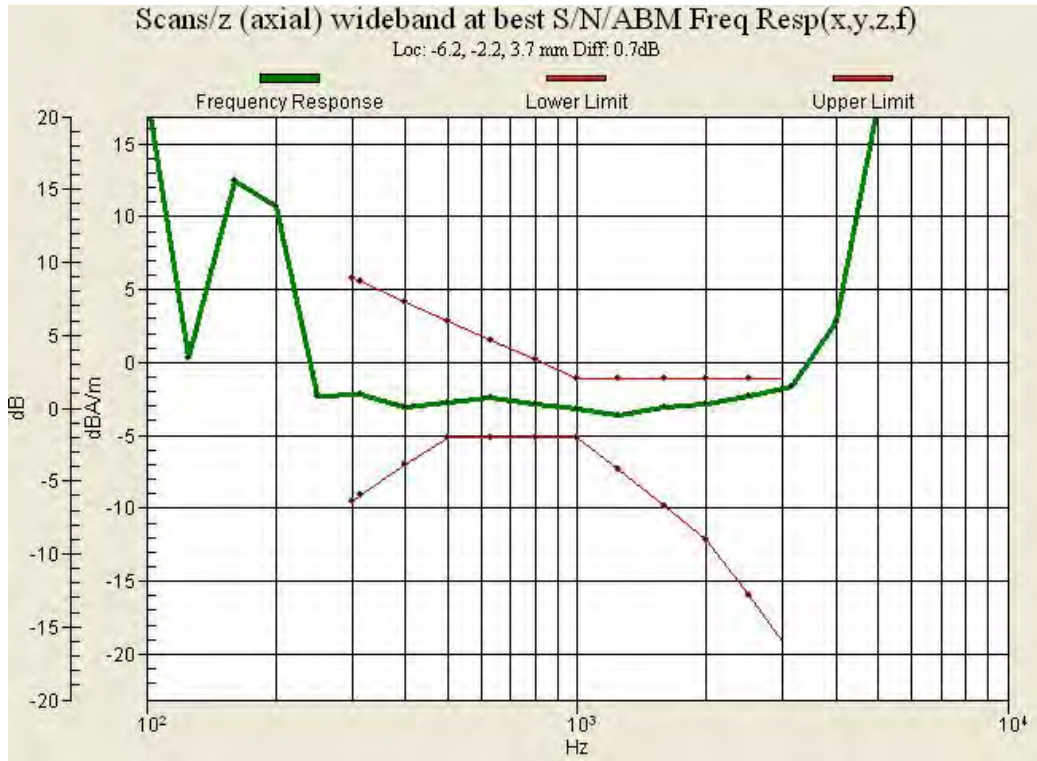

Test Laboratory: QuieTek-a DEKRA

Date/Time: 2016/06/13

**WCDMA Band 2 CH9538-X**

**DUT: AC24G; Type: Mobile Phone**

Communication System: UID 0, FCC WCDMA\_Band-2; Frequency: 1907.6 MHz;

Communication System PAR: 0 dB

Medium parameters used:  $\sigma = 0$  S/m,  $\epsilon_r = 1$ ;  $\rho = 1$  kg/m<sup>3</sup>

Phantom section: TCoil Section

Ambient Temperature (°C) : 22.4, Humidity (%RH) : 53

Measurement Standard: DASY5 (IEEE/IEC/ANSI C63.19-2011)

DASY5 Configuration:

- Probe: AM1DV2 - 1085; ; Calibrated: 2016/05/19
- Sensor-Surface: 0mm (Fix Surface)
- Electronics: DAE4 Sn1207; Calibrated: 2015/11/20
- Phantom: HAC Test Arch with AMCC; Type: SD HAC P01 BA;
- Measurement SW: DASY52, Version 52.8 (8); SEMCAD X Version 14.6.10 (7331)

**Configuration/Scans/x (longitudinal) 4.2mm 50 x 50/ABM Signal(x,y,z)**

**(13x13x1):** Measurement grid: dx=10mm, dy=10mm

Signal Type: Audio File (.wav) 48k\_voice\_1kHz\_1s.wav

Output Gain: 35.93

Measure Window Start: 0ms

Measure Window Length: 1000ms

BWC applied: 0.16 dB

Device Reference Point: 0, 0, -6.3 mm

**Cursor:**

ABM1 comp = -2.31 dBA/m

BWC Factor = 0.16 dB

Location: 4.2, 0, 3.7 mm

**Configuration/Scans/x (longitudinal) fine 3mm 42 x 6/ABM Signal(x,y,z)**

**(15x3x1):** Measurement grid: dx=10mm, dy=10mm

Signal Type: Audio File (.wav) 48k\_voice\_1kHz\_1s.wav

Output Gain: 35.93

Measure Window Start: 0ms

Measure Window Length: 1000ms

BWC applied: 0.16 dB

Device Reference Point: 0, 0, -6.3 mm

**Cursor:**

ABM1 comp = -2.61 dBA/m

BWC Factor = 0.16 dB

Location: 4.8, -4.2, 3.7 mm

**Configuration/Scans/x (longitudinal) fine 3mm 42 x 6/ABM SNR(x,y,z)**

**(15x3x1):** Measurement grid: dx=10mm, dy=10mm

Signal Type: Audio File (.wav) 48k\_voice\_1kHz\_1s.wav

Output Gain: 35.93

Measure Window Start: 0ms

Measure Window Length: 1000ms

BWC applied: 0.16 dB

Device Reference Point: 0, 0, -6.3 mm



**Cursor:**

ABM1/ABM2 = 52.37 dB  
 ABM1 comp = -3.63 dBA/m  
 BWC Factor = 0.16 dB  
 Location: 1.8, -4.2, 3.7 mm

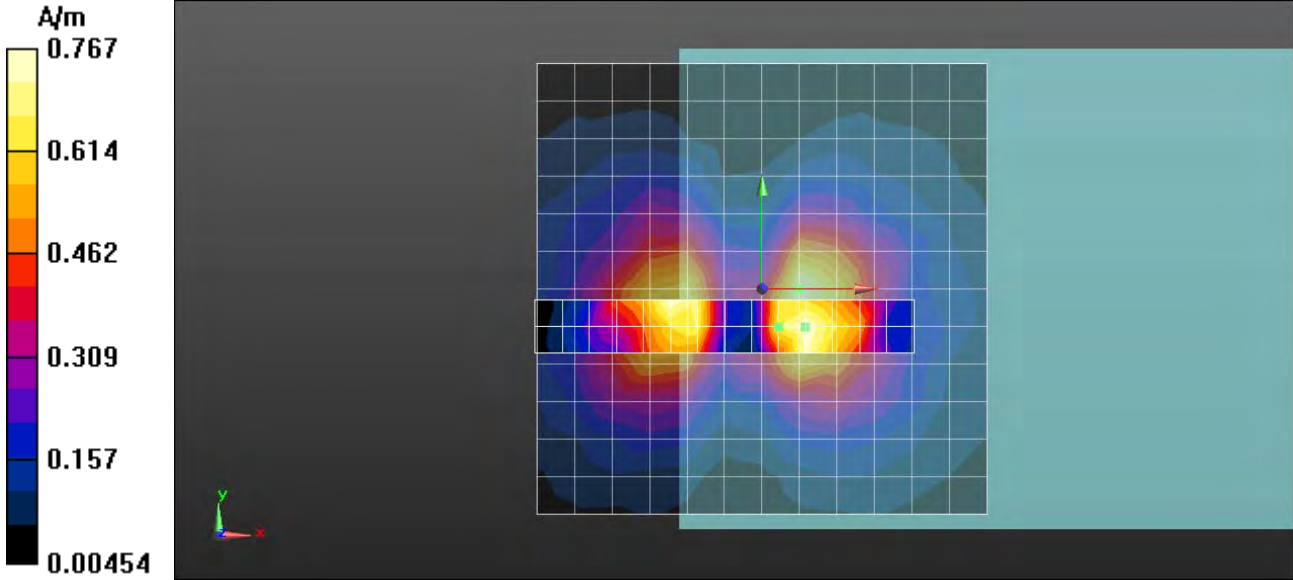

Test Laboratory: QuieTek-a DEKRA

Date/Time: 2016/06/13

**WCDMA Band 2 CH9538-Y**

**DUT: AC24G; Type: Mobile Phone**

Communication System: UID 0, FCC WCDMA\_Band-2; Frequency: 1907.6 MHz;

Communication System PAR: 0 dB

Medium parameters used:  $\sigma = 0$  S/m,  $\epsilon_r = 1$ ;  $\rho = 1$  kg/m<sup>3</sup>

Phantom section: TCoil Section

Ambient Temperature (°C) : 22.4, Humidity (%RH) : 53

Measurement Standard: DASYS (IEEE/IEC/ANSI C63.19-2011)

DASY5 Configuration:

- Probe: AM1DV2 - 1085; ; Calibrated: 2016/05/19
- Sensor-Surface: 0mm (Fix Surface)
- Electronics: DAE4 Sn1207; Calibrated: 2015/11/20
- Phantom: HAC Test Arch with AMCC; Type: SD HAC P01 BA;
- Measurement SW: DASYS2, Version 52.8 (8); SEMCAD X Version 14.6.10 (7331)

**Configuration/Scans/y (transversal) 4.2mm 50 x 50/ABM Signal(x,y,z)**

**(13x13x1):** Measurement grid: dx=10mm, dy=10mm

Signal Type: Audio File (.wav) 48k\_voice\_1kHz\_1s.wav

Output Gain: 35.93

Measure Window Start: 0ms

Measure Window Length: 1000ms

BWC applied: 0.16 dB

Device Reference Point: 0, 0, -6.3 mm

**Cursor:**

ABM1 comp = -3.53 dBA/m

BWC Factor = 0.16 dB

Location: -4.2, 4.2, 3.7 mm

**Configuration/Scans/y (transversal) fine 3mm 6 x 42/ABM Signal(x,y,z)**

**(3x15x1):** Measurement grid: dx=10mm, dy=10mm

Signal Type: Audio File (.wav) 48k\_voice\_1kHz\_1s.wav

Output Gain: 35.93

Measure Window Start: 0ms

Measure Window Length: 1000ms

BWC applied: 0.16 dB

Device Reference Point: 0, 0, -6.3 mm

**Cursor:**

ABM1 comp = -2.74 dBA/m

BWC Factor = 0.16 dB

Location: -1.2, 4.8, 3.7 mm

**Configuration/Scans/y (transversal) fine 3mm 6 x 42/ABM SNR(x,y,z)**

**(3x15x1):** Measurement grid: dx=10mm, dy=10mm

Signal Type: Audio File (.wav) 48k\_voice\_1kHz\_1s.wav

Output Gain: 35.93

Measure Window Start: 0ms

Measure Window Length: 1000ms

BWC applied: 0.16 dB

Device Reference Point: 0, 0, -6.3 mm

**Cursor:**

ABM1/ABM2 = 52.65 dB

ABM1 comp = -3.26 dBA/m

BWC Factor = 0.16 dB

Location: -1.2, -10.2, 3.7 mm

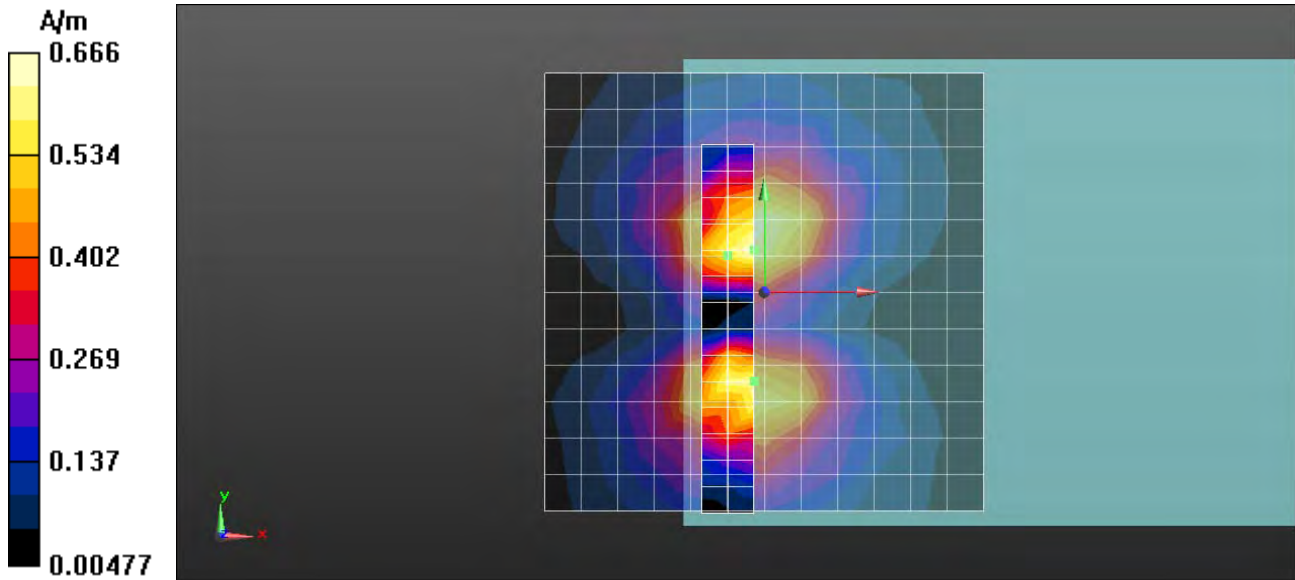

Test Laboratory: QuieTek-a DEKRA

Date/Time: 2016/06/13

**WCDMA Band 2 CH9538-Z**

**DUT: AC24G; Type: Mobile Phone**

Communication System: UID 0, FCC WCDMA\_Band-2; Frequency: 1907.6 MHz;

Communication System PAR: 0 dB

Medium parameters used:  $\sigma = 0$  S/m,  $\epsilon_r = 1$ ;  $\rho = 1$  kg/m<sup>3</sup>

Phantom section: TCoil Section

Ambient Temperature (°C) : 22.4, Humidity (%RH) : 53

Measurement Standard: DASYS (IEEE/IEC/ANSI C63.19-2011)

DASY5 Configuration:

- Probe: AM1DV2 - 1085; ; Calibrated: 2016/05/19
- Sensor-Surface: 0mm (Fix Surface)
- Electronics: DAE4 Sn1207; Calibrated: 2015/11/20
- Phantom: HAC Test Arch with AMCC; Type: SD HAC P01 BA;
- Measurement SW: DASYS2, Version 52.8 (8); SEMCAD X Version 14.6.10 (7331)

**Configuration/Scans/z (axial) 4.2mm 50 x 50/ABM Signal(x,y,z) (13x13x1):**

Measurement grid: dx=10mm, dy=10mm

Signal Type: Audio File (.wav) 48k\_voice\_1kHz\_1s.wav

Output Gain: 35.93

Measure Window Start: 0ms

Measure Window Length: 1000ms

BWC applied: 0.16 dB

Device Reference Point: 0, 0, -6.3 mm

**Cursor:**

ABM1 comp = 4.45 dBA/m

BWC Factor = 0.16 dB

Location: -4.2, -4.2, 3.7 mm

**Configuration/Scans/z (axial) fine 2mm 8 x 8/ABM Signal(x,y,z) (5x5x1):**

Measurement grid: dx=10mm, dy=10mm

Signal Type: Audio File (.wav) 48k\_voice\_1kHz\_1s.wav

Output Gain: 35.93

Measure Window Start: 0ms

Measure Window Length: 1000ms

BWC applied: 0.16 dB

Device Reference Point: 0, 0, -6.3 mm

**Cursor:**

ABM1 comp = 5.29 dBA/m

BWC Factor = 0.16 dB

Location: -2.2, -0.2, 3.7 mm

**Configuration/Scans/z (axial) fine 2mm 8 x 8/ABM SNR(x,y,z) (5x5x1):**

Measurement grid: dx=10mm, dy=10mm

Signal Type: Audio File (.wav) 48k\_voice\_1kHz\_1s.wav

Output Gain: 35.93

Measure Window Start: 0ms

Measure Window Length: 1000ms

BWC applied: 0.16 dB

Device Reference Point: 0, 0, -6.3 mm

**Cursor:**

ABM1/ABM2 = 54.56 dB  
 ABM1 comp = 2.36 dBA/m  
 BWC Factor = 0.16 dB  
 Location: -6.2, -2.2, 3.7 mm

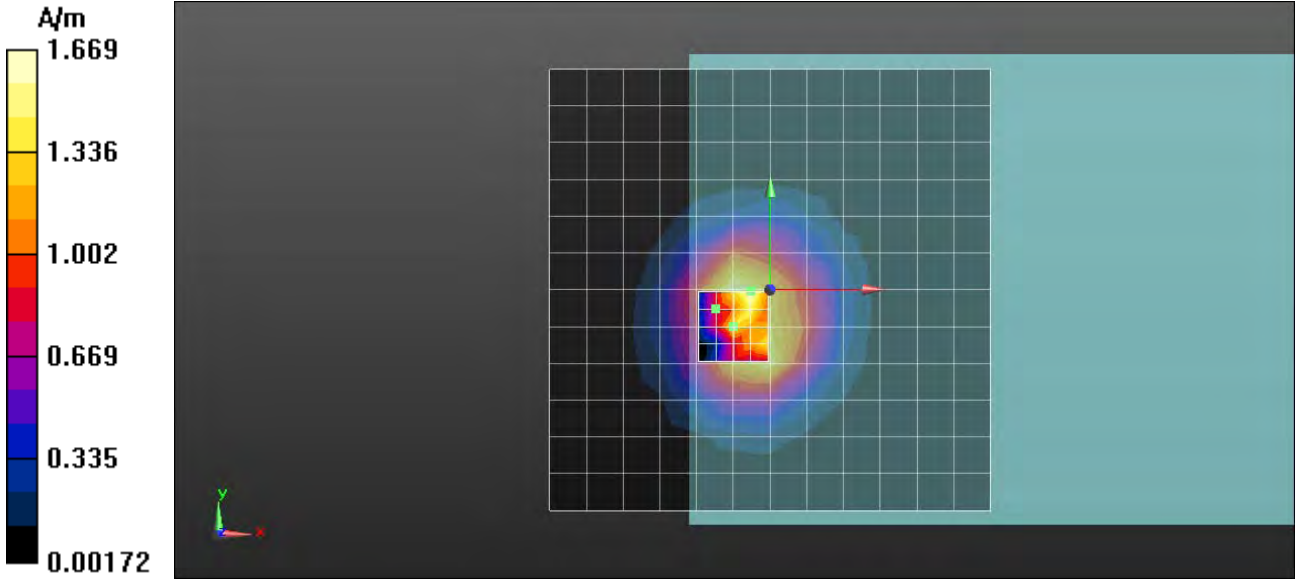

**T-Coil Z Axis plot**  
**Channel: 9538**

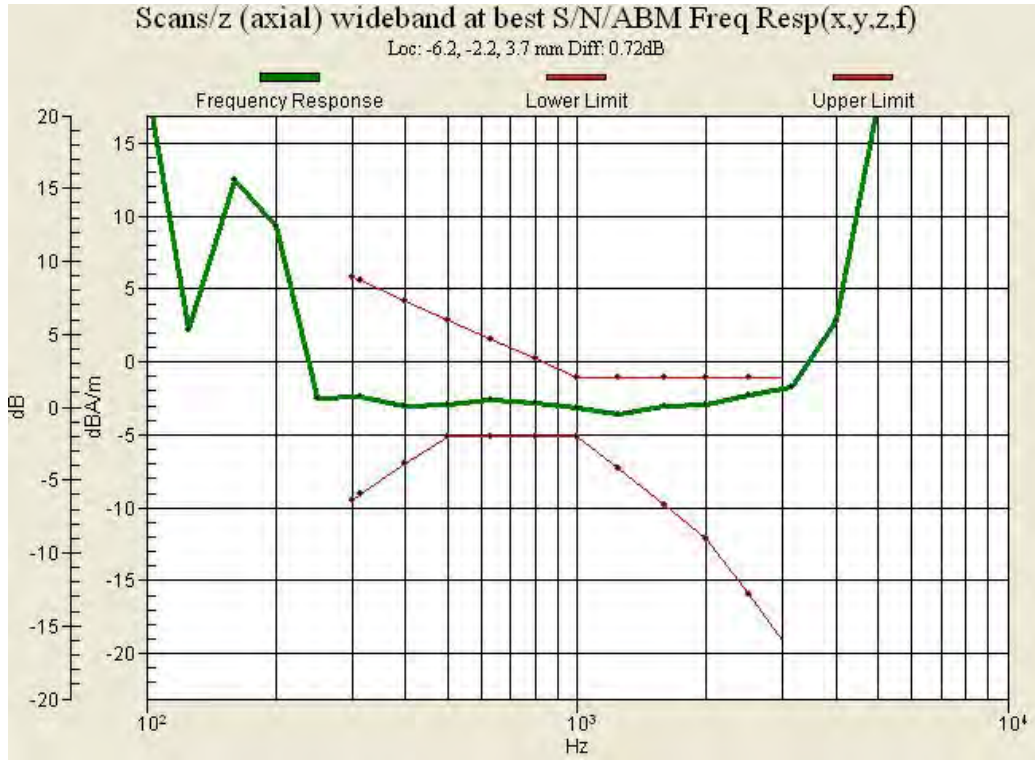

Test Laboratory: QuieTek-a DEKRA

Date/Time: 2016/06/13

**WCDMA Band 5 CH4132-X**

**DUT: AC24G; Type: Mobile Phone**

Communication System: UID 0, FCC WCDMA\_Band-5; Frequency: 826.4 MHz;

Communication System PAR: 0 dB

Medium parameters used:  $\sigma = 0$  S/m,  $\epsilon_r = 1$ ;  $\rho = 1$  kg/m<sup>3</sup>

Phantom section: TCoil Section

Ambient Temperature (°C) : 22.4, Humidity (%RH) : 53

Measurement Standard: DASYS (IEEE/IEC/ANSI C63.19-2011)

DASY5 Configuration:

- Probe: AM1DV2 - 1085; ; Calibrated: 2016/05/19
- Sensor-Surface: 0mm (Fix Surface)
- Electronics: DAE4 Sn1207; Calibrated: 2015/11/20
- Phantom: HAC Test Arch with AMCC; Type: SD HAC P01 BA;
- Measurement SW: DASYS2, Version 52.8 (8); SEMCAD X Version 14.6.10 (7331)

**Configuration/Scans/x (longitudinal) 4.2mm 50 x 50/ABM Signal(x,y,z)**

**(13x13x1):** Measurement grid: dx=10mm, dy=10mm

Signal Type: Audio File (.wav) 48k\_voice\_1kHz\_1s.wav

Output Gain: 35.93

Measure Window Start: 0ms

Measure Window Length: 1000ms

BWC applied: 0.16 dB

Device Reference Point: 0, 0, -6.3 mm

**Cursor:**

ABM1 comp = -3.06 dBA/m

BWC Factor = 0.16 dB

Location: -8.3, -4.2, 3.7 mm

**Configuration/Scans/x (longitudinal) fine 3mm 42 x 6/ABM Signal(x,y,z)**

**(15x3x1):** Measurement grid: dx=10mm, dy=10mm

Signal Type: Audio File (.wav) 48k\_voice\_1kHz\_1s.wav

Output Gain: 35.93

Measure Window Start: 0ms

Measure Window Length: 1000ms

BWC applied: 0.16 dB

Device Reference Point: 0, 0, -6.3 mm

**Cursor:**

ABM1 comp = -3.45 dBA/m

BWC Factor = 0.16 dB

Location: 6, -1.2, 3.7 mm

**Configuration/Scans/x (longitudinal) fine 3mm 42 x 6/ABM SNR(x,y,z)**

**(15x3x1):** Measurement grid: dx=10mm, dy=10mm

Signal Type: Audio File (.wav) 48k\_voice\_1kHz\_1s.wav

Output Gain: 35.93

Measure Window Start: 0ms

Measure Window Length: 1000ms

BWC applied: 0.16 dB

Device Reference Point: 0, 0, -6.3 mm



**Cursor:**

ABM1/ABM2 = 51.46 dB  
ABM1 comp = -4.62 dBA/m  
BWC Factor = 0.16 dB  
Location: -12, -4.2, 3.7 mm

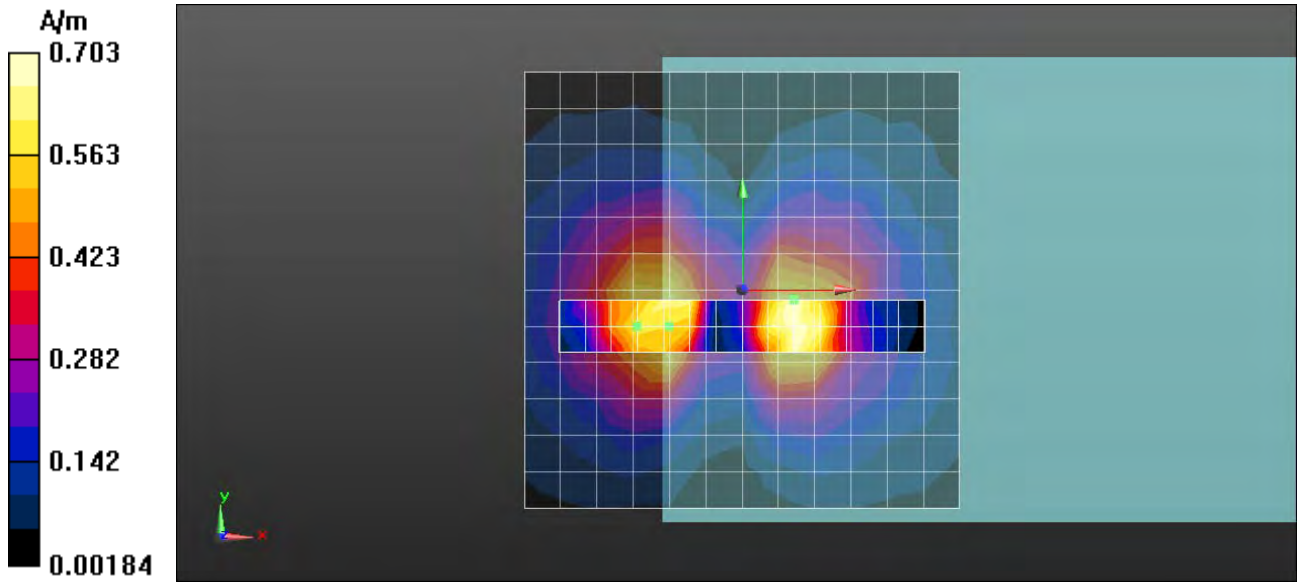

Test Laboratory: QuieTek-a DEKRA

Date/Time: 2016/06/13

**WCDMA Band 5 CH4132-Y**

**DUT: AC24G; Type: Mobile Phone**

Communication System: UID 0, FCC WCDMA\_Band-5; Frequency: 826.4 MHz;

Communication System PAR: 0 dB

Medium parameters used:  $\sigma = 0$  S/m,  $\epsilon_r = 1$ ;  $\rho = 1$  kg/m<sup>3</sup>

Phantom section: TCoil Section

Ambient Temperature (°C) : 22.4, Humidity (%RH) : 53

Measurement Standard: DASYS (IEEE/IEC/ANSI C63.19-2011)

DASY5 Configuration:

- Probe: AM1DV2 - 1085; ; Calibrated: 2016/05/19
- Sensor-Surface: 0mm (Fix Surface)
- Electronics: DAE4 Sn1207; Calibrated: 2015/11/20
- Phantom: HAC Test Arch with AMCC; Type: SD HAC P01 BA;
- Measurement SW: DASYS2, Version 52.8 (8); SEMCAD X Version 14.6.10 (7331)

**Configuration/Scans/y (transversal) 4.2mm 50 x 50/ABM Signal(x,y,z)**

**(13x13x1):** Measurement grid: dx=10mm, dy=10mm

Signal Type: Audio File (.wav) 48k\_voice\_1kHz\_1s.wav

Output Gain: 35.93

Measure Window Start: 0ms

Measure Window Length: 1000ms

BWC applied: 0.16 dB

Device Reference Point: 0, 0, -6.3 mm

**Cursor:**

ABM1 comp = -3.52 dBA/m

BWC Factor = 0.16 dB

Location: 0, 4.2, 3.7 mm

**Configuration/Scans/y (transversal) fine 3mm 6 x 42/ABM Signal(x,y,z)**

**(3x15x1):** Measurement grid: dx=10mm, dy=10mm

Signal Type: Audio File (.wav) 48k\_voice\_1kHz\_1s.wav

Output Gain: 35.93

Measure Window Start: 0ms

Measure Window Length: 1000ms

BWC applied: 0.16 dB

Device Reference Point: 0, 0, -6.3 mm

**Cursor:**

ABM1 comp = -3.55 dBA/m

BWC Factor = 0.16 dB

Location: 0, -10.2, 3.7 mm

**Configuration/Scans/y (transversal) fine 3mm 6 x 42/ABM SNR(x,y,z)**

**(3x15x1):** Measurement grid: dx=10mm, dy=10mm

Signal Type: Audio File (.wav) 48k\_voice\_1kHz\_1s.wav

Output Gain: 35.93

Measure Window Start: 0ms

Measure Window Length: 1000ms

BWC applied: 0.16 dB

Device Reference Point: 0, 0, -6.3 mm

**Cursor:**

ABM1/ABM2 = 52.73 dB  
 ABM1 comp = -3.55 dBA/m  
 BWC Factor = 0.16 dB  
 Location: 0, -10.2, 3.7 mm

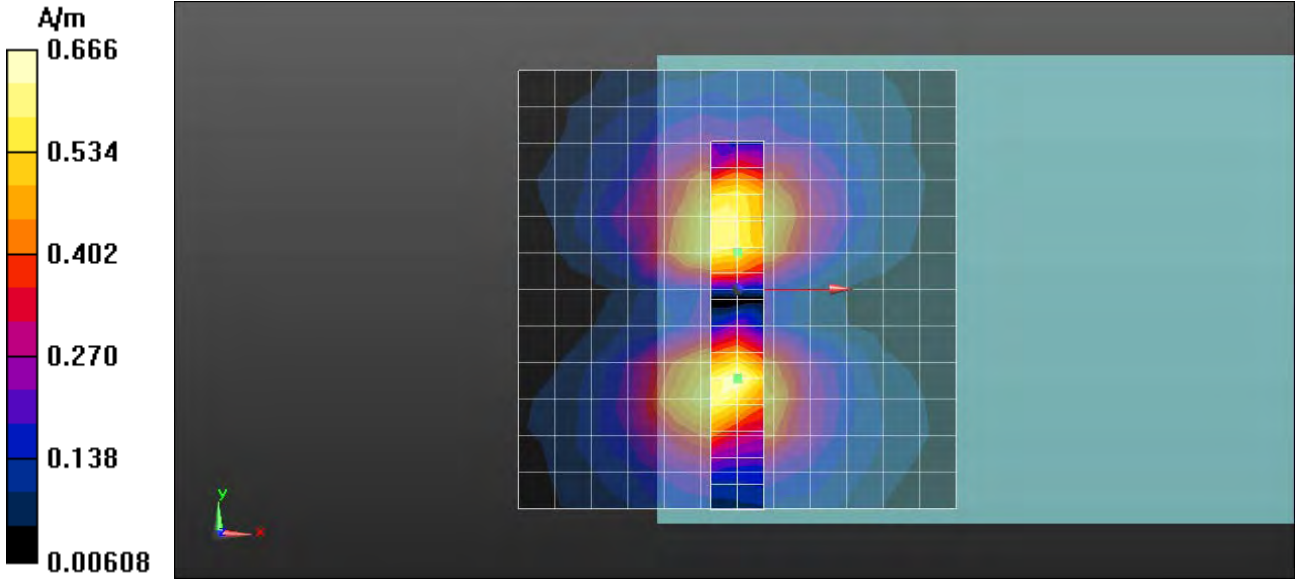

Test Laboratory: QuieTek-a DEKRA

Date/Time: 2016/06/13

**WCDMA Band 5 CH4132-Z**

**DUT: AC24G; Type: Mobile Phone**

Communication System: UID 0, FCC WCDMA\_Band-5; Frequency: 826.4 MHz;

Communication System PAR: 0 dB

Medium parameters used:  $\sigma = 0$  S/m,  $\epsilon_r = 1$ ;  $\rho = 1$  kg/m<sup>3</sup>

Phantom section: TCoil Section

Ambient Temperature (°C) : 22.4, Humidity (%RH) : 53

Measurement Standard: DASYS (IEEE/IEC/ANSI C63.19-2011)

DASY5 Configuration:

- Probe: AM1DV2 - 1085; ; Calibrated: 2016/05/19
- Sensor-Surface: 0mm (Fix Surface)
- Electronics: DAE4 Sn1207; Calibrated: 2015/11/20
- Phantom: HAC Test Arch with AMCC; Type: SD HAC P01 BA;
- Measurement SW: DASYS2, Version 52.8 (8); SEMCAD X Version 14.6.10 (7331)

**Configuration/Scans/z (axial) 4.2mm 50 x 50/ABM Signal(x,y,z) (13x13x1):**

Measurement grid: dx=10mm, dy=10mm

Signal Type: Audio File (.wav) 48k\_voice\_1kHz\_1s.wav

Output Gain: 35.93

Measure Window Start: 0ms

Measure Window Length: 1000ms

BWC applied: 0.16 dB

Device Reference Point: 0, 0, -6.3 mm

**Cursor:**

ABM1 comp = 4.96 dBA/m

BWC Factor = 0.16 dB

Location: 0, -4.2, 3.7 mm

**Configuration/Scans/z (axial) fine 2mm 8 x 8/ABM Signal(x,y,z) (5x5x1):**

Measurement grid: dx=10mm, dy=10mm

Signal Type: Audio File (.wav) 48k\_voice\_1kHz\_1s.wav

Output Gain: 35.93

Measure Window Start: 0ms

Measure Window Length: 1000ms

BWC applied: 0.16 dB

Device Reference Point: 0, 0, -6.3 mm

**Cursor:**

ABM1 comp = 4.41 dBA/m

BWC Factor = 0.16 dB

Location: -2, -0.2, 3.7 mm

**Configuration/Scans/z (axial) fine 2mm 8 x 8/ABM SNR(x,y,z) (5x5x1):**

Measurement grid: dx=10mm, dy=10mm

Signal Type: Audio File (.wav) 48k\_voice\_1kHz\_1s.wav

Output Gain: 35.93

Measure Window Start: 0ms

Measure Window Length: 1000ms

BWC applied: 0.16 dB

Device Reference Point: 0, 0, -6.3 mm

**Cursor:**

ABM1/ABM2 = 55.34 dB  
 ABM1 comp = 3.08 dBA/m  
 BWC Factor = 0.16 dB  
 Location: -2, -8.2, 3.7 mm

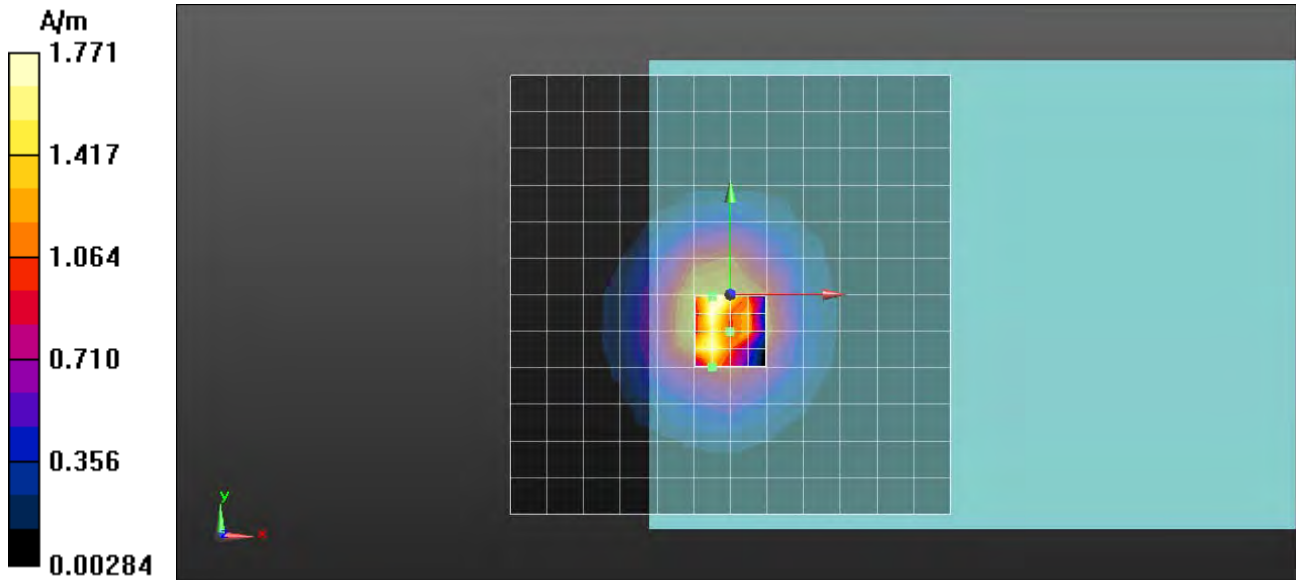

**T-Coil Z Axis plot**  
**Channel: 4132**

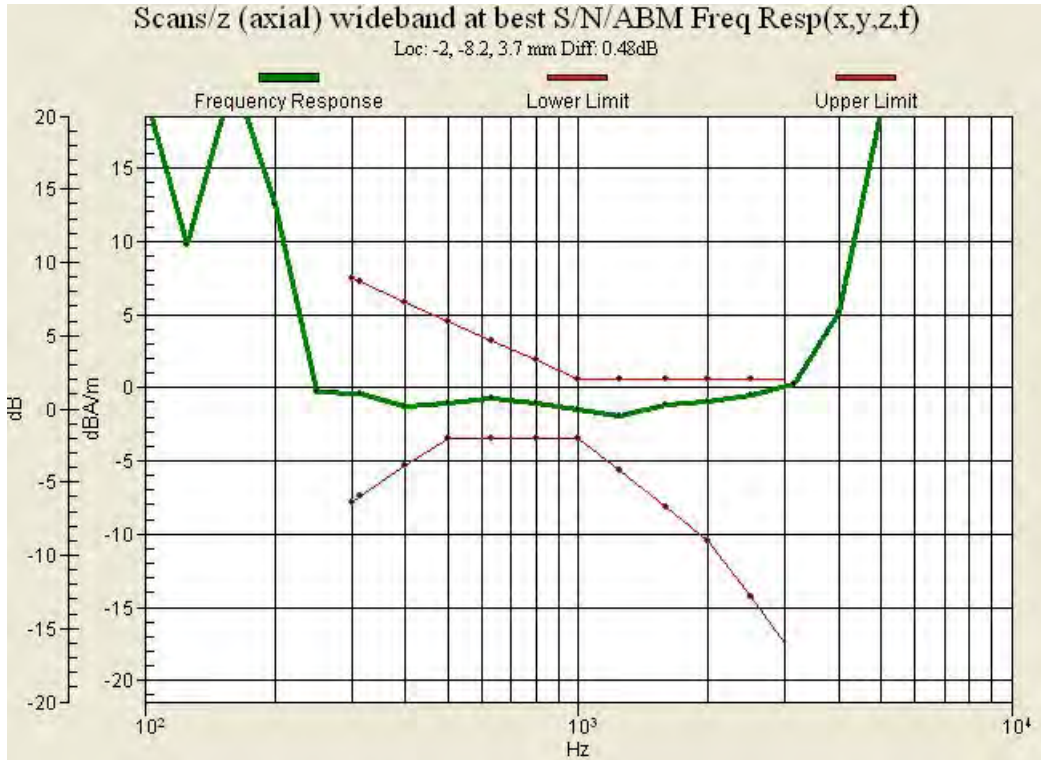

Test Laboratory: QuieTek-a DEKRA

Date/Time: 2016/06/13

**WCDMA Band 5 CH4183-X**

**DUT: AC24G; Type: Mobile Phone**

Communication System: UID 0, FCC WCDMA\_Band-5; Frequency: 836.6 MHz;

Communication System PAR: 0 dB

Medium parameters used:  $\sigma = 0$  S/m,  $\epsilon_r = 1$ ;  $\rho = 1$  kg/m<sup>3</sup>

Phantom section: TCoil Section

Ambient Temperature (°C) : 22.4, Humidity (%RH) : 53

Measurement Standard: DASYS (IEEE/IEC/ANSI C63.19-2011)

DASY5 Configuration:

- Probe: AM1DV2 - 1085; ; Calibrated: 2016/05/19
- Sensor-Surface: 0mm (Fix Surface)
- Electronics: DAE4 Sn1207; Calibrated: 2015/11/20
- Phantom: HAC Test Arch with AMCC; Type: SD HAC P01 BA;
- Measurement SW: DASYS2, Version 52.8 (8); SEMCAD X Version 14.6.10 (7331)

**Configuration/Scans/x (longitudinal) 4.2mm 50 x 50/ABM Signal(x,y,z)**

**(13x13x1):** Measurement grid: dx=10mm, dy=10mm

Signal Type: Audio File (.wav) 48k\_voice\_1kHz\_1s.wav

Output Gain: 35.93

Measure Window Start: 0ms

Measure Window Length: 1000ms

BWC applied: 0.16 dB

Device Reference Point: 0, 0, -6.3 mm

**Cursor:**

ABM1 comp = -3.41 dBA/m

BWC Factor = 0.16 dB

Location: -8.3, -4.2, 3.7 mm

**Configuration/Scans/x (longitudinal) fine 3mm 42 x 6/ABM Signal(x,y,z)**

**(15x3x1):** Measurement grid: dx=10mm, dy=10mm

Signal Type: Audio File (.wav) 48k\_voice\_1kHz\_1s.wav

Output Gain: 35.93

Measure Window Start: 0ms

Measure Window Length: 1000ms

BWC applied: 0.16 dB

Device Reference Point: 0, 0, -6.3 mm

**Cursor:**

ABM1 comp = -2.07 dBA/m

BWC Factor = 0.16 dB

Location: 6, -4.2, 3.7 mm

**Configuration/Scans/x (longitudinal) fine 3mm 42 x 6/ABM SNR(x,y,z)**

**(15x3x1):** Measurement grid: dx=10mm, dy=10mm

Signal Type: Audio File (.wav) 48k\_voice\_1kHz\_1s.wav

Output Gain: 35.93

Measure Window Start: 0ms

Measure Window Length: 1000ms

BWC applied: 0.16 dB

Device Reference Point: 0, 0, -6.3 mm



**Cursor:**

ABM1/ABM2 = 52.64 dB  
ABM1 comp = -2.07 dBA/m  
BWC Factor = 0.16 dB  
Location: 6, -4.2, 3.7 mm

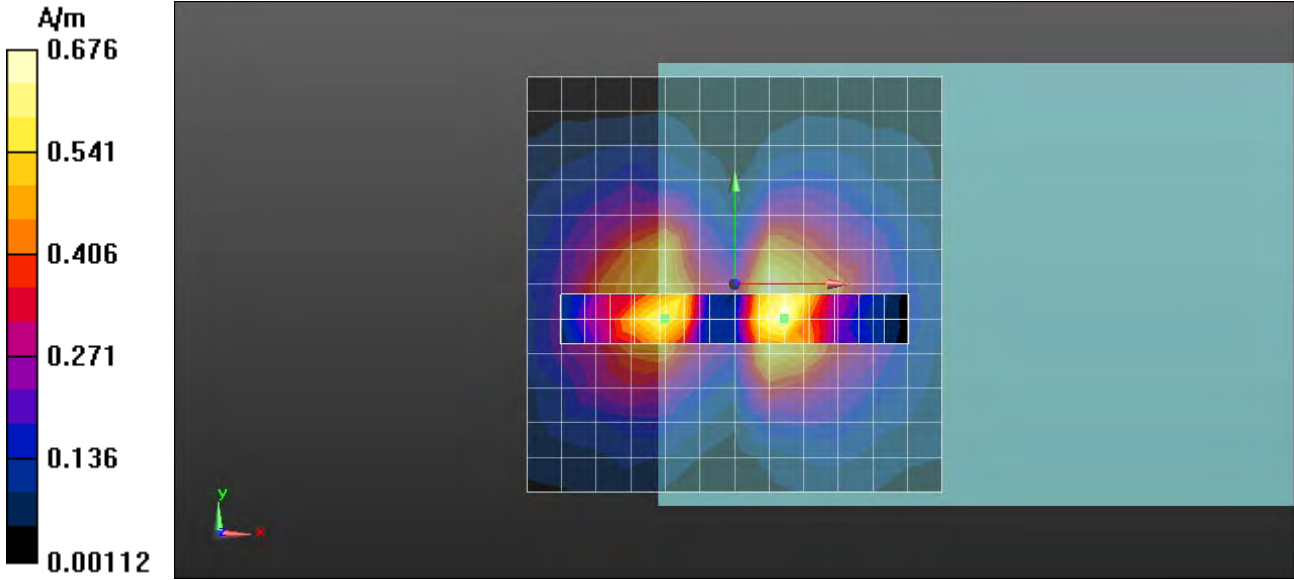

Test Laboratory: QuieTek-a DEKRA

Date/Time: 2016/06/13

**WCDMA Band 5 CH4183-Y**

**DUT: AC24G; Type: Mobile Phone**

Communication System: UID 0, FCC WCDMA\_Band-5; Frequency: 836.6 MHz;

Communication System PAR: 0 dB

Medium parameters used:  $\sigma = 0$  S/m,  $\epsilon_r = 1$ ;  $\rho = 1$  kg/m<sup>3</sup>

Phantom section: TCoil Section

Ambient Temperature (°C) : 22.4, Humidity (%RH) : 53

Measurement Standard: DASYS (IEEE/IEC/ANSI C63.19-2011)

DASY5 Configuration:

- Probe: AM1DV2 - 1085; ; Calibrated: 2016/05/19
- Sensor-Surface: 0mm (Fix Surface)
- Electronics: DAE4 Sn1207; Calibrated: 2015/11/20
- Phantom: HAC Test Arch with AMCC; Type: SD HAC P01 BA;
- Measurement SW: DASYS2, Version 52.8 (8); SEMCAD X Version 14.6.10 (7331)

**Configuration/Scans/y (transversal) 4.2mm 50 x 50/ABM Signal(x,y,z)**

**(13x13x1):** Measurement grid: dx=10mm, dy=10mm

Signal Type: Audio File (.wav) 48k\_voice\_1kHz\_1s.wav

Output Gain: 35.93

Measure Window Start: 0ms

Measure Window Length: 1000ms

BWC applied: 0.16 dB

Device Reference Point: 0, 0, -6.3 mm

**Cursor:**

ABM1 comp = -3.36 dBA/m

BWC Factor = 0.16 dB

Location: 0, 8.3, 3.7 mm

**Configuration/Scans/y (transversal) fine 3mm 6 x 42/ABM Signal(x,y,z)**

**(3x15x1):** Measurement grid: dx=10mm, dy=10mm

Signal Type: Audio File (.wav) 48k\_voice\_1kHz\_1s.wav

Output Gain: 35.93

Measure Window Start: 0ms

Measure Window Length: 1000ms

BWC applied: 0.16 dB

Device Reference Point: 0, 0, -6.3 mm

**Cursor:**

ABM1 comp = -3.00 dBA/m

BWC Factor = 0.16 dB

Location: 0, 7.8, 3.7 mm

**Configuration/Scans/y (transversal) fine 3mm 6 x 42/ABM SNR(x,y,z)**

**(3x15x1):** Measurement grid: dx=10mm, dy=10mm

Signal Type: Audio File (.wav) 48k\_voice\_1kHz\_1s.wav

Output Gain: 35.93

Measure Window Start: 0ms

Measure Window Length: 1000ms

BWC applied: 0.16 dB

Device Reference Point: 0, 0, -6.3 mm

**Cursor:**

ABM1/ABM2 = 53.19 dB  
ABM1 comp = -3.00 dBA/m  
BWC Factor = 0.16 dB  
Location: 0, 7.8, 3.7 mm

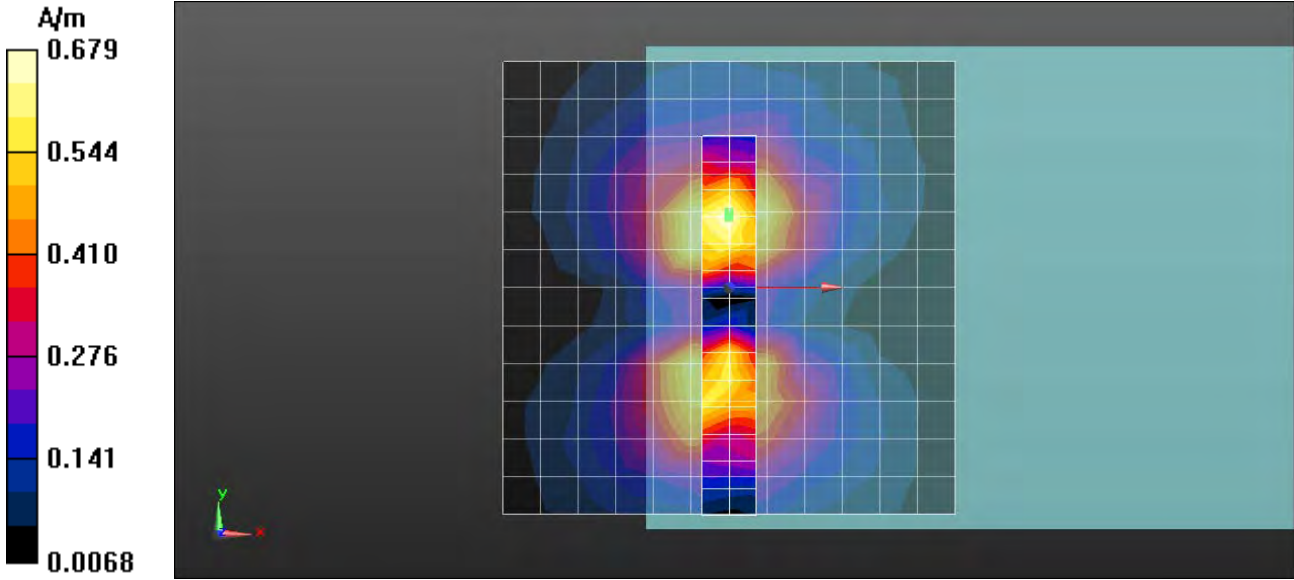

Test Laboratory: QuieTek-a DEKRA

Date/Time: 2016/06/13

**WCDMA Band 5 CH4183-Z**

**DUT: AC24G; Type: Mobile Phone**

Communication System: UID 0, FCC WCDMA\_Band-5; Frequency: 836.6 MHz;

Communication System PAR: 0 dB

Medium parameters used:  $\sigma = 0$  S/m,  $\epsilon_r = 1$ ;  $\rho = 1$  kg/m<sup>3</sup>

Phantom section: TCoil Section

Ambient Temperature (°C) : 22.4, Humidity (%RH) : 53

Measurement Standard: DASYS (IEEE/IEC/ANSI C63.19-2011)

DASY5 Configuration:

- Probe: AM1DV2 - 1085; ; Calibrated: 2016/05/19
- Sensor-Surface: 0mm (Fix Surface)
- Electronics: DAE4 Sn1207; Calibrated: 2015/11/20
- Phantom: HAC Test Arch with AMCC; Type: SD HAC P01 BA;
- Measurement SW: DASYS2, Version 52.8 (8); SEMCAD X Version 14.6.10 (7331)

**Configuration/Scans/z (axial) 4.2mm 50 x 50/ABM Signal(x,y,z) (13x13x1):**

Measurement grid: dx=10mm, dy=10mm

Signal Type: Audio File (.wav) 48k\_voice\_1kHz\_1s.wav

Output Gain: 35.93

Measure Window Start: 0ms

Measure Window Length: 1000ms

BWC applied: 0.16 dB

Device Reference Point: 0, 0, -6.3 mm

**Cursor:**

ABM1 comp = 4.60 dBA/m

BWC Factor = 0.16 dB

Location: 0, -4.2, 3.7 mm

**Configuration/Scans/z (axial) fine 2mm 8 x 8/ABM Signal(x,y,z) (5x5x1):**

Measurement grid: dx=10mm, dy=10mm

Signal Type: Audio File (.wav) 48k\_voice\_1kHz\_1s.wav

Output Gain: 35.93

Measure Window Start: 0ms

Measure Window Length: 1000ms

BWC applied: 0.16 dB

Device Reference Point: 0, 0, -6.3 mm

**Cursor:**

ABM1 comp = 5.96 dBA/m

BWC Factor = 0.16 dB

Location: 0, -2.2, 3.7 mm

**Configuration/Scans/z (axial) fine 2mm 8 x 8/ABM SNR(x,y,z) (5x5x1):**

Measurement grid: dx=10mm, dy=10mm

Signal Type: Audio File (.wav) 48k\_voice\_1kHz\_1s.wav

Output Gain: 35.93

Measure Window Start: 0ms

Measure Window Length: 1000ms

BWC applied: 0.16 dB

Device Reference Point: 0, 0, -6.3 mm

**Cursor:**

ABM1/ABM2 = 55.07 dB  
 ABM1 comp = 5.08 dBA/m  
 BWC Factor = 0.16 dB  
 Location: -2, -4.2, 3.7 mm

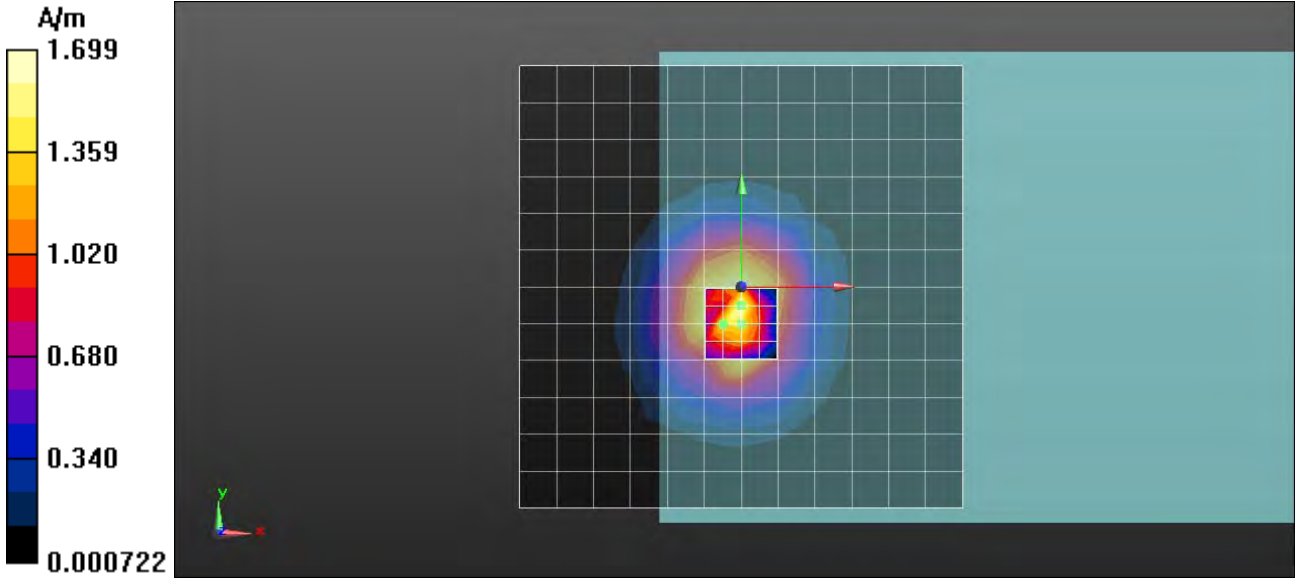

**T-Coil Z Axis plot**  
**Channel: 4183**

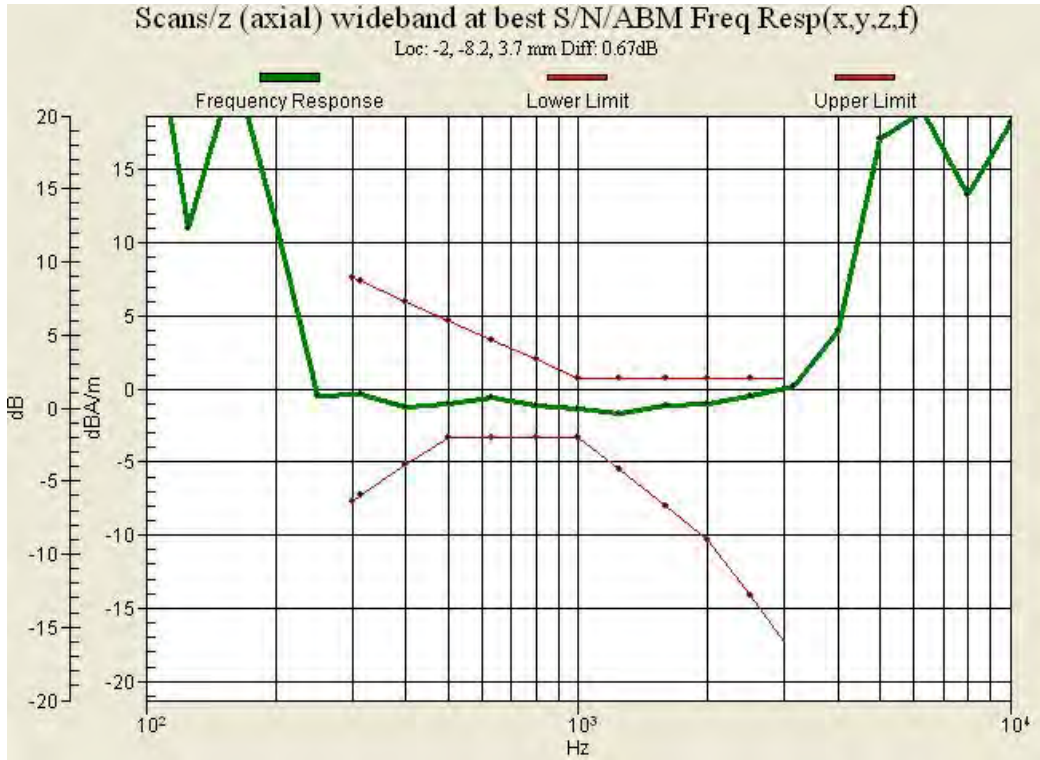

Test Laboratory: QuieTek-a DEKRA

Date/Time: 2016/06/13

**WCDMA Band 5 CH4233-X**

**DUT: AC24G; Type: Mobile Phone**

Communication System: UID 0, FCC WCDMA\_Band-5; Frequency: 846.6 MHz;

Communication System PAR: 0 dB

Medium parameters used:  $\sigma = 0$  S/m,  $\epsilon_r = 1$ ;  $\rho = 1$  kg/m<sup>3</sup>

Phantom section: TCoil Section

Ambient Temperature (°C) : 22.4, Humidity (%RH) : 53

Measurement Standard: DASYS (IEEE/IEC/ANSI C63.19-2011)

DASY5 Configuration:

- Probe: AM1DV2 - 1085; ; Calibrated: 2016/05/19
- Sensor-Surface: 0mm (Fix Surface)
- Electronics: DAE4 Sn1207; Calibrated: 2015/11/20
- Phantom: HAC Test Arch with AMCC; Type: SD HAC P01 BA;
- Measurement SW: DASYS2, Version 52.8 (8); SEMCAD X Version 14.6.10 (7331)

**Configuration/Scans/x (longitudinal) 4.2mm 50 x 50/ABM Signal(x,y,z)**

**(13x13x1):** Measurement grid: dx=10mm, dy=10mm

Signal Type: Audio File (.wav) 48k\_voice\_1kHz\_1s.wav

Output Gain: 35.93

Measure Window Start: 0ms

Measure Window Length: 1000ms

BWC applied: 0.15 dB

Device Reference Point: 0, 0, -6.3 mm

**Cursor:**

ABM1 comp = -3.16 dBA/m

BWC Factor = 0.15 dB

Location: -8.3, -4.2, 3.7 mm

**Configuration/Scans/x (longitudinal) fine 3mm 42 x 6/ABM Signal(x,y,z)**

**(15x3x1):** Measurement grid: dx=10mm, dy=10mm

Signal Type: Audio File (.wav) 48k\_voice\_1kHz\_1s.wav

Output Gain: 35.93

Measure Window Start: 0ms

Measure Window Length: 1000ms

BWC applied: 0.15 dB

Device Reference Point: 0, 0, -6.3 mm

**Cursor:**

ABM1 comp = -2.48 dBA/m

BWC Factor = 0.15 dB

Location: 6, -3, 3.7 mm

**Configuration/Scans/x (longitudinal) fine 3mm 42 x 6/ABM SNR(x,y,z)**

**(15x3x1):** Measurement grid: dx=10mm, dy=10mm

Signal Type: Audio File (.wav) 48k\_voice\_1kHz\_1s.wav

Output Gain: 35.93

Measure Window Start: 0ms

Measure Window Length: 1000ms

BWC applied: 0.15 dB

Device Reference Point: 0, 0, -6.3 mm



**Cursor:**

ABM1/ABM2 = 52.49 dB  
 ABM1 comp = -2.48 dBA/m  
 BWC Factor = 0.15 dB  
 Location: 6, -3, 3.7 mm

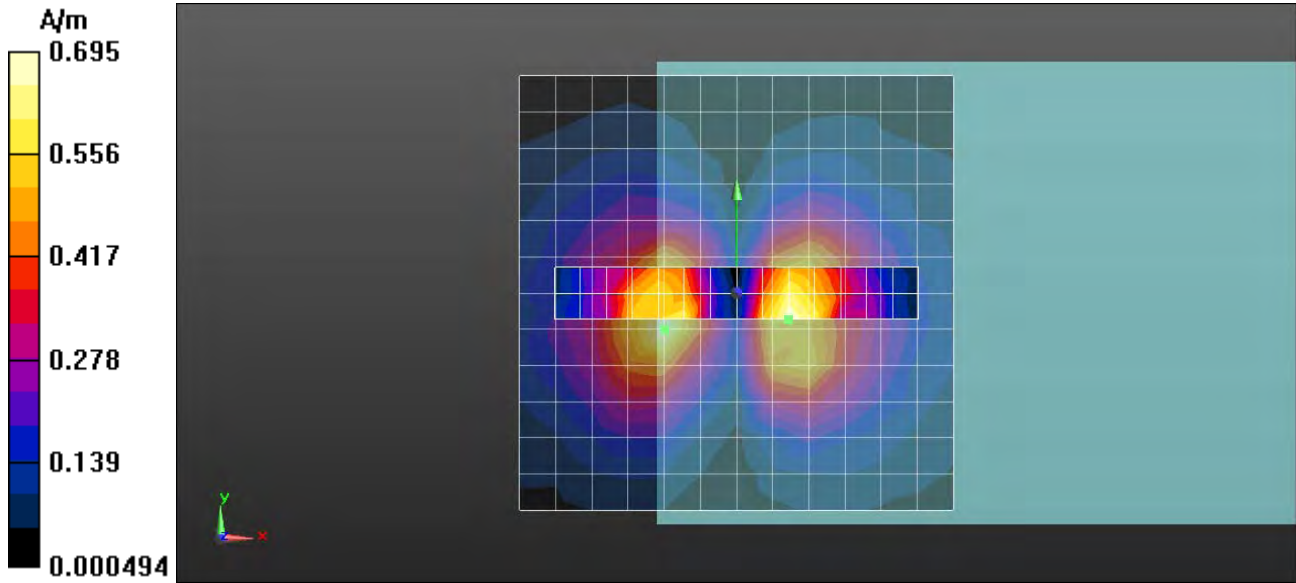

Test Laboratory: QuieTek-a DEKRA

Date/Time: 2016/06/13

**WCDMA Band 5 CH4233-Y**

**DUT: AC24G; Type: Mobile Phone**

Communication System: UID 0, FCC WCDMA\_Band-5; Frequency: 846.6 MHz;

Communication System PAR: 0 dB

Medium parameters used:  $\sigma = 0$  S/m,  $\epsilon_r = 1$ ;  $\rho = 1$  kg/m<sup>3</sup>

Phantom section: TCoil Section

Ambient Temperature (°C) : 22.4, Humidity (%RH) : 53

Measurement Standard: DASYS (IEEE/IEC/ANSI C63.19-2011)

DASY5 Configuration:

- Probe: AM1DV2 - 1085; ; Calibrated: 2016/05/19
- Sensor-Surface: 0mm (Fix Surface)
- Electronics: DAE4 Sn1207; Calibrated: 2015/11/20
- Phantom: HAC Test Arch with AMCC; Type: SD HAC P01 BA;
- Measurement SW: DASYS2, Version 52.8 (8); SEMCAD X Version 14.6.10 (7331)

**Configuration/Scans/y (transversal) 4.2mm 50 x 50/ABM Signal(x,y,z)**

**(13x13x1):** Measurement grid: dx=10mm, dy=10mm

Signal Type: Audio File (.wav) 48k\_voice\_1kHz\_1s.wav

Output Gain: 35.93

Measure Window Start: 0ms

Measure Window Length: 1000ms

BWC applied: 0.15 dB

Device Reference Point: 0, 0, -6.3 mm

**Cursor:**

ABM1 comp = -3.71 dBA/m

BWC Factor = 0.15 dB

Location: 0, -12.5, 3.7 mm

**Configuration/Scans/y (transversal) fine 3mm 6 x 42/ABM Signal(x,y,z)**

**(3x15x1):** Measurement grid: dx=10mm, dy=10mm

Signal Type: Audio File (.wav) 48k\_voice\_1kHz\_1s.wav

Output Gain: 35.93

Measure Window Start: 0ms

Measure Window Length: 1000ms

BWC applied: 0.15 dB

Device Reference Point: 0, 0, -6.3 mm

**Cursor:**

ABM1 comp = -3.39 dBA/m

BWC Factor = 0.15 dB

Location: 0, 6, 3.7 mm

**Configuration/Scans/y (transversal) fine 3mm 6 x 42/ABM SNR(x,y,z)**

**(3x15x1):** Measurement grid: dx=10mm, dy=10mm

Signal Type: Audio File (.wav) 48k\_voice\_1kHz\_1s.wav

Output Gain: 35.93

Measure Window Start: 0ms

Measure Window Length: 1000ms

BWC applied: 0.15 dB

Device Reference Point: 0, 0, -6.3 mm

**Cursor:**

ABM1/ABM2 = 52.51 dB  
 ABM1 comp = -4.01 dBA/m  
 BWC Factor = 0.15 dB  
 Location: 0, -12, 3.7 mm

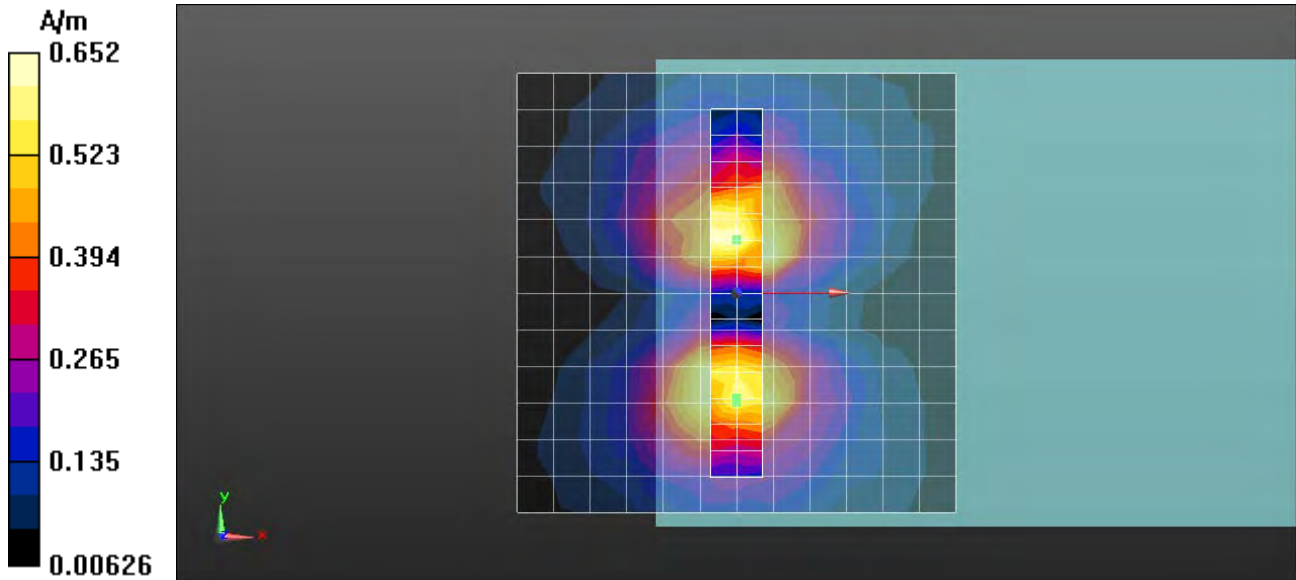

Test Laboratory: QuieTek-a DEKRA

Date/Time: 2016/06/13

**WCDMA Band 5 CH4233-Z**

**DUT: AC24G; Type: Mobile Phone**

Communication System: UID 0, FCC WCDMA\_Band-5; Frequency: 846.6 MHz;

Communication System PAR: 0 dB

Medium parameters used:  $\sigma = 0$  S/m,  $\epsilon_r = 1$ ;  $\rho = 1$  kg/m<sup>3</sup>

Phantom section: TCoil Section

Ambient Temperature (°C) : 22.4, Humidity (%RH) : 53

Measurement Standard: DASYS (IEEE/IEC/ANSI C63.19-2011)

DASY5 Configuration:

- Probe: AM1DV2 - 1085; ; Calibrated: 2016/05/19
- Sensor-Surface: 0mm (Fix Surface)
- Electronics: DAE4 Sn1207; Calibrated: 2015/11/20
- Phantom: HAC Test Arch with AMCC; Type: SD HAC P01 BA;
- Measurement SW: DASYS2, Version 52.8 (8); SEMCAD X Version 14.6.10 (7331)

**Configuration/Scans/z (axial) 4.2mm 50 x 50/ABM Signal(x,y,z) (13x13x1):**

Measurement grid: dx=10mm, dy=10mm

Signal Type: Audio File (.wav) 48k\_voice\_1kHz\_1s.wav

Output Gain: 35.93

Measure Window Start: 0ms

Measure Window Length: 1000ms

BWC applied: 0.15 dB

Device Reference Point: 0, 0, -6.3 mm

**Cursor:**

ABM1 comp = 4.21 dBA/m

BWC Factor = 0.15 dB

Location: 0, 0, 3.7 mm

**Configuration/Scans/z (axial) fine 2mm 8 x 8/ABM Signal(x,y,z) (5x5x1):**

Measurement grid: dx=10mm, dy=10mm

Signal Type: Audio File (.wav) 48k\_voice\_1kHz\_1s.wav

Output Gain: 35.93

Measure Window Start: 0ms

Measure Window Length: 1000ms

BWC applied: 0.15 dB

Device Reference Point: 0, 0, -6.3 mm

**Cursor:**

ABM1 comp = 4.87 dBA/m

BWC Factor = 0.15 dB

Location: -2, -4, 3.7 mm

**Configuration/Scans/z (axial) fine 2mm 8 x 8/ABM SNR(x,y,z) (5x5x1):**

Measurement grid: dx=10mm, dy=10mm

Signal Type: Audio File (.wav) 48k\_voice\_1kHz\_1s.wav

Output Gain: 35.93

Measure Window Start: 0ms

Measure Window Length: 1000ms

BWC applied: 0.15 dB

Device Reference Point: 0, 0, -6.3 mm

**Cursor:**

ABM1/ABM2 = 55.38 dB  
ABM1 comp = 4.44 dBA/m  
BWC Factor = 0.15 dB  
Location: -2, 0, 3.7 mm

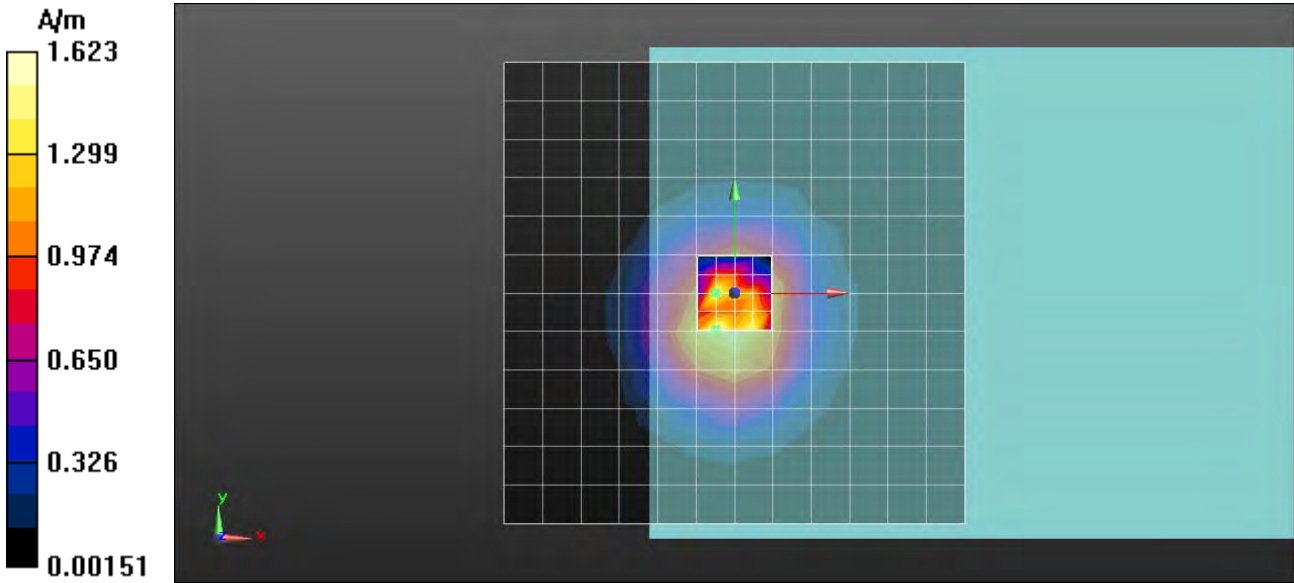

**T-Coil Z Axis plot**  
**Channel: 4233**

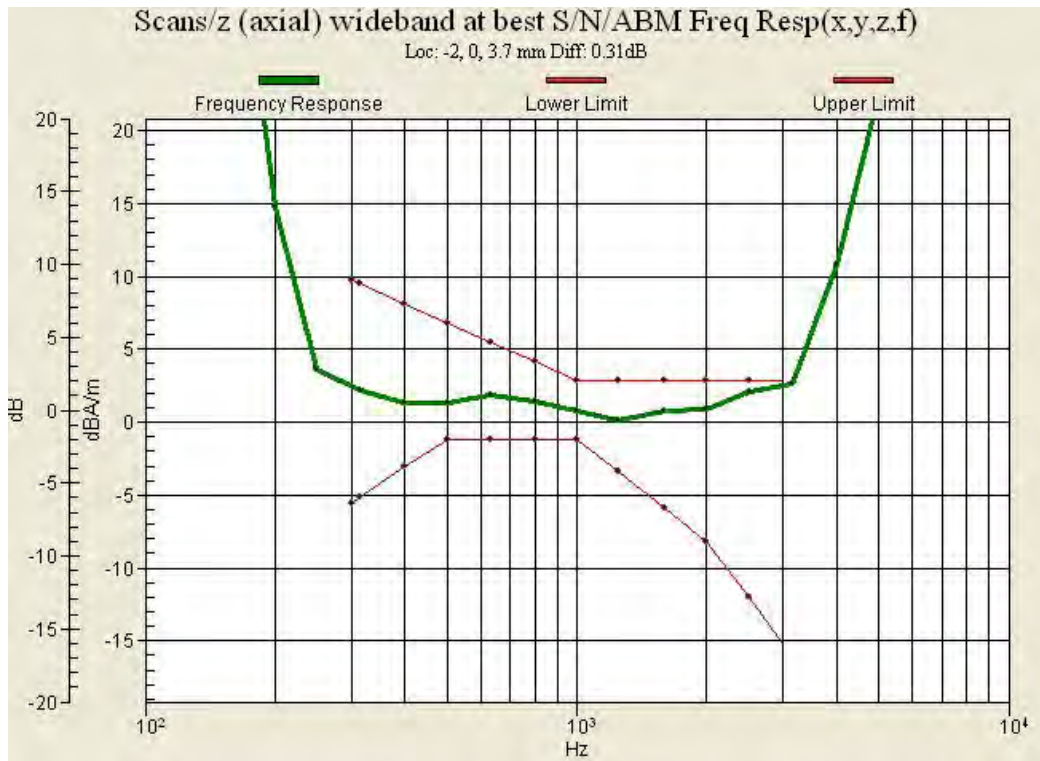



## Appendix C. Test Setup Photographs & EUT Photographs

### Test Setup Photographs

Front View



Side View





## EUT Photographs







## **Appendix D. Audio Magnetic 1D Field Probe**

**Object: AM1DV2- SN: 1085**



1135H

**Calibration Laboratory of  
Schmid & Partner  
Engineering AG**  
Zeughausstrasse 43, 8004 Zurich, Switzerland



**S** Schweizerischer Kalibrierdienst  
**C** Service suisse d'étalonnage  
**S** Servizio svizzero di taratura  
**S** Swiss Calibration Service

Accredited by the Swiss Accreditation Service (SAS)  
The Swiss Accreditation Service is one of the signatories to the EA  
Multilateral Agreement for the recognition of calibration certificates

Accreditation No.: **SCS 0108**

Client **Quietek-TW (Auden)**

Certificate No: **AM1DV2-1085\_May16**

## CALIBRATION CERTIFICATE

Object: **AM1DV2 - SN: 1085**

Calibration procedure(s): **QA CAL-24.v4  
Calibration procedure for AM1D magnetic field probes and TMFS in the audio range**

Calibration date: **May 19, 2016**

This calibration certificate documents the traceability to national standards, which realize the physical units of measurements (SI). The measurements and the uncertainties with confidence probability are given on the following pages and are part of the certificate.

All calibrations have been conducted in the closed laboratory facility: environment temperature (22 ± 3)°C and humidity < 70%.

Calibration Equipment used (M&TE critical for calibration)

Primary Standards	ID #	Cal Date (Certificate No.)	Scheduled Calibration
Keithley Multimeter Type 2001	SN: 0810278	09-Sep-15 (No. 17153)	Sep-16
Reference Probe AM1DV2	SN: 1008	30-Dec-15 (No. AM1D-1008_Dec15)	Dec-16
DAE4	SN: 781	04-Sep-15 (No. DAE4-781_Sep15)	Sep-16

Secondary Standards	ID #	Check Date (in house)	Scheduled Check
AMCC	SN: 1050	01-Oct-13 (in house check Sep-15)	Oct-17
AMMI Audio Measuring Instrument	SN: 1062	26-Sep-12 (in house check Sep-15)	Oct-17

	Name	Function	Signature
Calibrated by:	Jeton Kastrati	Laboratory Technician	
Approved by:	Katja Pokovic	Technical Manager	

Issued: May 20, 2016

This calibration certificate shall not be reproduced except in full without written approval of the laboratory.

## [References

- [1] ANSI-C63.19-2007  
American National Standard for Methods of Measurement of Compatibility between Wireless Communications Devices and Hearing Aids.
- [2] ANSI-C63.19-2011  
American National Standard, Methods of Measurement of Compatibility between Wireless Communications Devices and Hearing Aids.
- [3] DASY5 manual, Chapter: Hearing Aid Compatibility (HAC) T-Coil Extension

## Description of the AM1D probe

The AM1D Audio Magnetic Field Probe is a fully shielded magnetic field probe for the frequency range from 100 Hz to 20 kHz. The pickup coil is compliant with the dimensional requirements of [1+2]. The probe includes a symmetric low noise amplifier for the signal available at the shielded 3 pin connector at the side. Power is supplied via the same connector (phantom power supply) and monitored via the LED near the connector. The 7 pin connector at the end of the probe does not carry any signals, but determines the angle of the sensor when mounted on the DAE. The probe supports mechanical detection of the surface.

The single sensor in the probe is arranged in a tilt angle allowing measurement of 3 orthogonal field components when rotating the probe by 120° around its axis. It is aligned with the perpendicular component of the field, if the probe axis is tilted nominally 35.3° above the measurement plane, using the connector rotation and sensor angle stated below.

The probe is fully RF shielded when operated with the matching signal cable (shielded) and allows measurement of audio magnetic fields in the close vicinity of RF emitting wireless devices according to [1+2] without additional shielding.

## Handling of the item

The probe is manufactured from stainless steel. In order to maintain the performance and calibration of the probe, it must not be opened. The probe is designed for operation in air and shall not be exposed to humidity or liquids. For proper operation of the surface detection and emergency stop functions in a DASY system, the probe must be operated with the special probe cup provided (larger diameter).

## Methods Applied and Interpretation of Parameters

- *Coordinate System:* The AM1D probe is mounted in the DASY system for operation with a HAC Test Arch phantom with AMCC Helmholtz calibration coil according to [3], with the tip pointing to “southwest” orientation.
- *Functional Test:* The functional test preceding calibration includes test of Noise level  
RF immunity (1kHz AM modulated signal). The shield of the probe cable must be well connected.  
Frequency response verification from 100 Hz to 10 kHz.
- *Connector Rotation:* The connector at the end of the probe does not carry any signals and is used for fixation to the DAE only. The probe is operated in the center of the AMCC Helmholtz coil using a 1 kHz magnetic field signal. Its angle is determined from the two minima at nominally +120° and –120° rotation, so the sensor in the tip of the probe is aligned to the vertical plane in z-direction, corresponding to the field maximum in the AMCC Helmholtz calibration coil.
- *Sensor Angle:* The sensor tilting in the vertical plane from the ideal vertical direction is determined from the two minima at nominally +120° and –120°. DASY system uses this angle to align the sensor for radial measurements to the x and y axis in the horizontal plane.

*Sensitivity:* With the probe sensor aligned to the z-field in the AMCC, the output of the probe is compared to the magnetic field in the AMCC at 1 kHz. The field in the AMCC Helmholtz coil is given by the geometry and the current through the coil, which is monitored on the precision shunt resistor of the coil.

## AM1D probe identification and configuration data

Item	<b>AM1DV2</b> Audio Magnetic 1D Field Probe
Type No	SP AM1 001 AF
Serial No	<b>1085</b>

Overall length	296 mm
Tip diameter	6.0 mm (at the tip)
Sensor offset	3.0 mm (centre of sensor from tip)
Internal Amplifier	40 dB

Manufacturer / Origin	Schmid & Partner Engineering AG, Zürich, Switzerland
Manufacturing date	October 30, 2008
Last calibration date	May 21, 2015

## Calibration data

Connector rotation angle	(in DASY system)	<b>197.0 °</b>	+/- 3.6 ° (k=2)
Sensor angle	(in DASY system)	<b>0.20 °</b>	+/- 0.5 ° (k=2)
Sensitivity at 1 kHz	(in DASY system)	<b>0.0665 V / (A/m)</b>	+/- 2.2 % (k=2)

The reported uncertainty of measurement is stated as the standard uncertainty of measurement multiplied by the coverage factor k=2, which for a normal distribution corresponds to a coverage probability of approximately 95%.