

FCC REPORT

Applicant: AZUMI S.A

Address of Applicant: Avenida Aquilino de la Guardia con Calle 47, PH Ocean Plaza,
Piso 16 of. 16-01, Marbella, Ciudad de Panamá City, Rep.
Panamá

Equipment Under Test (EUT)

Product Name: GSM Mobile Phone

Model No.: A40Q

Trade mark: Azumi

FCC ID: QRP-AZUMIA40Q

Applicable standards: FCC CFR Title 47 Part 2
FCC CFR Title 47 Part22 Subpart H
FCC CFR Title 47 Part24 Subpart E

Date of sample receipt: 28 Jul., 2015

Date of Test: 28 Jul., to 06 Sep., 2015

Date of report issued: 07 Sep., 2015

Test Result: PASS *

* In the configuration tested, the EUT complied with the standards specified above.

Authorized Signature:



Bruce Zhang
Laboratory Manager

This report details the results of the testing carried out on one sample. The results contained in this test report do not relate to other samples of the same product and does not permit the use of the CCIS product certification mark. The manufacturer should ensure that all products in series production are in conformity with the product sample detailed in this report.

This report may only be reproduced and distributed in full. If the product in this report is used in any configuration other than that detailed in the report, the manufacturer must ensure the new system complies with all relevant standards.

This document cannot be reproduced except in full, without prior written approval of the Company. Any unauthorized alteration, forgery or falsification of the content or appearance of this document is unlawful and offenders may be prosecuted to the fullest extent of the law. Unless otherwise stated the results shown in this test report refer only to the sample(s) tested and such sample(s) are retained for 90 days only.

2. Version

| Version No. | Date | Description |
|-------------|---------------|-------------|
| 00 | 07 Sep., 2015 | Original |
| | | |
| | | |
| | | |
| | | |

Tested by:

Viki zhu

Date:

07 Sep., 2015

Test Engineer

Reviewed by:

Carey Chen

Date:

07 Sep., 2015

Project Engineer

3. Contents

| | Page |
|--|-----------|
| 1. COVER PAGE | 1 |
| 2. VERSION | 2 |
| 3. CONTENTS | 3 |
| 4. TEST SUMMARY | 4 |
| 5. GENERAL INFORMATION | 5 |
| 5.1 CLIENT INFORMATION..... | 5 |
| 5.2 GENERAL DESCRIPTION OF E.U.T..... | 5 |
| 5.3 TEST MODES..... | 8 |
| 5.4 RELATED SUBMITTAL(S) / GRANT (S)..... | 8 |
| 5.5 TEST METHODOLOGY..... | 8 |
| 5.6 LABORATORY FACILITY..... | 8 |
| 5.7 LABORATORY LOCATION..... | 8 |
| 5.8 TEST INSTRUMENTS LIST..... | 8 |
| 6. SYSTEM TEST CONFIGURATION | 10 |
| 6.1 EUT CONFIGURATION..... | 10 |
| 6.2 EUT EXERCISE..... | 10 |
| 6.3 CONFIGURATION OF TESTED SYSTEM..... | 10 |
| 6.4 DESCRIPTION OF TEST MODES..... | 10 |
| 6.5 CONDUCTED OUTPUT POWER..... | 11 |
| 6.6 OCCUPY BANDWIDTH..... | 15 |
| 6.7 PEAK-TO-AVERAGE RATIO..... | 25 |
| 6.8 MODULATION CHARACTERISTIC..... | 28 |
| 6.9 OUT OF BAND EMISSION AT ANTENNA TERMINALS..... | 28 |
| 6.10 ERP, EIRP MEASUREMENT..... | 39 |
| 6.11 FIELD STRENGTH OF SPURIOUS RADIATION MEASUREMENT..... | 42 |
| 6.12 FREQUENCY STABILITY V.S. TEMPERATURE MEASUREMENT..... | 48 |
| 6.13 FREQUENCY STABILITY V.S. VOLTAGE MEASUREMENT..... | 51 |
| 7 TEST SETUP PHOTO | 53 |
| 8 EUT CONSTRUCTIONAL DETAILS | 54 |

4. Test Summary

| Test Item | Section in CFR 47 | Result |
|--|--|---|
| RF Exposure (SAR) | Part 1.1307 Part 2.1093 | Passed* (Please refer to SAR Report) |
| RF Output Power | Part 2.1046 Part 22.913 (a)(2) Part 24.232 (c) | Pass |
| Modulation Characteristics | Part 2.1047 | Pass |
| 99% & -26 dB Occupied Bandwidth | Part 2.1049 Part 22.917 Part 24.238 | Pass |
| Spurious Emissions at Antenna Terminal | Part 2.1051 Part 22.917 (a) Part 24.238 (a) | Pass |
| Field Strength of Spurious Radiation | Part 2.1053 Part 22.917 (a) Part 24.238 (a) | Pass |
| Out of band emission, Band Edge | Part 22.917 (a) Part 24.238 (a) | Pass |
| Frequency stability vs. temperature | Part 2.1055(a)(1)(b) | Pass |
| Frequency stability vs. voltage | Part 2.1055(d)(1)(2) | Pass |

Pass: The EUT complies with the essential requirements in the standard.

5. General Information

5.1 Client Information

| | |
|--------------------------|--|
| Applicant: | AZUMI S.A |
| Address of Applicant: | Avenida Aquilino de la Guardia con Calle 47, PH Ocean Plaza, Piso 16 of. 16-01, Marbella, Ciudad de Panamá City, Rep. Panamá |
| Manufacturer: | United Creation Technology Co., Ltd |
| Address of Manufacturer: | Room 201, Block A, Science & Technology Building Phase-II, Nanhai Av. 1057, Nanshan, Shenzhen, China |
| Factory: | HUIZHOU Unison Electronics Co., Ltd. |
| Address of Factory: | Huizhou MaAn town QunLe road school Gold yeu two-floor |

5.2 General Description of E.U.T.

| | |
|----------------------------|--|
| Product Name: | GSM Mobile Phone |
| Model No.: | A40Q |
| Operation Frequency range: | GSM 850: 824.20MHz-848.80MHz PCS1900: 1850.20MHz-1909.80MHz WCDMA Band V:826.4MHz-846.6MHz WCDMA Band II:1852.4 MHz -1907.6 MHz |
| Modulation type: | GSM/GPRS:GMSK, UMTS:BPSK |
| Antenna type: | Integral Antenna |
| Antenna gain: | GSM 850: 1.8 dBi PCS 1900: 3.7dBi WCDMA 850: 1.9dBi WCDMA 1900: 3.7dBi |
| AC adapter: | Model No.:A40Q Input:100-240V AC,50/60Hz 0.15A Output:5V DC MAX 500mA |
| Power supply: | Rechargeable Li-ion Battery DC3.7V-1350mAh |

Operation Frequency List:

| GSM 850 | | PCS1900 | |
|--------------|-----------------|---------------|-----------------|
| Channel: | Frequency (MHz) | Channel: | Frequency (MHz) |
| 128 | 824.20 | 512 | 1850.20 |
| 129 | 824.40 | 513 | 1850.40 |
| | | | |
| 189 | 836.40 | 660 | 1879.80 |
| 190 | 836.60 | 661 | 1880.00 |
| 191 | 836.80 | 662 | 1880.20 |
| ... | ... | ... | ... |
| 250 | 848.60 | 809 | 1909.60 |
| 251 | 848.80 | 810 | 1909.80 |
| WCDMA Band V | | WCDMA Band II | |
| Channel: | Frequency (MHz) | Channel: | Frequency (MHz) |
| 4132 | 826.40 | 9262 | 1852.40 |
| 4133 | 826.60 | 9263 | 1852.60 |
| | | | |
| 4182 | 836.40 | 9399 | 1879.80 |
| 4183 | 836.60 | 9400 | 1880.00 |
| 4184 | 836.80 | 9401 | 1880.20 |
| ... | ... | ... | ... |
| 4232 | 846.40 | 9537 | 1907.40 |
| 4233 | 846.60 | 9538 | 1907.60 |

Regards to the operating frequency range over 10 MHz, the Lowest frequency, the middle frequency, and the highest frequency of channel were selected to perform the test, and the selected channel see below:

| GSM850 | | | PCS1900 | | |
|-----------------|------|----------------|-----------------|------|----------------|
| Channel | | Frequency(MHz) | Channel | | Frequency(MHz) |
| Lowest channel | 128 | 824.20 | Lowest channel | 512 | 1850.20 |
| Middle channel | 190 | 836.60 | Middle channel | 661 | 1880.00 |
| Highest channel | 251 | 848.80 | Highest channel | 810 | 1909.80 |
| WCDMA Band V | | | WCDMA Band II | | |
| Channel | | Frequency(MHz) | Channel | | Frequency(MHz) |
| Lowest channel | 4132 | 826.40 | Lowest channel | 9262 | 1852.40 |
| Middle channel | 4183 | 836.60 | Middle channel | 9400 | 1880.00 |
| Highest channel | 4233 | 846.60 | Highest channel | 9538 | 1907.60 |

5.3 Test modes

| | |
|------------------------------|---|
| Communicate mode (GSM850) | Keep the EUT in communicating mode on GSM 850 band. |
| Data mode (GPRS850) | Keep the EUT in data communicating mode on GPRS 850 band. |
| Communicate mode (PCS1900) | Keep the EUT in communicating mode on PCS1900 band. |
| Data mode (GPRS1900) | Keep the EUT in data communicating mode on GPRS1900 band. |
| Communicate mode (UMTS 850) | Keep the EUT in communicating mode on UMTS 850 band. |
| Communicate mode (UMTS 1900) | Keep the EUT in communicating mode on UMTS 1900 band. |
| Data mode (RMC UMTS 850) | Keep the EUT in data communicating mode on RMC in UMTS 850 (12.2 kbps, 64 kbps, 144 kbps & 384 kbps). |
| Data mode (HSDPA UMTS 850) | Keep the EUT in data communicating mode on HSDPA in UMTS 850(Sub-test 1~Sub-test 4). |
| Data mode (HSUPA UMTS 850) | Keep the EUT in data communicating mode on HSUPA in UMTS 850(Sub-test 1~Sub-test 5). |
| Data mode (RMC UMTS 1900) | Keep the EUT in data communicating mode on RMC in UMTS 850 (12.2 kbps, 64 kbps, 144 kbps & 384 kbps). |
| Data mode (HSDPA UMTS 1900) | Keep the EUT in data communicating mode on HSDPA in UMTS 1900. (Sub-test 1~Sub-test 4). |
| Data mode (HSUPA UMTS 1900) | Keep the EUT in data communicating mode on HSUPA in UMTS 1900. (Sub-test 1~Sub-test 5). |
| Remark : | Pre-test output power of all modes, and found GSM 850, PCS 1900, UMTS 850 12.2 kbps RMC & UMTS 1900 12.2 kbps RMC were the worst case. The details please refer to section 6.5. |

5.4 Related Submittal(s) / Grant (s)

This submittal(s) (test report) is filing to comply with Section Part 22 subpart H and Part 24 subpart E of the FCC CFR 47 Rules.

5.5 Test Methodology

Both conducted and radiated testing were performed according to the procedures document on TIA/EIA 603 and FCC CFR 47.1046, 2.1047, 2.1049, 2.1051, 2.1053, 2.1055 and 2.1057

5.6 Laboratory Facility

The test facility is recognized, certified, or accredited by the following organizations:

- **FCC - Registration No.: 817957**

Shenzhen Zhongjian Nanfang Testing Co., Ltd. EMC Laboratory has been registered and fully described in a report filed with the (FCC) Federal Communications Commission. The acceptance letter from the FCC is maintained in out files. Registration 817957, February 27, 2012.

- **IC - Registration No.: 10106A-1**

The 3m Semi-anechoic chamber of Shenzhen Zhongjian Nanfang Testing Co., Ltd. has been Registered by Certification and Engineering Bureau of Industry Canada for radio equipment testing with Registration No.: 10106A-1.

- **CNAS - Registration No.: CNAS L6048**

Shenzhen Zhongjian Nanfang Testing Co., Ltd. is accredited to ISO/IEC 17025:2005 General Requirements for the Competence of Testing and Calibration laboratories for the competence of testing. The Registration No. is CNAS L6048.

5.7 Laboratory Location

Shenzhen Zhongjian Nanfang Testing Co., Ltd.
 Address: No. B-C, 1/F., Building 2, Laodong No.2 Industrial Park, Xixiang Road,
 Bao'an District, Shenzhen, Guangdong, China
 Tel: +86-755-23118282
 Fax: +86-755-23116366

5.8 Test Instruments list

Radiated Emission:

| Item | Test Equipment | Manufacturer | Model No. | Inventory No. | Cal. Date (mm-dd-yy) | Cal. Due date (mm-dd-yy) |
|------|--------------------------------------|-----------------------------------|-----------------------------|---------------|----------------------|--------------------------|
| 1 | 3m Semi- Anechoic Chamber | SAEMC | 9(L)*6(W)* 6(H) | CCIS0001 | 08-23-2014 | 08-22-2017 |
| 2 | BiConiLog Antenna | SCHWARZBECK MESS-ELEKTRONIK | VULB9163 | CCIS0005 | 03-28-2015 | 03-28-2016 |
| 3 | Double -ridged waveguide horn | SCHWARZBECK MESS-ELEKTRONIK | BBHA9120D | CCIS0006 | 03-28-2015 | 03-28-2016 |
| 4 | EMI Test Software | AUDIX | E3 | N/A | N/A | N/A |
| 5 | Amplifier (10kHz-1.3GHz) | HP | 8447D | CCIS0003 | 04-01-2015 | 03-31-2016 |
| 6 | Amplifier (1GHz-18GHz) | Compliance Direction Systems Inc. | PAP-1G18 | CCIS0011 | 04-01-2015 | 03-31-2016 |
| 7 | Pre-amplifier (18-26GHz) | Rohde & Schwarz | AFS33-18002 650-30-8P-44 | GTS218 | 04-01-2015 | 03-31-2016 |
| 8 | Horn Antenna | ETS-LINDGREN | 3160 | GTS217 | 04-01-2015 | 03-31-2016 |
| 9 | Printer | HP | HP LaserJet P1007 | N/A | N/A | N/A |
| 10 | Positioning Controller | UC | UC3000 | CCIS0015 | N/A | N/A |
| 11 | Spectrum analyzer 9k-30GHz | Rohde & Schwarz | FSP 30 | CCIS0023 | 03-28-2015 | 03-28-2016 |
| 12 | EMI Test Receiver | Rohde & Schwarz | ESPI | CCIS0022 | 03-28-2015 | 03-28-2016 |
| 13 | Loop antenna | Laplace instrument | RF300 | EMC0701 | 04-01-2015 | 03-31-2016 |
| 14 | Universal radio communication tester | Rhode & Schwarz | CMU200 | CCIS0069 | 03-28-2015 | 03-28-2016 |
| 15 | Signal Analyzer | Rohde & Schwarz | FSIQ3 | CCIS0088 | 04-08-2015 | 04-08-2016 |

6. System test configuration

6.1 EUT Configuration

The EUT configuration for testing is installed on RF field strength measurement to meet the commission's requirement and operating in a manner which intends to maximize its emission characteristics in a continuous normal application.

6.2 EUT Exercise

The EUT (Transmitter) was operated in the engineering mode to fix the Tx frequency which was for the purpose of the measurements.

6.3 Configuration of Tested System

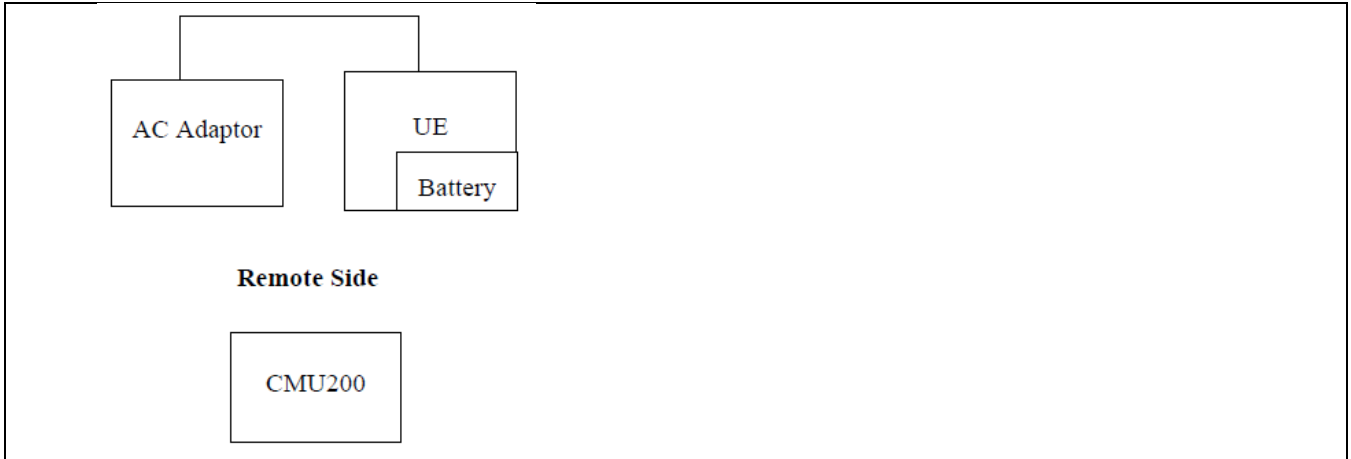

6.4 Description of Test Modes

The EUT has been tested under operating condition.

EUT staying in continuous transmitting mode. Channel Low, Mid and High for each type band with rated data rate were chosen for full testing.

The field strength of spurious radiation emission was measured as EUT stand-up position (H mode) and lie down position (E1, E2 mode) for three modes (GSM850, PCS1900, WCDMA Band V and WCDMA Band II) with power adaptor, earphone and Data cable. The worst-case H mode for GSM850, PCS1900, UMTS 850 and UMTS 1900.

6.5 Conducted Output Power

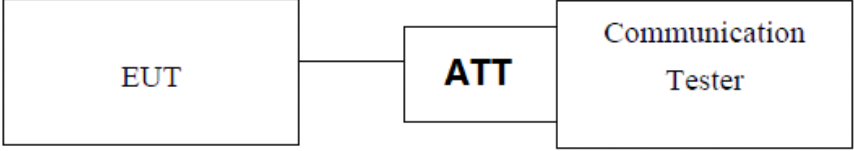
| | |
|-------------------|---|
| Test Requirement: | FCC part 22.913(a) and FCC part 24.232(b) |
| Test Method: | FCC part 2.1046 |
| Limit: | GSM 850 7W PCS 1900 2W WCDMA Band V: 7W WCDMA Band II: 2W |
| Test setup: |  <p style="text-align: center;"><i>Note: Measurement setup for testing on Antenna connector</i></p> |
| Test Procedure: | The transmitter output was connected to a calibrated attenuator, the other end of which was connected to the CMU200. Transmitter output power was read off in dBm. |
| Test Instruments: | Refer to section 5.8 for details |
| Test mode: | Refer to section 5.3 for details |
| Test results: | Passed |

Measurement Data

| EUT Mode | Channel | Frequency (MHz) | Burst Average power (dBm) | Limit(dBm) | Result |
|-------------------------------|---------|-----------------|---------------------------|------------|--------|
| GSM 850 | 128 | 824.20 | 32.85 | 38.45 | Pass |
| | 190 | 836.60 | 32.87 | | |
| | 251 | 848.80 | 33.08 | | |
| GPRS 850 (1 Uplink slot) | 128 | 824.20 | 32.83 | | |
| | 190 | 836.60 | 32.86 | | |
| | 251 | 848.80 | 33.07 | | |
| GPRS 850 (2 Uplink slots) | 128 | 824.20 | 31.16 | | |
| | 190 | 836.60 | 31.36 | | |
| | 251 | 848.80 | 31.50 | | |
| GPRS 850 (3 Uplink slots) | 128 | 824.20 | 29.43 | | |
| | 190 | 836.60 | 29.57 | | |
| | 251 | 848.80 | 29.71 | | |
| GPRS 850 (4 Uplink slots) | 128 | 824.20 | 27.48 | | |
| | 190 | 836.60 | 27.63 | | |
| | 251 | 848.80 | 27.75 | | |
| PCS 1900 | 512 | 1850.20 | 30.12 | 33.00 | Pass |
| | 661 | 1880.00 | 29.94 | | |
| | 810 | 1909.80 | 29.97 | | |
| GPRS 1900 (1 Uplink slot) | 512 | 1850.20 | 30.11 | | |
| | 661 | 1880.00 | 29.90 | | |
| | 810 | 1909.80 | 30.05 | | |
| GPRS 1900 (2 Uplink slots) | 512 | 1850.20 | 28.66 | | |
| | 661 | 1880.00 | 28.36 | | |
| | 810 | 1909.80 | 27.99 | | |
| GPRS 1900 (3 Uplink slots) | 512 | 1850.20 | 27.14 | | |
| | 661 | 1880.00 | 26.62 | | |
| | 810 | 1909.80 | 26.69 | | |
| GPRS 1900 (4 Uplink slots) | 512 | 1850.20 | 25.12 | | |
| | 661 | 1880.00 | 24.84 | | |
| | 810 | 1909.80 | 24.66 | | |

| EUT Mode | | Channel | Frequency (MHz) | Burst Average power (dBm) | Limit(dBm) | Result |
|----------------|-----------|---------|-----------------|---------------------------|------------|--------|
| UMTS 850 HSDPA | Subtest 1 | 4132 | 826.40 | 21.72 | 38.45 | Pass |
| | | 4183 | 836.00 | 21.82 | | |
| | | 4233 | 846.60 | 21.67 | | |
| | Subtest 2 | 4132 | 826.40 | 21.60 | | |
| | | 4183 | 836.00 | 21.74 | | |
| | | 4233 | 846.60 | 21.54 | | |
| | Subtest 3 | 4132 | 826.40 | 21.32 | | |
| | | 4183 | 836.00 | 21.16 | | |
| | | 4233 | 846.60 | 21.03 | | |
| | Subtest 4 | 4132 | 826.40 | 21.00 | | |
| | | 4183 | 836.00 | 21.23 | | |
| | | 4233 | 846.60 | 20.93 | | |
| UMTS 850 HSUPA | Subtest 1 | 4132 | 826.40 | 21.23 | | |
| | | 4183 | 836.00 | 21.35 | | |
| | | 4233 | 846.60 | 21.15 | | |
| | Subtest 2 | 4132 | 826.40 | 21.29 | | |
| | | 4183 | 836.00 | 21.44 | | |
| | | 4233 | 846.60 | 21.26 | | |
| | Subtest 3 | 4132 | 826.40 | 21.20 | | |
| | | 4183 | 836.00 | 21.52 | | |
| | | 4233 | 846.60 | 21.11 | | |
| | Subtest 4 | 4132 | 826.40 | 21.48 | | |
| | | 4183 | 836.00 | 21.73 | | |
| | | 4233 | 846.60 | 21.50 | | |
| Subtest 5 | 4132 | 826.40 | 21.11 | | | |
| | 4183 | 836.00 | 21.42 | | | |
| | 4233 | 846.60 | 21.38 | | | |
| UMTS 850 RMC | 12.2kbps | 4132 | 826.40 | 23.01 | | |
| | | 4183 | 836.00 | 22.91 | | |
| | | 4233 | 846.60 | 22.86 | | |
| UMTS 850 AMR | 12.2kbps | 4132 | 826.40 | 21.94 | | |
| | | 4183 | 836.00 | 22.01 | | |
| | | 4233 | 846.60 | 22.10 | | |

| EUT Mode | | Channel | Frequency (MHz) | Burst Average power (dBm) | Limit(dBm) | Result |
|----------------|-----------|---------|-----------------|---------------------------|------------|--------|
| UMTS1900 HSDPA | Subtest 1 | 9262 | 1852.40 | 20.50 | 33.00 | Pass |
| | | 9400 | 1880.00 | 20.19 | | |
| | | 9538 | 1907.60 | 20.74 | | |
| | Subtest 2 | 9262 | 1852.40 | 20.22 | | |
| | | 9400 | 1880.00 | 20.23 | | |
| | | 9538 | 1907.60 | 20.52 | | |
| | Subtest 3 | 9262 | 1852.40 | 19.68 | | |
| | | 9400 | 1880.00 | 19.86 | | |
| | | 9538 | 1907.60 | 19.91 | | |
| | Subtest 4 | 9262 | 1852.40 | 19.37 | | |
| | | 9400 | 1880.00 | 19.85 | | |
| | | 9538 | 1907.60 | 19.68 | | |
| UMTS1900 HSUPA | Subtest 1 | 9262 | 1852.40 | 19.70 | | |
| | | 9400 | 1880.00 | 19.75 | | |
| | | 9538 | 1907.60 | 20.16 | | |
| | Subtest 2 | 9262 | 1852.40 | 20.04 | | |
| | | 9400 | 1880.00 | 19.86 | | |
| | | 9538 | 1907.60 | 20.31 | | |
| | Subtest 3 | 9262 | 1852.40 | 19.72 | | |
| | | 9400 | 1880.00 | 20.09 | | |
| | | 9538 | 1907.60 | 20.08 | | |
| | Subtest 4 | 9262 | 1852.40 | 20.27 | | |
| | | 9400 | 1880.00 | 20.15 | | |
| | | 9538 | 1907.60 | 20.50 | | |
| | Subtest 5 | 9262 | 1852.40 | 19.82 | | |
| | | 9400 | 1880.00 | 20.12 | | |
| | | 9538 | 1907.60 | 20.20 | | |
| UMTS1900 RMC | 12.2kbps | 9262 | 1852.40 | 21.82 | | |
| | | 9400 | 1880.00 | 21.85 | | |
| | | 9538 | 1907.60 | 21.48 | | |
| UMTS1900 AMR | 12.2kbps | 9262 | 1852.40 | 20.80 | | |
| | | 9400 | 1880.00 | 20.82 | | |
| | | 9538 | 1907.60 | 20.29 | | |

6.6 Occupy Bandwidth

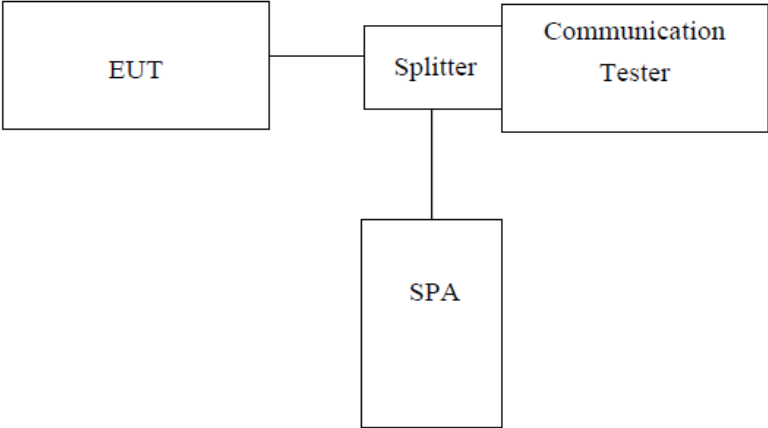
| | |
|-------------------|--|
| Test Requirement: | FCC part 22.913(a) and FCC part 24.232(b) |
| Test Method: | FCC part 2.1049 |
| Test setup: |  <p style="text-align: center;"><i>Note: Measurement setup for testing on Antenna connector</i></p> |
| Test Procedure: | <ol style="list-style-type: none"> 1. The EUT's output RF connector was connected with a short cable to the spectrum analyzer 2. RBW was set to about 1% of emission BW, VBW= 3 times RBW. 3. -26dBc display line was placed on the screen (or 99% bandwidth), the occupied bandwidth is the delta frequency between the two points where the display line intersects the signal trace. |
| Test Instruments: | Refer to section 5.8 for details |
| Test mode: | Refer to section 5.3 for details |
| Test results: | Passed |

Measurement Data

| EUT Mode | Channel | Frequency (MHz) | 99% Occupy bandwidth (kHz) | -26dB bandwidth (kHz) |
|-----------------------|---------|-----------------|----------------------------|-----------------------|
| GSM 850 | 128 | 824.2 | 246 | 324 |
| | 190 | 836.6 | 245 | 318 |
| | 251 | 848.8 | 246 | 323 |
| PCS 1900 | 512 | 1850.2 | 250 | 310 |
| | 661 | 1880.0 | 246 | 316 |
| | 810 | 1909.8 | 252 | 310 |
| UMTS850 12.2k RMC | 4132 | 824.40 | 4120 | 4700 |
| | 4183 | 836.00 | 4100 | 4680 |
| | 4233 | 846.60 | 4120 | 4660 |
| UMTS1900 12.2k RMC | 9262 | 1852.40 | 4100 | 4680 |
| | 9400 | 1880.00 | 4100 | 4660 |
| | 9538 | 1907.60 | 4080 | 4680 |

Note: GSM & GPRS use the same modulation technical (GMSK), and with the same channels, so the 99% OBW and the -26dB of GPRS not performed.

Test plot as follows:

99% Occupy bandwidth GSM850

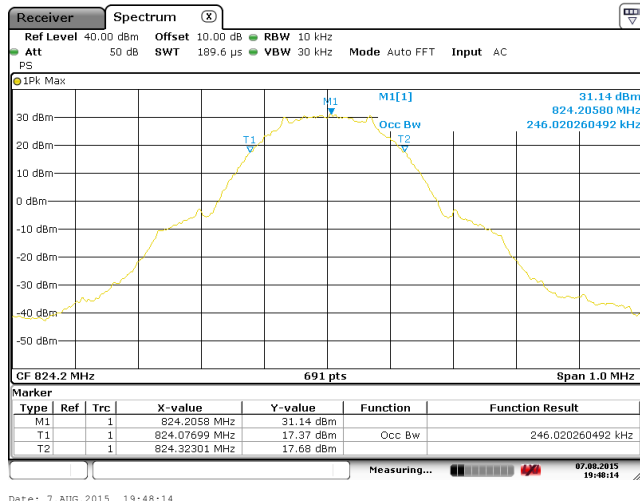

Lowest channel

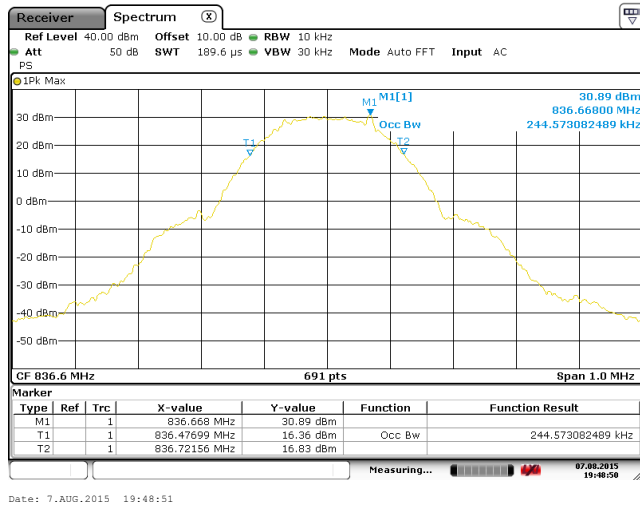

Middle channel

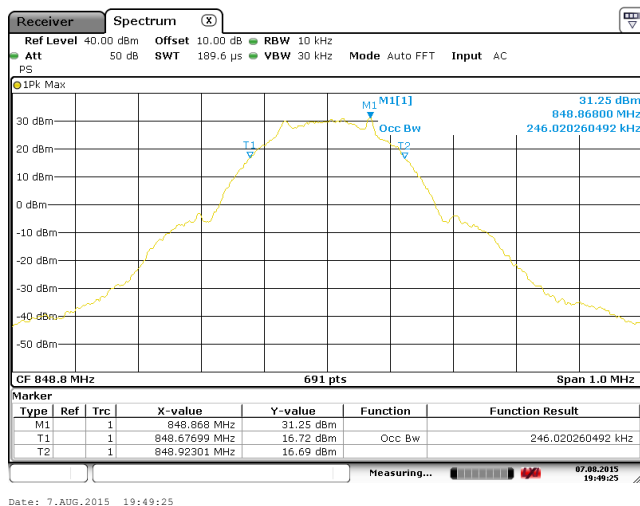

Highest channel

26dB Emission Bandwidth GSM850

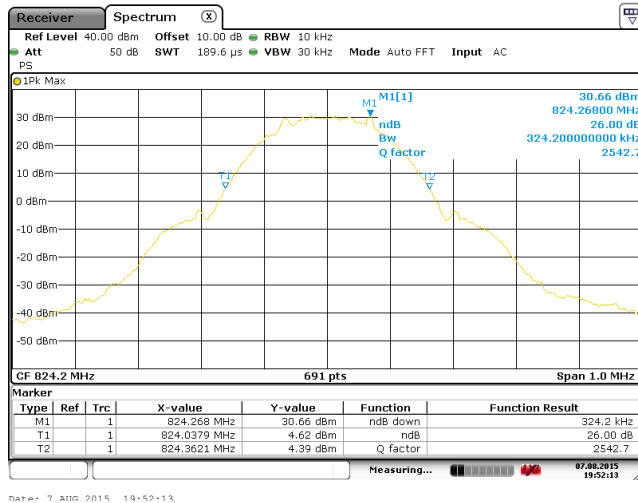

Lowest channel

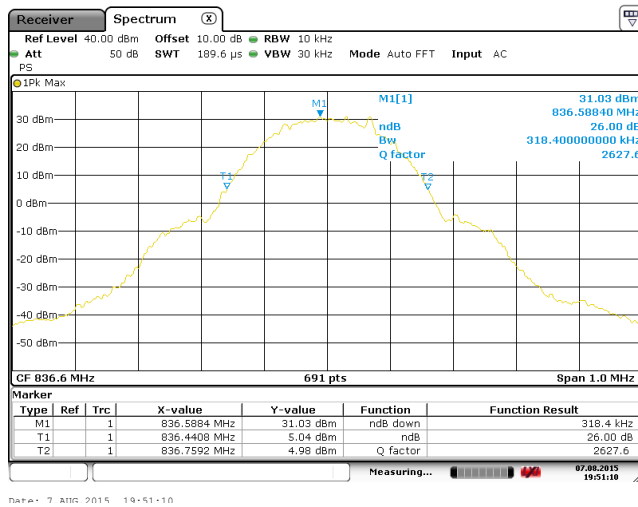

Middle channel

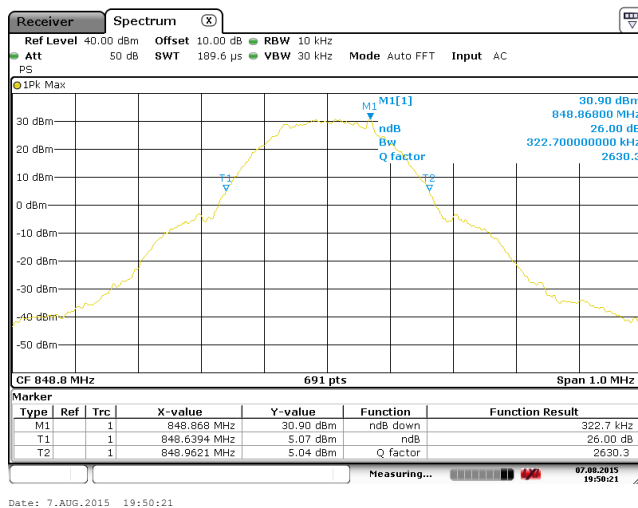

Highest channel

99% Occupy bandwidth

PCS 1900

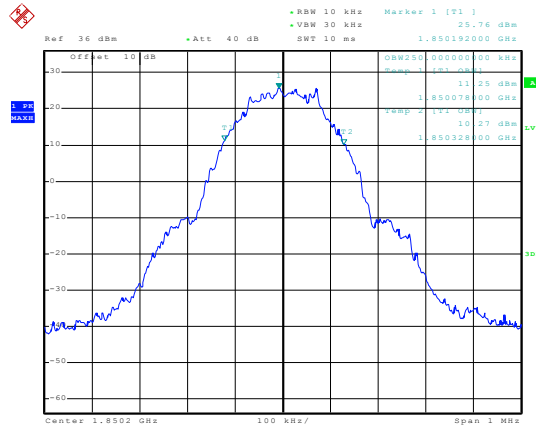

Date: 30.JUL.2015 15:06:19

Lowest channel

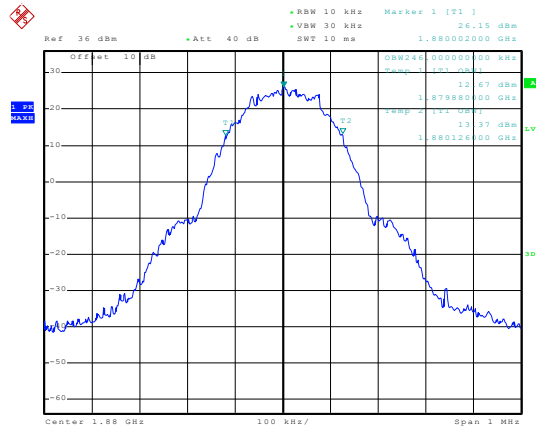

Date: 30.JUL.2015 15:08:40

Middle channel

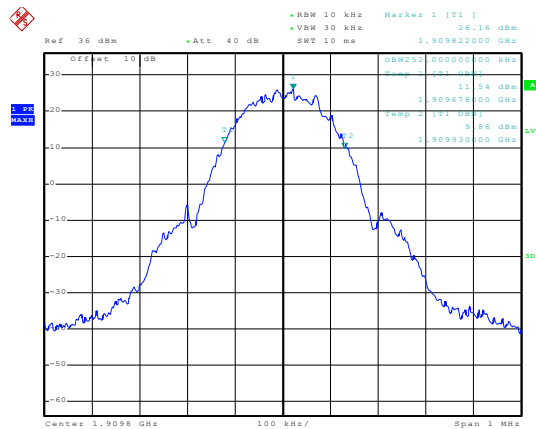

Date: 30.JUL.2015 15:09:32

Highest channel

26dB Emission Bandwidth PCS 1900

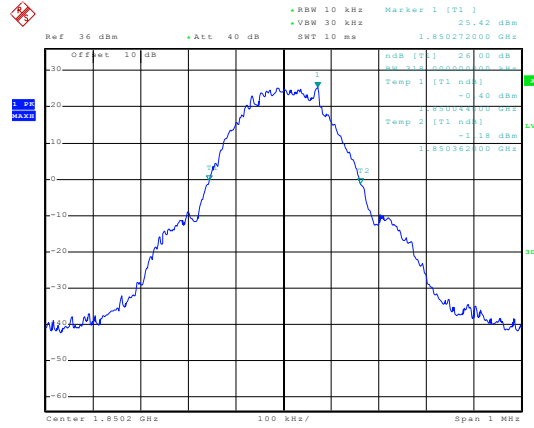

Date: 30.MAR.2015 15:07:11

Lowest channel

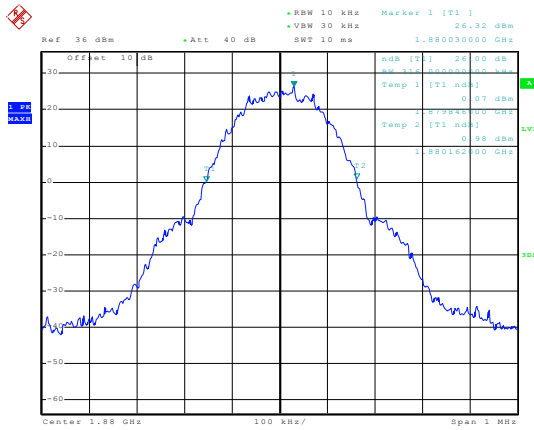

Date: 30.MAR.2015 15:08:00

Middle channel

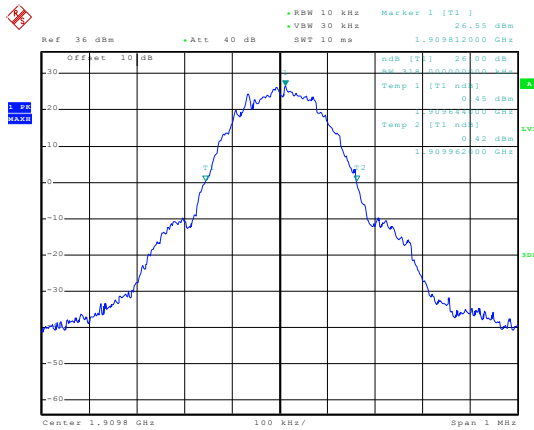

Date: 30.MAR.2015 15:10:03

Highest channel

99% Occupy bandwidth UMTS 850 12.2k RMC

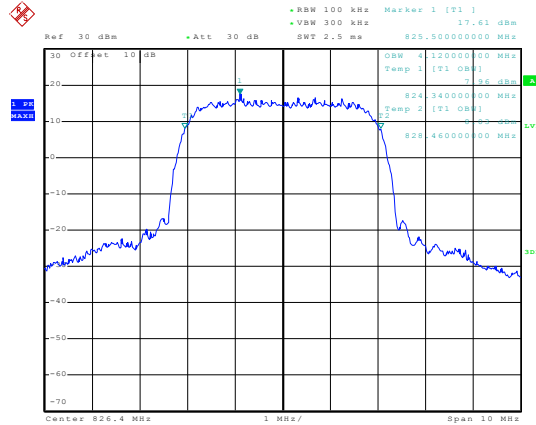

Date: 30.JUL.2015 16:13:38

Lowest channel

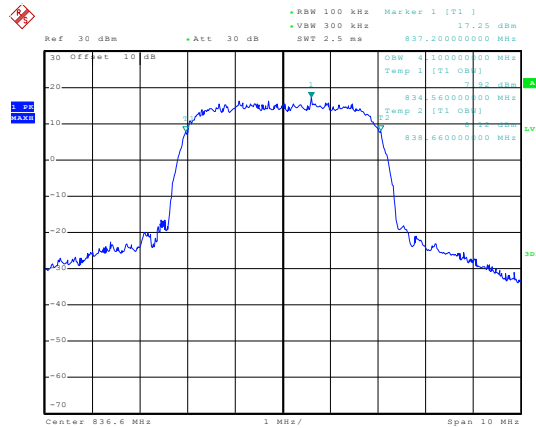

Date: 30.JUL.2015 16:14:59

Middle channel

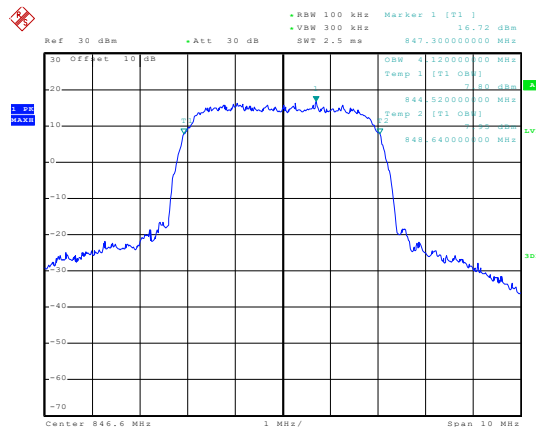

Date: 30.JUL.2015 16:15:30

Highest channel

26dB Emission Bandwidth UMTS 850 12.2k RMC

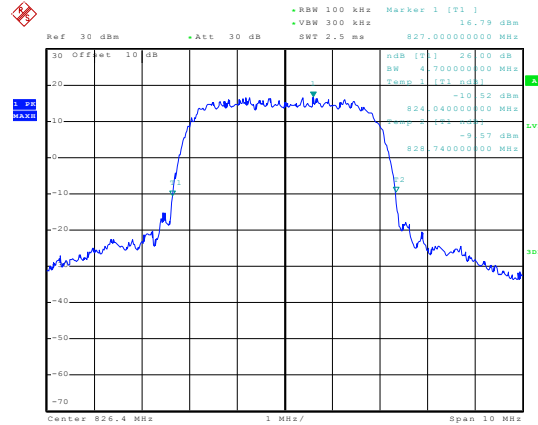

Date: 30.JUL.2015 16:14:04

Lowest channel

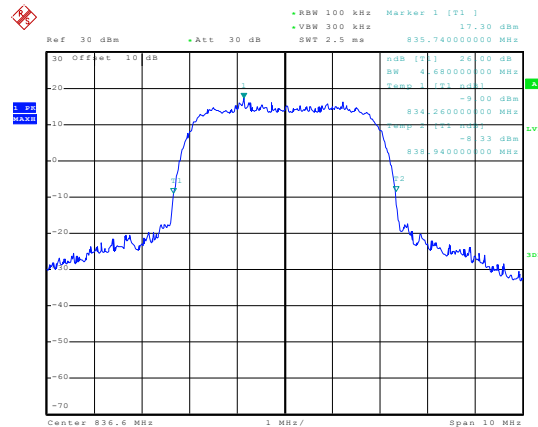

Date: 30.JUL.2015 16:14:34

Middle channel

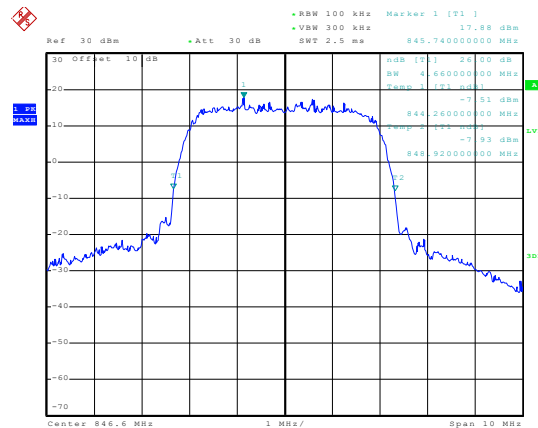

Date: 30.JUL.2015 16:15:56

Highest channel

99% Occupy bandwidth UMTS 1900 12.2k RMC

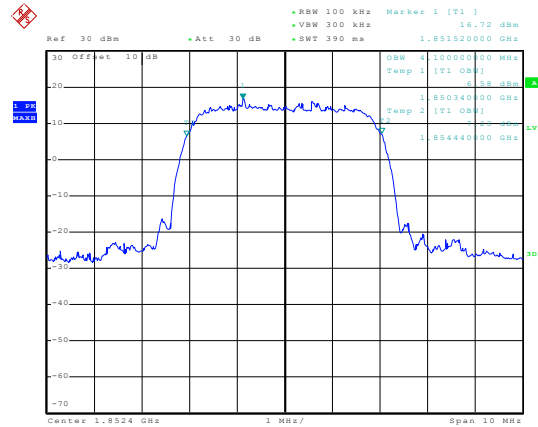

Date: 30.JUL.2015 16:30:19

Lowest channel

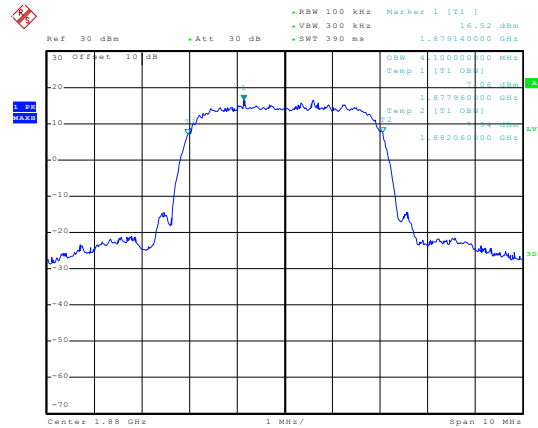

Date: 30.JUL.2015 16:30:00

Middle channel

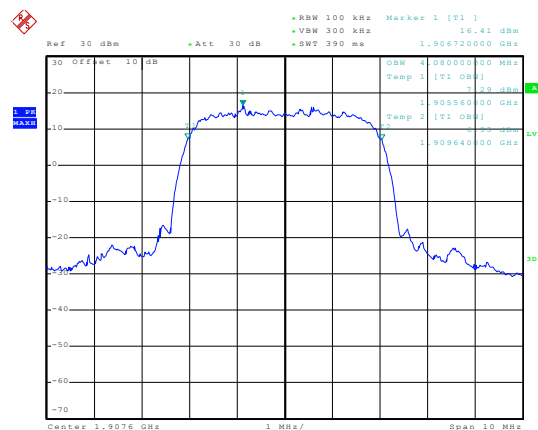

Date: 30.JUL.2015 16:29:08

Highest channel

26dB Emission Bandwidth UMTS 1900 12.2k RMC

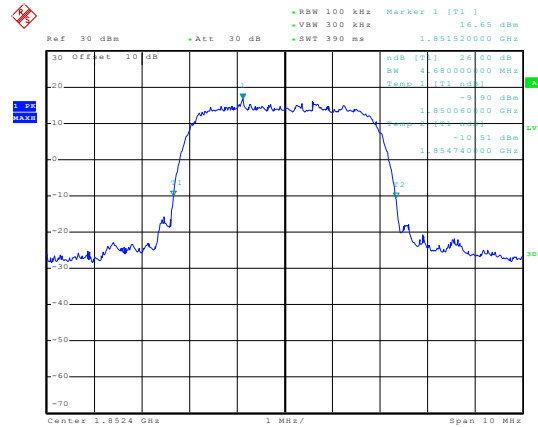

Date: 30.JUL.2015 16:30:38

Lowest channel

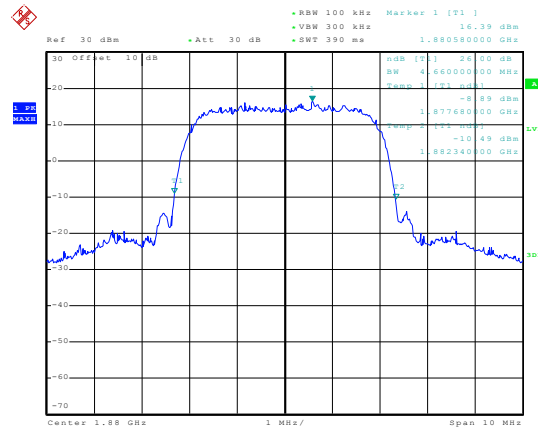

Date: 30.JUL.2015 16:29:42

Middle channel

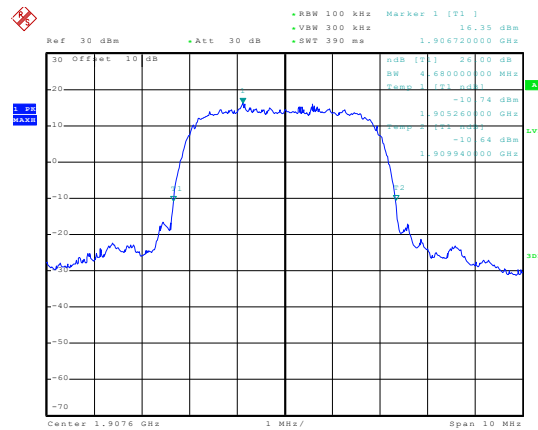

Date: 30.JUL.2015 16:29:25

Highest channel

6.7 Peak-to-Average Ratio

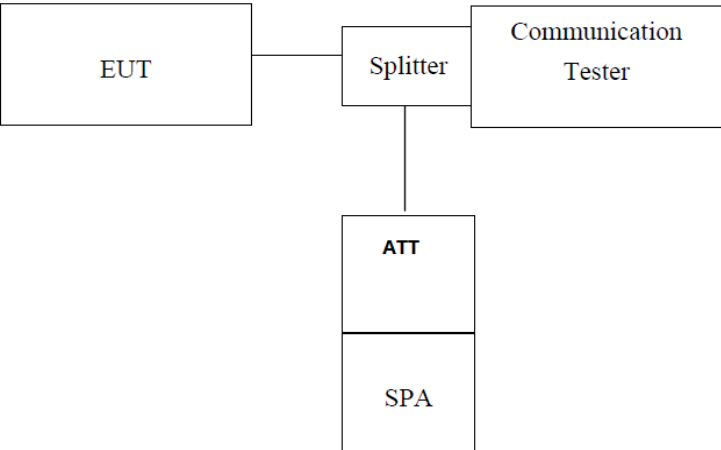
| | |
|-------------------|--|
| Test Requirement: | FCC part 24.232(d) |
| Limit: | The peak-to-average ratio (PAR) of the transmission may not exceed 13 dB. |
| Test setup: |  <p><i>Note: Measurement setup for testing on Antenna connector</i></p> |
| Test Procedure: | <ol style="list-style-type: none"> 1 The RF output of the transceiver was connected to a spectrum analyzer through appropriate attenuation. 2 Set the CCDF option in spectrum analyzer, $RBW \geq OBW$, 3 Set the EUT working in highest power level, measured and recorded the 0.1% as PAPR level. 4 Repeat step 1~3 at other frequency and modulations. |
| Test Instruments: | Refer to section 5.8 for details |
| Test mode: | Refer to section 5.3 for details |
| Test results: | Passed |

Measurement Data (worst case)

| Modulation | Test channel | PAPR |
|--------------|--------------|------|
| GSM 850 | 190 | 0.07 |
| PCS 1900 | 661 | 0.06 |
| UMTS 850 RMC | 4183 | 3.28 |
| UMTS1900 RMC | 9400 | 3.40 |

Test plots as below:

Middle channel
Modulation: GSM 850

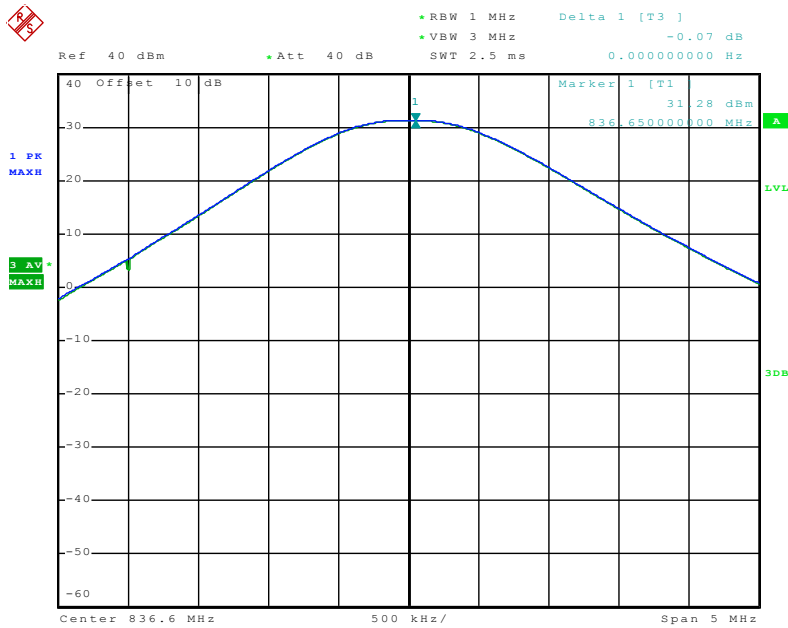

Date: 30.JUL.2015 15:52:53

Middle channel
Modulation: PCS 1900

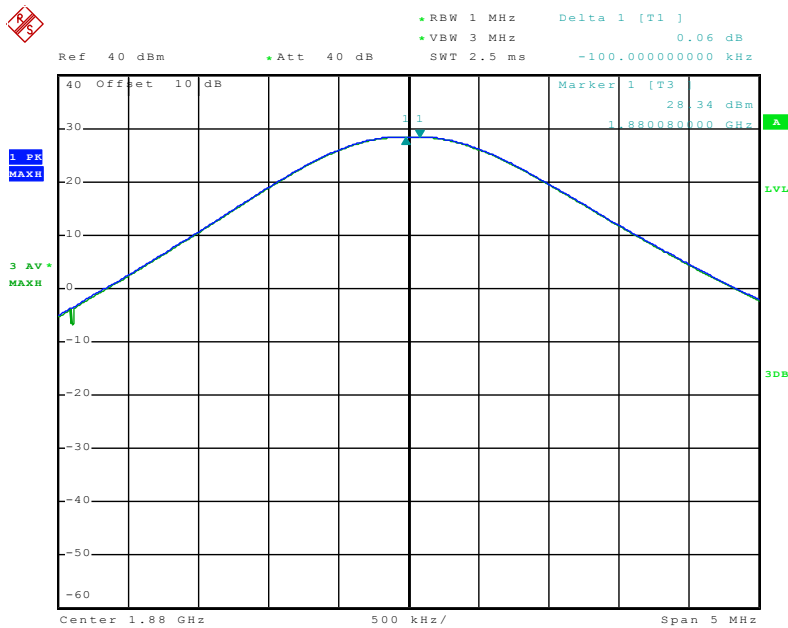

Date: 30.JUL.2015 15:42:58

Middle channel

Middle channel

Modulation: UMTS 850 RMC

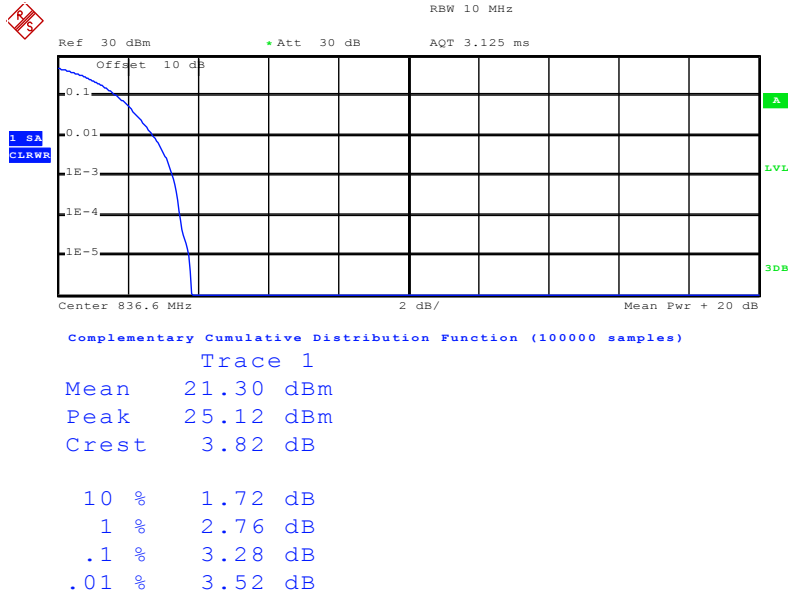

Date: 30.JUL.2015 16:11:57

Middle channel

Modulation: UMTS1900 RMC

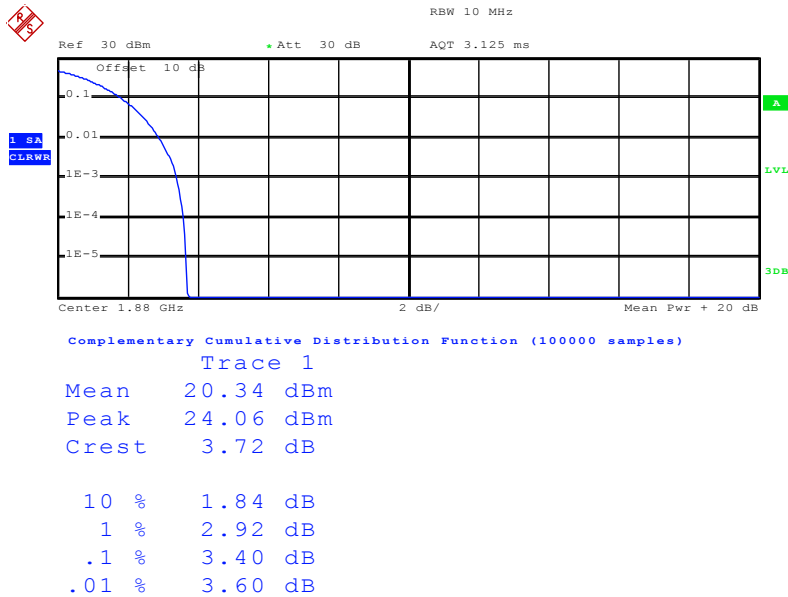

Date: 30.JUL.2015 16:31:12

6.8 Modulation Characteristic

According to FCC § 2.1047(d), Part 22H & 24E there is no specific requirement for digital modulation, therefore modulation characteristic is not presented.

6.9 Out of band emission at antenna terminals

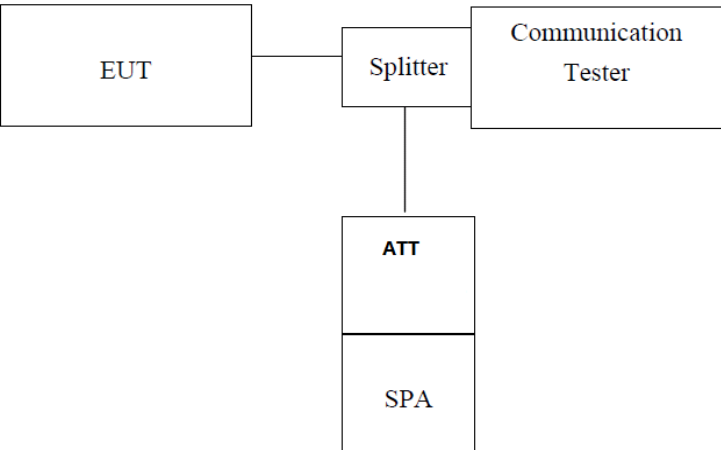
| | |
|-------------------|--|
| Test Requirement: | FCC part 22.917(a) and FCC part 24.238(a) |
| Test Method: | FCC part 2.1051 |
| Limit: | -13dBm |
| Test setup: |  <p><i>Note: Measurement setup for testing on Antenna connector</i></p> |
| Test Procedure: | <ol style="list-style-type: none"> 5 The RF output of the transceiver was connected to a spectrum analyzer through appropriate attenuation. 6 The resolution bandwidth of the spectrum analyzer was set at 100 kHz when below 1GHz, 1MHz when above 1 GHz; sufficient scans were taken to show the out of band Emissions if any up to 10th harmonic. 7 For the out of band: Set the RBW=100 kHz, VBW=300 kHz when below 1 GHz, RBW =1 MHz, VBW=3 MHz when above 1 GHz, Start=30MHz, Stop= 10th harmonic. 8 Band Edge Requirements: In the 1 MHz bands immediately outside and adjacent to the frequency block, a resolution bandwidth of at least 1 percent of the emission bandwidth of the fundamental emission of the transmitter may be employed to measure the out of band Emissions. |
| Test Instruments: | Refer to section 5.8 for details |
| Test mode: | Refer to section 5.3 for details |
| Test results: | Passed |

Test plots as follows:

Spurious emission

GSM 850

Lowest Channel

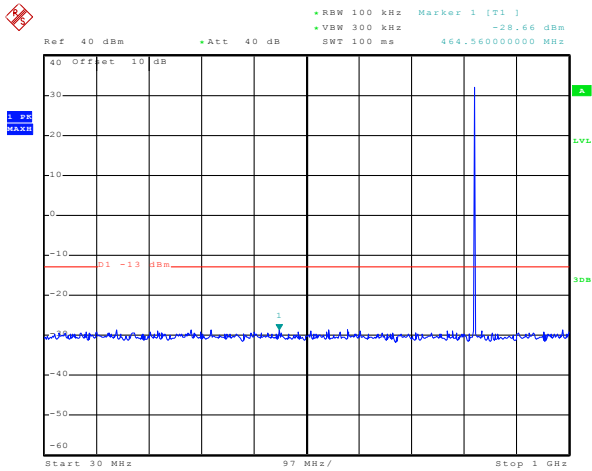

Date: 2.SEP.2015 17:28:54

30MHz~1GHz

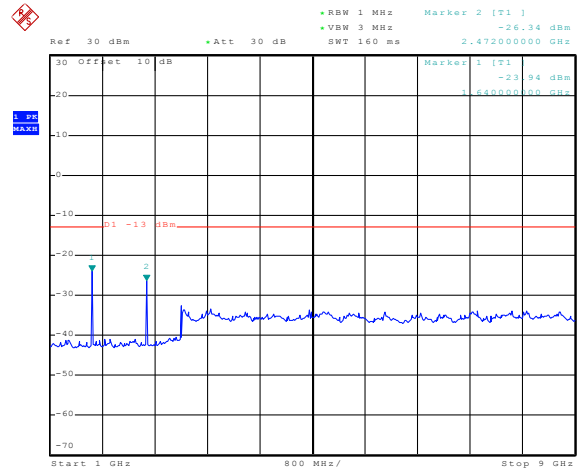

Date: 2.SEP.2015 17:23:04

1GHz~9GHz

Middle channel

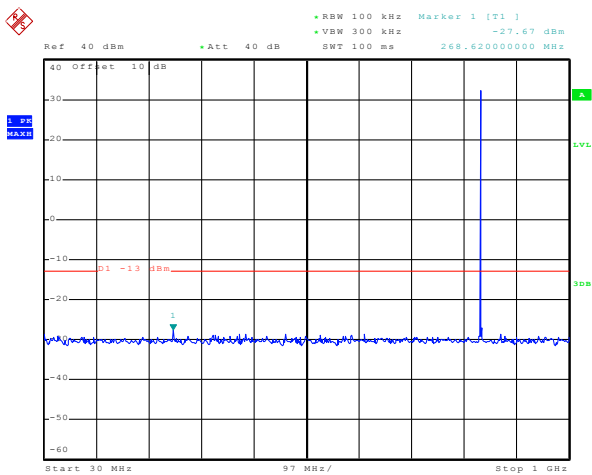

Date: 2.SEP.2015 17:29:40

30MHz~1GHz

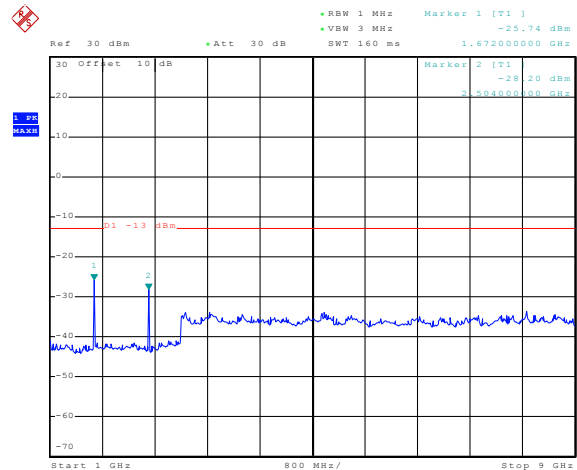

Date: 2.SEP.2015 17:23:49

1GHz~9GHz

Highest Channel

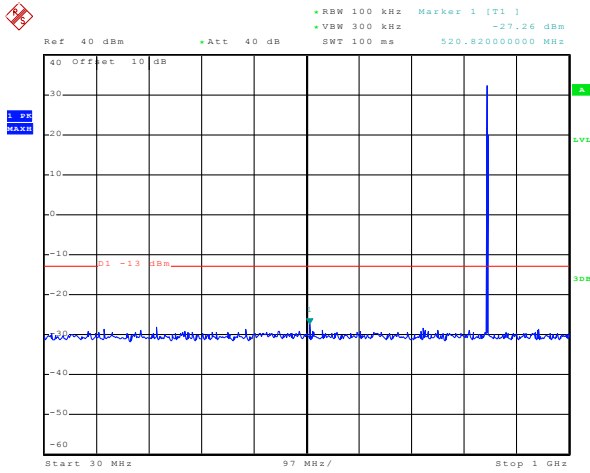

Date: 2.SRP.2015 17:30:12

30MHz~1GHz

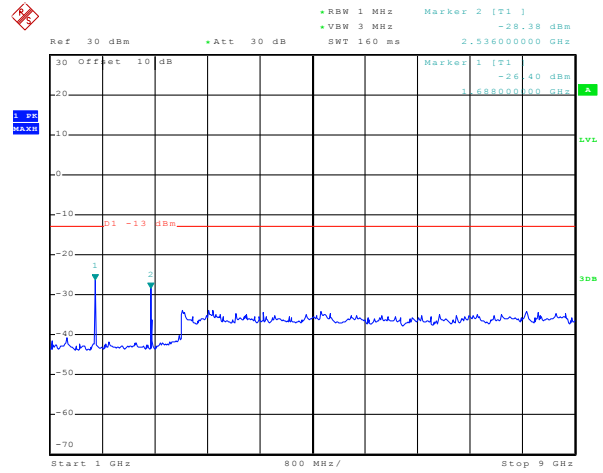

Date: 2.SRP.2015 17:24:24

1GHz~9GHz

PCS 1900

Lowest Channel

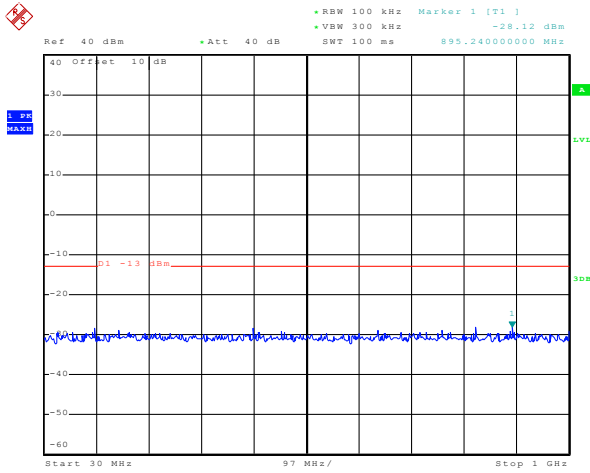

Date: 30..III..2015 15:37:10

30MHz~1GHz

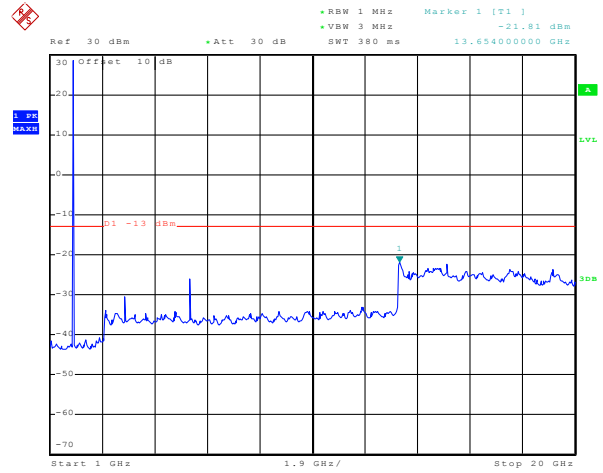

Date: 30..III..2015 15:39:15

1GHz~20GHz

Middle Channel

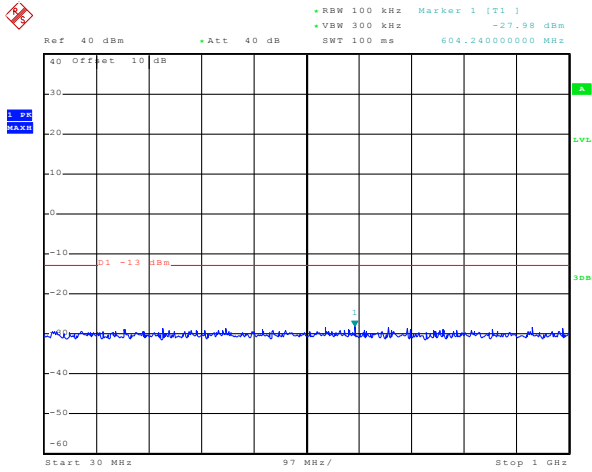

Date: 30..III..2015 15:36:50

30MHz~1GHz

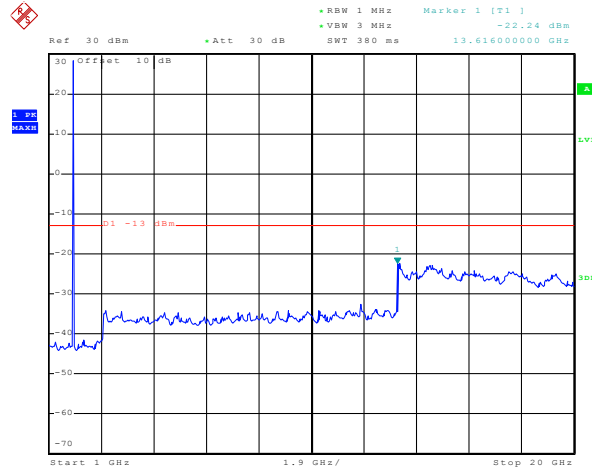

Date: 30..III..2015 15:39:44

1GHz~20GHz

Highest Channel

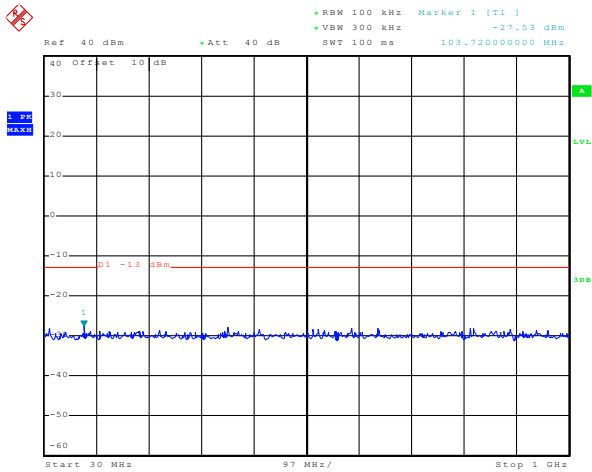

Date: 30..III..2015 15:32:15

30MHz~1GHz

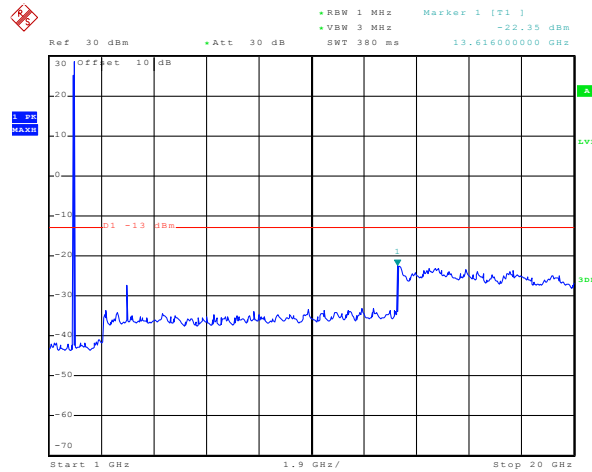

Date: 30..III..2015 15:40:46

1GHz~20GHz

UMTS 850 12.2k RMC

Lowest Channel

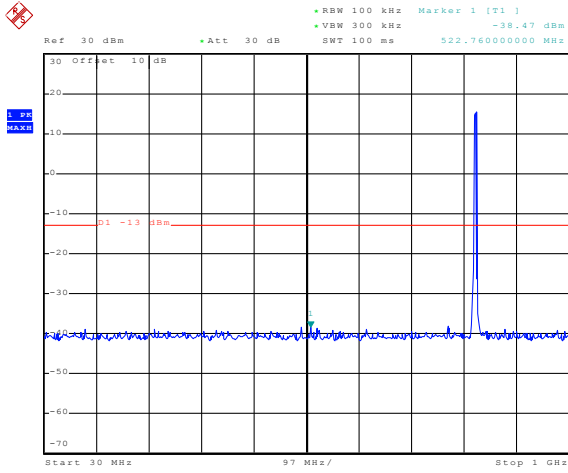

Date: 30..JUL..2015 16:18:30

30MHz~1GHz

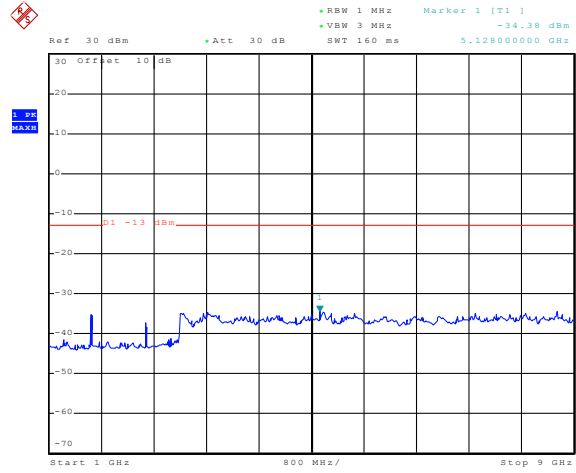

Date: 30..JUL..2015 16:19:26

1GHz~9GHz

Middle Channel

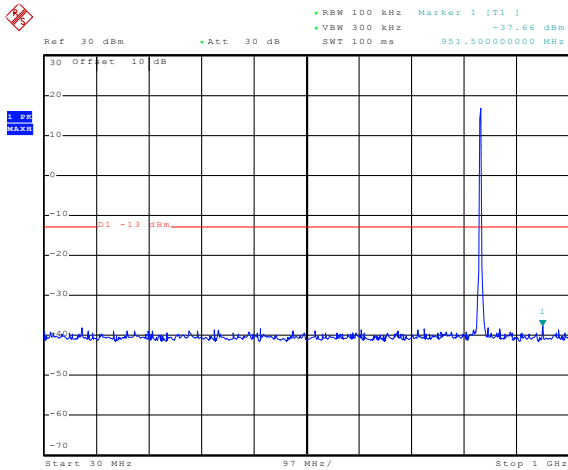

Date: 30..JUL..2015 16:18:07

30MHz~1GHz

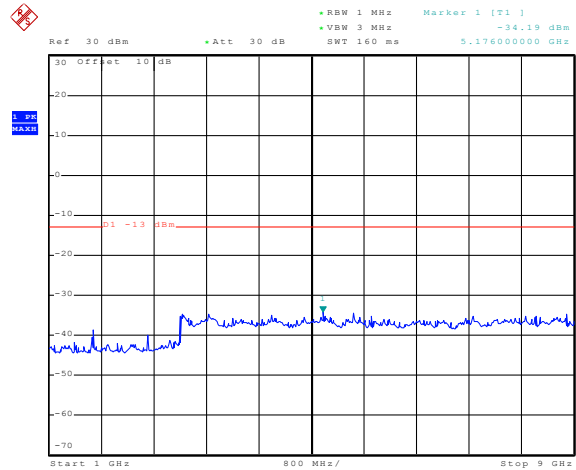

Date: 30..JUL..2015 16:19:48

1GHz~9GHz

Highest Channel

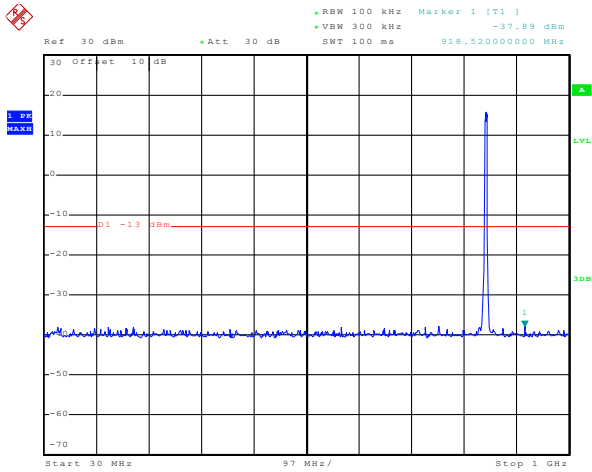

Date: 30.JUL.2015 16:17:36

30MHz~1GHz

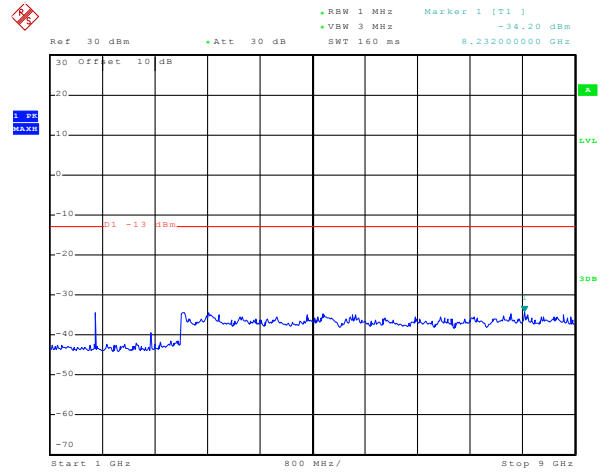

Date: 30.JUL.2015 16:20:18

1GHz~9GHz

UMTS 1900 12.2k RMC

Lowest Channel

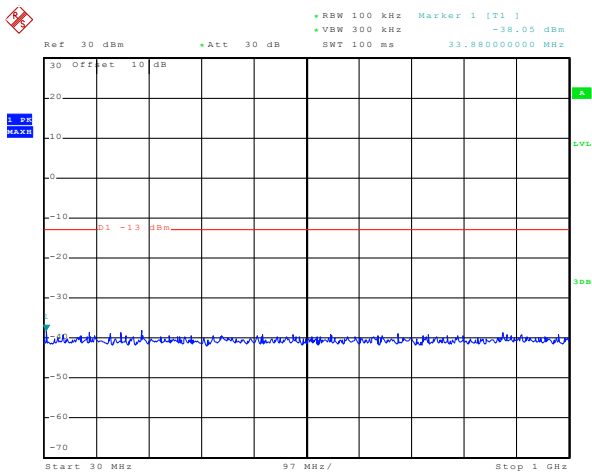

Date: 30.JUL.2015 16:25:30

30MHz~1GHz

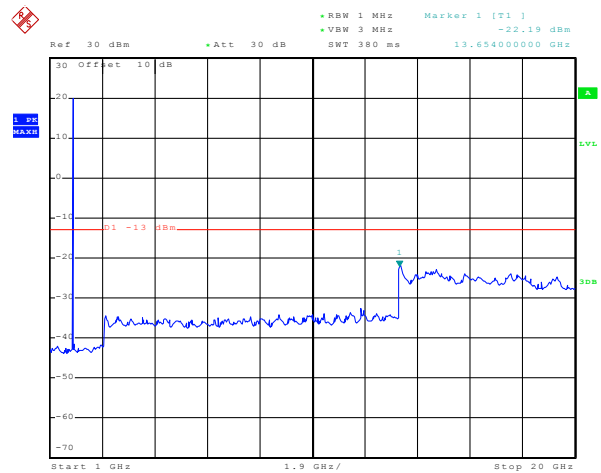

Date: 30.JUL.2015 16:26:42

1GHz~20GHz

Middle Channel

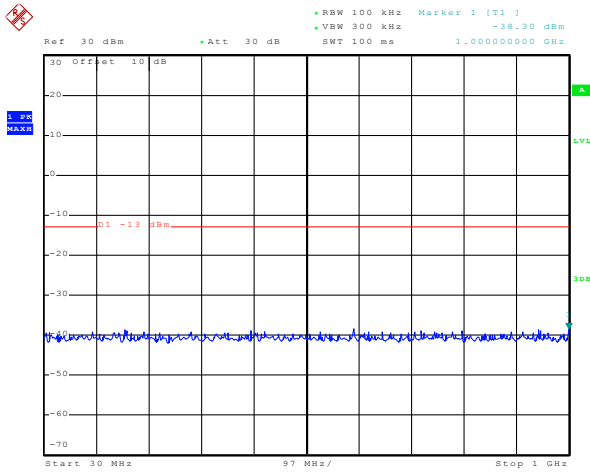

Date: 30.JUL.2015 16:25:10

30MHz~1GHz

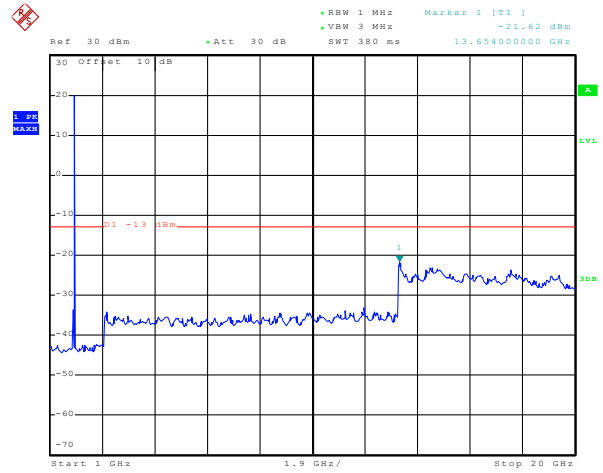

Date: 30.JUL.2015 16:27:06

1GHz~20GHz

Highest Channel

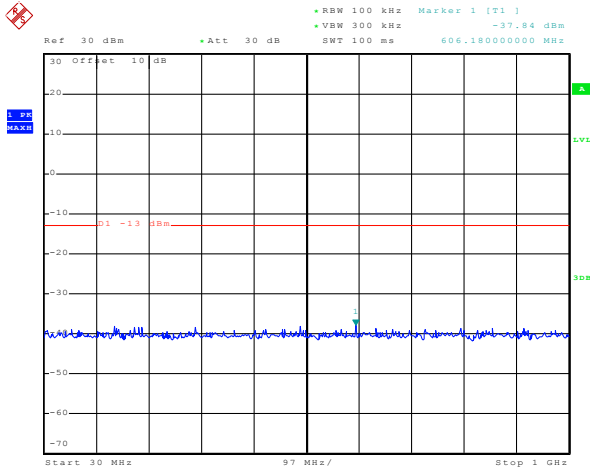

Date: 30.JUL.2015 16:24:48

30MHz~1GHz

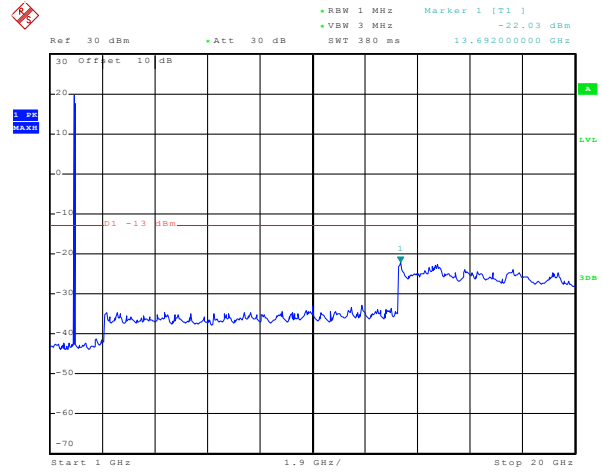

Date: 30.JUL.2015 16:28:05

1GHz~20GHz

Band edge emission

GSM850

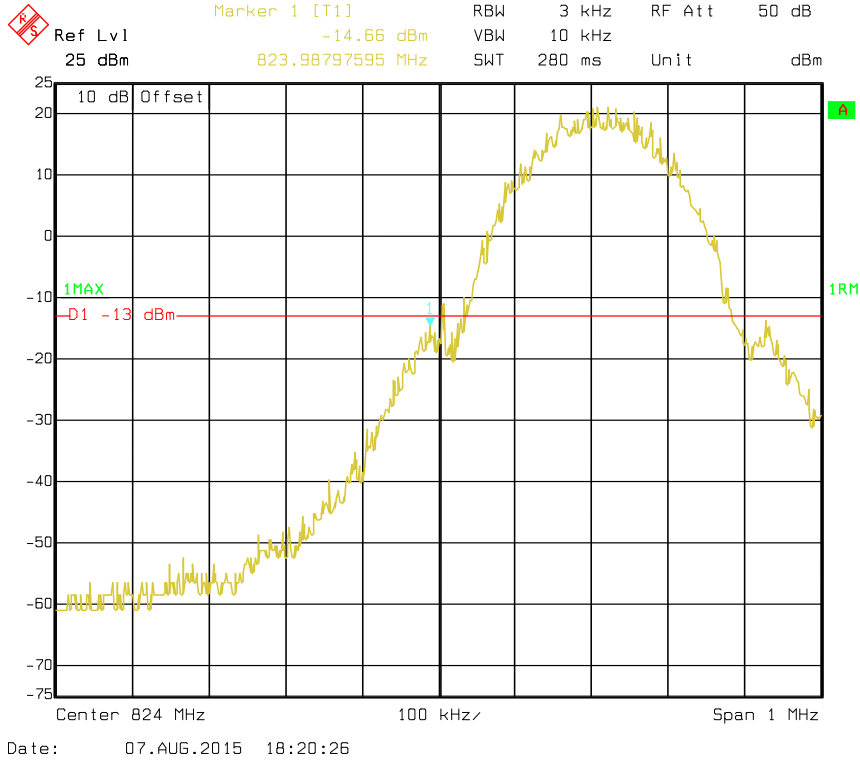

Lowest channel

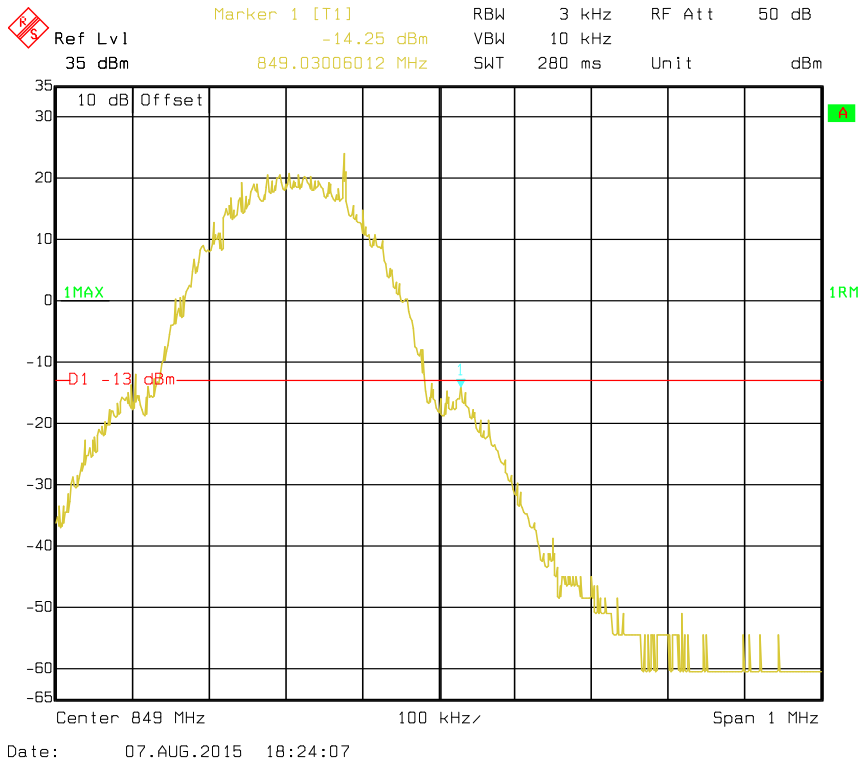

Highest channel

PCS1900

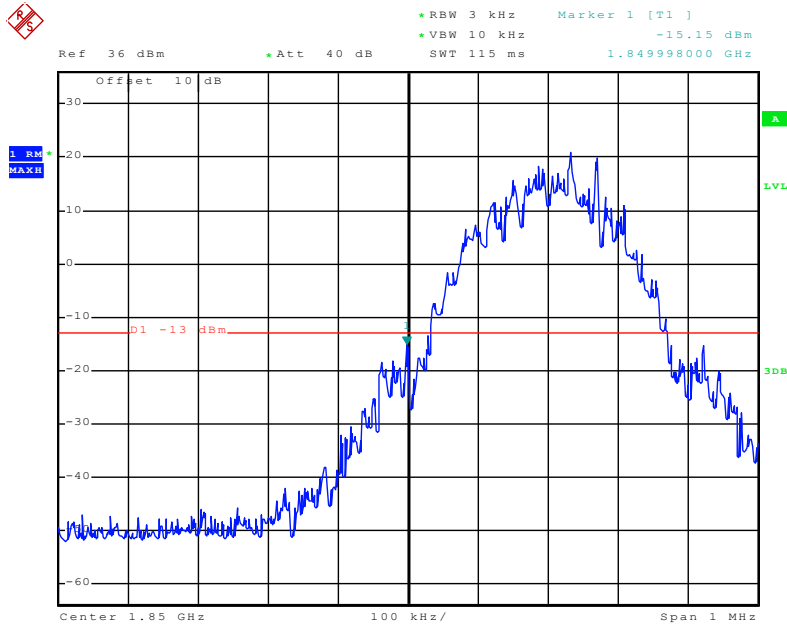

Date: 30.JUL.2015 15:29:23

Lowest channel

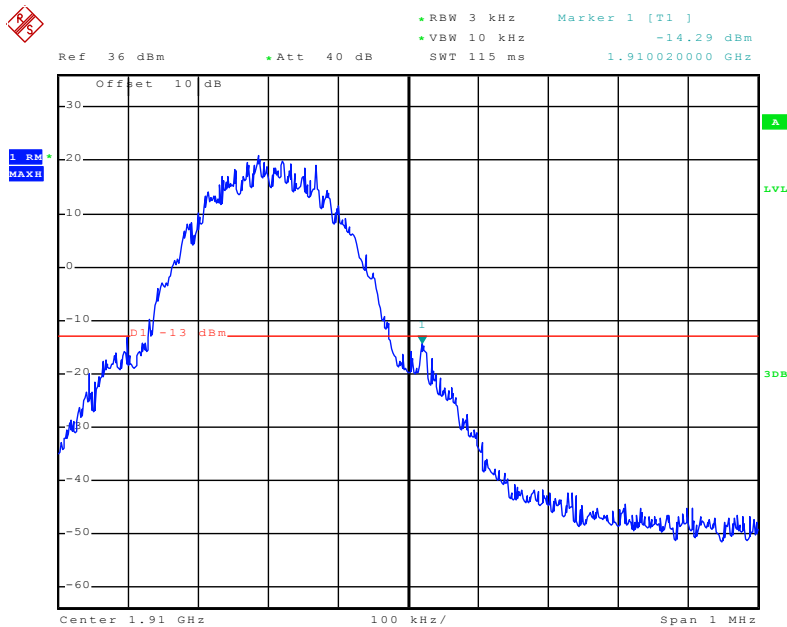

Date: 30.JUL.2015 15:30:20

Highest channel

UMTS850 12.2k RMC

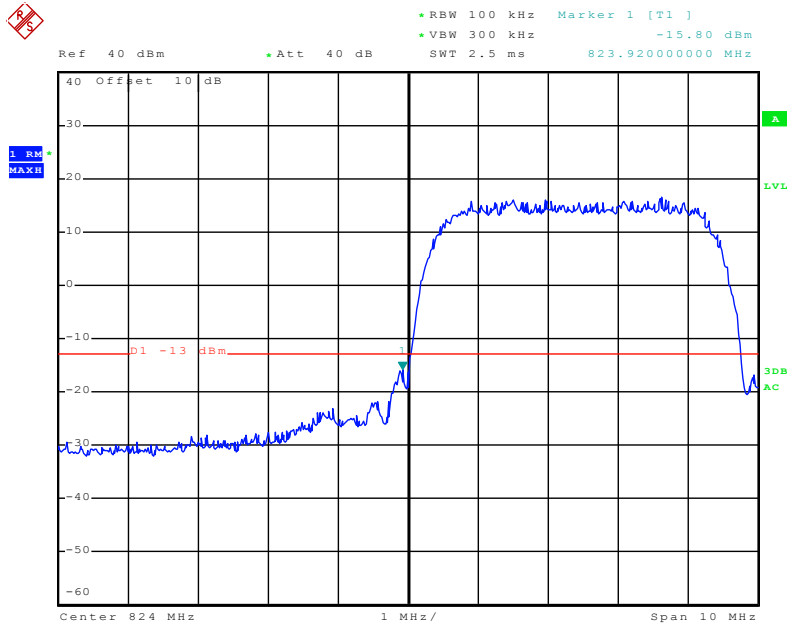

Date: 7.SEP.2015 00:05:04

Lowest channel

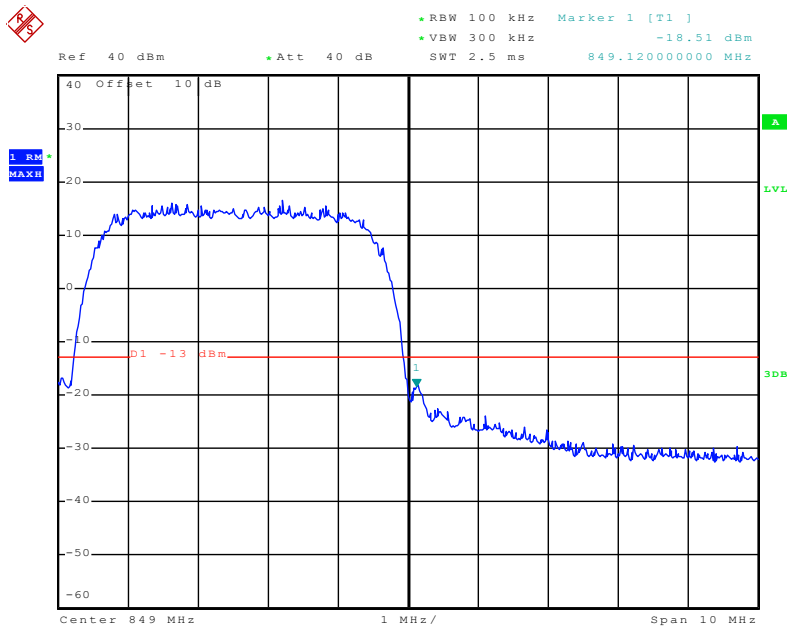

Date: 30.JUL.2015 16:08:03

Highest channel

UMTS 1900 12.2k RMC

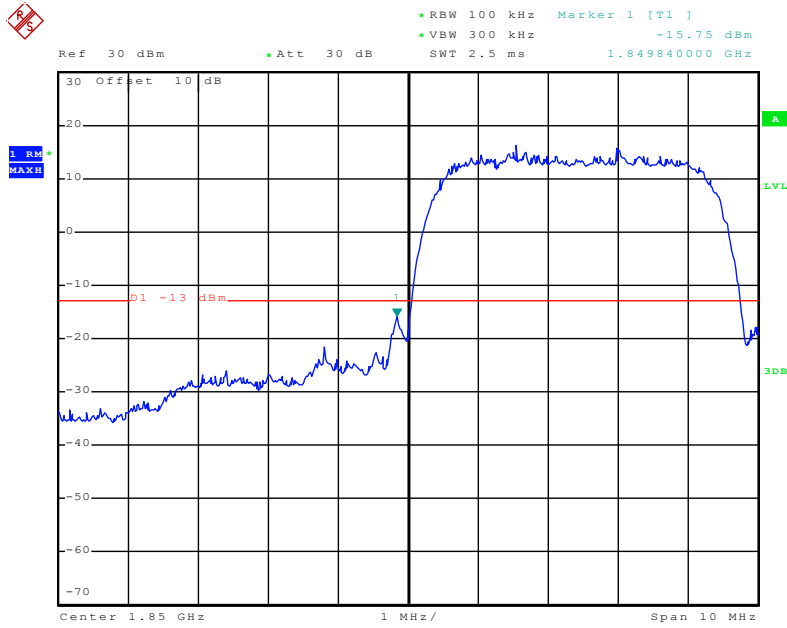

Date: 30.JUL.2015 16:22:43

Lowest channel

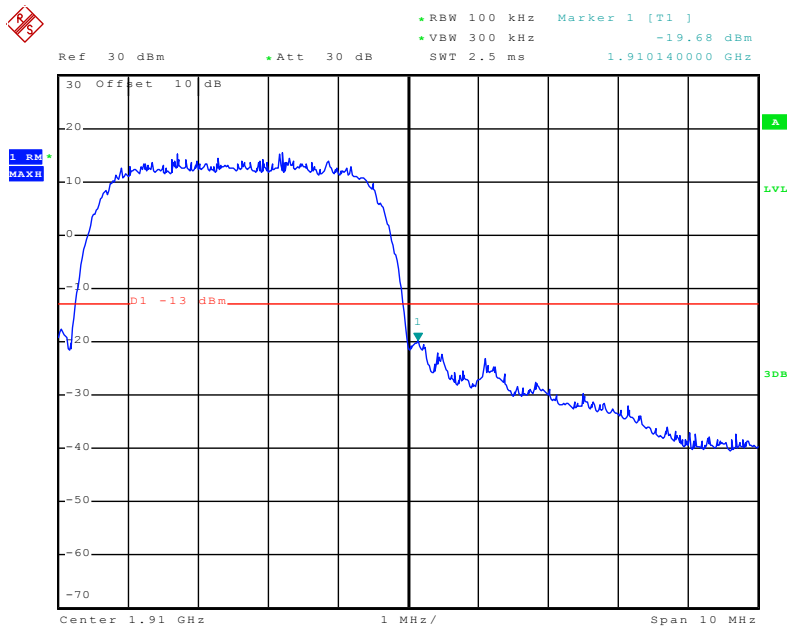

Date: 30.JUL.2015 16:23:54

Highest channel

6.10 ERP, EIRP Measurement

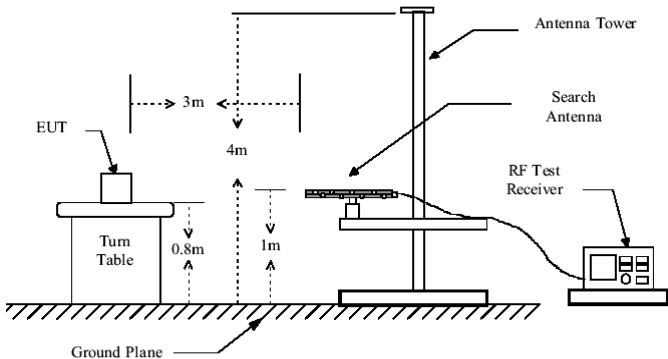
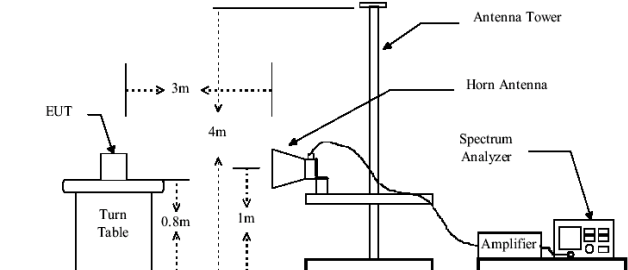
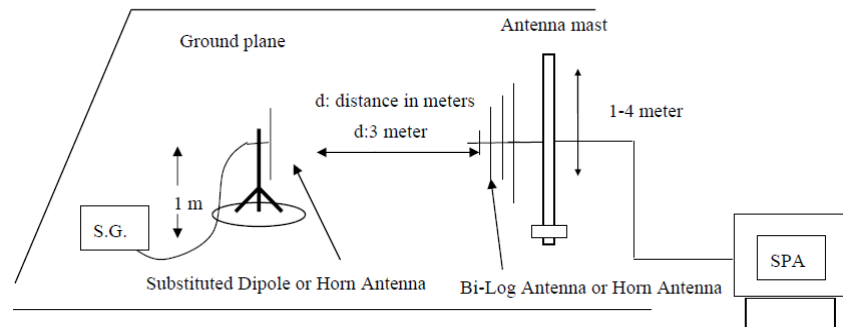
| | |
|-------------------|--|
| Test Requirement: | FCC part 22.913(a) and FCC part 24.232(b) |
| Test Method: | FCC part 2.1046 |
| Limit: | GSM850 7W ERP PCS1900 2W EIRP WCDMA Band V: 7W ERP WCDMA Band II: 2W EIRP |
| Test setup: | <p>Below 1GHz</p>  <p>Above 1GHz</p>  <p>Substituted method:</p>  |

| | |
|--------------------------|--|
| <p>Test Procedure:</p> | <ol style="list-style-type: none"> 1. The EUT was placed on a non-conductive turntable using a non-conductive support. The radiated emission at the fundamental frequency was measured at 3 m with a test antenna and EMI spectrum analyzer. 2. During the measurement, the EUT was in communication with the station. The highest emission was recorded with the rotation of the turntable and the lowering of the test antenna from 4m to 1m. The reading was recorded and the field strength (E in dBuV/m) was calculated. 3. ERP in frequency band 824.2 –848.80.8MHz were measured using a substitution method. The EUT was replaced by a dipole antenna connected, the S.G. output was recorded and ERP was calculated as follows: $\text{ERP} = \text{S.G. output (dBm)} + \text{Antenna Gain (dBd)} - \text{Cable Loss (dB)}$ 4. EIRP in frequency band 1850.2 –1909.8MHz were measured using a substitution method. The EUT was replaced by a horn antenna connected, the S.G. output was recorded and EIRP was calculated as follows: $\text{EIRP} = \text{S.G. output (dBm)} + \text{Antenna Gain (dBi)} - \text{Cable Loss (dB)}$ 5. The worst case was relating to the conducted output power. |
| <p>Test Instruments:</p> | <p>Refer to section 5.8 for details</p> |
| <p>Test mode:</p> | <p>Refer to section 5.3 for details</p> |
| <p>Test results:</p> | <p>Passed (All three channels were tested, and just the worst case data were shown in the report.)</p> |

Measurement Data (worst case)

| EUT mode | Channel | EUT Pol. | Antenna Pol. | ERP(dBm) | Limit (dBm) | Result |
|----------|---------|----------|--------------|----------|-------------|--------|
| GSM850 | 251 | H | V | 24.47 | 38.45 | Pass |
| | | | H | 23.25 | | |

| EUT mode | Channel | EUT Pol. | Antenna Pol. | EIRP(dBm) | Limit (dBm) | Result |
|----------|---------|----------|--------------|-----------|-------------|--------|
| PCS1900 | 512 | H | V | 29.06 | 33.00 | Pass |
| | | | H | 23.29 | | |

| EUT mode | Channel | EUT Pol. | Antenna Pol. | ERP(dBm) | Limit (dBm) | Result |
|-----------------------|---------|----------|--------------|----------|-------------|--------|
| UMTS 850 12.2k RMC | 4132 | H | V | 20.59 | 38.45 | Pass |
| | | | H | 18.45 | | |

| EUT mode | Channel | EUT Pol. | Antenna Pol. | EIRP(dBm) | Limit (dBm) | Result |
|------------------------|---------|----------|--------------|-----------|-------------|--------|
| UMTS 1900 12.2k RMC | 9400 | H | V | 26.19 | 33.00 | Pass |
| | | | H | 18.00 | | |

6.11 Field strength of spurious radiation measurement

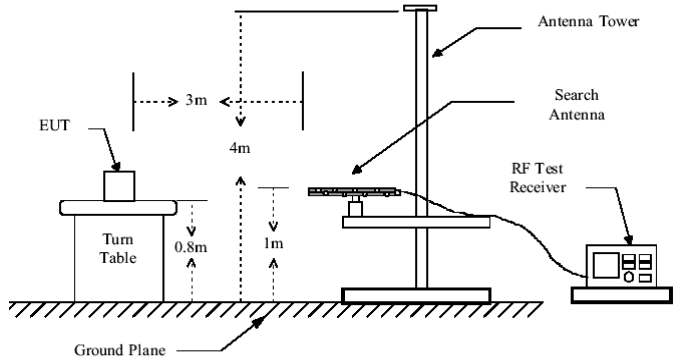
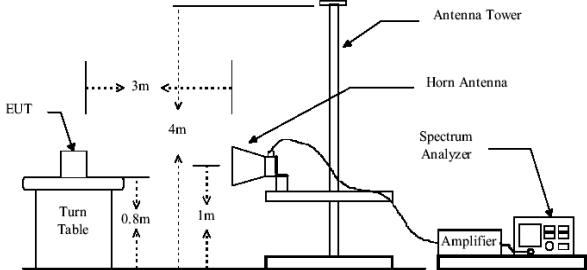
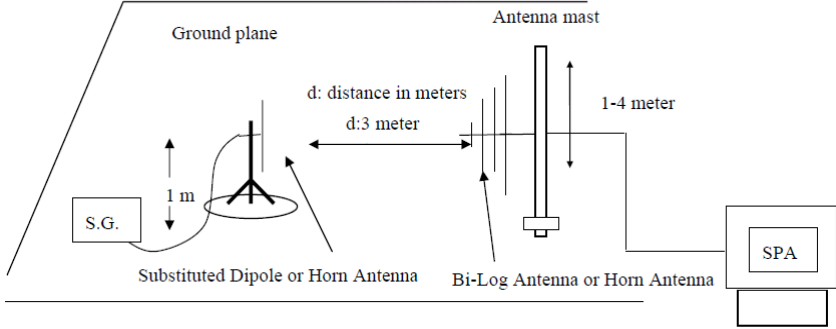
| | |
|-------------------|--|
| Test Requirement: | FCC part 22.917(a) and FCC part 24.238(a) |
| Test Method: | FCC part 2.1053 |
| Limit: | -13dBm |
| Test setup: | <p>Below 1GHz</p>  <p>Above 1GHz</p>  <p>Substituted method:</p>  |
| Test Procedure: | <ol style="list-style-type: none"> 1. The EUT was placed on an non-conductive turntable using a non-conductive support. The radiated emission at the fundamental frequency was measured at 3 m with a test antenna and EMI spectrum analyzer. 2. During the tests, the antenna height and the EUT azimuth were varied in order to identify the maximum level of emissions from the EUT. This maximization process was repeated with the EUT positioned in each of its three orthogonal orientations. 3. The frequency range up to tenth harmonic was investigated for each of three fundamental frequency (low, middle and high channels). Once spurious emission was identified, the power of the emission was determined using the substitution method. 4. The spurious emissions attenuation was calculated as the difference |

| | |
|-------------------|---|
| | between radiated power at the fundamental frequency and the spurious emissions frequency. $ERP / EIRP = S.G. \text{ output (dBm)} + \text{Antenna Gain(dB/dBi)} - \text{Cable Loss (dB)}$ |
| Test Instruments: | Refer to section 5.8 for details |
| Test mode: | Refer to section 5.3 for details. Based on the ERP/EIRP results, we selected GSM850, PCS1900, UMTS RMC 850 and UMTS RMC 1900 for Radiated spurious emission test, other modes were not test. |
| Test results: | Passed |

Measurement Data (worst case)

| Test mode: | GSM850 | | Test channel: | Lowest |
|-----------------|-------------------|-------------|---------------|---------|
| Frequency (MHz) | Spurious Emission | | Limit (dBm) | Result |
| | Polarization | Level (dBm) | | |
| 1648.40 | Vertical | -47.38 | -13.00 | Pass |
| 2472.60 | V | -41.52 | | |
| 3296.80 | V | -45.44 | | |
| 1648.40 | Horizontal | -53.88 | -13.00 | Pass |
| 2472.60 | H | -44.78 | | |
| 4121.00 | H | -46.53 | | |
| Test mode: | GSM850 | | Test channel: | Middle |
| Frequency (MHz) | Spurious Emission | | Limit (dBm) | Result |
| | Polarization | Level (dBm) | | |
| 1673.20 | Vertical | -47.28 | -13.00 | Pass |
| 2509.80 | V | -46.12 | | |
| 4183.00 | V | -46.62 | | |
| 1673.20 | Horizontal | -51.27 | -13.00 | Pass |
| 3346.40 | H | -46.37 | | |
| 4183.00 | H | -48.42 | | |
| Test mode: | GSM850 | | Test channel: | Highest |
| Frequency (MHz) | Spurious Emission | | Limit (dBm) | Result |
| | Polarization | Level (dBm) | | |
| 1697.60 | Vertical | -45.59 | -13.00 | Pass |
| 2546.40 | V | -49.79 | | |
| 4244.00 | V | -46.65 | | |
| 1697.60 | Horizontal | -49.58 | -13.00 | Pass |
| 2546.40 | H | -47.81 | | |
| 4244.00 | H | -48.32 | | |

Remark:

- The emission levels of below 1 GHz are very lower than the limit and not show in test report.

| Test mode: | PCS1900 | | Test channel: | Lowest |
|-----------------|-------------------|-------------|---------------|---------|
| Frequency (MHz) | Spurious Emission | | Limit (dBm) | Result |
| | Polarization | Level (dBm) | | |
| 3700.40 | Vertical | -31.98 | -13.00 | Pass |
| 9251.00 | V | -33.77 | | |
| 3700.40 | Horizontal | -36.78 | -13.00 | Pass |
| 9251.00 | H | -30.37 | | |
| Test mode: | PCS1900 | | Test channel: | Middle |
| Frequency (MHz) | Spurious Emission | | Limit (dBm) | Result |
| | Polarization | Level (dBm) | | |
| 3760.00 | Vertical | -31.89 | -13.00 | Pass |
| 9400.00 | V | -36.74 | | |
| 3760.00 | Horizontal | -38.62 | -13.00 | Pass |
| 9400.00 | H | -34.72 | | |
| Test mode: | PCS1900 | | Test channel: | Highest |
| Frequency (MHz) | Spurious Emission | | Limit (dBm) | Result |
| | Polarization | Level (dBm) | | |
| 3819.60 | Vertical | -32.08 | -13.00 | Pass |
| 9549.00 | V | -39.40 | | |
| 3819.60 | Horizontal | -38.28 | -13.00 | Pass |
| 9549.00 | H | -39.21 | | |

Remark:

1. The emission levels of below 1 GHz are very lower than the limit and not show in test report.

| Test mode: | | UMTS850 12.2k RMC | | Test channel: | Lowest |
|-----------------|-------------------|-------------------|-------------|---------------|---------|
| Frequency (MHz) | Spurious Emission | | Limit (dBm) | Result | |
| | Polarization | Level (dBm) | | | |
| 1652.80 | Vertical | -47.77 | -13.00 | Pass | |
| 2479.20 | V | -42.90 | | | |
| 4132.00 | V | -47.49 | | | |
| 1652.80 | Horizontal | -53.46 | -13.00 | Pass | |
| 2479.20 | H | -45.48 | | | |
| 3305.60 | H | -47.09 | | | |
| 4132.00 | H | -41.02 | | | |
| Test mode: | | UMTS850 12.2k RMC | | Test channel: | Middle |
| Frequency (MHz) | Spurious Emission | | Limit (dBm) | Result | |
| | Polarization | Level (dBm) | | | |
| 1673.20 | Vertical | -43.94 | -13.00 | Pass | |
| 2509.80 | V | -42.08 | | | |
| 1673.20 | Horizontal | -51.18 | -13.00 | Pass | |
| 4183.00 | H | -44.24 | | | |
| Test mode: | | UMTS850 12.2k RMC | | Test channel: | Highest |
| Frequency (MHz) | Spurious Emission | | Limit (dBm) | Result | |
| | Polarization | Level (dBm) | | | |
| 1693.20 | Vertical | -40.28 | -13.00 | Pass | |
| 2539.80 | V | -45.11 | | | |
| 4233.00 | V | -46.59 | | | |
| 1693.20 | Horizontal | -48.57 | -13.00 | Pass | |
| 2539.80 | H | -44.45 | | | |
| 4233.00 | H | -46.43 | | | |

Remark:

- The emission levels of below 1 GHz are very lower than the limit and not show in test report.

| Test mode: | UMTS 1900 12.2k RMC | | Test channel: | Lowest |
|-----------------|---------------------|-------------|---------------|---------|
| Frequency (MHz) | Spurious Emission | | Limit (dBm) | Result |
| | Polarization | Level (dBm) | | |
| 3704.80 | Vertical | -44.39 | -13.00 | Pass |
| 5557.20 | V | -42.46 | | |
| 3704.80 | Horizontal | -47.90 | -13.00 | Pass |
| 9262.00 | H | -44.01 | | |
| Test mode: | UMTS 1900 12.2k RMC | | Test channel: | Middle |
| Frequency (MHz) | Spurious Emission | | Limit (dBm) | Result |
| | Polarization | Level (dBm) | | |
| 3760.00 | Vertical | -44.51 | -13.00 | Pass |
| 9400.00 | V | -40.01 | | |
| 3760.00 | Horizontal | -47.75 | -13.00 | Pass |
| 9400.00 | H | -43.05 | | |
| Test mode: | UMTS 1900 12.2k RMC | | Test channel: | Highest |
| Frequency (MHz) | Spurious Emission | | Limit (dBm) | Result |
| | Polarization | Level (dBm) | | |
| 3815.20 | Vertical | -43.31 | -13.00 | Pass |
| 9538.00 | V | -38.15 | | |
| 3815.20 | Horizontal | -46.41 | -13.00 | Pass |
| 9538.00 | H | -42.85 | | |

Remark:

1. The emission levels of below 1 GHz are very lower than the limit and not show in test report.

6.12 Frequency stability V.S. Temperature measurement

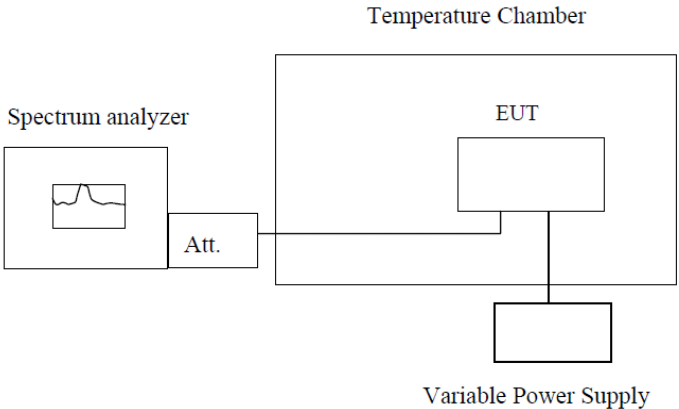
| | |
|-------------------|---|
| Test Requirement: | FCC Part 2.1055(a)(1)(b) |
| Test Method: | FCC Part 2.1055(a)(1)(b) |
| Limit: | 2.5 ppm |
| Test setup: |  <p style="text-align: center;">Note : Measurement setup for testing on Antenna connector</p> |
| Test procedure: | <ol style="list-style-type: none"> 1. The equipment under test was connected to an external DC power supply and input rated voltage. 2. RF output was connected to a frequency counter or spectrum analyzer via feed through attenuators. 3. The EUT was placed inside the temperature chamber. 4. Set the spectrum analyzer RBW low enough to obtain the desired frequency resolution and measure EUT 25°C operating frequency as reference frequency. 5. Turn EUT off and set the chamber temperature to -30°C. After the temperature stabilized for approximately 30 minutes recorded the frequency. 6. Repeat step measure with 10°C increased per stage until the highest temperature of +50°C reached |
| Test Instruments: | Refer to section 5.8 for details |
| Test mode: | Refer to section 5.3 for details |
| Test results: | Passed |
| Remark: | All three channels of all modulations have been tested, but only the worst channel and the worst modulation show in this test item. |

Measurement Data:

| Reference Frequency: GSM850 Middle channel=190 channel=836.6MHz | | | | | |
|---|------------------|-----------------|----------|-------------|--------|
| Power supplied (Vdc) | Temperature (°C) | Frequency error | | Limit (ppm) | Result |
| | | Hz | ppm | | |
| 3.70 | -30 | 179 | 0.213961 | 2.5 | Pass |
| | -20 | 164 | 0.196032 | | |
| | -10 | 154 | 0.184078 | | |
| | 0 | 153 | 0.182883 | | |
| | 10 | 148 | 0.176907 | | |
| | 20 | 121 | 0.144633 | | |
| | 30 | 132 | 0.157781 | | |
| | 40 | 125 | 0.149414 | | |
| | 50 | 124 | 0.148219 | | |
| Reference Frequency: PCS1900 Middle channel=661 channel=1880MHz | | | | | |
| Power supplied (Vdc) | Temperature (°C) | Frequency error | | Limit (ppm) | Result |
| | | Hz | ppm | | |
| 3.70 | -30 | 189 | 0.100532 | 2.5 | Pass |
| | -20 | 161 | 0.085638 | | |
| | -10 | 144 | 0.076596 | | |
| | 0 | 153 | 0.081383 | | |
| | 10 | 154 | 0.081915 | | |
| | 20 | 146 | 0.077660 | | |
| | 30 | 137 | 0.072872 | | |
| | 40 | 144 | 0.076596 | | |
| | 50 | 122 | 0.064894 | | |

| Reference Frequency: UMTS850 12.2k RMC Middle channel=4183 channel=836.6MHz | | | | | |
|---|------------------|-----------------|----------|-------------|--------|
| Power supplied (Vdc) | Temperature (°C) | Frequency error | | Limit (ppm) | Result |
| | | Hz | ppm | | |
| 3.70 | -30 | 158 | 0.188860 | 2.5 | Pass |
| | -20 | 124 | 0.148219 | | |
| | -10 | 121 | 0.144633 | | |
| | 0 | 134 | 0.160172 | | |
| | 10 | 145 | 0.173321 | | |
| | 20 | 121 | 0.144633 | | |
| | 30 | 102 | 0.121922 | | |
| | 40 | 103 | 0.123117 | | |
| | 50 | 124 | 0.148219 | | |
| Reference Frequency: UMTS1900 12.2k RMC Middle channel=9400 channel=1880MHz | | | | | |
| Power supplied (Vdc) | Temperature (°C) | Frequency error | | Limit (ppm) | Result |
| | | Hz | ppm | | |
| 3.70 | -30 | 158 | 0.084043 | 2.5 | Pass |
| | -20 | 141 | 0.075000 | | |
| | -10 | 143 | 0.076064 | | |
| | 0 | 135 | 0.071809 | | |
| | 10 | 122 | 0.064894 | | |
| | 20 | 104 | 0.055319 | | |
| | 30 | 116 | 0.061702 | | |
| | 40 | 107 | 0.056915 | | |
| | 50 | 122 | 0.064894 | | |

6.13 Frequency stability V.S. Voltage measurement

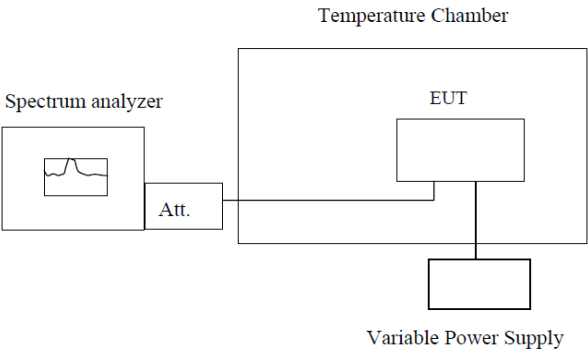
| | |
|-------------------|--|
| Test Requirement: | FCC Part 2.1055(d)(1)(2) |
| Test Method: | FCC Part 2.1055(d)(1)(2) |
| Limit: | 2.5ppm |
| Test setup: |  <p style="text-align: center;">Note : Measurement setup for testing on Antenna connector</p> |
| Test procedure: | <ol style="list-style-type: none"> 1. Set chamber temperature to 25°C. Use a variable DC power source to power the EUT and set the voltage to rated voltage. 2. Set the spectrum analyzer RBW low enough to obtain the desired frequency resolution and recorded the frequency. 3. Reduce the input voltage to specify extreme voltage variation (+/- 15%) and endpoint, record the maximum frequency change. |
| Test Instruments: | Refer to section 5.8 for details |
| Test mode: | Refer to section 5.3 for details, and all channels have been tested, only shows the worst channel data in this report. |
| Test results: | Passed |

Measurement Data (the worst channel):

| Reference Frequency: GSM850 Middle channel=190 channel=836.6MHz | | | | | |
|---|----------------------|-----------------|----------|-------------|--------|
| Temperature (°C) | Power supplied (Vdc) | Frequency error | | Limit (ppm) | Result |
| | | Hz | ppm | | |
| 25 | 4.25 | 99 | 0.118336 | 2.5 | Pass |
| | 3.70 | 91 | 0.108774 | | |
| | 3.40 | 72 | 0.086063 | | |
| Reference Frequency: PCS1900 Middle channel=661 channel=1880MHz | | | | | |
| Temperature (°C) | Power supplied (Vdc) | Frequency error | | Limit (ppm) | Result |
| | | Hz | ppm | | |
| 25 | 4.25 | 66 | 0.035106 | 2.5 | Pass |
| | 3.70 | 84 | 0.044681 | | |
| | 3.40 | 82 | 0.043617 | | |

| Reference Frequency: UMTS 850 12.2k RMC Middle channel=4183 channel=836.6MHz | | | | | |
|--|----------------------|-----------------|----------|-------------|--------|
| Temperature (°C) | Power supplied (Vdc) | Frequency error | | Limit (ppm) | Result |
| | | Hz | ppm | | |
| 25 | 4.25 | 69 | 0.082477 | 2.5 | Pass |
| | 3.70 | 84 | 0.100406 | | |
| | 3.40 | 72 | 0.086063 | | |
| Reference Frequency: UMTS 1900 12.2k RMC Middle channel=9400 channel=1880MHz | | | | | |
| Temperature (°C) | Power supplied (Vdc) | Frequency error | | Limit (ppm) | Result |
| | | Hz | ppm | | |
| 25 | 4.25 | 67 | 0.035638 | 2.5 | Pass |
| | 3.70 | 81 | 0.043085 | | |
| | 3.40 | 72 | 0.038298 | | |