



RADIO REPORT FCC 47 CFR Part 95I Medical Device Radiocommunication Service (MedRadio) ISED RSS-243 Medical Devices Operating in the 401 – 406 MHz Frequency Band	
Report Reference No	G0M-1809-7676-TFC95IMR-V01
Testing Laboratory	Eurofins Product Service GmbH
Address	Storkower Str. 38c 15526 Reichenwalde Germany
Accreditation	 <p>A2LA Accredited Testing Laboratory, Certificate No.: 1983.01 FCC Test Firm Designation Number: DE0008 IC Testing Laboratory site: 3470A-2</p>
Applicant	BIOTRONIK SE & Co. KG
Address	Woermannkehre 1 12359 Berlin GERMANY
Test Specification	According to FCC/ISED rules
Standard	47 CFR Part 95I RSS-243, Issue 3, 2010-02 RSS-Gen Issue 5, 2018-04
Non-Standard Test Method	None
Equipment under Test (EUT):	
Product Description	BM2610 / Implantable Cardiac Monitor
Model(s)	BIOMONITOR III
Additional Model(s)	None
Brand Name(s)	None
Hardware Version(s)	Module Version 01 / BOM-0387_07; SCH-0227_0A, ASM-1300_0A
Software Version(s)	ROM: 7848ROMRev_1.03 / RAM: 7848RAMRev_04.06
FCC-ID	QRI-BM2610
IC	4708A-BM2610
Test Result	PASSED

Possible test case verdicts:		
required by standard but not tested	N/T	
not required by standard	N/R	
not applicable to EUT	N/A	
test object does meet the requirement	P(PASS)	
test object does not meet the requirement	F(FAIL)	
Testing:		
Test Lab Temperature	20 - 23 °C	
Test Lab Humidity	32 – 38 %	
Date of receipt of test item	2018-10-04	
Report:		
Compiled by	Wilfried Treffke	
Tested by (+ signature) (Responsible for Test)	Wilfried Treffke	
Approved by (+ signature) (Head of Lab)	Christian Weber	
Date of Issue	2018-11-16	
Total number of pages	69	
General Remarks:		
<p>The test results presented in this report relate only to the object tested.</p> <p>The results contained in this report reflect the results for this particular model and serial number. It is the responsibility of the manufacturer to ensure that all production models meet the intent of the requirements detailed within this report.</p> <p>This report shall not be reproduced, except in full, without the written approval of the Issuing testing laboratory.</p>		
Additional Comments:		

VERSION HISTORY

Version History			
Version	Issue Date	Remarks	Revised By
01	2018-11-16	Initial Release	

ABBREVIATIONS AND ACRONYMS

Acronyms	
Acronym	Description
EUT	Equipment Under Test
FCC	Federal Communications Commission
ISED	Innovation, Science and Economic Development Canada
RBW	Resolution bandwidth
RMS	Root mean square
VBW	Video bandwidth
V _{NOM}	Nominal supply voltage

REPORT INDEX

1	Equipment (Test Item) Under Test.....	6
1.1	Photos – Equipment External.....	7
1.2	Photos – Equipment Internal.....	8
1.3	Photos – Test Setup.....	9
1.4	Photos – Auxiliary/Associated Equipment.....	10
1.5	Support Equipment.....	12
1.6	Test mode duty cycle.....	13
1.7	Test Frequencies.....	16
1.8	Sample emission level calculation.....	17
1.9	Simulated human body.....	18
2	Result Summary.....	19
3	Test Conditions and Results.....	20
3.1	Test Conditions and Results - Occupied bandwidth.....	20
3.2	Test Conditions and Results - Emission bandwidth.....	25
3.3	Test Conditions and Results - Frequency stability.....	30
3.4	Test Conditions and Results - Transmitter output power.....	32
3.5	Test Conditions and Results - Band-edge and In-band Emissions.....	34
3.6	Test Conditions and Results - Transmitter unwanted emissions.....	44
3.7	Test Conditions and Results - Receiver spurious emissions.....	46
ANNEX A	Transmitter spurious emissions.....	48
ANNEX B	Receiver spurious emissions.....	64

1 Equipment (Test Item) Under Test

Description	BM2610 / Implantable Cardiac Monitor	
Model	BIOMONITOR III	
Additional Model(s)	None	
Brand Name(s)	None	
Serial Number(s)	81704794	
Hardware Version(s)	Module Version 01 / BOM-0387_07; SCH-0227_0A, ASM-1300_0A	
Software Version(s)	ROM: 7848ROMRev_1.03 / RAM: 7848RAMRev_04.06	
PMN	BIOMONITOR III	
HVIN	436066	
FVIN	None	
HMN	None	
FCC-ID	QRI-BM2610	
IC	4708A-BM2610	
Equipment type	End Product	
Radio type	Transceiver	
Assigned frequency bands	402 - 405 MHz	
Radio technology	MedRadio (MICS) active medical implant	
Modulation	2-FSK	
Emission designator	F1D	
Number of channels	9	
Channel spacing	300 kHz	
Spectrum access	LBT/AFA (channel access controlled by ULP-AMI-P device outside the human body)	
Number of antenna ports	1	
Antenna	Type	Integrated
	Model	BIOMONITOR III Lead
	Manufacturer	BIOTRONIK SE & Co. KG
	Gain	-11.05 dBi (By measurement)
Supply Voltage	V _{NOM}	2.7 VDC
	V _{MIN}	2.0 VDC
	V _{MAX}	3.3 VDC
Operating Temperature	T _{NOM}	37 °C
	T _{MIN}	25 °C
	T _{MAX}	45 °C
AC/DC-Adaptor	Model	None
	Vendor	None
	Input	None
	Output	None
Manufacturer	BIOTRONIK SE & Co. KG Woermannkehre 1 12359 Berlin GERMANY	

1.5 Support Equipment

Product Type	Device	Manufacturer	Model	Comment
AE1	USB Telbox	BIOTRONIK	327	
AE2	Programming Wand	BIOTRONIK	PHG 3000	
Description:				
AE	Auxiliary Equipment			
SIM	Simulator			
CBL	Connecting Cable			
Comment:				

1.6 Test mode duty cycle

1.6.1 Information

Test Information	
Measurement Method	ANSI C63.10 11.6

1.6.2 Requirements

Requirements	
Duty cycle	Duty cycle correction
≥ 98 %	No correction required
< 98 %	Correction required ($10 \times \log_{10}(1/DC)$)

1.6.3 Setup

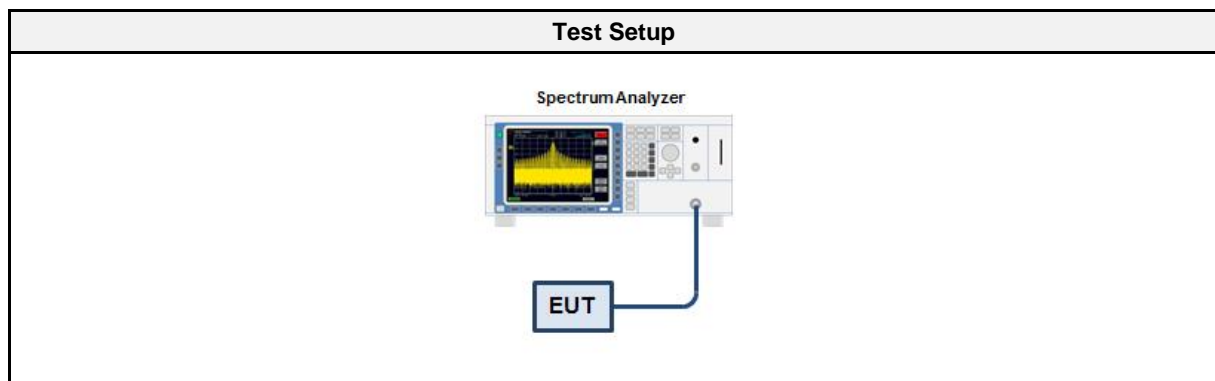

1.6.4 Equipment

Test Equipment					
Description	Manufacturer	Model	Identifier	Cal. Date	Cal. Due
Spectrum Analyzer	R&S	FSU 3	EF00241	2017-07	2019-07

1.6.5 Procedure

Test Procedure
<ol style="list-style-type: none"> 1. EUT set to test mode 2. Span is set to zero span 3. Detector set to peak 4. Sweep time is set long enough to capture at least 5 bursts 5. Envelope peak value of emission spectrum is selected 6. The maximum burst duration T_{ON} is measured using two markers set to the start and the end of the longest burst 7. The minimum idle duration T_{OFF} is measured using two markers set to the start and the end of the shortest idle period 8. The duty cycle is calculated by $DC = T_{ON} / (T_{ON} + T_{OFF})$ 9. The duty cycle correction is calculated by $DC = 10 \times \log_{10}(T_{ON} / (T_{ON} + T_{OFF}))$

1.6.6 Results

Duty Cycle Results		
Mode	Duty Cycle	Correction Factor [dB]
Modulated	1 (100%)	0

Test Modes

Mode	Description
Unmodulated	Mode = Transmit Modulation = None
Unmodulated PS	Laboratory power supply Mode = Transmit Modulation = None
Modulated	Mode = Transmit Modulation = 2-FSK Power level = maximum
Receive	Mode = Receive Modulation = 2-FSK
Comment:	

1.7 Test Frequencies

Designator	Mode	Channel	Frequency [MHz]
F1	Tx/RX	8	402.45
F2	Tx/RX	0	403.65
F3	Tx/RX	7	404.85

1.8 Sample emission level calculation

The following is a description of terms and a sample calculation, as appears in the radiated emissions data table. The numbers used in the calculation are for example only. There is no direct correlation to the specific data taken for the product described in this document:

Reading:

This is the reading obtained on the spectrum analyzer in dBμV. Any external preamplifiers used are taken into account through internal analyzer settings.

A.F.:

This is the antenna factor for the receiving antenna. It is a conversion factor, which converts electric fields strengths to voltages, which can be measured directly on the spectrum analyzer. It is treated as a loss in dB. Cable losses have been included with the A.F. to simplify the calculations. The antenna factor is used in calculations as follows:

$$\text{Reading on Analyzer (dB}\mu\text{V)} + \text{A.F. (dB/m)} = \text{Net field strength (dB}\mu\text{V/m)}$$

Net:

This is the net field strength measurement (as shown above).

Limit:

This is the FCC Class B radiated emission limit (in units of dBμV/m). The FCC limits are given in units of μV/m. The following formula is used to convert the units of μV/m to dBμV/m:

$$\text{Limit (dB}\mu\text{V/m)} = 20 \cdot \log(\mu\text{V/m})$$

Margin:

This is the margin of compliance below the FCC limit. The units are given in dB. A negative margin indicates the emission was below the limit. A positive margin indicates that the emission exceeds the limit.

Example only:

Reading + AF	=	Net Reading	:	Net reading - FCC limit	=	Margin
+21.5 dBμV + 26 dB/m		= 47.5 dBμV/m		47.5 dBμV/m - 57.0 dBμV/m		= -9.5 dB

1.9 Simulated human body

For radiated tests the implant was placed in a simulated human body.

Liquid components			
Component	percentage per weight		
Deionized water	52.4		
Bactericide	0.08		
Hydroxy ethyl cellulose (HCE)	1.0		
Sodium chloride	1.4		
Sucrose	45.0		
Tissue parameters – 403.5MHz Measured tissue parameters:			
Component	Target	Measured	Tolerance [%]
Dielectric constant ϵ	62.5	63.08	0.93
Conductivity σ [ms/cm]	9.08	8.8	-2.22

2 Result Summary

FCC 47 CFR Part 95I, 15C, ISED RSS-243, ISED RSS-Gen				
Product Standard Reference	Requirement	Reference Method	Result	Remarks
ISED RSS-243 3.2 ISED RSS-Gen 6.6	Occupied Bandwidth	ANSI C63.10 6.9.3	N/R	Informational only
FCC 95.2573(a) ISED RSS-243 3.6	Emission Bandwidth	ANSI C63.10 6.9.2 ETSI EN 301 839 5.3.2	PASS	
FCC 95.2565 ISED RSS-243 3.3, 5.3	Frequency stability	ETSI EN 301 839 5.3.1	PASS	
FCC 95.2567(a), 95.2569 ISED RSS-243 5.4	Transmitter output power	ETSI EN 301 839 5.3.3	PASS	
FCC 95.2579 ISED RSS-243 3.4, 5.5	Band edge compliance	ANSI C63.10 6.10	PASS	
FCC 95.2579 ISED RSS-243 3.4, 5.5	Transmitter unwanted emissions	ANSI C63.10 6.10	PASS	
ISED RSS-243 3.5, 5.6 ISED RSS-Gen 7.3	Receiver spurious emissions	ANSI C63.10 6.10	PASS	
FCC 15.207 ISED RSS-Gen 7.2, 8.8	AC power line conducted emissions	ANSI C63.10 6.2	N/A	EUT battery powered
FCC 95.2559(a)(3),(a)(4) ISED RSS-243 3.6, 5.7.1	System threshold power levels	ETSI EN 301 839 5.3.7.1.3	N/A	Applies only to equipment by which LBT is performed
FCC 95.2559(a)(1) ISED RSS-243 3.6, 5.7.2	Monitoring system bandwidth	ETSI EN 301 839 5.3.7.1.4	N/A	Applies only to equipment by which LBT is performed
FCC 95.2559(a)(2) ISED RSS-243 3.6, 5.7.3	Scan cycle time	ETSI EN 301 839 5.3.7.1.5	N/A	Applies only to equipment by which LBT is performed
FCC 95.2559(a)(2) ISED RSS-243 3.6, 5.7.4	Minimum channel monitoring period	ETSI EN 301 839 5.3.7.1.5	N/A	Applies only to equipment by which LBT is performed
FCC 95.2559(a)(5) ISED RSS-243 3.6, 5.7.5	Channel Access	ETSI EN 301 839 5.3.7.1.6	N/A	Applies only to equipment by which LBT is performed
FCC 95.2559(a)(5) ISED RSS-243 3.6, 5.7.6	Discontinuation of MICS of MEDS session	ETSI EN 301 839 5.3.7.1.7	N/A	Applies only to equipment by which LBT is performed
FCC 95.2559(a)(6) ISED RSS-243 3.6, 5.7.7	Use of the pre-scanned alternate channel	ETSI EN 301 839 5.3.7.1.8	N/A	Applies only to equipment by which LBT is performed
Comment:				

Possible Test Case Verdicts	
PASS	Test object does meet the requirements
FAIL	Test object does not meet the requirements
N/T	Required by standard but not tested
N/R	Not required by standard for the test object

3 Test Conditions and Results

3.1 Test Conditions and Results - Occupied bandwidth

3.1.1 Information

Test Information	
Reference	ISED RSS-243 3.2, RSS-Gen 6.6
Measurement Method	ANSI C63.10 6.9.3
Operator	Wilfried Treffke
Date	2018-10-11

3.1.2 Limits

Limits
None (Informational only)

3.1.3 Setup

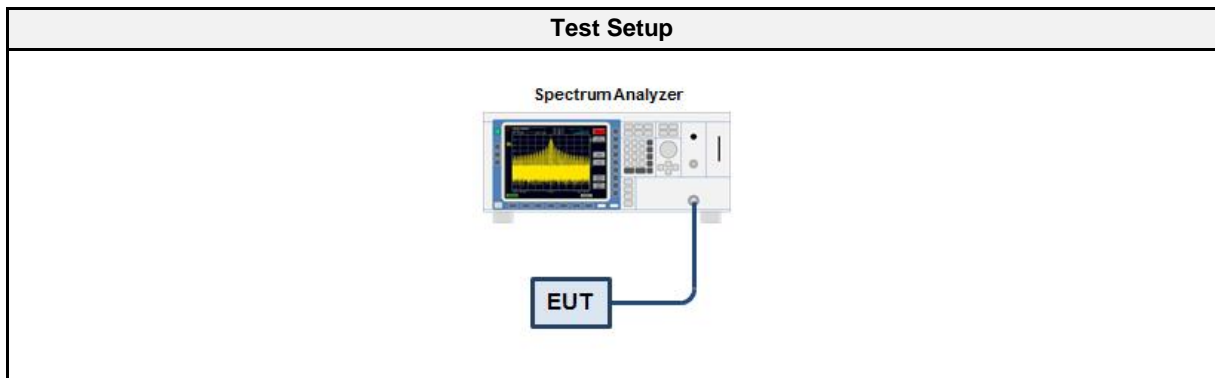

3.1.4 Equipment

Test Equipment					
Description	Manufacturer	Model	Identifier	Cal. Date	Cal. Due
Spectrum Analyzer	R&S	FSU 3	EF00241	2017-07	2019-07

3.1.5 Procedure

Test Procedure
<ol style="list-style-type: none"> 1. EUT transmitter is activated in test mode under normal conditions 2. The spectrum analyzer is set to peak detection and maximum hold with a span twice the emission spectrum 3. The resolution bandwidth is set 1 % to 5 % of the bandwidth 4. The occupied bandwidth (99%) is measured with the build-in analyzer function

3.1.6 Results

Test Results		
Mode	Channel [MHz]	Bandwidth [MHz]
Transmit	402.45	229.725
Transmit	403.65	229.275
Transmit	404.85	229.275

Occupied Bandwidth RSS-243

Project Number: G0M-1809-7676
 Applicant: BIOTRONIK SE & Co. KG
 Model Description: BM2610 / Implantable Cardiac Monitor
 Model: BIOMONITOR III
 Test Sample ID: 20553
 Reference Method: RSS-Gen Issue 4 6.6 (Occupied Bandwidth)
 Operational Mode: 2FSK, 16 kbps, Channel: 8, 402.45 MHz
 Operating Conditions: Tnom / Vnom
 Operator: W. Treffke
 Test Site: Eurofins Product Service GmbH
 Test Date: 2018-10-11
 Occupied Bandwidth [kHz]: 229.725

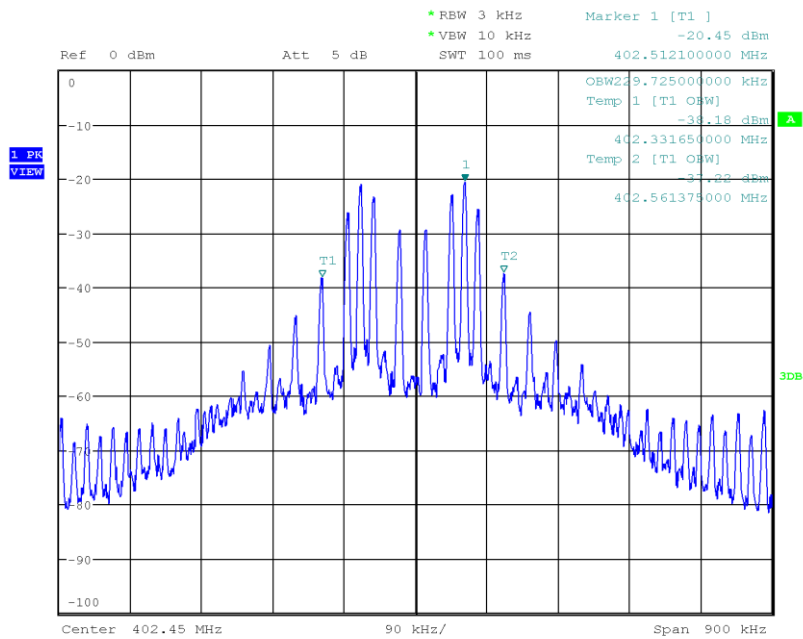

Date: 11.OCT.2018 08:44:41

Occupied Bandwidth RSS-243

Project Number: G0M-1809-7676
 Applicant: BIOTRONIK SE & Co. KG
 Model Description: BM2610 / Implantable Cardiac Monitor
 Model: BIOMONITOR III
 Test Sample ID: 20553
 Reference Method: RSS-Gen Issue 4 6.6 (Occupied Bandwidth)
 Operational Mode: 2FSK, 16 kbps, Channel: 0, 403.65 MHz
 Operating Conditions: Tnom / Vnom
 Operator: W. Treffke
 Test Site: Eurofins Product Service GmbH
 Test Date: 2018-10-11
 Occupied Bandwidth [kHz]: 229.275

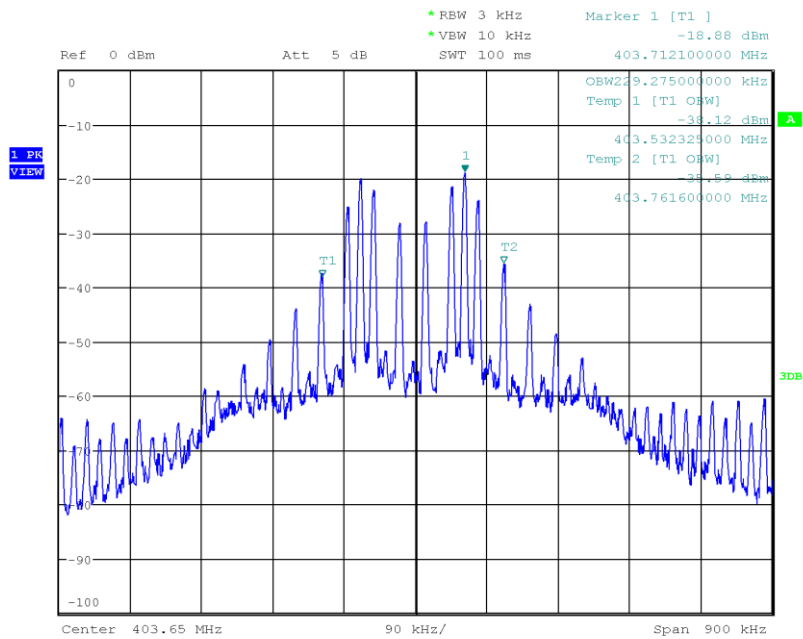

Date: 11.OCT.2018 08:43:27

Occupied Bandwidth RSS-243

Project Number: G0M-1809-7676
 Applicant: BIOTRONIK SE & Co. KG
 Model Description: BM2610 / Implantable Cardiac Monitor
 Model: BIOMONITOR III
 Test Sample ID: 20553
 Reference Method: RSS-Gen Issue 4 6.6 (Occupied Bandwidth)
 Operational Mode: 2FSK, 16 kbps, Channel: 7, 404.85 MHz
 Operating Conditions: Tnom / Vnom
 Operator: W. Treffke
 Test Site: Eurofins Product Service GmbH
 Test Date: 2018-10-11
 Occupied Bandwidth [kHz]: 229.275

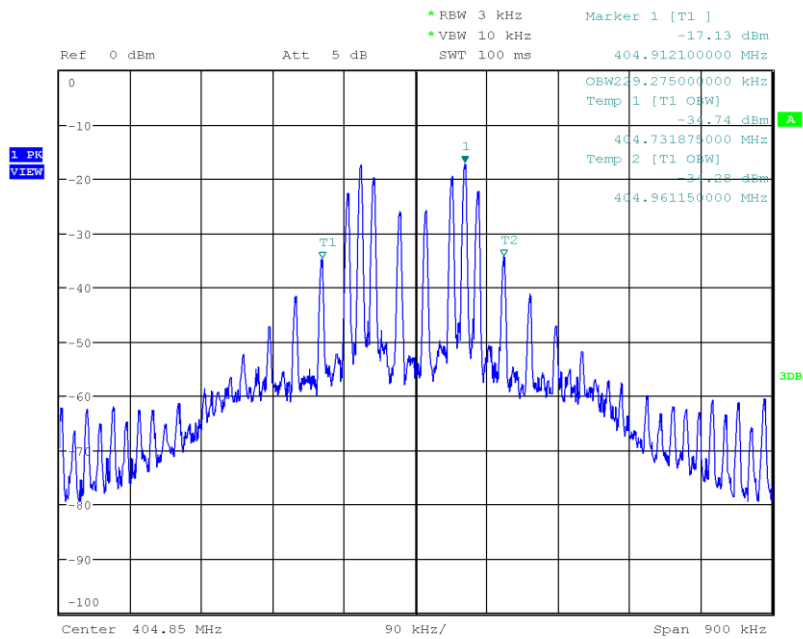

Date: 11.OCT.2018 08:40:31

3.2 Test Conditions and Results - Emission bandwidth

3.2.1 Information

Test Information	
Reference	FCC 95.2573(a) ISED RSS-243 3.6
Measurement Method	ANSI C63.10 6.9.2 ETSI EN 301 839 5.3.2
Operator	Wilfried Treffke
Date	2018-10-11

3.2.2 Limits

Limits
≤ 300 kHz

3.2.3 Setup

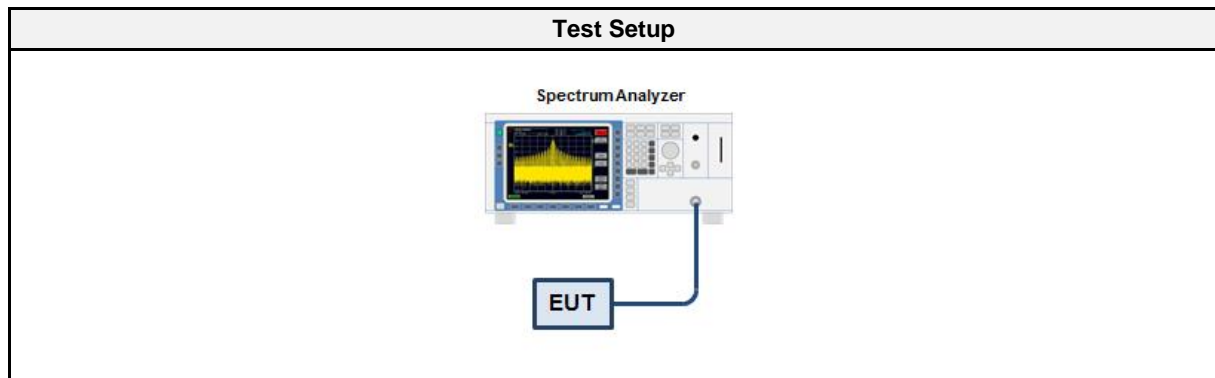

3.2.4 Equipment

Test Equipment					
Description	Manufacturer	Model	Identifier	Cal. Date	Cal. Due
Spectrum Analyzer	R&S	FSU 3	EF00241	2017-07	2019-07

3.2.5 Procedure

Test Procedure
<ol style="list-style-type: none"> 1. EUT set to test mode 2. Span set to at least twice the emission spectrum 3. Detector set to peak and max hold 4. Envelope peak value of emission spectrum is selected 5. Marker on envelope of spectrum is set to level of -20 dB to the left of the peak 6. Marker on envelope of spectrum is set to level of -20 dB to the right of the peak 7. 20dB Bandwidth is determined by marker frequency separation

3.2.6 Results

Test Results		
Mode	Channel [MHz]	Bandwidth [MHz]
Transmit	402.45	233.325
Transmit	403.65	233.100
Transmit	404.85	233.100

20 dB Bandwidth FCC

Project Number: G0M-1809-7676
 Applicant: BIOTRONIK SE & Co. KG
 Model Description: BM2610 / Implantable Cardiac Monitor
 Model: BIOMONITOR III
 Test Sample ID: 20553
 Reference Standards: FCC 95.627
 Reference Method: 47 CFR § 95.627(a)(6)(i)
 Operational Mode: 2FSK, 16 kbps, Channel: 8, 402.45 MHz
 Operating Conditions: Tnom/Vnom
 Operator: W. Treffke
 Test Site: Eurofins Product Service GmbH
 Test Date: 2018-10-11
 Lower Frequency [MHz]: 402.330
 Upper Frequency [MHz]: 402.563
 20 dB Bandwidth [kHz]: 233.325

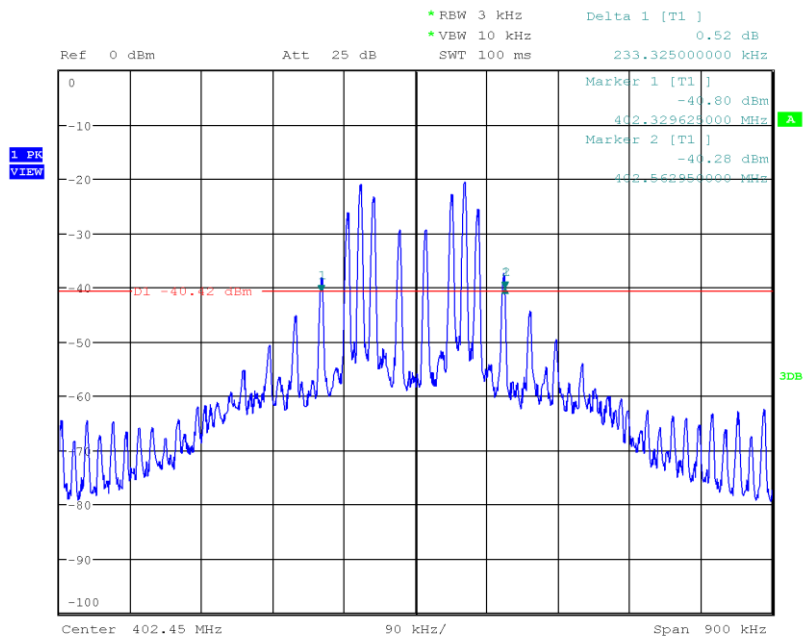

Date: 11.OCT.2018 09:03:12

20 dB Bandwidth FCC

Project Number: G0M-1809-7676
 Applicant: BIOTRONIK SE & Co. KG
 Model Description: BM2610 / Implantable Cardiac Monitor
 Model: BIOMONITOR III
 Test Sample ID: 20553
 Reference Standards: FCC 95.627
 Reference Method: 47 CFR § 95.627(a)(6)(i)
 Operational Mode: 2FSK, 16 kbps, Channel: 0, 403.65 MHz
 Operating Conditions: Tnom/Vnom
 Operator: W. Treffke
 Test Site: Eurofins Product Service GmbH
 Test Date: 2018-10-11
 Lower Frequency [MHz]: 403.530
 Upper Frequency [MHz]: 403.763
 20 dB Bandwidth [kHz]: 233.100

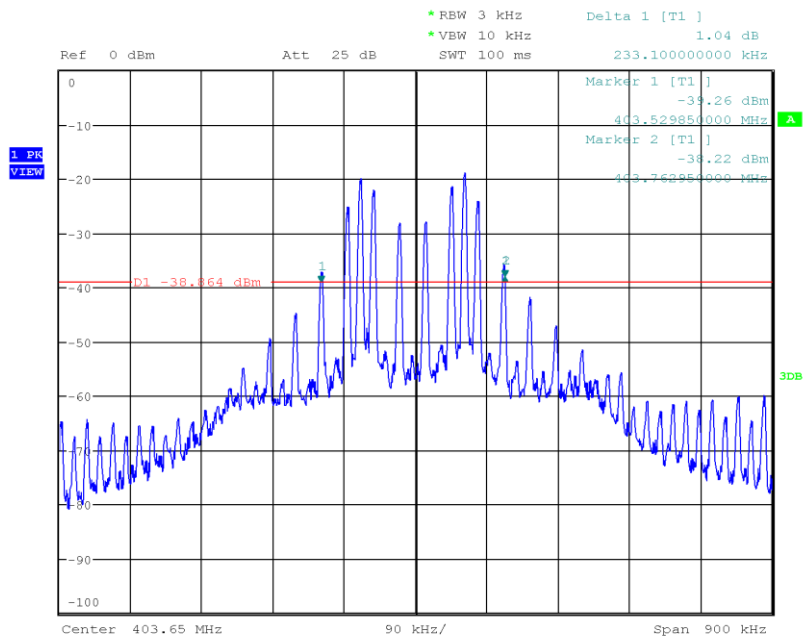

Date: 11.OCT.2018 08:57:59

20 dB Bandwidth FCC

Project Number: G0M-1809-7676
 Applicant: BIOTRONIK SE & Co. KG
 Model Description: BM2610 / Implantable Cardiac Monitor
 Model: BIOMONITOR III
 Test Sample ID: 20553
 Reference Standards: FCC 95.627
 Reference Method: 47 CFR § 95.627(a)(6)(i)
 Operational Mode: 2FSK, 16 kbps, Channel: 7, 404.85 MHz
 Operating Conditions: Tnom/Vnom
 Operator: W. Treffke
 Test Site: Eurofins Product Service GmbH
 Test Date: 2018-10-11
 Lower Frequency [MHz]: 404.730
 Upper Frequency [MHz]: 404.963
 20 dB Bandwidth [kHz]: 233.100

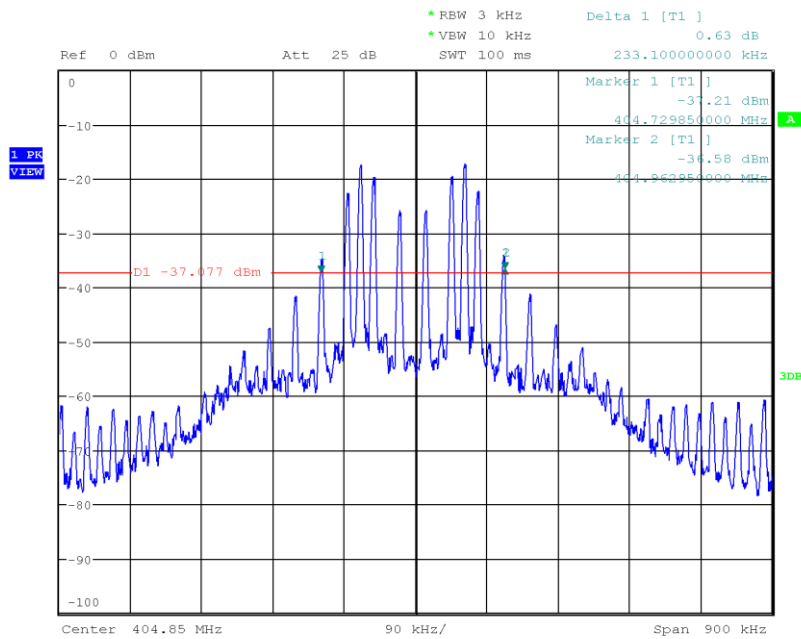

Date: 11.OCT.2018 09:00:17

3.3 Test Conditions and Results - Frequency stability

3.3.1 Information

Test Information	
Reference	FCC 95.2565 ISED RSS-243 3.3, 5.3
Measurement Method	ETSI EN 301 839 5.3.1
Operator	Wilfried Treffke
Date	2018-10-11

3.3.2 Limits

Limits
$\leq \pm 100$ ppm

3.3.3 Setup

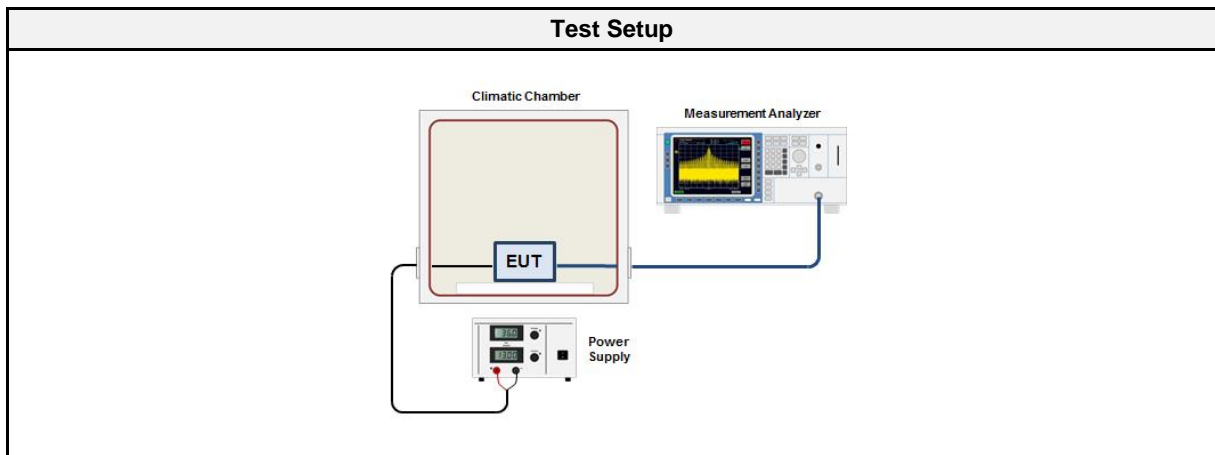

3.3.4 Equipment

Test Equipment					
Description	Manufacturer	Model	Identifier	Cal. Date	Cal. Due
Spectrum Analyzer	R&S	FSU 3	EF00241	2017-07	2019-07

3.3.5 Procedure

Test Procedure
<ol style="list-style-type: none"> 1. EUT set to test mode with supply voltage and temperature set to nominal conditions 2. EUT transmits without modulation 3. Detector set to peak and max hold 4. Peak of emission is measured using a frequency counter 5. The frequency error is determined as the deviation of the emission frequency from the nominal frequency stated by the customer.

3.3.6 Results

Test Results				
Channel [MHz]	Temperature [°C]	Supply voltage [VDC]	Frequency [MHz]	Drift [ppm]
402.45	37	2.7	402.445655	-10.80
402.45	25	2.7	402.446208	-09.42
402.45	45	2.7	402.445352	-11.55
403.65	37	2.7	403.645730	-10.58
403.65	25	2.7	403.646296	-09.18
403.65	45	2.7	403.645425	-11.33
404.85	37	2.7	404.845797	-10.38
404.85	25	2.7	404.846367	-08.97
404.85	45	2.7	404.845499	-11.12

3.4 Test Conditions and Results - Transmitter output power

3.4.1 Information

Test Information	
Reference	FCC 95.2567(a), 95.2569 ISED RSS-243 5.4
Measurement Method	EN 301 839 5.3.3
Operator	Wilfried Treffke
Date	2018-10-09

3.4.2 Limits

Limits
≤ 25 μW (-16 dBm) e.i.r.p.

3.4.3 Setup

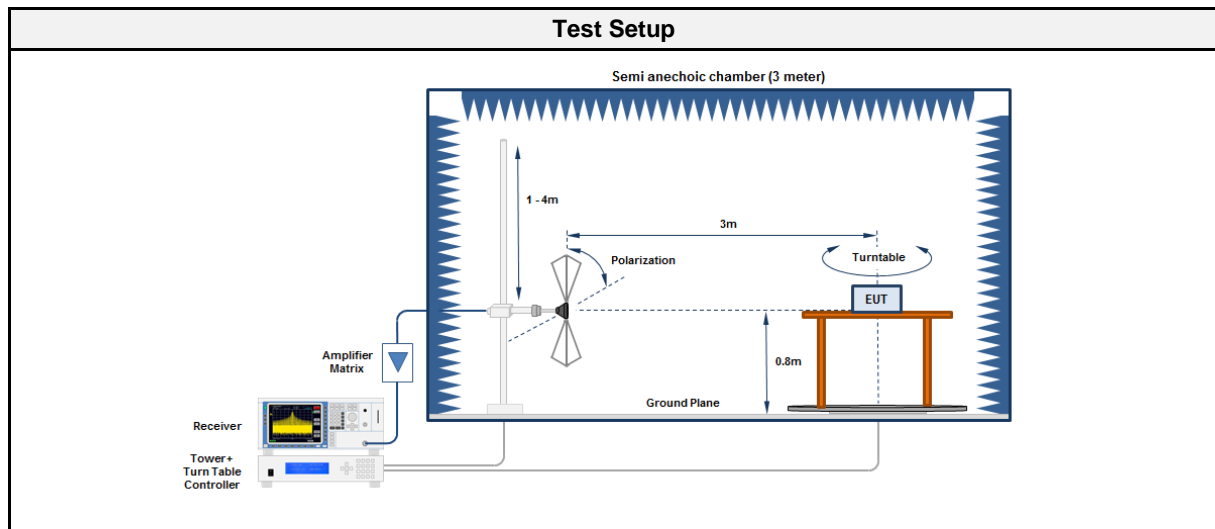

3.4.4 Equipment

Test Equipment 30 - 1000 MHz					
Description	Manufacturer	Model	Identifier	Cal. Date	Cal. Due
Anechoic Chamber	Frankonia	AC1	EF00062	2018-07	2021-07
Measurement Receiver	Agilent	N9038A-526/WXP	EF01070	2018-08	2019-08
Antenna	R&S	HL 223	EF00187	2016-05	2019-05

3.4.5 Procedure

Test Procedure
<ol style="list-style-type: none"> 1. EUT set to test frequency with modulation 2. Measurement polarization is set to vertical 3. Span it set according to measurement range and detector is set to peak and max hold 4. Resolution bandwidth is set to be at least twice the emission bandwidth 5. During the sweep the EUT is rotated to obtain maximum emission level 6. Measurement is repeated with horizontal measurement polarization

3.4.6 Results

Test Results				
Channel [MHz]	Emission Level [dBm e.i.r.p.]	Detector	Limit [dBm e.i.r.p.]	Margin [dB]
402.45	-30.0	pk	-16	-14.00
404.85	-29.8	pk	-16	-13.80

3.5 Test Conditions and Results - Band-edge and In-band Emissions

3.5.1 Information

Test Information	
Reference	FCC 95.2579 ISED RSS-243 3.4, 5.5
Measurement Method	ANSI C63.10 6.10
Operator	Wilfried Treffke
Date	2018-10-09

3.5.2 Limits

Limits FCC	
Frequency range	Limit
402 MHz – 250 kHz $\leq f \leq$ 402 MHz	20 dB below maximum permitted output power
402 MHz < f < 150 kHz - f _c	20 dB below transmitter output power
150 kHz + f _c < f < 405 MHz	20 dB below transmitter output power
405 MHz $\leq f \leq$ 405 MHz + 250 kHz	20 dB below maximum permitted output power
Limits ISED	
Frequency range	Limit
402 MHz – 250 kHz < f < 150 kHz-f _c	20 dB below maximum permitted output power
150 kHz+f _c < f < 405 MHz + 250 kHz	20 dB below maximum permitted output power

The FCC limits are more stringent than the ISED limits, that is why the FCC limits are used to fulfil the band-edge emission requirements

3.5.3 Setup

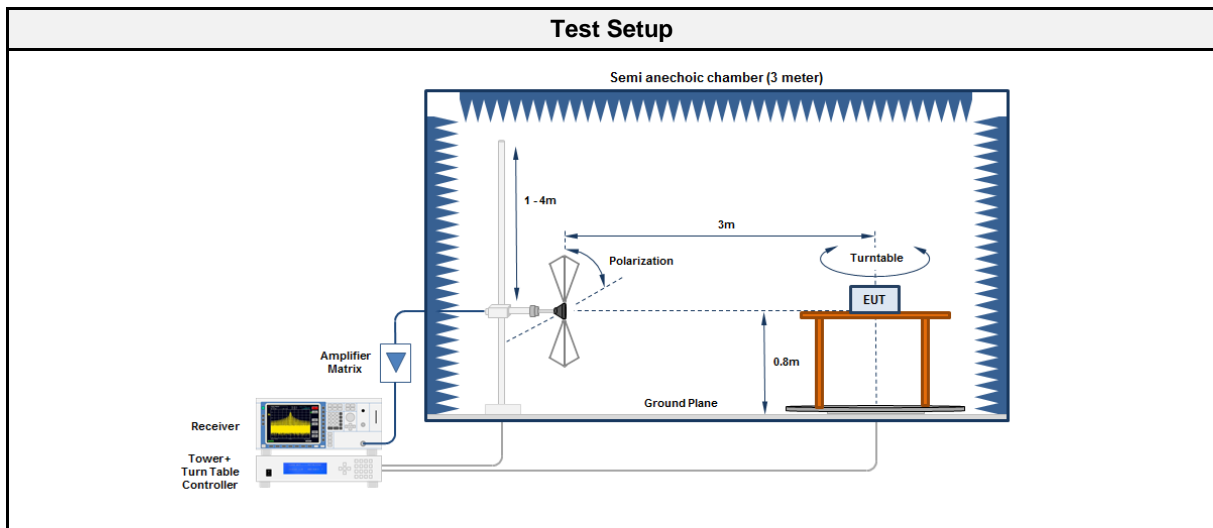

3.5.4 Equipment

Test Equipment 30 - 1000 MHz					
Description	Manufacturer	Model	Identifier	Cal. Date	Cal. Due
Anechoic Chamber	Frankonia	AC1	EF00062	2018-07	2021-07
Measurement Receiver	Agilent	N9038A-526/WXP	EF01070	2018-08	2019-08
Antenna	R&S	HL 223	EF00187	2016-05	2019-05

3.5.5 Procedure

Test Procedure
1. EUT set to test frequency with modulation
2. Measurement polarization is set to vertical
3. Span it set according to measurement range
4. Resolution bandwidth is set to 1% of the emission bandwidth and detector is set to peak
5. During the sweep the EUT is rotated to obtain maximum emission level
6. Measurement is repeated with horizontal measurement polarization

3.5.6 Results

Test Results					
Channel [MHz]	Emission [MHz]	Level [dB μ V/m]	Pol.	Limit [dB μ V/m]	Margin [dB]
402.45	402.299	21.76	hor	54.10	-32.34
402.45	402.3	30.48	ver	54.10	-23.62
402.45	402.6	20.22	hor	54.10	-33.88
402.45	402.6	27.89	ver	54.10	-26.21
402.45	403.235	18.76	hor	54.10	-35.34
402.45	403.235	27.05	ver	54.10	-27.05
402.45	403.957	17.16	hor	54.10	-36.94
402.45	403.959	25.19	ver	54.10	-28.91
402.45	404.089	17.56	hor	54.10	-36.54
402.45	404.089	26.06	ver	54.10	-28.04
404.85	403.074	11.31	ver	44.10	-32.79
404.85	403.467	12.22	ver	44.10	-31.88
404.85	404.697	19.03	hor	44.10	-25.07
404.85	404.697	31.37	ver	44.10	-12.73
404.85	404.999	11.69	hor	44.10	-32.41
404.85	405	21.13	ver	44.10	-22.97
404.85	405.027	25.05	ver	59.40	-34.35

Spurious emissions according to FCC Part 95; Subpart I

Project number: G0M-1809-7676

Applicant: BIOTRONIK SE & Co. KG
 EUT Name: BM2610 / Implantable Cardiac Monitor
 Model: BIOMONITOR III
 Test Site: Eurofins Product Service GmbH
 Operator: Wilfried Treffke
 Test Conditions: Tnom: 22°C, Vnom: 2.7 VDC (Battery)
 Antenna: HL223, Horizontal
 Measurement distance: 3 m
 Mode: TX; 2-FSK; 402.45 MHz
 Test Date: 2018-10-09
 Note: Band-edge

Index 23

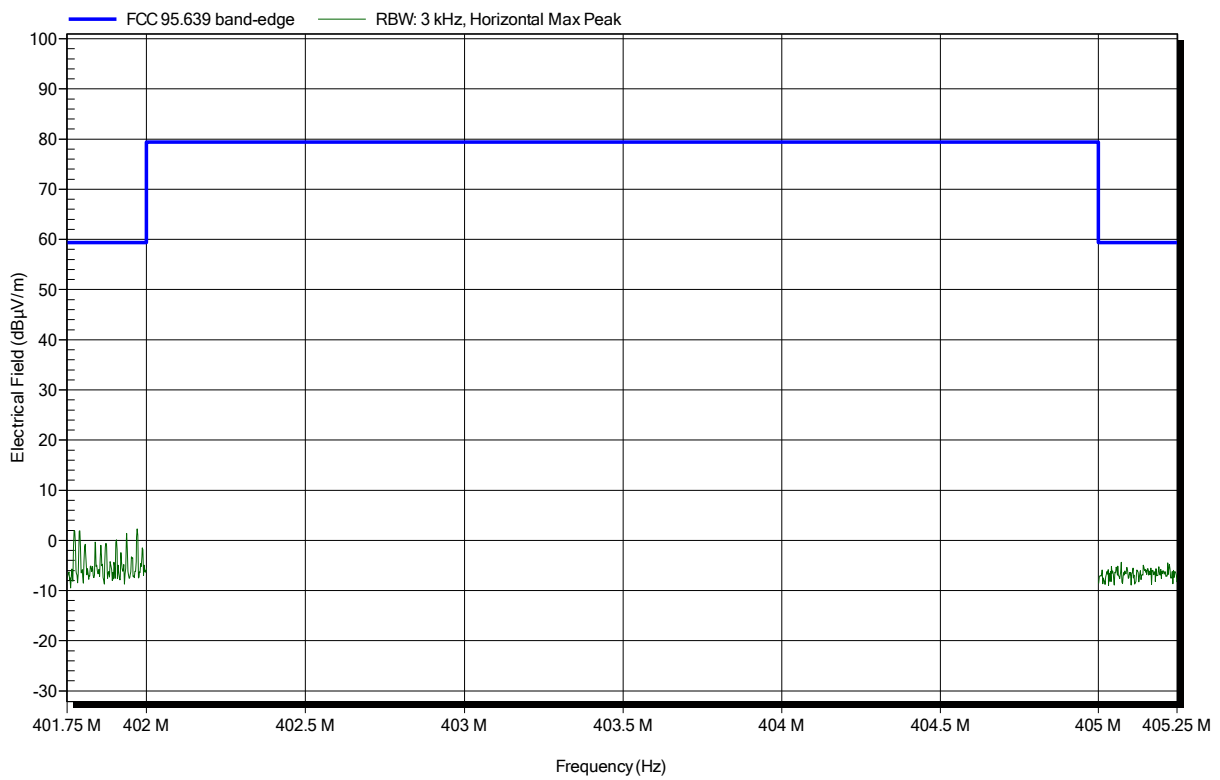

Spurious emissions according to FCC Part 95; Subpart I

Project number: G0M-1809-7676

Applicant: BIOTRONIK SE & Co. KG
 EUT Name: BM2610 / Implantable Cardiac Monitor
 Model: BIOMONITOR III
 Test Site: Eurofins Product Service GmbH
 Operator: Wilfried Treffke
 Test Conditions: Tnom: 22°C, Vnom: 2.7 VDC (Battery)
 Antenna: HL223, Vertical
 Measurement distance: 3 m
 Mode: TX; 2-FSK; 402.45 MHz
 Test Date: 2018-10-09
 Note: Band-edge

Index 24

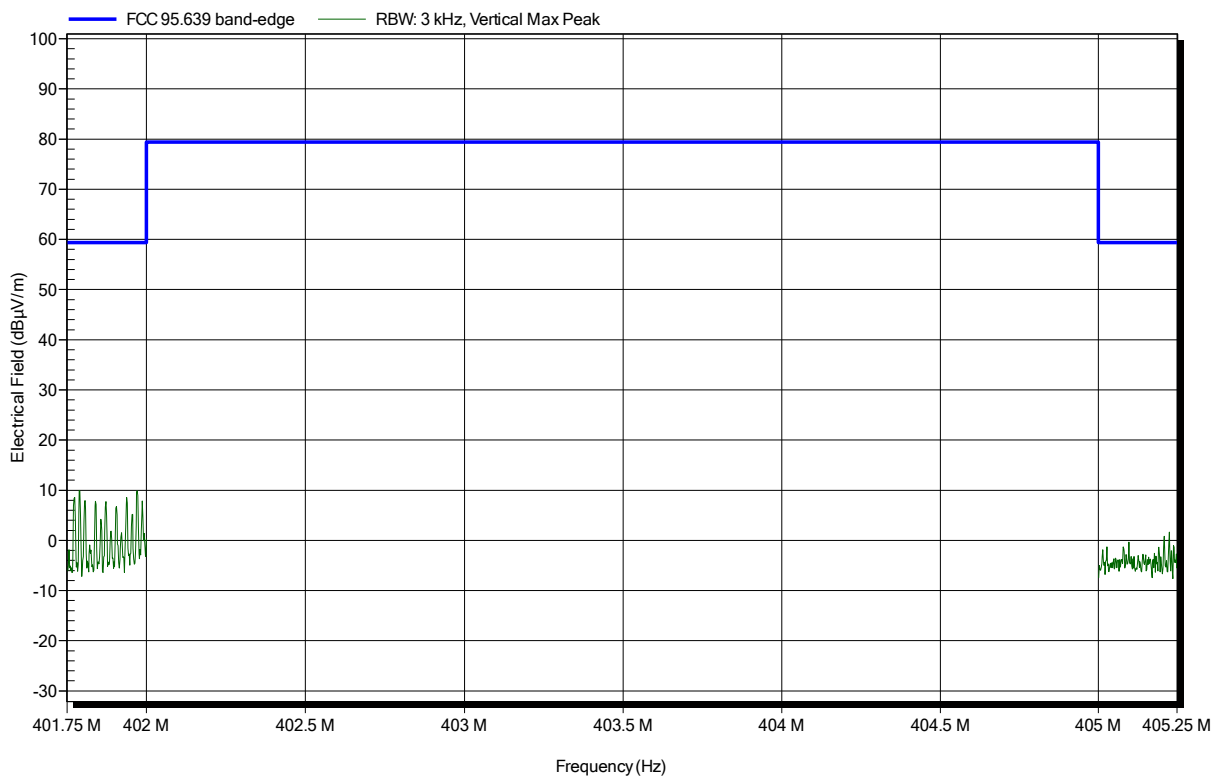

Spurious emissions according to FCC Part 95; Subpart I

Project number: G0M-1809-7676

Applicant: BIOTRONIK SE & Co. KG
 EUT Name: BM2610 / Implantable Cardiac Monitor
 Model: BIOMONITOR III
 Test Site: Eurofins Product Service GmbH
 Operator: Wilfried Treffke
 Test Conditions: Tnom: 22°C, Vnom: 2.7 VDC (Battery)
 Antenna: HL223, Horizontal
 Measurement distance: 3 m
 Mode: TX; 2-FSK; 402.45 MHz
 Test Date: 2018-10-09
 Note: In-band emissions

Index 26

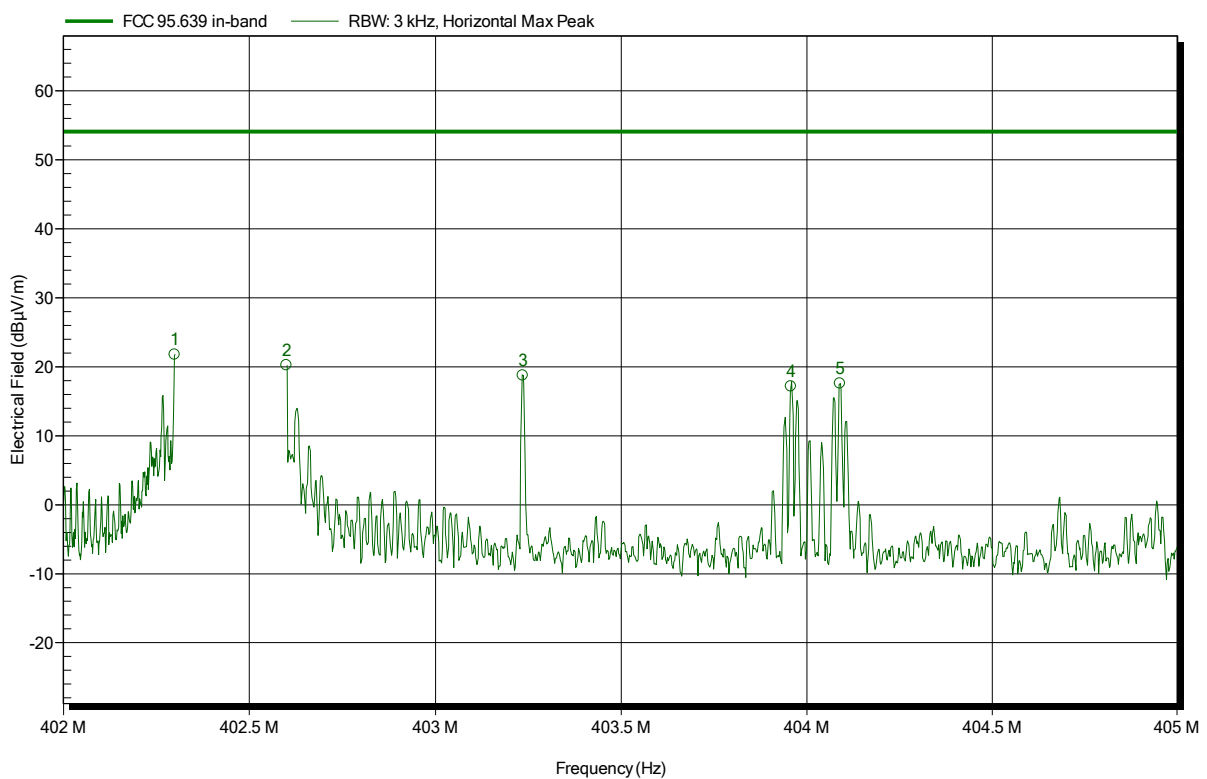

Frequency	Peak	Peak Limit	Peak Difference	Peak Status
402.299 MHz	21.76 dBµV/m	54.1 dBµV/m	-32.34 dB	Pass
402.6 MHz	20.22 dBµV/m	54.1 dBµV/m	-33.88 dB	Pass
403.235 MHz	18.76 dBµV/m	54.1 dBµV/m	-35.34 dB	Pass
403.957 MHz	17.16 dBµV/m	54.1 dBµV/m	-36.94 dB	Pass
404.089 MHz	17.56 dBµV/m	54.1 dBµV/m	-36.54 dB	Pass

Spurious emissions according to FCC Part 95; Subpart I

Project number: G0M-1809-7676

Applicant: BIOTRONIK SE & Co. KG
 EUT Name: BM2610 / Implantable Cardiac Monitor
 Model: BIOMONITOR III
 Test Site: Eurofins Product Service GmbH
 Operator: Wilfried Treffke
 Test Conditions: Tnom: 22°C, Vnom: 2.7 VDC (Battery)
 Antenna: HL223, Vertical
 Measurement distance: 3 m
 Mode: TX; 2-FSK; 402.45 MHz
 Test Date: 2018-10-09
 Note: In-band emissions

Index 25

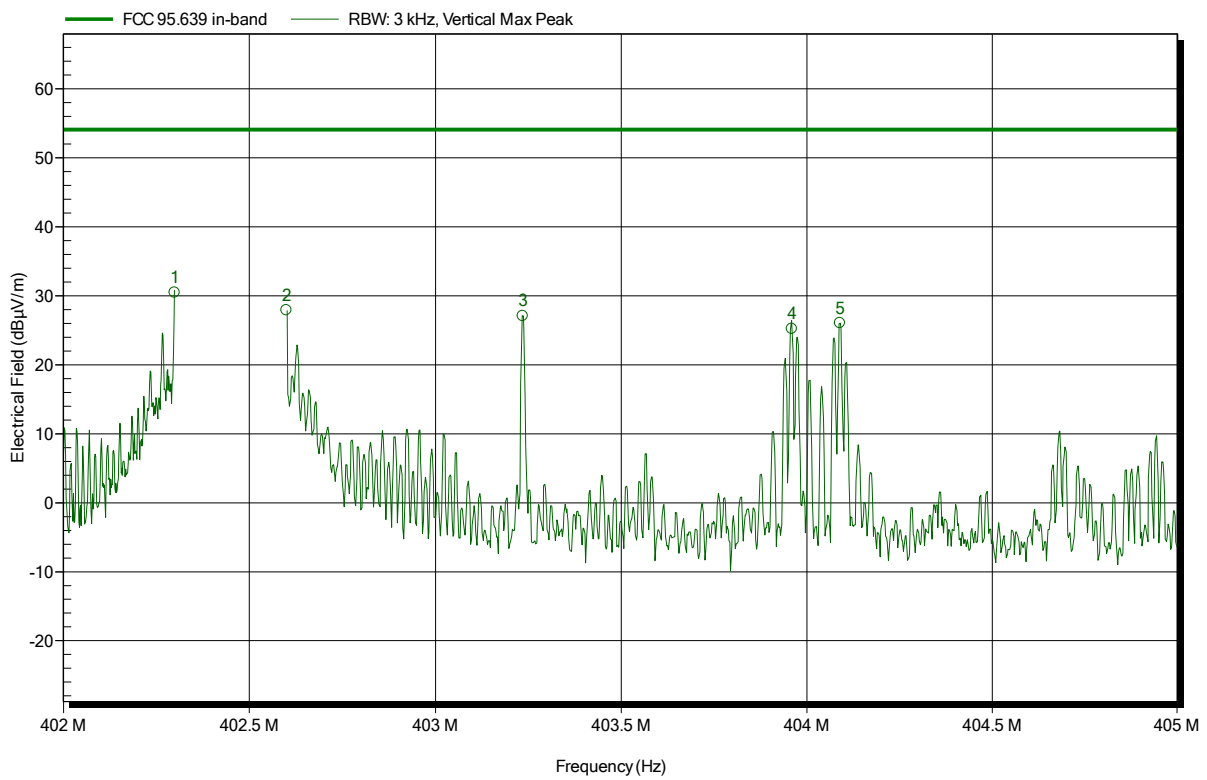

Frequency	Peak	Peak Limit	Peak Difference	Peak Status
402.3 MHz	30.48 dBµV/m	54.1 dBµV/m	-23.62 dB	Pass
402.6 MHz	27.89 dBµV/m	54.1 dBµV/m	-26.21 dB	Pass
403.235 MHz	27.05 dBµV/m	54.1 dBµV/m	-27.05 dB	Pass
403.959 MHz	25.19 dBµV/m	54.1 dBµV/m	-28.91 dB	Pass
404.089 MHz	26.06 dBµV/m	54.1 dBµV/m	-28.04 dB	Pass

Spurious emissions according to FCC Part 95; Subpart I

Project number: G0M-1809-7676

Applicant: BIOTRONIK SE & Co. KG
 EUT Name: BM2610 / Implantable Cardiac Monitor
 Model: BIOMONITOR III
 Test Site: Eurofins Product Service GmbH
 Operator: Wilfried Treffke
 Test Conditions: Tnom: 22°C, Vnom: 2.7 VDC (Battery)
 Antenna: HL223, Horizontal
 Measurement distance: 3 m
 Mode: TX; 2-FSK; 404.85 MHz
 Test Date: 2018-10-09
 Note: Band-edge

Index 38

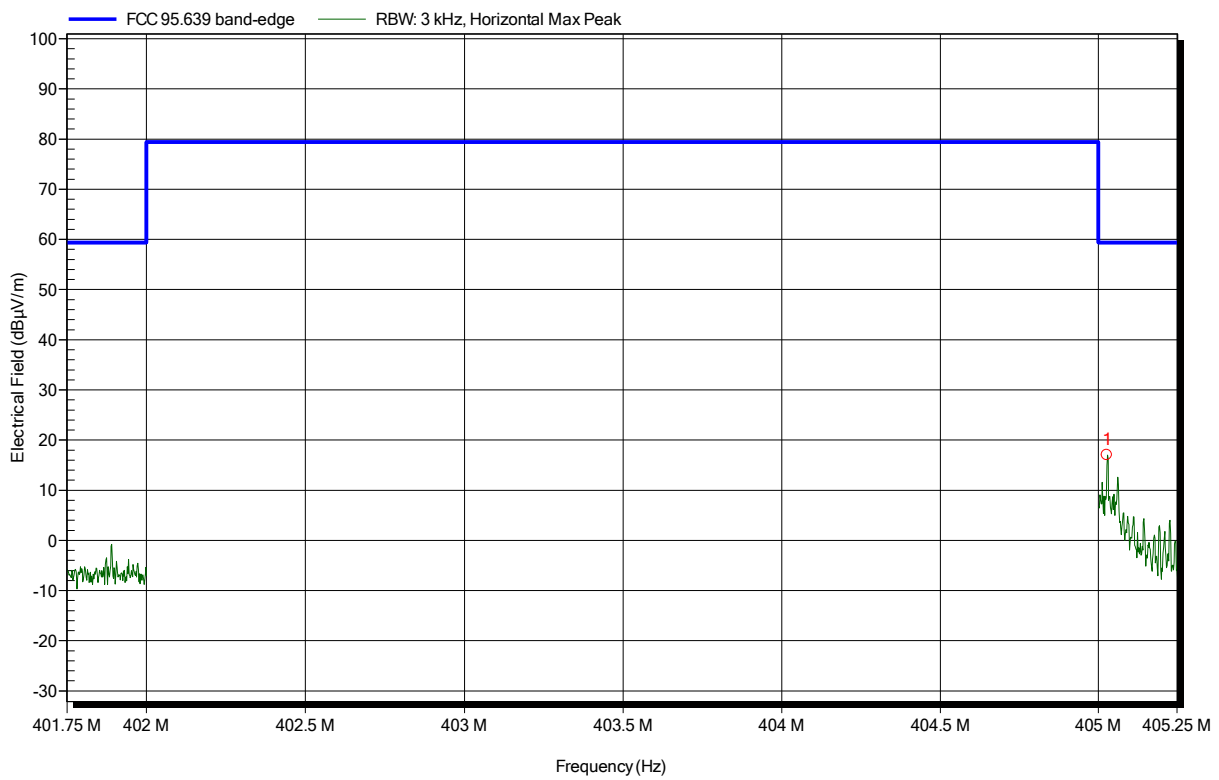

Frequency	Peak	Peak Limit	Peak Difference	Peak Status
405.027 MHz	17 dBµV/m	59.4 dBµV/m	-42.4 dB	Pass

Spurious emissions according to FCC Part 95; Subpart I

Project number: G0M-1809-7676

Applicant: BIOTRONIK SE & Co. KG
 EUT Name: BM2610 / Implantable Cardiac Monitor
 Model: BIOMONITOR III
 Test Site: Eurofins Product Service GmbH
 Operator: Wilfried Treffke
 Test Conditions: Tnom: 22°C, Vnom: 2.7 VDC (Battery)
 Antenna: HL223, Vertical
 Measurement distance: 3 m
 Mode: TX; 2-FSK; 404.85 MHz
 Test Date: 2018-10-09
 Note: Band-edge

Index 39

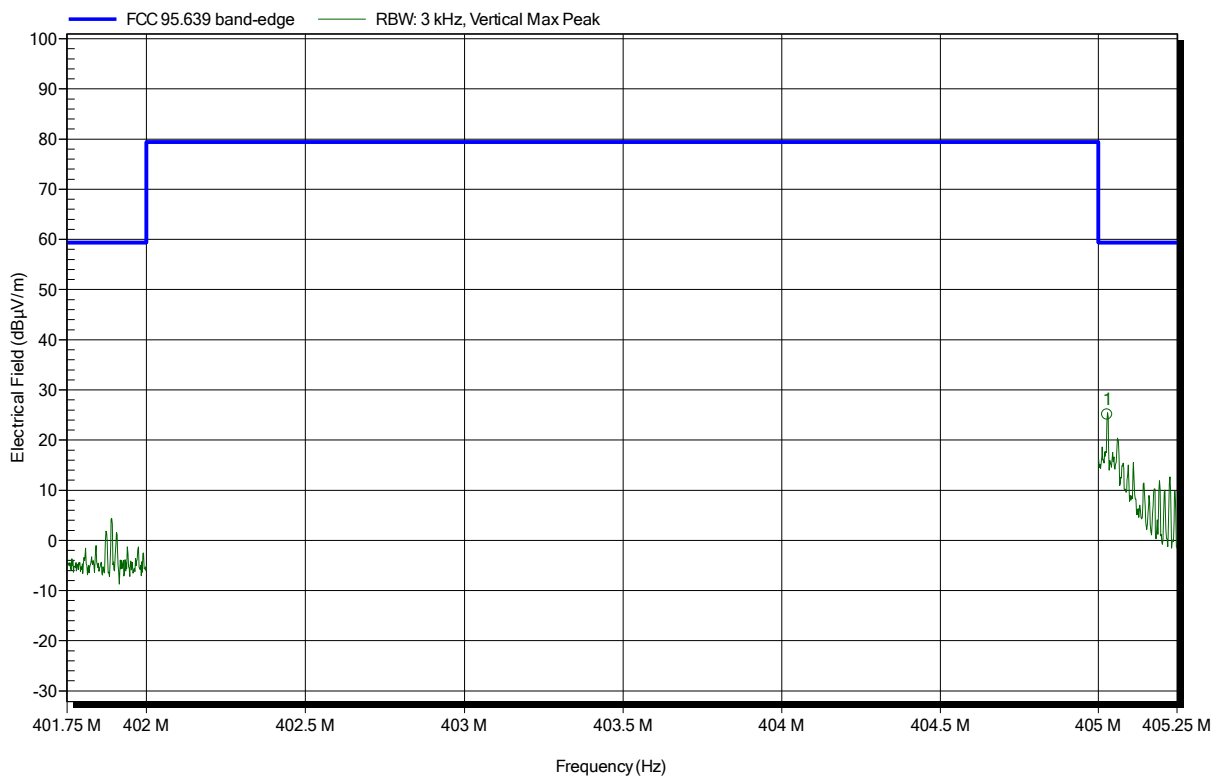

Frequency	Peak	Peak Limit	Peak Difference	Peak Status
405.027 MHz	25.05 dBµV/m	59.4 dBµV/m	-34.35 dB	Pass

Spurious emissions according to FCC Part 95; Subpart I

Project number: G0M-1809-7676

Applicant: BIOTRONIK SE & Co. KG
 EUT Name: BM2610 / Implantable Cardiac Monitor
 Model: BIOMONITOR III
 Test Site: Eurofins Product Service GmbH
 Operator: Wilfried Treffke
 Test Conditions: Tnom: 22°C, Vnom: 2.7 VDC (Battery)
 Antenna: HL223, Horizontal
 Measurement distance: 3 m
 Mode: TX; 2-FSK; 404.85 MHz
 Test Date: 2018-10-09
 Note: In-band emissions

Index 41

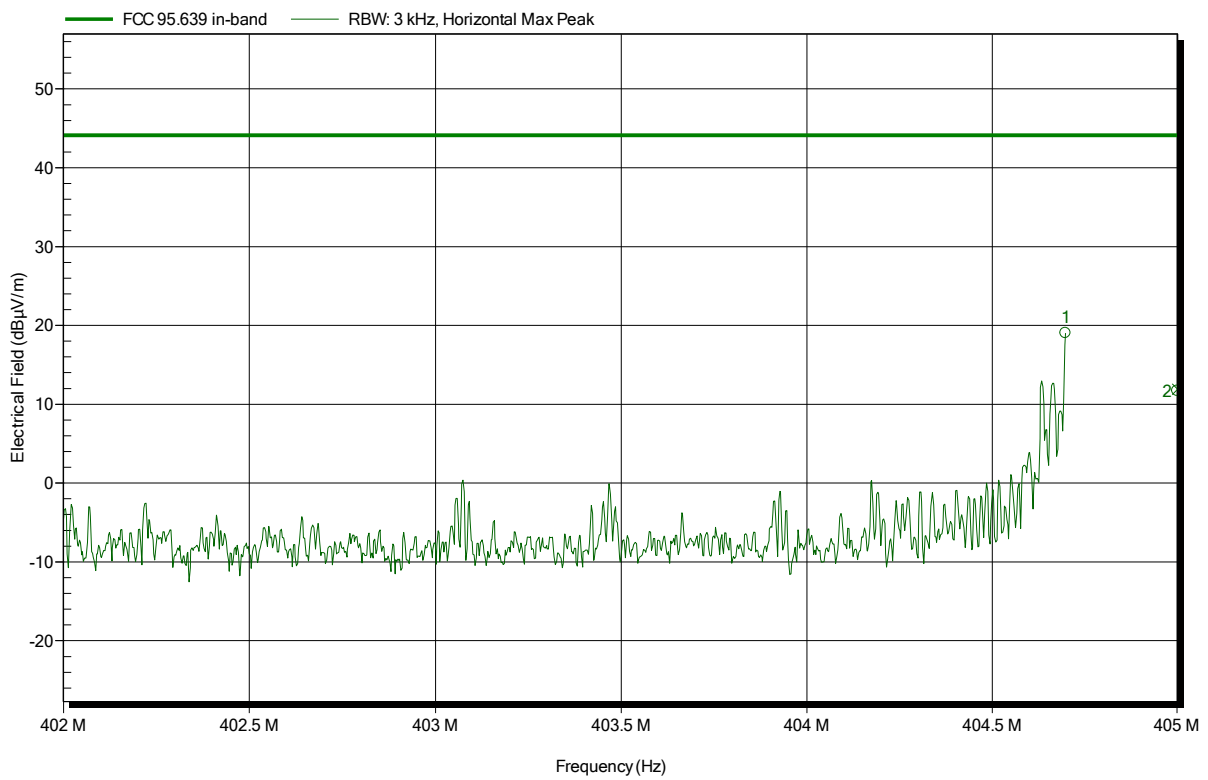

Frequency	Peak	Peak Limit	Peak Difference	Peak Status
404.697 MHz	19.03 dBµV/m	44.1 dBµV/m	-25.07 dB	Pass
404.999 MHz	11.69 dBµV/m	44.1 dBµV/m	-32.41 dB	Pass

Spurious emissions according to FCC Part 95; Subpart I

Project number: G0M-1809-7676

Applicant: BIOTRONIK SE & Co. KG
 EUT Name: BM2610 / Implantable Cardiac Monitor
 Model: BIOMONITOR III
 Test Site: Eurofins Product Service GmbH
 Operator: Wilfried Treffke
 Test Conditions: Tnom: 22°C, Vnom: 2.7 VDC (Battery)
 Antenna: HL223, Vertical
 Measurement distance: 3 m
 Mode: TX; 2-FSK; 404.85 MHz
 Test Date: 2018-10-09
 Note: In-band emissions

Index 40

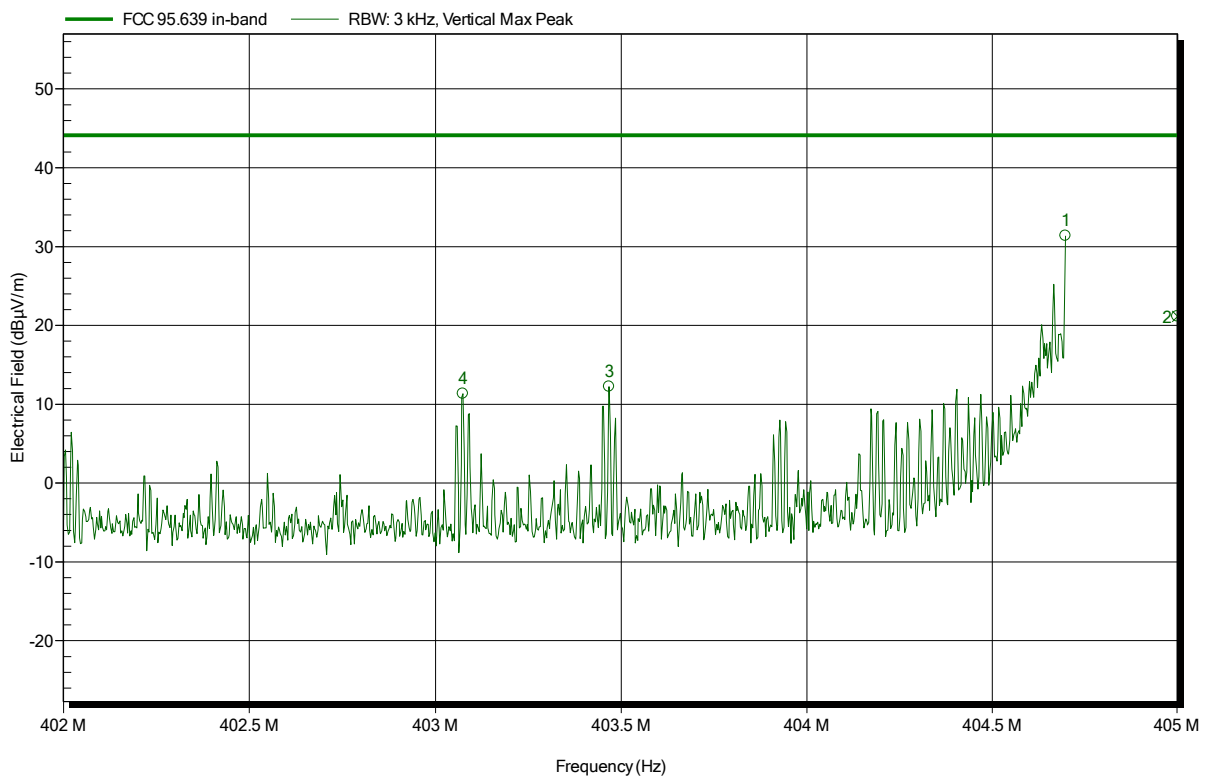

Frequency	Peak	Peak Limit	Peak Difference	Peak Status
403.074 MHz	11.31 dBµV/m	44.1 dBµV/m	-32.79 dB	Pass
403.467 MHz	12.22 dBµV/m	44.1 dBµV/m	-31.88 dB	Pass
404.697 MHz	31.37 dBµV/m	44.1 dBµV/m	-12.73 dB	Pass
405 MHz	21.13 dBµV/m	44.1 dBµV/m	-22.97 dB	Pass

3.6 Test Conditions and Results - Transmitter unwanted emissions

3.6.1 Information

Test Information	
Reference	FCC 95.2579 ISED RSS-243 3.4, 5.5
Measurement Method	ANSI C63.10 6.10
Operator	Wilfried Treffke
Date	2018-10-09

3.6.2 Limits

Limits				
Frequency range [MHz]	Detector	Limit [$\mu\text{V}/\text{m}$]	Limit [$\text{dB}\mu\text{V}/\text{m}$]	Limit Distance [m]
30 – 88	Quasi-Peak	100	40	3
88 – 216	Quasi-Peak	150	43.5	3
216 – 960	Quasi-Peak	200	46	3
960 – 1000	Quasi-Peak	500	54	3
> 1000	Average	500	54	3

3.6.3 Setup

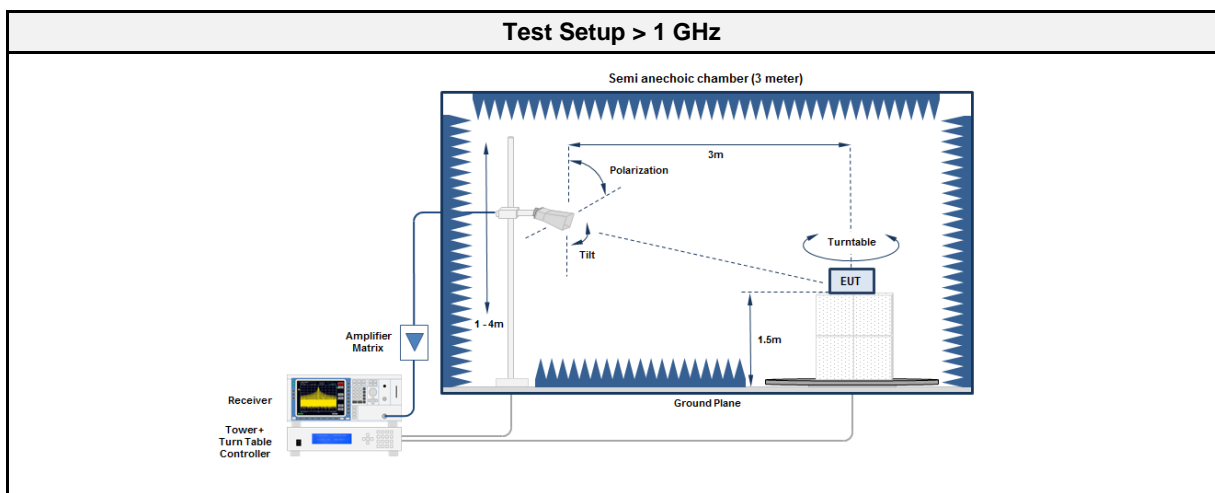
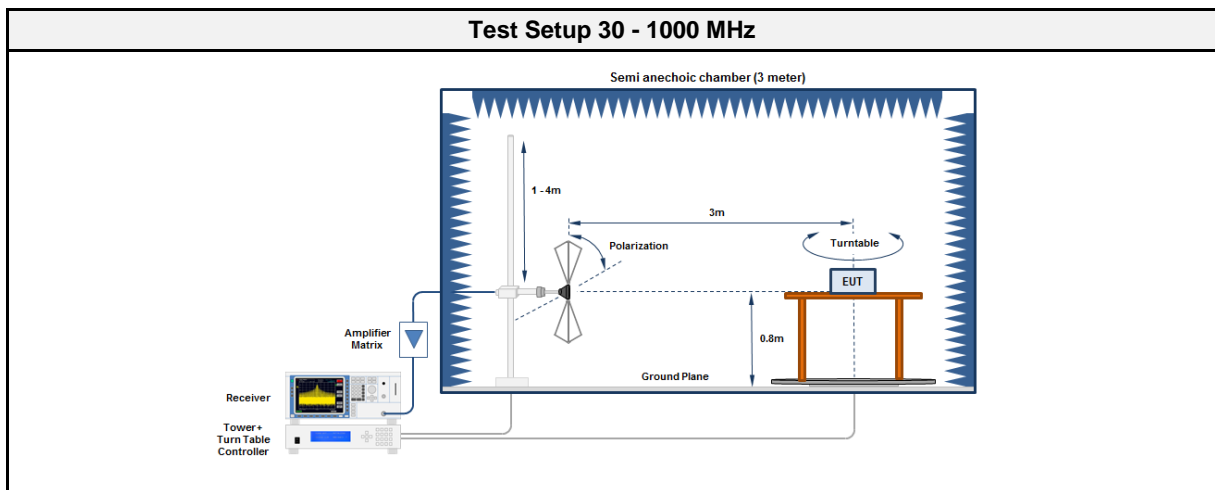

3.6.4 Equipment

Test Equipment 30 - 1000 MHz					
Description	Manufacturer	Model	Identifier	Cal. Date	Cal. Due
Anechoic Chamber	Frankonia	AC1	EF00062	2018-07	2021-07
Measurement Receiver	Agilent	N9038A-526/WXP	EF01070	2018-08	2019-08
Antenna	R&S	HK 116	EF00030	2016-04	2019-04
Antenna	R&S	HL 223	EF00187	2016-05	2019-05

Test Equipment > 1 GHz					
Description	Manufacturer	Model	Identifier	Cal. Date	Cal. Due
Anechoic Chamber	Frankonia	AC1	EF00062	2018-07	2021-07
Measurement Receiver	Agilent	N9038A-526/WXP	EF01070	2018-08	2019-08
Antenna	Schwarzbeck	BBHA 9120D	EF01153	2018-09	2019-09

3.6.5 Procedure

Test Procedure
<ol style="list-style-type: none"> 1. EUT set to test mode 2. Span it set according to measurement range 3. Resolution bandwidth below 1 GHz is set according to CISPR 16 with peak/quasi-peak detector and RBW of 1 MHz with peak/average detector is used above 1 GHz 4. Markers are set to peak emission levels within restricted bands

3.6.6 Results

Test Results							
Channel [MHz]	Emission [MHz]	Level [dB μ V/m]	Det.	Pol.	Limit [dB μ V/m]	Limit dist. [m]	Margin [dB]
402.45	405.25	25.67	pk	ver	46.00	3	-20.33
402.45	408.221	24.05	pk	ver	46.00	3	-21.95
404.85	398.525	18.42	pk	hor	46.00	3	-27.58
404.85	398.525	16.85	pk	ver	46.00	3	-29.15
404.85	405.844	31.05	pk	ver	46.00	3	-14.95

3.7 Test Conditions and Results - Receiver spurious emissions

3.7.1 Information

Test Information	
Reference	ISED RSS-243 3.5, 5.6 ISED RSS-Gen 7.3
Measurement Method	ANSI C63.10 6.10
Operator	Wilfried Treffke
Date	2018-10-10

3.7.2 Limits

Limits				
Frequency range [MHz]	Detector	Limit [$\mu\text{V}/\text{m}$]	Limit [$\text{dB}\mu\text{V}/\text{m}$]	Limit Distance [m]
30 – 88	Quasi-Peak	100	40	3
88 – 216	Quasi-Peak	150	43.5	3
216 – 960	Quasi-Peak	200	46	3
960 – 1000	Quasi-Peak	500	54	3
> 1000	Average	500	54	3

3.7.3 Setup

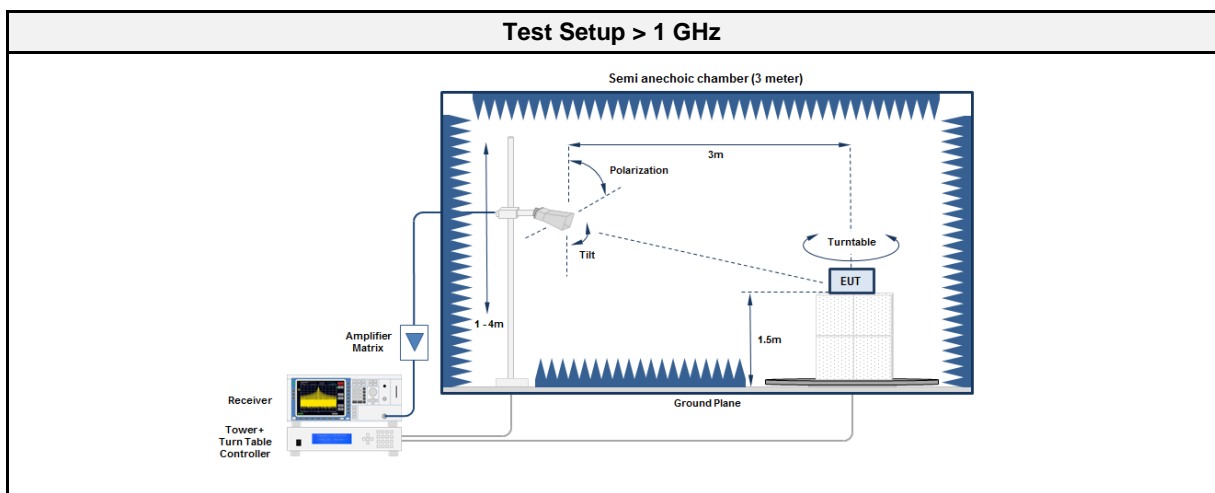
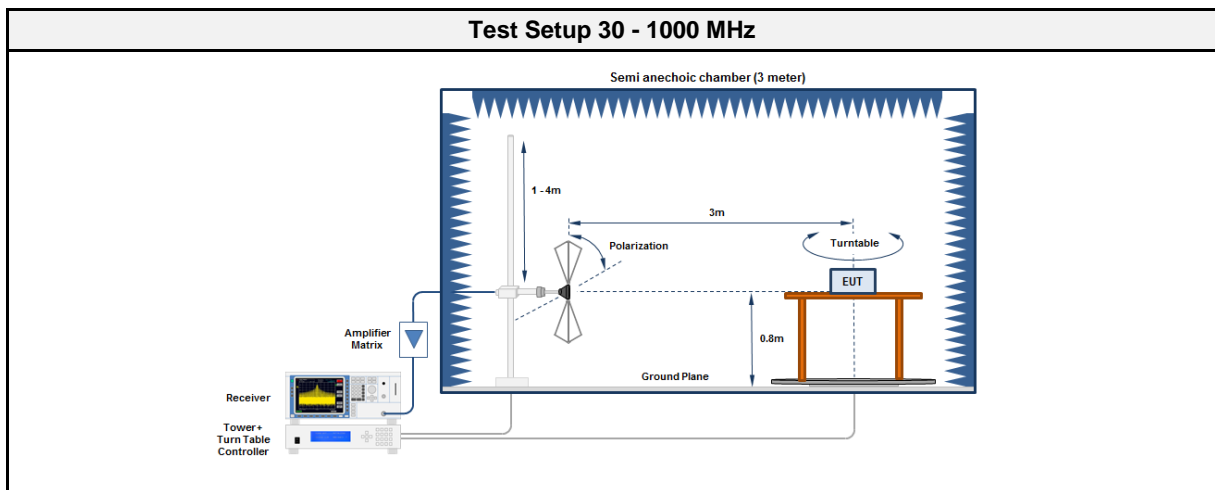

3.7.4 Equipment

Test Equipment 30 - 1000 MHz					
Description	Manufacturer	Model	Identifier	Cal. Date	Cal. Due
Anechoic Chamber	Frankonia	AC1	EF00062	2018-07	2021-07
Measurement Receiver	Agilent	N9038A-526/WXP	EF01070	2018-08	2019-08
Antenna	R&S	HK 116	EF00030	2016-04	2019-04
Antenna	R&S	HL 223	EF00187	2016-05	2019-05

Test Equipment > 1 GHz					
Description	Manufacturer	Model	Identifier	Cal. Date	Cal. Due
Anechoic Chamber	Frankonia	AC1	EF00062	2018-07	2021-07
Measurement Receiver	Agilent	N9038A-526/WXP	EF01070	2018-08	2019-08
Antenna	Schwarzbeck	BBHA 9120D	EF01153	2018-09	2019-09

3.7.5 Procedure

Test Procedure
<ol style="list-style-type: none"> 1. EUT set to receive mode 2. Span it set according to measurement range 3. Resolution bandwidth below 1 GHz is set according to CISPR 16 with peak/quasi-peak detector and RBW of 1 MHz with peak/average detector is used above 1 GHz 4. Markers are set to peak emission levels

3.7.6 Results

Test Results						
Channel [MHz]	Emission [MHz]	Emission Level [dBμV/m]	Det.	Pol.	Limit [dBμV/m]	Margin [dB]
403.65	193.377	31.05	pk	hor	43.50	-12.45
403.65	1701	34.11	pk	hor	53.98	-19.87
403.65	3970	41.93	pk	hor	53.98	-12.05
403.65	3970	42.20	pk	ver	53.98	-11.78

ANNEX A Transmitter spurious emissions

Spurious emissions according to FCC Part 95; Subpart I

Project number: G0M-1809-7676

Applicant: BIOTRONIK SE & Co. KG
 EUT Name: BM2610 / Implantable Cardiac Monitor
 Model: BIOMONITOR III
 Test Site: Eurofins Product Service GmbH
 Operator: Wilfried Treffke
 Test Conditions: Tnom: 22°C, Vnom: 2.7 VDC (Battery)
 Antenna: HK116, Horizontal
 Measurement distance: 3 m
 Mode: TX; 2-FSK; 402.45 MHz
 Test Date: 2018-10-09
 Note:

Index 19

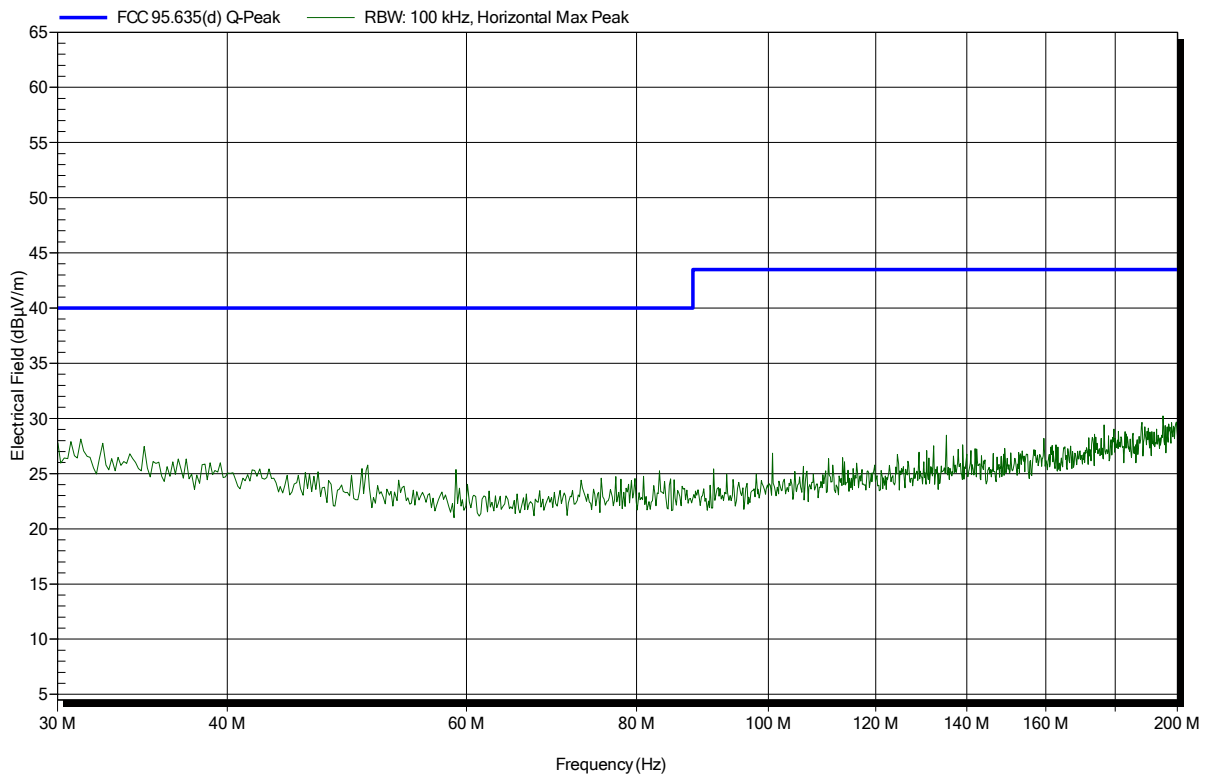

Spurious emissions according to FCC Part 95; Subpart I

Project number: G0M-1809-7676

Applicant: BIOTRONIK SE & Co. KG
 EUT Name: BM2610 / Implantable Cardiac Monitor
 Model: BIOMONITOR III
 Test Site: Eurofins Product Service GmbH
 Operator: Wilfried Treffke
 Test Conditions: Tnom: 22°C, Vnom: 2.7 VDC (Battery)
 Antenna: HK116, Vertical
 Measurement distance: 3 m
 Mode: TX; 2-FSK; 402.45 MHz
 Test Date: 2018-10-09
 Note:

Index 20

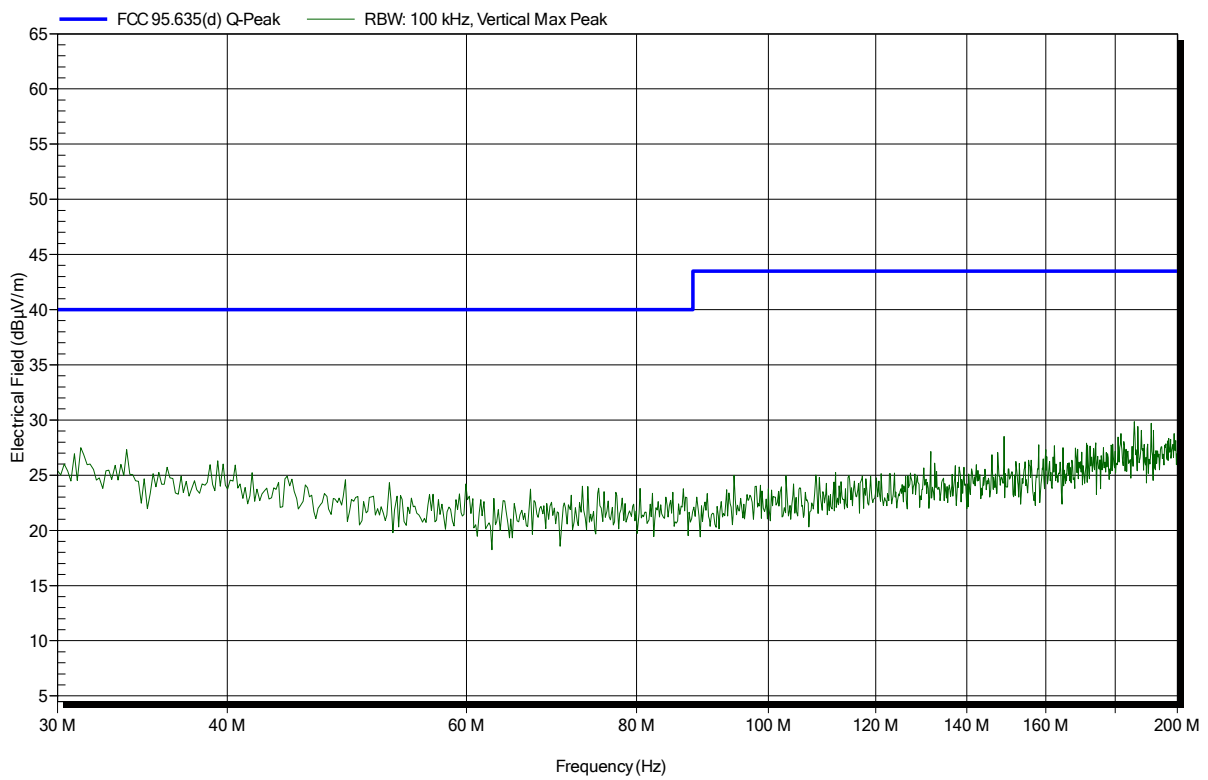

Spurious emissions according to FCC Part 95; Subpart I

Project number: G0M-1809-7676

Applicant: BIOTRONIK SE & Co. KG
 EUT Name: BM2610 / Implantable Cardiac Monitor
 Model: BIOMONITOR III
 Test Site: Eurofins Product Service GmbH
 Operator: Wilfried Treffke
 Test Conditions: Tnom: 22°C, Vnom: 2.7 VDC (Battery)
 Antenna: HL223, Horizontal
 Measurement distance: 3 m
 Mode: TX; 2-FSK; 402.45 MHz
 Test Date: 2018-10-09
 Note:

Index 22

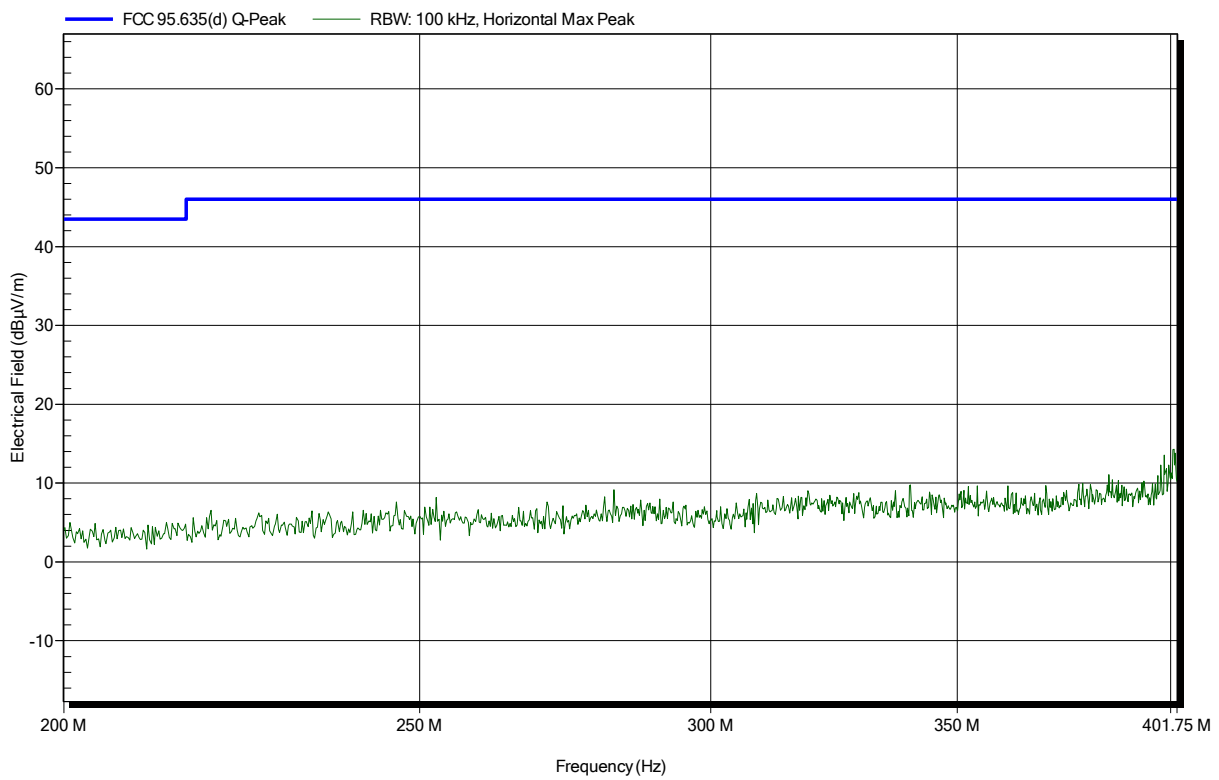

Spurious emissions according to FCC Part 95; Subpart I

Project number: G0M-1809-7676

Applicant: BIOTRONIK SE & Co. KG
 EUT Name: BM2610 / Implantable Cardiac Monitor
 Model: BIOMONITOR III
 Test Site: Eurofins Product Service GmbH
 Operator: Wilfried Treffke
 Test Conditions: Tnom: 22°C, Vnom: 2.7 VDC (Battery)
 Antenna: HL223, Vertical
 Measurement distance: 3 m
 Mode: TX; 2-FSK; 402.45 MHz
 Test Date: 2018-10-09
 Note:

Index 21

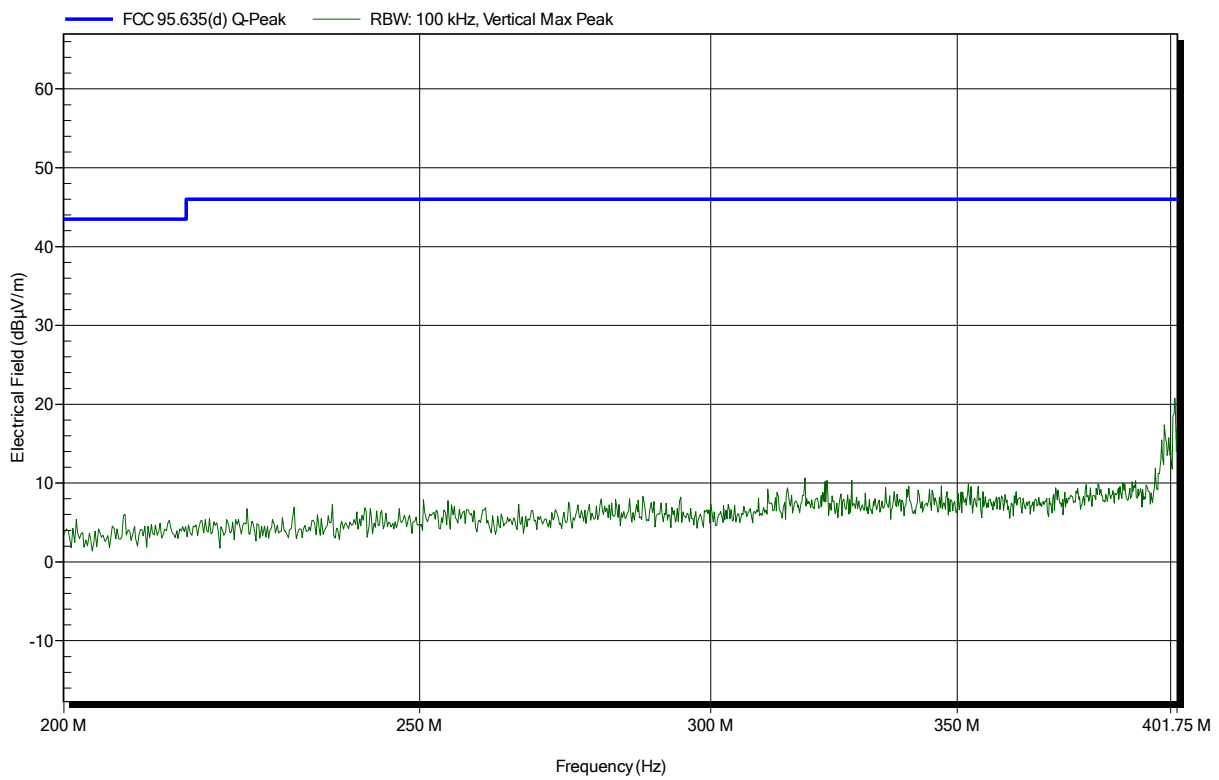

Spurious emissions according to FCC Part 95; Subpart I

Project number: G0M-1809-7676

Applicant: BIOTRONIK SE & Co. KG
 EUT Name: BM2610 / Implantable Cardiac Monitor
 Model: BIOMONITOR III
 Test Site: Eurofins Product Service GmbH
 Operator: Wilfried Treffke
 Test Conditions: Tnom: 22°C, Vnom: 2.7 VDC (Battery)
 Antenna: HL223, Horizontal
 Measurement distance: 3 m
 Mode: TX; 2-FSK; 402.45 MHz
 Test Date: 2018-10-09
 Note:

Index 27

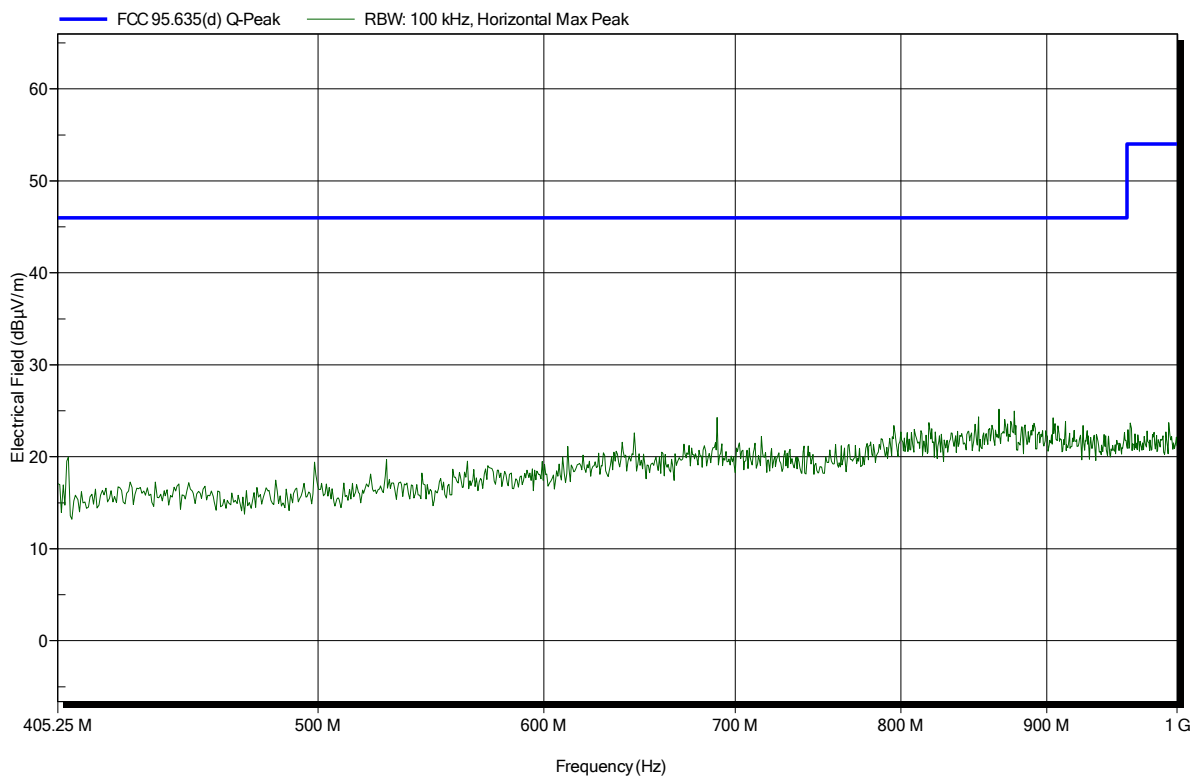

Spurious emissions according to FCC Part 95; Subpart I

Project number: G0M-1809-7676

Applicant: BIOTRONIK SE & Co. KG
 EUT Name: BM2610 / Implantable Cardiac Monitor
 Model: BIOMONITOR III
 Test Site: Eurofins Product Service GmbH
 Operator: Wilfried Treffke
 Test Conditions: Tnom: 22°C, Vnom: 2.7 VDC (Battery)
 Antenna: HL223, Vertical
 Measurement distance: 3 m
 Mode: TX; 2-FSK; 402.45 MHz
 Test Date: 2018-10-09
 Note:

Index 28

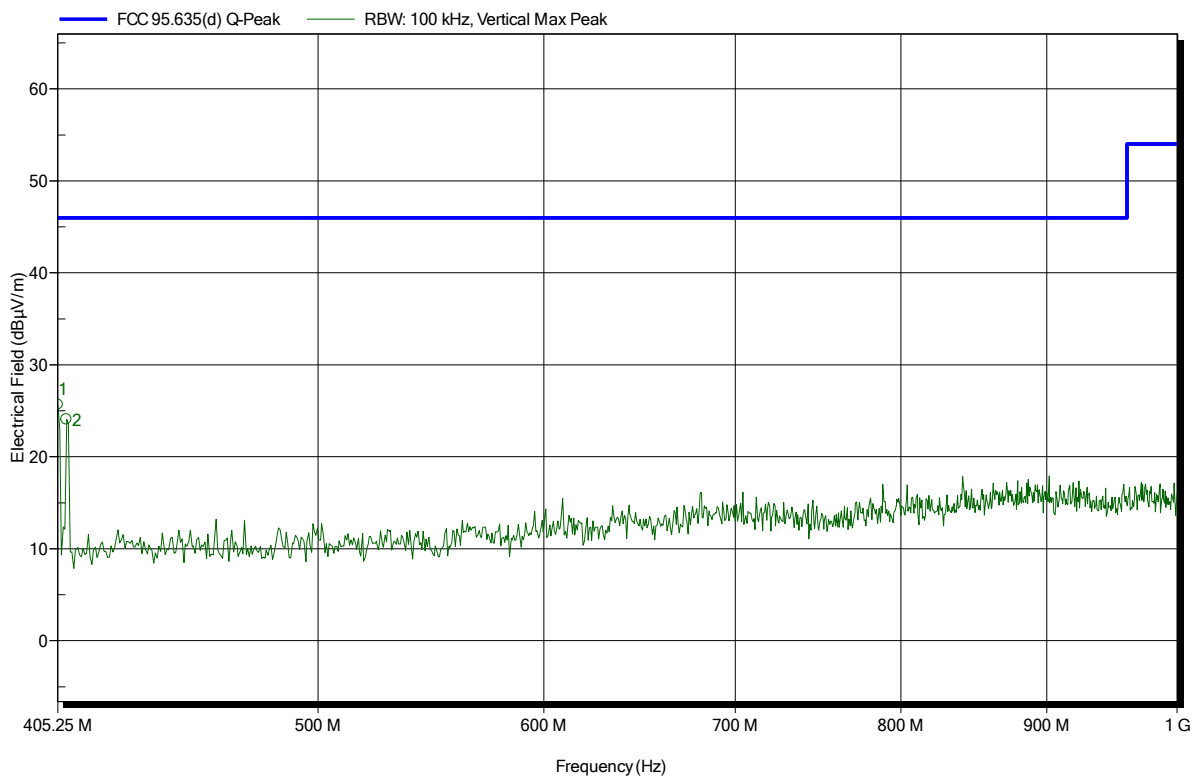

Frequency	Peak	Peak Limit	Peak Difference	Peak Status
405.25 MHz	25.67 dBµV/m	46 dBµV/m	-20.33 dB	Pass
408.221 MHz	24.05 dBµV/m	46 dBµV/m	-21.95 dB	Pass

Spurious emissions according to FCC Part 95; Subpart I

Project number: G0M-1809-7676

Applicant: BIOTRONIK SE & Co. KG
 EUT Name: BM2610 / Implantable Cardiac Monitor
 Model: BIOMONITOR III
 Test Site: Eurofins Product Service GmbH
 Operator: Wilfried Treffke
 Test Conditions: Tnom: 22°C, Vnom: 2.7 VDC (Battery)
 Antenna: HL025, Horizontal
 Measurement distance: 3 m
 Mode: TX; 2-FSK; 402.45 MHz
 Test Date: 2018-10-09
 Note:

Index 29

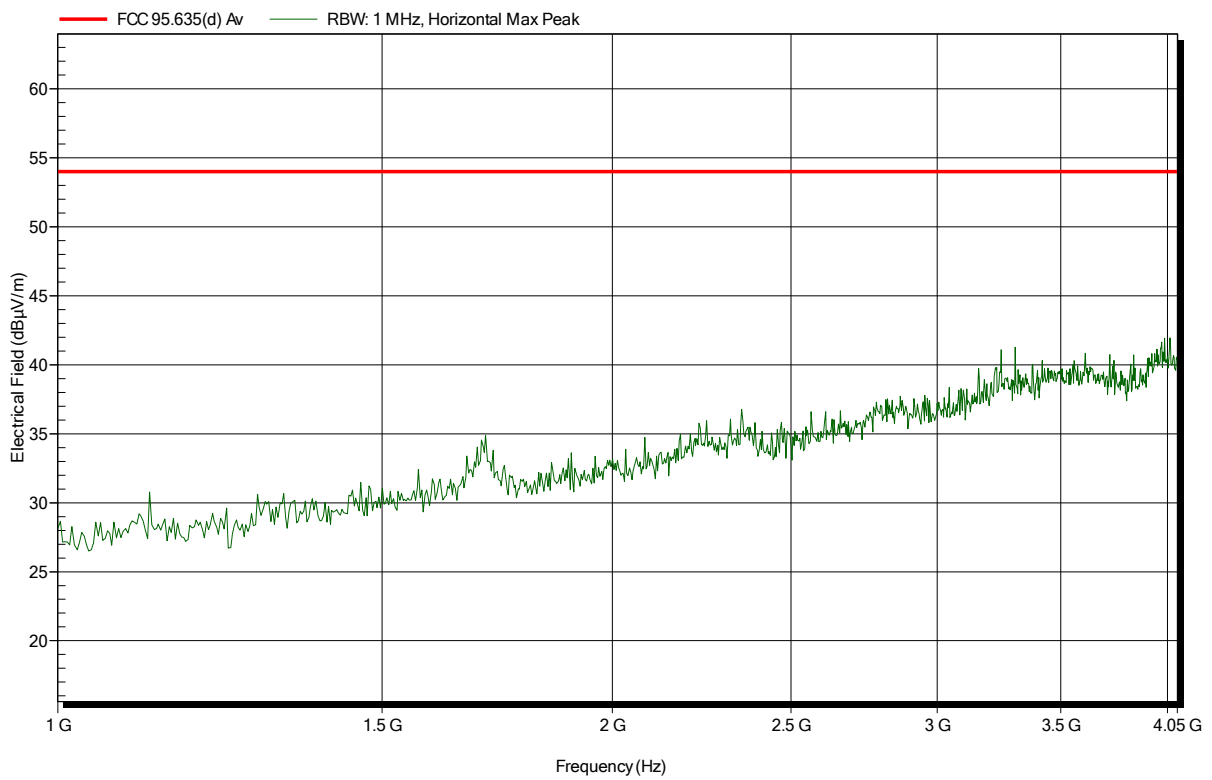

Spurious emissions according to FCC Part 95; Subpart I

Project number: G0M-1809-7676

Applicant: BIOTRONIK SE & Co. KG
 EUT Name: BM2610 / Implantable Cardiac Monitor
 Model: BIOMONITOR III
 Test Site: Eurofins Product Service GmbH
 Operator: Wilfried Treffke
 Test Conditions: Tnom: 22°C, Vnom: 2.7 VDC (Battery)
 Antenna: HL025, Vertical
 Measurement distance: 3 m
 Mode: TX; 2-FSK; 402.45 MHz
 Test Date: 2018-10-09
 Note:

Index 30

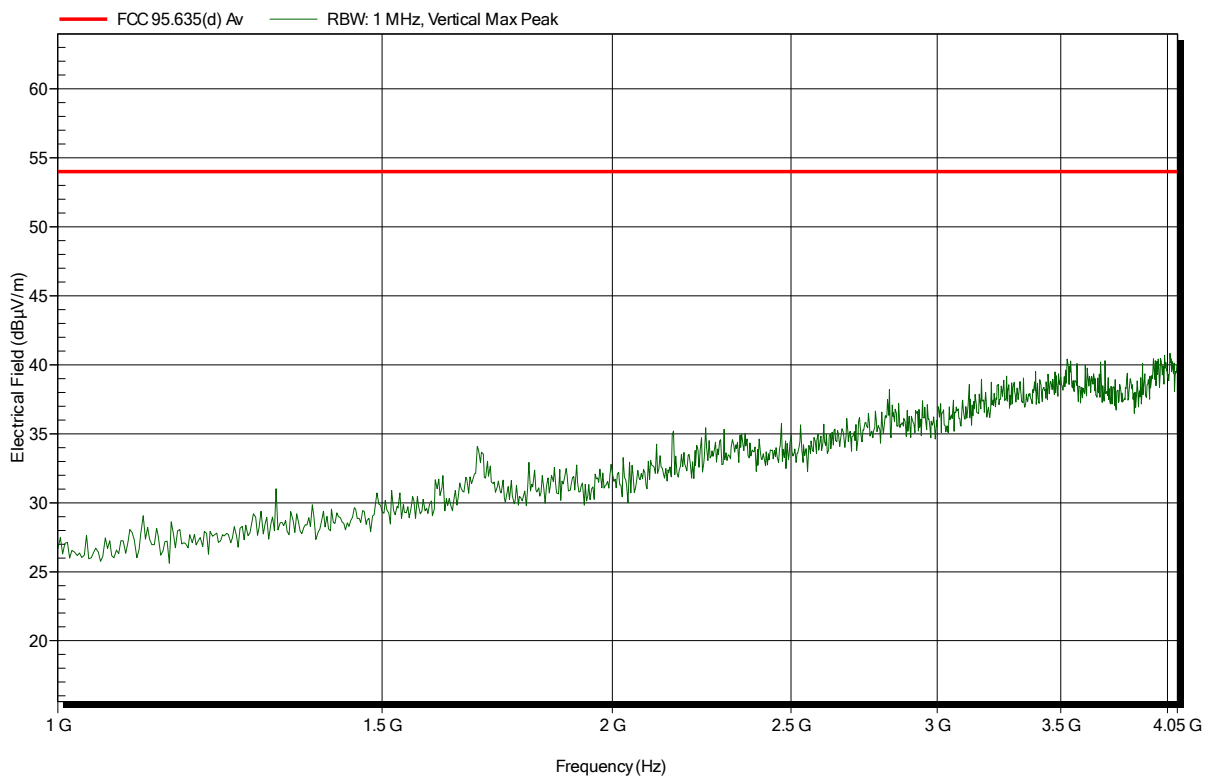

Spurious emissions according to FCC Part 95; Subpart I

Project number: G0M-1809-7676

Applicant: BIOTRONIK SE & Co. KG
 EUT Name: BM2610 / Implantable Cardiac Monitor
 Model: BIOMONITOR III
 Test Site: Eurofins Product Service GmbH
 Operator: Wilfried Treffke
 Test Conditions: Tnom: 22°C, Vnom: 2.7 VDC (Battery)
 Antenna: HK116, Horizontal
 Measurement distance: 3 m
 Mode: TX; 2-FSK; 404.85 MHz
 Test Date: 2018-10-09
 Note:

Index 34

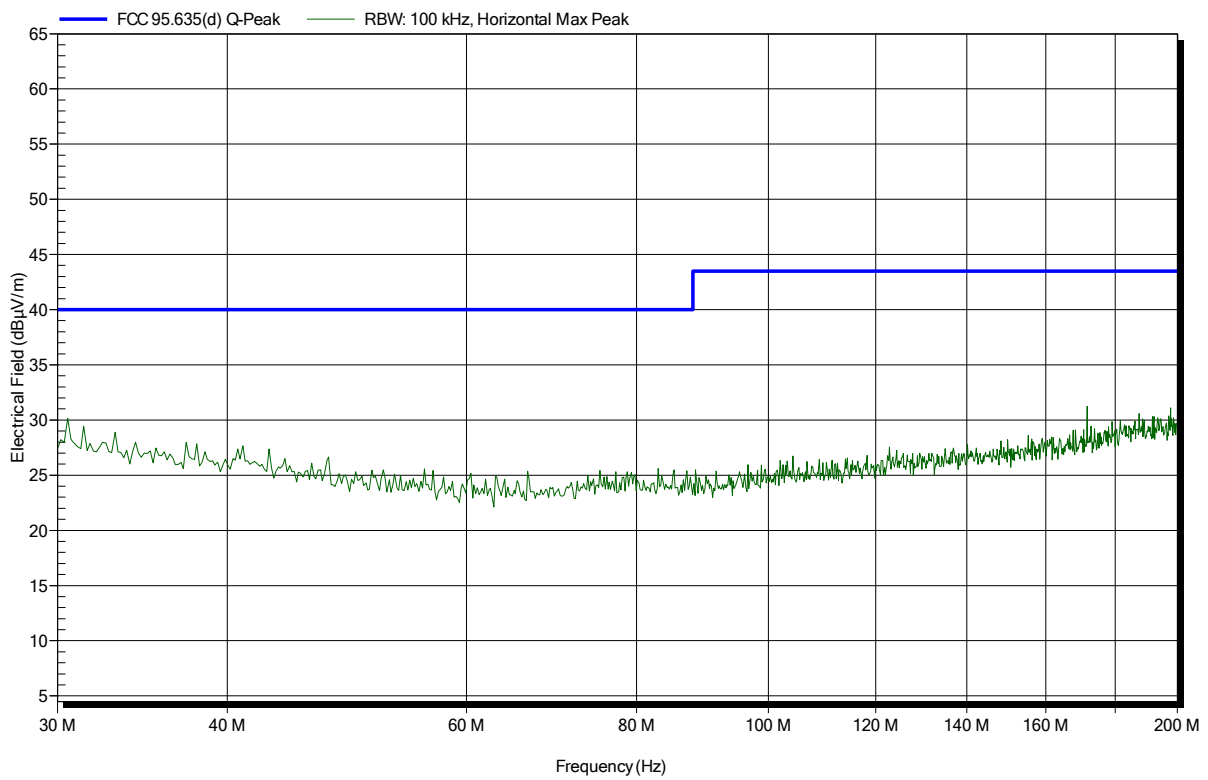

Spurious emissions according to FCC Part 95; Subpart I

Project number: G0M-1809-7676

Applicant: BIOTRONIK SE & Co. KG
 EUT Name: BM2610 / Implantable Cardiac Monitor
 Model: BIOMONITOR III
 Test Site: Eurofins Product Service GmbH
 Operator: Wilfried Treffke
 Test Conditions: Tnom: 22°C, Vnom: 2.7 VDC (Battery)
 Antenna: HK116, Vertical
 Measurement distance: 3 m
 Mode: TX; 2-FSK; 404.85 MHz
 Test Date: 2018-10-09
 Note:

Index 35

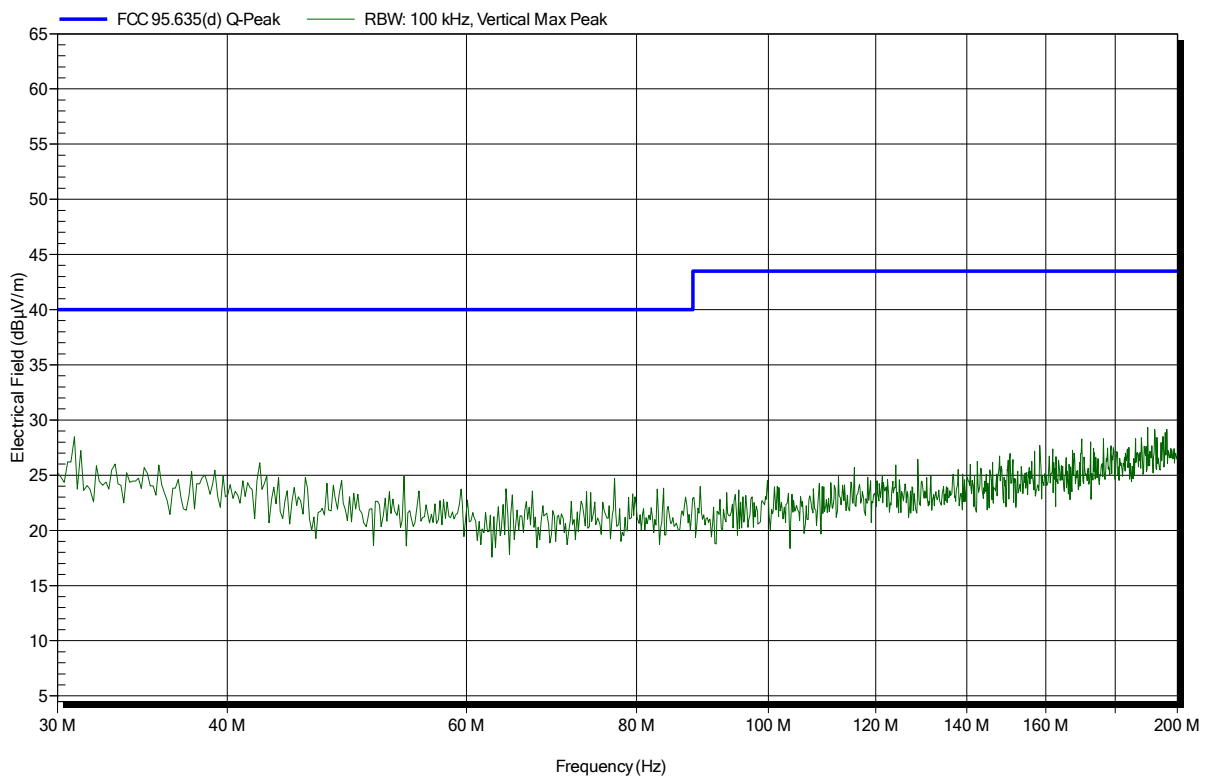

Spurious emissions according to FCC Part 95; Subpart I

Project number: G0M-1809-7676

Applicant: BIOTRONIK SE & Co. KG
 EUT Name: BM2610 / Implantable Cardiac Monitor
 Model: BIOMONITOR III
 Test Site: Eurofins Product Service GmbH
 Operator: Wilfried Treffke
 Test Conditions: Tnom: 22°C, Vnom: 2.7 VDC (Battery)
 Antenna: HL223, Horizontal
 Measurement distance: 3 m
 Mode: TX; 2-FSK; 404.85 MHz
 Test Date: 2018-10-09
 Note:

Index 36

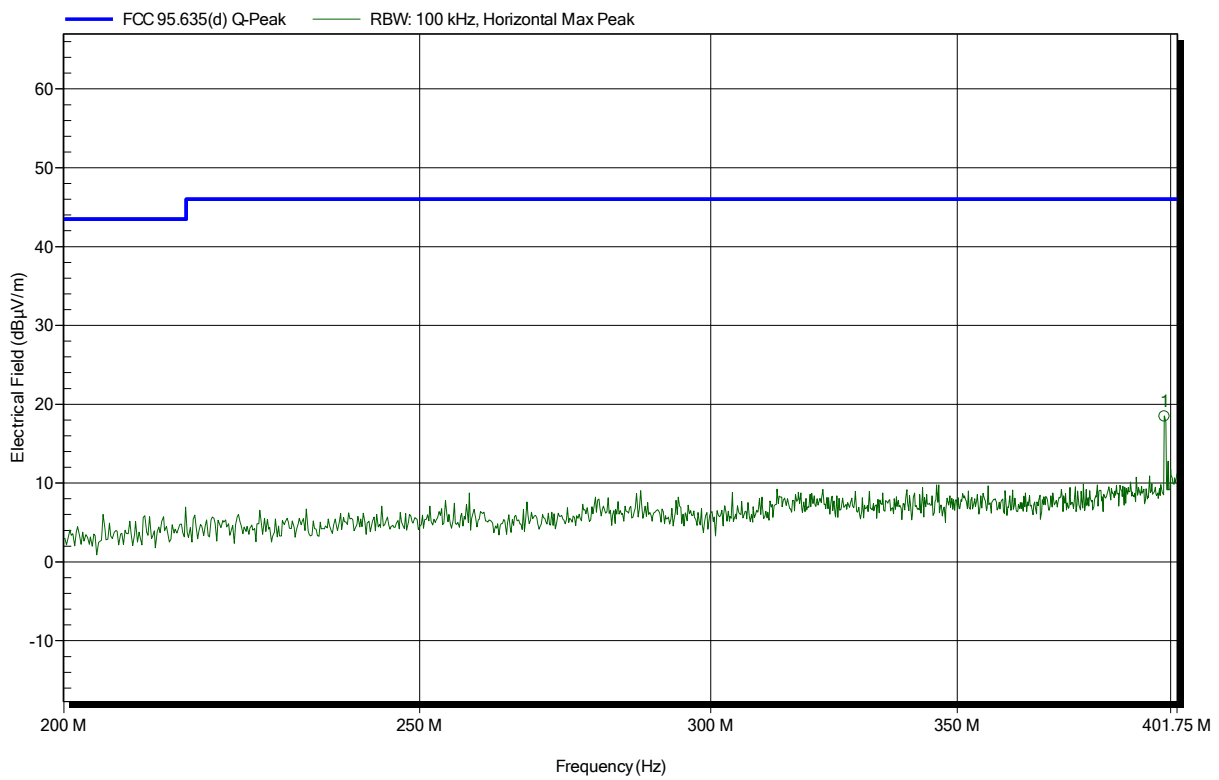

Frequency	Peak	Peak Limit	Peak Difference	Peak Status
398.525 MHz	18.42 dBµV/m	46 dBµV/m	-27.58 dB	Pass

Spurious emissions according to FCC Part 95; Subpart I

Project number: G0M-1809-7676

Applicant: BIOTRONIK SE & Co. KG
 EUT Name: BM2610 / Implantable Cardiac Monitor
 Model: BIOMONITOR III
 Test Site: Eurofins Product Service GmbH
 Operator: Wilfried Treffke
 Test Conditions: Tnom: 22°C, Vnom: 2.7 VDC (Battery)
 Antenna: HL223, Vertical
 Measurement distance: 3 m
 Mode: TX; 2-FSK; 404.85 MHz
 Test Date: 2018-10-09
 Note:

Index 37

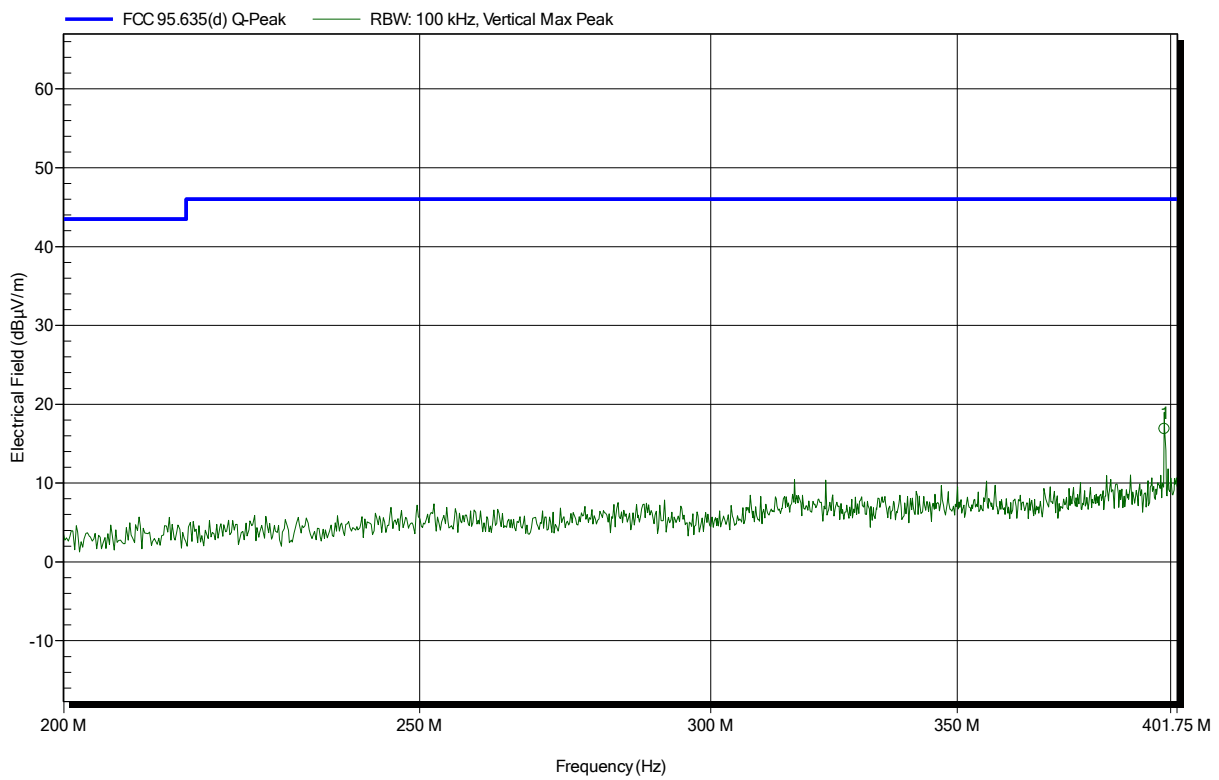

Frequency	Peak	Peak Limit	Peak Difference	Peak Status
398.525 MHz	16.85 dBµV/m	46 dBµV/m	-29.15 dB	Pass

Spurious emissions according to FCC Part 95; Subpart I

Project number: G0M-1809-7676

Applicant: BIOTRONIK SE & Co. KG
 EUT Name: BM2610 / Implantable Cardiac Monitor
 Model: BIOMONITOR III
 Test Site: Eurofins Product Service GmbH
 Operator: Wilfried Treffke
 Test Conditions: Tnom: 22°C, Vnom: 2.7 VDC (Battery)
 Antenna: HL223, Horizontal
 Measurement distance: 3 m
 Mode: TX; 2-FSK; 404.85 MHz
 Test Date: 2018-10-09
 Note:

Index 42

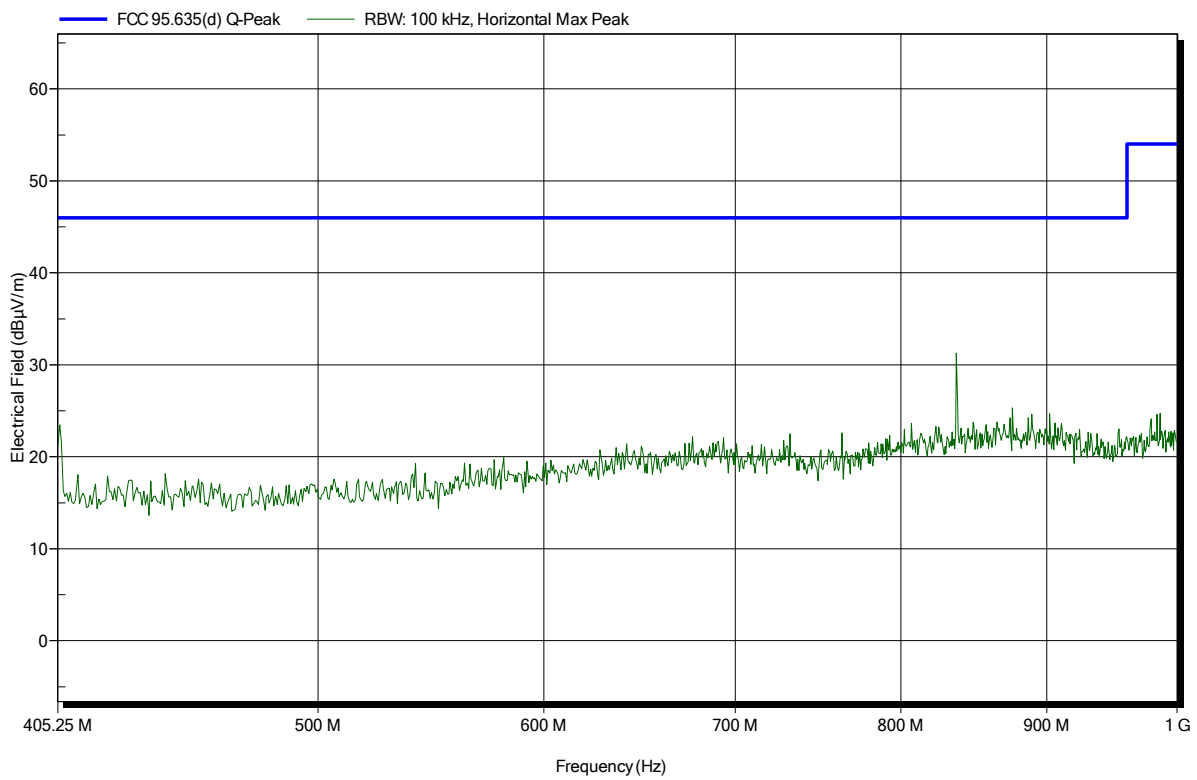

Spurious emissions according to FCC Part 95; Subpart I

Project number: G0M-1809-7676

Applicant: BIOTRONIK SE & Co. KG
 EUT Name: BM2610 / Implantable Cardiac Monitor
 Model: BIOMONITOR III
 Test Site: Eurofins Product Service GmbH
 Operator: Wilfried Treffke
 Test Conditions: Tnom: 22°C, Vnom: 2.7 VDC (Battery)
 Antenna: HL223, Vertical
 Measurement distance: 3 m
 Mode: TX; 2-FSK; 404.85 MHz
 Test Date: 2018-10-09
 Note:

Index 43

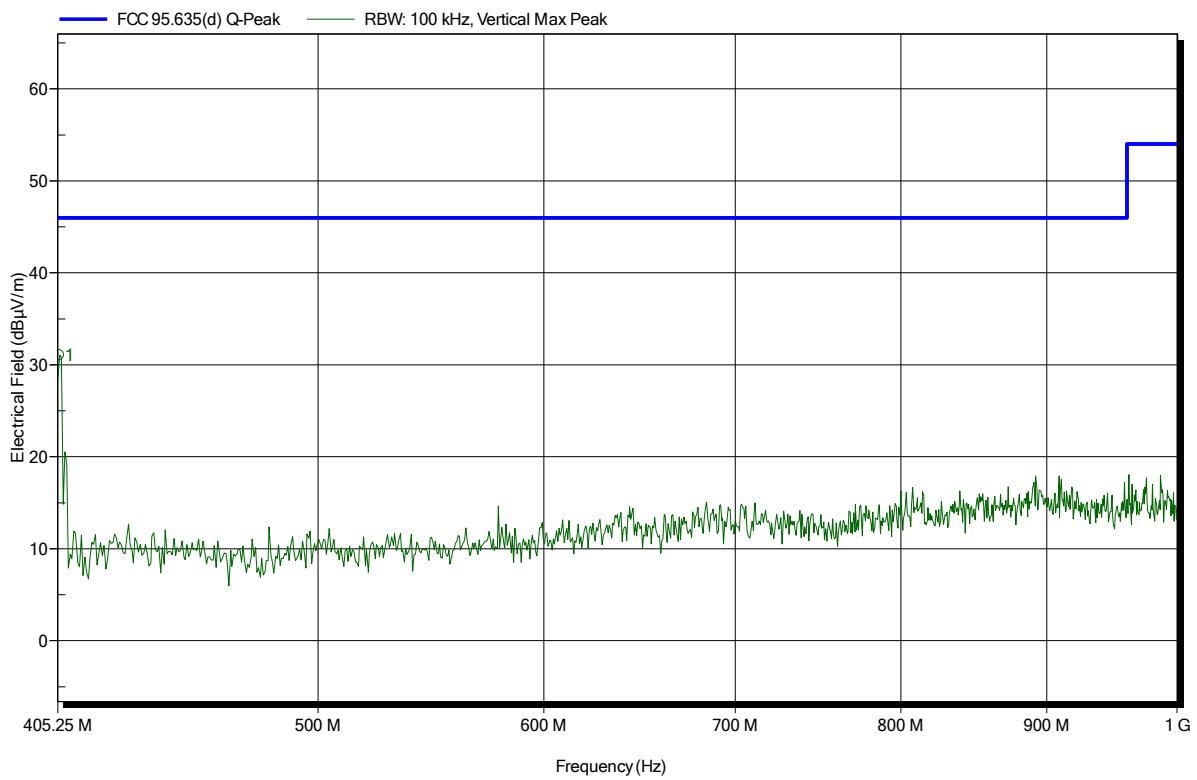

Frequency	Peak	Peak Limit	Peak Difference	Peak Status
405.844 MHz	31.05 dBµV/m	46 dBµV/m	-14.95 dB	Pass

Spurious emissions according to FCC Part 95; Subpart I

Project number: G0M-1809-7676

Applicant: BIOTRONIK SE & Co. KG
 EUT Name: BM2610 / Implantable Cardiac Monitor
 Model: BIOMONITOR III
 Test Site: Eurofins Product Service GmbH
 Operator: Wilfried Treffke
 Test Conditions: Tnom: 22°C, Vnom: 2.7 VDC (Battery)
 Antenna: HL025, Horizontal
 Measurement distance: 3 m
 Mode: TX; 2-FSK; 404.85 MHz
 Test Date: 2018-10-09
 Note:

Index 44

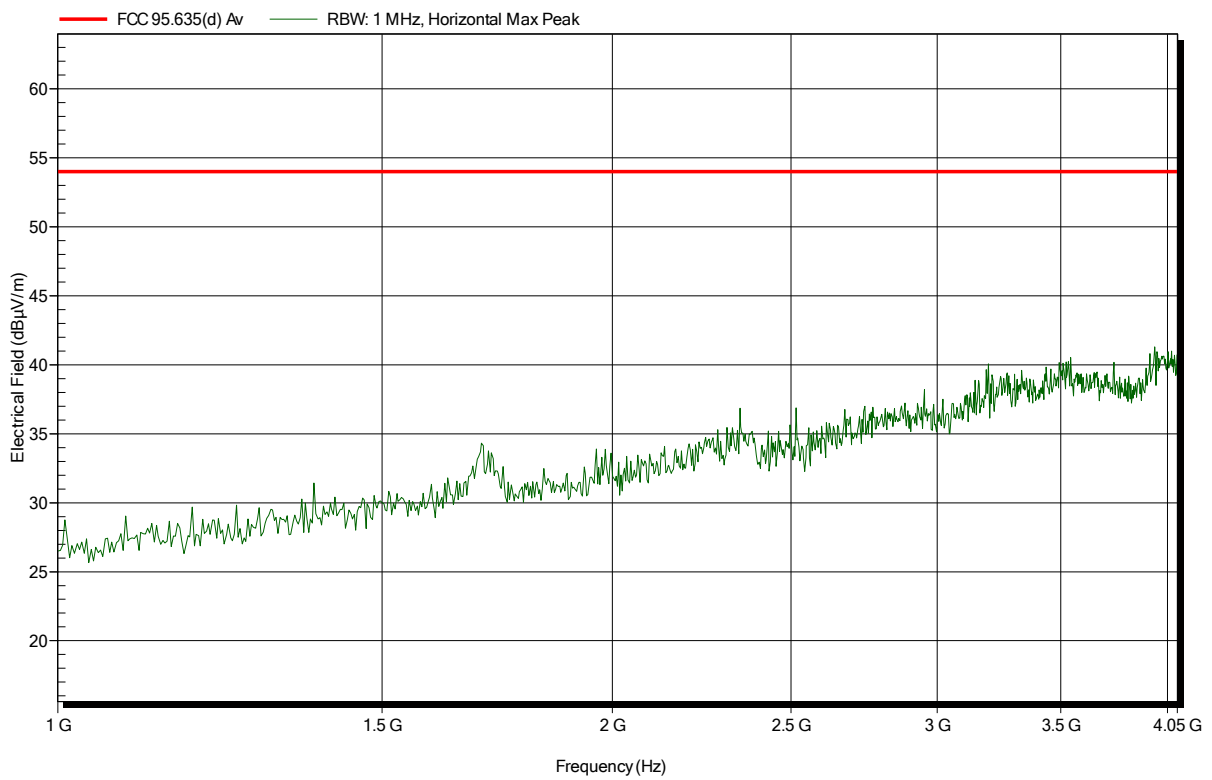

Spurious emissions according to FCC Part 95; Subpart I

Project number: G0M-1809-7676

Applicant: BIOTRONIK SE & Co. KG
 EUT Name: BM2610 / Implantable Cardiac Monitor
 Model: BIOMONITOR III
 Test Site: Eurofins Product Service GmbH
 Operator: Wilfried Treffke
 Test Conditions: Tnom: 22°C, Vnom: 2.7 VDC (Battery)
 Antenna: HL025, Vertical
 Measurement distance: 3 m
 Mode: TX; 2-FSK; 404.85 MHz
 Test Date: 2018-10-09
 Note:

Index 45

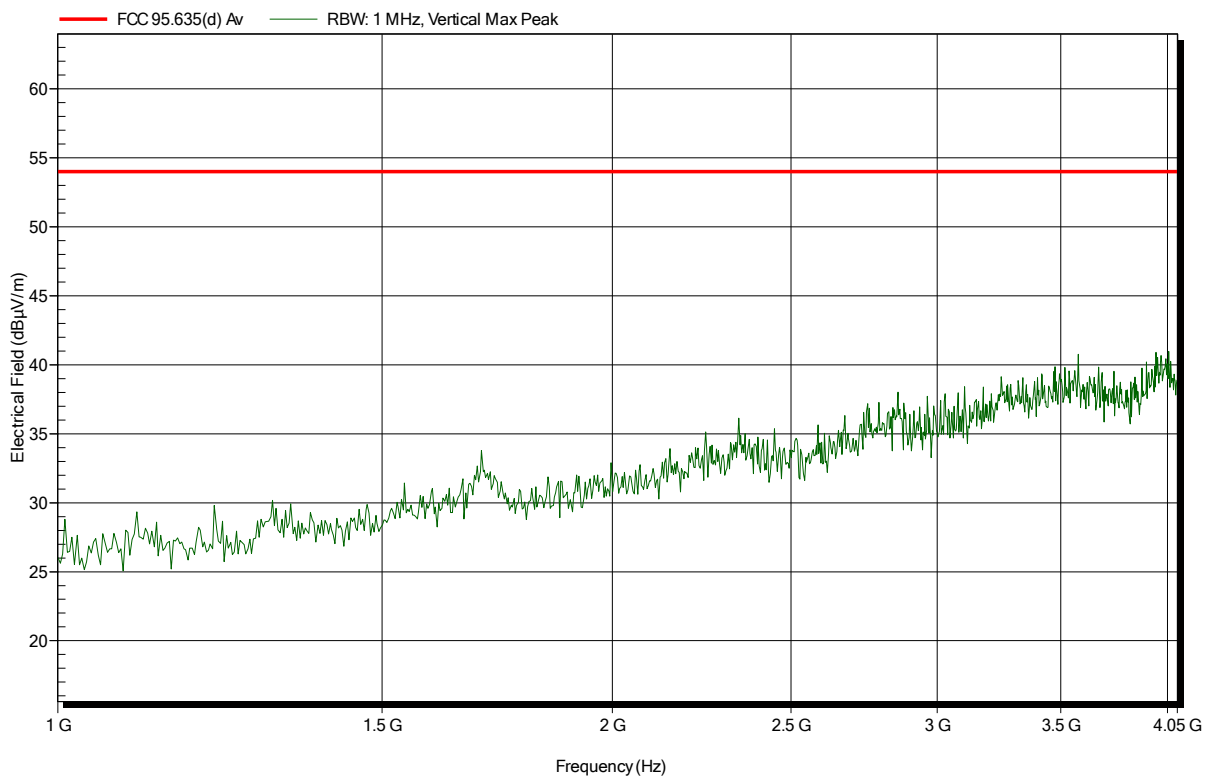

ANNEX B Receiver spurious emissions

Spurious emissions according to RSS-Gen

Project number: G0M-1809-7676

Applicant: BIOTRONIK SE & Co. KG
 EUT Name: BM2610 / Implantable Cardiac Monitor
 Model: BIOMONITOR III
 Test Site: Eurofins Product Service GmbH
 Operator: Wilfried Treffke
 Test Conditions: Tnom: 22°C, Vnom: 2.7 VDC (Battery)
 Antenna: HK116, Horizontal
 Measurement distance: 3 m
 Mode: RX; 403.65 MHz
 Test Date: 2018-10-10
 Note:

Index 13

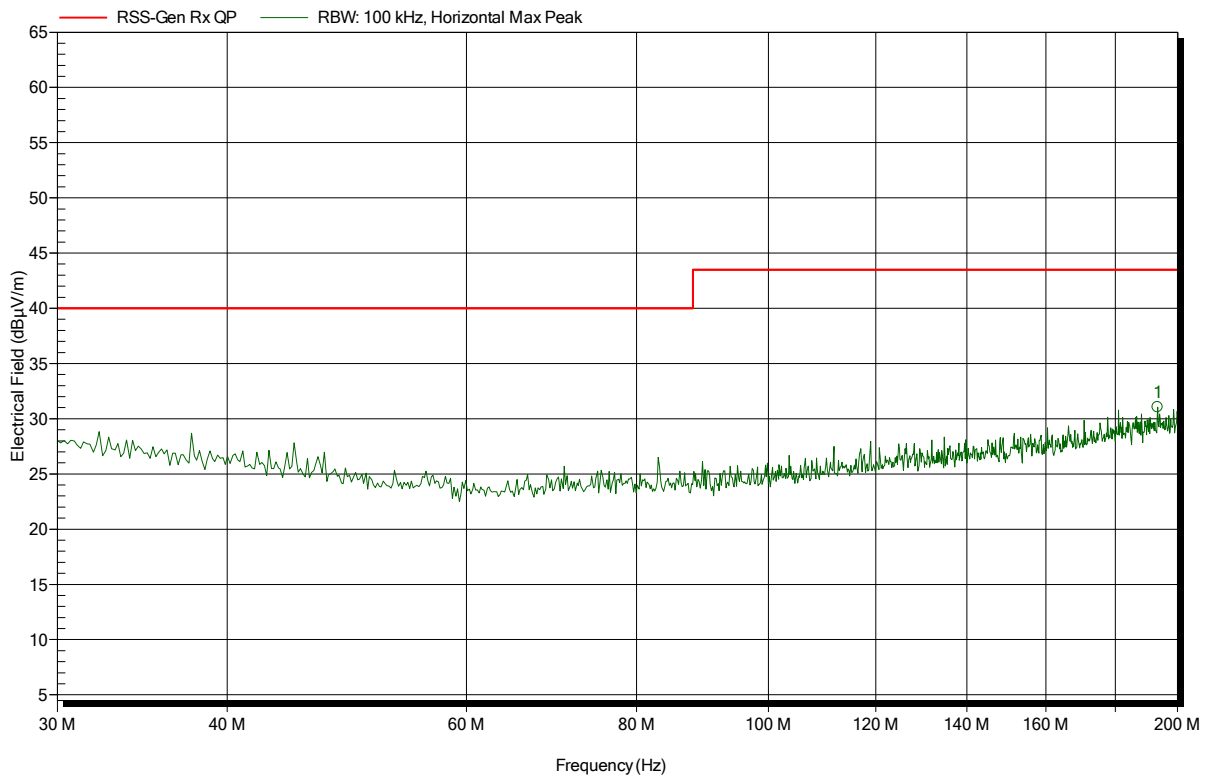

Frequency	Peak	Peak Limit	Peak Difference	Status
193.377 MHz	31.05 dBµV/m	43.5 dBµV/m	-12.45 dB	Pass

Spurious emissions according to RSS-Gen

Project number: G0M-1809-7676

Applicant: BIOTRONIK SE & Co. KG
 EUT Name: BM2610 / Implantable Cardiac Monitor
 Model: BIOMONITOR III
 Test Site: Eurofins Product Service GmbH
 Operator: Wilfried Treffke
 Test Conditions: Tnom: 22°C, Vnom: 2.7 VDC (Battery)
 Antenna: HK116, Vertical
 Measurement distance: 3 m
 Mode: RX; 403.65 MHz
 Test Date: 2018-10-10
 Note:

Index 14

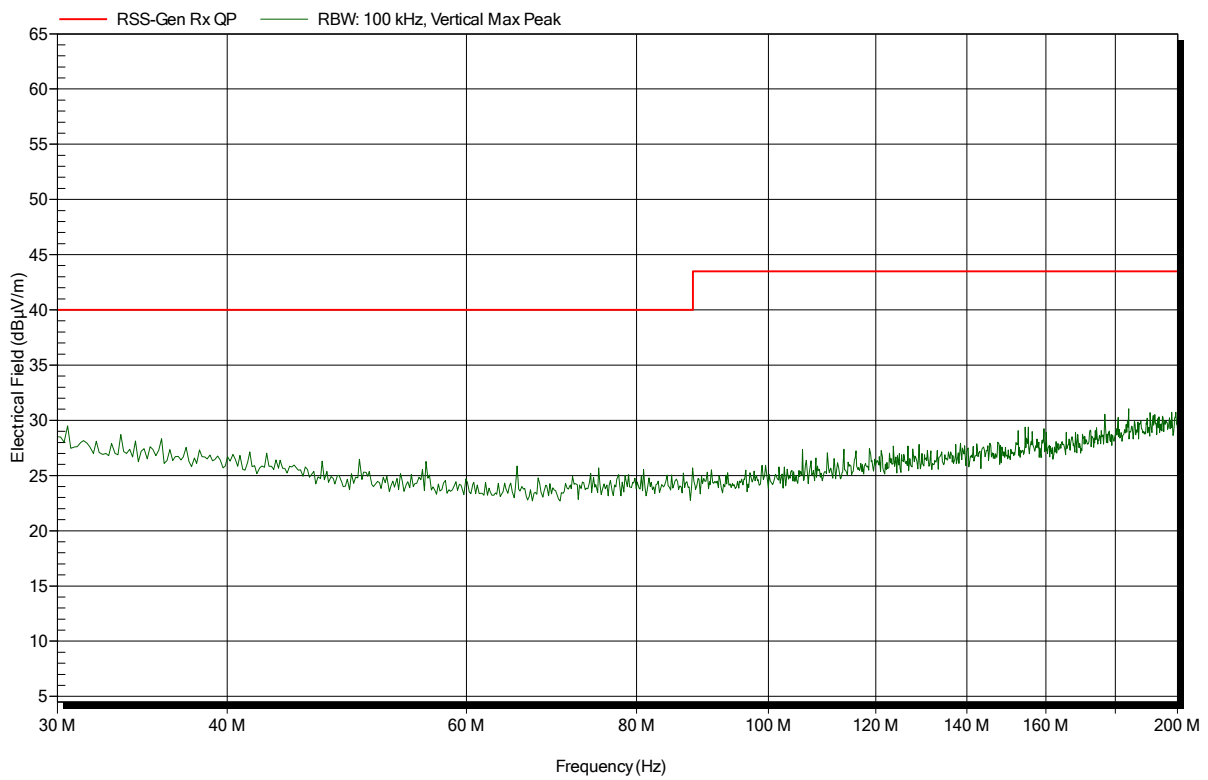

Spurious emissions according to RSS-Gen

Project number: G0M-1809-7676

Applicant: BIOTRONIK SE & Co. KG
 EUT Name: BM2610 / Implantable Cardiac Monitor
 Model: BIOMONITOR III
 Test Site: Eurofins Product Service GmbH
 Operator: Wilfried Treffke
 Test Conditions: Tnom: 22°C, Vnom: 2.7 VDC (Battery)
 Antenna: HL223, Horizontal
 Measurement distance: 3 m
 Mode: RX; 403.65 MHz
 Test Date: 2018-10-10
 Note:

Index 15

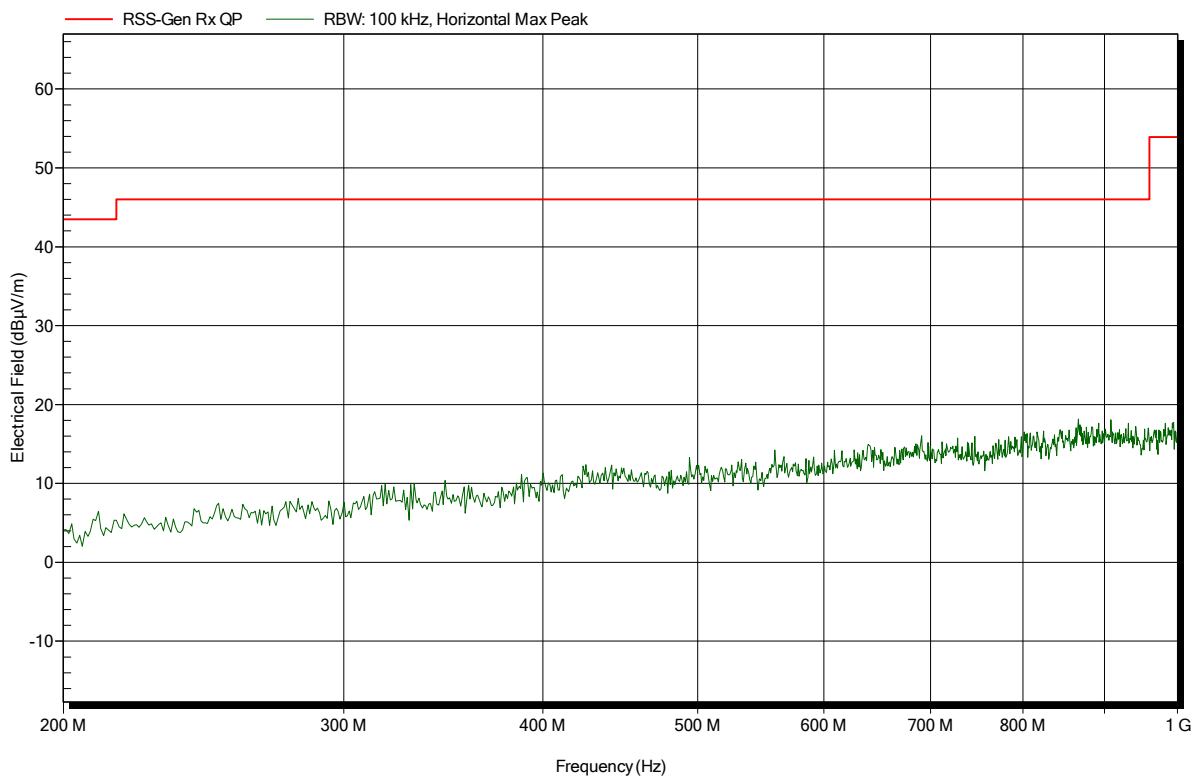

Spurious emissions according to RSS-Gen

Project number: G0M-1809-7676

Applicant: BIOTRONIK SE & Co. KG
 EUT Name: BM2610 / Implantable Cardiac Monitor
 Model: BIOMONITOR III
 Test Site: Eurofins Product Service GmbH
 Operator: Wilfried Treffke
 Test Conditions: Tnom: 22°C, Vnom: 2.7 VDC (Battery)
 Antenna: HL223, Vertical
 Measurement distance: 3 m
 Mode: RX; 403.65 MHz
 Test Date: 2018-10-10
 Note:

Index 16

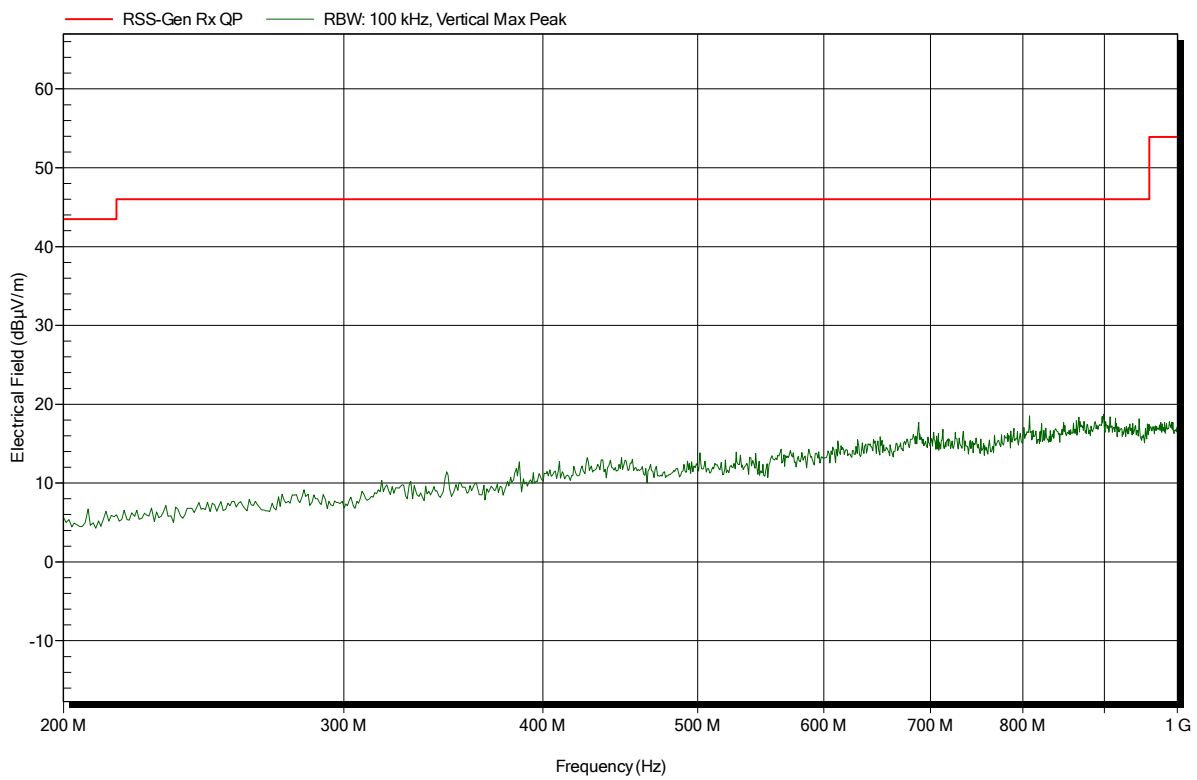

Spurious emissions according to RSS-Gen

Project number: G0M-1809-7676

Applicant: BIOTRONIK SE & Co. KG
 EUT Name: BM2610 / Implantable Cardiac Monitor
 Model: BIOMONITOR III
 Test Site: Eurofins Product Service GmbH
 Operator: Wilfried Treffke
 Test Conditions: Tnom: 22°C, Vnom: 2.7 VDC (Battery)
 Antenna: HL025, Horizontal
 Measurement distance: 3 m
 Mode: RX; 403.65 MHz
 Test Date: 2018-10-10
 Note:

Index 17

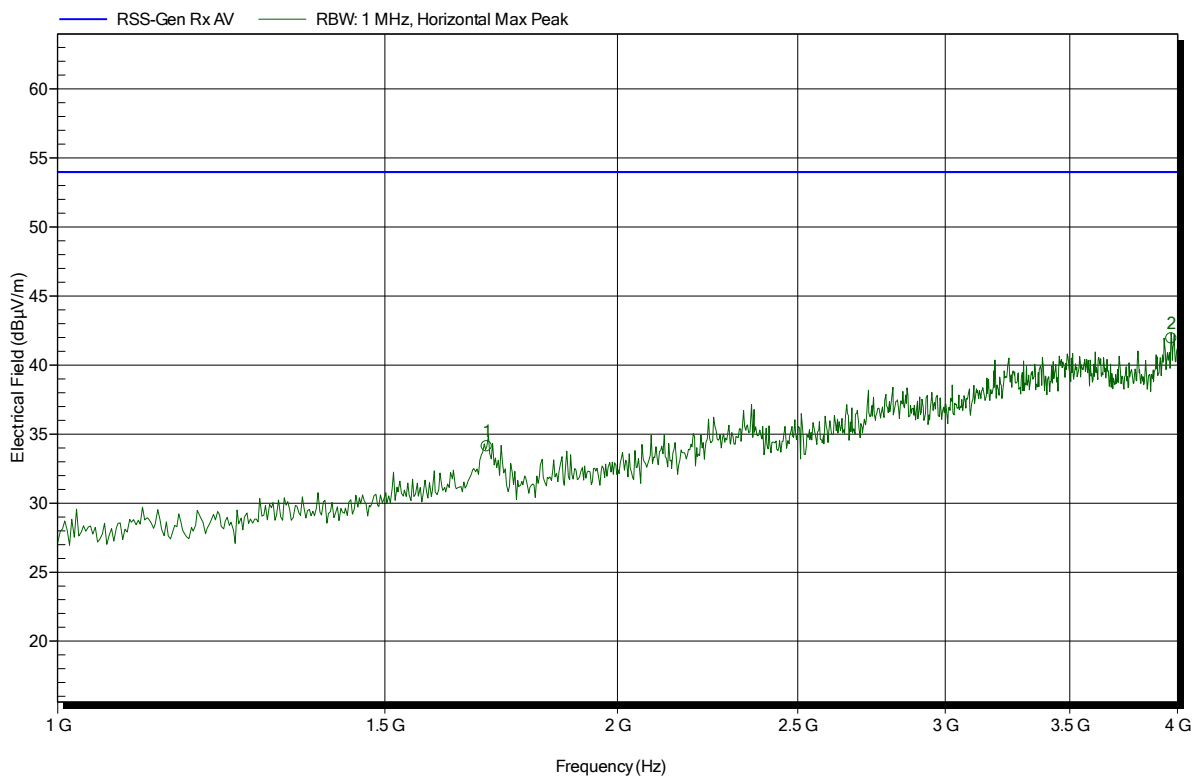

Frequency	Peak	Peak Limit	Peak Difference	Status
1.701 GHz	34.11 dBµV/m	53.98 dBµV/m	-19.87 dB	Pass
3.97 GHz	41.93 dBµV/m	53.98 dBµV/m	-12.05 dB	Pass

Spurious emissions according to RSS-Gen

Project number: G0M-1809-7676

Applicant: BIOTRONIK SE & Co. KG
 EUT Name: BM2610 / Implantable Cardiac Monitor
 Model: BIOMONITOR III
 Test Site: Eurofins Product Service GmbH
 Operator: Wilfried Treffke
 Test Conditions: Tnom: 22°C, Vnom: 2.7 VDC (Battery)
 Antenna: HL025, Vertical
 Measurement distance: 3 m
 Mode: RX; 403.65 MHz
 Test Date: 2018-10-10
 Note:

Index 18

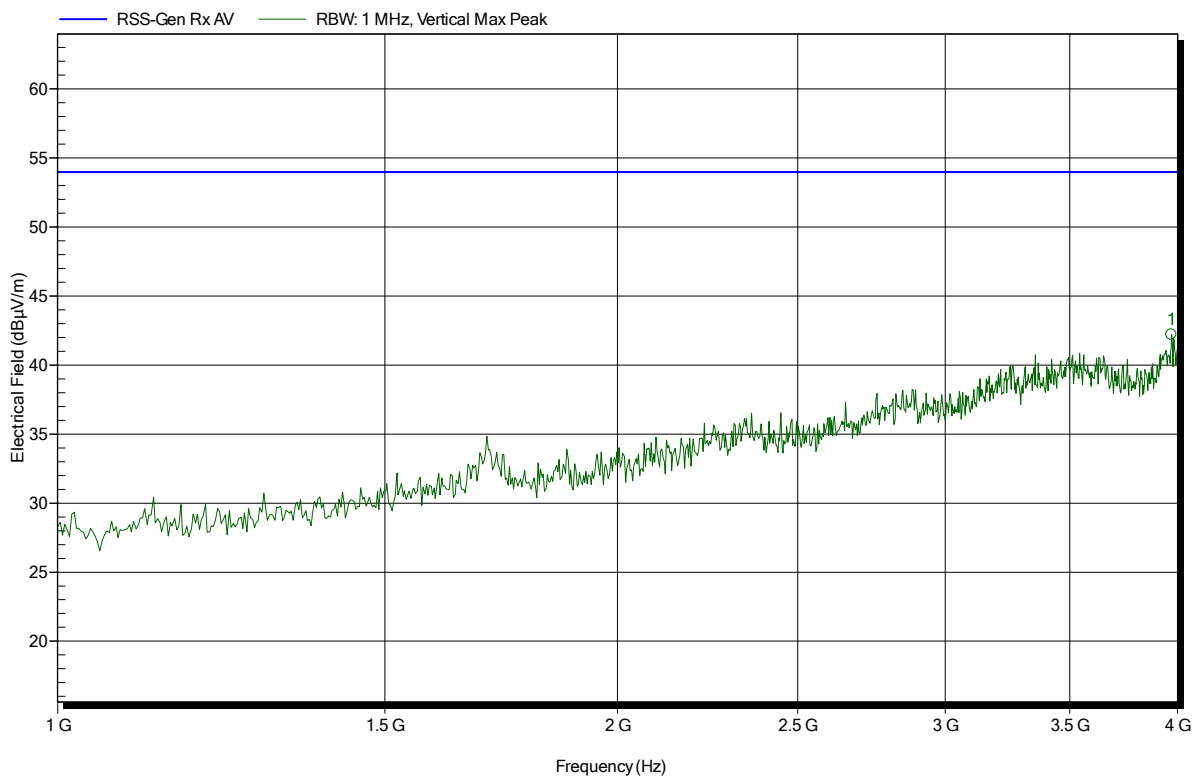

Frequency	Peak	Peak Limit	Peak Difference	Status
3.97 GHz	42.2 dBµV/m	53.98 dBµV/m	-11.78 dB	Pass