



**ELECTRONIC TECHNOLOGY SYSTEMS  
DR. GENZ GMBH**

# **TEST - REPORT**

**SAR Compliance Test Report**

**Test report no.:**

**G6D203010016-T-28**

# **SAR**

## TABLE OF CONTENTS

<b>1</b>	<b>General information</b>
1.1	Notes
1.2	Testing laboratory
1.3	Details of approval holder
1.4	Manufacturer
1.5	Application details
1.6	Test item
1.7	Test results
1.8	Test standards
<b>2</b>	<b>Technical test</b>
2.1	Summary of test results
2.2	Test environment
2.3	Test equipment utilized
2.4	Definitions
2.5	Measurement system description
2.6	Test system specification
2.7	Measurement procedure
2.8	Reference points
2.9	Test positions
2.10	Measurement uncertainty
<b>3</b>	<b>Tissue and system verification</b>
3.1	Tissue verification
3.2	System verification
<b>4</b>	<b>Test Results</b>
<b>5</b>	<b>References</b>
<b>6</b>	<b>Appendix</b>

# 1 General Information

## 1.1 Notes

The purpose of conformity testing is to increase the probability of adherence to the essential requirements or conformity specifications, as appropriate.

The complexity of the technical specifications, however, means that full and thorough testing is impractical for both technical and economic reasons.

Furthermore, there is no guarantee that a test sample which has passed all the relevant tests conforms to a specification.

The existence of the tests nevertheless provides the confidence that the test sample possesses the qualities as maintained and that its performance generally conforms to representative cases of communications equipment.

The test results of this test report relate exclusively to the item tested as specified in 1.5.

The test report may only be reproduced or published in full.

Reproduction or publication of extracts from the report requires the prior written approval of the ELECTRONIC TECHNOLOGY SYSTEMS DR. GENZ GMBH.

I attest to the accuracy of data. All measurements reported herein were performed by me or were made under my supervision and are correct to the best of my knowledge and belief. I assume full responsibility for the completeness of these measurements and vouch for the qualification of all persons taking them.

### Tester:

29.04.2003 N. Kaspar

---

Date	ETS-Lab.	Name	Signature
------	----------	------	-----------

### Technical responsibility for area of testing:

29.04.2003 Dr. Genz

---

Date	ETS	Name	Signature
------	-----	------	-----------

## 1.2 Testing laboratory

### 1.2.1 Location

ELECTRONIC TECHNOLOGY SYSTEM DR. GENZ GMBH (ETS)  
Storkower Straße 38c  
D-15526 Reichenwalde b. Berlin  
Germany  
Telephone : +49 33631 888 00  
Fax : +49 33631 888 660

### 1.2.2 Details of accreditation status

#### ACCREDITED TESTING LABORATORY

DAR-REGISTRATION NUMBER: TTI-P-G 126/96-30

FCC FILED TEST LABORATORY REG. No. 96970

#### BLUETOOTH QUALIFICATION TEST FACILITY (BQTF)

ACCREDITED BY BLUETOOTH QUALIFICATION REVIEW BOARD

INDUSTRY CANADA FILED TEST LABORATORY REG. No. IC 3470

A2LA ACCREDITED Certificate Number 1983-01

## 1.3 Details of approval holder

Name : Compal Communications Inc.  
Street : 7F, 319, Sec. 4, Pa-Teh Road  
Town : Taipei (105)  
Country : Taiwan, R.O.C.  
Telephone : +886-2-2528-8198  
Fax : +886-2-2748-7547  
Contact : Ms. Cinthy Kuo  
Telephone : +886-2-2528-8198

## 1.4 Manufacturer: (if applicable)

Name :  
Street :  
Town :  
Country :

## 1.5 Application details

Date of receipt of application : 10.02.2003  
 Date of receipt of test item : 10.02.2003  
 Date of test : 06.03.2003 - 25.05.2003

## 1.6 Test item

FCC ID : QQXEB-G60U  
 Description of test item : GPRS Dual-Band (GSM850/PCS1900) Handset Phase II+  
 Type identification : EB-G60U  
 Serial number : without; Identical Prototype  
 Device category : PCE (Licensed Portable Transmitter Held to Ear)

### Technical data

	<b>GSM850</b>	<b>PCS</b>
TX Frequency range	: 824,2 - 848,8 MHz	1850,2 - 1909,8 MHz
RX Frequency range	: 869,2 - 893,8 MHz	1930,2 - 1989,8 MHz
Max. Conducted RF output power	: 31,7 dBm	31,2 dBm
Power supply	: 3,7 V DC rechargeable battery	
Antenna Tx	: integral	
Antenna RX	: integral	
Additional information	: Tx and Rx. antenna are the same.	

## 1.7 Test Results

Max. SAR Measurement : 0.522 W/kg (averaged over 1 gram)

This EUT has been shown to be capable of compliance for localized specific absorption rate (SAR) for uncontrolled environment/general population exposure limits specified in ANSI/IEEE Std. C95.1-1992 and had been tested in accordance with the measurement procedures specified in FCC/OET Bulletin 65 Supplement C (2001) and IEEE Std. 1528-200X (Draft 6.5, January 2002).

## 1.8 Test standards

Standards	:	- ANSI/IEEE Std C95.1-1992 - IEEE Std. 1528-200X (Draft 6.5, January 2002)
FCC Rule Part(s)	:	- § 2.1093 - FCC OET Bulletin 65, Supplement C, Edition 01-01

## 2 Technical test

### 2.1 Summary of test results

EUT complies with the RF radiation exposure limits of the FCC as shown by the SAR measurement results. These measurements are taken to simulate the RF effects exposure under worst-case conditions. The EUT complies with the requirements in respect to all parameters subject to the test. The test results and statements relate only to the item(s) tested.

Please note that the absorption and distribution of electromagnetic energy in the body are very complex phenomena that depend on the mass, shape, and size of the body, the orientation of the body with respect to the field vectors, and the electrical properties of both the body and the environment. Other variables that may play a substantial role in possible biological effects are those that characterize the environment (e.g. ambient temperature, air velocity, relative humidity, and body insulation) and those that characterize the individual (e.g. age, gender, activity level, debilitation, or disease). Because innumerable factors may interact to determine the specific biological outcome of an exposure to electromagnetic fields, any protection guide shall consider maximal amplification of biological effects as a result of field-body interactions, environmental conditions, and physiological variables. [1]

### 2.2 Test environment

Room temperature	:	22,1 -22,6° C
Liquid temperature	:	22,0 -22,3° C
Relative humidity content	:	20 ... 75 %
Air pressure	:	86 ... 103 k P a
Details of power supply	:	3,7 V DC

### 2.3 Test equipment utilized

No.	Measurement device:	Type:	Manufacturer:
ETS 0449	Stäubli Robot	RX90B L	Stäubli
ETS 0450	Stäubli Robot Controller	CS/MBs&p	Stäubli
ETS 0451	DASY 4 Measurement Server		Schmidt & Partner
ETS 0452	Control Pendant		Stäubli
ETS 0453	Compaq Computer	Pentium IV, 2 GHz,	Schmidt & Partner
ETS 0454	Dabu Acquisition Electronics	DAE3V1	Schmidt & Partner
ETS 0455	Dummy Probe		Schmidt & Partner
ETS 0456	Dosimetric E-Field Probe	ET3DV6	Schmidt & Partner
ETS 0457	Dosimetric E-Field Probe	ET3DV6	Schmidt & Partner
ETS 0458	Dosimetric H-Field Probe	H3DV6	Schmidt & Partner
ETS 0459	System Validation Kit	D900V2	Schmidt & Partner
ETS 0460	System Validation Kit	D1800V2	Schmidt & Partner
ETS 0461	System Validation Kit	D1900V2	Schmidt & Partner
ETS 0462	System Validation Kit	D2450V2	Schmidt & Partner
ETS 0463	Probe Alignment Unit	LBV2	Schmidt & Partner
ETS 0464	SAM Twin phantom	V 4.0	Schmidt & Partner
ETS 0465	Mounting Device	V 3.1	Schmidt & Partner
ETS 0224a	Millivoltmeter	URV 5	Rohde & Schwarz
ETS 0219	Power sensor	NRV-Z2	Rohde & Schwarz
ETS 0268	RF signal generator	SMP 02	Rohde & Schwarz
ETS 0322	Insertion unit	URV5-Z4	Rohde & Schwarz
ETS 0466	Directional Coupler	HP 87300B	HP
ETS0231	Radio Communication Tester	CMD65	Rohde & Schwarz
ETS 0467	Universal Radio Communication Tester	CMU 200	Rohde & Schwarz
ETS 0468	Network Analyzer 300 kHz to 3 GHz	8753C	Agilent
ETS 0469	Dielectric Probe Kit	85070C	Agilent

## 2.4 Definitions

### 2.4.1 SAR

The specific absorption rate (SAR) is defined as the time derivative of the incremental energy ( $dW$ ) absorbed by (dissipated in) an incremental mass ( $dm$ ) contained in a volume element ( $dV$ ) of a given density ( $\rho_t$ ), expressed in watts per kilogram (W/kg)

$$\text{SAR} = \frac{d}{dt} \left( \frac{dW}{dm} \right) = \frac{d}{dt} \left( \frac{dW}{\rho_t dV} \right) = \frac{\sigma}{\rho_t} |E_t|^2$$

where:

$$\frac{dW}{dt} = \int_v E \cdot J dV = \int_v \sigma E^2 dV$$

### 2.4.2 Uncontrolled Exposure

The general population/uncontrolled exposure limits are applicable to situations in which the general public may be exposed or in which persons who are exposed as a consequence of their employment may not be made fully aware of the potential for exposure or cannot exercise control over their exposure. Members of the general public would come under this category when exposure is not employment-related; for example, in the case of a wireless transmitter that exposes persons in its vicinity. Warning labels placed on low-power consumer devices such as cellular telephones are not considered sufficient to allow the device to be considered under the occupational/controlled category, and the general population/uncontrolled exposure limits apply to these devices. [2]

### 2.4.2 Controlled Exposure

In general, occupational/controlled exposure limits are applicable to situations in which persons are exposed as a consequence of their employment, who have been made fully aware of the potential for exposure and can exercise control over their exposure. This exposure category is also applicable when the exposure is of a transient nature due to incidental passage through a location where the exposure levels may be higher than the general population/uncontrolled limits, but the exposed person is fully aware of the potential for exposure and can exercise control over his or her exposure by leaving the area or by some other appropriate means. Awareness of the potential for RF exposure in a workplace or similar environment can be provided through specific training as part of a RF safety program. If appropriate, warning signs and labels can also be used to establish such awareness by providing prominent information on the risk of potential exposure and instructions on the risk of potential exposure and instructions on methods to minimize such exposure risks. [2]



## 2.5 Measurement System Description

### 2.5.1 System Setup

Measurements are performed using the DASY4 automated dosimetric assessment system (figure 1) made by Schmidt & Partner Engineering AG (SPEAG) in Zurich, Switzerland.



Figure 1

The DASY4 system for performing compliance tests consists of the following items:

- A standard high precision 6-axis robot (Stäubli RX family) with controller, teach pendant and software. An arm extension for accommodating the data acquisition electronics (DAE).
- A dosimetric probe, i.e., an isotropic E-field probe optimized and calibrated for usage in tissue simulating liquid. The probe is equipped with an optical surface detector system.
- A data acquisition electronics (DAE) which performs the signal amplification, signal multiplexing, AD-conversion, offset measurements, mechanical surface detection, collision detection, etc. The unit is battery powered with standard or rechargeable batteries. The signal is optically transmitted to the EOC.
- An unit to operate the optical surface detector which is connected to the EOC.
- The Electro-optical converter (EOC) performs the conversion from the optical into a digital electric signal of the DAE. The EOC is connected to the measurement server.
- The functions of the measurement server is to perform the time critical task such as signal filtering, surveillance of the robot operation, fast movement interrupts.
- A probe alignment unit which improves the (absolute) accuracy of the probe positioning.
- A computer operating Windows 2000 or Windows NT.
- DASY4 software.
- Remote control with teach pendant and additional circuitry for robot safety such as warning lamps, etc.
- The SAM twin phantom enabling testing left-hand and right-hand usage.
- The device holder for handheld mobile phones.
- Tissue simulating liquid mixed according to the given recipes (see Application Notes).
- System validation dipoles allowing to validate the proper functioning of the system.

## 2.5.2 Phantom Description



Figure 2

The SAM twin phantom V4.0 (figure 2) is a fiberglass shell phantom with 2 mm shell thickness. It has three measurement areas:

- Left hand
- Right hand
- Flat phantom

The phantom is integrated in a wooden table.

The bottom plate of the table contains three pair of bolts for locking the device holder. The device holder positions are adjusted to the standard measurement positions in the three sections. Only one device holder is necessary if two phantoms are used (e.g., for different liquids).

A cover is provided to tap the phantom during off-periods to prevent water evaporation and changes in the liquid parameters. Free space scans of devices on the cover are possible.

On the phantom top, three reference markers are provided to identify the phantom positions with respect to the robot.

## 2.5.3 Tissue Simulating Liquids

The parameters of the tissue simulating liquid strongly influence the SAR. The parameters for the different frequencies are defined in the corresponding compliance standards (e.g., EN 50361, IEEE P1528-200X).

Tissue dielectric properties

Frequency (MHz)	Head		Body	
	Relative Dielectric Constant ( $\epsilon_r$ )	Conductivity ( $\sigma$ ) (S/m)	Relative Dielectric Constant ( $\epsilon_r$ )	Conductivity ( $\sigma$ ) (S/m)
300	45.3	0.87	58.2	0.92
450	43.5	0.87	56.7	0.94
835	41.5	0.90	55.2	0.97
900	41.5	0.97	55.0	1.05
1450	40.5	1.20	54.0	1.30
1800	40.0	1.40	53.3	1.52
1900	40.0	1.40	53.3	1.52
2000	40.0	1.40	53.3	1.52
2450	39.2	1.80	52.7	1.95
3000	38.5	2.40	52.0	2.73

## 2.5.4 Device Holder

The DASY device holder (figure 3.1 and 3.2) is designed to cope with different positions given in the standard. It has two scales for the device rotation (with respect to the body axis) and the device inclination (with respect to the line between the ear openings). The rotation centers for both scales is the ear opening. Thus the device needs no repositioning when changing the angles.



Figure 3.1



Figure 3.2

The DASY device holder has been made out of low-loss POM material having the following dielectric parameters: relative permittivity  $\epsilon = 3$  and loss tangent  $\delta = 0.02$ . The amount of dielectric material has been reduced in the closest vicinity of the device, since measurements have suggested that the influence of the clamp on the test results could thus be lowered.

## 2.5.5 Probes

The SAR measurements were conducted with the dosimetric probe ET3DV6 (figure 4), designed in the classical triangular configuration and optimized for dosimetric evaluation. [3] The probe is constructed using the thick film technique; with printed resistive lines on ceramic substrates. The probe is equipped with an optical multifiber line ending at the front of the probe tip. It is connected to the EOC box on the robot arm and provides an automatic detection of the phantom surface. Half of the fibers are connected to a pulsed infrared transmitter, the other half to a synchronized receiver. As the probe approaches the surface, the reflection from the surface produces a coupling from the transmitting to the receiving fibers. This reflection increases first during the approach, reaches maximum and then decreases. If the probe is flatly touching the surface, the coupling is zero. The distance of the coupling maximum to the surface is independent of the surface reflectivity and largely independent of the surface to probe angle. The DASY4 software reads the reflection during a software approach and looks for the maximum using a 2<sup>nd</sup> order fitting. The approach is stopped at reaching the maximum.

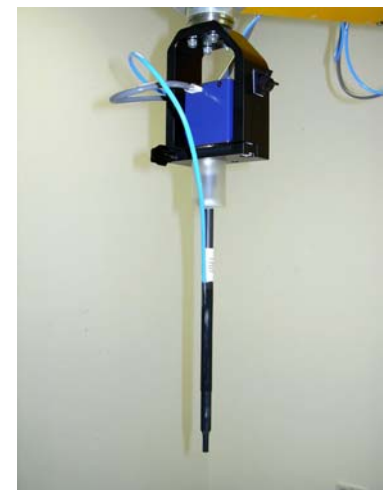

Figure 4

## Probe Specifications

Calibration:	In air from 10 MHz to 2.5 GHz In brain and muscle simulating tissue at Frequencies of 835 MHz, 900 MHz, 1800 MHz, 1900 MHz and 2450 MHz Calibration certificates please find attached.
Frequency:	10 MHz to > 3 GHz; Linearity: $\pm 0.2$ dB (30 MHz to 3 GHz)
Directivity:	$\pm 0.2$ dB in HSL (rotation around probe axis) $\pm 0.4$ dB in HSL (rotation normal probe axis)
Dynamic Range:	5 $\mu$ W/g to > 100 mW/g;
Linearity:	$\pm 0.2$ dB
Dimensions:	Overall length: 330 mm Tip length: 16 mm Body diameter: 12 mm Tip diameter: 6.8 mm Distance from probe tip to dipole centers: 2.7 mm
Application:	General dosimetry up to 3 GHz Compliance tests of mobile phones Fast automatic scanning in arbitrary phantoms

## 2.6 Test System Specification

### Positioner

Robot:	Stäubli Animation Corp. Robot Model: RX90B L
Repeatability:	0.02 mm
No. of axis:	6

### Data Acquisition Electronic (DAE) System

#### Cell Controller

Processor:	Pentium IV
Clock Speed:	2.0 GHz
Operating System:	Windows 2000
Data Card:	DASY4 PC-Board
Data Converter	
Features:	Signal Amplifier, multiplexer, A/D converter, & control logic
Software:	DASY4 software
Connecting Lines:	Optical downlink for data and status info. Optical uplink for commands and clock

### PC Interface Card

Function:	24 bit (64 MHz) DSP for real time processing Link to DAE3 16 bit A/D converter for surface detection system serial link to robot direct emergency stop output for robot
-----------	---

**E-Field Probes**

Model:	ET3DV6 SN1711
Construction:	Triangular core fiber optic detection system
Frequency:	10 MHz to 6 GHz
Linearity:	$\pm 0.2$ dB (30MHz to 3 GHz)

**Phantom**

Phantom:	SAM Twin Phantom (V4.0)
Shell Material:	Fiberglass
Thickness:	$2.0 \pm 0.2$ mm

**2.7 Measurement Procedure**

The evaluation was performed using the following procedure:

1. The SAR measurement was taken at a selected spatial reference point to monitor power variations during testing. This fixed location point was measured and used as a reference value.
2. The SAR distribution at the exposed side of the head was measured at a distance of 3.9mm from the inner surface of the shell. The area covered the entire dimension of the head and the horizontal grid spacing was 10mm x 10mm.
3. Based on the area scan data, the area of the maximum absorption was determined by spline interpolation. Around this point, a volume of 30mm x 30mm x 30mm (fine resolution volume scan, zoom scan) was assessed by measuring 5 x 5 x 5 points. On this basis of this data set, the spatial peak SAR value was evaluated with the following procedure:
  - a. The data at the surface was extrapolated, since the center of the dipoles is 2.7mm away from the tip of the probe and the distance between the surface and the lowest measuring point is 1.2mm. The extrapolation was based on a least square algorithm [4]. A polynomial of the fourth order was calculated through the points in z-axes. This polynomial was then used to evaluate the points between the surface and the probe tip.
  - b. The maximum interpolated value was searched with a straight-forward algorithm. Around this maximum the SAR values averaged over the spatial volumes (1g or 10g) were computed using the 3D-Spline interpolation algorithm. The 3D-spline is composed of three one-dimensional splines with the "Not a knot" condition (in x, y, and z directions) [4] [5]. The volume was integrated with the trapezoidal algorithm. One thousand points (10 x 10 x 10) were interpolated to calculate the average.
  - c. All neighboring volumes were evaluated until no neighboring volume with a higher average value was found.
4. The SAR reference value, at the same location as procedure #1, was remeasured. If the value changed by more than 5%, the evaluation is repeated.

## 2.8 Reference Points

### 2.8.1 Ear Reference Points

Figure 5.1 shows the front, back and side views of SAM. The point "M" is the reference point for the center of mouth, "LE" is the left ear reference point (ERP), and "RE" is the right ERP. The ERPs are 15 mm posterior to the entrance to ear canal (EEC) along the B-M line (Back-Mouth), as shown in Figure 5.2. The plane passing through the two ear reference points and M is defined as the Reference Plane. The line N-F (Neck-Front) perpendicular to the reference plane and passing through the RE (or LE) is called the Reference Pivoting Line (see Figure 5.3). Line B-M is perpendicular to the N-F line. Both N-F and B-M lines should be marked on the external phantom shell to facilitate handset positioning. Posterior to the N-F line, the thickness of the N-F line, the ear is truncated as illustrated in Figure 5.2. The ear truncation is introduced to avoid the handset from touching the ear lobe, which can cause unstable handset positioning at the cheek. [6]

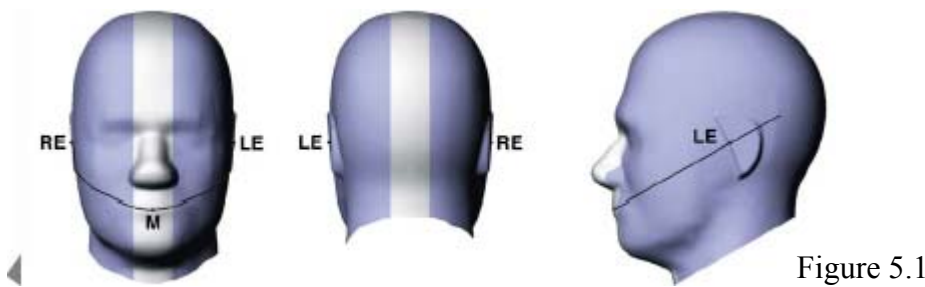

Figure 5.1

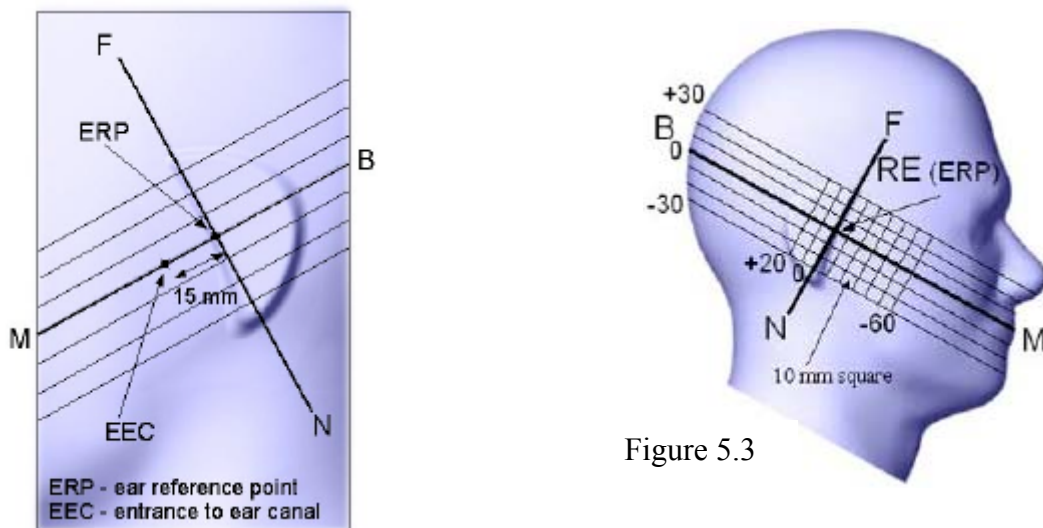

Figure 5.3

Figure 5.2

## 2.8.2 Handset Reference Points

Two imaginary lines on the handset were defined: the vertical centerline and the horizontal line. The vertical centerline passes through two points on the front side of the handset: the midpoint of the width  $w_t$  of the handset at the level of the acoustic output (point A on Figures 6.1 and 6.2), and the midpoint of the width  $w_b$  of the bottom of the handset (point B). The horizontal line is perpendicular to the vertical centerline and passes through the center of the acoustic output (see Figure 6.1). The two lines intersect at point A. For many handsets, point A coincides with the center of the acoustic output. However, the acoustic output may be located elsewhere on the horizontal line. The vertical centerline is not necessarily parallel to the front face of the handset (see Figure 6.2), especially for clamshell handsets, handsets with flip pieces, and other irregularly-shaped handsets. [6]

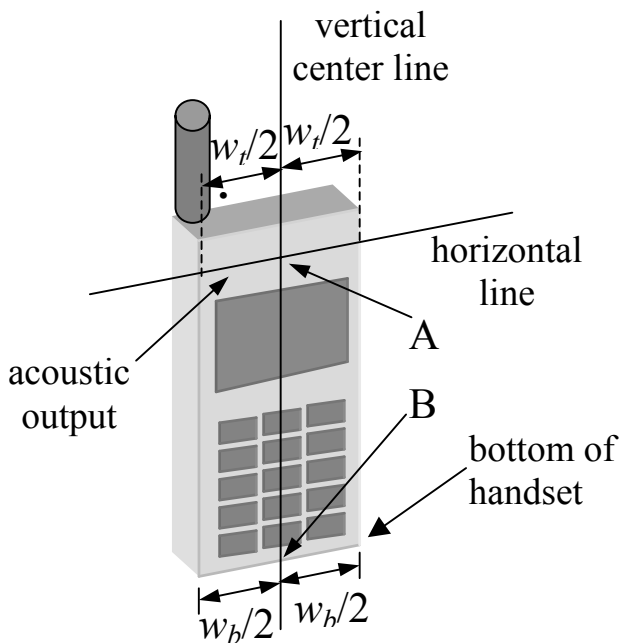

Figure 6.1

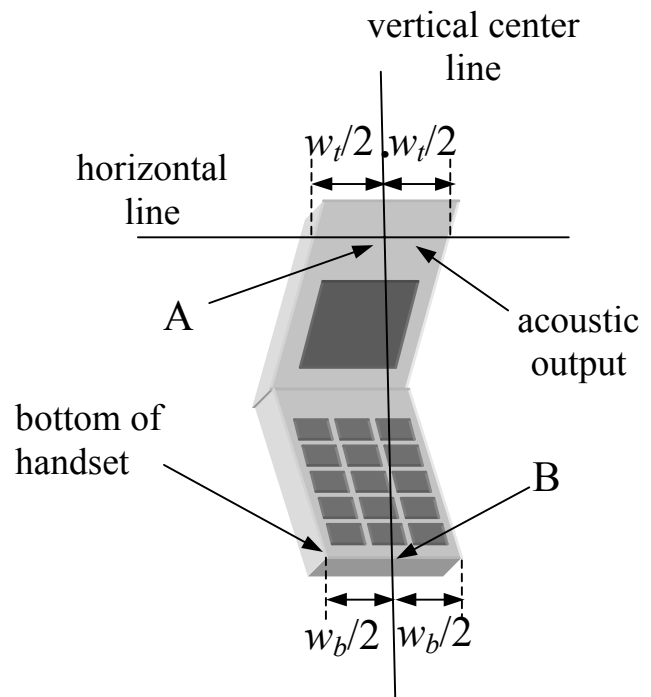

Figure 6.2

## 2.9 Test Positions

### 2.9.1 "Cheek" / "Touch" Position

The EUT was positioned close to the surface of the phantom such that point A is on the (virtual) extension of the line passing through points RE and LE on the phantom (see Figure 7), such that the plane defined by the vertical center line and the horizontal line of the handset is approximately parallel to the sagittal plane of the phantom.

The EUT was translated towards the phantom along the line passing through RE and LE until the handset touches the pinna.

While maintaining the handset in this plane, the EUT was rotated it around the LE-RE line until the vertical centerline was in the plane normal to MB-NF including the line MB (called the reference plane).

The EUT was rotated around the vertical centerline until the handset (horizontal line) was symmetrical with respect to the line NF.

While maintaining the vertical centerline in the reference plane, keeping point A on the line passing through RE and LE and maintaining the handset contact with the pinna, the EUT was rotated about the line NF until any point on the handset was in contact with a phantom point below the pinna (cheek). [6] See Figure 7.

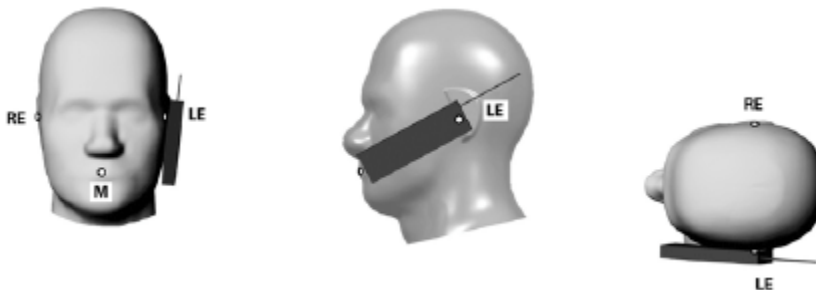

Figure 7



## 2.9.2 "Tilted" Position

The EUT was in "cheek position".

While maintaining the orientation of the handset move the handset away from the pinna along the line passing through RE and LE in order to enable a rotation of the handset by 15 degrees.

The EUT was rotated around the horizontal line by 15 degrees.

While maintaining the orientation of the handset, the EUT was moved towards the phantom on a line passing through RE and LE until any part of the handset touched the ear. The tilted position is obtained when the contact is on the pinna. If the contact was at any location other than the pinna (e.g., the antenna with the back of the phantom head), the angle of the handset would be reduced. In this case, the tilted position is obtained if any part of the handset was in contact with the pinna as well as a second part of the handset was in contact with the phantom (e.g., the antenna with the back of the head). [6] See Figure 8.

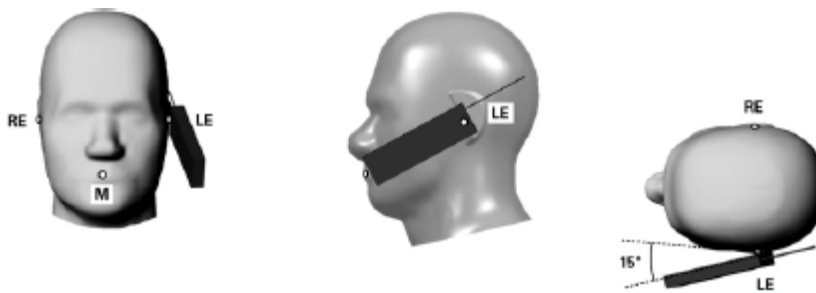

Figure 8

### 2.9.3 Belt Clip/Holster Configuration

Test configurations for body-worn operated EUTs are carried out while the belt-clip and/or holster is attached to the EUT and placed against a flat phantom in a regular configuration. An EUT with a headset output is tested with a headset connected to the device.

Body dielectric parameters are used.

There are two categories for accessories for body-worn operation configurations:

1. accessories not containing metallic components
2. accessories containing metallic components.

When the EUT is equipped with accessories not containing metallic components the tests are done with the accessory that dictates the closest spacing to the body. For accessories containing metallic parts a test with each one is implemented. If the multiple accessories share an identical metallic component (e.g. the same metallic belt-clip used with different holsters with no other metallic components) only the accessory that has the closest spacing to the body is tested.

In case that a EUT authorized to be body-worn is not supplied or has no options to be operated with any accessories, a test configuration where a separation distance between the back of the device and the flat phantom is used. All test position spacings are documented.

Transmitters operating in front of a person's face (e.g. push-to-talk configurations) are tested for SAR compliance with the front of the device positioned to face the flat platform. SAR Compliance tests for shoulder, waist or chest-worn transmitters are carried out with the accessories including headsets and microphones attached to the device and placed against a flat phantom in a regular configuration.

The SAR measurements are performed to investigate the worst-case positioning. This is documented and used to perform Body SAR testing. [2]

## 2.10 Measurement uncertainty

The uncertainty budget has been determined for the DASY4 system performance check according to IEEE Str. 1528-200X, (draft), April 2002.

Error Description	Tol. (± %)	Prob. dist.	Div.	$(^c i)^1$ (1g)	Std. unc. (1g) (± %)	$(^v i)^2$
<b>Measurement System</b>						
Probe Calibration	4.4	N	1	1	4.4	$\infty$
Axial Isotropy	4.7	R	$\sqrt{3}$	1	2.7	$\infty$
Hemispherical Isotropy	0	R	$\sqrt{3}$	1	0	$\infty$
Boundary Effects	8.3	R	$\sqrt{3}$	1	4.8	$\infty$
Linearity	4.7	R	$\sqrt{3}$	1	2.7	$\infty$
System Detection Limit	1.0	R	$\sqrt{3}$	1	0.6	$\infty$
Readout Electronics	1.0	N	1	1	1.0	$\infty$
Response Time	0	R	$\sqrt{3}$	1	0	$\infty$
Integration Time	0	R	$\sqrt{3}$	1	0	$\infty$
RF Ambient Conditions	3.0	R	$\sqrt{3}$	1	1.7	$\infty$
Probe Positioner	0.4	R	$\sqrt{3}$	1	0.2	$\infty$
Probe Positioning	2.9	R	$\sqrt{3}$	1	1.7	$\infty$
Algorithms for Max. SAR Eval.	3.9	R	$\sqrt{3}$	1	2.3	$\infty$
<b>Dipole</b>						
Dipole Axis to Liquid Distance	1.0	R	$\sqrt{3}$	1	0.6	$\infty$
Power Drift	4.7	R	$\sqrt{3}$	1	2.7	$\infty$
<b>Phantom and Tissue Param.</b>						
Phantom Uncertainty	4.0	R	$\sqrt{3}$	1	2.3	$\infty$
Liquid Conductivity (target)	5.0	R.	$\sqrt{3}$	0.6	1.7	$\infty$
Liquid Conductivity (meas.)	10.0	R	$\sqrt{3}$	0.6	3.5	$\infty$
Liquid Permittivity (target)	5.0	R	$\sqrt{3}$	0.6	1.7	$\infty$
Liquid Permittivity (meas.)	5.0	R	$\sqrt{3}$	0.6	1.7	$\infty$
<b>Combined Standard Uncertainty</b>					<b>10.2</b>	$\infty$
<b>Expanded Uncertainty kp=2</b>						
<b>Coverage Factor for 95%</b>					<b>20.3</b>	

### 3. Tissue and System Verification

#### 3.1 Tissue Verification

Dielectric parameters of the simulating liquids were verified using a Dielectric Probe Kit Agilent 85070D to a tolerance of  $\pm 5\%$ . It was used 900 MHz muscle tissue which has nearly the same values as 835 MHz muscle tissue.

Room Temperature: 22,1 -22,6 °C

	Measured Tissue Parameters			
	900 MHz Brain		1900 MHz Brain	
	Target	Measured	Target	Measured
Date		06.03.2003		25.04.2003
Liquid Temperature: °C		22,1		22,1
Dielectric Constant: $\epsilon$	41,5	41,86	40,0	40,2
Conductivity: $\sigma$	0,97	0,98	1,40	1,37

#### 3.2 System Verification

Prior to the assessment, the system was verified by using a 900 MHz /1900 MHz validation dipole. Power level of 20dBm / 17,0 dBm was supplied to the dipole antenna placed under the flat section of SAM Phantom. This system validation is valid for a frequency range of  $900 \pm 100$  MHz.

The system was verified to a tolerance of  $\pm 10\%$ .

Liquid Temperature: 22,0 -22,3 °C  
 Room Temperature: 22,1 -22,6 °C  
 Liquid Depth: >15.5 cm

System Dipole Validation Target & Measurement					
Date	System Validation Kit:	Liquid	Targeted SAR 1g (mW/g)	Measured SAR 1g (mW/g)	Deviation (%)
06.03.2003	D900V2 SN164	900 MHz Head	10,2	10,8	5,88
07.03.2003	D1900V2 SN5d025	1900 MHz Head	40,4	43,49	7,64

Comment: Please find attached the measurement plot.

## 4. Test Results

### Procedures Used To Establish Test Signal

The EUT was placed into simulated call mode (e.g. AMPS, Cellular CDMA & PCS CDMA modes) using manufacturers test codes. Such test signals offer a consistent means for testing SAR and are recommended for evaluating SAR [2]. The actual transmission is activated through a base station simulator or similar when test modes are not available or inappropriate for testing the EUT.

The EUT is rechargeable battery operated. The battery used for the SAR measurements was completely charged. The device was tested at full power verified by implementing conducted output power measurements. For confirming of the output power it was tested before and after each SAR measurement. The test was repeated if a conducted power deviation of more than 5 % occurred.

**Mixture Type:** 900 MHz Head

**Date:** 06.03.2002

**Liquid Temperature:** 22,0 -22,3 ° C

**Room Temperature:** 22,1 -22,6 ° C

Frequency			Power Drift dBm	Antenna Pos.	Phantom Section	Test Position	SAR (W/kg)
MHz	Channel	Modulat.					
824,2	128	GSM	-0,03	Integral ant1	Right Ear	Cheek	0,472
824,2	128	GSM	-0,04	Integral ant1	Right Ear	Tilt	0,227
836,4	189	GSM	-0,006	Integral ant1	Right Ear	Cheek	0,464
836,4	189	GSM	-0,03	Integral ant1	Right Ear	Tilt	0,212
848,8	251	GSM	-0,08	Integral ant1	Right Ear	Cheek	<b>0,561</b>
848,8	251	GSM	0,02	Integral ant1	Right Ear	Tilt	0,292
824,2	128	GSM	-0,01	Integral ant1	Left Ear	Cheek	0,399
824,2	128	GSM	-0,007	Integral ant1	Left Ear	Tilt	0,135
836,4	189	GSM	0,01	Integral ant1	Left Ear	Cheek	0,265
836,4	189	GSM	0,07	Integral ant1	Left Ear	Tilt	0,126
848,8	251	GSM	-0,004	Integral ant1	Left Ear	Cheek	0,324
848,8	251	GSM	0,03	Integral ant1	Left Ear	Tilt	0,148

### Limits:

Exposure Limits	SAR (W/kg)	
	Uncontrolled Exposure/General Population Environment	Controlled Exposure/Occupational Environment
Spatial Average SAR (averaged over the whole body)	0.08	0.40
Spatial Peak SAR (averaged over any 1g of tissue)	1.60	8.00
Spatial Peak SAR (Hands, Feet, Ankles, Wrist) (averaged over any 10g of tissue)	4.00	20.00

### Notes:

1. Test data represent the worst case SAR value and test procedure used are according to OET Bulletin 65, Supplement C (01-01).
2. All modes of operation were investigated.

Mixture Type: 1900 MHz Head

Date: 25.04.2002

Liquid Temperature: 22,0 -22,3 °C

Room Temperature: 22,1 -22,6 °C

Frequency			Power Drift dBm	Antenna Pos.	Phantom Section	Test Position	SAR (W/kg)
MHz	Channel	Modulat.					
1850,2	512	GSM	0,100	Integral ant1	Right Ear	Cheek	0,306
1850,2	512	GSM	-0,040	Integral ant1	Right Ear	Tilt	0,296
1880,0	661	GSM	-0,060	Integral ant1	Right Ear	Cheek	0,403
1880,0	661	GSM	-0,040	Integral ant1	Right Ear	Tilt	0,481
1909,8	810	GSM	0,010	Integral ant1	Right Ear	Cheek	0,343
1909,8	810	GSM	-0,030	Integral ant1	Right Ear	Tilt	0,471
1850,2	512	GSM	0,004	Integral ant1	Left Ear	Cheek	0,406
1850,2	512	GSM	-0,040	Integral ant1	Left Ear	Tilt	0,351
1880,0	661	GSM	-0,040	Integral ant1	Left Ear	Cheek	0,458
1880,0	661	GSM	-0,040	Integral ant1	Left Ear	Tilt	0,421
1909,8	810	GSM	0,020	Integral ant1	Left Ear	Cheek	0,519
1909,8	810	GSM	-0,003	Integral ant1	Left Ear	Tilt	<b>0,522</b>

Limits:

Exposure Limits	SAR (W/kg)	
	Uncontrolled Exposure/General Population Environment	Controlled Exposure/Occupational Environment
Spatial Average SAR (averaged over the whole body)	0.08	0.40
Spatial Peak SAR (averaged over any 1g of tissue)	1.60	8.00
Spatial Peak SAR (Hands, Feet, Ankles, Wrist) (averaged over any 10g of tissue)	4.00	20.00

Notes:

- Test data represent the worst case SAR value and test procedure used are according to OET Bulletin 65, Supplement C (01-01).
- All modes of operation were investigated.

## 5. References

- [1] ANSI/IEEE C95.3 – 1991, *IEEE Recommended Practice for the Measurement of Potentially Hazardous Electromagnetic fields, 300 kHz to 100 GHz*, New York: IEEE, Aug. 1992
- [2] Federal Communications Commission, OET Bulletin 65 (Edition 97-01), Supplement C (Edition 01-01), *Evaluating Compliance with FCC Guidelines for Human Exposure to Radiofrequency Electromagnetic Fields*, July 2001.
- [3] T. Schmid, O. Egger, N. Kuster, *Automated E-field scanning system for dosimetric assessments*, IEEE Transaction on Microwave Theory and Techniques, vol. 44, Jan. 1996, pp. 105-113.
- [4] W. Gander, *Computermathematics*, Birkhaeuser, Basel, 1992.
- [5] W.H. Press, S.A. Teukolsky, W.T. Vetterling, and B.P. Flannery, *Numerical Receptions in C, The Art of Scientific Computing*, Second edition, Cambridge University Press, 1992.
- [6] IEEE Standards Coordinating Committee 34 – IEEE Std. 1528-200X (Draft 6.1 – January 2002), *Draft Recommended Practice for Determining the Peak Spatial-Average Absorption Rate (SAR in the Human Body Due to Wireless Communications Devices: Experimental Techniques*.
- [7] DASY4 *Dosimetric Assessment System Manual*; Draft; September 6, 2002; Schmidt & Partner Engineering AG

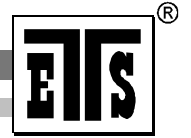

## 6. Appendix

1. Appendix A Calibration Certificate D900V2 SN164  
D1900V2 SN5d025  
ET3DV6 SN1711  
DAE3V1-522
2. Appendix B Measurement Plots
3. Appendix C Pictures





## Appendix A

### Calibration Certificate

# Schmid & Partner Engineering AG

Zeughausstrasse 43, 8004 Zurich, Switzerland, Phone +41 1 245 97 00, Fax +41 1 245 97 79

## Calibration Certificate

### 900 MHz System Validation Dipole

Type:

**D900V2**

Serial Number:

**164**

Place of Calibration:

**Zurich**

Date of Calibration:

**September 5, 2002**

Calibration Interval:

**24 months**

Schmid & Partner Engineering AG hereby certifies, that this device has been calibrated on the date indicated above. The calibration was performed in accordance with specifications and procedures of Schmid & Partner Engineering AG.

Wherever applicable, the standards used in the calibration process are traceable to international standards. In all other cases the standards of the Laboratory for EMF and Microwave Electronics at the Swiss Federal Institute of Technology (ETH) in Zurich, Switzerland have been applied.

Calibrated by:

**N. Vetter**

Approved by:

**Alain Kaya**

**Schmid & Partner  
Engineering AG**

---

Zeughausstrasse 43, 8004 Zurich, Switzerland, Phone +41 1 245 97 00, Fax +41 1 245 97 79

---

**DASY**

**Dipole Validation Kit**

**Type: D900V2**

**Serial: 164**

**Manufactured: April 30, 2002**

**Calibrated: September 5, 2002**

## 1. Measurement Conditions

The measurements were performed in the flat section of the new SAM twin phantom filled with head simulating solution of the following electrical parameters at 900 MHz:

Relative Dielectricity	<b>40.6</b>	$\pm 5\%$
Conductivity	<b>0.95 mho/m</b>	$\pm 5\%$

The DASY System with a dosimetric E-field probe ET3DV6 (SN:1507, Conversion factor 6.5 at 900 MHz) was used for the measurements.

The dipole was mounted on the small tripod so that the dipole feedpoint was positioned below the center marking of the flat phantom section and the dipole was oriented parallel to the body axis (the long side of the phantom). The standard measuring distance was 15mm from dipole center to the solution surface. The included distance holder was used during measurements for accurate distance positioning.

The coarse grid with a grid spacing of 20mm was aligned with the dipole. The 5x5x7 fine cube was chosen for cube integration. Probe isotropy errors were cancelled by measuring the SAR with normal and 90° turned probe orientations and averaging.

The dipole input power (forward power) was 250mW  $\pm 3\%$ . The results are normalized to 1W input power.

## 2 SAR Measurement with DASY4 System

Standard SAR-measurements were performed according to the measurement conditions described in section 1. The results (see figure supplied) have been normalized to a dipole input power of 1W (forward power). The resulting averaged SAR-values measured with the dosimetric probe ET3DV6 SN:1507 and applying the advanced extrapolation are:

averaged over 1 cm <sup>3</sup> (1 g) of tissue:	<b>10.2 mW/g</b>
averaged over 10 cm <sup>3</sup> (10 g) of tissue:	<b>6.56 mW/g</b>

### 3. Dipole Impedance and Return Loss

The impedance was measured at the SMA-connector with a network analyzer and numerically transformed to the dipole feedpoint. The transformation parameters from the SMA-connector to the dipole feedpoint are:

Electrical delay:           **1.408 ns**   (one direction)  
Transmission factor:       **0.990**       (voltage transmission, one direction)

The dipole was positioned at the flat phantom sections according to section 1 and the distance holder was in place during impedance measurements.

Feedpoint impedance at 900 MHz:            $\text{Re}\{Z\} = 50.7 \Omega$

$\text{Im}\{Z\} = -5.2 \Omega$

Return Loss at 900 MHz                      **-25.7 dB**

### 4. Handling

Do not apply excessive force to the dipole arms, because they might bend. Bending of the dipole arms stresses the soldered connections near the feedpoint leading to a damage of the dipole.

### 5. Design

The dipole is made of standard semirigid coaxial cable. The center conductor of the feeding line is directly connected to the second arm of the dipole. The antenna is therefore short-circuited for DC-signals.

### 6. Power Test

After long term use with 100W radiated power, only a slight warming of the dipole near the feedpoint can be measured.

## Validation Dipole D900V2 SN:164, d=15 mm

Frequency: 900 MHz; Antenna Input Power: 250 [mW]

SAM Phantom; Flat Section; Grid Spacing: Dx = 20.0, Dy = 20.0, Dz = 10.0

Probe: ET3DV6 - SN1507; ConvF(6.50,6.50,6.50) at 900 MHz; IEEE 1528 900 MHz:  $\sigma = 0.95$  mho/m  $\epsilon_r = 40.6$   $\rho = 1.00$  g/cm<sup>3</sup>

Cubes (2): Peak: 3.80 mW/g  $\pm 0.03$  dB, SAR (1g): 2.54 mW/g  $\pm 0.03$  dB, SAR (10g): 1.64 mW/g  $\pm 0.02$  dB, (Advanced extrapolation)

Penetration depth: 12.5 (12.3, 13.0) [mm]

Powerdrift: -0.01 dB

SAR<sub>tot</sub> [mW/g]

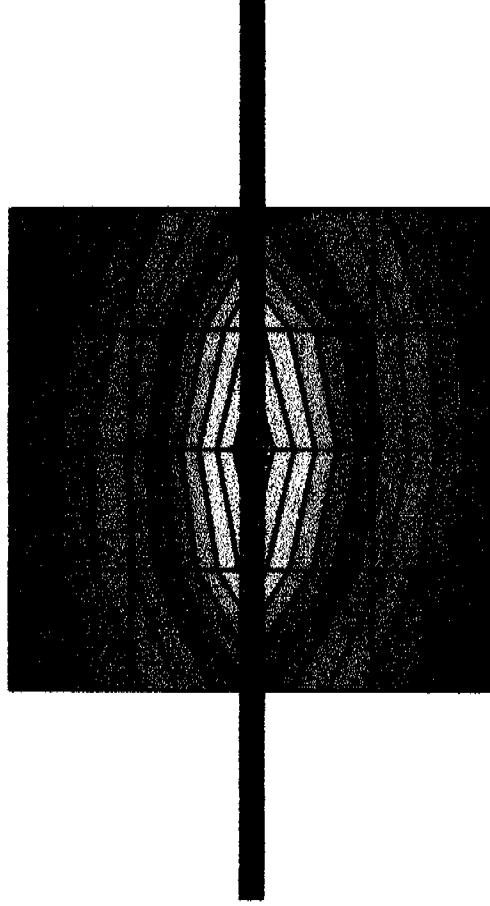
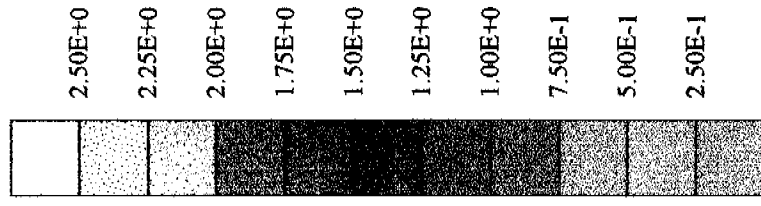

## Validation Dipole D900V2 SN:164, d=15 mm

Frequency: 900 MHz; Antenna Input Power: 250 [mW]

SAM Phantom; Flat Section; Grid Spacing: Dx = 20.0, Dy = 20.0, Dz = 10.0

Probe: ET3DV6 - SN1507; ConvF(6.50,6.50,6.50) at 900 MHz; IEEE 1528 900 MHz:  $\sigma = 0.95$  mho/m  $\epsilon_r = 40.6$   $\rho = 1.00$  g/cm<sup>3</sup>

Cubes (2): Peak: 4.29 mW/g  $\pm 0.03$  dB, SAR (1g): 2.71 mW/g  $\pm 0.03$  dB, SAR (10g): 1.72 mW/g  $\pm 0.02$  dB, (Worst-case extrapolation)

Penetration depth: 11.6 (10.7, 12.8) [mm]

Powerdrift: -0.01 dB

SAR<sub>Tot</sub> [mW/g]

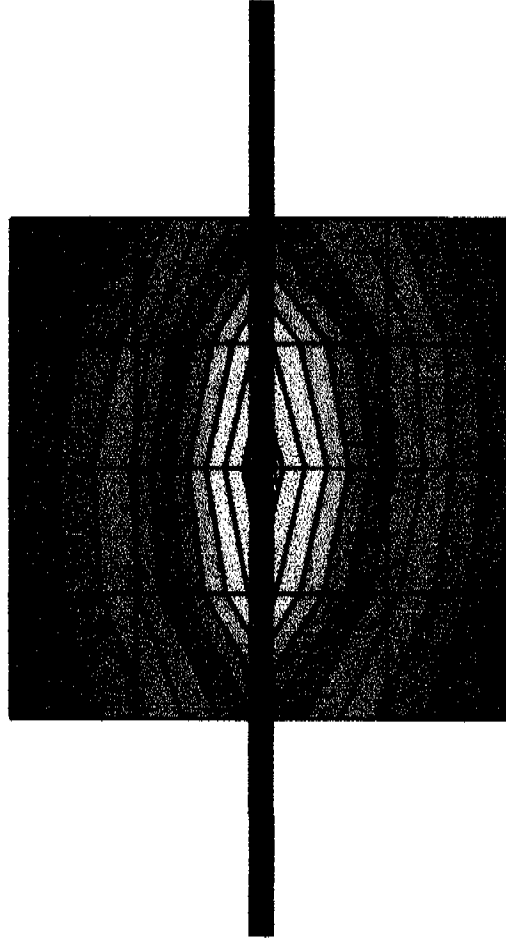
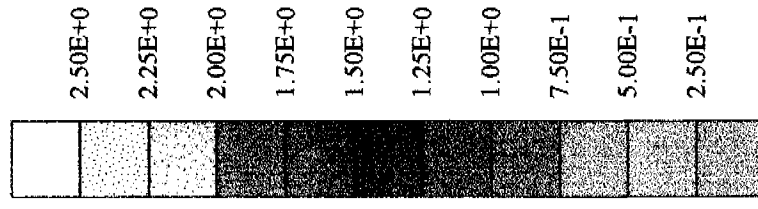

4 Sep 2002 10:05:41

CH1 S11 1 U FS 1: 50.693  $\Omega$  -5.2207  $\Omega$  33.873 pF 900.000 000 MHz

De1

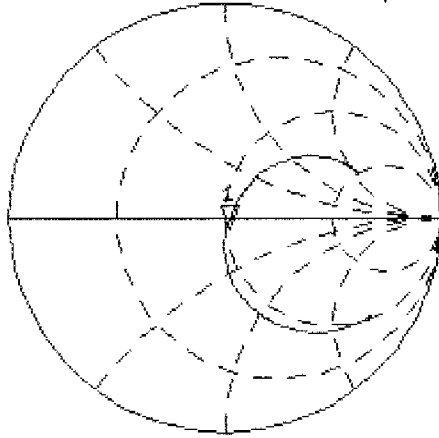

PRm

Cor  
Avg  
16

↑

CH2 S11 LOG 5 dB/REF 0 dB 1:-25.680 dB 900.000 000 MHz

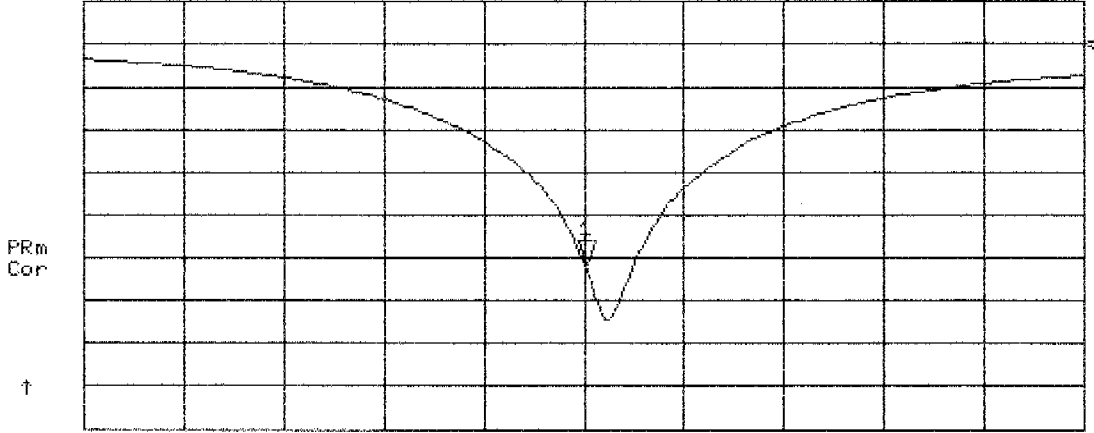

PRm  
Cor

↑

START 700.000 000 MHz

STOP 1100.000 000 MHz



# Schmid & Partner Engineering AG

Zeughausstrasse 43, 8004 Zurich, Switzerland, Phone +41 1 245 97 00, Fax +41 1 245 97 79

## Calibration Certificate

### 1900 MHz System Validation Dipole

Type:

D1900V2

Serial Number:

5d025

Place of Calibration:

Zurich

Date of Calibration:

October 14, 2002

Calibration Interval:

24 months

Schmid & Partner Engineering AG hereby certifies, that this device has been calibrated on the date indicated above. The calibration was performed in accordance with specifications and procedures of Schmid & Partner Engineering AG.

Wherever applicable, the standards used in the calibration process are traceable to international standards. In all other cases the standards of the Laboratory for EMF and Microwave Electronics at the Swiss Federal Institute of Technology (ETH) in Zurich, Switzerland have been applied.

Calibrated by:

D. Vella

Approved by:

Blair Kofe

# DASY

## Dipole Validation Kit

Type: D1900V2

Serial: 5d025

Manufactured: July 29, 2002

Calibrated: October 14, 2002

## 1. Measurement Conditions

The measurements were performed in the flat section of the new SAM twin phantom filled with head simulating glycol solution of the following electrical parameters at 1900 MHz:

Relative Dielectricity	<b>38.7</b>	$\pm 5\%$
Conductivity	<b>1.45 mho/m</b>	$\pm 5\%$

The DASY4 System with a dosimetric E-field probe ET3DV6 (SN:1507, Conversion factor 5.2 at 1900 MHz) was used for the measurements.

The dipole was mounted on the small tripod so that the dipole feedpoint was positioned below the center marking of the flat phantom section and the dipole was oriented parallel to the body axis (the long side of the phantom). The standard measuring distance was 10mm from dipole center to the solution surface. The included distance holder was used during measurements for accurate distance positioning.

The coarse grid with a grid spacing of 15mm was aligned with the dipole. The 7x7x7 fine cube was chosen for cube integration.

The dipole input power (forward power) was  $250\text{mW} \pm 3\%$ . The results are normalized to 1W input power.

## 2 SAR Measurement with DASY4 System

Standard SAR-measurements were performed according to the measurement conditions described in section 1. The results (see figure supplied) have been normalized to a dipole input power of 1W (forward power). The resulting averaged SAR-values measured with the dosimetric probe ET3DV6 SN:1507 and applying the advanced extrapolation are:

averaged over $1\text{ cm}^3$ (1 g) of tissue:	<b>40.4 mW/g</b>
averaged over $10\text{ cm}^3$ (10 g) of tissue:	<b>20.6 mW/g</b>

### 3. Dipole Impedance and Return Loss

The impedance was measured at the SMA-connector with a network analyzer and numerically transformed to the dipole feedpoint. The transformation parameters from the SMA-connector to the dipole feedpoint are:

Electrical delay:           **1.196 ns**   (one direction)  
Transmission factor:       **0.997**     (voltage transmission, one direction)

The dipole was positioned at the flat phantom sections according to section 1 and the distance holder was in place during impedance measurements.

Feedpoint impedance at 1900 MHz:            $\text{Re}\{Z\} = 51.6 \Omega$

$\text{Im}\{Z\} = 4.7 \Omega$

Return Loss at 1900 MHz                    **-26.3 dB**

### 4. Handling

Do not apply excessive force to the dipole arms, because they might bend. Bending of the dipole arms stresses the soldered connections near the feedpoint leading to a damage of the dipole.

### 5. Design

The dipole is made of standard semirigid coaxial cable. The center conductor of the feeding line is directly connected to the second arm of the dipole. The antenna is therefore short-circuited for DC-signals.

### 6. Power Test

After long term use with 40W radiated power, only a slight warming of the dipole near the feedpoint can be measured.

Test Laboratory: SPEAG, Zurich, Switzerland  
File Name: SN5d025\_SN1507\_HSL1900\_141002.da4

**DUT: Dipole 1900 MHz Type & Serial Number: D1900V2 - SN5d025**  
**Program: Dipole Calibration; Pin = 250 mW; d = 10 mm**

Communication System: CW-1900; Frequency: 1900 MHz; Duty Cycle: 1:1  
Medium: HSL 1900 MHz ( $\sigma = 1.45$  mho/m,  $\epsilon = 38.7$ ,  $\rho = 1000$  kg/m<sup>3</sup>)  
Phantom section: FlatSection

**DASY4 Configuration:**

- Probe: ET3DV6 - SN1507; ConvF(5.2, 5.2, 5.2); Calibrated: 1/24/2002
- Sensor-Surface: 4mm (Mechanical Surface Detection)
- Electronics: DAE3 - SN410; Calibrated: 7/18/2002
- Phantom: SAM 4.0 - TP:1006
- Software: DASY4, V4.0 Build 35

**Area Scan (81x81x1):** Measurement grid: dx=15mm, dy=15mm  
**Zoom Scan (7x7x7)/Cube 0:** Measurement grid: dx=5mm, dy=5mm  
Reference Value = 93 V/m  
Peak SAR = 18.3 mW/g  
SAR(1 g) = 10.1 mW/g; SAR(10 g) = 5.16 mW/g  
Power Drift = -0.0005 dB

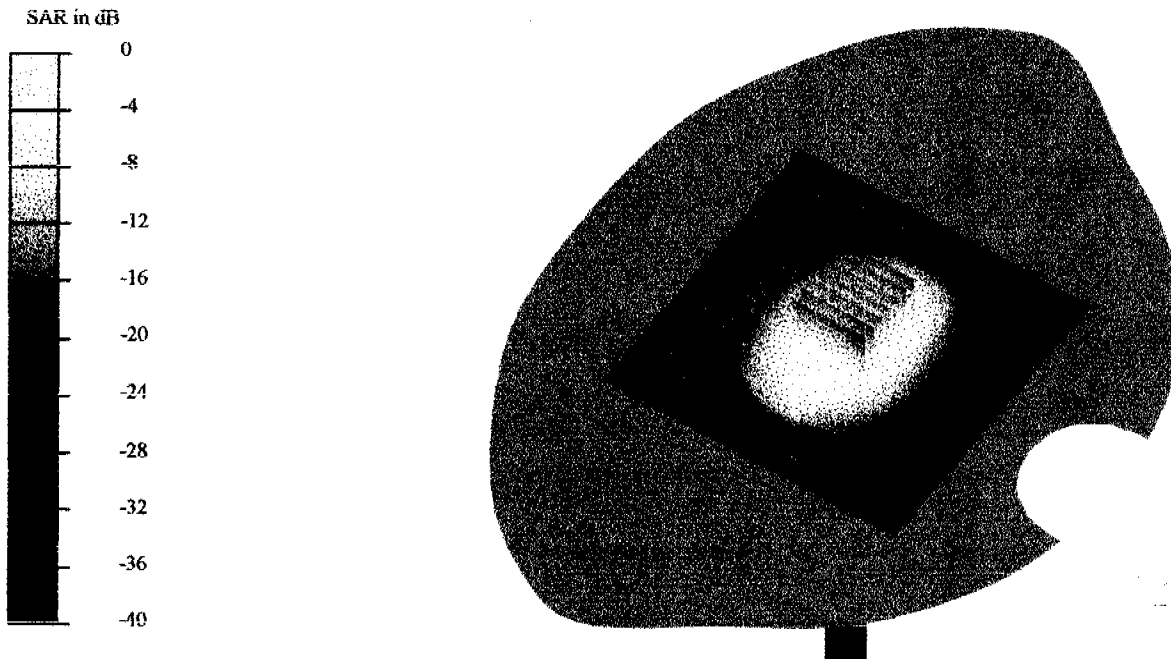

CH1 S11 1 U F9 1: 51.551  $\Omega$  4.6641  $\Omega$  390.69  $\mu$ H 1 900.000 000 MHz

γ

Del

PRm

Cor  
Avg  
16

↑

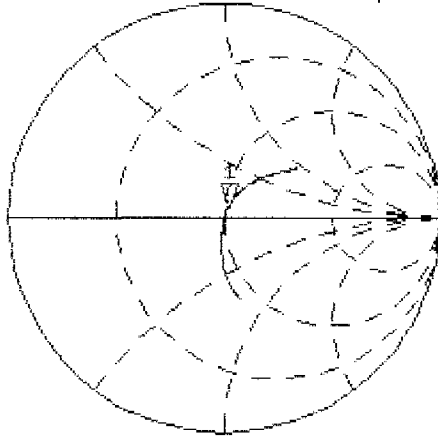

CH2 S11 LOG 5 dB/REF 0 dB 1:-26.320 dB 1 900.000 000 MHz

PRm  
Cor

↑

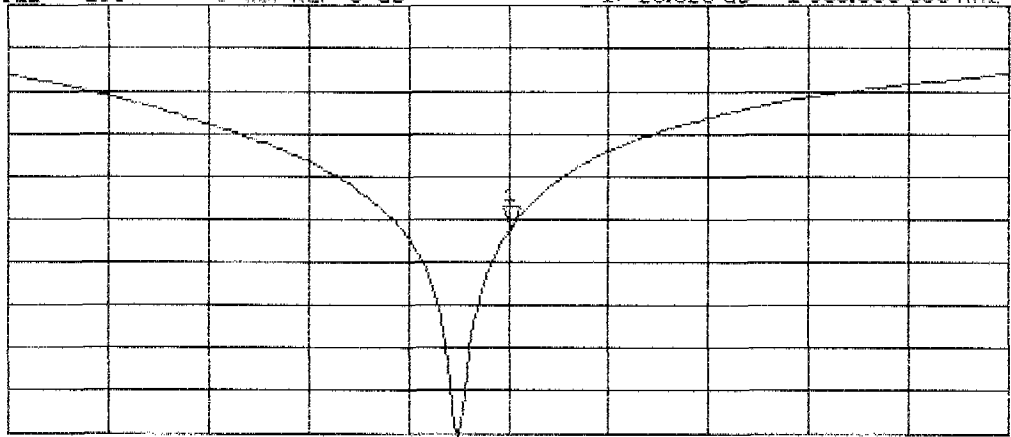

START 1 700.000 000 MHz

STOP 2 100.000 000 MHz

# Schmid & Partner Engineering AG

Zeughausstrasse 43, 8004 Zurich, Switzerland, Phone +41 1 245 97 00, Fax +41 1 245 97 79

## Calibration Certificate

### Dosimetric E-Field Probe

Type:

ET3DV6

Serial Number:

1711

Place of Calibration:

Zurich

Date of Calibration:

September 3, 2002

Calibration Interval:

12 months

Schmid & Partner Engineering AG hereby certifies, that this device has been calibrated on the date indicated above. The calibration was performed in accordance with specifications and procedures of Schmid & Partner Engineering AG.

Wherever applicable, the standards used in the calibration process are traceable to international standards. In all other cases the standards of the Laboratory for EMF and Microwave Electronics at the Swiss Federal Institute of Technology (ETH) in Zurich, Switzerland have been applied.

Calibrated by:

D. Keller

Approved by:

Marie Katzev

# Probe ET3DV6

**SN:1711**

**Manufactured: August 7, 2002**  
**Last calibration: September 3, 2002**

**Calibrated for DASY Systems**

(Note: non-compatible with DASY2 system!)



**DASY - Parameters of Probe: ET3DV6 SN:1711****Sensitivity in Free Space**

NormX	<b>1.38</b> $\mu\text{V}/(\text{V}/\text{m})^2$
NormY	<b>1.60</b> $\mu\text{V}/(\text{V}/\text{m})^2$
NormZ	<b>1.53</b> $\mu\text{V}/(\text{V}/\text{m})^2$

**Diode Compression**

DCP X	<b>97</b>	mV
DCP Y	<b>97</b>	mV
DCP Z	<b>97</b>	mV

**Sensitivity in Tissue Simulating Liquid**

Head	<b>900 MHz</b>	$\epsilon_r = 41.5 \pm 5\%$	$\sigma = 0.97 \pm 5\%$ mho/m
Head	<b>835 MHz</b>	$\epsilon_r = 41.5 \pm 5\%$	$\sigma = 0.90 \pm 5\%$ mho/m
ConvF X	<b>6.4</b> $\pm 9.5\%$ (k=2)	Boundary effect:	
ConvF Y	<b>6.4</b> $\pm 9.5\%$ (k=2)	Alpha	<b>0.47</b>
ConvF Z	<b>6.4</b> $\pm 9.5\%$ (k=2)	Depth	<b>2.17</b>
Head	<b>1800 MHz</b>	$\epsilon_r = 40.0 \pm 5\%$	$\sigma = 1.40 \pm 5\%$ mho/m
Head	<b>1900 MHz</b>	$\epsilon_r = 40.0 \pm 5\%$	$\sigma = 1.40 \pm 5\%$ mho/m
ConvF X	<b>5.3</b> $\pm 9.5\%$ (k=2)	Boundary effect:	
ConvF Y	<b>5.3</b> $\pm 9.5\%$ (k=2)	Alpha	<b>0.49</b>
ConvF Z	<b>5.3</b> $\pm 9.5\%$ (k=2)	Depth	<b>2.52</b>

**Boundary Effect**

Head	<b>900 MHz</b>	<b>Typical SAR gradient: 5 % per mm</b>	
Probe Tip to Boundary		<b>1 mm</b>	<b>2 mm</b>
SAR <sub>be</sub> [%] Without Correction Algorithm		<b>9.6</b>	<b>5.3</b>
SAR <sub>be</sub> [%] With Correction Algorithm		<b>0.2</b>	<b>0.4</b>
Head	<b>1800 MHz</b>	<b>Typical SAR gradient: 10 % per mm</b>	
Probe Tip to Boundary		<b>1 mm</b>	<b>2 mm</b>
SAR <sub>be</sub> [%] Without Correction Algorithm		<b>12.5</b>	<b>8.4</b>
SAR <sub>be</sub> [%] With Correction Algorithm		<b>0.2</b>	<b>0.2</b>

**Sensor Offset**

Probe Tip to Sensor Center	<b>2.7</b>	mm
Optical Surface Detection	<b>1.3 <math>\pm</math> 0.2</b>	mm

### Receiving Pattern ( $\phi$ ), $\theta = 0^\circ$

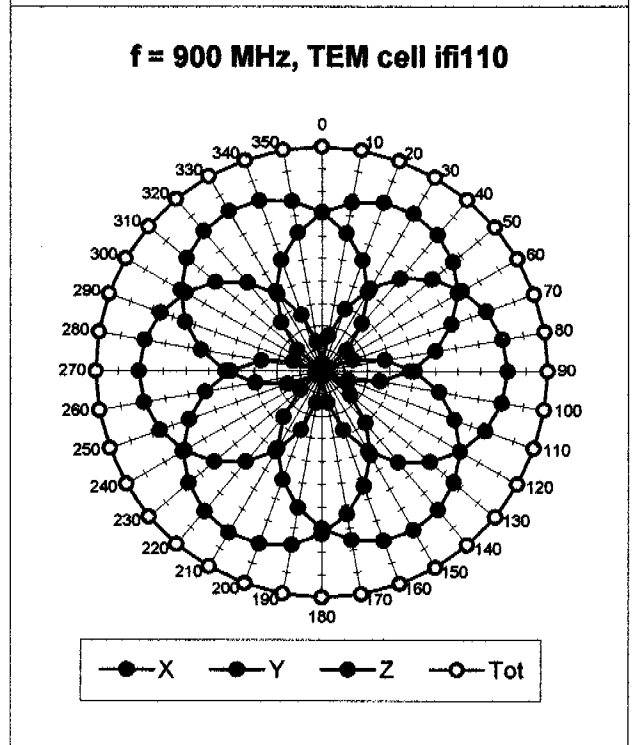
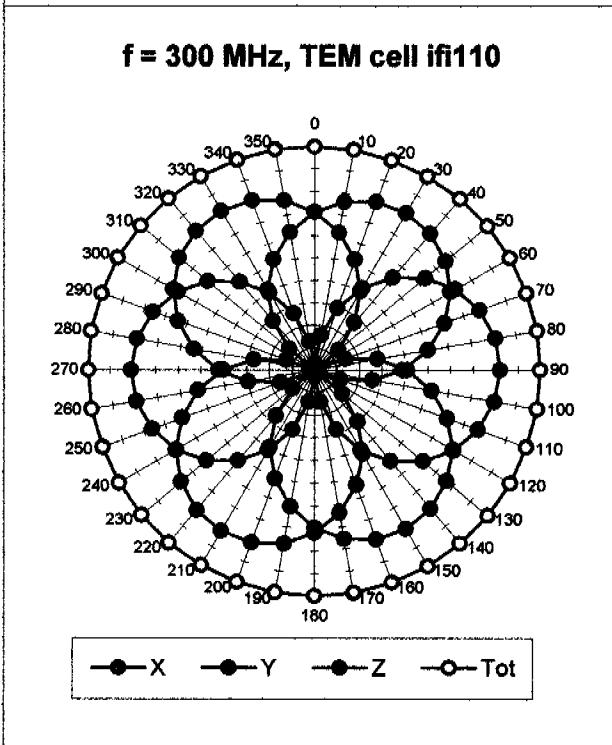
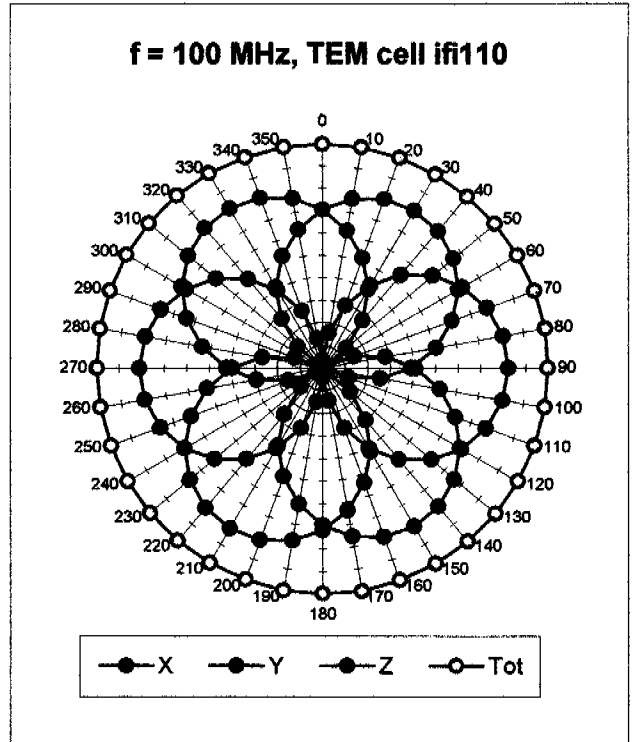
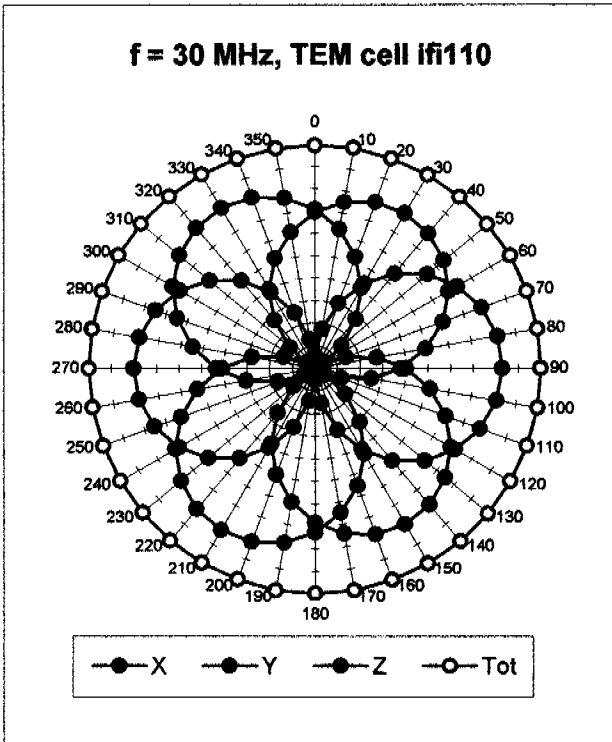

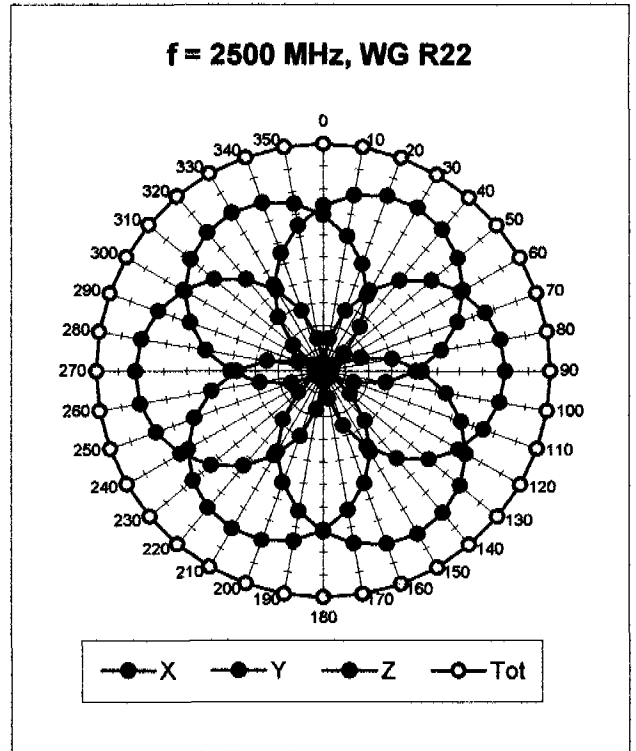
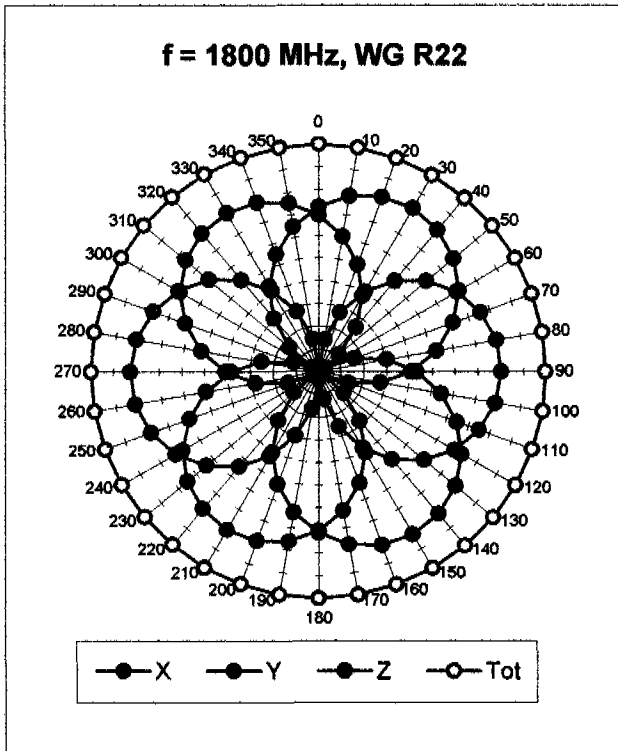

### Isotropy Error ( $\phi$ ), $\theta = 0^\circ$

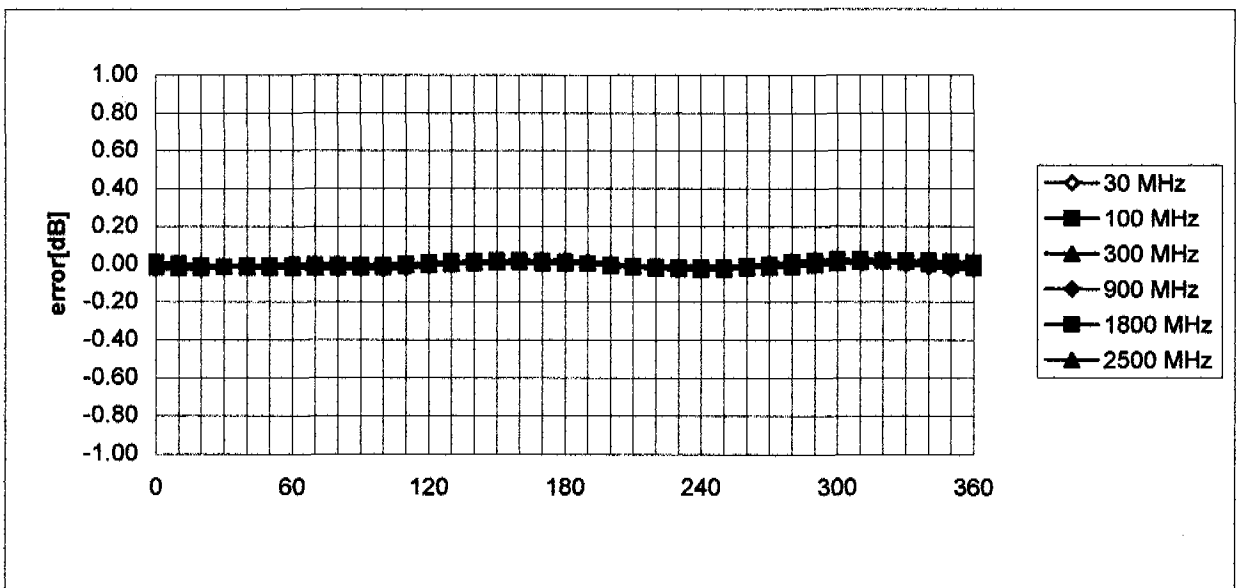

# Frequency Response of E-Field

( TEM-Cell:ifi110, Waveguide R22)

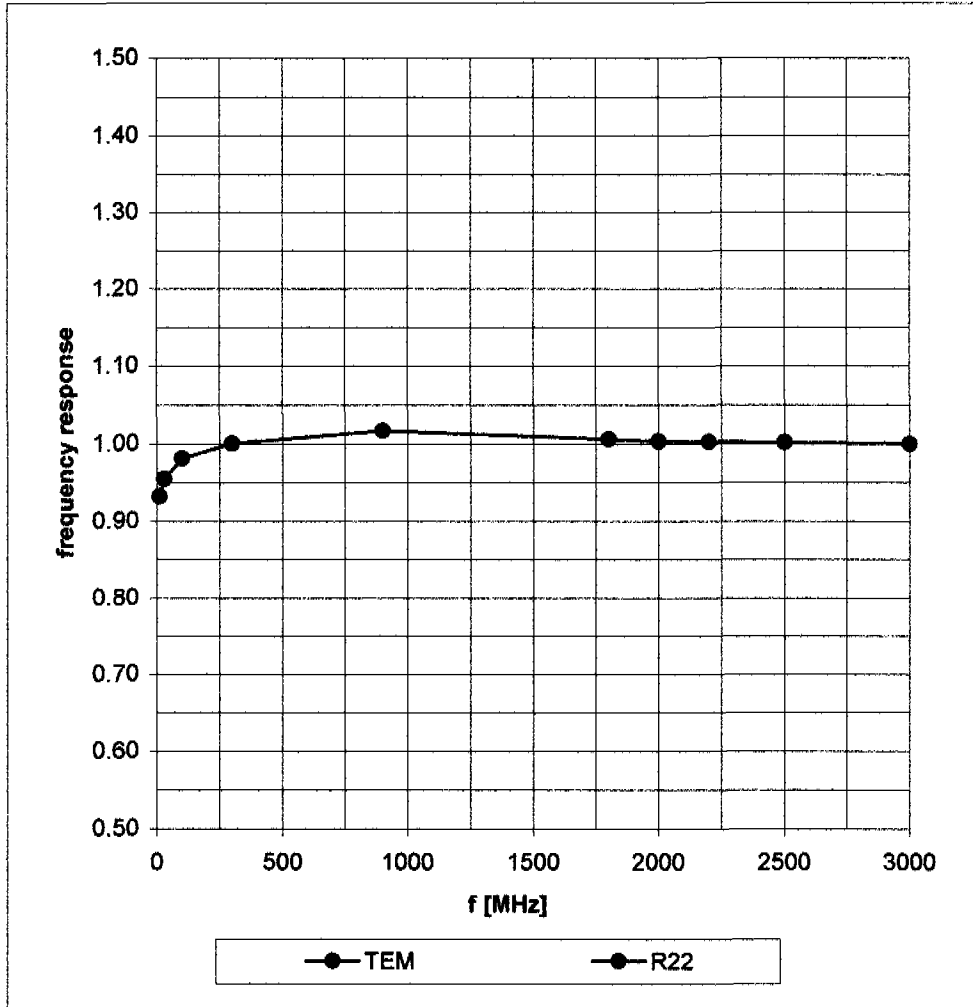

### Dynamic Range f(SAR<sub>brain</sub>) ( Waveguide R22 )

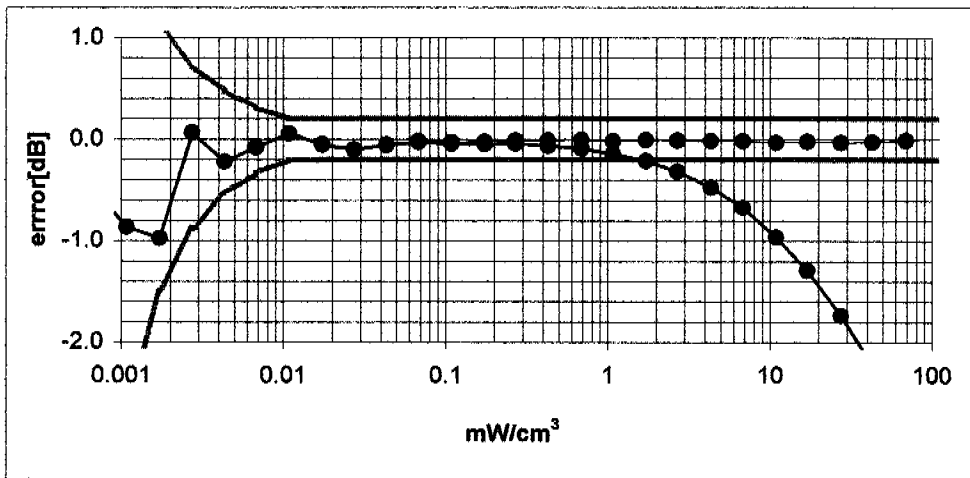
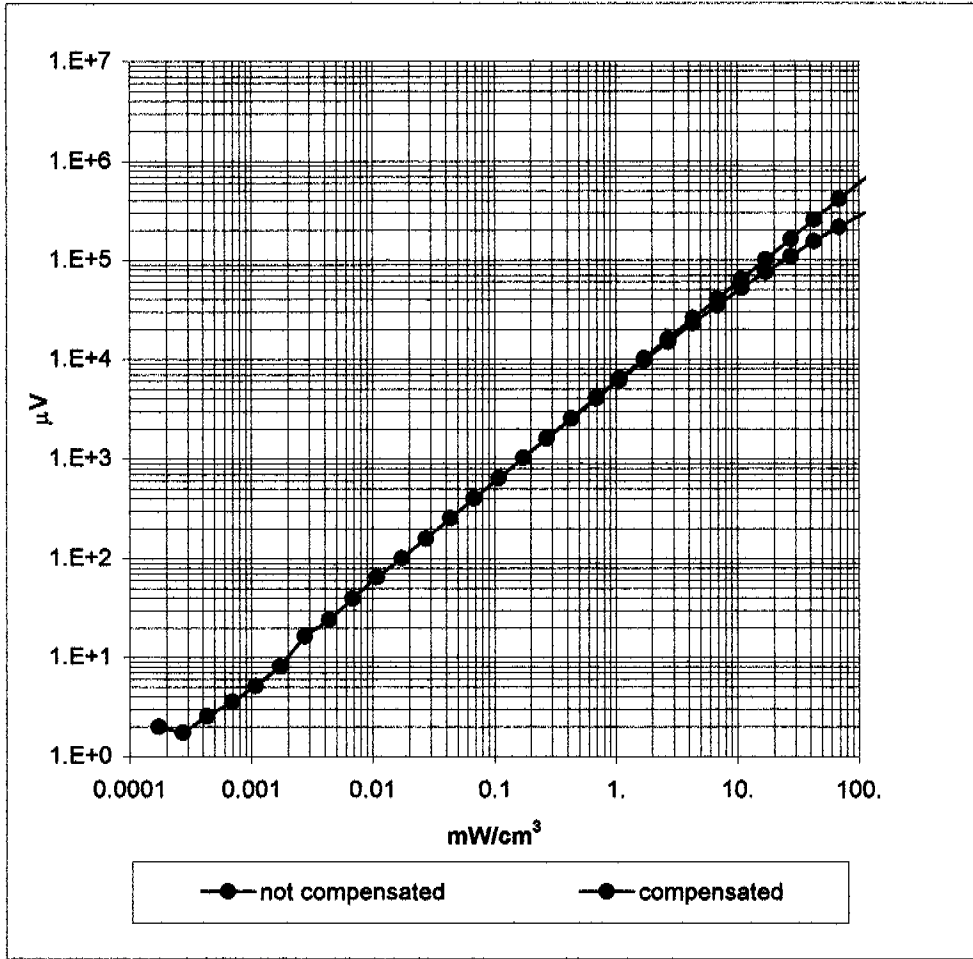

## Conversion Factor Assessment

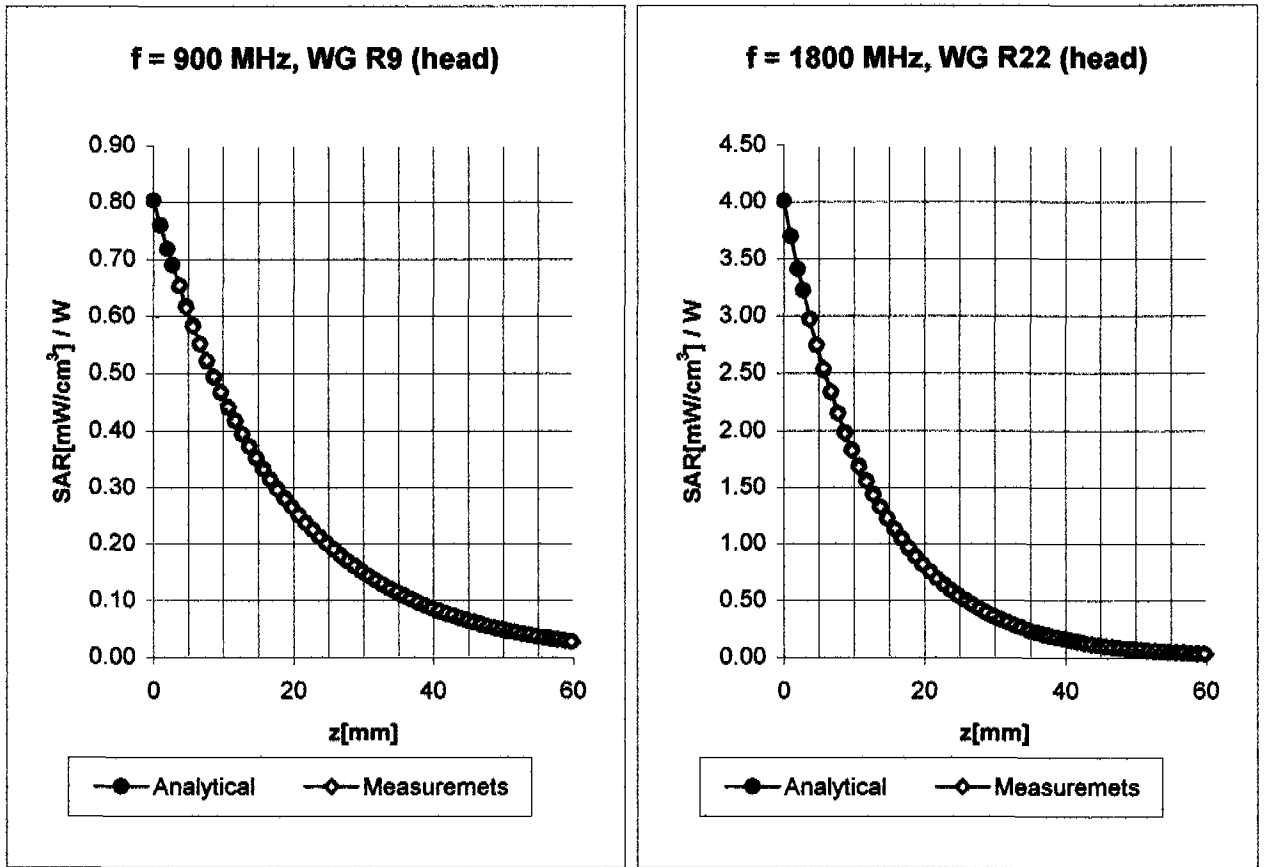

<b>Head</b>	<b>900 MHz</b>	$\epsilon_r = 41.5 \pm 5\%$	$\sigma = 0.97 \pm 5\% \text{ mho/m}$
<b>Head</b>	<b>835 MHz</b>	$\epsilon_r = 41.5 \pm 5\%$	$\sigma = 0.90 \pm 5\% \text{ mho/m}$
	ConvF X	<b>6.4</b> $\pm 9.5\%$ (k=2)	Boundary effect:
	ConvF Y	<b>6.4</b> $\pm 9.5\%$ (k=2)	Alpha <b>0.47</b>
	ConvF Z	<b>6.4</b> $\pm 9.5\%$ (k=2)	Depth <b>2.17</b>
<b>Head</b>	<b>1800 MHz</b>	$\epsilon_r = 40.0 \pm 5\%$	$\sigma = 1.40 \pm 5\% \text{ mho/m}$
<b>Head</b>	<b>1900 MHz</b>	$\epsilon_r = 40.0 \pm 5\%$	$\sigma = 1.40 \pm 5\% \text{ mho/m}$
	ConvF X	<b>5.3</b> $\pm 9.5\%$ (k=2)	Boundary effect:
	ConvF Y	<b>5.3</b> $\pm 9.5\%$ (k=2)	Alpha <b>0.49</b>
	ConvF Z	<b>5.3</b> $\pm 9.5\%$ (k=2)	Depth <b>2.52</b>

# Deviation from Isotropy in HSL

Error ( $\theta, \phi$ ),  $f = 900$  MHz

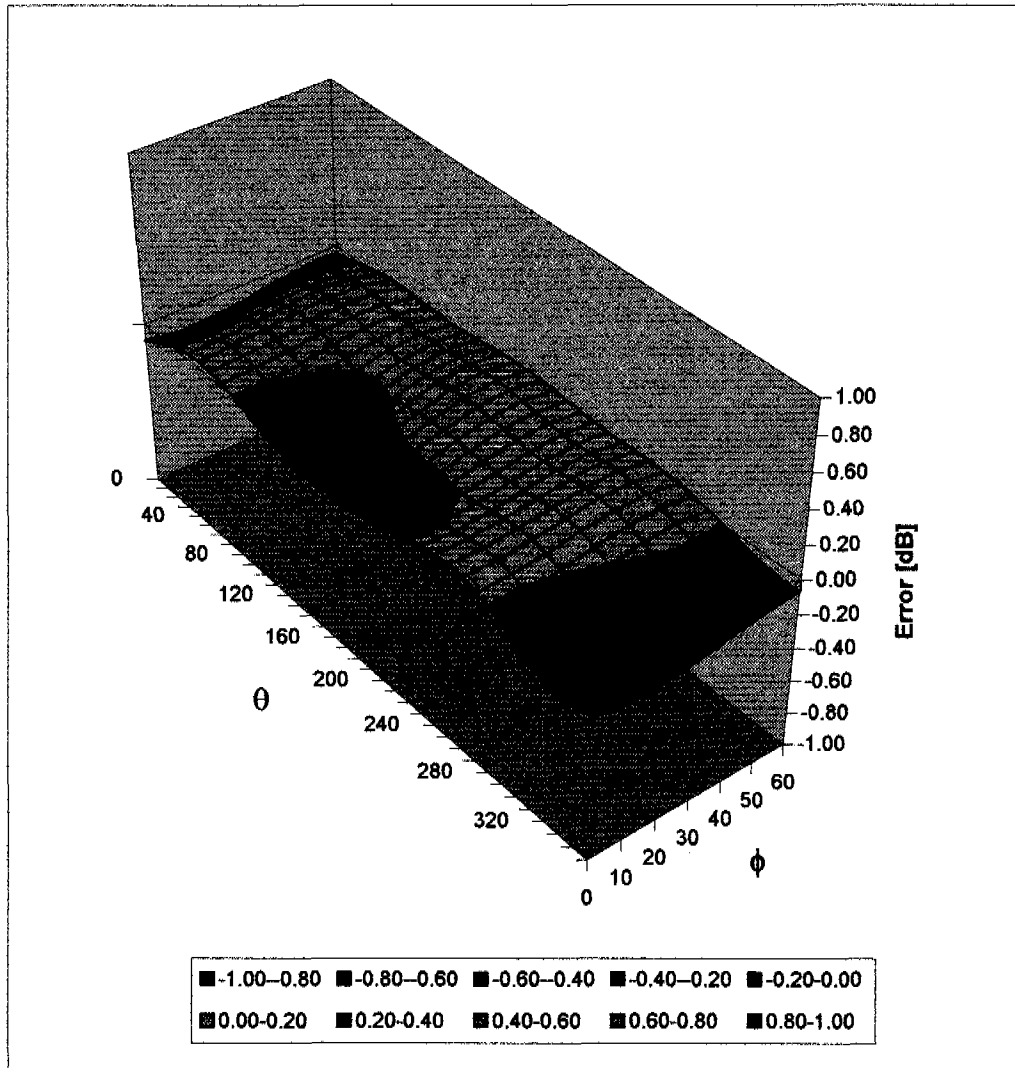

# Probe ET3DV6

**SN:1711**

**Additional Conversion Factors**

**Calibrated: November 26, 2002**

**Calibrated for DASY Systems**

(Note: non-compatible with DASY2 system!)



## Conversion Factor Assessment

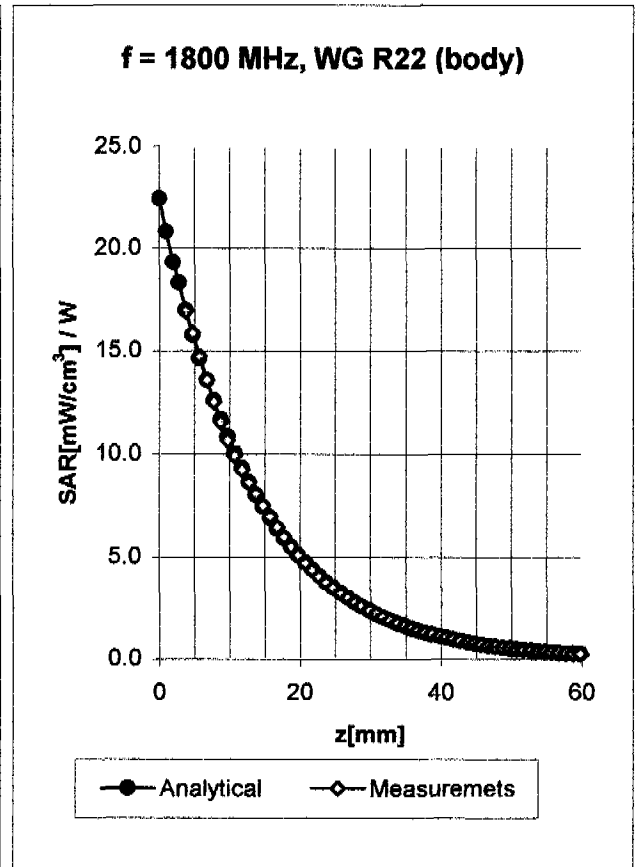
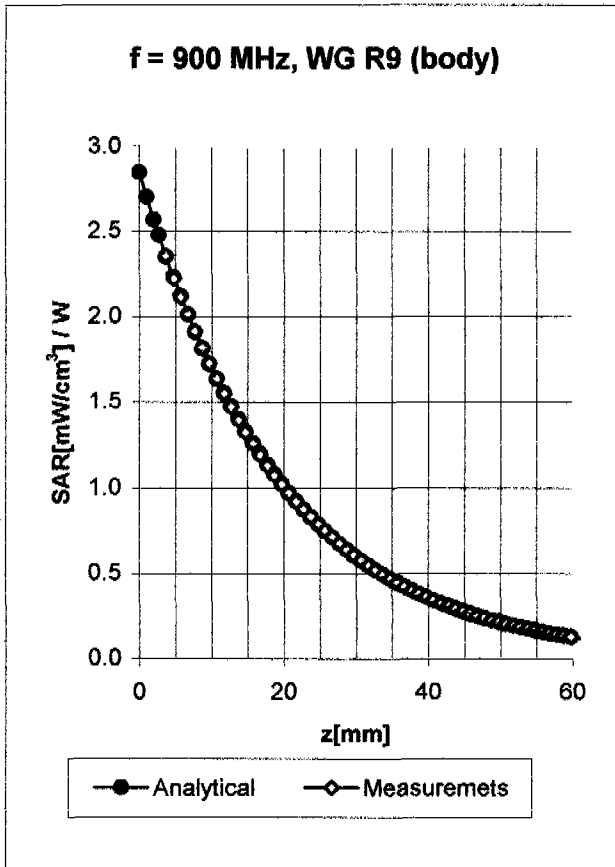

<b>Body</b>	<b>900 MHz</b>	$\epsilon_r = 55.0 \pm 5\%$	$\sigma = 1.05 \pm 5\% \text{ mho/m}$
<b>Body</b>	<b>835 MHz</b>	$\epsilon_r = 55.2 \pm 5\%$	$\sigma = 0.97 \pm 5\% \text{ mho/m}$
	ConvF X	<b>6.2</b> $\pm 9.5\%$ (k=2)	Boundary effect:
	ConvF Y	<b>6.2</b> $\pm 9.5\%$ (k=2)	Alpha <b>0.41</b>
	ConvF Z	<b>6.2</b> $\pm 9.5\%$ (k=2)	Depth <b>2.49</b>
<b>Body</b>	<b>1800 MHz</b>	$\epsilon_r = 53.3 \pm 5\%$	$\sigma = 1.52 \pm 5\% \text{ mho/m}$
<b>Body</b>	<b>1900 MHz</b>	$\epsilon_r = 53.3 \pm 5\%$	$\sigma = 1.52 \pm 5\% \text{ mho/m}$
	ConvF X	<b>5.0</b> $\pm 9.5\%$ (k=2)	Boundary effect:
	ConvF Y	<b>5.0</b> $\pm 9.5\%$ (k=2)	Alpha <b>0.63</b>
	ConvF Z	<b>5.0</b> $\pm 9.5\%$ (k=2)	Depth <b>2.26</b>

## Conversion Factor Assessment

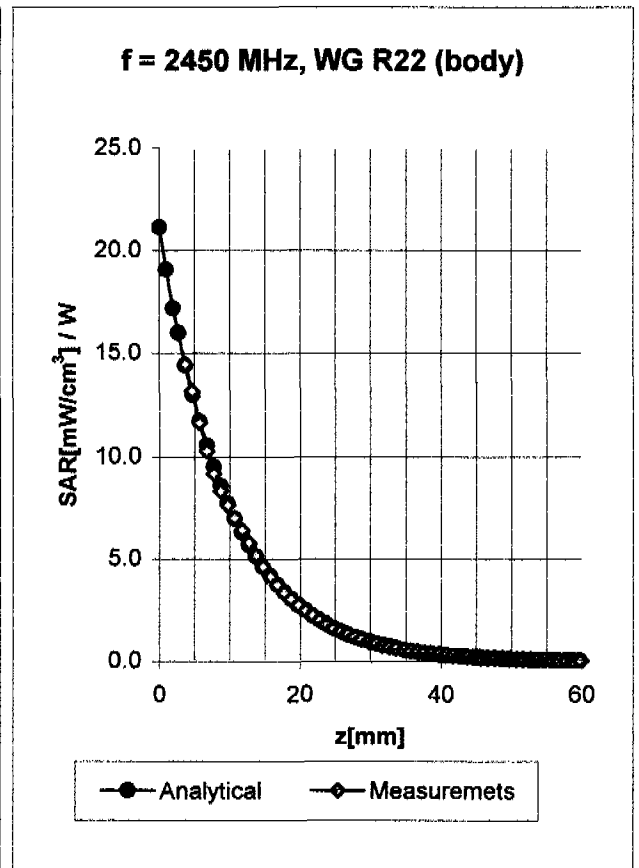
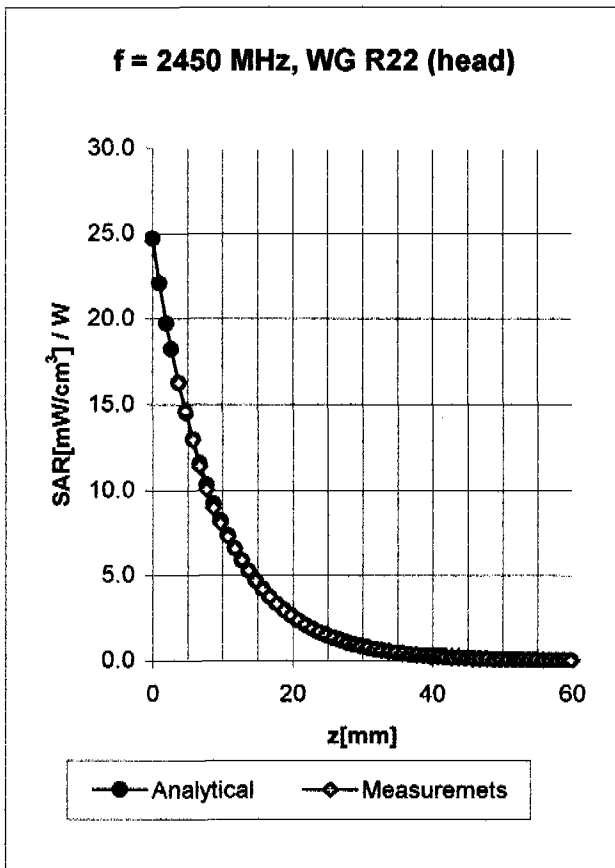

<b>2450</b>	<b>Head</b>	<b>MHz</b>	$\epsilon_r = 39.2 \pm 5\%$	$\sigma = 1.80 \pm 5\% \text{ mho/m}$
	ConvF X		<b>4.9</b> $\pm 8.9\%$ (k=2)	Boundary effect:
	ConvF Y		<b>4.9</b> $\pm 8.9\%$ (k=2)	Alpha <b>1.00</b>
	ConvF Z		<b>4.9</b> $\pm 8.9\%$ (k=2)	Depth <b>1.72</b>
<b>2450</b>	<b>Body</b>	<b>MHz</b>	$\epsilon_r = 52.7 \pm 5\%$	$\sigma = 1.95 \pm 5\% \text{ mho/m}$
	ConvF X		<b>4.4</b> $\pm 8.9\%$ (k=2)	Boundary effect:
	ConvF Y		<b>4.4</b> $\pm 8.9\%$ (k=2)	Alpha <b>1.00</b>
	ConvF Z		<b>4.4</b> $\pm 8.9\%$ (k=2)	Depth <b>1.85</b>

**DASY - DOSIMETRIC ASSESSMENT SYSTEM**

**CALIBRATION REPORT**

**DATA ACQUISITION ELECTRONICS**

**MODEL:** DAE3 V1

**SERIAL NUMBER:** 522

This Data Acquisition Unit was calibrated and tested using a FLUKE 702 Process Calibrator. Calibration and verification were performed at an ambient temperature of  $23 \pm 5$  °C and a relative humidity of  $< 70\%$ .

Measurements were performed using the standard DASY software for converting binary values, offset compensation and noise filtering. Software settings are indicated in the reports.

Results from this calibration relate only to the unit calibrated.

**Calibrated by:** Storchenegger

**Calibration Date:** 11. 09. 2002

**DASY Software Version:** DASY3 V3.1c

# 1. DC Voltage Measurement

DA - Converter Values from DAE

High Range: 1LSB = 6.1 $\mu$ V, full range = 400 mV  
 Low Range: 1LSB = 61nV, full range = 4 mV

Software Set-up: Calibration time: 3 sec Measuring time: 3 sec

Setup	X	Y	Z
High Range	403.7567398	403.5333268	403.8600523
Low Range	3.90623	3.92439	3.92633
Connector Position	44 °		

High Range	Input	Reading in $\mu$ V	% Error
Channel X + Input	200mV	200000.4	0.00
	20mV	19994.9	-0.03
Channel X - Input	20mV	-19994.4	-0.03
	200mV	199999.9	0.00
Channel Y + Input	20mV	19996.04	-0.02
	20mV	-19995.35	-0.02
Channel Y - Input	20mV	-19995.35	-0.02
	200mV	200000	0.00
Channel Z + Input	20mV	19993.57	-0.03
	20mV	-19994.59	-0.03
Channel Z - Input	20mV	-19994.59	-0.03

Low Range	Input	Reading in $\mu$ V	% Error
Channel X + Input	2mV	2000.07	0.00
	0.2mV	200.266	0.13
Channel X - Input	0.2mV	-200.669	0.33
	2mV	2000.005	0.00
Channel Y + Input	0.2mV	199.4087	-0.30
	0.2mV	-200.5428	0.27
Channel Y - Input	0.2mV	-200.5428	0.27
	2mV	2000.05	0.00
Channel Z + Input	0.2mV	199.285	-0.36
	0.2mV	-201.008	0.50
Channel Z - Input	0.2mV	-201.008	0.50

## 2. Common mode sensitivity

Software Set-up

Calibration time: 3 sec, Measuring time: 3 sec

High/Low Range

in $\mu\text{V}$	Common mode Input Voltage	High Range Reading	Low Range Reading
<b>Channel X</b>	200mV	1.89173	1.5706
	- 200mV	-0.957298	-1.63568
<b>Channel Y</b>	200mV	1.06159	0.55289
	- 200mV	-1.07262	-1.60898
<b>Channel Z</b>	200mV	-7.02304	-7.75271
	- 200mV	6.48984	6.11901

## 3. Channel separation

Software Set-up

Calibration time: 3 sec, Measuring time: 3 sec

High Range

in $\mu\text{V}$	Input Voltage	Channel X	Channel Y	Channel Z
<b>Channel X</b>	200mV	-	0.967802	-0.38491
<b>Channel Y</b>	200mV	0.985686	-	-0.851851
<b>Channel Z</b>	200mV	0.469187	-0.713242	-

## 4. AD-Converter Values with inputs shorted

in LSB	Low Range	High Range
<b>Channel X</b>	14950.9	15343
<b>Channel Y</b>	14931.4	15456.6
<b>Channel Z</b>	15332.2	15470.3

## 5. Input Offset Measurement

Measured after 15 min warm-up time of the Data Acquisition Electronic.  
Every Measurement is preceded by a calibration cycle.

Software set-up:

Calibration time: 3 sec  
Measuring time: 3 sec  
Number of measurements: 100, Low Range

Input 10M $\Omega$

in $\mu\text{V}$	Average	min. Offset	max. Offset	Std. Deviation
Channel X	-1.11	-3.70	0.56	0.65
Channel Y	0.79	-0.47	2.26	0.38
Channel Z	-1.60	-3.56	-0.55	0.34

Input shorted

in $\mu\text{V}$	Average	min. Offset	max. Offset	Std. Deviation
Channel X	-1.36	-2.30	0.49	0.39
Channel Y	0.05	-0.63	1.82	0.33
Channel Z	-0.53	-1.37	0.58	0.21

## 6. Input Offset Current

in fA	Input Offset Current
Channel X	< 25
Channel Y	< 25
Channel Z	< 25

## 7. Input Resistance

	Calibrating	Measuring
Channel X	200 k $\Omega$	200 M $\Omega$
Channel Y	200 k $\Omega$	200 M $\Omega$
Channel Z	200 k $\Omega$	200 M $\Omega$

## 8. Low Battery Alarm Voltage

in V	Alarm Level
Supply (+ Vcc)	7.83 V
Supply (- Vcc)	-7.62 V

## 9. Power Consumption

in mA	Switched off	Stand by	Transmitting
Supply (+ Vcc)	0.000	5.79	13.9
Supply (- Vcc)	-0.011	-8.07	-9.24

## 10. Functional test

Touch async pulse 1	ok
Touch async pulse 2	ok
Touch status bit 1	ok
Touch status bit 2	ok
Remote power off	ok
Remote analog Power control	ok
Modification Status	B - C

Date: 11.09.02

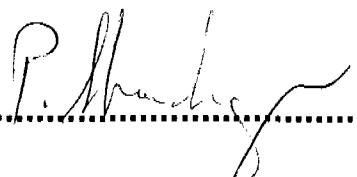
Signature: 



## Appendix B

### Measurement Plots



Test Laboratory: ELECTRONIC TECHNOLOGY SYSTEMS DR. GENZ GMBH  
File Name: Dipol Valid.900\_06.03.03.da4

**DUT: Dipole 900 MHz Type & Serial Number:**  
**Program: Dipol Valid 900; Dipol 900 (20dBm)**

Communication System: CW; Frequency: 900 MHz; Duty Cycle: 1:1  
Medium: Head 900 MHz ( $\sigma = 0.98$  mho/m,  $\epsilon = 41.86$ ,  $\rho = 1000$  kg/m<sup>3</sup>)  
Phantom section: FlatSection

DASY4 Configuration:

- Probe: ET3DV6 - SN1711; ConvF(6.4, 6.4, 6.4); Calibrated: 11/29/2002
- Sensor-Surface: 4mm (Mechanical Surface Detection)
- Electronics: DAE3 Sn522; Calibrated: 9/11/2002
- Phantom: - TP:
- Software: DASY4, V4.0 Build 51

**Zoom Scan (7x7x7)/Cube 0:** Measurement grid: dx=5mm, dy=5mm

Reference Value = 36.4 V/m

Peak SAR = 1.74 mW/g

SAR(1 g) = 1.08 mW/g; SAR(10 g) = 0.688 mW/g

Power Drift = -0.01 dB

**Area Scan (61x61x1):** Measurement grid: dx=15mm, dy=15mm

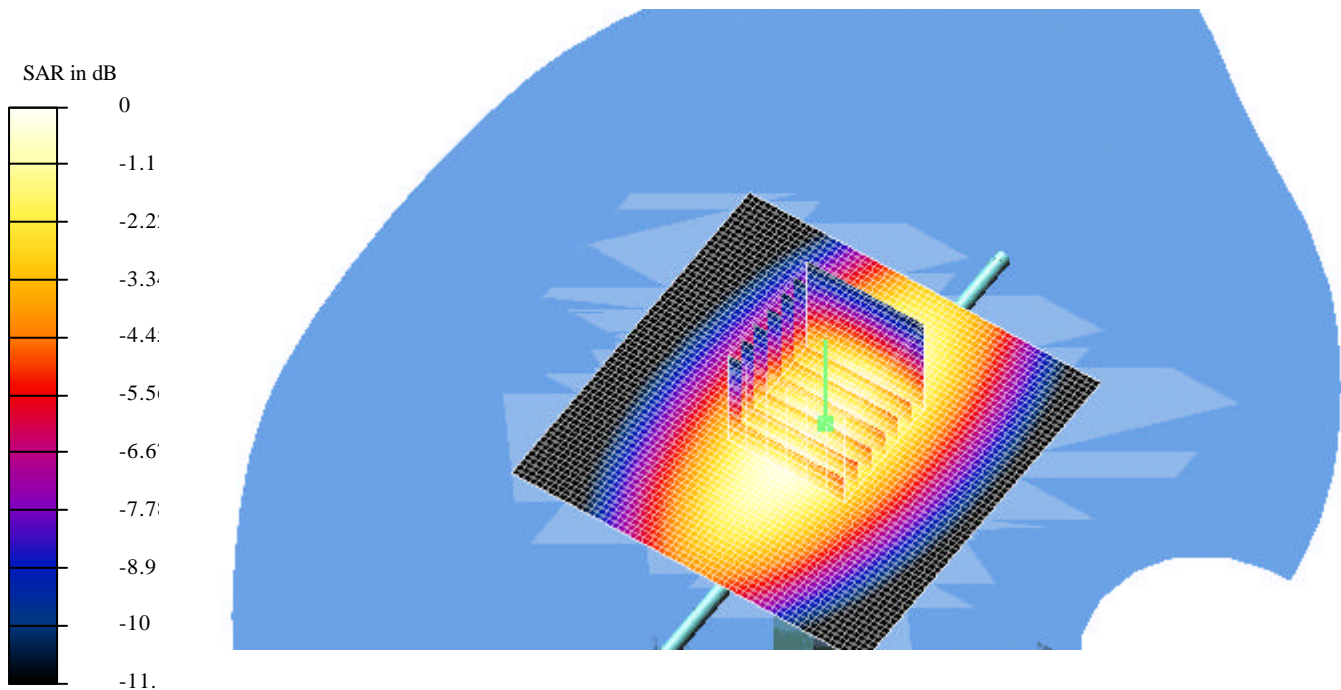

Test Laboratory: ELECTRONIC TECHNOLOGY SYSTEMS DR. GENZ GMBH  
File Name: Dipol Valid.1900 h 17dBm\_25.04.03.da4

**DUT: Dipole 1900 MHz Type & Serial Number: 5d025**  
**Program: Dipol Valid 1900; Dipol 1900 (17dBm)**

Communication System: CW; Frequency: 1900 MHz; Duty Cycle: 1:1  
Medium: Head 1900 MHz ( $\sigma = 1.37$  mho/m,  $\epsilon = 40.2$ ,  $\rho = 1000$  kg/m<sup>3</sup>)  
Phantom section: FlatSection

DASY4 Configuration:

- Probe: ET3DV6 - SN1711; ConvF(5.3, 5.3, 5.3); Calibrated: 11/29/2002
- Sensor-Surface: 4mm (Mechanical Surface Detection)
- Electronics: DAE3 Sn522; Calibrated: 9/11/2002
- Phantom: - TP:
- Software: DASY4, V4.0 Build 51

**Zoom Scan (7x7x7)/Cube 0:** Measurement grid: dx=5mm, dy=5mm

Reference Value = 44.3 V/m

Peak SAR = 3.85 mW/g

SAR(1 g) = 2.18 mW/g; SAR(10 g) = 1.13 mW/g

Power Drift = 0.002 dB

**Area Scan (81x81x1):** Measurement grid: dx=10mm, dy=10mm

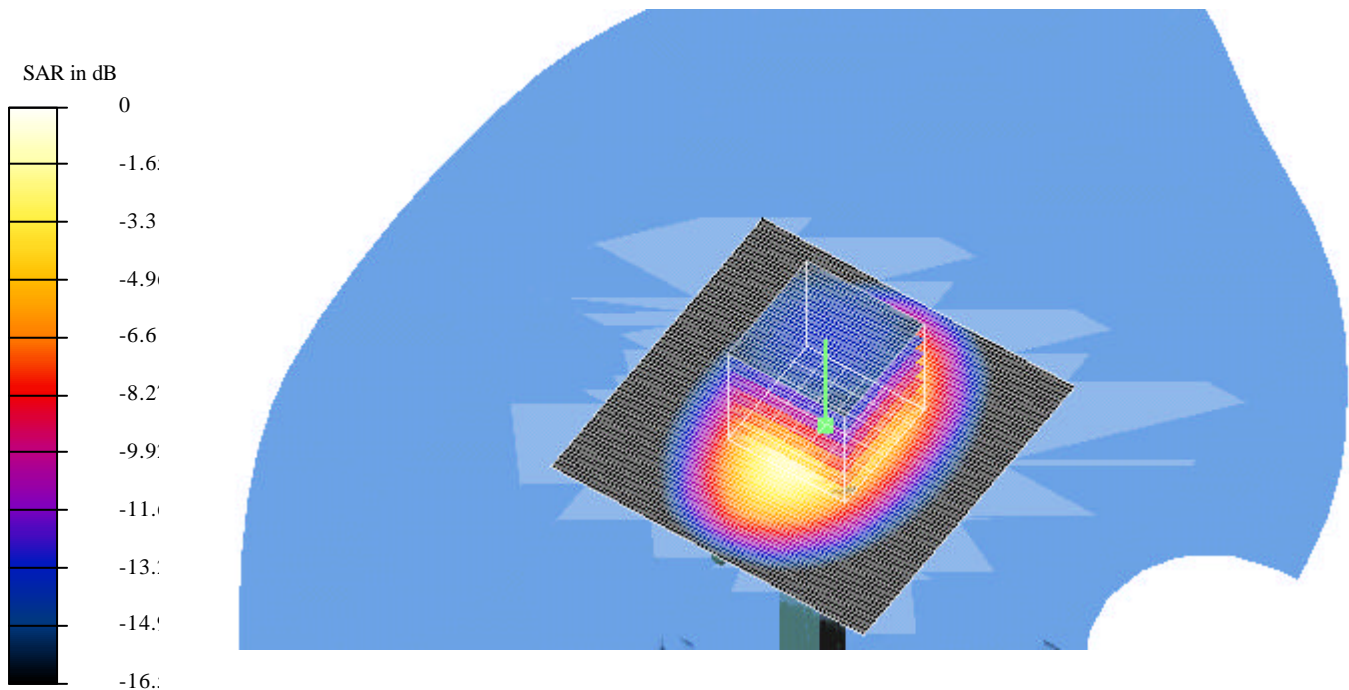

Test Laboratory: ELECTRONIC TECHNOLOGY SYSTEMS DR. GENZ GMBH  
File Name: GSM850\_right\_ch128\_cheek.da4

**DUT: GPRS Dual-Band Type & Serial Number: EB-G60U**  
**Program: GSM ; GSM850**

Communication System: GSM 850; Frequency: 824.2 MHz; Duty Cycle: 1:8  
Medium: Head 900 MHz ( $\sigma = 0.88$  mho/m,  $\epsilon = 43.51$ ,  $\rho = 1000$  kg/m<sup>3</sup>)  
Phantom section: RightSection

DASY4 Configuration:

- Probe: ET3DV6 - SN1711; ConvF(6.4, 6.4, 6.4); Calibrated: 11/29/2002
- Sensor-Surface: 4mm (Mechanical Surface Detection)
- Electronics: DAE3 Sn522; Calibrated: 9/11/2002
- Phantom: - TP:
- Software: DASY4, V4.0 Build 51

**Zoom Scan (7x7x7)/Cube 0:** Measurement grid: dx=5mm, dy=5mm

Reference Value = 14.2 V/m

Peak SAR = 0.766 mW/g

SAR(1 g) = 0.472 mW/g; SAR(10 g) = 0.288 mW/g

Power Drift = -0.03 dB

**Area Scan (41x81x1):** Measurement grid: dx=15mm, dy=15mm

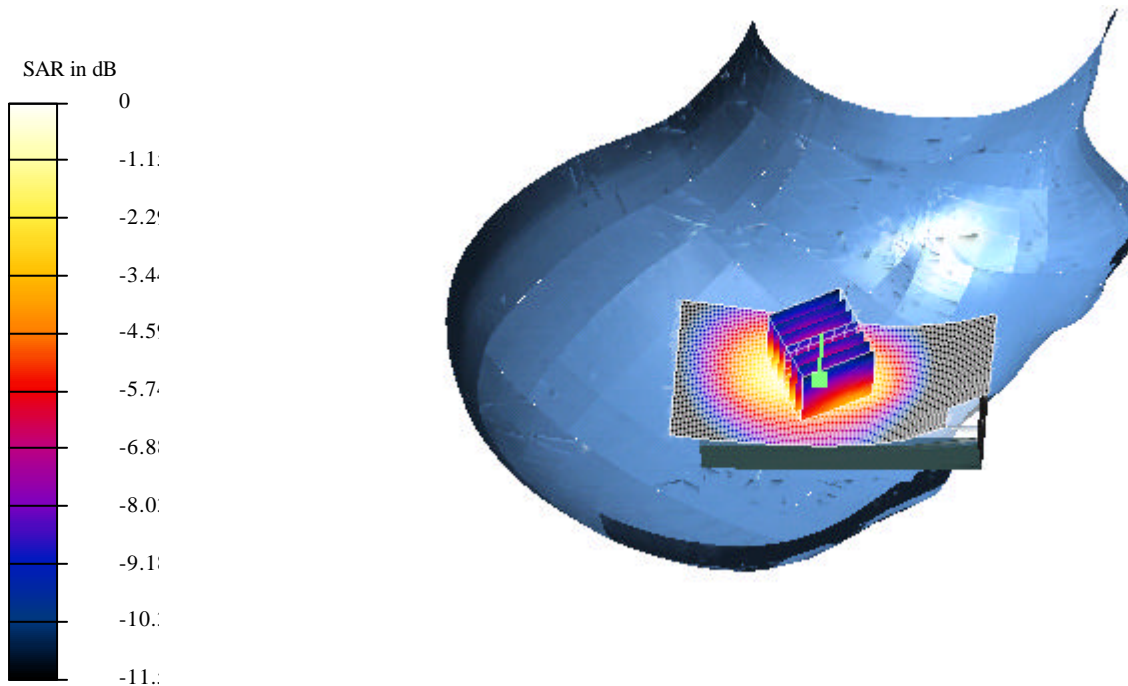

Test Laboratory: ELECTRONIC TECHNOLOGY SYSTEMS DR. GENZ GMBH  
File Name: GSM850\_right\_ch128\_tilted.da4

**DUT: GPRS Dual-Band Type & Serial Number: EB-G60U**  
**Program: GSM; GSM850**

Communication System: GSM 850; Frequency: 824.2 MHz; Duty Cycle: 1:8  
Medium: Head 900 MHz ( $\sigma = 0.9$  mho/m,  $\epsilon = 43.2$ ,  $\rho = 1000$  kg/m<sup>3</sup>)  
Phantom section: RightSection

DASY4 Configuration:

- Probe: ET3DV6 - SN1711; ConvF(6.4, 6.4, 6.4); Calibrated: 11/29/2002
- Sensor-Surface: 4mm (Mechanical Surface Detection)
- Electronics: DAE3 Sn522; Calibrated: 9/11/2002
- Phantom: - TP:
- Software: DASY4, V4.0 Build 51

**Zoom Scan (7x7x7)/Cube 0:** Measurement grid: dx=5mm, dy=5mm

Reference Value = 12.4 V/m

Peak SAR = 0.339 mW/g

SAR(1 g) = 0.227 mW/g; SAR(10 g) = 0.142 mW/g

Power Drift = -0.04 dB

**Area Scan (41x81x1):** Measurement grid: dx=15mm, dy=15mm

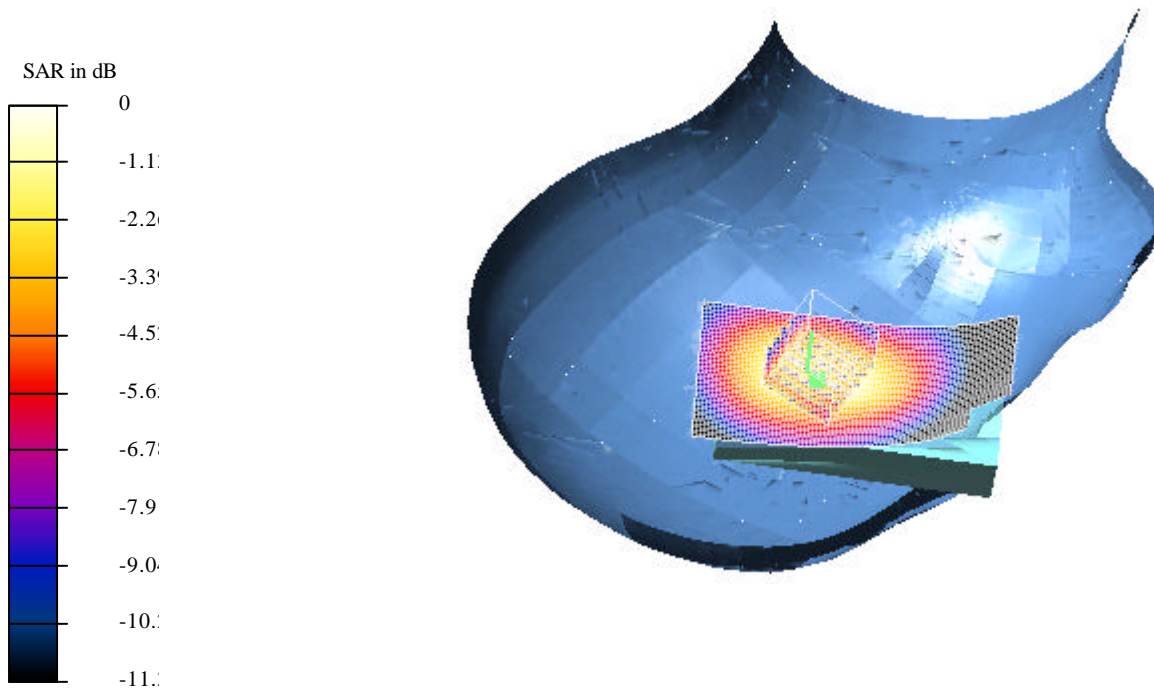

Test Laboratory: ELECTRONIC TECHNOLOGY SYSTEMS DR. GENZ GMBH  
File Name: GSM850\_right\_ch189\_cheek.da4

**DUT: GPRS Dual-Band Type & Serial Number: EB-G60U**  
**Program: GSM; GSM850**

Communication System: GSM 850; Frequency: 836.4 MHz; Duty Cycle: 1:8  
Medium: Head 900 MHz ( $\sigma = 0.90$  mho/m,  $\epsilon = 43.2$   $\rho = 1000$  kg/m<sup>3</sup>)  
Phantom section: RightSection

DASY4 Configuration:

- Probe: ET3DV6 - SN1711; ConvF(6.4, 6.4, 6.4); Calibrated: 11/29/2002
- Sensor-Surface: 4mm (Mechanical Surface Detection)
- Electronics: DAE3 Sn522; Calibrated: 9/11/2002
- Phantom: - TP:
- Software: DASY4, V4.0 Build 51

**Zoom Scan (7x7x7)/Cube 0:** Measurement grid: dx=5mm, dy=5mm

Reference Value = 13.7 V/m

Peak SAR = 0.691 mW/g

SAR(1 g) = 0.464 mW/g; SAR(10 g) = 0.29 mW/g

Power Drift = -0.006 dB

**Area Scan (41x81x1):** Measurement grid: dx=15mm, dy=15mm

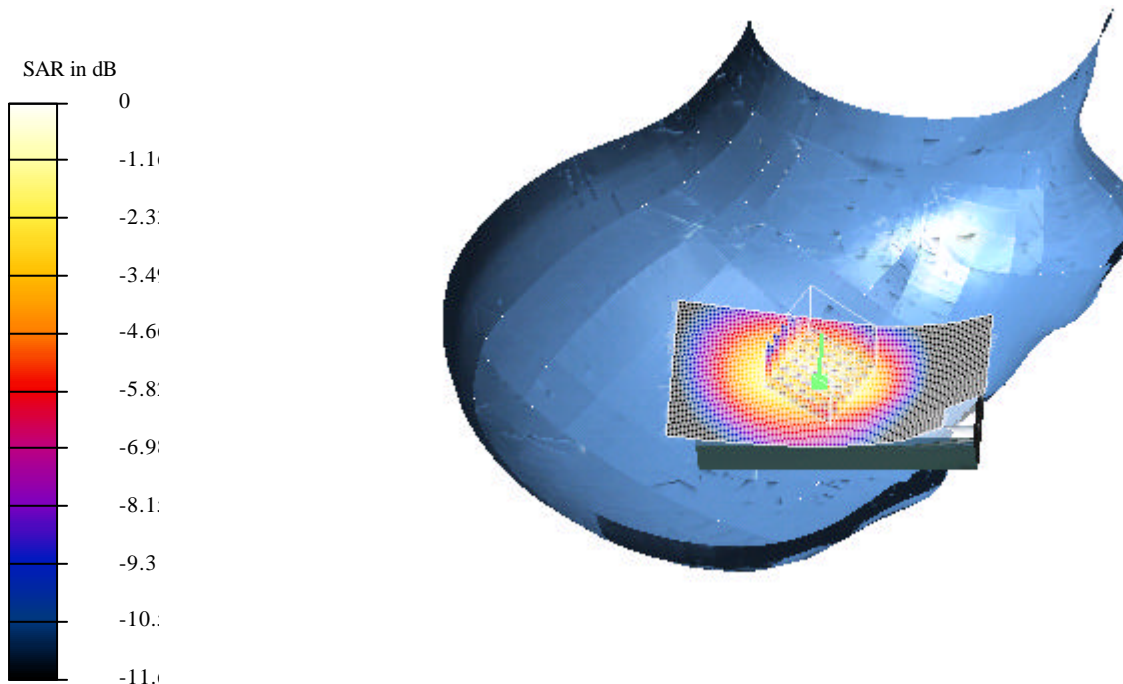



Test Laboratory: ELECTRONIC TECHNOLOGY SYSTEMS DR. GENZ GMBH  
File Name: GSM850\_right\_ch189\_tilted.da4

**DUT: GPRS Dual-Band Type & Serial Number: EB-G60U**  
**Program: GSM; GSM850**

Communication System: GSM 850; Frequency: 836.4 MHz; Duty Cycle: 1:8  
Medium: Head 900 MHz ( $\sigma = 0.9$  mho/m,  $\epsilon = 43.2$ ,  $\rho = 1000$  kg/m<sup>3</sup>)  
Phantom section: RightSection

DASY4 Configuration:

- Probe: ET3DV6 - SN1711; ConvF(6.4, 6.4, 6.4); Calibrated: 11/29/2002
- Sensor-Surface: 4mm (Mechanical Surface Detection)
- Electronics: DAE3 Sn522; Calibrated: 9/11/2002
- Phantom: - TP:
- Software: DASY4, V4.0 Build 51

**Zoom Scan (7x7x7)/Cube 0:** Measurement grid: dx=5mm, dy=5mm

Reference Value = 12.2 V/m

Peak SAR = 0.316 mW/g

SAR(1 g) = 0.212 mW/g; SAR(10 g) = 0.133 mW/g

Power Drift = -0.03 dB

**Area Scan (41x81x1):** Measurement grid: dx=15mm, dy=15mm

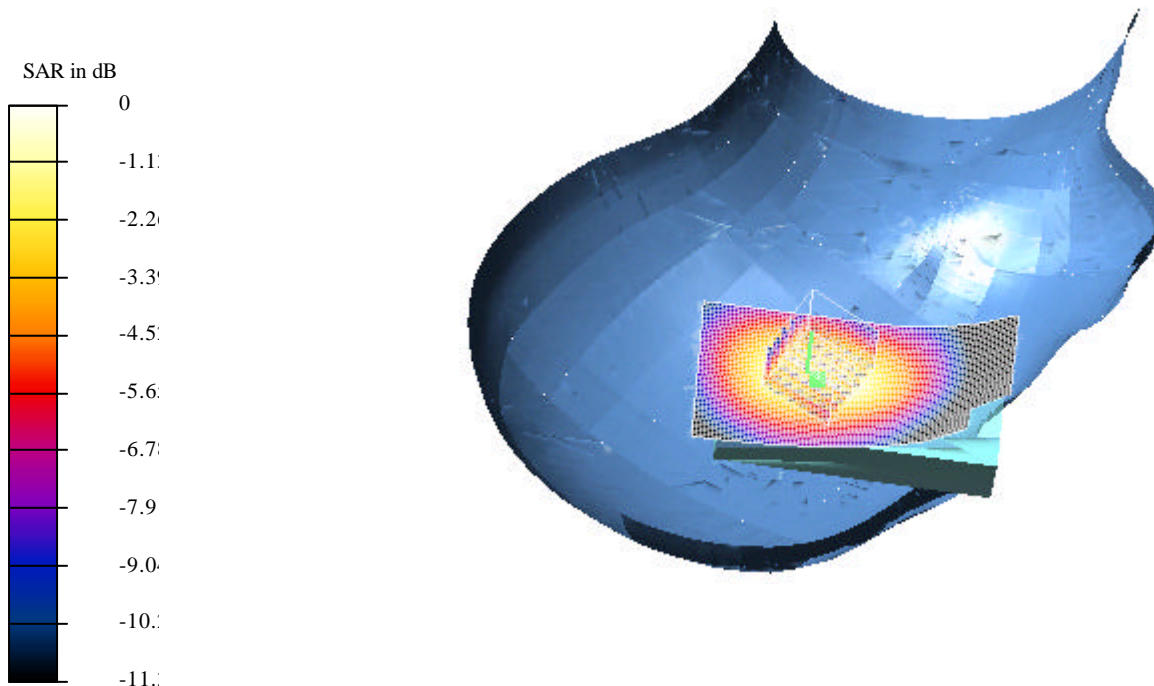

Test Laboratory: ELECTRONIC TECHNOLOGY SYSTEMS DR. GENZ GMBH  
File Name: GSM850\_right\_ch251\_cheek.da4

**DUT: GPRS Dual-Band Type & Serial Number: EB-G60U**  
**Program: GSM; GSM850**

Communication System: GSM 850; Frequency: 848.8 MHz; Duty Cycle: 1:8  
Medium: Head 900 MHz ( $\sigma = 0.92$  mho/m,  $\epsilon = 42.92$ ,  $\rho = 1000$  kg/m<sup>3</sup>)  
Phantom section: RightSection

DASY4 Configuration:

- Probe: ET3DV6 - SN1711; ConvF(6.4, 6.4, 6.4); Calibrated: 11/29/2002
- Sensor-Surface: 4mm (Mechanical Surface Detection)
- Electronics: DAE3 Sn522; Calibrated: 9/11/2002
- Phantom: - TP:
- Software: DASY4, V4.0 Build 51

**Zoom Scan (7x7x7)/Cube 0:** Measurement grid: dx=5mm, dy=5mm

Reference Value = 15.1 V/m

Peak SAR = 0.823 mW/g

SAR(1 g) = 0.561 mW/g; SAR(10 g) = 0.352 mW/g

Power Drift = -0.08 dB

**Area Scan (41x81x1):** Measurement grid: dx=15mm, dy=15mm

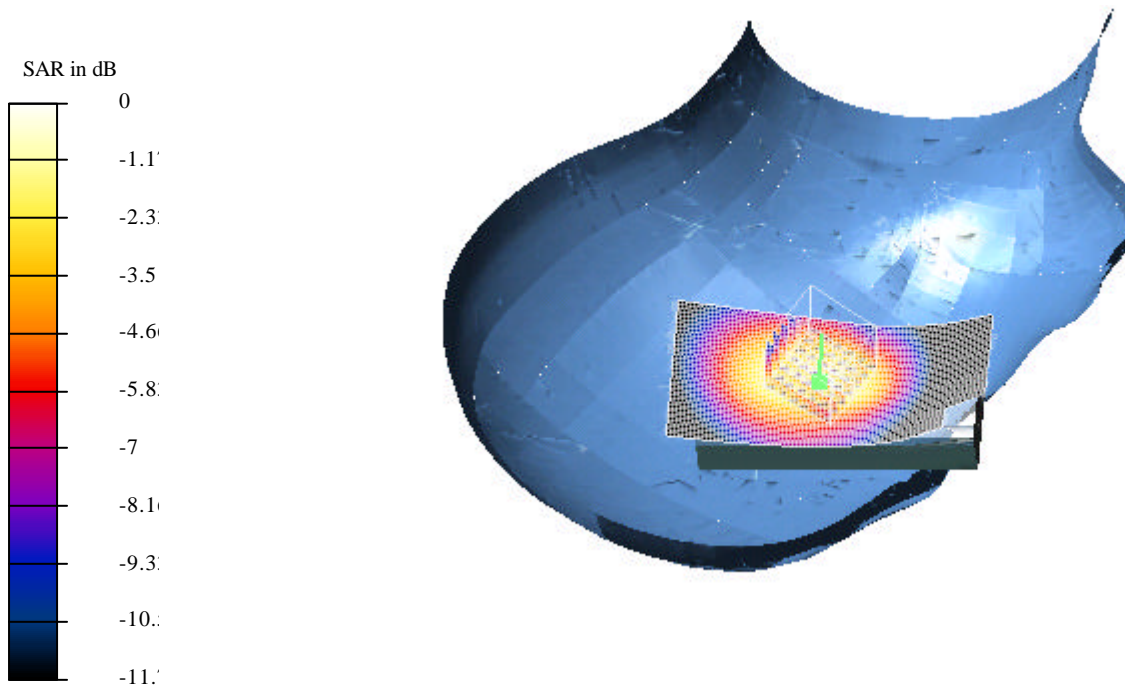

Test Laboratory: ELECTRONIC TECHNOLOGY SYSTEMS DR. GENZ GMBH  
File Name: GSM850\_right\_ch251\_tilted.da4

**DUT: GPRS Dual-Band Type & Serial Number: EB-G60U**  
**Program: GSM; GSM850**

Communication System: GSM 850; Frequency: 848.8 MHz; Duty Cycle: 1:8  
Medium: Head 900 MHz ( $\sigma = 0.92$  mho/m,  $\epsilon = 42.92$ ,  $\rho = 1000$  kg/m<sup>3</sup>)  
Phantom section: RightSection

DASY4 Configuration:

- Probe: ET3DV6 - SN1711; ConvF(6.4, 6.4, 6.4); Calibrated: 11/29/2002
- Sensor-Surface: 4mm (Mechanical Surface Detection)
- Electronics: DAE3 Sn522; Calibrated: 9/11/2002
- Phantom: - TP:
- Software: DASY4, V4.0 Build 51

**Zoom Scan (7x7x7)/Cube 0:** Measurement grid: dx=5mm, dy=5mm

Reference Value = 13.9 V/m

Peak SAR = 0.415 mW/g

SAR(1 g) = 0.292 mW/g; SAR(10 g) = 0.186 mW/g

Power Drift = 0.02 dB

**Area Scan (41x81x1):** Measurement grid: dx=15mm, dy=15mm

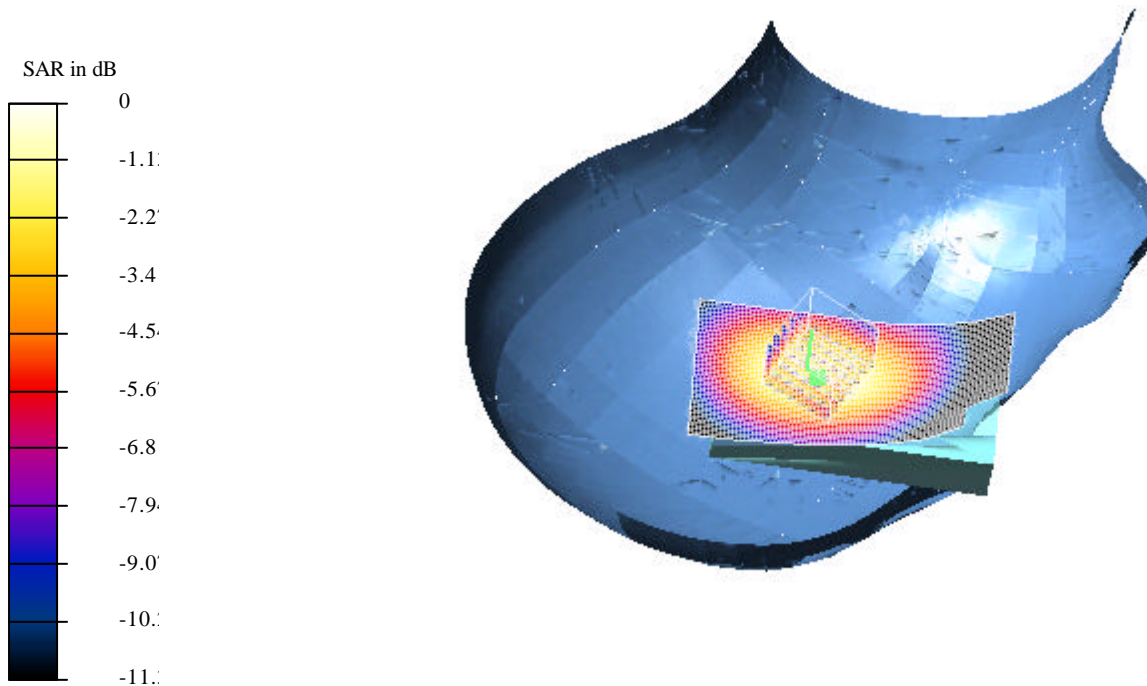



Test Laboratory: ELECTRONIC TECHNOLOGY SYSTEMS DR. GENZ GMBH  
File Name: GSM850\_left\_ch128\_cheek.da4

**DUT: GPRS Dual-Band Type & Serial Number: EB-G60U**  
**Program: GSM; GSM850**

Communication System: GSM 850; Frequency: 824.2 MHz; Duty Cycle: 1:8  
Medium: Head 900 MHz ( $\sigma = 0.9$  mho/m,  $\epsilon = 43.2$ ,  $\rho = 1000$  kg/m<sup>3</sup>)  
Phantom section: LeftSection

DASY4 Configuration:

- Probe: ET3DV6 - SN1711; ConvF(6.4, 6.4, 6.4); Calibrated: 11/29/2002
- Sensor-Surface: 4mm (Mechanical Surface Detection)
- Electronics: DAE3 Sn522; Calibrated: 9/11/2002
- Phantom: - TP:
- Software: DASY4, V4.0 Build 51

**Zoom Scan (7x7x7)/Cube 0:** Measurement grid: dx=5mm, dy=5mm

Reference Value = 19.7 V/m

Peak SAR = 0.604 mW/g

SAR(1 g) = 0.399 mW/g; SAR(10 g) = 0.246 mW/g

Power Drift = 0.01 dB

**Area Scan (71x121x1):** Measurement grid: dx=10mm, dy=10mm

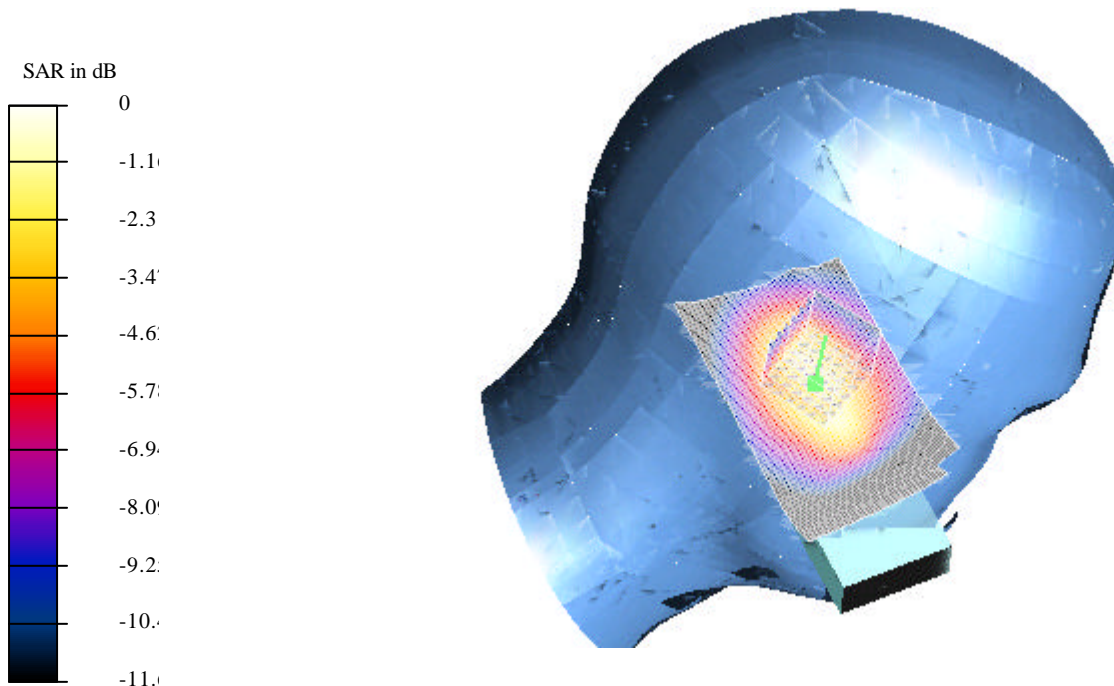

Test Laboratory: ELECTRONIC TECHNOLOGY SYSTEMS DR. GENZ GMBH  
File Name: GSM850\_left\_ch128\_tilted\_2.da4

**DUT: GPRS Dual-Band Type & Serial Number: EB-G60U**  
**Program: GSM; GSM850**

Communication System: GSM 850; Frequency: 824.2 MHz; Duty Cycle: 1:8  
Medium: Head 900 MHz ( $\sigma = 0.9$  mho/m,  $\epsilon = 43.2$ ,  $\rho = 1000$  kg/m<sup>3</sup>)  
Phantom section: LeftSection

DASY4 Configuration:

- Probe: ET3DV6 - SN1711; ConvF(6.4, 6.4, 6.4); Calibrated: 11/29/2002
- Sensor-Surface: 4mm (Mechanical Surface Detection)
- Electronics: DAE3 Sn522; Calibrated: 9/11/2002
- Phantom: - TP:
- Software: DASY4, V4.0 Build 51

**Zoom Scan (7x7x7)/Cube 0:** Measurement grid: dx=5mm, dy=5mm

Reference Value = 13.4 V/m

Peak SAR = 0.206 mW/g

SAR(1 g) = 0.135 mW/g; SAR(10 g) = 0.081 mW/g

Power Drift = -0.007 dB

**Area Scan (61x121x1):** Measurement grid: dx=10mm, dy=10mm

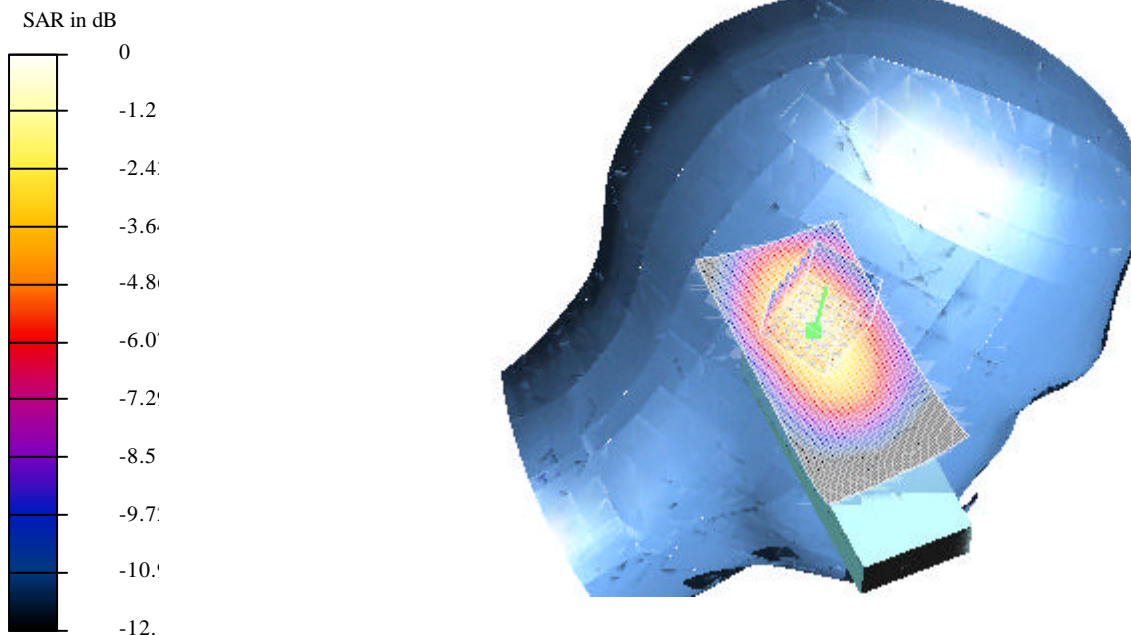

Test Laboratory: ELECTRONIC TECHNOLOGY SYSTEMS DR. GENZ GMBH  
File Name: GSM850\_left\_ch189\_cheek.da4

**DUT: GPRS Dual-Band Type & Serial Number: EB-G60U**  
**Program: GSM; GSM850**

Communication System: GSM 850; Frequency: 836.4 MHz; Duty Cycle: 1:8  
Medium: Head 900 MHz ( $\sigma = 0.9$  mho/m,  $\epsilon = 43.2$ ,  $\rho = 1000$  kg/m<sup>3</sup>)  
Phantom section: LeftSection

DASY4 Configuration:

- Probe: ET3DV6 - SN1711; ConvF(6.4, 6.4, 6.4); Calibrated: 11/29/2002
- Sensor-Surface: 4mm (Mechanical Surface Detection)
- Electronics: DAE3 Sn522; Calibrated: 9/11/2002
- Phantom: - TP:
- Software: DASY4, V4.0 Build 51

**Zoom Scan (7x7x7)/Cube 0:** Measurement grid: dx=5mm, dy=5mm

Reference Value = 16.9 V/m

Peak SAR = 0.376 mW/g

SAR(1 g) = 0.265 mW/g; SAR(10 g) = 0.167 mW/g

Power Drift = -0.01 dB

**Area Scan (71x121x1):** Measurement grid: dx=10mm, dy=10mm

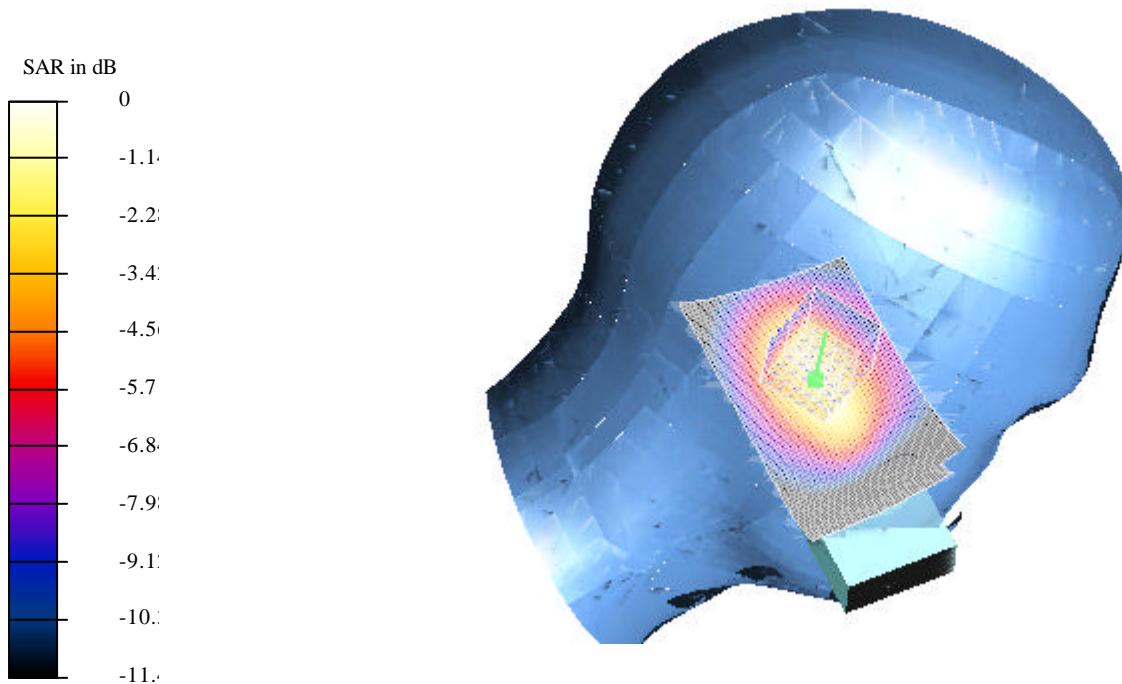

Test Laboratory: ELECTRONIC TECHNOLOGY SYSTEMS DR. GENZ GMBH  
File Name: GSM850\_left\_ch189\_tilted.da4

**DUT: GPRS Dual-Band Type & Serial Number: EB-G60U**  
**Program: GSM; GSM850**

Communication System: GSM 850; Frequency: 836.4 MHz; Duty Cycle: 1:8  
Medium: Head 900 MHz ( $\sigma = 0.9$  mho/m,  $\epsilon = 43.2$ ,  $\rho = 1000$  kg/m<sup>3</sup>)  
Phantom section: LeftSection

DASY4 Configuration:

- Probe: ET3DV6 - SN1711; ConvF(6.4, 6.4, 6.4); Calibrated: 11/29/2002
- Sensor-Surface: 4mm (Mechanical Surface Detection)
- Electronics: DAE3 Sn522; Calibrated: 9/11/2002
- Phantom: - TP:
- Software: DASY4, V4.0 Build 51

**Zoom Scan (7x7x7)/Cube 0:** Measurement grid: dx=5mm, dy=5mm

Reference Value = 12.9 V/m

Peak SAR = 0.194 mW/g

SAR(1 g) = 0.126 mW/g; SAR(10 g) = 0.0761 mW/g

Power Drift = 0.07 dB

**Area Scan (61x121x1):** Measurement grid: dx=10mm, dy=10mm

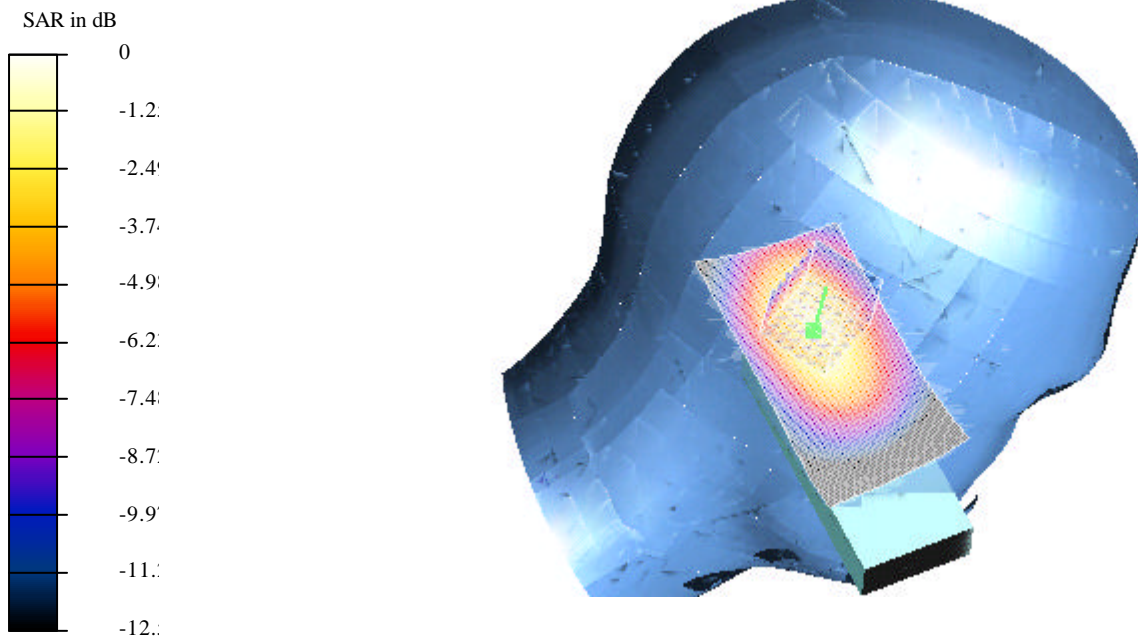

Test Laboratory: ELECTRONIC TECHNOLOGY SYSTEMS DR. GENZ GMBH  
File Name: GSM850\_left\_ch251\_cheek.da4

**DUT: GPRS Dual-Band Type & Serial Number: EB-G60U**  
**Program: GSM; GSM850**

Communication System: GSM 850; Frequency: 848.8 MHz; Duty Cycle: 1:8  
Medium: Head 900 MHz ( $\sigma = 0.92$  mho/m,  $\epsilon = 42.92$ ,  $\rho = 1000$  kg/m<sup>3</sup>)  
Phantom section: LeftSection

DASY4 Configuration:

- Probe: ET3DV6 - SN1711; ConvF(6.4, 6.4, 6.4); Calibrated: 11/29/2002
- Sensor-Surface: 4mm (Mechanical Surface Detection)
- Electronics: DAE3 Sn522; Calibrated: 9/11/2002
- Phantom: - TP:
- Software: DASY4, V4.0 Build 51

**Zoom Scan (7x7x7)/Cube 0:** Measurement grid: dx=5mm, dy=5mm

Reference Value = 18.1 V/m

Peak SAR = 0.457 mW/g

SAR(1 g) = 0.324 mW/g; SAR(10 g) = 0.204 mW/g

Power Drift = -0.0004 dB

**Area Scan (91x161x1):** Measurement grid: dx=10mm, dy=10mm

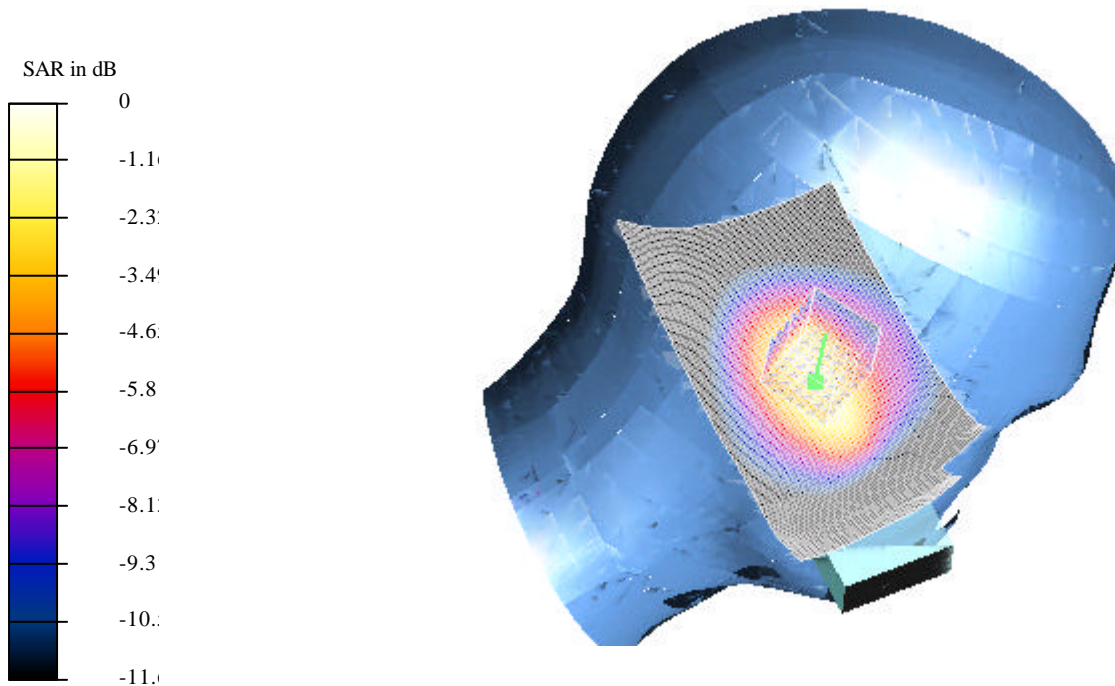



Test Laboratory: ELECTRONIC TECHNOLOGY SYSTEMS DR. GENZ GMBH  
File Name: GSM850\_left\_ch251\_tilted.da4

**DUT: GPRS Dual-Band Type & Serial Number: EB-G60U**  
**Program: GSM; GSM850**

Communication System: GSM 850; Frequency: 848.8 MHz; Duty Cycle: 1:8  
Medium: Head 900 MHz ( $\sigma = 0.92$  mho/m,  $\epsilon = 42.92$ ,  $\rho = 1000$  kg/m<sup>3</sup>)  
Phantom section: LeftSection

DASY4 Configuration:

- Probe: ET3DV6 - SN1711; ConvF(6.4, 6.4, 6.4); Calibrated: 11/29/2002
- Sensor-Surface: 4mm (Mechanical Surface Detection)
- Electronics: DAE3 Sn522; Calibrated: 9/11/2002
- Phantom: - TP:
- Software: DASY4, V4.0 Build 51

**Zoom Scan (7x7x7)/Cube 0:** Measurement grid: dx=5mm, dy=5mm

Reference Value = 13.4 V/m

Peak SAR = 0.229 mW/g

SAR(1 g) = 0.148 mW/g; SAR(10 g) = 0.0883 mW/g

Power Drift = 0.03 dB

**Area Scan (61x121x1):** Measurement grid: dx=10mm, dy=10mm

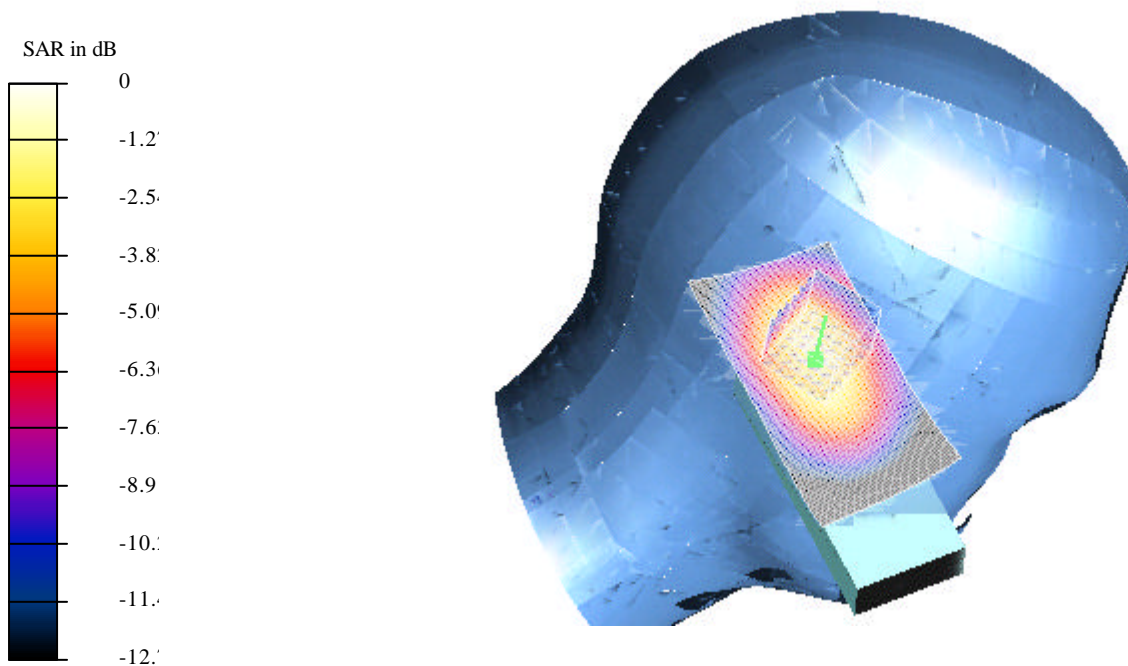

## Z-axis scan at max SAR location

Test Laboratory: ELECTRONIC TECHNOLOGY SYSTEMS DR. GENZ GMBH

**DUT: GPRS Dual-Band Type & Serial Number: EB-G60U**

**Program: GSM; GSM850**

Communication System: GSM 850; Frequency: 848.8 MHz; Duty Cycle: 1:8

Medium: Head 900 MHz ( $\sigma = 0.92$  mho/m,  $\epsilon = 42.92$ ,  $\rho = 1000$  kg/m<sup>3</sup>)

Phantom section: RightSection

DASY4 Configuration:

- Probe: ET3DV6 - SN1711; ConvF(6.4, 6.4, 6.4); Calibrated: 11/29/2002
- Sensor-Surface: 4mm (Mechanical Surface Detection)
- Electronics: DAE3 Sn522; Calibrated: 9/11/2002
- Phantom: - TP:
- Software: DASY4, V4.0 Build 51

**Zoom Scan (7x7x7)/Cube 0:** Measurement grid: dx=5mm, dy=5mm

Reference Value = 15.1 V/m

Peak SAR = 0.823 mW/g

SAR(1 g) = 0.561 mW/g; SAR(10 g) = 0.352 mW/g

Power Drift = -0.08 dB

**Area Scan (41x81x1):** Measurement grid: dx=15mm, dy=15mm

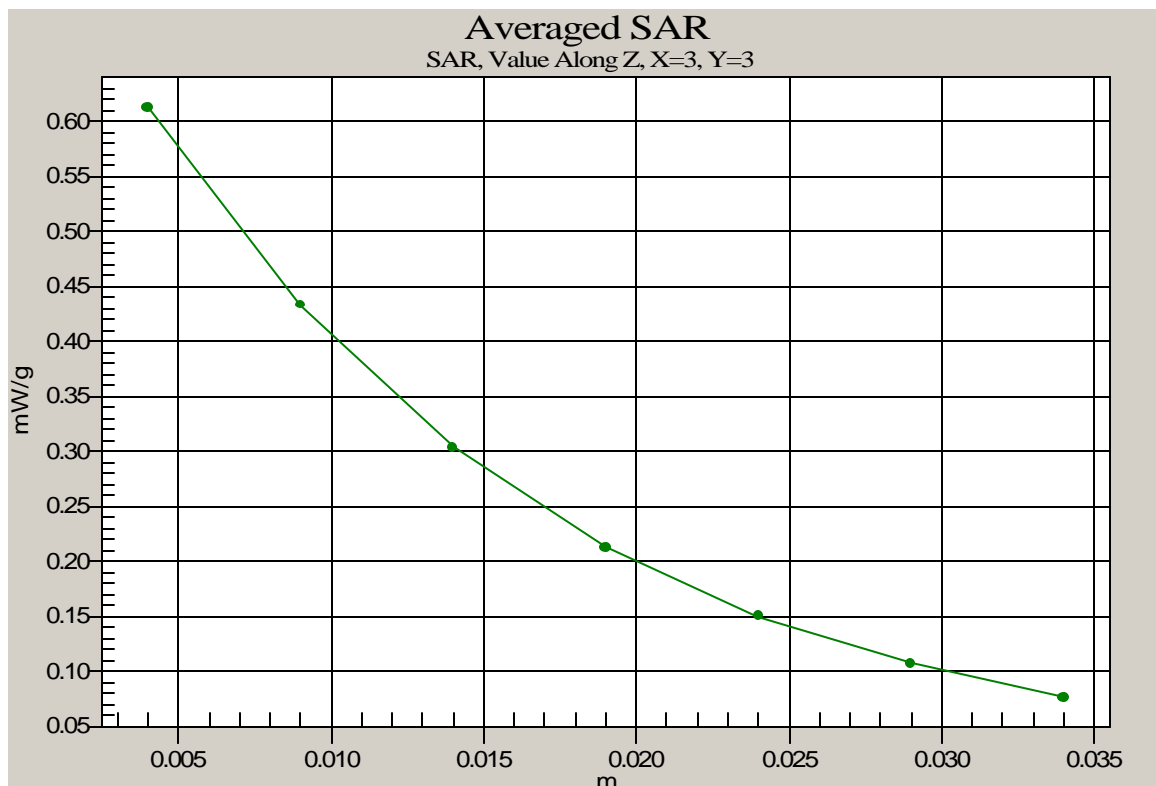

Test Laboratory: ELECTRONIC TECHNOLOGY SYSTEMS DR. GENZ GMBH  
File Name: GSM1900\_right\_ch512\_cheek.da4

**DUT: GPRS Dual-Band Type & Serial Number: EB-G60U**  
**Program: GSM; GSM1900**

Communication System: GSM 1900; Frequency: 1850.2 MHz; Duty Cycle: 1:8  
Medium: Head 1900 MHz ( $\sigma = 1.35$  mho/m,  $\epsilon = 40.5$ ,  $\rho = 1000$  kg/m<sup>3</sup>)  
Phantom section: RightSection

DASY4 Configuration:

- Probe: ET3DV6 - SN1711; ConvF(5.3, 5.3, 5.3); Calibrated: 11/29/2002
- Sensor-Surface: 4mm (Mechanical Surface Detection)
- Electronics: DAE3 Sn522; Calibrated: 9/11/2002
- Phantom: - TP:
- Software: DASY4, V4.0 Build 51

**Zoom Scan (7x7x7)/Cube 0:** Measurement grid: dx=5mm, dy=5mm

Reference Value = 13.0 V/m

Peak SAR = 0.431 mW/g

SAR(1 g) = 0.306 mW/g; SAR(10 g) = 0.183 mW/g

Power Drift = -0.1 dB

**Area Scan (71x121x1):** Measurement grid: dx=10mm, dy=10mm

**Zoom Scan (7x7x7)/Cube 1:** Measurement grid: dx=5mm, dy=5mm

Reference Value = 13.0 V/m

Peak SAR = 0.279 mW/g

SAR(1 g) = 0.198 mW/g; SAR(10 g) = 0.128 mW/g

Power Drift = -0.1 dB

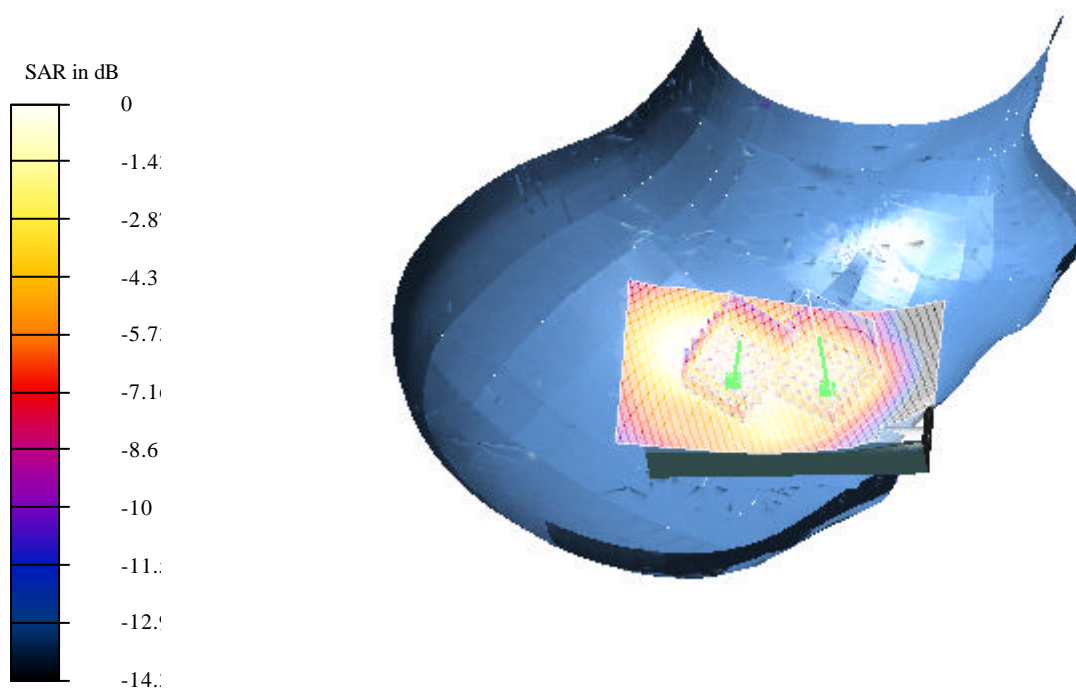



Test Laboratory: ELECTRONIC TECHNOLOGY SYSTEMS DR. GENZ GMBH  
File Name: GSM1900\_right\_ch512\_tilted.da4

**DUT: GPRS Dual-Band Type & Serial Number: EB-G60U**  
**Program: GSM; GSM1900**

Communication System: GSM 1900; Frequency: 1850.2 MHz; Duty Cycle: 1:8  
Medium: Head 1900 MHz ( $\sigma = 1.36$  mho/m,  $\epsilon = 40.4$ ,  $\rho = 1000$  kg/m<sup>3</sup>)  
Phantom section: RightSection

DASY4 Configuration:

- Probe: ET3DV6 - SN1711; ConvF(5.3, 5.3, 5.3); Calibrated: 11/29/2002
- Sensor-Surface: 4mm (Mechanical Surface Detection)
- Electronics: DAE3 Sn522; Calibrated: 9/11/2002
- Phantom: - TP:
- Software: DASY4, V4.0 Build 51

**Zoom Scan (7x7x7)/Cube 0:** Measurement grid: dx=5mm, dy=5mm

Reference Value = 14,5 V/m

Peak SAR = 0.48 mW/g

SAR(1 g) = 0.296 mW/g; SAR(10 g) = 0.176 mW/g

Power Drift = -0.04 dB

**Area Scan (71x121x1):** Measurement grid: dx=10mm, dy=10mm

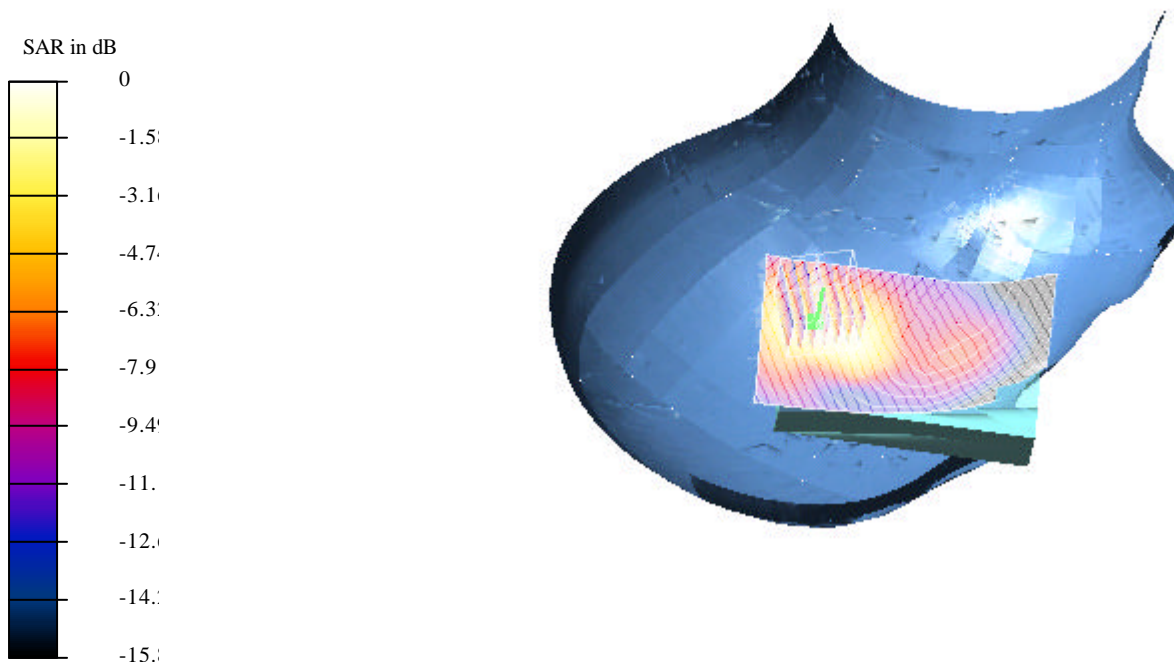

Test Laboratory: ELECTRONIC TECHNOLOGY SYSTEMS DR. GENZ GMBH  
File Name: GSM1900\_right\_ch661\_cheek.da4

**DUT: GPRS Dual-Band Type & Serial Number: EB-G60U**  
**Program: GSM; GSM1900**

Communication System: GSM 1900; Frequency: 1880 MHz; Duty Cycle: 1:8  
Medium: Head 1900 MHz ( $\sigma = 1.38$  mho/m,  $\epsilon = 40.2$ ,  $\rho = 1000$  kg/m<sup>3</sup>)  
Phantom section: RightSection

DASY4 Configuration:

- Probe: ET3DV6 - SN1711; ConvF(5.3, 5.3, 5.3); Calibrated: 11/29/2002
- Sensor-Surface: 4mm (Mechanical Surface Detection)
- Electronics: DAE3 Sn522; Calibrated: 9/11/2002
- Phantom: - TP:
- Software: DASY4, V4.0 Build 51

**Zoom Scan (7x7x7)/Cube 0:** Measurement grid: dx=5mm, dy=5mm

Reference Value = 16,53 V/m

Peak SAR = 0.629 mW/g

SAR(1 g) = 0.403 mW/g; SAR(10 g) = 0.253 mW/g

Power Drift = -0.06 dB

**Area Scan (71x121x1):** Measurement grid: dx=10mm, dy=10mm

**Zoom Scan (7x7x7)/Cube 1:** Measurement grid: dx=5mm, dy=5mm

Reference Value = 16,53 V/m

Peak SAR = 0.426 mW/g

SAR(1 g) = 0.230 mW/g; SAR(10 g) = 0.188 mW/g

Power Drift = -0.06 dB

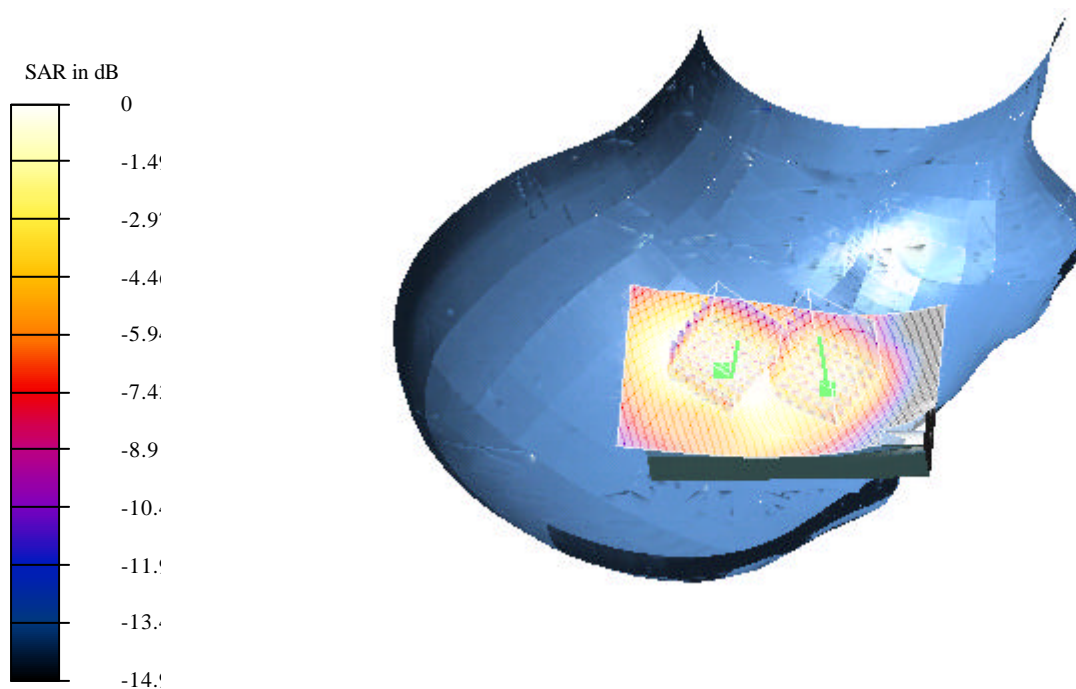

Test Laboratory: ELECTRONIC TECHNOLOGY SYSTEMS DR. GENZ GMBH  
File Name: GSM1900\_right\_ch661\_tilted.da4

**DUT: GPRS Dual-Band Type & Serial Number: EB-G60U**  
**Program: GSM; GSM1900**

Communication System: GSM 1900; Frequency: 1880 MHz; Duty Cycle: 1:8  
Medium: Head 1900 MHz ( $\sigma = 1.38$  mho/m,  $\epsilon = 40.2$ ,  $\rho = 1000$  kg/m<sup>3</sup>)  
Phantom section: RightSection

DASY4 Configuration:

- Probe: ET3DV6 - SN1711; ConvF(5.3, 5.3, 5.3); Calibrated: 11/29/2002
- Sensor-Surface: 4mm (Mechanical Surface Detection)
- Electronics: DAE3 Sn522; Calibrated: 9/11/2002
- Phantom: - TP:
- Software: DASY4, V4.0 Build 51

**Zoom Scan (7x7x7)/Cube 0:** Measurement grid: dx=5mm, dy=5mm

Reference Value = 19,1 V/m

Peak SAR = 0.794 mW/g

SAR(1 g) = 0.481 mW/g; SAR(10 g) = 0.273 mW/g

Power Drift = -0.04 dB

**Area Scan (71x121x1):** Measurement grid: dx=10mm, dy=10mm

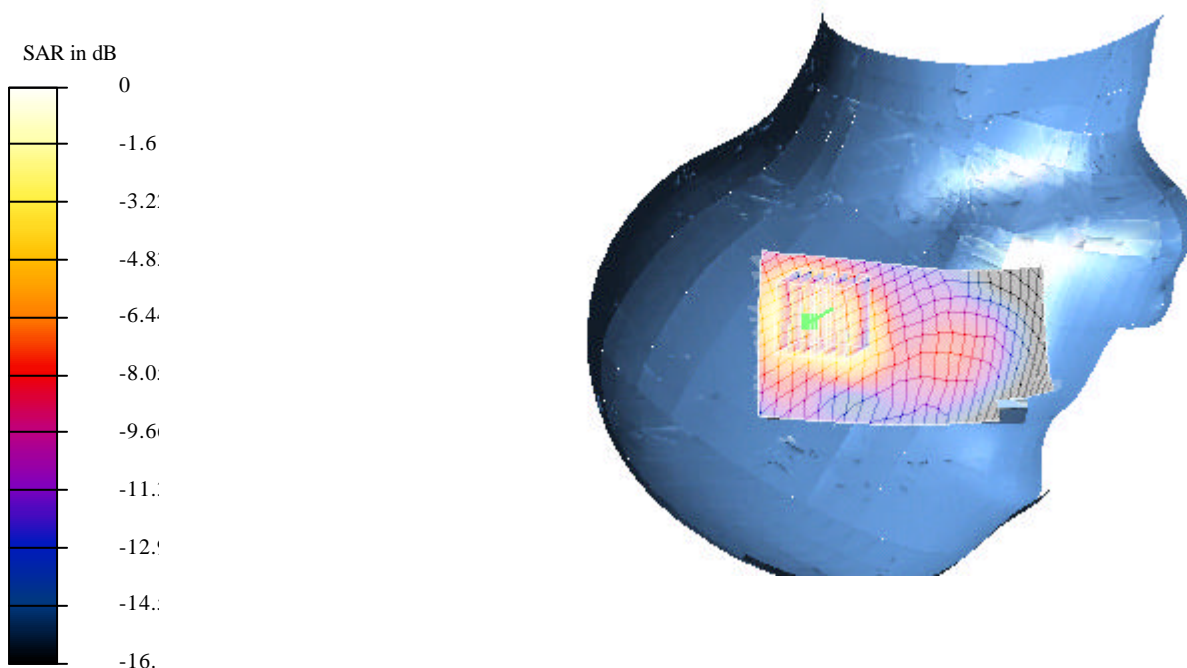

Test Laboratory: ELECTRONIC TECHNOLOGY SYSTEMS DR. GENZ GMBH  
File Name: GSM1900\_right\_ch810\_cheek.da4

**DUT: GPRS Dual-Band Type & Serial Number: EB-G60U**  
**Program: GSM; GSM1900**

Communication System: GSM 1900; Frequency: 1909.8 MHz; Duty Cycle: 1:8  
Medium: Head 1900 MHz ( $\sigma = 1.41$  mho/m,  $\epsilon = 40.1$ ,  $\rho = 1000$  kg/m<sup>3</sup>)  
Phantom section: RightSection

DASY4 Configuration:

- Probe: ET3DV6 - SN1711; ConvF(5.3, 5.3, 5.3); Calibrated: 11/29/2002
- Sensor-Surface: 4mm (Mechanical Surface Detection)
- Electronics: DAE3 Sn522; Calibrated: 9/11/2002
- Phantom: - TP:
- Software: DASY4, V4.0 Build 51

**Zoom Scan (7x7x7)/Cube 1:** Measurement grid: dx=5mm, dy=5mm

Reference Value = 15.2 V/m

Peak SAR = 0.425 mW/g

SAR(1 g) = 0.289 mW/g; SAR(10 g) = 0.172 mW/g

Power Drift = 0.01 dB

**Area Scan (71x121x1):** Measurement grid: dx=10mm, dy=10mm

**Zoom Scan (7x7x7)/Cube 0:** Measurement grid: dx=5mm, dy=5mm

Reference Value = 15.2 V/m

Peak SAR = 0.559 mW/g

SAR(1 g) = 0.343 mW/g; SAR(10 g) = 0.207 mW/g

Power Drift = 0.01 dB

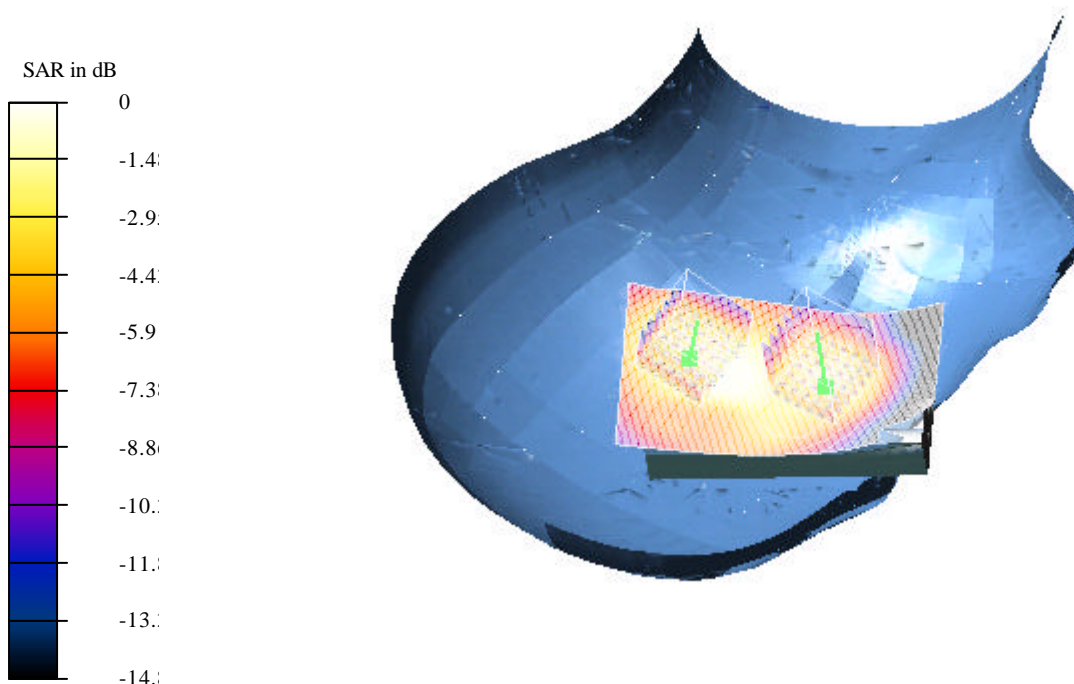

Test Laboratory: ELECTRONIC TECHNOLOGY SYSTEMS DR. GENZ GMBH  
File Name: GSM1900\_right\_ch810\_tilted.da4

**DUT: GPRS Dual-Band Type & Serial Number: EB-G60U**  
**Program: GSM; GSM1900**

Communication System: GSM 1900; Frequency: 1909.8 MHz; Duty Cycle: 1:8  
Medium: Head 1900 MHz ( $\sigma = 1.41$  mho/m,  $\epsilon = 40.1$ ,  $\rho = 1000$  kg/m<sup>3</sup>)  
Phantom section: RightSection

DASY4 Configuration:

- Probe: ET3DV6 - SN1711; ConvF(5.3, 5.3, 5.3); Calibrated: 11/29/2002
- Sensor-Surface: 4mm (Mechanical Surface Detection)
- Electronics: DAE3 Sn522; Calibrated: 9/11/2002
- Phantom: - TP:
- Software: DASY4, V4.0 Build 51

**Area Scan (71x121x1):** Measurement grid: dx=10mm, dy=10mm  
**Zoom Scan (7x7x7)/Cube 0:** Measurement grid: dx=5mm, dy=5mm  
Reference Value = 19.4 V/m  
Peak SAR = 0.819 mW/g  
SAR(1 g) = 0.471 mW/g; SAR(10 g) = 0.257 mW/g  
Power Drift = -0.03 dB

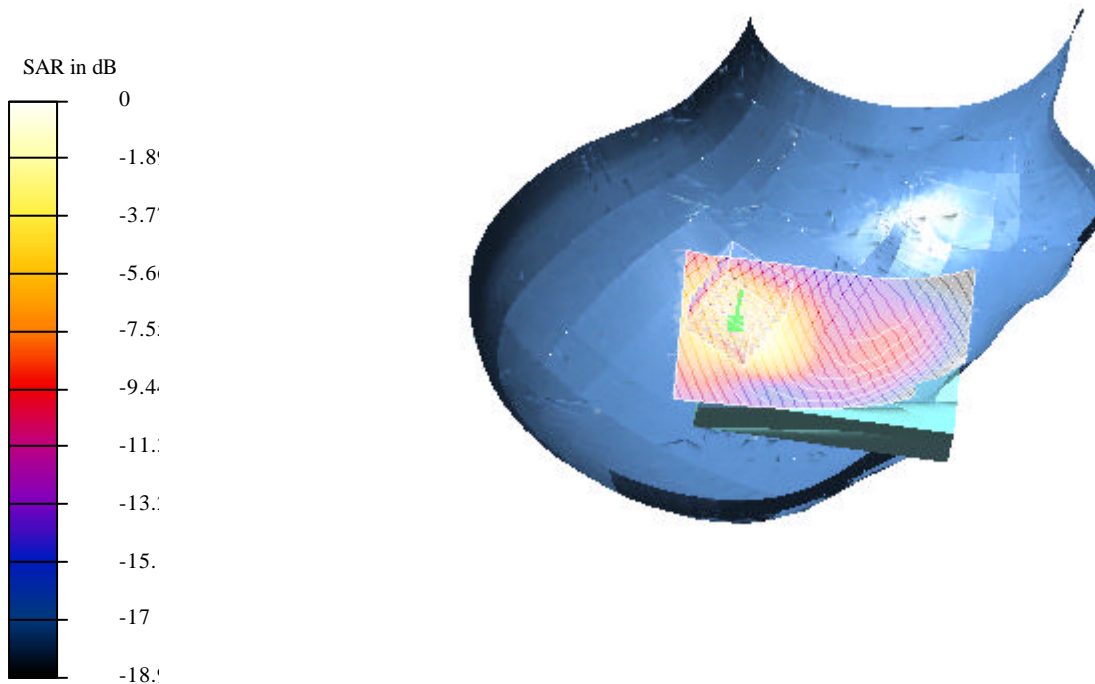

Test Laboratory: ELECTRONIC TECHNOLOGY SYSTEMS DR. GENZ GMBH  
File Name: GSM1900\_left\_ch512\_cheek.da4

**DUT: GPRS Dual-Band Type & Serial Number: EB-G60U**  
**Program: GSM; GSM1900**

Communication System: GSM 1900; Frequency: 1850.2 MHz; Duty Cycle: 1:8  
Medium: Head 1900 MHz ( $\sigma = 1.35$  mho/m,  $\epsilon = 40.5$ ,  $\rho = 1000$  kg/m<sup>3</sup>)  
Phantom section: LeftSection

DASY4 Configuration:

- Probe: ET3DV6 - SN1711; ConvF(5.3, 5.3, 5.3); Calibrated: 11/29/2002
- Sensor-Surface: 4mm (Mechanical Surface Detection)
- Electronics: DAE3 Sn522; Calibrated: 9/11/2002
- Phantom: - TP:
- Software: DASY4, V4.0 Build 51

**Zoom Scan (7x7x7)/Cube 0:** Measurement grid: dx=5mm, dy=5mm

Reference Value = 12.3 V/m

Peak SAR = 0.638 mW/g

SAR(1 g) = 0.406 mW/g; SAR(10 g) = 0.237 mW/g

Power Drift = 0.004 dB

**Area Scan (71x121x1):** Measurement grid: dx=10mm, dy=10mm

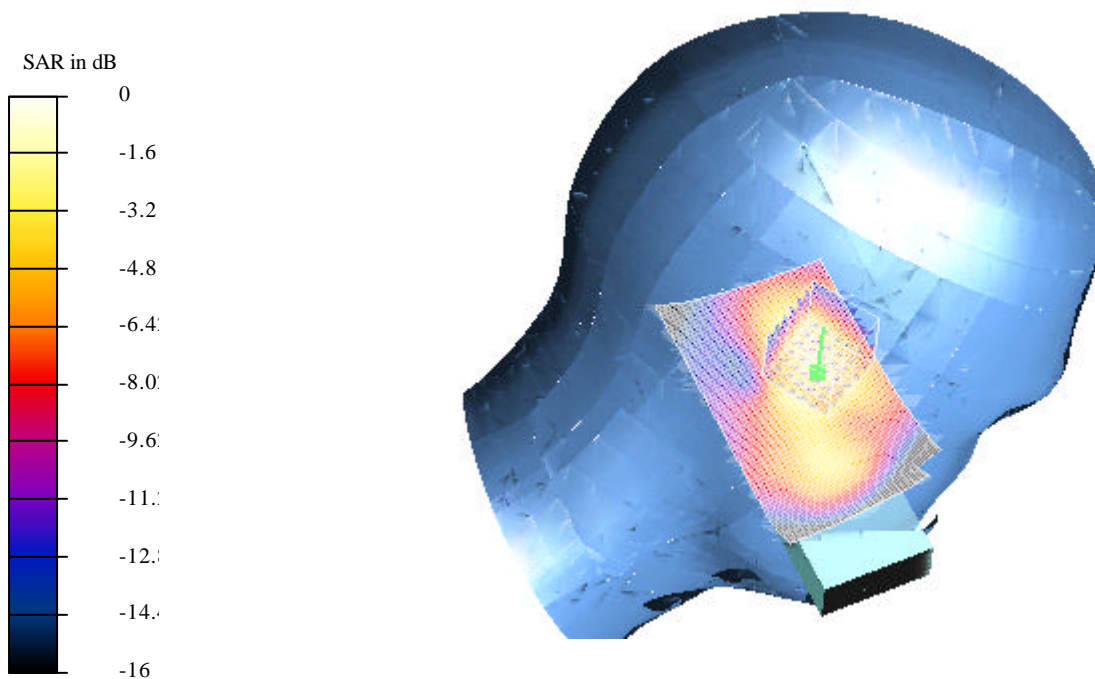



Test Laboratory: ELECTRONIC TECHNOLOGY SYSTEMS DR. GENZ GMBH  
File Name: GSM1900\_left\_ch512\_tilted.da4

**DUT: GPRS Dual-Band Type & Serial Number: EB-G60U**  
**Program: GSM; GSM1900**

Communication System: GSM 1900; Frequency: 1850.2 MHz; Duty Cycle: 1:8  
Medium: Head 1900 MHz ( $\sigma = 1.35$  mho/m,  $\epsilon = 40.5$ ,  $\rho = 1000$  kg/m<sup>3</sup>)  
Phantom section: LeftSection

DASY4 Configuration:

- Probe: ET3DV6 - SN1711; ConvF(5.3, 5.3, 5.3); Calibrated: 11/29/2002
- Sensor-Surface: 4mm (Mechanical Surface Detection)
- Electronics: DAE3 Sn522; Calibrated: 9/11/2002
- Phantom: - TP:
- Software: DASY4, V4.0 Build 51

**Zoom Scan (7x7x7)/Cube 0:** Measurement grid: dx=5mm, dy=5mm

Reference Value = 13.3 V/m

Peak SAR = 0.605 mW/g

SAR(1 g) = 0.351 mW/g; SAR(10 g) = 0.196 mW/g

Power Drift = -0.04 dB

**Area Scan (71x101x1):** Measurement grid: dx=10mm, dy=10mm

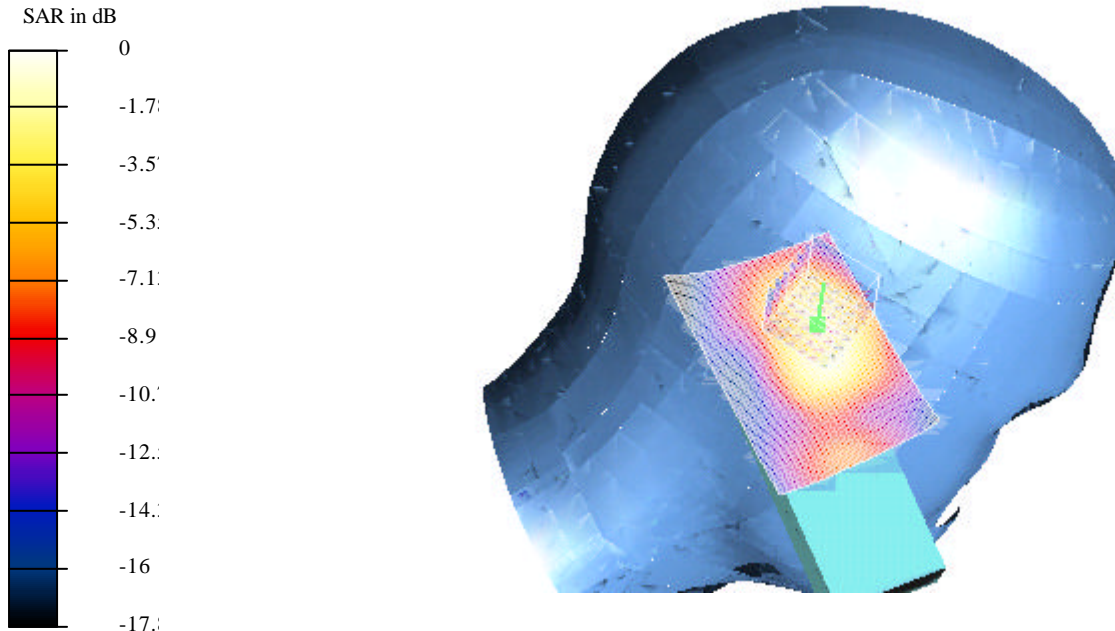

Test Laboratory: ELECTRONIC TECHNOLOGY SYSTEMS DR. GENZ GMBH  
File Name: GSM1900\_left\_ch661\_cheek.da4

**DUT: GPRS Dual-Band Type & Serial Number: EB-G60U**  
**Program: GSM; GSM1900**

Communication System: GSM 1900; Frequency: 1880 MHz; Duty Cycle: 1:8  
Medium: Head 1900 MHz ( $\sigma = 1.37$  mho/m,  $\epsilon = 40.3$ ,  $\rho = 1000$  kg/m<sup>3</sup>)  
Phantom section: LeftSection

DASY4 Configuration:

- Probe: ET3DV6 - SN1711; ConvF(5.3, 5.3, 5.3); Calibrated: 11/29/2002
- Sensor-Surface: 4mm (Mechanical Surface Detection)
- Electronics: DAE3 Sn522; Calibrated: 9/11/2002
- Phantom: - TP:
- Software: DASY4, V4.0 Build 51

**Zoom Scan (7x7x7)/Cube 0:** Measurement grid: dx=5mm, dy=5mm

Reference Value = 15.7 V/m

Peak SAR = 0.830 mW/g

SAR(1 g) = 0.485 mW/g; SAR(10 g) = 0.281 mW/g

Power Drift = -0.04 dB

**Area Scan (71x121x1):** Measurement grid: dx=10mm, dy=10mm

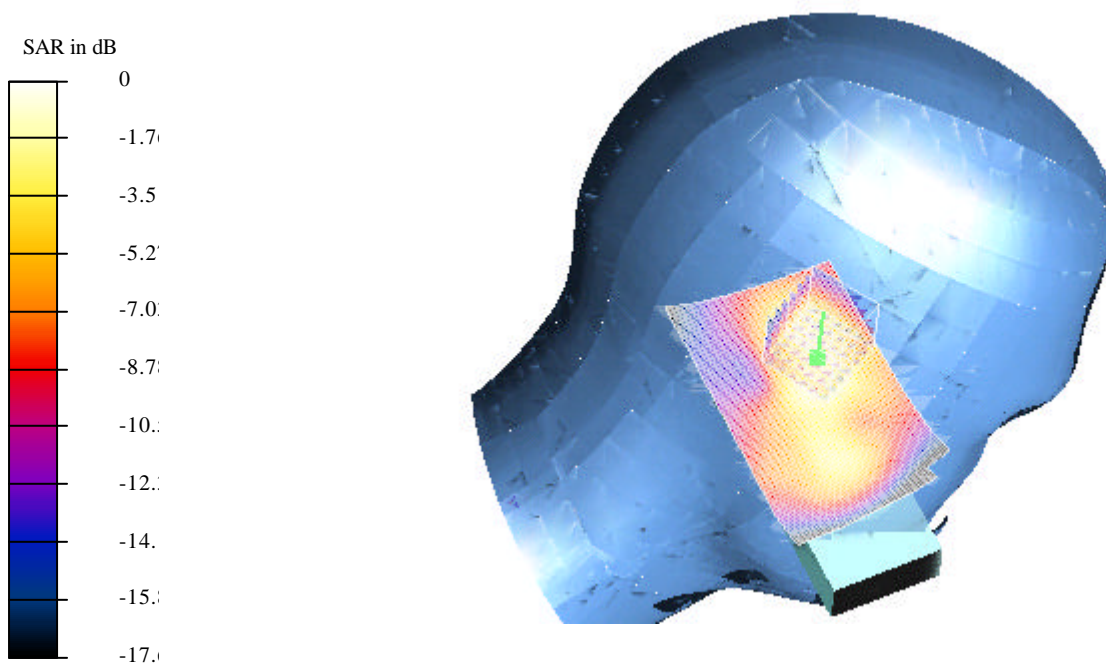



Test Laboratory: ELECTRONIC TECHNOLOGY SYSTEMS DR. GENZ GMBH  
File Name: GSM1900\_left\_ch661\_tilted.da4

**DUT: GPRS Dual-Band Type & Serial Number: EB-G60U**  
**Program: GSM; GSM1900**

Communication System: GSM 1900; Frequency: 1880 MHz; Duty Cycle: 1:8  
Medium: Head 1900 MHz ( $\sigma = 1.37$  mho/m,  $\epsilon = 40.3$ ,  $\rho = 1000$  kg/m<sup>3</sup>)  
Phantom section: LeftSection

DASY4 Configuration:

- Probe: ET3DV6 - SN1711; ConvF(5.3, 5.3, 5.3); Calibrated: 11/29/2002
- Sensor-Surface: 4mm (Mechanical Surface Detection)
- Electronics: DAE3 Sn522; Calibrated: 9/11/2002
- Phantom: - TP:
- Software: DASY4, V4.0 Build 51

**Zoom Scan (7x7x7)/Cube 0:** Measurement grid: dx=5mm, dy=5mm

Reference Value = 17.6 V/m

Peak SAR = 0.92 mW/g

SAR(1 g) = 0.521 mW/g; SAR(10 g) = 0.281 mW/g

Power Drift = -0.04 dB

**Area Scan (71x101x1):** Measurement grid: dx=10mm, dy=10mm

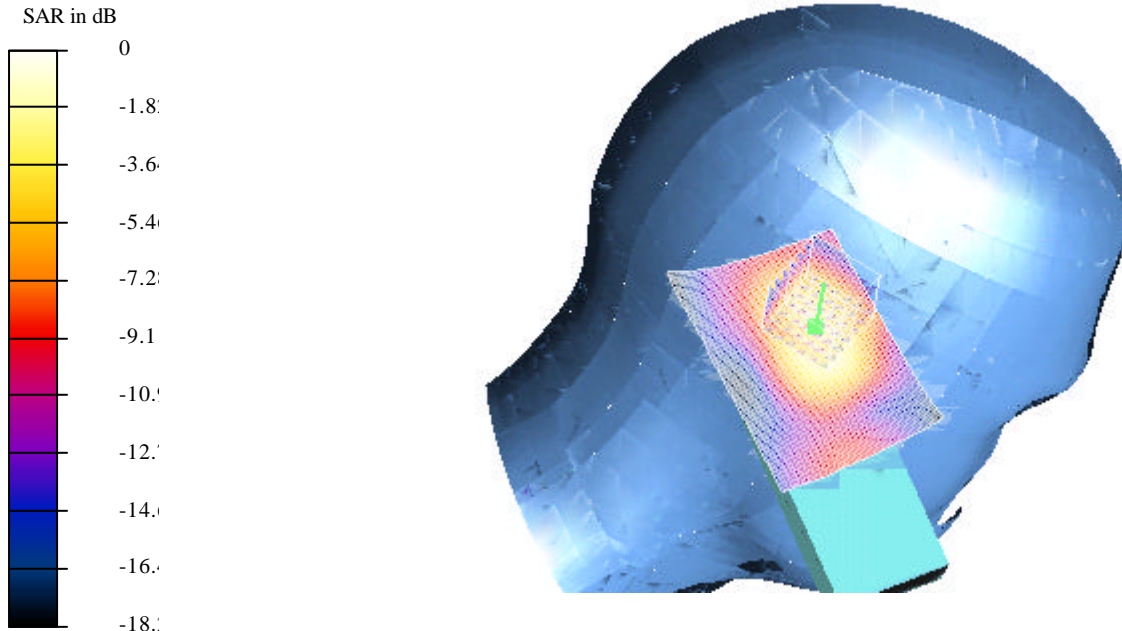

Test Laboratory: ELECTRONIC TECHNOLOGY SYSTEMS DR. GENZ GMBH  
File Name: GSM1900\_left\_ch810\_cheek.da4

**DUT: GPRS Dual-Band Type & Serial Number: EB-G60U**  
**Program: GSM; GSM1900**

Communication System: GSM 1900; Frequency: 1909.8 MHz; Duty Cycle: 1:8  
Medium: Head 1900 MHz ( $\sigma = 1.4 \text{ mho/m}$ ,  $\epsilon = 40.2$ ,  $\rho = 1000 \text{ kg/m}^3$ )  
Phantom section: LeftSection

DASY4 Configuration:

- Probe: ET3DV6 - SN1711; ConvF(5.3, 5.3, 5.3); Calibrated: 11/29/2002
- Sensor-Surface: 4mm (Mechanical Surface Detection)
- Electronics: DAE3 Sn522; Calibrated: 9/11/2002
- Phantom: - TP:
- Software: DASY4, V4.0 Build 51

**Zoom Scan (7x7x7)/Cube 0:** Measurement grid: dx=5mm, dy=5mm

Reference Value = 15.2 V/m

Peak SAR = 1.06 mW/g

SAR(1 g) = 0.519 mW/g; SAR(10 g) = 0.277 mW/g

Power Drift = 0.02 dB

**Area Scan (71x121x1):** Measurement grid: dx=10mm, dy=10mm

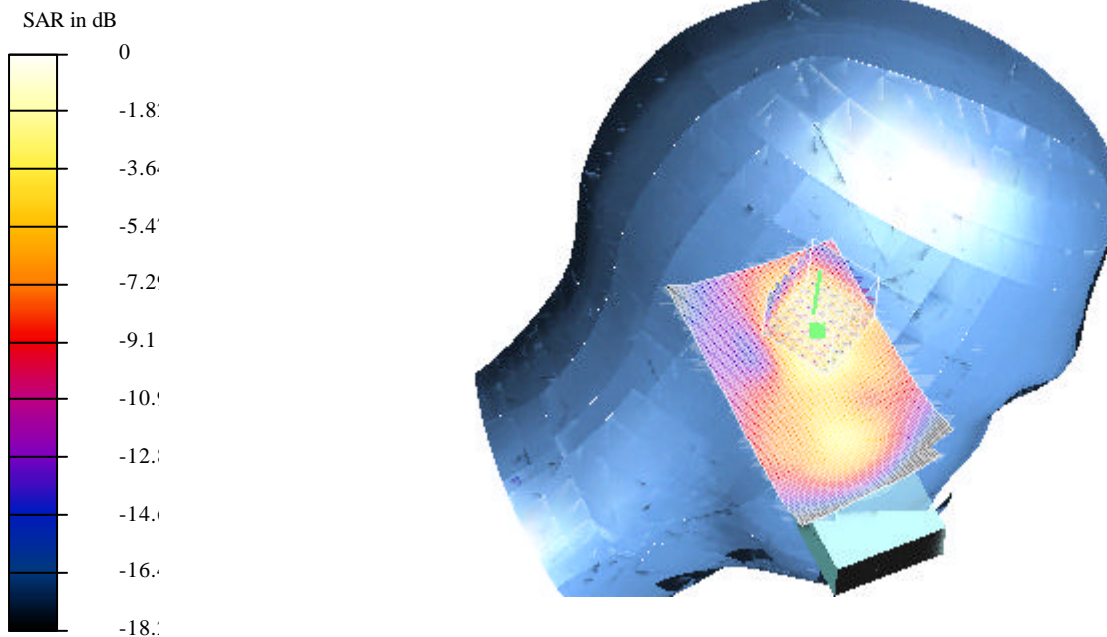

Test Laboratory: ELECTRONIC TECHNOLOGY SYSTEMS DR. GENZ GMBH  
File Name: GSM1900\_left\_ch810\_tilted.da4

**DUT: GPRS Dual-Band Type & Serial Number: EB-G60U**  
**Program: GSM; GSM1900**

Communication System: GSM 1900; Frequency: 1909.8 MHz; Duty Cycle: 1:8  
Medium: Head 1900 MHz ( $\sigma = 1.4 \text{ mho/m}$ ,  $\epsilon = 40.2$ ,  $\rho = 1000 \text{ kg/m}^3$ )  
Phantom section: LeftSection

DASY4 Configuration:

- Probe: ET3DV6 - SN1711; ConvF(5.3, 5.3, 5.3); Calibrated: 11/29/2002
- Sensor-Surface: 4mm (Mechanical Surface Detection)
- Electronics: DAE3 Sn522; Calibrated: 9/11/2002
- Phantom: - TP:
- Software: DASY4, V4.0 Build 51

**Zoom Scan (7x7x7)/Cube 0:** Measurement grid: dx=5mm, dy=5mm

Reference Value = 17.6 V/m

Peak SAR = 0.98 mW/g

SAR(1 g) = 0.522 mW/g; SAR(10 g) = 0.273 mW/g

Power Drift = -0.003 dB

**Area Scan (71x101x1):** Measurement grid: dx=10mm, dy=10mm

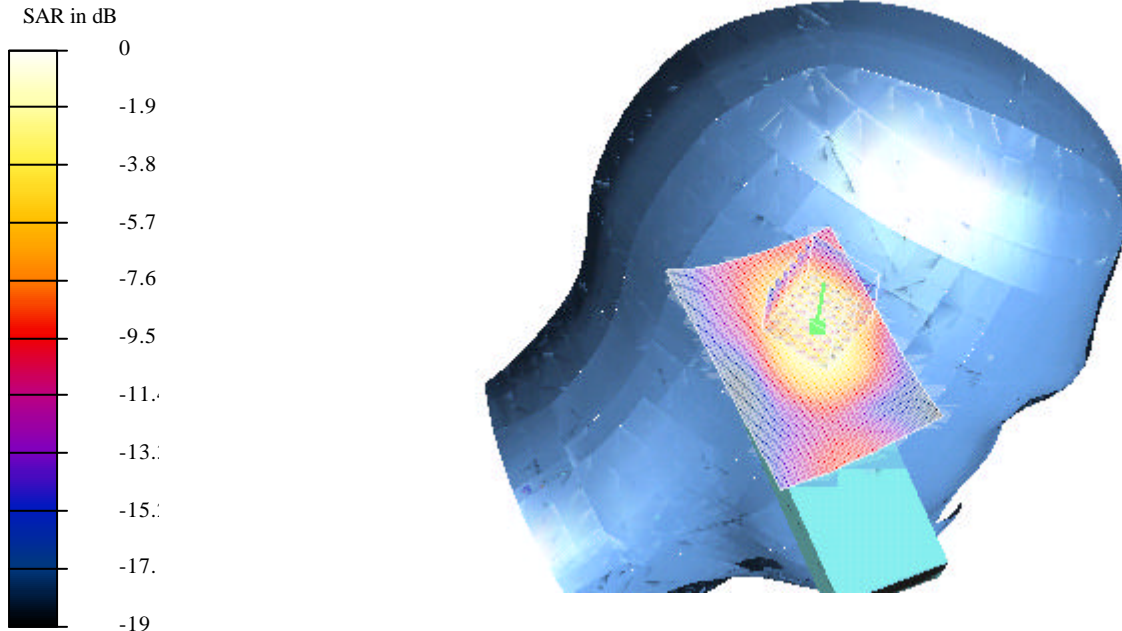

## Z-axis scan at max SAR location

Test Laboratory: ELECTRONIC TECHNOLOGY SYSTEMS DR. GENZ GMBH

**DUT: GPRS Dual-Band Type & Serial Number: EB-G60U**

**Program: GSM; GSM1900**

Communication System: GSM 1900; Frequency: 1909.8 MHz; Duty Cycle: 1:8

Medium: Head 1900 MHz ( $\sigma = 1.4$  mho/m,  $\epsilon = 40.2$ ,  $\rho = 1000$  kg/m<sup>3</sup>)

Phantom section: LeftSection

DASY4 Configuration:

- Probe: ET3DV6 - SN1711; ConvF(5.3, 5.3, 5.3); Calibrated: 11/29/2002
- Sensor-Surface: 4mm (Mechanical Surface Detection)
- Electronics: DAE3 Sn522; Calibrated: 9/11/2002
- Phantom: - TP:
- Software: DASY4, V4.0 Build 51

**Zoom Scan (7x7x7)/Cube 0:** Measurement grid: dx=5mm, dy=5mm

Reference Value = 17.6 V/m

Peak SAR = 0.98 mW/g

SAR(1 g) = 0.522 mW/g; SAR(10 g) = 0.273 mW/g

Power Drift = -0.003 dB

**Area Scan (71x101x1):** Measurement grid: dx=10mm, dy=10mm

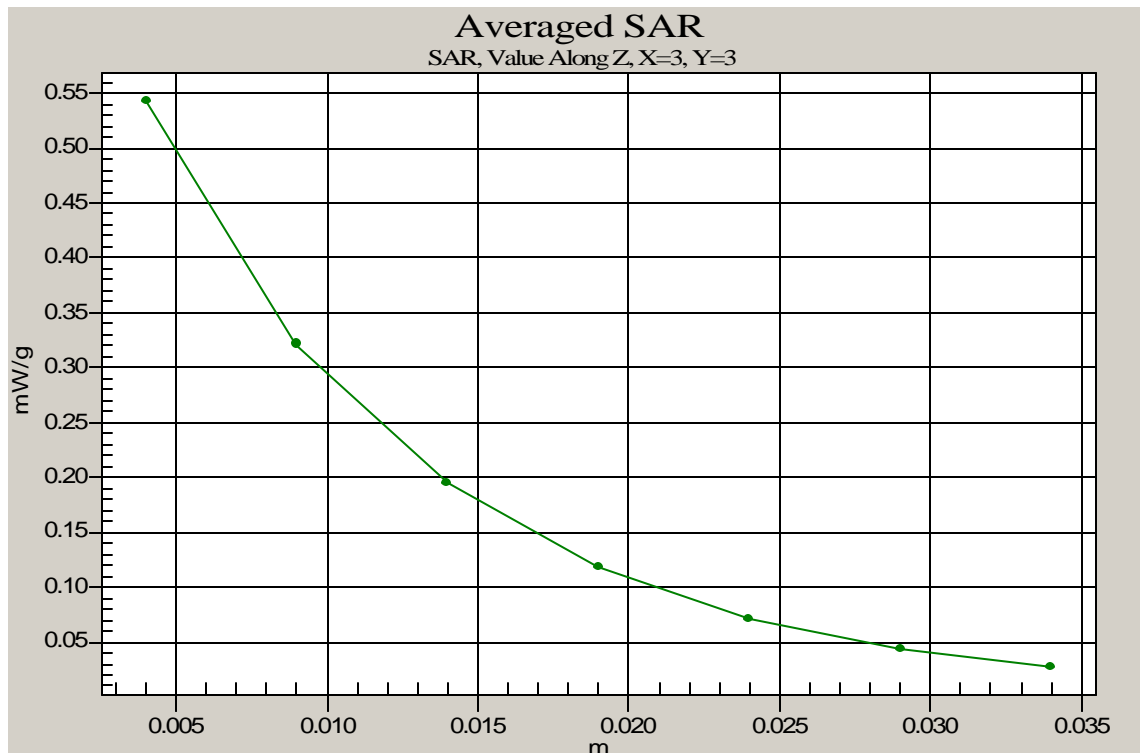



## Appendix C

### Pictures

## Appendix

### C. Pictures



---

REGISTRATION NUMBER: G6D203010016-T-28

---





---

REGISTRATION NUMBER: G6D203010016-T-28

---

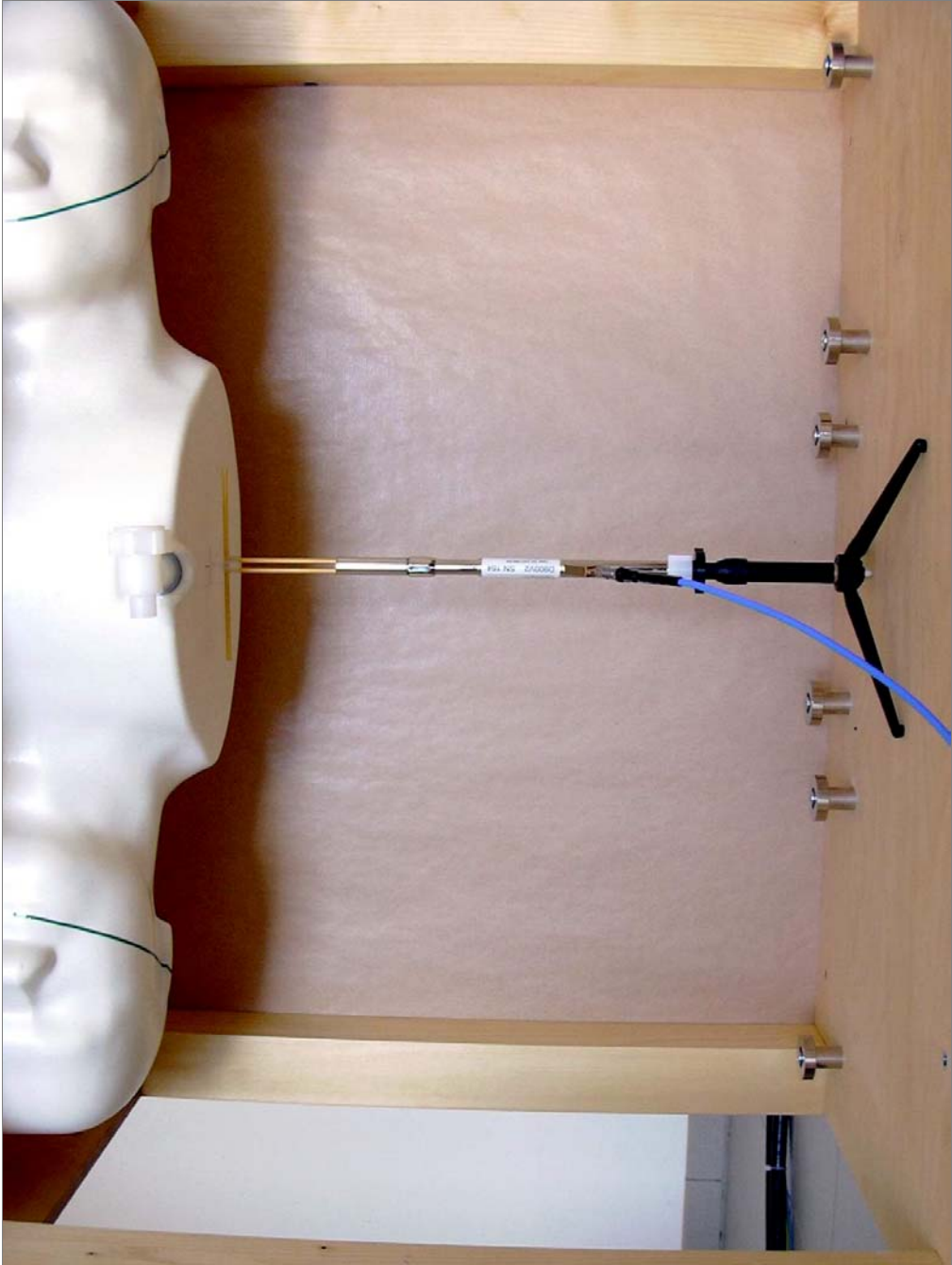

---

REGISTRATION NUMBER: G6D203010016-T-28

---



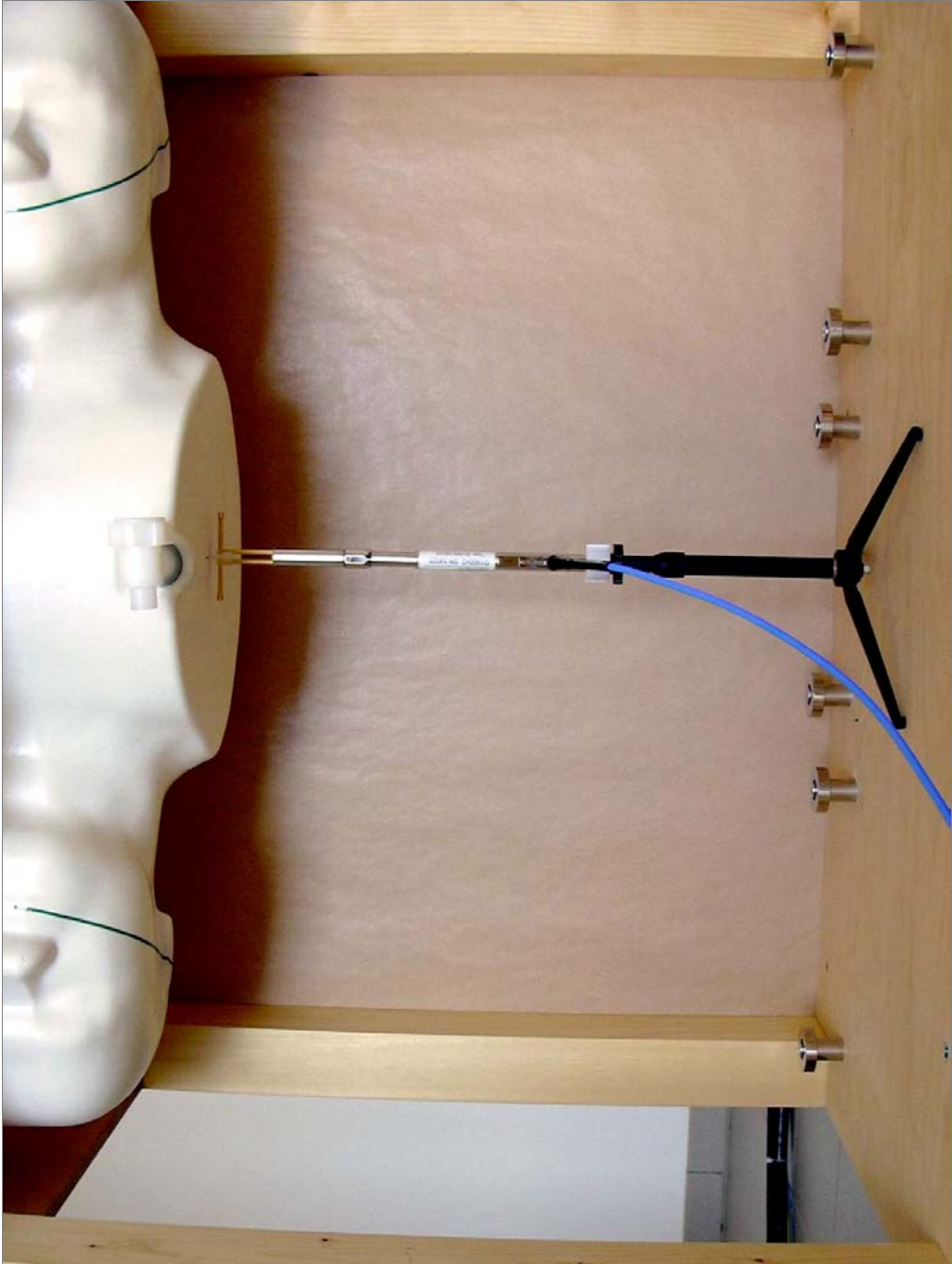

---

REGISTRATION NUMBER: G6D203010016-T-28

---

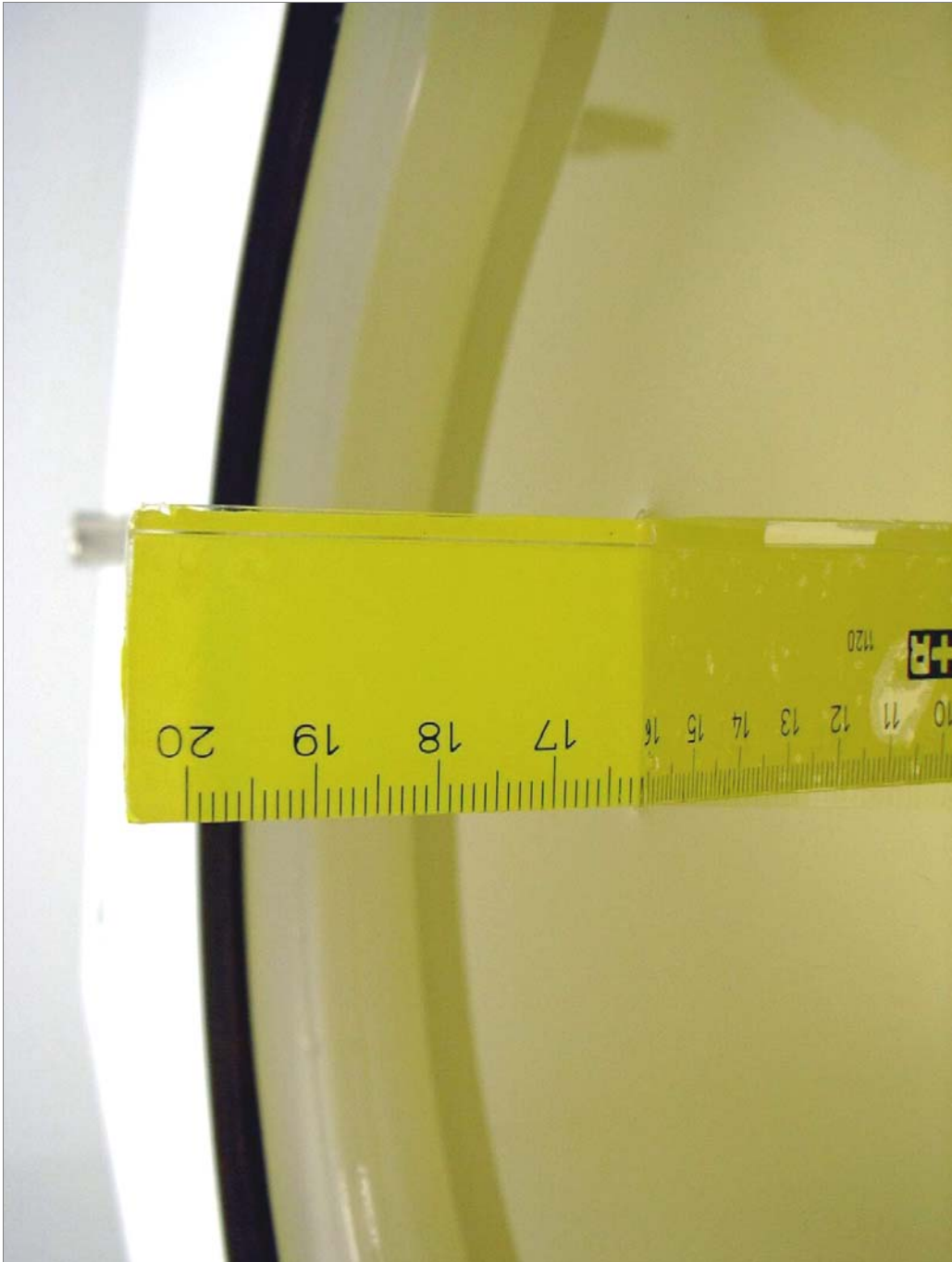

---

REGISTRATION NUMBER: G6D203010016-T-28

---



---

REGISTRATION NUMBER: G6D203010016-T-28

---



---

REGISTRATION NUMBER: G6D203010016-T-28

---



---

REGISTRATION NUMBER: G6D203010016-T-28

---



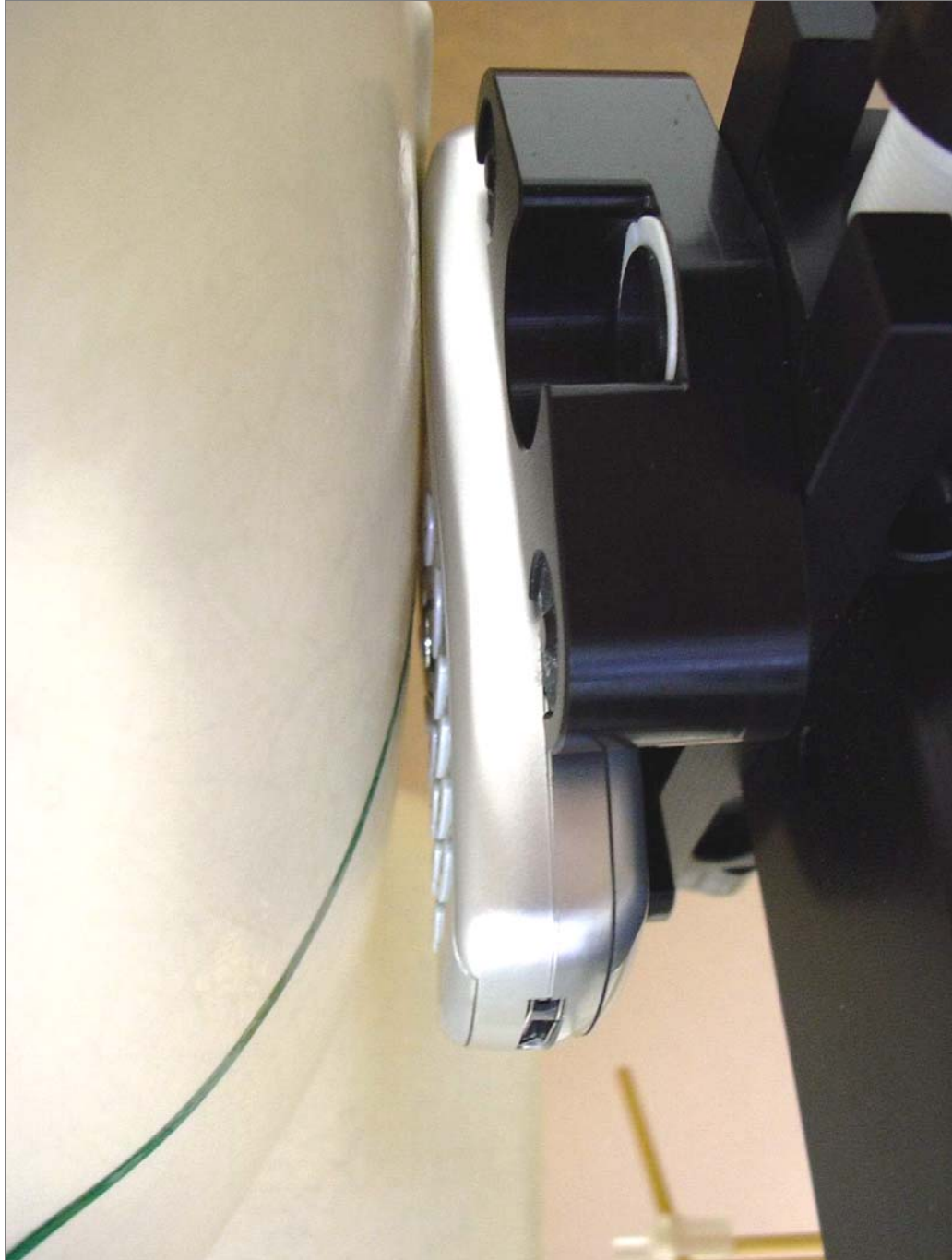

---

REGISTRATION NUMBER: G6D203010016-T-28

---



---

REGISTRATION NUMBER: G6D203010016-T-28

---