

MFA **M. Flom Associates, Inc. - Global Compliance Center**
3356 North San Marcos Place, Suite 107, Chandler, Arizona 85225-7176
www.mflom.com general@mflom.com (480) 926-3100, FAX: 926-3598

T R A N S M I T T E R C E R T I F I C A T I O N

of

FCC ID: QQLC3310
MODEL: C3310

to

FEDERAL COMMUNICATIONS COMMISSION

Rule Part(s) 2, 22, 24E, 22.901d, Confidentiality

DATE OF REPORT: February 7, 2003

ON THE BEHALF OF THE APPLICANT:

AirLink Communications, Inc.

AT THE REQUEST OF:

P.O. 0020828

AirLink Communications, Inc.
472 Kato Terrace
Fremont, CA 94539

Attention of:

Jim Baichtal
510-226-4201; FAX: -4299
email: jim@airlink.com

SUPERVISED BY:



Morton Flom, P. Eng.

LIST OF EXHIBITS
(FCC **CERTIFICATION** (CELLULAR TRANSMITTERS) - REVISED 9/28/98)

APPLICANT: AirLink Communications, Inc.

FCC ID: QQLC3310

BY APPLICANT:

- | | |
|---|---|
| 1. LETTER OF AUTHORIZATION | x |
| 2. IDENTIFICATION DRAWINGS, 2.1033(c)(11) | |
| <u> x </u> LABEL | |
| <u> x </u> LOCATION OF LABEL | |
| <u> x </u> COMPLIANCE STATEMENT | |
| <u> x </u> LOCATION OF COMPLIANCE STATEMENT | |
| 3. PHOTOGRAPHS, 2.1033(c)(12) | x |
| 4. CONFIDENTIALITY REQUEST: 0.457 and 0.459 | x |
| 5. DOCUMENTATION: 2.1033(c) | |
| (3) USER MANUAL | x |
| (9) TUNE UP INFO | x |
| (10) SCHEMATIC DIAGRAM | x |
| (10) CIRCUIT DESCRIPTION | x |
| BLOCK DIAGRAM | x |
| PARTS LIST | x |
| ACTIVE DEVICES | x |
| 6. MPE REPORT | x |

BY M.F.A. INC.

- A. TESTIMONIAL & STATEMENT OF CERTIFICATION
- B. STATEMENT OF QUALIFICATIONS

THE APPLICANT HAS BEEN CAUTIONED AS TO THE FOLLOWING:

15.21 INFORMATION TO USER.

The users manual or instruction manual for an intentional radiator shall caution the user that changes or modifications not expressly approved by the party responsible for compliance could void the user's authority to operate the equipment.

15.27(a) SPECIAL ACCESSORIES.

Equipment marketed to a consumer must be capable of complying with the necessary regulations in the configuration in which the equipment is marketed. Where special accessories, such as shielded cables and/or special connectors are required to enable an unintentional or intentional radiator to comply with the emission limits in this part, the equipment must be marketed with, i.e. shipped and sold with, those special accessories. However, in lieu of shipping or packaging the special accessories with the unintentional or intentional radiator, the responsible party may employ other methods of ensuring that the special accessories are provided to the consumer, without additional charge.

Information detailing any alternative method used to supply the special accessories for a grant of equipment authorization or retained in the verification records, as appropriate. The party responsible for the equipment, as detailed in § 2.909 of this chapter, shall ensure that these special accessories are provided with the equipment. The instruction manual for such devices shall include appropriate instructions on the first page of text concerned with the installation of the device that these special accessories must be used with the device. It is the responsibility of the user to use the needed special accessories supplied with the equipment.

TABLE OF CONTENTS

RULE	DESCRIPTION	PAGE
	Test Report	1
2.1033(c)	General Information Required	2
2.1033(c)(14)	Rule Summary	5
	General Information	6
	Standard Test Conditions and Engineering Practices	6
2.1046(a)	Carrier Output Power (Conducted)	7
2.1046(a)	ERP Carrier Power (Radiated)	9
2.1049(c)(1), 22		
	Emission Masks (Occupied Bandwidth)	11
2.1051, 2.1049(c), 24, 24.238(b)		
	Transmitter Conducted Measurements	19
2.1051, 22.917	Spurious Emissions at Antenna Terminals	27
2.1053(a)	Field Strength of Spurious Radiation	30
2.1055(a)(1)	Frequency Stability (Temperature Variation)	34
2.1055(b)(1)	Frequency Stability (Voltage Variation)	37
2.202(g)	Necessary Bandwidth and Emission Bandwidth	38

PAGE NO. 1 of 38.

Required information per ISO/IEC Guide 25-1990, paragraph 13.2:

- a) TEST REPORT
- b) Laboratory: M. Flom Associates, Inc.
(FCC: 31040/SIT) 3356 N. San Marcos Place, Suite 107
(Canada: IC 2044) Chandler, AZ 85225
- c) Report Number: d0320010
- d) Client: AirLink Communications, Inc.
472 Kato Terrace
Fremont, CA 94539
- e) Identification: C3310
FCC ID: QQLC3310
Description: CDMA Modem
- f) EUT Condition: Not required unless specified in individual tests.
- g) Report Date: February 7, 2003
EUT Received: January 29, 2003
- h, j, k): As indicated in individual tests.
- i) Sampling method: No sampling procedure used.
- l) Uncertainty: In accordance with MFA internal quality manual.
- m) Supervised by: 
Morton Flom, P. Eng.
- n) Results: The results presented in this report relate only to the item tested.
- o) Reproduction: This report must not be reproduced, except in full, without written permission from this laboratory.

PAGE NO. 2 of 38.

LIST OF GENERAL INFORMATION REQUIRED FOR CERTIFICATION

IN ACCORDANCE WITH FCC RULES AND REGULATIONS,
VOLUME II, PART 2 AND TO

2, 22, 24E, 22.901d, Confidentiality

Sub-part 2.1033

(c)(1): NAME AND ADDRESS OF APPLICANT:

AirLink Communications, Inc.
472 Kato Terrace
Fremont, CA 94539

MANUFACTURER:

Applicant

(c)(2): FCC ID: QQLC3310

MODEL NO: C3310

(c)(3): INSTRUCTION MANUAL(S):

PLEASE SEE ATTACHED EXHIBITS

(c)(4): TYPE OF EMISSION: 1M25F9W

(c)(5): FREQUENCY RANGE, MHz: 824.04 to 848
1850 to 1910

(c)(6): POWER RATING, Watts: 0.25
Switchable Variable x N/A

FCC GRANT NOTE: BC - The output power is continuously variable from the value listed in this entry to 5%-10% of the value listed.

(c)(7): MAXIMUM POWER RATING, Watts: 0.6

PAGE NO. 3 of 38.

Subpart 2.1033 (continued)

(c)(8): VOLTAGES & CURRENTS IN ALL ELEMENTS IN FINAL R. F. STAGE, INCLUDING FINAL TRANSISTOR OR SOLID STATE DEVICE:

COLLECTOR CURRENT, A = 600 ma
 COLLECTOR VOLTAGE, Vdc = 3.3
 SUPPLY VOLTAGE, Vdc = 12

(c)(9): TUNE-UP PROCEDURE:

PLEASE SEE ATTACHED EXHIBITS

(c)(10): CIRCUIT DIAGRAM/CIRCUIT DESCRIPTION:

Including description of circuitry & devices provided for determining and stabilizing frequency, for suppression of spurious radiation, for limiting modulation and limiting power.

PLEASE SEE ATTACHED EXHIBITS

(c)(11): LABEL INFORMATION:

PLEASE SEE ATTACHED EXHIBITS

(c)(12): PHOTOGRAPHS:

PLEASE SEE ATTACHED EXHIBITS

(c)(13): DIGITAL MODULATION DESCRIPTION:

 ATTACHED EXHIBITS
 x N/A

(c)(14): TEST AND MEASUREMENT DATA:

FOLLOWS

M. Flom Associates, Inc. is accredited by the American Association for Laboratory Association (A2LA) as shown in the scope below.



THE AMERICAN ASSOCIATION FOR LABORATORY ACCREDITATION

ACCREDITED LABORATORY

A2LA has accredited

M. FLOM ASSOCIATES, INC.
Chandler, AZ

for technical competence in the field of

Electrical (EMC) Testing

The accreditation covers the specific tests and types of tests listed on the agreed scope of accreditation. This laboratory meets the requirements of ISO/IEC 17025 - 1999 "General Requirements for the Competence of Testing and Calibration Laboratories" and any additional program requirements in the identified field of testing. Testing and calibration laboratories that comply with this International Standard also operate in accordance with ISO 9001 or ISO 9002.

Presented this 2nd day of March, 2001.



Peter Mlynar
President
For the Accreditation Council
Certificate Number 1008.01
Valid to December 31, 2002

For tests or types of tests to which this accreditation applies, please refer to the laboratory's Electrical (EMC) Scope of Accreditation



American Association for Laboratory Accreditation

SCOPE OF ACCREDITATION TO ISO/IEC 17025:1999

M. FLOM ASSOCIATES, INC.
Electronic Testing Laboratory
106 North Sun Valley Plaza, Suite 107
Chandler, AZ 85225
March 2, 2001 Phone: 480-928-1100

ELECTRICAL (EMC)

Valid to: December 31, 2001 Certificate Number: 1008.01

In recognition of the successful completion of the A2LA evaluation process, accreditation is granted to this laboratory to perform the following electromagnetic compatibility tests:

Date:	3/2/2001
RF Emissions:	FCC Part 15 (Subparts B and C) using ANSI C63.4-2000, CFR 47.15.101-15.102, 15.103, 15.104, 15.105, 15.106, 15.107, 15.108, 15.109, 15.110, 15.111, 15.112, 15.113, 15.114, 15.115, 15.116, 15.117, 15.118, 15.119, 15.120, 15.121, 15.122, 15.123, 15.124, 15.125, 15.126, 15.127, 15.128, 15.129, 15.130, 15.131, 15.132, 15.133, 15.134, 15.135, 15.136, 15.137, 15.138, 15.139, 15.140, 15.141, 15.142, 15.143, 15.144, 15.145, 15.146, 15.147, 15.148, 15.149, 15.150, 15.151, 15.152, 15.153, 15.154, 15.155, 15.156, 15.157, 15.158, 15.159, 15.160, 15.161, 15.162, 15.163, 15.164, 15.165, 15.166, 15.167, 15.168, 15.169, 15.170, 15.171, 15.172, 15.173, 15.174, 15.175, 15.176, 15.177, 15.178, 15.179, 15.180, 15.181, 15.182, 15.183, 15.184, 15.185, 15.186, 15.187, 15.188, 15.189, 15.190, 15.191, 15.192, 15.193, 15.194, 15.195, 15.196, 15.197, 15.198, 15.199, 15.200, 15.201, 15.202, 15.203, 15.204, 15.205, 15.206, 15.207, 15.208, 15.209, 15.210, 15.211, 15.212, 15.213, 15.214, 15.215, 15.216, 15.217, 15.218, 15.219, 15.220, 15.221, 15.222, 15.223, 15.224, 15.225, 15.226, 15.227, 15.228, 15.229, 15.230, 15.231, 15.232, 15.233, 15.234, 15.235, 15.236, 15.237, 15.238, 15.239, 15.240, 15.241, 15.242, 15.243, 15.244, 15.245, 15.246, 15.247, 15.248, 15.249, 15.250, 15.251, 15.252, 15.253, 15.254, 15.255, 15.256, 15.257, 15.258, 15.259, 15.260, 15.261, 15.262, 15.263, 15.264, 15.265, 15.266, 15.267, 15.268, 15.269, 15.270, 15.271, 15.272, 15.273, 15.274, 15.275, 15.276, 15.277, 15.278, 15.279, 15.280, 15.281, 15.282, 15.283, 15.284, 15.285, 15.286, 15.287, 15.288, 15.289, 15.290, 15.291, 15.292, 15.293, 15.294, 15.295, 15.296, 15.297, 15.298, 15.299, 15.300, 15.301, 15.302, 15.303, 15.304, 15.305, 15.306, 15.307, 15.308, 15.309, 15.310, 15.311, 15.312, 15.313, 15.314, 15.315, 15.316, 15.317, 15.318, 15.319, 15.320, 15.321, 15.322, 15.323, 15.324, 15.325, 15.326, 15.327, 15.328, 15.329, 15.330, 15.331, 15.332, 15.333, 15.334, 15.335, 15.336, 15.337, 15.338, 15.339, 15.340, 15.341, 15.342, 15.343, 15.344, 15.345, 15.346, 15.347, 15.348, 15.349, 15.350, 15.351, 15.352, 15.353, 15.354, 15.355, 15.356, 15.357, 15.358, 15.359, 15.360, 15.361, 15.362, 15.363, 15.364, 15.365, 15.366, 15.367, 15.368, 15.369, 15.370, 15.371, 15.372, 15.373, 15.374, 15.375, 15.376, 15.377, 15.378, 15.379, 15.380, 15.381, 15.382, 15.383, 15.384, 15.385, 15.386, 15.387, 15.388, 15.389, 15.390, 15.391, 15.392, 15.393, 15.394, 15.395, 15.396, 15.397, 15.398, 15.399, 15.400, 15.401, 15.402, 15.403, 15.404, 15.405, 15.406, 15.407, 15.408, 15.409, 15.410, 15.411, 15.412, 15.413, 15.414, 15.415, 15.416, 15.417, 15.418, 15.419, 15.420, 15.421, 15.422, 15.423, 15.424, 15.425, 15.426, 15.427, 15.428, 15.429, 15.430, 15.431, 15.432, 15.433, 15.434, 15.435, 15.436, 15.437, 15.438, 15.439, 15.440, 15.441, 15.442, 15.443, 15.444, 15.445, 15.446, 15.447, 15.448, 15.449, 15.450, 15.451, 15.452, 15.453, 15.454, 15.455, 15.456, 15.457, 15.458, 15.459, 15.460, 15.461, 15.462, 15.463, 15.464, 15.465, 15.466, 15.467, 15.468, 15.469, 15.470, 15.471, 15.472, 15.473, 15.474, 15.475, 15.476, 15.477, 15.478, 15.479, 15.480, 15.481, 15.482, 15.483, 15.484, 15.485, 15.486, 15.487, 15.488, 15.489, 15.490, 15.491, 15.492, 15.493, 15.494, 15.495, 15.496, 15.497, 15.498, 15.499, 15.500, 15.501, 15.502, 15.503, 15.504, 15.505, 15.506, 15.507, 15.508, 15.509, 15.510, 15.511, 15.512, 15.513, 15.514, 15.515, 15.516, 15.517, 15.518, 15.519, 15.520, 15.521, 15.522, 15.523, 15.524, 15.525, 15.526, 15.527, 15.528, 15.529, 15.530, 15.531, 15.532, 15.533, 15.534, 15.535, 15.536, 15.537, 15.538, 15.539, 15.540, 15.541, 15.542, 15.543, 15.544, 15.545, 15.546, 15.547, 15.548, 15.549, 15.550, 15.551, 15.552, 15.553, 15.554, 15.555, 15.556, 15.557, 15.558, 15.559, 15.560, 15.561, 15.562, 15.563, 15.564, 15.565, 15.566, 15.567, 15.568, 15.569, 15.570, 15.571, 15.572, 15.573, 15.574, 15.575, 15.576, 15.577, 15.578, 15.579, 15.580, 15.581, 15.582, 15.583, 15.584, 15.585, 15.586, 15.587, 15.588, 15.589, 15.590, 15.591, 15.592, 15.593, 15.594, 15.595, 15.596, 15.597, 15.598, 15.599, 15.600, 15.601, 15.602, 15.603, 15.604, 15.605, 15.606, 15.607, 15.608, 15.609, 15.610, 15.611, 15.612, 15.613, 15.614, 15.615, 15.616, 15.617, 15.618, 15.619, 15.620, 15.621, 15.622, 15.623, 15.624, 15.625, 15.626, 15.627, 15.628, 15.629, 15.630, 15.631, 15.632, 15.633, 15.634, 15.635, 15.636, 15.637, 15.638, 15.639, 15.640, 15.641, 15.642, 15.643, 15.644, 15.645, 15.646, 15.647, 15.648, 15.649, 15.650, 15.651, 15.652, 15.653, 15.654, 15.655, 15.656, 15.657, 15.658, 15.659, 15.660, 15.661, 15.662, 15.663, 15.664, 15.665, 15.666, 15.667, 15.668, 15.669, 15.670, 15.671, 15.672, 15.673, 15.674, 15.675, 15.676, 15.677, 15.678, 15.679, 15.680, 15.681, 15.682, 15.683, 15.684, 15.685, 15.686, 15.687, 15.688, 15.689, 15.690, 15.691, 15.692, 15.693, 15.694, 15.695, 15.696, 15.697, 15.698, 15.699, 15.700, 15.701, 15.702, 15.703, 15.704, 15.705, 15.706, 15.707, 15.708, 15.709, 15.710, 15.711, 15.712, 15.713, 15.714, 15.715, 15.716, 15.717, 15.718, 15.719, 15.720, 15.721, 15.722, 15.723, 15.724, 15.725, 15.726, 15.727, 15.728, 15.729, 15.730, 15.731, 15.732, 15.733, 15.734, 15.735, 15.736, 15.737, 15.738, 15.739, 15.740, 15.741, 15.742, 15.743, 15.744, 15.745, 15.746, 15.747, 15.748, 15.749, 15.750, 15.751, 15.752, 15.753, 15.754, 15.755, 15.756, 15.757, 15.758, 15.759, 15.760, 15.761, 15.762, 15.763, 15.764, 15.765, 15.766, 15.767, 15.768, 15.769, 15.770, 15.771, 15.772, 15.773, 15.774, 15.775, 15.776, 15.777, 15.778, 15.779, 15.780, 15.781, 15.782, 15.783, 15.784, 15.785, 15.786, 15.787, 15.788, 15.789, 15.790, 15.791, 15.792, 15.793, 15.794, 15.795, 15.796, 15.797, 15.798, 15.799, 15.800, 15.801, 15.802, 15.803, 15.804, 15.805, 15.806, 15.807, 15.808, 15.809, 15.810, 15.811, 15.812, 15.813, 15.814, 15.815, 15.816, 15.817, 15.818, 15.819, 15.820, 15.821, 15.822, 15.823, 15.824, 15.825, 15.826, 15.827, 15.828, 15.829, 15.830, 15.831, 15.832, 15.833, 15.834, 15.835, 15.836, 15.837, 15.838, 15.839, 15.840, 15.841, 15.842, 15.843, 15.844, 15.845, 15.846, 15.847, 15.848, 15.849, 15.850, 15.851, 15.852, 15.853, 15.854, 15.855, 15.856, 15.857, 15.858, 15.859, 15.860, 15.861, 15.862, 15.863, 15.864, 15.865, 15.866, 15.867, 15.868, 15.869, 15.870, 15.871, 15.872, 15.873, 15.874, 15.875, 15.876, 15.877, 15.878, 15.879, 15.880, 15.881, 15.882, 15.883, 15.884, 15.885, 15.886, 15.887, 15.888, 15.889, 15.890, 15.891, 15.892, 15.893, 15.894, 15.895, 15.896, 15.897, 15.898, 15.899, 15.900, 15.901, 15.902, 15.903, 15.904, 15.905, 15.906, 15.907, 15.908, 15.909, 15.910, 15.911, 15.912, 15.913, 15.914, 15.915, 15.916, 15.917, 15.918, 15.919, 15.920, 15.921, 15.922, 15.923, 15.924, 15.925, 15.926, 15.927, 15.928, 15.929, 15.930, 15.931, 15.932, 15.933, 15.934, 15.935, 15.936, 15.937, 15.938, 15.939, 15.940, 15.941, 15.942, 15.943, 15.944, 15.945, 15.946, 15.947, 15.948, 15.949, 15.950, 15.951, 15.952, 15.953, 15.954, 15.955, 15.956, 15.957, 15.958, 15.959, 15.960, 15.961, 15.962, 15.963, 15.964, 15.965, 15.966, 15.967, 15.968, 15.969, 15.970, 15.971, 15.972, 15.973, 15.974, 15.975, 15.976, 15.977, 15.978, 15.979, 15.980, 15.981, 15.982, 15.983, 15.984, 15.985, 15.986, 15.987, 15.988, 15.989, 15.990, 15.991, 15.992, 15.993, 15.994, 15.995, 15.996, 15.997, 15.998, 15.999, 16.000, 16.001, 16.002, 16.003, 16.004, 16.005, 16.006, 16.007, 16.008, 16.009, 16.010, 16.011, 16.012, 16.013, 16.014, 16.015, 16.016, 16.017, 16.018, 16.019, 16.020, 16.021, 16.022, 16.023, 16.024, 16.025, 16.026, 16.027, 16.028, 16.029, 16.030, 16.031, 16.032, 16.033, 16.034, 16.035, 16.036, 16.037, 16.038, 16.039, 16.040, 16.041, 16.042, 16.043, 16.044, 16.045, 16.046, 16.047, 16.048, 16.049, 16.050, 16.051, 16.052, 16.053, 16.054, 16.055, 16.056, 16.057, 16.058, 16.059, 16.060, 16.061, 16.062, 16.063, 16.064, 16.065, 16.066, 16.067, 16.068, 16.069, 16.070, 16.071, 16.072, 16.073, 16.074, 16.075, 16.076, 16.077, 16.078, 16.079, 16.080, 16.081, 16.082, 16.083, 16.084, 16.085, 16.086, 16.087, 16.088, 16.089, 16.090, 16.091, 16.092, 16.093, 16.094, 16.095, 16.096, 16.097, 16.098, 16.099, 16.100, 16.101, 16.102, 16.103, 16.104, 16.105, 16.106, 16.107, 16.108, 16.109, 16.110, 16.111, 16.112, 16.113, 16.114, 16.115, 16.116, 16.117, 16.118, 16.119, 16.120, 16.121, 16.122, 16.123, 16.124, 16.125, 16.126, 16.127, 16.128, 16.129, 16.130, 16.131, 16.132, 16.133, 16.134, 16.135, 16.136, 16.137, 16.138, 16.139, 16.140, 16.141, 16.142, 16.143, 16.144, 16.145, 16.146, 16.147, 16.148, 16.149, 16.150, 16.151, 16.152, 16.153, 16.154, 16.155, 16.156, 16.157, 16.158, 16.159, 16.160, 16.161, 16.162, 16.163, 16.164, 16.165, 16.166, 16.167, 16.168, 16.169, 16.170, 16.171, 16.172, 16.173, 16.174, 16.175, 16.176, 16.177, 16.178, 16.179, 16.180, 16.181, 16.182, 16.183, 16.184, 16.185, 16.186, 16.187, 16.188, 16.189, 16.190, 16.191, 16.192, 16.193, 16.194, 16.195, 16.196, 16.197, 16.198, 16.199, 16.200, 16.201, 16.202, 16.203, 16.204, 16.205, 16.206, 16.207, 16.208, 16.209, 16.210, 16.211, 16.212, 16.213, 16.214, 16.215, 16.216, 16.217, 16.218, 16.219, 16.220, 16.221, 16.222, 16.223, 16.224, 16.225, 16.226, 16.227, 16.228, 16.229, 16.230, 16.231, 16.232, 16.233, 16.234, 16.235, 16.236, 16.237, 16.238, 16.239, 16.240, 16.241, 16.242, 16.243, 16.244, 16.245, 16.246, 16.247, 16.248, 16.249, 16.250, 16.251, 16.252, 16.253, 16.254, 16.255, 16.256, 16.257, 16.258, 16.259, 16.260, 16.261, 16.262, 16.263, 16.264, 16.265, 16.266, 16.267, 16.268, 16.269, 16.270, 16.271, 16.272, 16.273, 16.274, 16.275, 16.276, 16.277, 16.278, 16.279, 16.280, 16.281, 16.282, 16.283, 16.284, 16.285, 16.286, 16.287, 16.288, 16.289, 16.290, 16.291, 16.292, 16.293, 16.294, 16.295, 16.296, 16.297, 16.298, 16.299, 16.300, 16.301, 16.302, 16.303, 16.304, 16.305, 16.306, 16.307, 16.308, 16.309, 16.310, 16.311, 16.312, 16.313, 16.314, 16.315, 16.316, 16.317, 16.318, 16.319, 16.320, 16.321, 16.322, 16.323, 16.324, 16.325, 16.326, 16.327, 16.328, 16.329, 16.330, 16.331, 16.332, 16.333, 16.334, 16.335, 16.336, 16.337, 16.338, 16.339, 16.340, 16.341, 16.342, 16.343, 16.344, 16.345, 16.346, 16.347, 16.348, 16.349, 16.350, 16.351, 16.352, 16.353, 16.354, 16.355, 16.356, 16.357, 16.358, 16.359, 16.360, 16.361, 16.362, 16.363, 16.364, 16.365, 16.366, 16.367, 16.368, 16.369, 16.370, 16.371, 16.372, 16.373, 16.374, 16.375, 16.376, 16.377, 16.378, 16.379, 16.380, 16.381, 16.382, 16.383, 16.384, 16.385, 16.386, 16.387, 16.388, 16.389, 16.390, 16.391, 16.392, 16.393, 16.394, 16.395, 16.396, 16.397, 16.398, 16.399, 16.400, 16.401, 16.402, 16.403, 16.404, 16.405, 16.406, 16.407, 16.408, 16.409, 16.410, 16.411, 16.412, 16.413, 16.414, 16.415, 16.416, 16.417, 16.418, 16.419, 16.420, 16.421, 16.422, 16.423, 16.424, 16.425, 16.426, 16.427, 16.428, 16.429, 16.430, 16.431, 16.432, 16.433, 16.434, 16.435, 16.436, 16.437, 16.438, 16.439, 16.440, 16.441, 16.442, 16.443, 16.444, 16.445, 16.446, 16.447, 16.448, 16.449, 16.450, 16.451, 16.452, 16.453, 16.454, 16.455, 16.456, 16.457, 16.458, 16.459, 16.460, 16.461, 16.462, 16.463, 16.464, 16.465, 16.466, 16.467, 16.468, 16.469, 16.470, 16.471, 16.472, 16.473, 16.474, 16.475, 16.476, 16.477, 16.478, 16.479, 16.480, 16.481, 16.482, 16.483, 16.484, 16.485, 16.486, 16.487, 16.488, 16.489, 16.490, 16.491, 16.492, 16.493, 16.494, 16.495, 16.496, 16.497, 16.498, 16.499, 16.500, 16.501, 16.502, 16.503, 16.504, 16.505, 16.506, 16.507, 16.508, 16.509, 16.510, 16.511, 16.512, 16.513, 16.514, 16.515, 16.516, 16.517, 16.518, 16.519, 16.520, 16.521, 16.522, 16.523, 16.524, 16.525, 16.526, 16.527, 16.528, 16.529, 16.530, 16.531, 16.532, 16.533, 16.534, 16.535, 16.53

PAGE NO.

5 of 38.

Sub-part
2.1033(c)(14):TEST AND MEASUREMENT DATA

All tests and measurement data shown were performed in accordance with FCC Rules and Regulations, Volume II; Part 2, Sub-part J, Sections 2.947, 2.1033(c), 2.1041, 2.1046, 2.1047, 2.1079, 2.1051, 2.1053, 2.1055, 2.1057 and the following individual Parts:

- 21 - Domestic Public Fixed Radio Services
- 22 - Public Mobile Services
- 22 Subpart H - Cellular Radiotelephone Service
- 22.901(d) - Alternative technologies and auxiliary services
- 23 - International Fixed Public Radiocommunication services
- 24 - Personal Communications Services
- 74 Subpart H - Low Power Auxiliary Stations
- 80 - Stations in the Maritime Services
- 80 Subpart E - General Technical Standards
- 80 Subpart F - Equipment Authorization for Compulsory Ships
- 80 Subpart K - Private Coast Stations and Marine Utility Stations
- 80 Subpart S - Compulsory Radiotelephone Installations for Small Passenger Boats
- 80 Subpart T - Radiotelephone Installation Required for Vessels on the Great Lakes
- 80 Subpart U - Radiotelephone Installations Required by the Bridge-to-Bridge Act
- 80 Subpart V - Emergency Position Indicating Radiobeacons (EPIRB'S)
- 80 Subpart W - Global Maritime Distress and Safety System (GMDSS)
- 80 Subpart X - Voluntary Radio Installations
- 87 - Aviation Services
- 90 - Private Land Mobile Radio Services
- 94 - Private Operational-Fixed Microwave Service
- 95 Subpart A - General Mobile Radio Service (GMRS)
- 95 Subpart C - Radio Control (R/C) Radio Service
- 95 Subpart D - Citizens Band (CB) Radio Service
- 95 Subpart E - Family Radio Service
- 95 Subpart F - Interactive Video and Data Service (IVDS)
- 97 - Amateur Radio Service
- 101 - Fixed Microwave Services

PAGE NO.

6 of 38.

STANDARD TEST CONDITIONS
and
ENGINEERING PRACTICES

Except as noted herein, the following conditions and procedures were observed during the testing:

In accordance with ANSI C63.4-1992/2000, section 6.1.9, and unless otherwise indicated in the specific measurement results, the ambient temperature of the actual EUT was maintained within the range of 10° to 40°C (50° to 104 °F) unless the particular equipment requirements specify testing over a different temperature range. Also, unless otherwise indicated, the humidity levels were in the range of 10% to 90% relative humidity.

Prior to testing, the EUT was tuned up in accordance with the manufacturer's alignment procedures. All external gain controls were maintained at the position of maximum and/or optimum gain throughout the testing.

Measurement results, unless otherwise noted, are worst case measurements.

PAGE NO. 7 of 38.
NAME OF TEST: Carrier Output Power (Conducted)
SPECIFICATION: 47 CFR 2.1046(a)
TEST EQUIPMENT: As per attached page

MEASUREMENT PROCEDURE

1. The EUT was connected to a resistive coaxial attenuator of normal load impedance, and the unmodulated output power was measured by means of an R. F. Power Meter.
2. Measurement accuracy is $\pm 3\%$.

MEASUREMENT RESULTS

Frequency, MHz	High Power, dbm	High Power mw
824.04	23.48	222.8
836.4	23.72	235.5
848.97	21.86	153.5
1851.25	23.87	243.8
1880	23.23	210.4
1908.75	23.3	213.8

PERFORMED BY:

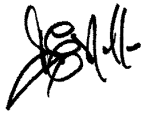
 Doug Noble, B.A.S. E.E.T.

TRANSMITTER POWER CONDUCTED MEASUREMENTS

TEST 1: R. F. POWER OUTPUT
 TEST 2: FREQUENCY STABILITY

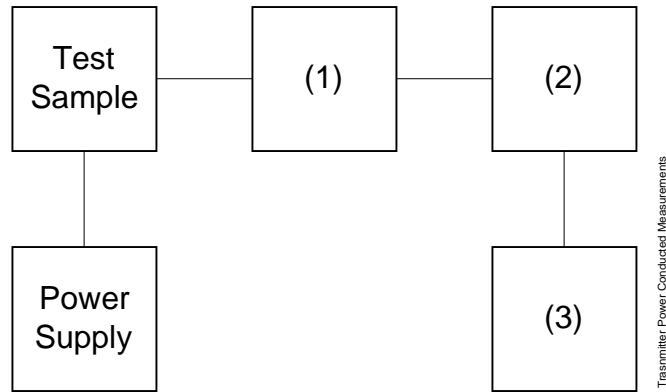

Asset	Description (as applicable)	s/n
(1)	<u>COAXIAL ATTENUATOR</u>	
i00122	Narda 766-10	7802
i00123	Narda 766-10	7802A
i00069	Bird 8329 (30 dB)	1006
i00113	Sierra 661A-3D	1059
(2)	<u>POWER METERS</u>	
i00014	HP 435A	1733A05836
i00039	HP 436A	2709A26776
i00020	HP 8901A POWER MODE	2105A01087
(3)	<u>FREQUENCY COUNTER</u>	
i00042	HP 5383A	1628A00959
i00019	HP 5334B	2704A00347
i00020	HP 8901A FREQUENCY MODE	2105A01087

PAGE NO. 9 of 38.

NAME OF TEST: ERP Carrier Power (Radiated)

SPECIFICATION: TIA/EIA 603A (Substitution Method)

2.2.17.1 Definition: The average radiated power of a licensed device is the equivalent power required, when delivered to a half-wave dipole or horn antenna, to produce at a distant point the same average received power as produced by the licensed device.

2.2.17.2 Method of Measurement:

a) Connect the equipment as illustrated. Place the transmitter to be tested on the turntable in the standard test site.

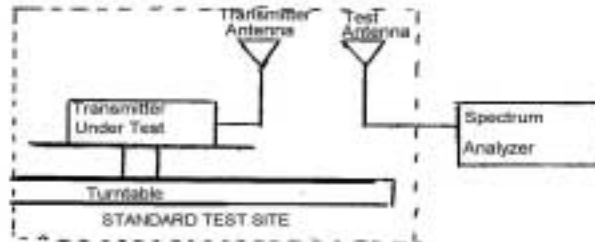

b) Raise and lower the test antenna from 1m to 6 m with the transmitter facing the antenna and record the highest received signal in dB as LVL.

c) Repeat step b) for seven additional readings at 45° interval positions of the turntable.

d) Replace the transmitter under test with a half-wave or horn vertically polarized antenna. The center of the antenna should be at the same location as the transmitter under test. Connect the antenna to a signal generator with a known output power and record the path loss in dB or LOSS.

e) Calculate the average radiated output power from the readings in step c) and d) by the following:

$$\text{average radiated power} = 10 \log_{10} \Sigma 10(\text{LVL} - \text{LOSS})/10 \text{ (dBm)}$$

RESULTS ATTACHED

PAGE NO. 10 of 38.

NAME OF TEST: ERP Carrier Power (Radiated)

RESULTS

	824 MHz		836.4 MHz		848.2 MHz	
	LVL, dbm	Path Loss, db	LVL, dbm	Path Loss, db	LVL, dbm	Path Loss, db
0°	23.7	0.7	23.1	1.0	21.1	1.8
45°	21.9	0.7	22.4	1.0	19.9	1.8
90°	22.5	0.7	21.8	1.0	23.1	1.8
135°	23.2	0.7	23.6	1.0	20.6	1.8
180°	22.3	0.7	22.8	1.0	21.9	1.8
225°	23.9	0.7	21.8	1.0	19.7	1.8
270°	22.2	0.7	21.8	1.0	20.6	1.8
315°	21.8	0.7	20.3	1.0	20.9	1.8

	824 MHz	836.4 MHz	848.2 MHz
Av. Radiated Power:	23.7 dbm	23.2 dbm	22.8 dbm

	1851.25 MHz		1880 MHz		1908.75 MHz	
	LVL, dbm	Path Loss, db	LVL, dbm	Path Loss, db	LVL, dbm	Path Loss, db
0°	20.8	3.2	24.8	3.3	16.1	3.3
45°	16.4	3.2	24.7	3.3	13.6	3.3
90°	18.8	3.2	21.9	3.3	21.0	3.3
135°	18.1	3.2	17.4	3.3	21.4	3.3
180°	14.1	3.2	23.3	3.3	18.2	3.3
225°	17.3	3.2	20.6	3.3	19.7	3.3
270°	17.9	3.2	19.7	3.3	17.0	3.3
315°	19.3	3.2	13.3	3.3	8.0	3.3

	1851.25 MHz	1880 MHz	1908.75 MHz
Av. Radiated Power:	18.9 dbm	23.9 dbm	20.2 dbm

PAGE NO. 11 of 38.
NAME OF TEST: Emission Masks (Occupied Bandwidth)
SPECIFICATION: 47 CFR 2.1049(c)(1), 22
TEST EQUIPMENT: As per previous page

MEASUREMENT PROCEDURE

1. The EUT and test equipment were set up as shown on the following page, with the Spectrum Analyzer connected.
2. For EUTs supporting audio modulation, the audio signal generator was adjusted to the frequency of maximum response and with output level set for ± 2.5 kHz deviation (or 50% modulation). With level constant, the signal level was increased 16 dB.
3. For EUTs supporting digital modulation, the digital modulation mode was operated to its maximum extent.
4. The Occupied Bandwidth was measured with the Spectrum Analyzer controls set as shown on the test results.
5. MEASUREMENT RESULTS: ATTACHED

PAGE NO. 12 of 38.

NAME OF TEST: Emission Masks (Occupied Bandwidth)
g02b0034: 2003-Jan-31 Fri
STATE: 2:High Power

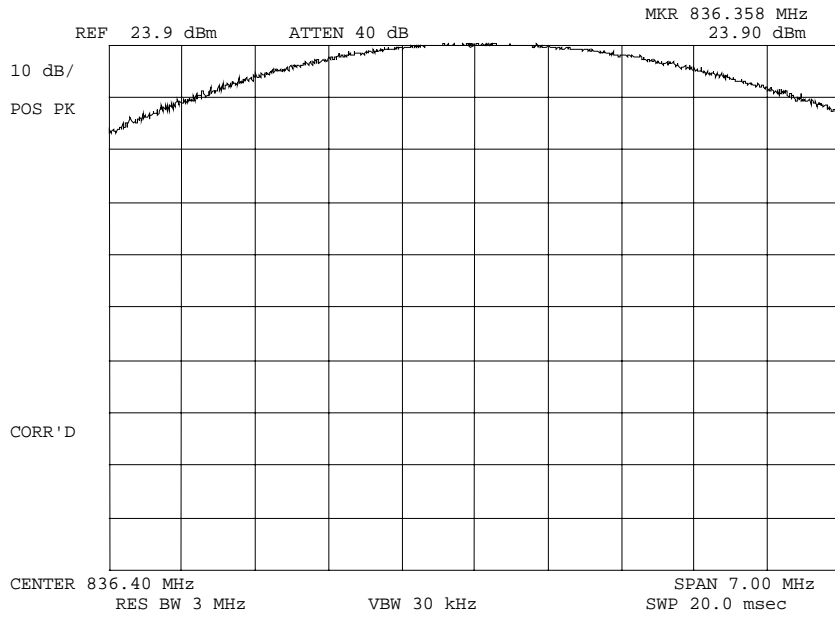

POWER:
MODULATION:

HIGH
CDMA 800
REFERENCE LEVEL

PERFORMED BY:

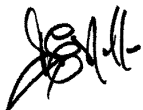
Doug Noble, B.A.S. E.E.T.

PAGE NO. 13 of 38.

NAME OF TEST: Emission Masks (Occupied Bandwidth)
g02b0028: 2003-Jan-31 Fri
STATE: 1:Low Power

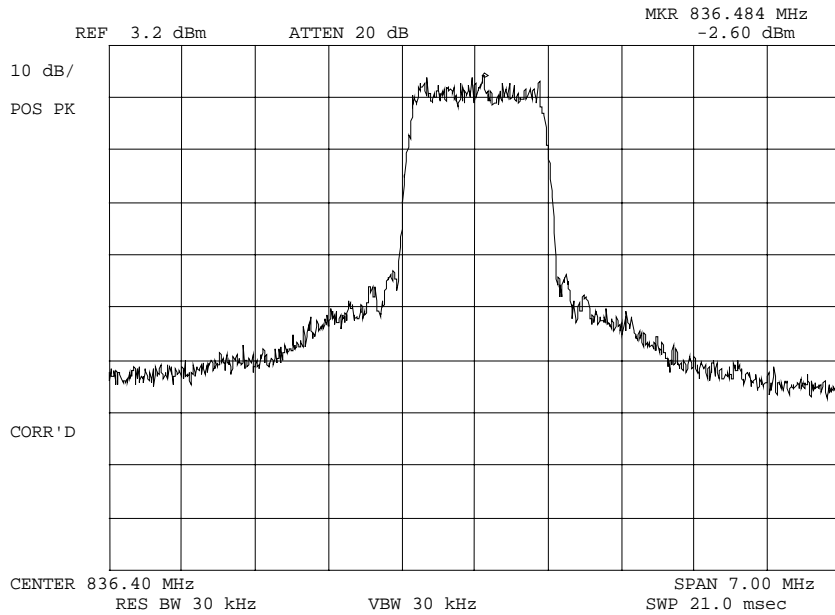

POWER: LOW
MODULATION: CDMA 800

PERFORMED BY:

Doug Noble, B.A.S. E.E.T.

PAGE NO. 14 of 38.

NAME OF TEST: Emission Masks (Occupied Bandwidth)
g02b0031: 2003-Jan-31 Fri
STATE: 2:High Power

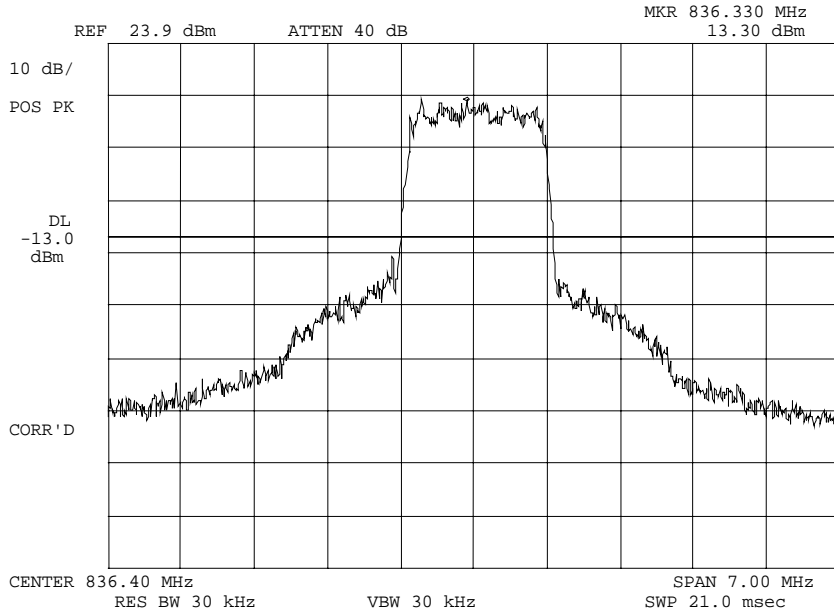

POWER: HIGH
MODULATION: CDMA 800

PERFORMED BY:

Doug Noble, B.A.S. E.E.T.

PAGE NO. 15 of 38.

NAME OF TEST: Emission Masks (Occupied Bandwidth)
g02b0029: 2003-Jan-31 Fri
STATE: 2:High Power

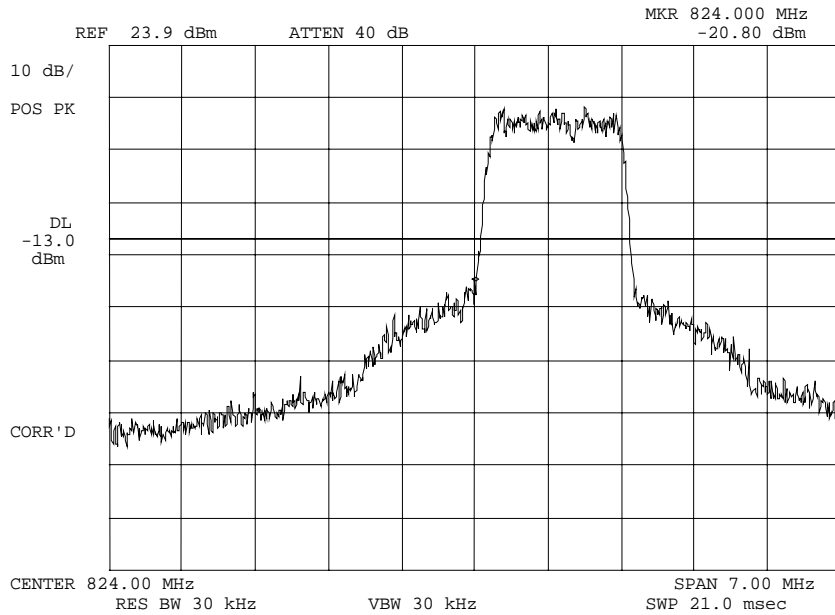

POWER:	HIGH
MODULATION:	CDMA 800
	LOWER BANDEDGE CH 1014

PERFORMED BY:

Doug Noble, B.A.S. E.E.T.

PAGE NO. 16 of 38.

NAME OF TEST: Emission Masks (Occupied Bandwidth)
g02b0030: 2003-Jan-31 Fri
STATE: 2:High Power

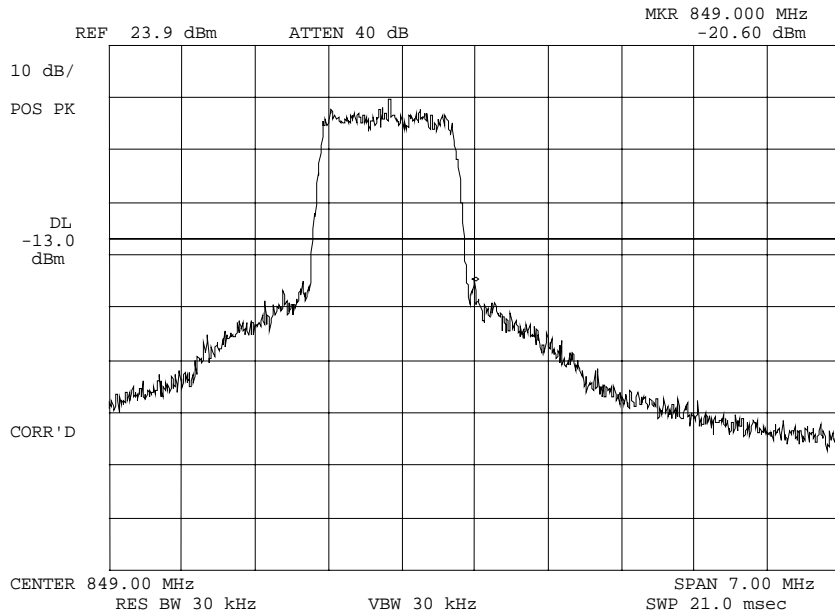

POWER: HIGH
MODULATION: CDMA 800
UPPER BANDEDGE CH 773

PERFORMED BY:

Doug Noble, B.A.S. E.E.T.

PAGE NO. 18 of 38.

NAME OF TEST: Emission Masks (Occupied Bandwidth)
g02b0032: 2003-Jan-31 Fri
STATE: 2:High Power

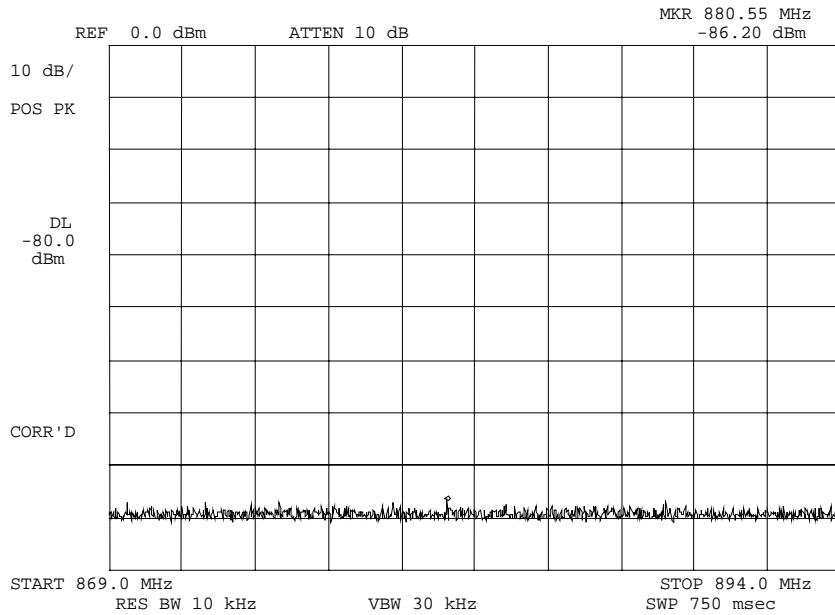

POWER:	HIGH
MODULATION:	CDMA 800
	TX SPURS IN RX CRITICAL BAND

PERFORMED BY:

Doug Noble, B.A.S. E.E.T.

PAGE NO. 19 of 38.
NAME OF TEST: Transmitter Conducted Measurements
SPECIFICATION: 47 CFR 2.1051: Unwanted (spurious) Emissions
2.1049(c), 24.238(b): Occupied Bandwidth
24: Emissions at Band Edges
TEST EQUIPMENT: As per attached page

MEASUREMENT PROCEDURE

1. The EUT and test equipment were set up as shown on the following page with the Spectrum Analyzer connected.
2. The low and high channels for all RF powers within the designated frequency block(s) were measured.
3. MEASUREMENT RESULTS: ATTACHED

PERFORMED BY:

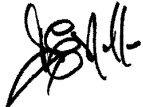
Doug Noble, B.A.S. E.E.T.

TRANSMITTER SPURIOUS EMISSION

TEST A. OCCUPIED BANDWIDTH (IN-BAND SPURIOUS)
 TEST B. OUT-OF-BAND SPURIOUS

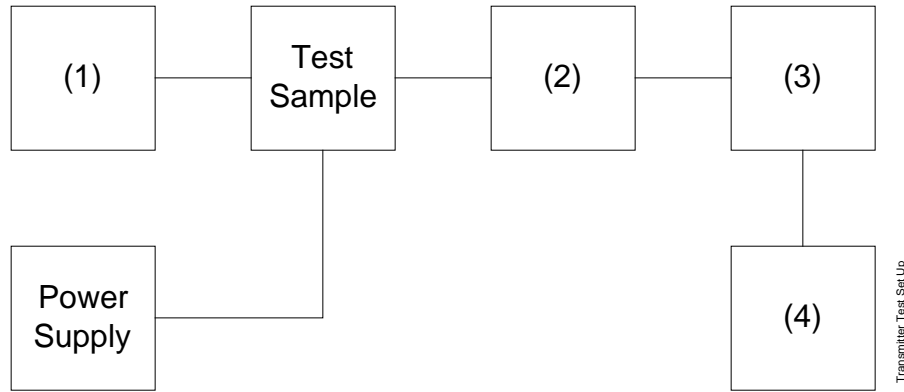

Asset Description
 (as applicable)

s/n

(1) AUDIO OSCILLATOR/GENERATOR

i00010	HP 204D	1105A04683
i00017	HP 8903A	2216A01753
i00012	HP 3312A	1432A11250

(2) COAXIAL ATTENUATOR

i00122	Narda 766-10	7802
i00123	Narda 766-10	7802A
i00069	Bird 8329 (30 dB)	1006
i00113	Sierra 661A-3D	1059

(3) FILTERS; NOTCH, HP, LP, BP

i00126	Eagle TNF-1	100-250
i00125	Eagle TNF-1	50-60
i00124	Eagle TNF-1	250-850

(4) SPECTRUM ANALYZER

i00048	HP 8566B	2511A01467
i00029	HP 8563E	3213A00104

PAGE NO. 21 of 38.

NAME OF TEST: Emission Masks (Occupied Bandwidth)
g02a0035: 2003-Jan-31 Fri
STATE: 2:High Power

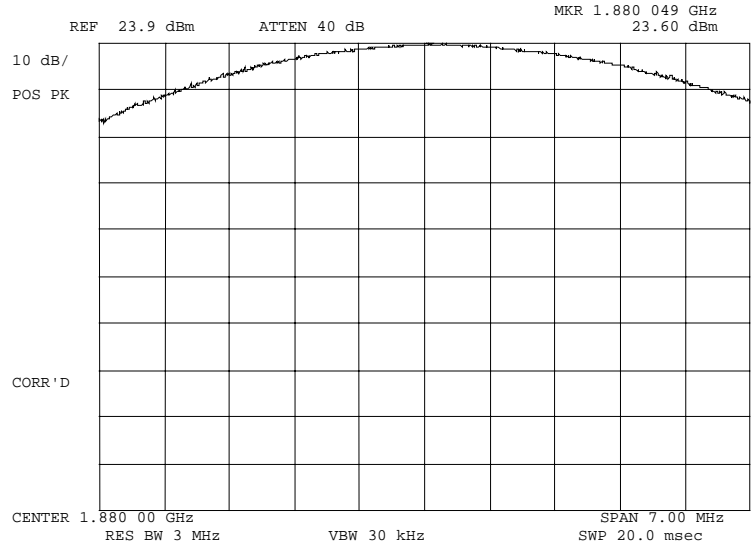

POWER:
MODULATION:

HIGH
CDMA PCS BAND
REFERENCE LEVEL

PERFORMED BY:

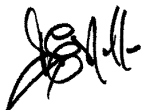
Doug Noble, B.A.S. E.E.T.

PAGE NO. 22 of 38.

NAME OF TEST: Emission Masks (Occupied Bandwidth)
g02a0037: 2003-Jan-31 Fri
STATE: 1:Low Power

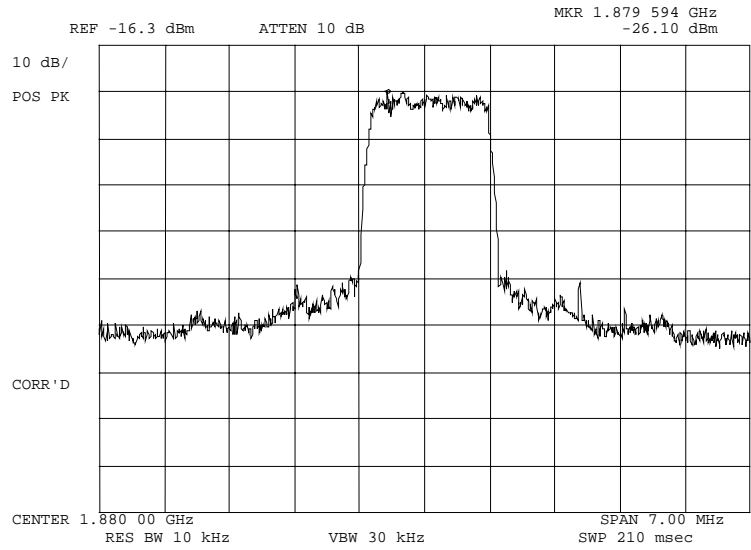

POWER: LOW
MODULATION: CDMA PCS BAND

PERFORMED BY:

Doug Noble, B.A.S. E.E.T.

PAGE NO. 23 of 38.

NAME OF TEST: Emission Masks (Occupied Bandwidth)
g02a0036: 2003-Jan-31 Fri
STATE: 2:High Power

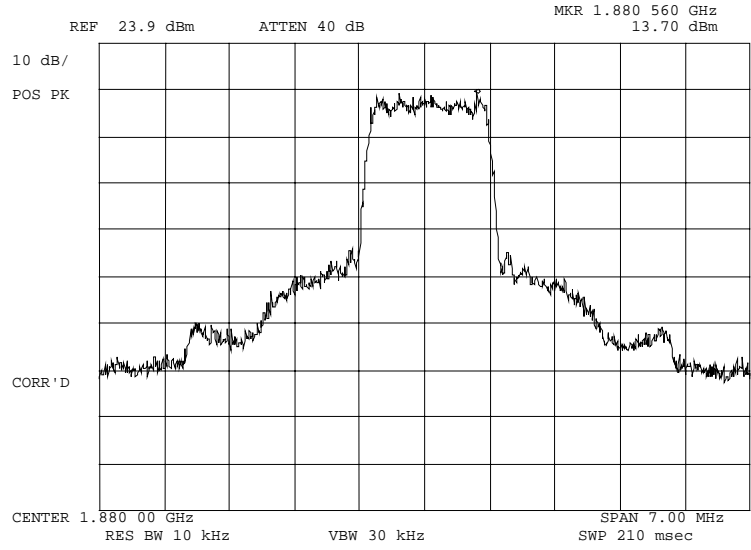

POWER: HIGH
MODULATION: CDMA PCS BAND

PERFORMED BY:

Doug Noble, B.A.S. E.E.T.

PAGE NO. 24 of 38.

NAME OF TEST: Emission Masks (Occupied Bandwidth)
g02a0039: 2003-Jan-31 Fri
STATE: 2:High Power

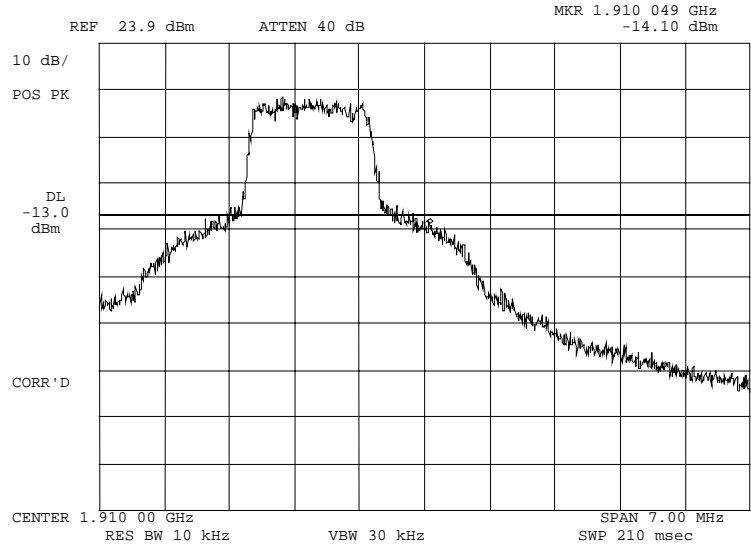

POWER: HIGH
MODULATION: CDMA PCS BAND
UPPER BANDEDGE CH 1175

PERFORMED BY:

Doug Noble, B.A.S. E.E.T.

PAGE NO. 25 of 38.

NAME OF TEST: Emission Masks (Occupied Bandwidth)
g02a0040: 2003-Jan-31 Fri
STATE: 2:High Power

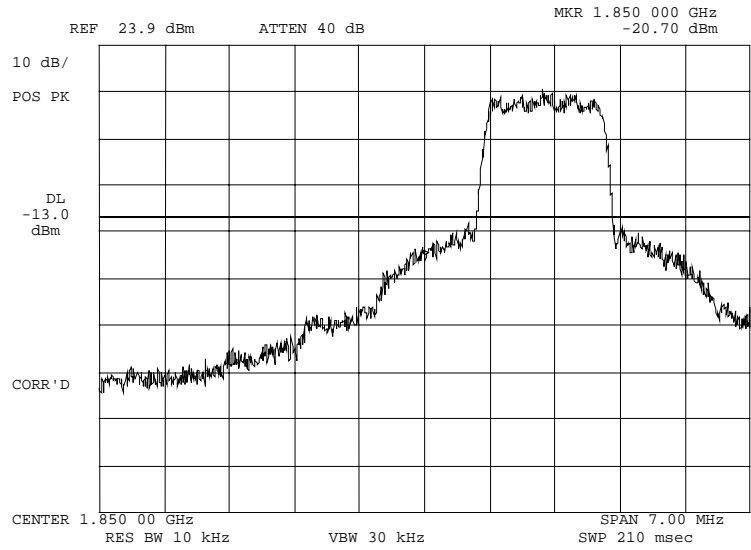

POWER: HIGH
MODULATION: CDMA PCS BAND
LOWER BANDEDGE CH 025

PERFORMED BY:

Doug Noble, B.A.S. E.E.T.

PAGE NO.

26 of 38.

NAME OF TEST: Emission Masks (Occupied Bandwidth)
g02a0038: 2003-Jan-31 Fri
STATE: 2:High Power

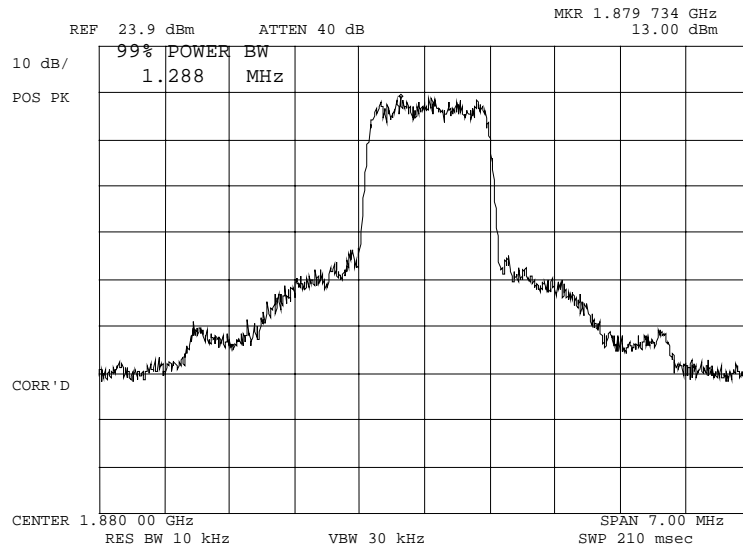

POWER:	HIGH
MODULATION:	CDMA PCS BAND
	99 % POWER BANDWIDTH

PERFORMED BY:

Doug Noble, B.A.S. E.E.T.

PAGE NO. 27 of 38.
NAME OF TEST: Spurious Emissions at Antenna Terminals
SPECIFICATION: 47 CFR 2.1051, 22.917
TEST EQUIPMENT: As per attached page

MEASUREMENT PROCEDURE

1. The EUT was connected to a coaxial attenuator and then to a Spectrum Analyzer.
2. A notch filter was introduced to reduce or eliminate spurious emission which could be generated internally in the spectrum analyzer.
3. Measurements were made over the range from 45 kHz to 10 GHz for the worst case modulation so both the highest and lowest R.F. power settings.
4. All other emissions were 20 dB or more below the limit.
5. Spectrum analyzer bandwidth was set to section 22.917(h) as applicable.
6. MEASUREMENT RESULTS: ATTACHED

PAGE NO.

28 of 38.

NAME OF TEST: Unwanted Emissions (Transmitter Conducted)
 g0310167: 2003-Jan-31 Fri 12:28:00
 STATE: 2:High Power

FREQUENCY TUNED, MHz	FREQUENCY EMISSION, MHz	LEVEL, dBm	LEVEL, dBc	MARGIN, dB
824.040000	1648.218900	-45.2	-72.9	-32.2
836.400000	1672.666600	-46.4	-74.1	-33.4
848.970000	1697.709600	-46.5	-74.2	-33.5
824.040000	2471.915600	-45.1	-72.8	-32.1
836.400000	2508.992100	-48.5	-76.2	-35.5
848.970000	2546.999500	-48.2	-75.9	-35.2
824.040000	3296.241500	-48.5	-76.2	-35.5
836.400000	3345.537500	-49.2	-76.9	-36.2
848.970000	3395.872500	-48.7	-76.4	-35.7
824.040000	4119.972100	-48.5	-76.2	-35.5
836.400000	4182.148400	-48.5	-76.2	-35.5
848.970000	4244.971000	-46.8	-74.5	-33.8
824.040000	4943.998100	-48.6	-76.3	-35.6
836.400000	5018.291500	-47.9	-75.6	-34.9
848.970000	5093.802000	-48.5	-76.2	-35.5
824.040000	5768.376000	-48.8	-76.5	-35.8
836.400000	5854.836300	-41.8	-69.5	-28.8
848.970000	5942.700400	-41.6	-69.3	-28.6
824.040000	6592.140300	-41.7	-69.4	-28.7
836.400000	6691.437500	-41.5	-69.2	-28.5
848.970000	6791.896400	-42.3	-70	-29.3
824.040000	7416.558600	-40.8	-68.5	-27.8
836.400000	7527.635300	-41.7	-69.4	-28.7
848.970000	7640.896300	-42.4	-70.1	-29.4
824.040000	8240.425400	-41.6	-69.3	-28.6
836.400000	8363.986600	-42.4	-70.1	-29.4
848.970000	8489.890700	-42.6	-70.3	-29.6
824.040000	9064.304100	-41.5	-69.2	-28.5
836.400000	9200.380100	-42.9	-70.6	-29.9
848.970000	9338.583400	-41.7	-69.4	-28.7
824.040000	9888.525800	-42.3	-70	-29.3
836.400000	10036.570500	-42.2	-69.9	-29.2
848.970000	10187.710700	-41.5	-69.2	-28.5
824.040000	10712.349800	-42.4	-70.1	-29.4
836.400000	10873.220900	-41.7	-69.4	-28.7
848.970000	11036.537300	-41.6	-69.3	-28.6
824.040000	11536.527600	-41.2	-68.9	-28.2
836.400000	11709.540800	-41.5	-69.2	-28.5
848.970000	11885.704900	-40.6	-68.3	-27.6
824.040000	12360.611400	-41.6	-69.3	-28.6
836.400000	12545.925000	-37.8	-65.5	-24.8
848.970000	12734.430500	-37.4	-65.1	-24.4

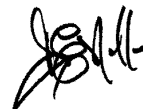

PERFORMED BY:

Doug Noble, B.A.S. E.E.T.

PAGE NO. 29 of 38.

NAME OF TEST: Unwanted Emissions (Transmitter Conducted)
 g0310174: 2003-Jan-31 Fri 14:30:00
 STATE: 2:High Power

FREQUENCY TUNED, MHz	FREQUENCY EMISSION, MHz	LEVEL, dBm	LEVEL, dBc	MARGIN, dB
1851.250000	1861.200000	-34	-58.8	-21
1880.000000	1870.440000	-35.1	-59.9	-22.1
1908.750000	1890.070000	-34.7	-59.5	-21.7
1908.750000	1898.880000	-33.4	-58.2	-20.4
1851.250000	3702.510000	-53.1	-77.9	-40.1
1880.000000	3760.001000	-54	-78.8	-41
1908.750000	3817.604000	-52.9	-77.7	-39.9
1851.250000	5553.528600	-54.1	-78.9	-41.1
1880.000000	5640.194900	-54.5	-79.3	-41.5
1908.750000	5726.416900	-53.7	-78.5	-40.7
1851.250000	7404.905900	-47.8	-72.6	-34.8
1880.000000	7520.144900	-46.7	-71.5	-33.7
1908.750000	7634.876000	-47.6	-72.4	-34.6
1851.250000	9256.487500	-46.8	-71.6	-33.8
1880.000000	9399.875100	-48.6	-73.4	-35.6
1908.750000	9543.691800	-47.9	-72.7	-34.9
1851.250000	11107.329300	-47.5	-72.3	-34.5
1880.000000	11280.087600	-47.9	-72.7	-34.9
1908.750000	11452.511900	-47.5	-72.3	-34.5
1851.250000	12958.938900	-43.1	-67.9	-30.1
1880.000000	13159.810300	-42.5	-67.3	-29.5
1908.750000	13361.278000	-43.4	-68.2	-30.4
1851.250000	14809.879500	-41.4	-66.2	-28.4
1880.000000	15039.811600	-42.9	-67.7	-29.9
1908.750000	15270.124000	-41.3	-66.1	-28.3
1851.250000	16661.341500	-41.5	-66.3	-28.5
1880.000000	16919.933800	-42.2	-67	-29.2
1908.750000	17178.961900	-41.8	-66.6	-28.8
1851.250000	18512.360500	-41.3	-66.1	-28.3
1880.000000	18800.207200	-36.9	-61.7	-23.9
1908.750000	19087.565700	-36	-60.8	-23
1851.250000	20363.708900	-34.8	-59.6	-21.8
1880.000000	20679.839300	-34.9	-59.7	-21.9
1908.750000	20996.127000	-34.1	-58.9	-21.1

PERFORMED BY:

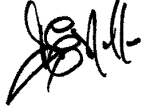
 Doug Noble, B.A.S. E.E.T.

PAGE NO. 30 of 38.

NAME OF TEST: Field Strength of Spurious Radiation

SPECIFICATION: 47 CFR 2.1053(a)

GUIDE: ANSI/TIA/EIA-603-1992/2001, Paragraph 1.2.12 and Table 16, 47 CFR 22.917

MEASUREMENT PROCEDURE

1.2.12.1 Definition: Radiated spurious emissions are emissions from the equipment when transmitting into a non-radiating load on a frequency or frequencies which are outside an occupied band sufficient to ensure transmission of information of required quality for the class of communications desired.

1.2.12.2 Method of Measurement

- A) Connect the equipment as illustrated
- B) Adjust the spectrum analyzer for the following settings:
- 1) Resolution Bandwidth 100 kHz (<1 GHz), 1 MHz (> 1GHz).
 - 2) Video Bandwidth ≥ 3 times Resolution Bandwidth, or 30 kHz (22.917)
 - 3) Sweep Speed ≤ 2000 Hz/second
 - 4) Detector Mode = Mean or Average Power
- C) Place the transmitter to be tested on the turntable in the standard test site. The transmitter is transmitting into a non-radiating load which is placed on the turntable. The RF cable to this load should be of minimum length.

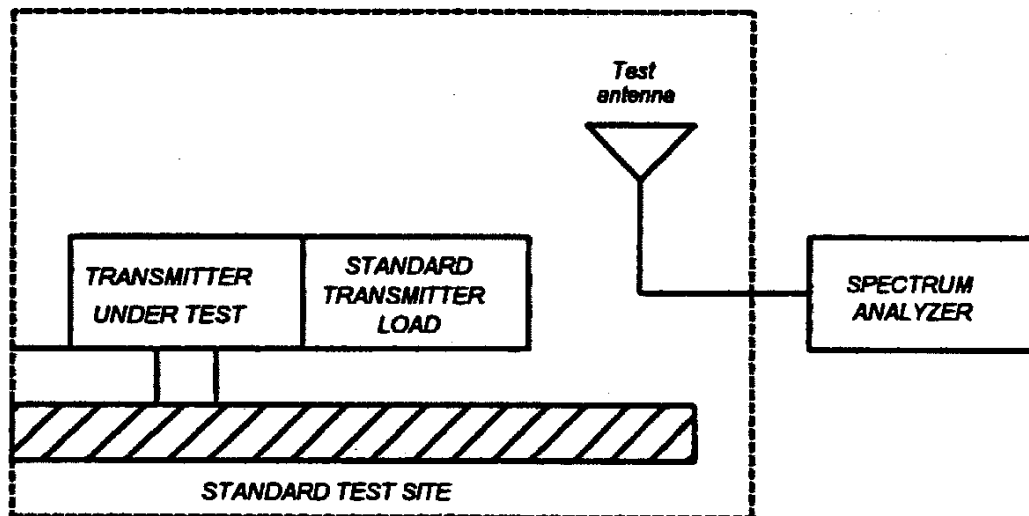

PAGE NO. 31 of 38.

NAME OF TEST: Field Strength of Spurious Radiation (Cont.)

- D) For each spurious measurement the test antenna should be adjusted to the correct length for the frequency involved. This length may be determined from a calibration ruler supplied with the equipment. Measurements shall be made from the lowest radio frequency generated in the equipment to the tenth harmonic of the carrier, except for the region close to the carrier equal to \pm the test bandwidth (see section 1.3.4.4).
- E) For each spurious frequency, raise and lower the test antenna from 1 m to 4 m to obtain a maximum reading on the spectrum analyzer with the test antenna at horizontal polarity. Repeat this procedure to obtain the highest possible reading. Record this maximum reading.
- F) Repeat step E) for each spurious frequency with the test antenna polarized vertically.

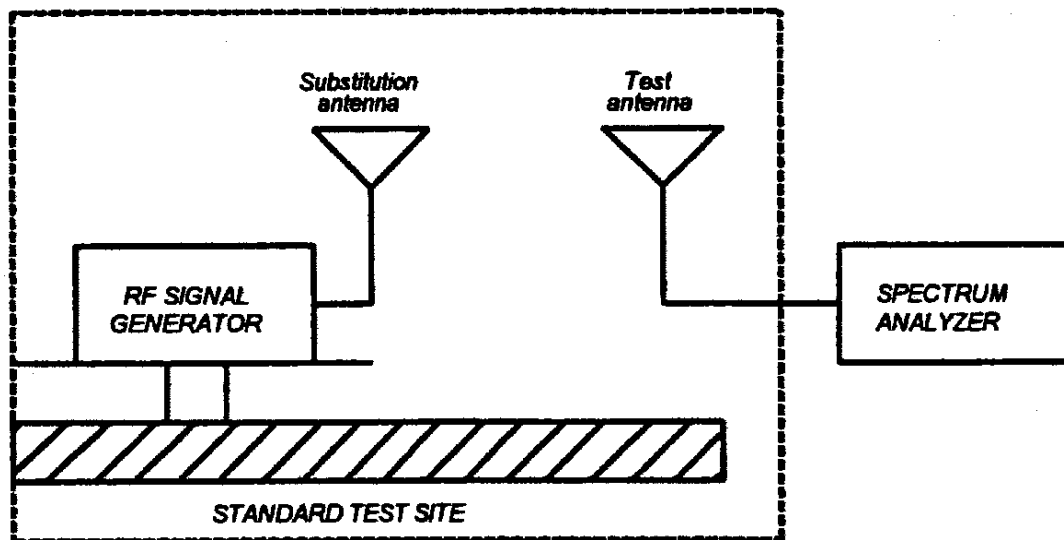

- G) Reconnect the equipment as illustrated.
- H) Keep the spectrum analyzer adjusted as in step B).
- I) Remove the transmitter and replace it with a substitution antenna (the antenna should be half-wavelength for each frequency involved). The center of the substitution antenna should be approximately at the same location as the center of the transmitter. At lower frequencies, where the substitution antenna is very long, this will be impossible to achieve when the antenna is polarized vertically. In such case the lower end of the antenna should be 0.3 m above the ground.

PAGE NO. 32 of 38.

NAME OF TEST: Field Strength of Spurious Radiation (Cont.)

- J) Feed the substitution antenna at the transmitter end with a signal generator connected to the antenna by means of a non-radiating cable. With the antennas at both ends horizontally polarized and with the signal generator tuned to a particular spurious frequency, raise and lower the test antenna to obtain a maximum reading at the spectrum analyzer. Adjust the level of the signal generator output until the previously recorded maximum reading for this set of conditions is obtained. This should be done carefully repeating the adjustment of the test antenna and generator output.
- K) Repeat step J) with both antennas vertically polarized for each spurious frequency.
- L) Calculate power in dBm into a reference ideal half-wave dipole antenna by reducing the readings obtained in steps J) and K) by the power loss in the cable between the generator and the antenna and further corrected for the gain of the substitution antenna used relative to an ideal half-wave dipole antenna.
- M) The levels recorded in step L) are absolute levels of radiated spurious emissions in dBm. The radiated spurious emissions in dB can be calculated by the following:

Radiated spurious emissions dB =
 $10 \log_{10}(\text{TX power in watts}/0.001) - \text{the levels in step l)}$

NOTE: It is permissible that other antennas provided can be referenced to a dipole.

Test Equipment:

Asset Description (as applicable)	s/n	Cycle	Last Cal
<u>TRANSDUCER</u>			
i00088 EMCO 3109-B 25MHz-300MHz	2336	12 mo.	Sep-02
i00065 EMCO 3301-B Active Monopole	2635	12 mo.	Sep-02
i00089 Aprel 2001 200MHz-1GHz	001500	12 mo.	Sep-02
i00103 EMCO 3115 1GHz-18GHz	9208-3925	12 mo.	Sep-02
<u>AMPLIFIER</u>			
i00028 HP 8449A	2749A00121	12 mo.	Mar-02
<u>SPECTRUM ANALYZER</u>			
i00029 HP 8563E	3213A00104	12 mo.	Jan-03
i00033 HP 85462A	3625A00357	12 mo.	Jan-03
i00048 HP 8566B	2511AD1467	6 mo.	Jan-03

Per ANSI C63.4-1992/2000 Draft, 10.1.4

PAGE NO. 33 of 38.

NAME OF TEST: Field Strength of Spurious Radiation

STATE: 2:High Power g0310150: 2003-Jan-29 Wed 11:58:00

FREQUENCY TUNED, MHz	FREQUENCY EMISSION, MHz	ERP, dBm	ERP, dbc
836.400000	1672.833334	-67	≤ -76.9
836.400000	2509.200001	-61	≤ -76.9
836.400000	3345.650001	-60	≤ -76.9
836.400000	4182.066668	-58.1	≤ -76.9
836.400000	5018.483335	-57.8	≤ -76.9
836.400000	5854.900002	-55.1	≤ -76.9
836.400000	6691.316669	-55.8	≤ -76.9
836.400000	7527.733336	-54.6	≤ -76.9
836.400000	8364.150003	-52.9	≤ -76.9

STATE: 2:High Power g0310149: 2003-Jan-29 Wed 11:32:00

FREQUENCY TUNED, MHz	FREQUENCY EMISSION, MHz	ERP, dBm	EIRP, dbc
1880.000000	3760.033334	-47.4	≤ -57
1880.000000	5640.050001	-44.5	≤ -57
1880.000000	7520.066668	-44.6	≤ -57
1880.000000	9400.083335	-40.7	≤ -57
1880.000000	11280.100002	-40.2	≤ -57
1880.000000	13160.116669	-38.6	≤ -57
1880.000000	15040.133336	-38.1	≤ -57
1880.000000	16920.150003	-35.1	≤ -57

PERFORMED BY:

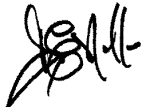
 Doug Noble, B.A.S. E.E.T.

PAGE NO. 34 of 38.
NAME OF TEST: Frequency Stability (Temperature Variation)
SPECIFICATION: 47 CFR 2.1055(a)(1)
TEST CONDITIONS: As Indicated
TEST EQUIPMENT: As per previous page

MEASUREMENT PROCEDURE

1. The EUT and test equipment were set up as shown on the following page.
2. With all power removed, the temperature was decreased to -30°C and permitted to stabilize for three hours. Power was applied and the maximum change in frequency was noted within one minute.
3. With power OFF, the temperature was raised in 10°C steps. The sample was permitted to stabilize at each step for at least one-half hour. Power was applied and the maximum frequency change was noted within one minute.
4. The temperature tests were performed for the worst case.
5. MEASUREMENT RESULTS: ATTACHED

TRANSMITTER TEST SET-UP

- TEST A. OPERATIONAL STABILITY
- TEST B. CARRIER FREQUENCY STABILITY
- TEST C. OPERATIONAL PERFORMANCE STABILITY
- TEST D. HUMIDITY
- TEST E. VIBRATION
- TEST F. ENVIRONMENTAL TEMPERATURE
- TEST G. FREQUENCY STABILITY: TEMPERATURE VARIATION
- TEST H. FREQUENCY STABILITY: VOLTAGE VARIATION

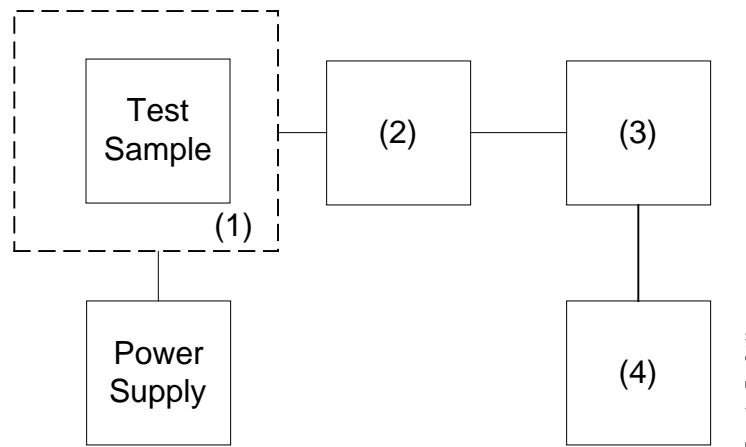

Asset Description (as applicable)	s/n
<u>(1) TEMPERATURE, HUMIDITY, VIBRATION</u>	
i00027 Tenney Temp. Chamber	9083-765-234
i00 Weber Humidity Chamber	
i00 L.A.B. RVH 18-100	
<u>(2) COAXIAL ATTENUATOR</u>	
i00122 NARDA 766-10	7802
i00123 NARDA 766-10	7802A
i00113 SIERRA 661A-3D	1059
i00069 BIRD 8329 (30 dB)	10066
<u>(3) R.F. POWER</u>	
i00014 HP 435A POWER METER	1733A05839
i00039 HP 436A POWER METER	2709A26776
i00020 HP 8901A POWER MODE	2105A01087
<u>(4) FREQUENCY COUNTER</u>	
i00042 HP 5383A	1628A00959
i00019 HP 5334B	2704A00347
i00020 HP 8901A	2105A01087

PAGE NO.

36 of 38. AMENDED March 3, 2003

NAME OF TEST:

Frequency Stability (Temperature Variation)

<u>TEMPERATURE, °C</u>	<u>CHANGE, Hz</u>	<u>PPM</u>
-30	231	0.28
-20	264	0.32
-10	214	0.26
0	115	0.14
10	58	0.07
20	41	0.05
30	-25	-0.3
40	-288	-0.35
50	-387	-0.47

PERFORMED BY:

Doug Noble, B.A.S. E.E.T.

PAGE NO. 37 of 38.
NAME OF TEST: Frequency Stability (Voltage Variation)
SPECIFICATION: 47 CFR 2.1055 (b)(1)
TEST EQUIPMENT: As per previous page

MEASUREMENT PROCEDURE

1. The EUT was placed in a temperature chamber at 25±5°C and connected as for "Frequency Stability - Temperature Variation" test.
2. The power supply voltage to the EUT was varied from 85% to 115% of the nominal value measured at the input to the EUT.
3. The variation in frequency was measured for the worst case.

Use 'best' data only.');

RESULTS: Frequency Stability (Voltage Variation)

g02b0036: 2003-Jan-30

STATE: 0:General

LIMIT, ppm = 5
 LIMIT, Hz = 4182
 BATTERY END POINT (Voltage) = 15

% of STV	Voltage	Frequency, MHz	Change, Hz	Change, ppm
85	16.4	836.410220	-1680	-2.01
100	19.3	836.411900	0	0.00
115	22.19	836.412810	910	1.09
78	15	836.412110	210	0.25

LIMIT: Must remain within authorized frequency block.

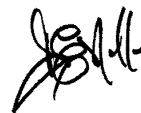

PERFORMED BY:

Doug Noble, B.A.S. E.E.T.

PAGE NO. 38 of 38.

NAME OF TEST: Necessary Bandwidth and Emission Bandwidth

SPECIFICATION: 47 CFR 2.202(g)

MODULATION = 1M25F9W

NECESSARY BANDWIDTH:

NECESSARY BANDWIDTH (B_N), kHz = 1,250
(measured at the 99.75% power bandwidth)

PERFORMED BY:

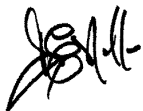
Doug Noble, B.A.S. E.E.T.

END OF TEST REPORT

TESTIMONIAL
AND
STATEMENT OF CERTIFICATION

THIS IS TO CERTIFY THAT:

1. THAT the application was prepared either by, or under the direct supervision of, the undersigned.
2. THAT the technical data supplied with the application was taken under my direction and supervision.
3. THAT the data was obtained on representative units, randomly selected.
4. THAT, to the best of my knowledge and belief, the facts set forth in the application and accompanying technical data are true and correct.

CERTIFYING ENGINEER:



Morton Flom, P. Eng.