



MET Laboratories, Inc. *Safety Certification - EMI - Telecom Environmental Simulation*

914 WEST PATAPSCO AVENUE • BALTIMORE, MARYLAND 21230-3432 • PHONE (410) 354-3300 • FAX (410) 354-3313

33439 WESTERN AVENUE • UNION CITY, CALIFORNIA 94587 • PHONE (510) 489-6300 • FAX (510) 489-6372

3162 BELICK STREET • SANTA CLARA, CA 95054 • PHONE (408) 748-3585 • FAX (510) 489-6372

13301 MCCALLEN PASS • AUSTIN, TX 78753 • PHONE (512) 287-2500 • FAX (512) 287-2513

July 3, 2013

SyChip, LLC
4441 Sigma Rd.
Dallas, TX 75244

Dear Michael Feng,

Enclosed is the EMC Wireless Class II Permissive Change test report for compliance testing of the SyChip, LLC, WiFi Module, SN8200UFL as tested to the requirements of Title 47 of the CFR, Ch. 1 (10-1-06 ed.), Part 15, Subpart C and RSS-210, Issue 8, Dec. 2010 for Intentional Radiators.

Thank you for using the services of MET Laboratories, Inc. If you have any questions regarding these results or if MET can be of further service to you, please feel free to contact me.

Sincerely yours,
MET LABORATORIES, INC.

Jennifer Warnell
Documentation Department

Reference: (\SyChip, LLC\EMCA38795-FCC247 Rev. 3)

Certificates and reports shall not be reproduced except in full, without the written permission of MET Laboratories, Inc.

Electromagnetic Compatibility Criteria Class II Permissive Change Test Report

for the

**SyChip, LLC
WiFi Module, SN8200UFL**

Tested under
the FCC Certification Rules
contained in
Title 47 of the CFR, Parts 15 Subpart C
& RSS-210, Issue 8, Dec. 2010
for Intentional Radiators

MET Report: EMCA38795-FCC247 Rev. 3

July 3, 2013

Prepared For:

**SyChip, LLC
4441 Sigma Rd.
Dallas, TX 75244**

Prepared By:
MET Laboratories, Inc.
914 W. Patapsco Ave
Baltimore, MD 21230

Electromagnetic Compatibility Criteria Class II Permissive Change Test Report

for the

SyChip, LLC
WiFi Module, SN8200UFL

Tested under
the FCC Certification Rules
contained in
Title 47 of the CFR, Parts 15 Subpart C
& RSS-210, Issue 8, Dec. 2010
for Intentional Radiators



Erik Ray, Project Engineer
Electromagnetic Compatibility Lab



Jennifer Warnell
Documentation Department

Engineering Statement: The measurements shown in this report were made in accordance with the procedures indicated, and the emissions from this equipment were found to be within the limits applicable. I assume full responsibility for the accuracy and completeness of these measurements, and for the qualifications of all persons taking them. It is further stated that upon the basis of the measurements made, the equipment tested is capable of operation in accordance with the requirements of the FCC Rules Part 15.247 and Industry Canada standard RSS-210, Issue 8, Dec. 2010 under normal use and maintenance.



Asad Bajwa,
Director, Electromagnetic Compatibility Lab

Report Status Sheet

Revision	Report Date	Reason for Revision
∅	June 18, 2013	Initial Issue.
1	June 21, 2013	Revised to reflect customer corrections.
2	June 27, 2013	Revised to reflect customer address.
3	July 3, 2013	Revised to add RF Exposure.

Table of Contents

I.	Executive Summary	1
	A. Purpose of Test	2
	B. Executive Summary	2
II.	Equipment Configuration	3
	A. Overview.....	4
	B. References.....	5
	C. Test Site	5
	D. Description of Test Sample.....	6
	E. Equipment Configuration.....	8
	F. Support Equipment	8
	G. Ports and Cabling Information.....	8
	H. Mode of Operation.....	9
	I. Method of Monitoring EUT Operation	9
	J. Modifications	9
	a) Modifications to EUT.....	9
	b) Modifications to Test Standard.....	9
	K. Disposition of EUT	9
III.	Electromagnetic Compatibility Criteria for Intentional Radiators.....	10
	§ 15.203 Antenna Requirement	11
	§ 15.247(d) Radiated Spurious Emissions Requirements and Band Edge.....	12
IV.	Test Equipment	33
V.	Certification & User’s Manual Information	35
	A. Certification Information	36
	B. Label and User’s Manual Information	40
VI.	ICES-003 Procedural & Labeling Requirements.....	42

List of Tables

Table 1. Executive Summary of EMC Part 15.247 Compliance Testing	2
Table 2. EUT Summary Table.....	4
Table 3. References	5
Table 4. Equipment Configuration	8
Table 5. Support Equipment.....	8
Table 6. Ports and Cabling Information	8
Table 7. Antenna List	11
Table 8. Restricted Bands of Operation.....	12
Table 9. Radiated Emissions Limits Calculated from FCC Part 15, § 15.209 (a)	13
Table 10. Test Equipment List	34

List of Plots

Plot 1. Radiated Spurious Emissions, 802.11b, Low Channel, 30 MHz – 1 GHz.....	14
Plot 2. Radiated Spurious Emissions, 802.11b, Low Channel, 1 GHz – 18 GHz.....	14
Plot 3. Radiated Spurious Emissions, 802.11b, Low Channel, 18 GHz – 26.5 GHz.....	14
Plot 4. Radiated Spurious Emissions, 802.11b, Mid Channel, 30 MHz – 1 GHz.....	15
Plot 5. Radiated Spurious Emissions, 802.11b, Mid Channel, 1 GHz – 18 GHz	15
Plot 6. Radiated Spurious Emissions, 802.11b, Mid Channel, 18 GHz – 26.5 GHz	15
Plot 7. Radiated Spurious Emissions, 802.11b, High Channel, 30 MHz – 1 GHz	16
Plot 8. Radiated Spurious Emissions, 802.11b, High Channel, 1 GHz – 18 GHz.....	16
Plot 9. Radiated Spurious Emissions, 802.11b, High Channel, 18 GHz – 26.5 GHz	16
Plot 10. Radiated Spurious Emissions, 802.11g, Low Channel, 30 MHz – 1 GHz.....	17
Plot 11. Radiated Spurious Emissions, 802.11g, Low Channel, 1 GHz – 18 GHz.....	17
Plot 12. Radiated Spurious Emissions, 802.11g, Low Channel, 18 GHz – 26.5 GHz.....	17
Plot 13. Radiated Spurious Emissions, 802.11g, Mid Channel, 30 MHz – 1 GHz.....	18
Plot 14. Radiated Spurious Emissions, 802.11g, Mid Channel, 1 GHz – 18 GHz	18
Plot 15. Radiated Spurious Emissions, 802.11g, Mid Channel, 18 GHz – 26.5 GHz	18
Plot 16. Radiated Spurious Emissions, 802.11g, High Channel, 30 MHz – 1 GHz	19
Plot 17. Radiated Spurious Emissions, 802.11g, High Channel, 1 GHz – 18 GHz.....	19
Plot 18. Radiated Spurious Emissions, 802.11g, High Channel, 18 GHz – 26.5 GHz.....	19
Plot 19. Radiated Spurious Emissions, 802.11n, Low Channel, 30 MHz – 1 GHz.....	20
Plot 20. Radiated Spurious Emissions, 802.11n, Low Channel, 1 GHz – 18 GHz.....	20
Plot 21. Radiated Spurious Emissions, 802.11n, Low Channel, 18 GHz – 26.5 GHz.....	20
Plot 22. Radiated Spurious Emissions, 802.11n, Mid Channel, 30 MHz – 1 GHz.....	21
Plot 23. Radiated Spurious Emissions, 802.11n, Mid Channel, 1 GHz – 18 GHz	21
Plot 24. Radiated Spurious Emissions, 802.11n, Mid Channel, 18 GHz – 26.5 GHz	21
Plot 25. Radiated Spurious Emissions, 802.11n, High Channel, 30 MHz – 1 GHz	22
Plot 26. Radiated Spurious Emissions, 802.11n, High Channel, 1 GHz – 18 GHz.....	22
Plot 27. Radiated Spurious Emissions, 802.11n, High Channel, 18 GHz – 26.5 GHz.....	22
Plot 28. Radiated Restricted Band, 802.11b, Low Channel, Peak.....	23
Plot 29. Radiated Restricted Band, 802.11b, Low Channel, Average	23
Plot 30. Radiated Restricted Band, 802.11b, High Channel, Peak	24
Plot 31. Radiated Restricted Band, 802.11b, High Channel, Average	24
Plot 32. Radiated Restricted Band, 802.11g, Low Channel, Peak.....	25
Plot 33. Radiated Restricted Band, 802.11g, Low Channel, Average	25
Plot 34. Radiated Restricted Band, 802.11g, High Channel, Peak	26
Plot 35. Radiated Restricted Band, 802.11g, High Channel, Average	26
Plot 36. Radiated Restricted Band, 802.11n, Low Channel, Peak.....	27
Plot 37. Radiated Restricted Band, 802.11n, Low Channel, Average	27

Plot 38. Radiated Restricted Band, 802.11n, High Channel, Peak28
 Plot 39. Radiated Restricted Band, 802.11n, High Channel, Average28

List of Figures

Figure 1. Block Diagram of Test Configuration..... 7

List of Photographs

Photograph 1. SyChip, LLC WiFi Module, SN8200UFL 6
 Photograph 2. Radiated Spurious Emissions, Test Setup, 30 MHz – 1 GHz.....29
 Photograph 3. Radiated Spurious Emissions, Test Setup, 1 GHz – 18 GHz29
 Photograph 4. Radiated Spurious Emissions, Test Setup, 18 GHz – 26.5 GHz30
 Photograph 5. Radiated Spurious Emissions, Test Setup, Rear.....30
 Photograph 6. Radiated Restricted Band, Test Setup31

List of Terms and Abbreviations

AC	Alternating Current
ACF	Antenna Correction Factor
Cal	Calibration
<i>d</i>	Measurement Distance
dB	Decibels
dB μ A	Decibels above one microamp
dB μ V	Decibels above one microvolt
dB μ A/m	Decibels above one microamp per meter
dB μ V/m	Decibels above one microvolt per meter
DC	Direct Current
E	Electric Field
DSL	Digital Subscriber Line
ESD	Electrostatic Discharge
EUT	Equipment Under Test
<i>f</i>	Frequency
FCC	Federal Communications Commission
GRP	Ground Reference Plane
H	Magnetic Field
HCP	Horizontal Coupling Plane
Hz	Hertz
IEC	International Electrotechnical Commission
kHz	kilohertz
kPa	kilopascal
kV	kilovolt
LISN	Line Impedance Stabilization Network
MHz	Megahertz
μ H	microhenry
μ	microfarad
μ s	microseconds
NEBS	Network Equipment-Building System
PRF	Pulse Repetition Frequency
RF	Radio Frequency
RMS	Root-Mean-Square
TWT	Traveling Wave Tube
V/m	Volts per meter
VCP	Vertical Coupling Plane

I. Executive Summary

A. Purpose of Test

An EMC evaluation was performed to determine Class II Permissive Change compliance of the SyChip, LLC WiFi Module, SN8200UFL, with the requirements of Part 15, §15.247. All references are to the most current version of Title 47 of the Code of Federal Regulations in effect. In accordance with §2.1033, the following data is presented in support of the Certification of the WiFi Module, SN8200UFL. SyChip, LLC should retain a copy of this document which should be kept on file for at least two years after the manufacturing of the WiFi Module, SN8200UFL, has been **permanently** discontinued.

B. Executive Summary

The following tests were conducted on a sample of the equipment for the purpose of demonstrating Class II Permissive Change compliance with Part 15, §15.247, in accordance with RF Monolithics, purchase order number 50886. All tests were conducted using measurement procedure ANSI C63.4-2003.

FCC Reference 47 CFR Part 15.247:2005	IC Reference RSS-210 Issue 8: 2010; RSS-GEN Issues 3: 2010	Description	Compliance
Title 47 of the CFR, Part 15 §15.203	N/A	Antenna Requirement	Compliant
Title 47 of the CFR, Part 15 §15.247(d); §15.209; §15.205	RSS-210(A8.5)	Radiated Spurious Emissions	Compliant

Table 1. Executive Summary of EMC Part 15.247 Compliance Testing

II. Equipment Configuration

A. Overview

MET Laboratories, Inc. was contracted by SyChip, LLC to perform testing on the WiFi Module, SN8200UFL, under RF Monolithics' purchase order number 50886.

This document describes the test setups, test methods, required test equipment, and the test limit criteria used to perform compliance testing of the SyChip, LLC, WiFi Module, SN8200UFL.

The results obtained relate only to the item(s) tested.

Model(s) Tested:	WiFi Module, SN8200UFL	
Model(s) Covered:	WiFi Module, SN8205UFL and SN8206UFL	
EUT Specifications:	Primary Power: 3.6 V	
	FCC ID: QPU8200 IC: 4523A-SN8200	
	Type of Modulations:	DSSS, OFDM
	Equipment Code:	DTS
	Peak RF Output Power:	802.11g, High Channel (2462MHz) 22.1dBm
	EUT Frequency Ranges:	2412 MHz to 2462 MHz
Analysis:	The results obtained relate only to the item(s) tested.	
Environmental Test Conditions:	Temperature: 15-35° C	
	Relative Humidity: 30-60%	
	Barometric Pressure: 860-1060 mbar	
Evaluated by:	Erik Ray	
Report Date(s):	July 3, 2013	

Table 2. EUT Summary Table

B. References

CFR 47, Part 15, Subpart C	Federal Communication Commission, Code of Federal Regulations, Title 47, Part 15: General Rules and Regulations, Allocation, Assignment, and Use of Radio Frequencies
RSS-210, Issue 8, Dec. 2010	Low-power Licence-exempt Radiocommunications Devices (All Frequency Bands): Category I Equipment
RSS-GEN, Issue 3, Dec. 2010	General Requirements and Information for the Certification of Radio Apparatus
ANSI C63.4:2003	Methods and Measurements of Radio-Noise Emissions from Low-Voltage Electrical And Electronic Equipment in the Range of 9 kHz to 40 GHz
ISO/IEC 17025:2005	General Requirements for the Competence of Testing and Calibration Laboratories
ANSI C63.10-2009	American National Standard for Testing Unlicensed Wireless Devices

Table 3. References

C. Test Site

All testing was performed at MET Laboratories, Inc., 13301 McCallen Pass, Austin, TX 78753. All equipment used in making physical determinations is accurate and bears recent traceability to the National Institute of Standards and Technology.

Radiated Emissions measurements were performed in a 10 meter semi-anechoic chamber (equivalent to an Open Area Test Site). In accordance with §2.948(a)(3), a complete site description is contained at MET Laboratories.

D. Description of Test Sample

The SyChip, LLC WiFi Module, SN8200UFL, Equipment Under Test (EUT), is a complete low power self-contained embedded wireless solution to address the connectivity demand in M2M applications. It integrates micro-controller, Wi-Fi BB/MAC/RF IC, RF front end, clocks, and on-board antenna into a small form factor module. SN8200 can be controlled by a host device through a serial interface; it can also serve as a standalone Wi-Fi station or network controller. Thus, it can be used to enable wireless connectivity to the simplest products with minimal engineering resources.

The SN8200 provides standard IEEE802.11 b/g/n functions. The integrated MCU supports Broadcom WICED™ software. It can be used for a variety of different applications, such as wireless sensor node, serial to Wi-Fi transceiver, Wi-Fi network controller, Wi-Fi gateway/bridges plus internet server.

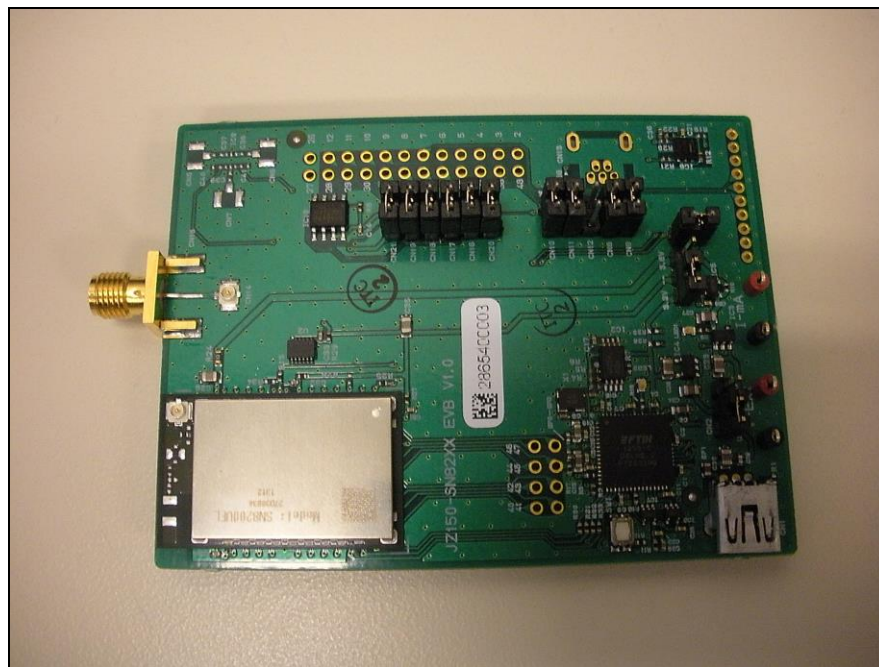

Photograph 1. SyChip, LLC WiFi Module, SN8200UFL

1.3 Block Diagram

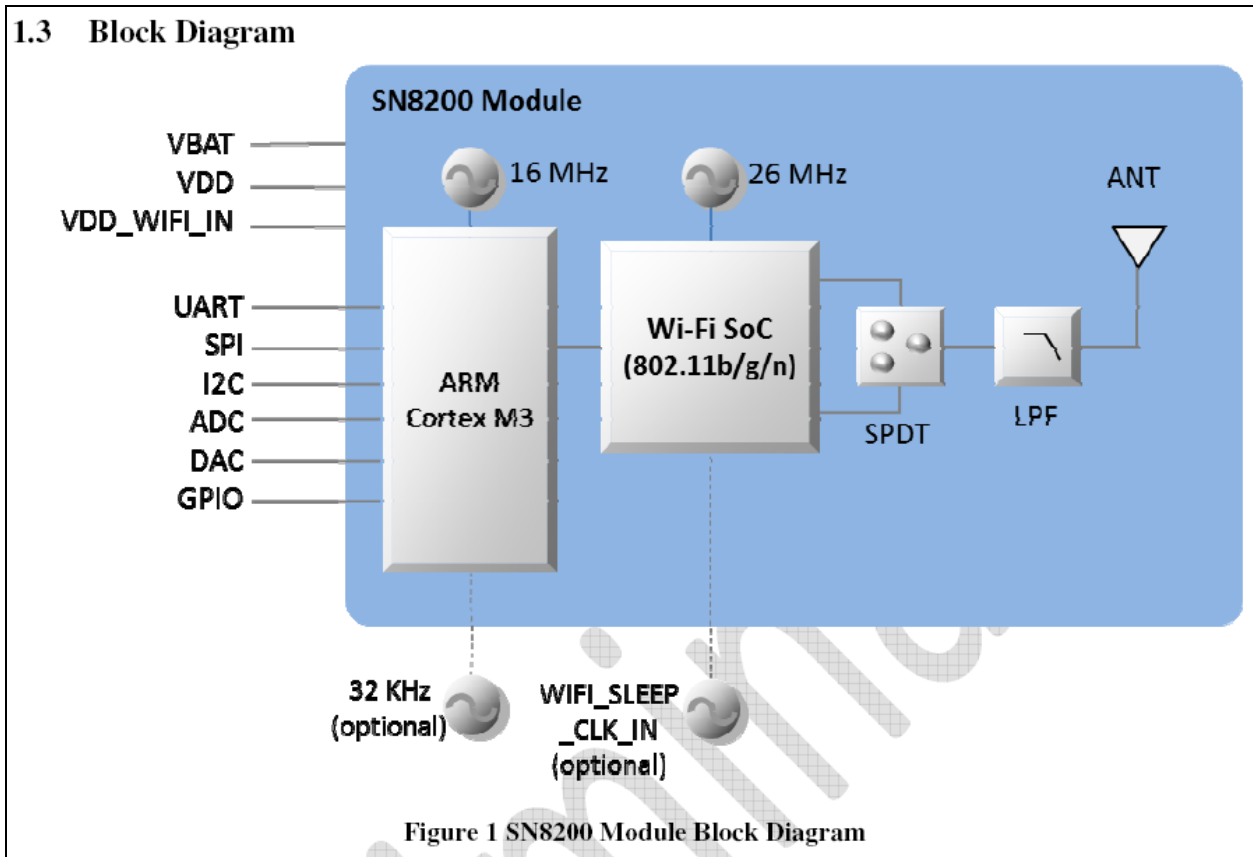

Figure 1. Block Diagram of Test Configuration

E. Equipment Configuration

The EUT was set up as outlined in Figure 1, Block Diagram of Test Setup. All cards, racks, etc., incorporated as part of the EUT is included in the following list.

Ref. ID	Name / Description	Model Number	Serial Number
1	SN8200 WiFi module	SN8200UFL	MAC: 000B6C41932F
3	Omni-directional antenna for FCC	TRF1002 Gain: 5 dBi	--

Table 4. Equipment Configuration

F. Support Equipment

Support equipment necessary for the operation and testing of the EUT is included in the following list.

Ref. ID	Name / Description	Manufacturer
1	Laptop	DELL
2	USB cable	--

Table 5. Support Equipment

G. Ports and Cabling Information

Ref. ID	Port Name on EUT	Cable Description	Qty.	Length (m)	Shielded (Y/N)	Termination Point
1	UFL on module	For antenna connection	1	--	--	--
2	SMA on carrier	For conducted measure	1	--	--	--
3	USB on carrier	For command & DC pwr	1	--	--	--

Table 6. Ports and Cabling Information

H. Mode of Operation

SN8200, a WiFi module, operates in 802.11b, g and n modes.
The operation is controlled by the command set provided (in the Laptop).
The commands are explained in a separate file.

I. Method of Monitoring EUT Operation

1. A Spectrum Analyzer can be used to monitor the RF performance.
2. A set of terminals on carrier board , marked I-mA, can be used to plot the DC current on a scope.
3. The interactive Command screen shows the status of command execution.

J. Modifications

- a) **Modifications to EUT**
No modifications were made to the EUT.
- b) **Modifications to Test Standard**
No modifications were made to the test standard.

K. Disposition of EUT

The test sample including all support equipment submitted to the Electro-Magnetic Compatibility Lab for testing was returned to SyChip, LLC upon completion of testing.

III. Electromagnetic Compatibility Criteria for Intentional Radiators

Electromagnetic Compatibility Criteria for Intentional Radiators

§ 15.203 Antenna Requirement

Test Requirement: § 15.203: An intentional radiator shall be designed to ensure that no antenna other than that furnished by the responsible party shall be used with the device. The use of a permanently attached antenna or of an antenna that uses a unique coupling to the intentional radiator shall be considered sufficient to comply with the provisions of this section. The manufacturer may design the unit so that a broken antenna can be replaced by the user, but the use of a standard antenna jack or electrical connector is prohibited.

The structure and application of the EUT were analyzed to determine compliance with Section 15.203 of the Rules. Section 15.203 states that the subject device must meet at least one of the following criteria:

- a.) Antenna must be permanently attached to the unit.
- b.) Antenna must use a unique type of connector to attach to the EUT.
- c.) Unit must be professionally installed. Installer shall be responsible for verifying that the correct antenna is employed with the unit.

Results: The EUT as tested is compliant the criteria of §15.203. The antenna has a unique UFL connector to attach to the EUT.

Test Engineer(s): Erik Ray

Test Date(s): 06/11/13

Gain	Type	Model	Manufacturer
5dBi	Omni-Directional	TRF1002	MicroChip

Table 7. Antenna List

Electromagnetic Compatibility Criteria for Intentional Radiators

§ 15.247(d) Radiated Spurious Emissions Requirements and Band Edge

Test Requirements: §15.247(d); §15.205: Emissions outside the frequency band.

§15.247(d): In any 100 kHz bandwidth outside the frequency band in which the spread spectrum or digitally modulated intentional radiator is operating, the radio frequency power that is produced by the intentional radiator shall be at least 20 dB below that in the 100 kHz bandwidth within the band that contains the highest level of the desired power, based on either an RF conducted or a radiated measurement. Attenuation below the general limits specified in § 15.209(a) is not required. In addition, radiated emissions which fall in the restricted bands, as defined in § 15.205(a), must also comply with the radiated emission limits specified in § 15.209(a).

§15.205(a): Except as shown in paragraph (d) of this section, only spurious emissions are permitted in any of the frequency bands listed below:

MHz	MHz	MHz	GHz
0.090–0.110-----	16.42–16.423	399.9–410	4.5–5.15
¹ 0.495–0.505-----	16.69475–16.69525	608–614	5.35–5.46
2.1735–2.1905-----	16.80425–16.80475	960–1240	7.25–7.75
4.125–4.128-----	25.5–25.67	1300–1427	8.025–8.5
4.17725–4.17775-----	37.5–38.25	1435–1626.5	9.0–9.2
4.20725–4.20775-----	73–74.6	1645.5–1646.5	9.3–9.5
6.215–6.218-----	74.8–75.2	1660–1710	10.6–12.7
6.26775–6.26825-----	108–121.94	1718.8–1722.2	13.25–13.4
6.31175–6.31225-----	123–138	2200–2300	14.47–14.5
8.291–8.294-----	149.9–150.05	2310–2390	15.35–16.2
8.362–8.366-----	156.52475–156.52525	2483.5–2500	17.7–21.4
8.37625–8.38675-----	156.7–156.9	2655–2900	22.01–23.12
8.41425–8.41475-----	162.0125–167.17	3260–3267	23.6–24.0
12.29–12.293-----	167.72–173.2	3332–3339	31.2–31.8
12.51975–12.52025-----	240–285	3345.8–3358.36	43–36.5
12.57675–12.57725-----	322–335.4	3600–4400	(²)

Table 8. Restricted Bands of Operation

¹ Until February 1, 1999, this restricted band shall be 0.490 – 0.510 MHz.

² Above 38.6

Test Requirement(s): § 15.209 (a): Except as provided elsewhere in this subpart, the emissions from an intentional radiator shall not exceed the field strength levels specified in Table 9.

Frequency (MHz)	§ 15.209(a), Radiated Emission Limits (dBµV) @ 3m
30 - 88	40.00
88 - 216	43.50
216 - 960	46.00
Above 960	54.00

Table 9. Radiated Emissions Limits Calculated from FCC Part 15, § 15.209 (a)

Test Procedure: The transmitter was set to the mid channel at the highest output power and placed on a 0.8 m high acrylic table inside in a semi-anechoic chamber. Measurements were performed with the EUT rotated 360 degrees and varying the adjustable antenna mast with 1 m to 4 m height to determine worst case orientation for maximum emissions. Measurements were repeated at the low and highest channels.

For frequencies from 30 MHz to 1 GHz, measurements were made using a quasi-peak detector with a 120 kHz RBW bandwidth. For frequencies above 1GHz, peak measurements were made using a 1MHz RBW and 3MHz VBW. Average measurements above 1GHz were made using a 1MHz RBW and 10Hz VBW.

For intentional radiators with a digital device portion which operates below 10 GHz, the spectrum was investigated as per §15.33(a)(1) and §15.33(a)(4); i.e., the lowest RF signal generated or used in the device up to the 10th harmonic of the highest fundamental frequency or to 40 GHz, whichever is lower.

In accordance with §15.35(b) the limit on the radio frequency emissions as measured using instrumentation with a peak detector function shall be 20 dB above the maximum permitted average limit for the frequency being investigated unless a different peak emission limit is otherwise specified in the rules.

EUT Field Strength Final Amplitude = Raw Amplitude – Preamp gain + Antenna Factor + Cable Loss – Distance Correction Factor

Test Results: The EUT was compliant with the Radiated Spurious Emission limits of §15.247(d).

Test Engineer(s): Erik Ray

Test Date(s): 06/11/13

Radiated Spurious Emissions Test Results

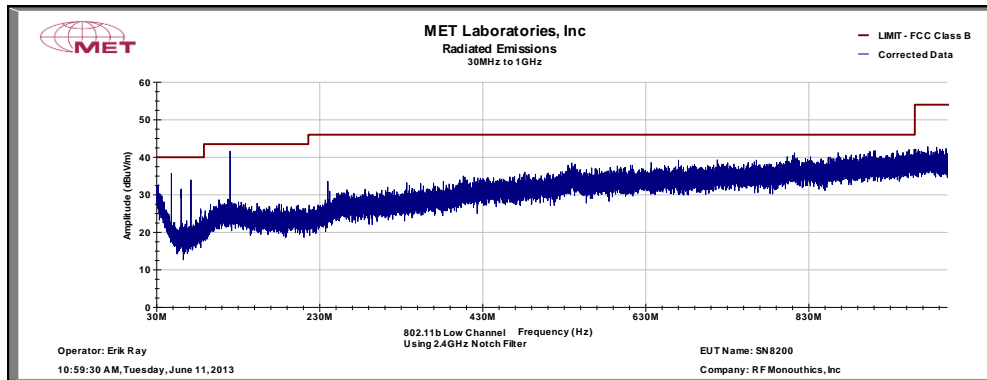

Plot 1. Radiated Spurious Emissions, 802.11b, Low Channel, 30 MHz – 1 GHz

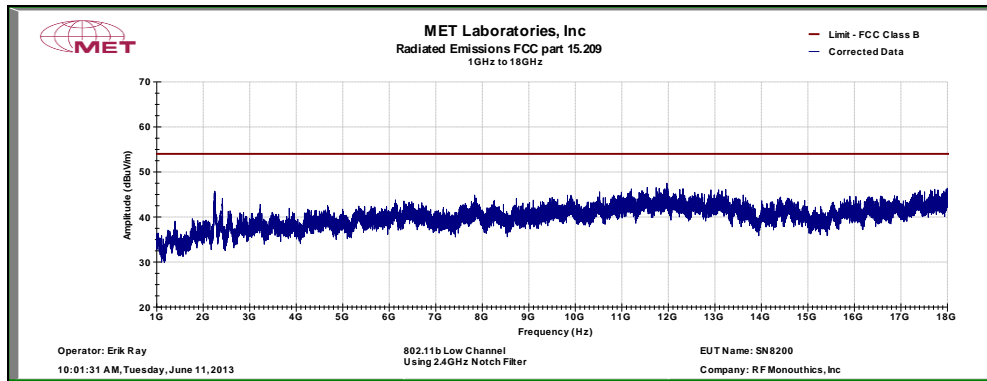

Plot 2. Radiated Spurious Emissions, 802.11b, Low Channel, 1 GHz – 18 GHz

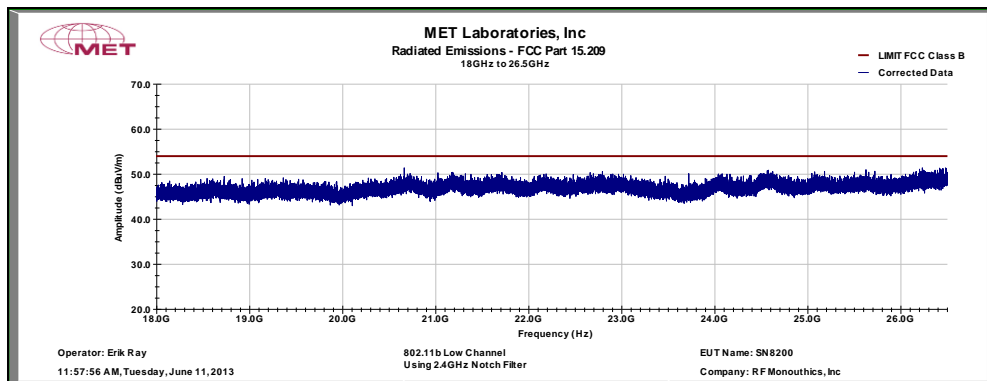

Plot 3. Radiated Spurious Emissions, 802.11b, Low Channel, 18 GHz – 26.5 GHz

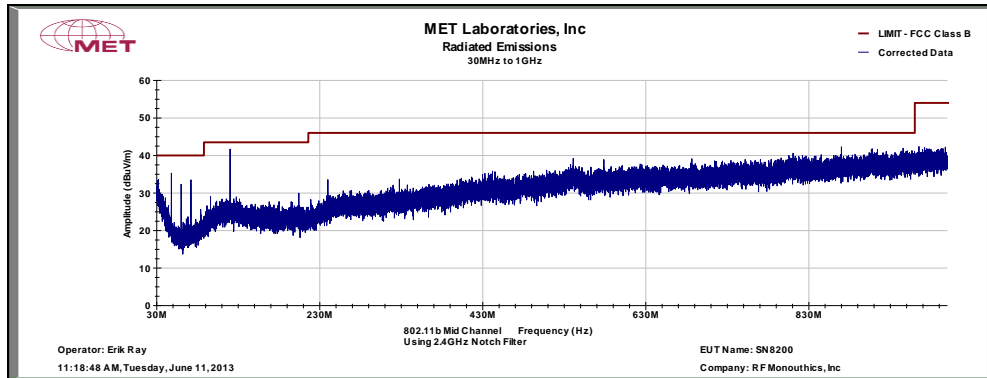

Plot 4. Radiated Spurious Emissions, 802.11b, Mid Channel, 30 MHz – 1 GHz

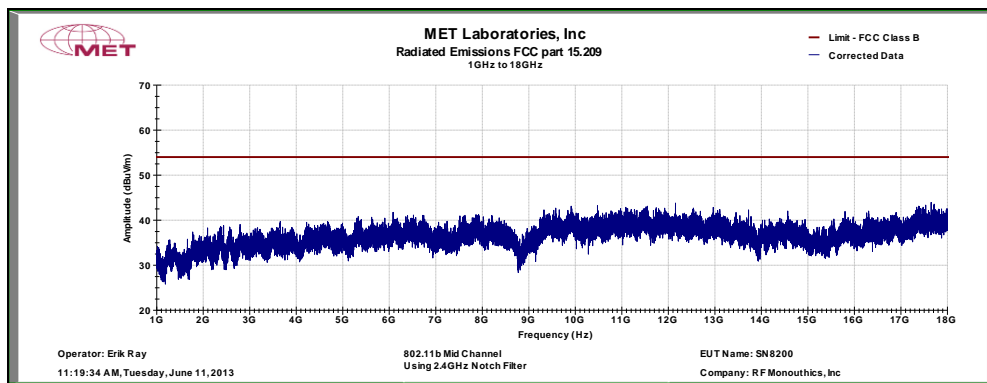

Plot 5. Radiated Spurious Emissions, 802.11b, Mid Channel, 1 GHz – 18 GHz

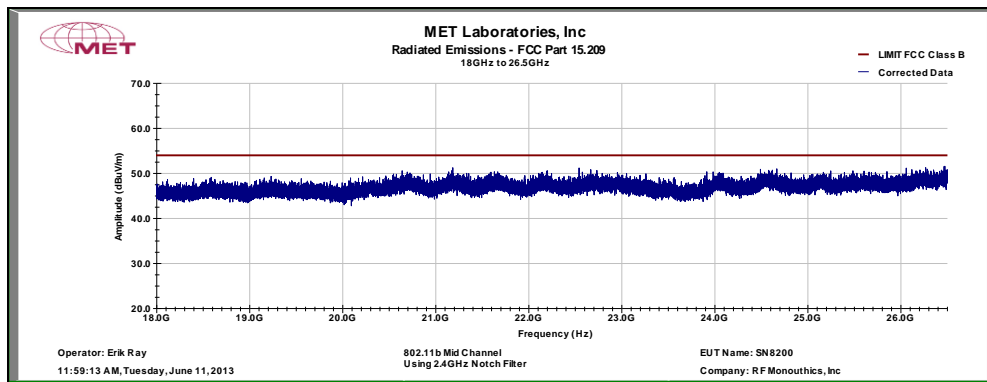

Plot 6. Radiated Spurious Emissions, 802.11b, Mid Channel, 18 GHz – 26.5 GHz

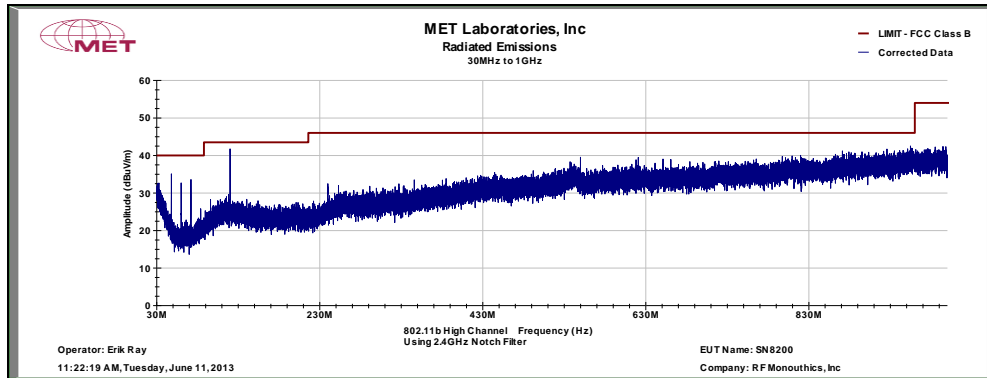

Plot 7. Radiated Spurious Emissions, 802.11b, High Channel, 30 MHz – 1 GHz

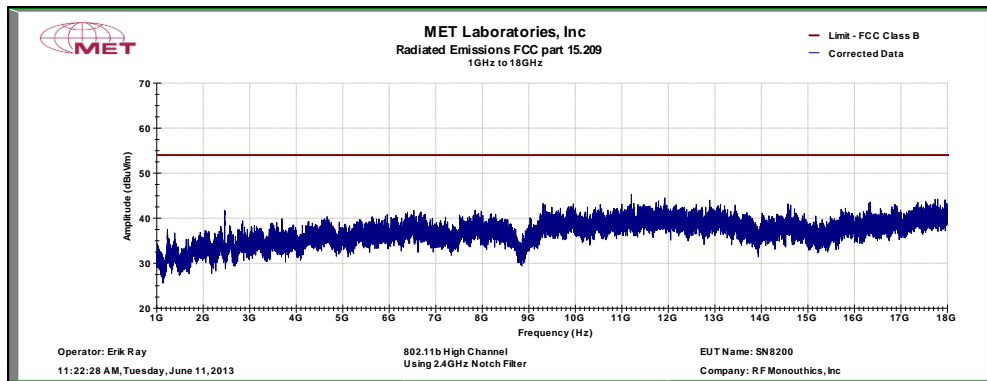

Plot 8. Radiated Spurious Emissions, 802.11b, High Channel, 1 GHz – 18 GHz

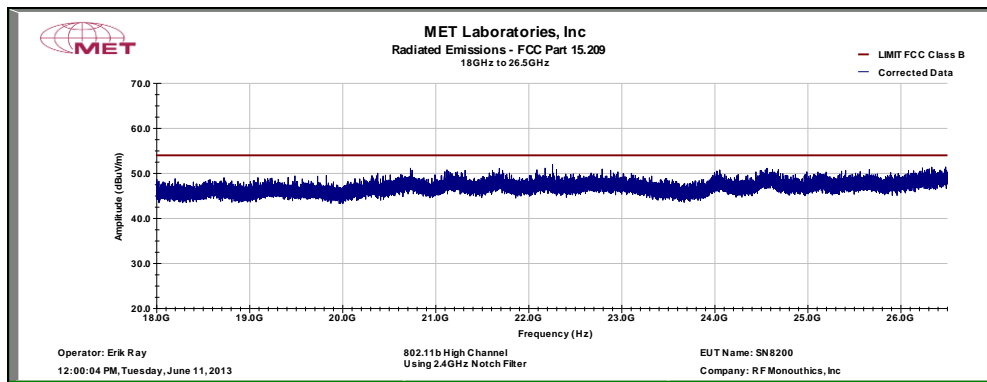

Plot 9. Radiated Spurious Emissions, 802.11b, High Channel, 18 GHz – 26.5 GHz

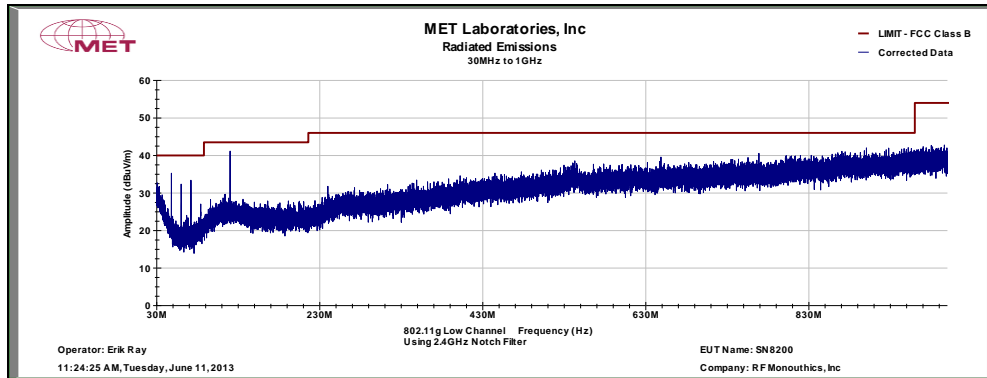

Plot 10. Radiated Spurious Emissions, 802.11g, Low Channel, 30 MHz – 1 GHz

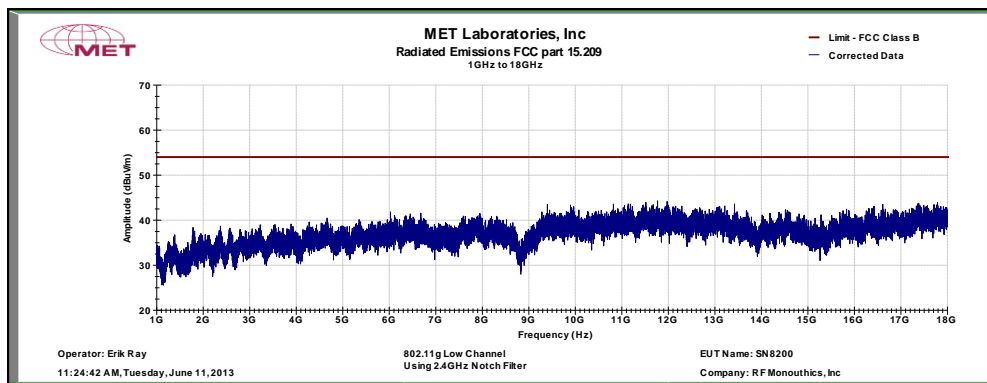

Plot 11. Radiated Spurious Emissions, 802.11g, Low Channel, 1 GHz – 18 GHz

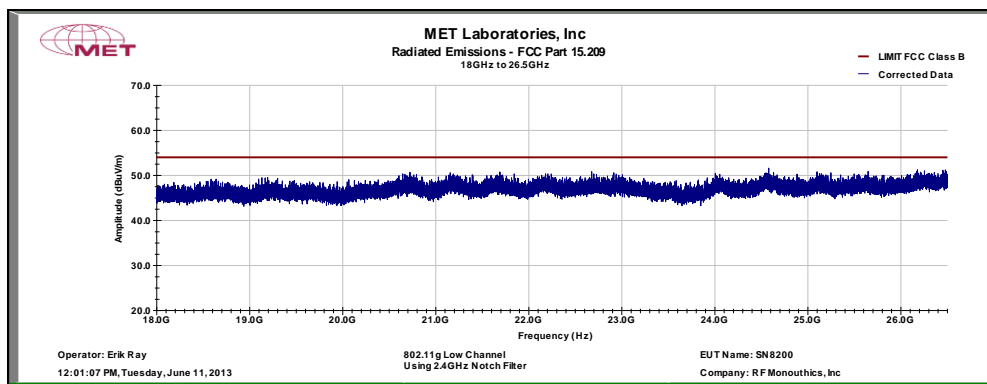

Plot 12. Radiated Spurious Emissions, 802.11g, Low Channel, 18 GHz – 26.5 GHz

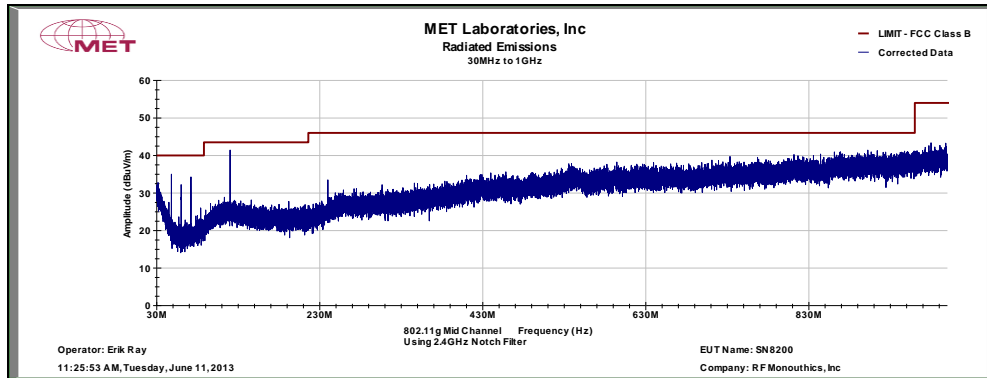

Plot 13. Radiated Spurious Emissions, 802.11g, Mid Channel, 30 MHz – 1 GHz

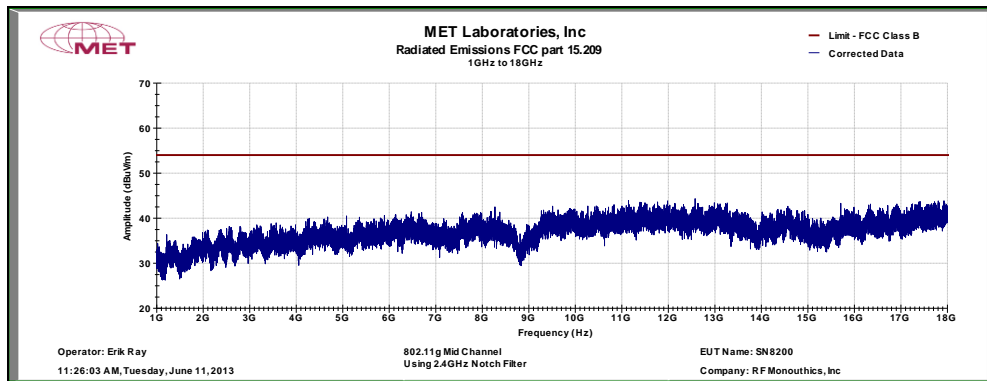

Plot 14. Radiated Spurious Emissions, 802.11g, Mid Channel, 1 GHz – 18 GHz

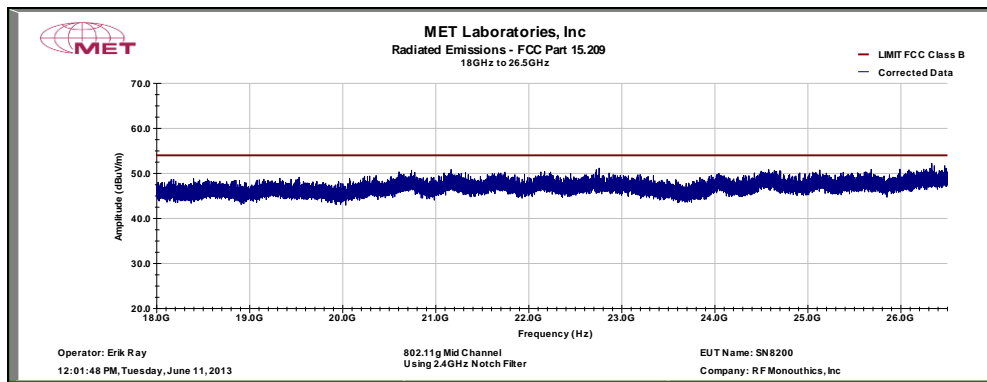

Plot 15. Radiated Spurious Emissions, 802.11g, Mid Channel, 18 GHz – 26.5 GHz

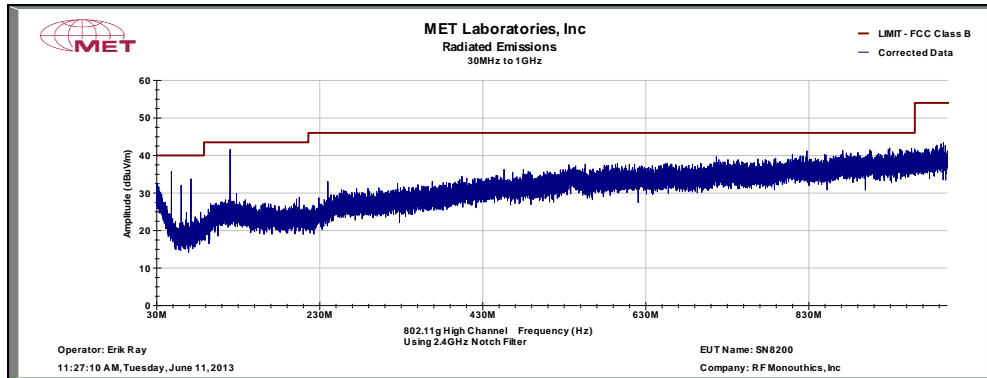

Plot 16. Radiated Spurious Emissions, 802.11g, High Channel, 30 MHz – 1 GHz

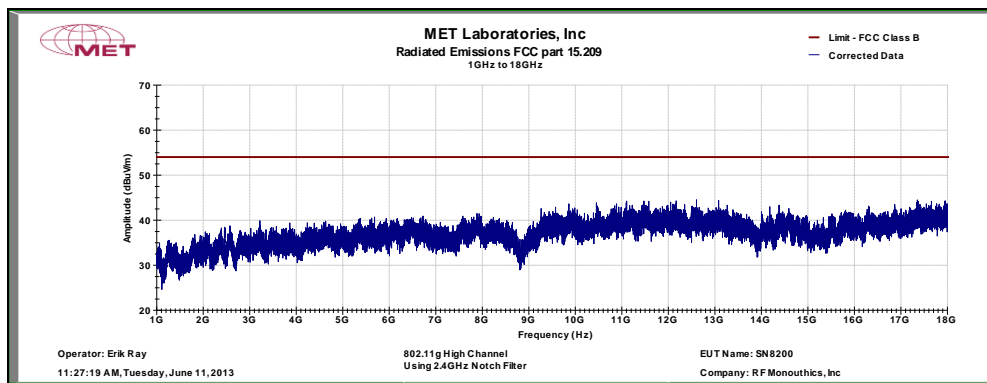

Plot 17. Radiated Spurious Emissions, 802.11g, High Channel, 1 GHz – 18 GHz

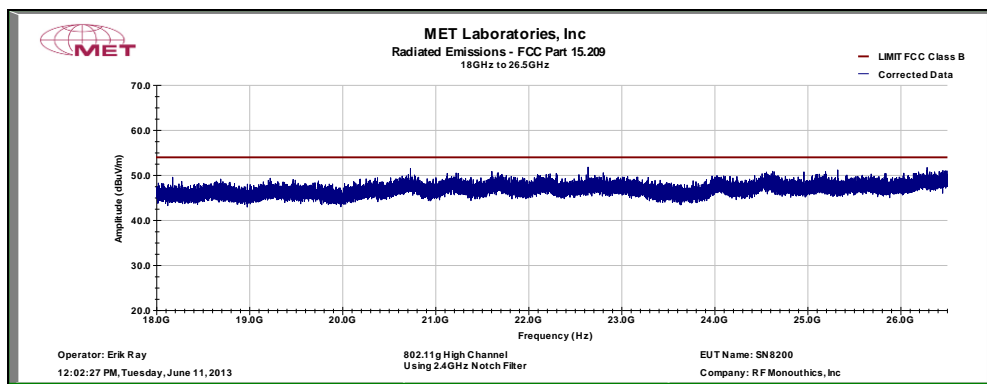

Plot 18. Radiated Spurious Emissions, 802.11g, High Channel, 18 GHz – 26.5 GHz

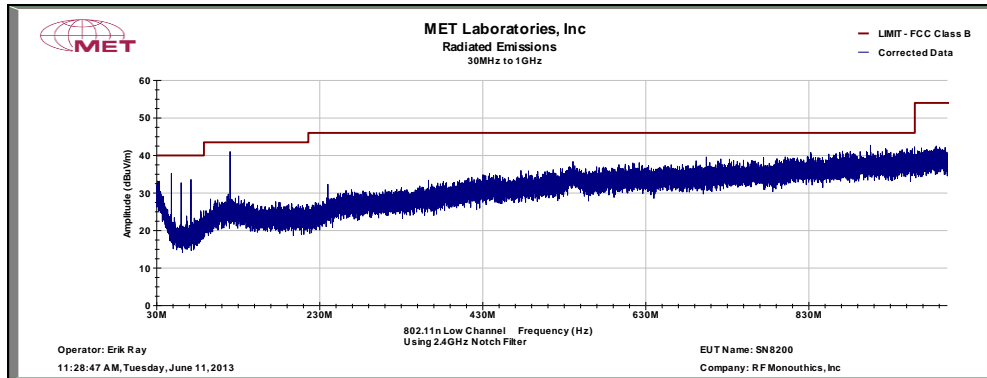

Plot 19. Radiated Spurious Emissions, 802.11n, Low Channel, 30 MHz – 1 GHz

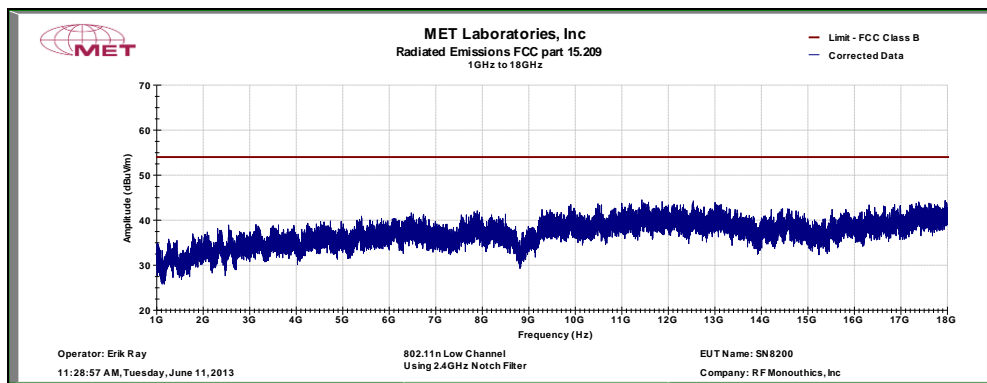

Plot 20. Radiated Spurious Emissions, 802.11n, Low Channel, 1 GHz – 18 GHz

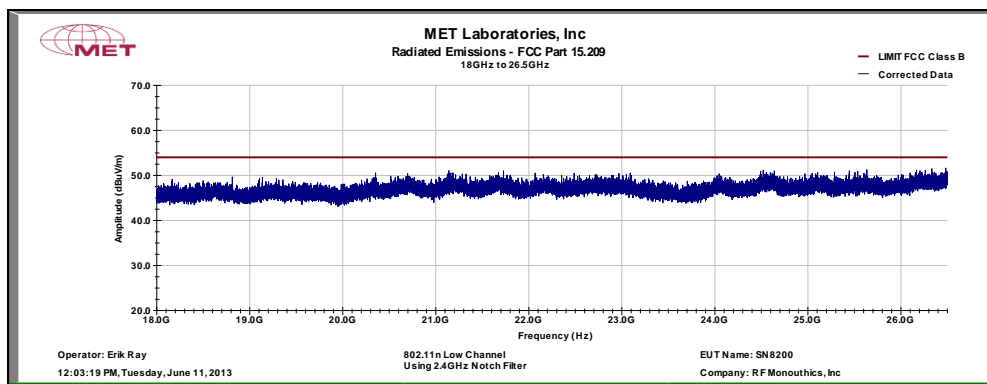

Plot 21. Radiated Spurious Emissions, 802.11n, Low Channel, 18 GHz – 26.5 GHz

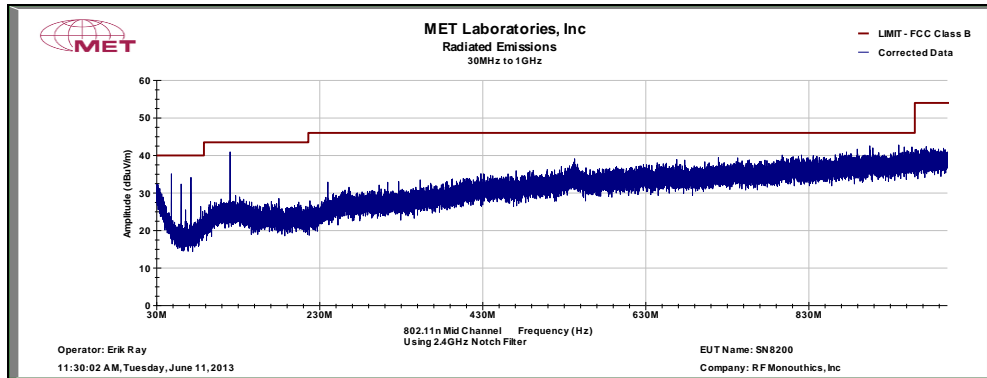

Plot 22. Radiated Spurious Emissions, 802.11n, Mid Channel, 30 MHz – 1 GHz

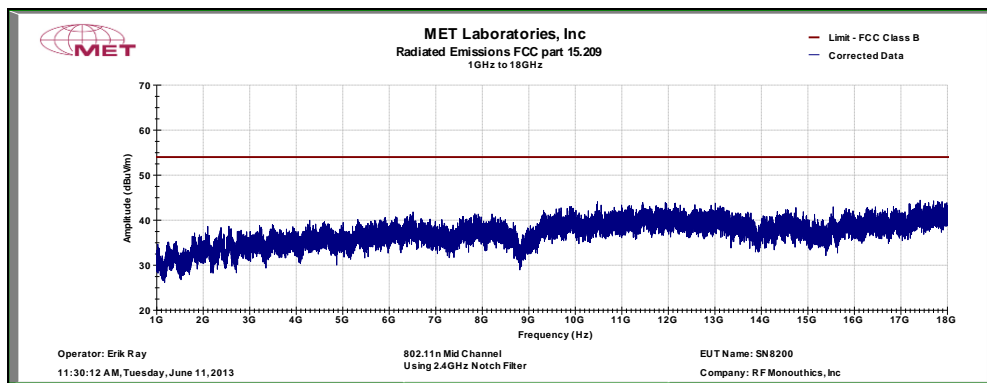

Plot 23. Radiated Spurious Emissions, 802.11n, Mid Channel, 1 GHz – 18 GHz

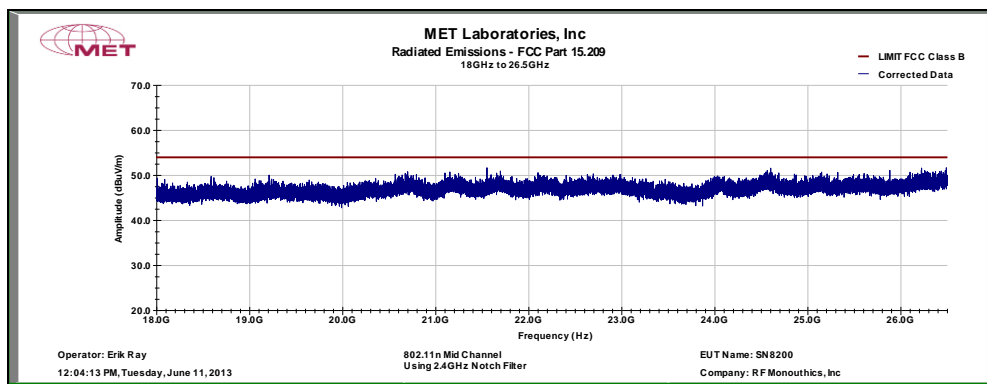

Plot 24. Radiated Spurious Emissions, 802.11n, Mid Channel, 18 GHz – 26.5 GHz

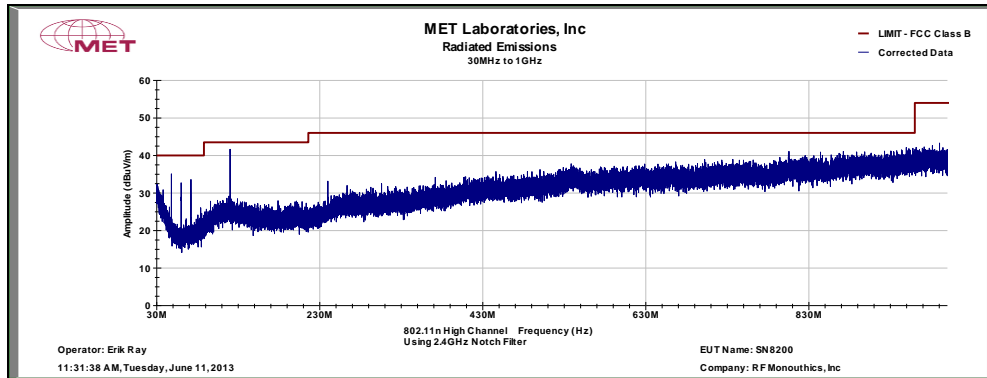

Plot 25. Radiated Spurious Emissions, 802.11n, High Channel, 30 MHz – 1 GHz

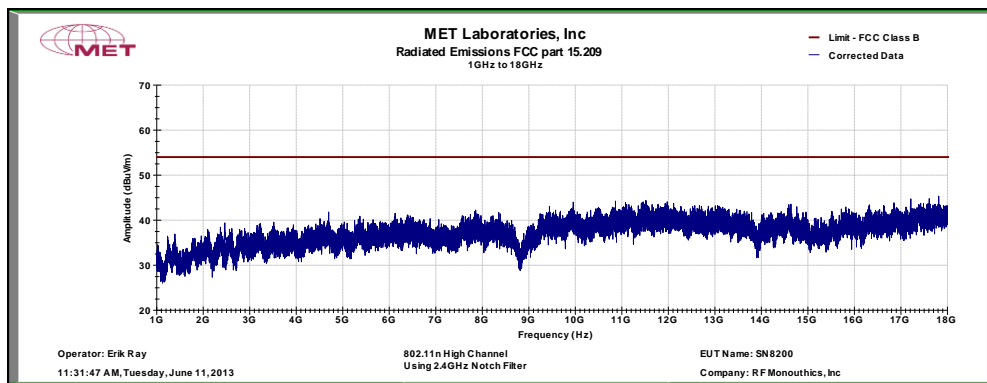

Plot 26. Radiated Spurious Emissions, 802.11n, High Channel, 1 GHz – 18 GHz

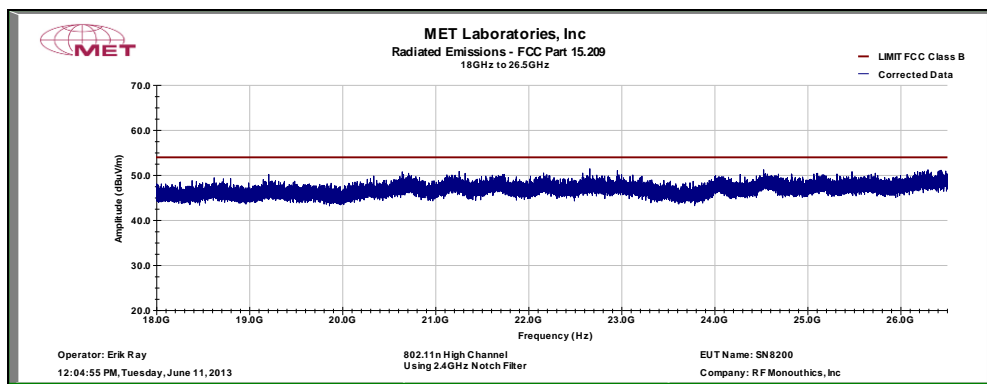

Plot 27. Radiated Spurious Emissions, 802.11n, High Channel, 18 GHz – 26.5 GHz

Radiated Band Edge Measurements

Test Procedures: The transmitter was turned. Measurements were performed of the low and high Channels. The EUT was rotated orthogonally through all three axes. Plots shown are corrected for both antenna correction factor and distance.

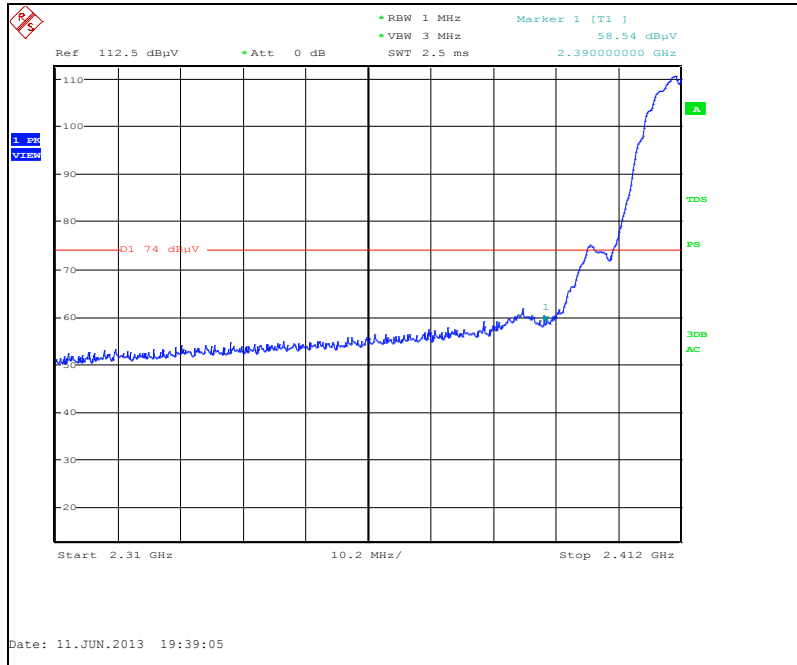

Plot 28. Radiated Restricted Band, 802.11b, Low Channel, Peak

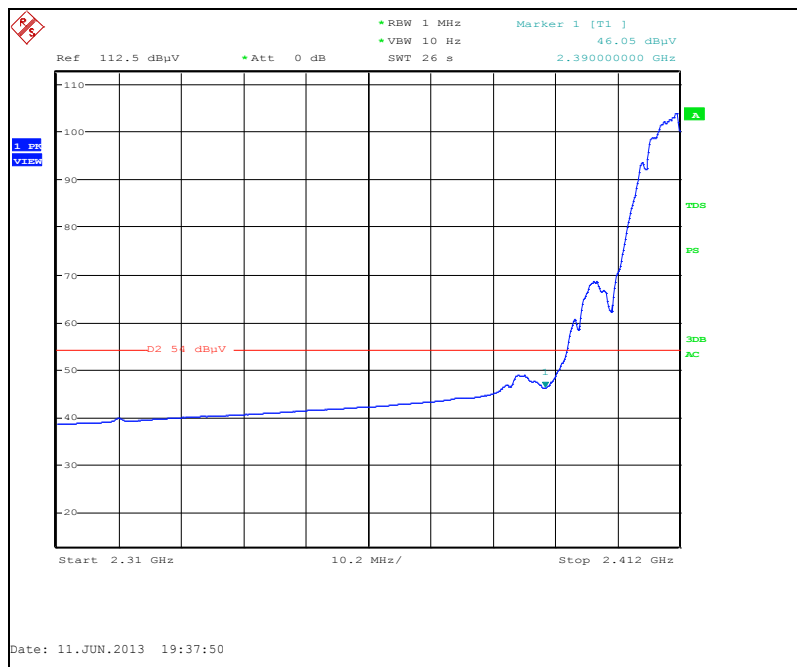

Plot 29. Radiated Restricted Band, 802.11b, Low Channel, Average

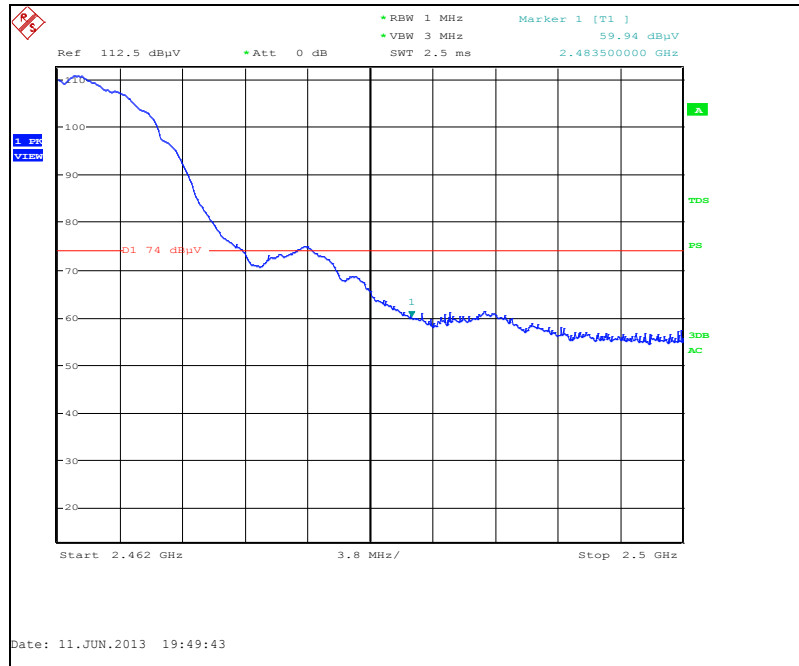

Plot 30. Radiated Restricted Band, 802.11b, High Channel, Peak



Plot 31. Radiated Restricted Band, 802.11b, High Channel, Average

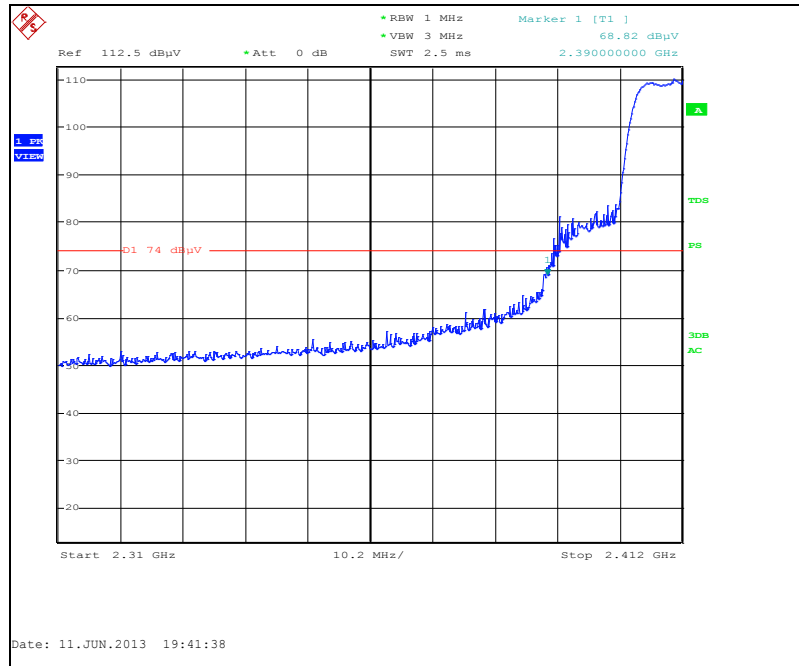

Plot 32. Radiated Restricted Band, 802.11g, Low Channel, Peak

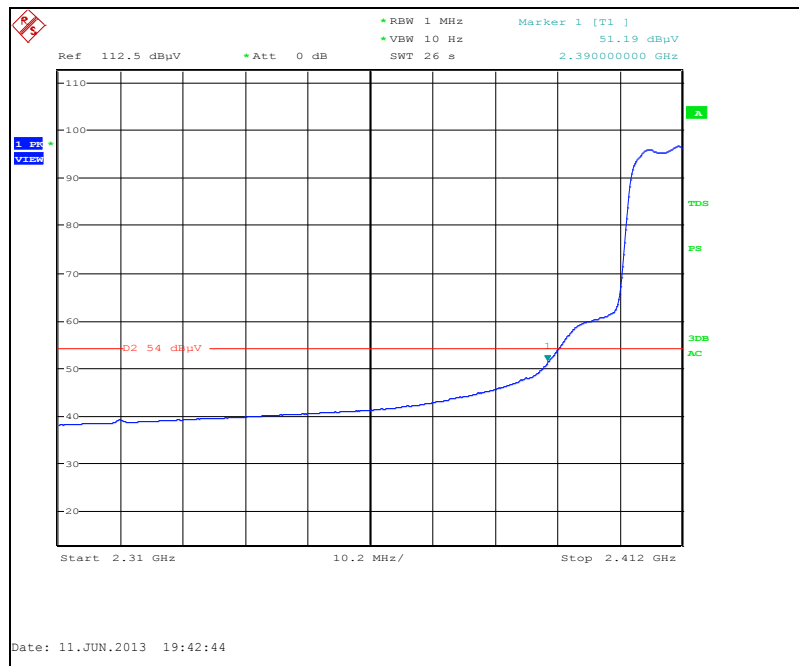

Plot 33. Radiated Restricted Band, 802.11g, Low Channel, Average

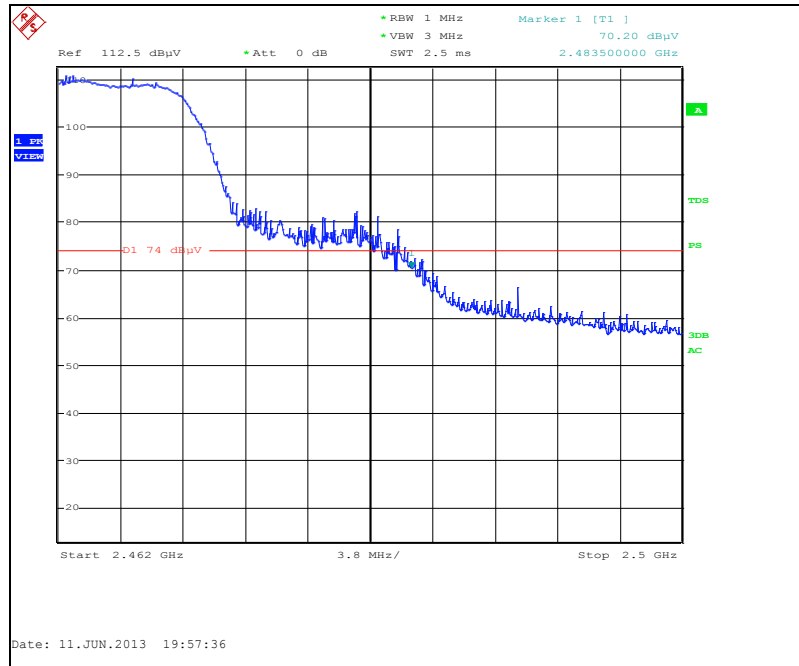

Plot 34. Radiated Restricted Band, 802.11g, High Channel, Peak



Plot 35. Radiated Restricted Band, 802.11g, High Channel, Average

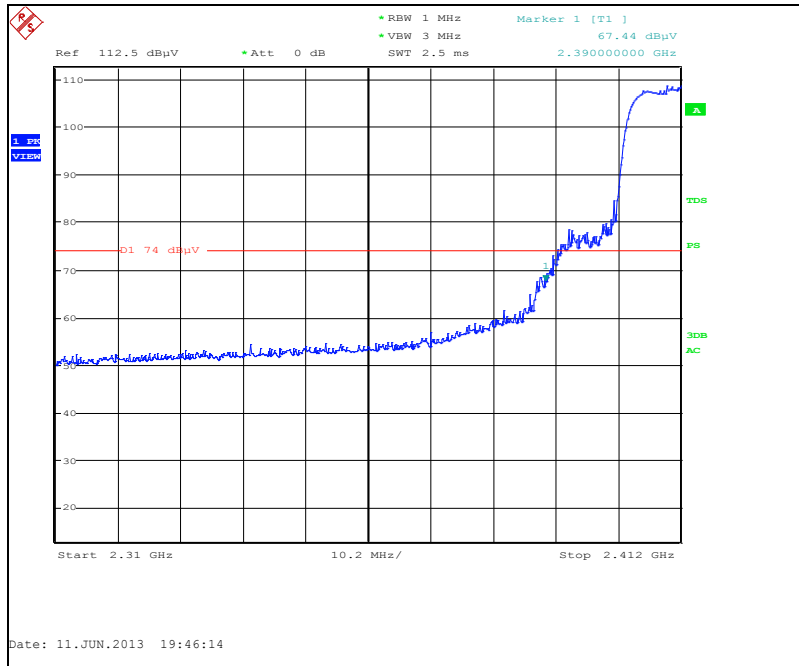

Plot 36. Radiated Restricted Band, 802.11n, Low Channel, Peak

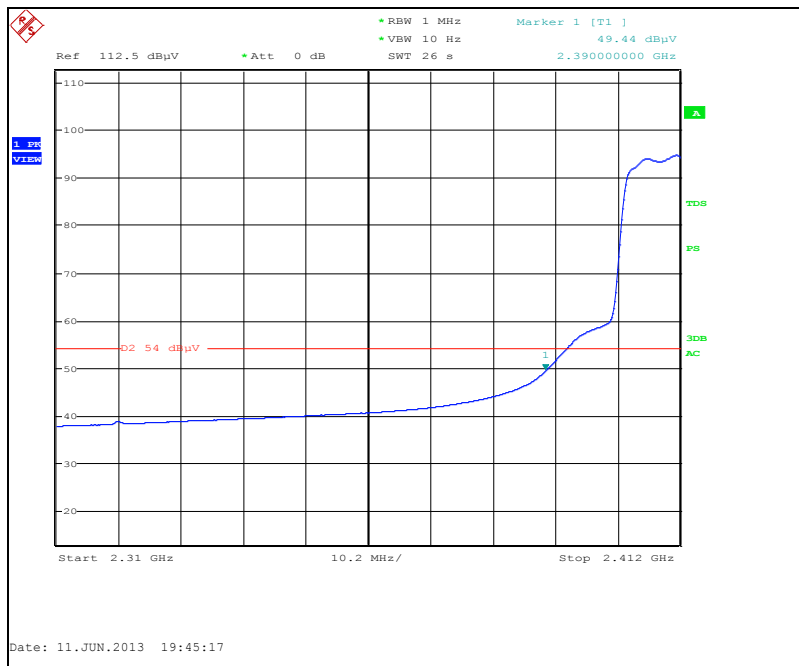

Plot 37. Radiated Restricted Band, 802.11n, Low Channel, Average

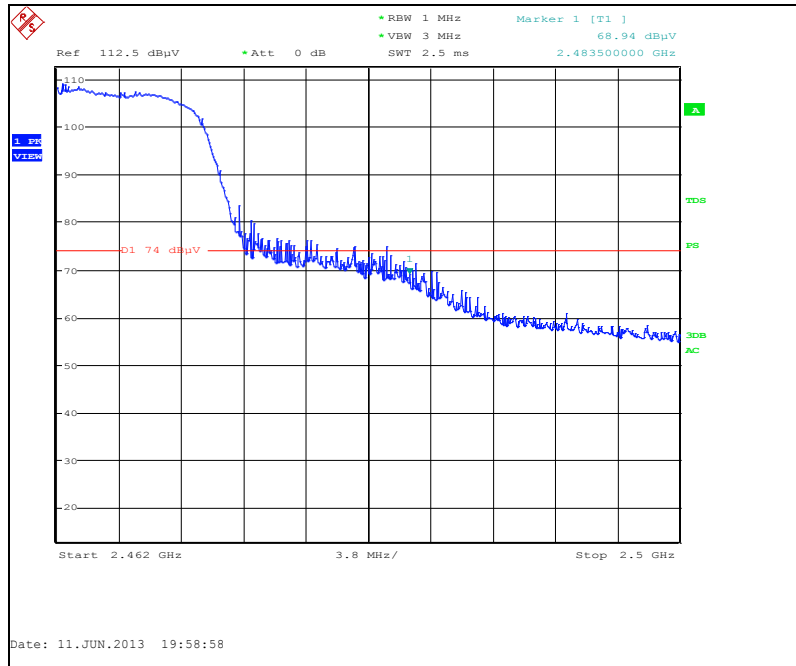

Plot 38. Radiated Restricted Band, 802.11n, High Channel, Peak



Plot 39. Radiated Restricted Band, 802.11n, High Channel, Average

Radiated Spurious Emissions Test Setup



Photograph 2. Radiated Spurious Emissions, Test Setup, 30 MHz – 1 GHz

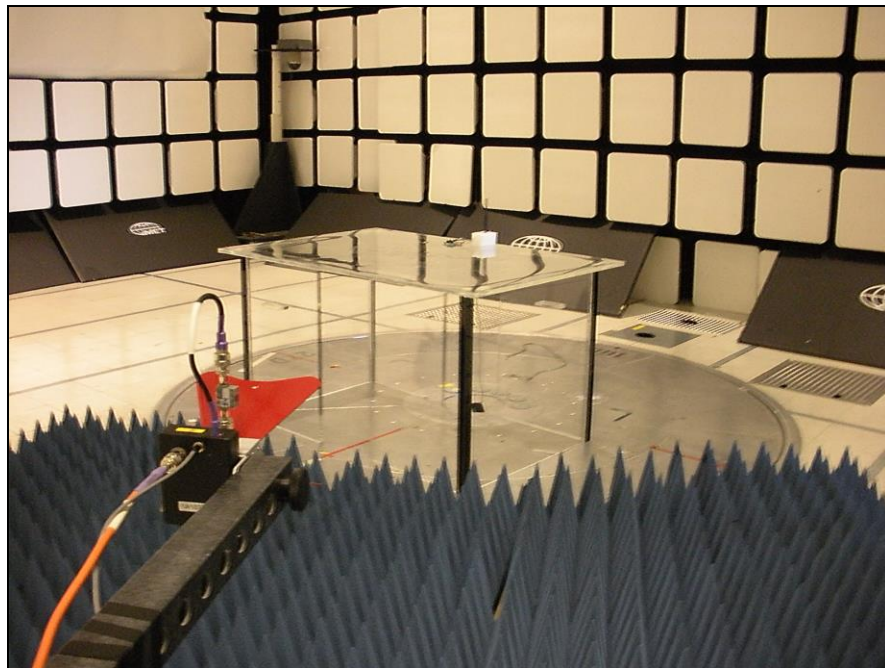

Photograph 3. Radiated Spurious Emissions, Test Setup, 1 GHz – 18 GHz

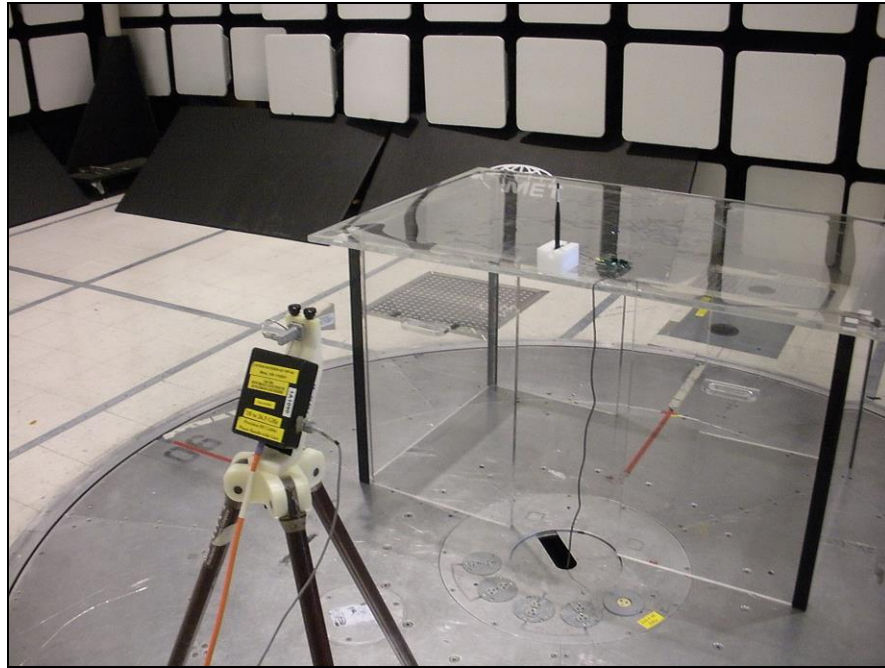

Photograph 4. Radiated Spurious Emissions, Test Setup, 18 GHz – 26.5 GHz

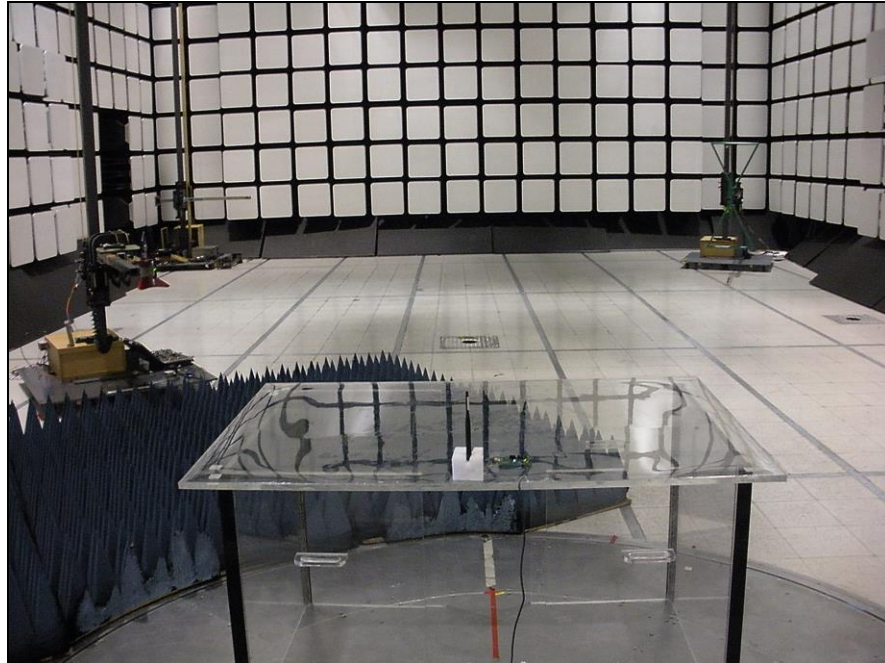

Photograph 5. Radiated Spurious Emissions, Test Setup, Rear

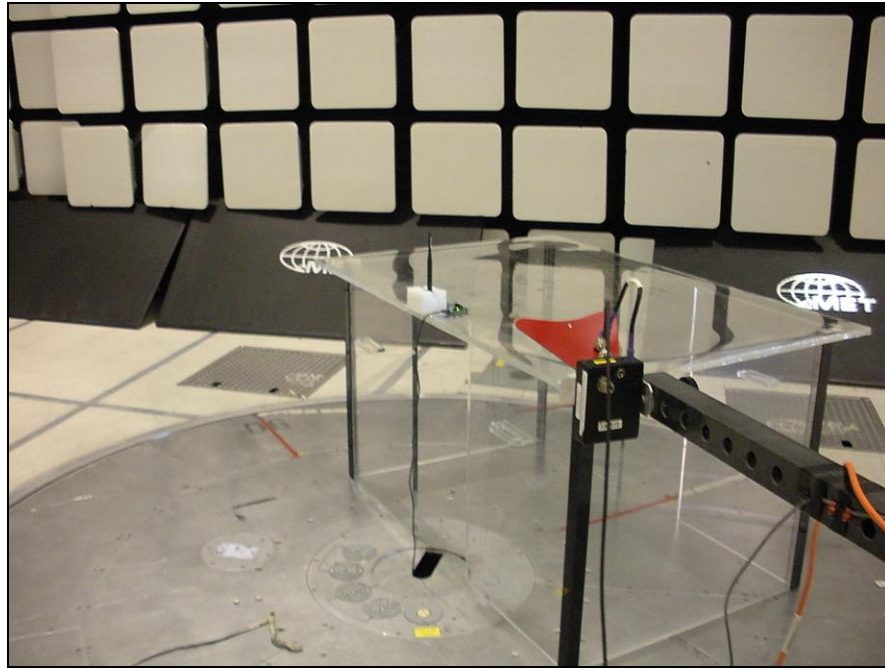

Photograph 6. Radiated Restricted Band, Test Setup

Electromagnetic Compatibility Criteria for Intentional Radiators

§ 15.247(i) Maximum Permissible Exposure

RF Exposure Requirements: §1.1307(b)(1) and §1.1307(b)(2): Systems operating under the provisions of this section shall be operated in a manner that ensures that the public is not exposed to radio frequency energy levels in excess of the Commission's guidelines.

RF Radiation Exposure Limit: §1.1310: As specified in this section, the Maximum Permissible Exposure (MPE) Limit shall be used to evaluate the environmental impact of human exposure to radiofrequency (RF) radiation as specified in Sec. 1.1307(b), except in the case of portable devices which shall be evaluated according to the provisions of Sec. 2.1093 of this chapter.

Test Results: The EUT was compliant with the requirements of this section.

Antenna gain = 5 dBi = 3.16
Power = 173 mW (from original filing)

2.4 GHz Band

$$S = PG/4\pi R^2$$

$$S = \frac{(173\text{mW})(3.16)}{4\pi(20)^2}$$

$$S = 0.109 \text{ mW/cm}^2$$

Test Engineer(s): Erik Ray

IV. Test Equipment

Test Equipment

Calibrated test equipment utilized during testing was maintained in a current state of calibration per the requirements of ISO/IEC 17025:2005.

Test Name: Radiated Emissions				Test Date(s): 6-11-13 to 6-12-13	
MET Asset #	Nomenclature	Manufacturer	Model	Last Cal Date	Cal Due Date
1A1083	EMI TEST RECEIVER	ROHDE & SCHWARZ	ESU40	5-31-13	5-31-14
1A1088	PRE-AMP	RHODE & SCHWARZ	TS-PR1	SEE NOTE	
1A1141	SPECTRUM ANALYZER	HEWLETT PACKARD	E4407B	5-3-13	5-3-14
1A1113	PRE-AMP	MINI-CIRCUIT	ZVA-183+	SEE NOTE	
1A1072	PRE-AMP	MITEQ	AFS5-01001800-25-8P-6-PS	SEE NOTE	
1A1047	HORN ANTENNA	ETS	3117	4-3-12	10-3-13
1A1026	18-26.5GHZ ANTENNA	ETS	011777-002	5-9-12	11-9-13
1A1050	BI-CONILOG ANTENNA (30MHZ TO 1GHZ)	SCHAFFNER	CBL6112D	6-4-12	12-4-13
1A1106	10M CHAMBER	ETS	SEMI-ANECHOIC	9-12-12	3-12-14

Table 10. Test Equipment List

Note: Functionally tested equipment is verified using calibrated instrumentation at the time of testing.

V. Certification & User's Manual Information

Certification & User's Manual Information

A. Certification Information

The following is extracted from Title 47 of the Code of Federal Regulations, Part 2, Subpart I — Marketing of Radio frequency devices:

§ 2.801 Radio-frequency device defined.

As used in this part, a radio-frequency device is any device which in its operation is capable of Emitting radio-frequency energy by radiation, conduction, or other means. Radio- frequency devices include, but are not limited to:

- (a) The various types of radio communication transmitting devices described throughout this chapter.
- (b) *The incidental, unintentional and intentional radiators defined in Part 15 of this chapter.*
- (c) The industrial, scientific, and medical equipment described in Part 18 of this chapter.
- (d) Any part or component thereof which in use emits radio-frequency energy by radiation, conduction, or other means.

§ 2.803 Marketing of radio frequency devices prior to equipment authorization.

- (a) Except as provided elsewhere in this chapter, no person shall sell or lease, or offer for sale or lease (including advertising for sale or lease), or import, ship or distribute for the purpose of selling or leasing or offering for sale or lease, any radio frequency device unless:
 - (1) In the case of a device subject to certification, such device has been authorized by the Commission in accordance with the rules in this chapter and is properly identified and labeled as required by §2.925 and other relevant sections in this chapter; or
 - (2) In the case of a device that is not required to have a grant of equipment authorization issued by the Commission, but which must comply with the specified technical standards prior to use, such device also complies with all applicable administrative (including verification of the equipment or authorization under a Declaration of Conformity, where required), technical, labeling and identification requirements specified in this chapter.
- (d) Notwithstanding the provisions of paragraph (a) of this section, the offer for sale solely to business, commercial, industrial, scientific or medical users (but not an offer for sale to other parties or to end users located in a residential environment) of a radio frequency device that is in the conceptual, developmental, design or pre-production stage is permitted prior to equipment authorization or, for devices not subject to the equipment authorization requirements, prior to a determination of compliance with the applicable technical requirements *provided* that the prospective buyer is advised in writing at the time of the offer for sale that the equipment is subject to the FCC rules and that the equipment will comply with the appropriate rules before delivery to the buyer or to centers of distribution.

- (e)(1) Notwithstanding the provisions of paragraph (a) of this section, prior to equipment authorization or determination of compliance with the applicable technical requirements any radio frequency device may be operated, but not marketed, for the following purposes and under the following conditions:
- (i) *Compliance testing*;
 - (ii) Demonstrations at a trade show provided the notice contained in paragraph (c) of this section is displayed in a conspicuous location on, or immediately adjacent to, the device;
 - (iii) Demonstrations at an exhibition conducted at a business, commercial, industrial, scientific or medical location, but excluding locations in a residential environment, provided the notice contained in paragraphs (c) or (d) of this section, as appropriate, is displayed in a conspicuous location on, or immediately adjacent to, the device;
 - (iv) Evaluation of product performance and determination of customer acceptability, provided such operation takes place at the manufacturer's facilities during developmental, design or pre-production states; or
 - (v) Evaluation of product performance and determination of customer acceptability where customer acceptability of a radio frequency device cannot be determined at the manufacturer's facilities because of size or unique capability of the device, provided the device is operated at a business, commercial, industrial, scientific or medical user's site, but not at a residential site, during the development, design or pre-production stages.
- (e)(2) For the purpose of paragraphs (e)(1)(iv) and (e)(1)(v) of this section, the term *manufacturer's facilities* includes the facilities of the party responsible for compliance with the regulations and the manufacturer's premises, as well as the facilities of other entities working under the authorization of the responsible party in connection with the development and manufacture, but not the marketing, of the equipment.
- (f) For radio frequency devices subject to verification and sold solely to business, commercial, industrial, scientific and medical users (excluding products sold to other parties or for operation in a residential environment), parties responsible for verification of the devices shall have the option of ensuring compliance with the applicable technical specifications of this chapter at each end user's location after installation, provided that the purchase or lease agreement includes a proviso that such a determination of compliance be made and is the responsibility of the party responsible for verification of the equipment.

Certification & User's Manual Information

The following is extracted from Title 47 of the Code of Federal Regulations, Part 2, Subpart J — Equipment Authorization Procedures:

§ 2.901 Basis and Purpose

- (a) In order to carry out its responsibilities under the Communications Act and the various treaties and international regulations, and in order to promote efficient use of the radio spectrum, the Commission has developed technical standards for radio frequency equipment and parts or components thereof. The technical standards applicable to individual types of equipment are found in that part of the rules governing the service wherein the equipment is to be operated.¹ *In addition to the technical standards provided, the rules governing the service may require that such equipment be verified by the manufacturer or importer, be authorized under a Declaration of Conformity, or receive an equipment authorization from the Commission by one of the following procedures: certification or registration.*
- (b) The following sections describe the verification procedure, the procedure for a Declaration of Conformity, and the procedures to be followed in obtaining certification from the Commission and the conditions attendant to such a grant.

§ 2.907 Certification.

- (a) Certification is an equipment authorization issued by the Commission, based on representation and test data submitted by the applicant.
- (b) Certification attaches to all units subsequently marketed by the grantee which are identical (see Section 2.908) to the sample tested except for permissive changes or other variations authorized by the Commission pursuant to Section 2.1043.

¹ In this case, the equipment is subject to the rules of Part 15. More specifically, the equipment falls under Subpart B (of Part 15), which deals with unintentional radiators.

Certification & User's Manual Information

§ 2.948 Description of measurement facilities.

- (a) Each party making measurements of equipment that is subject to an equipment authorization under Part 15 or Part 18 of this chapter, regardless of whether the measurements are filed with the Commission or kept on file by the party responsible for compliance of equipment marketed within the U.S. or its possessions, shall compile a description of the measurement facilities employed.
- (1) If the measured equipment is subject to the verification procedure, the description of the measurement facilities shall be retained by the party responsible for verification of the equipment.
- (i) *If the equipment is verified through measurements performed by an independent laboratory, it is acceptable for the party responsible for verification of the equipment to rely upon the description of the measurement facilities retained by or placed on file with the Commission by that laboratory. In this situation, the party responsible for the verification of the equipment is not required to retain a duplicate copy of the description of the measurement facilities.*
- (ii) If the equipment is verified based on measurements performed at the installation site of the equipment, no specific site calibration data is required. It is acceptable to retain the description of the measurement facilities at the site at which the measurements were performed.
- (2) If the equipment is to be authorized by the Commission under the certification procedure, the description of the measurement facilities shall be filed with the Commission's Laboratory in Columbia, Maryland. The data describing the measurement facilities need only be filed once but must be updated as changes are made to the measurement facilities or as otherwise described in this section. At least every three years, the organization responsible for filing the data with the Commission shall certify that the data on file is current.

Certification & User's Manual Information

1. Label and User's Manual Information

The following is extracted from Title 47 of the Code of Federal Regulations, Part 15, Subpart A — General:

§ 15.19 Labeling requirements.

(a) *In addition to the requirements in Part 2 of this chapter, a device subject to certification or verification shall be labeled as follows:*

- (1) Receivers associated with the operation of a licensed radio service, e.g., FM broadcast under Part 73 of this chapter, land mobile operation under Part 90, etc., shall bear the following statement in a conspicuous location on the device:

This device complies with Part 15 of the FCC Rules. Operation is subject to the condition that this device does not cause harmful interference.

- (2) A stand-alone cable input selector switch, shall bear the following statement in a conspicuous location on the device:

This device is verified to comply with Part 15 of the FCC Rules for use with cable television service.

- (3) All other devices shall bear the following statement in a conspicuous location on the device:

This device complies with Part 15 of the FCC Rules. Operation is subject to the following two conditions: (1) This device may not cause harmful interference, and (2) this device must accept any interference received, including interference that may cause undesired operation.

- (4) Where a device is constructed in two or more sections connected by wires and marketed together, the statement specified under paragraph (a) of this section is required to be affixed only to the main control unit.

- (5) When the device is so small or for such use that it is not practicable to place the statement specified under paragraph (a) of this section on it, the information required by this paragraph shall be placed in a prominent location in the instruction manual or pamphlet supplied to the user or, alternatively, shall be placed on the container in which the device is marketed. However, the FCC identifier or the unique identifier, as appropriate, must be displayed on the device.

§ 15.21 Information to user.

The users manual or instruction manual for an intentional or unintentional radiator shall caution the user that changes or modifications not expressly approved by the party responsible for compliance could void the user's authority to operate the equipment.

Verification & User's Manual Information

The following is extracted from Title 47 of the Code of Federal Regulations, Part 15, Subpart B — Unintentional Radiators:

§ 15.105 Information to the user.

- (a) For a Class A digital device or peripheral, the instructions furnished the user shall include the following or similar statement, placed in a prominent location in the text of the manual:

Note: This equipment has been tested and found to comply with the limits for a Class A digital device, pursuant to Part 15 of the FCC Rules. These limits are designed to provide reasonable protection against harmful interference when the equipment is operated in a commercial environment. This equipment generates, uses, and can radiate radio frequency energy and, if not installed and used in accordance with the instruction manual, may cause harmful interference to radio communications. Operation of this equipment in a residential area is likely to cause harmful interference in which case the user will be required to correct the interference at own expense.

- (b) For a Class B digital device or peripheral, the instructions furnished the user shall include the following or similar statement, placed in a prominent location in the text of the manual:

Note: This equipment has been tested and found to comply with the limits for a Class B digital device, pursuant to Part 15 of the FCC Rules. These limits are designed to provide reasonable protection against harmful interference when the equipment is operated in a residential environment. This equipment generates, uses, and can radiate radio frequency energy and, if not installed and used in accordance with the instruction manual, may cause harmful interference to radio communications. However, there is no guarantee that interference will not occur in a particular installation. If this equipment does cause harmful interference to radio or television reception, which can be determined by turning the equipment off and on, the user is encouraged to try to correct the interference by one or more of the following measures:

- Reorient or relocate the receiving antenna.
- Increase the separation between the equipment and receiver.
- Connect the equipment into an outlet on a circuit different from that to which the receiver is connected.
- Consult the dealer or an experienced radio/TV technician for help.

ICES-003 Procedural & Labeling Requirements

From the Industry Canada Electromagnetic Compatibility Advisory Bulletin entitled, "Implementation and Interpretation of the Interference-Causing Equipment Standard for Digital Apparatus, ICES-003" (EMCAB-3, Issue 2, July 1995):

"At present, CISPR 22: 2002 and ICES technical requirements are essentially equivalent. Therefore, if you have CISPR 22: 2002 approval by meeting CISPR Publication 22, the only additional requirements are: to attach a note to the report of the test results for compliance, indicating that these results are deemed satisfactory evidence of compliance with ICES-003 of the Canadian Interference-Causing Equipment Regulations; to maintain these records on file for the requisite five year period; and to provide the device with a notice of compliance in accordance with ICES-003."

Procedural Requirements:

According to Industry Canada's Interference Causing Equipment Standard for Digital Apparatus ICES-003 Issue 4, February 2004:

- Section 6.1: A record of the measurements and results, showing the date that the measurements were completed, shall be retained by the manufacturer or importer for a period of at least five years from the date shown in the record and made available for examination on the request of the Minister.
- Section 6.2: A written notice indicating compliance must accompany each unit of digital apparatus to the end user. The notice shall be in the form of a label that is affixed to the apparatus. Where because of insufficient space or other constraints it is not feasible to affix a label to the apparatus, the notice may be in the form of a statement in the user's manual.

Labeling Requirements:

The suggested text for the notice, in English and in French, is provided below, from the Annex of ICES-003:

This Class [²] digital apparatus complies with Canadian ICES-003.

Cet appareil numérique de la classe [¹] est conforme à la norme NMB-003 du Canada.

² Insert either A or B but not both as appropriate for the equipment requirements.

End of Report