

SmartValve with Integrated Bypass 10-3600i

Internal Photos

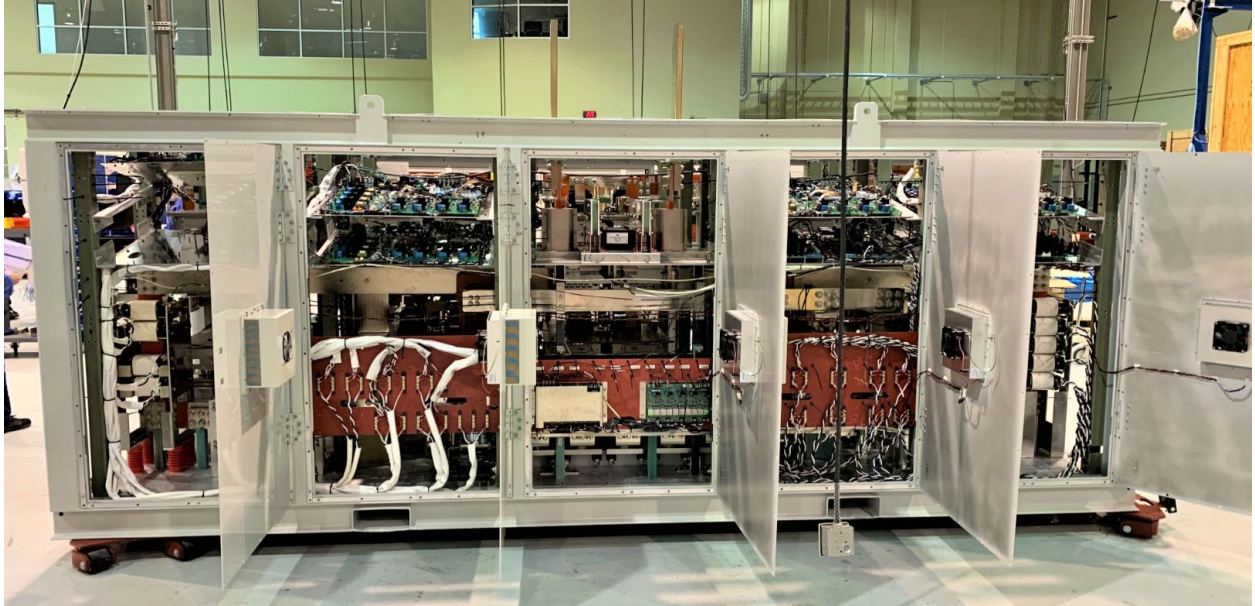

Enclosure Cooler side View



End Panel side view



LCS side internal view

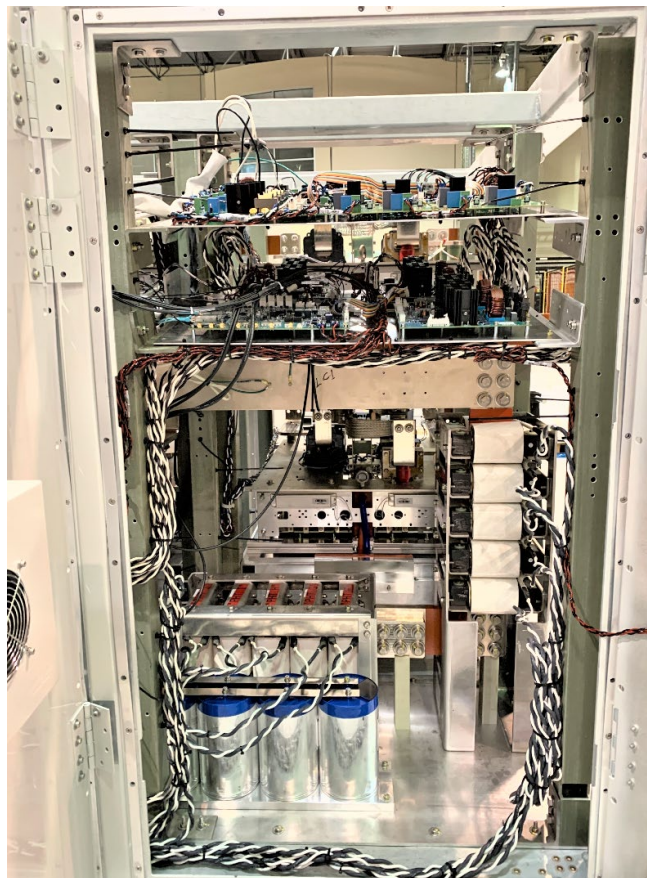

2 MVar. Module

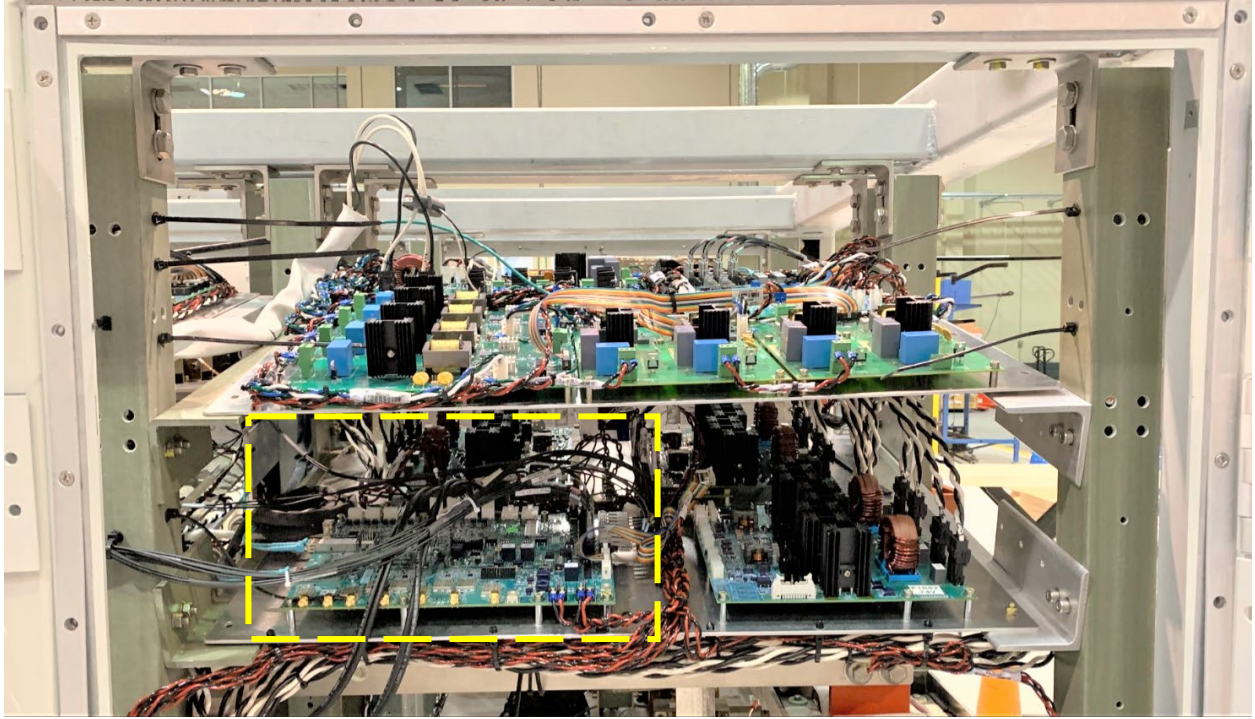

RF and control PCBA P110860 iDCE Board view 1

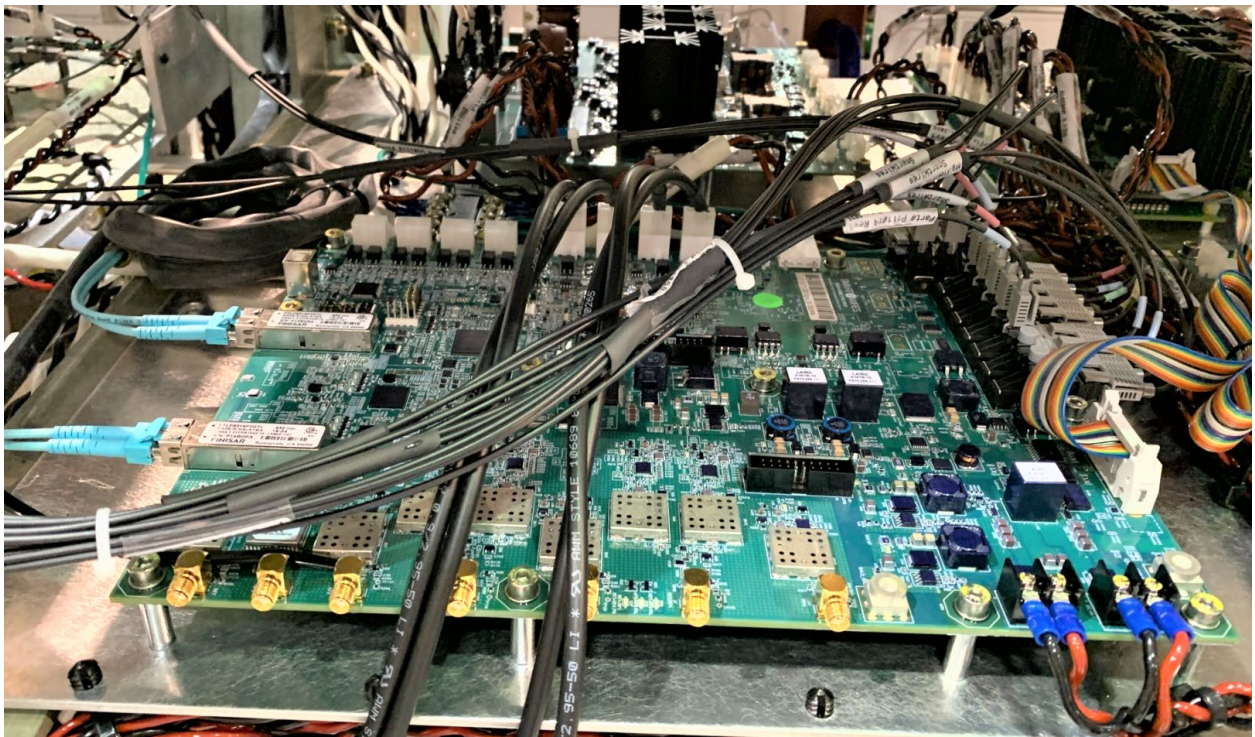

RF and control PCBA P110860 iDCE Board view 2

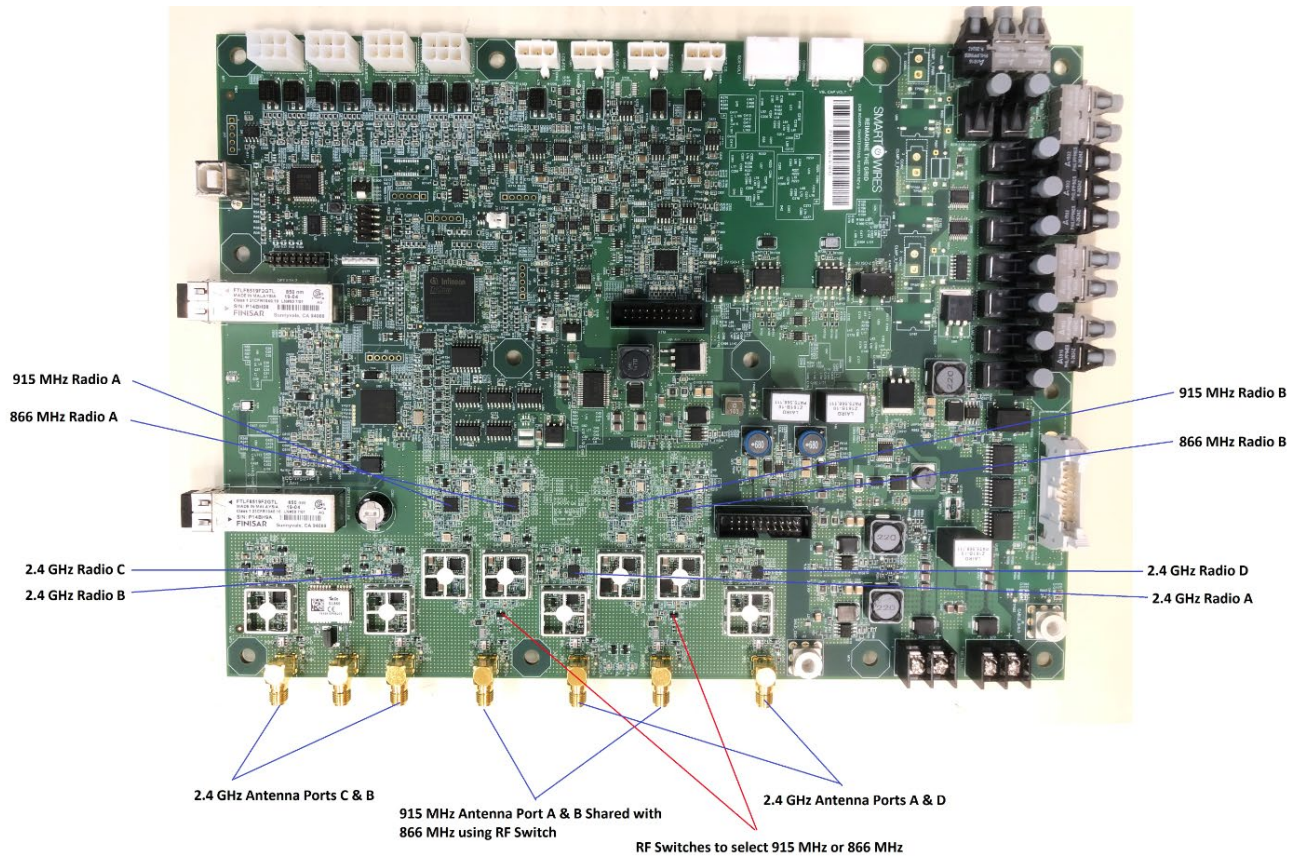

P110860 iDCE PCBA RF Layout (EMC shields removed)

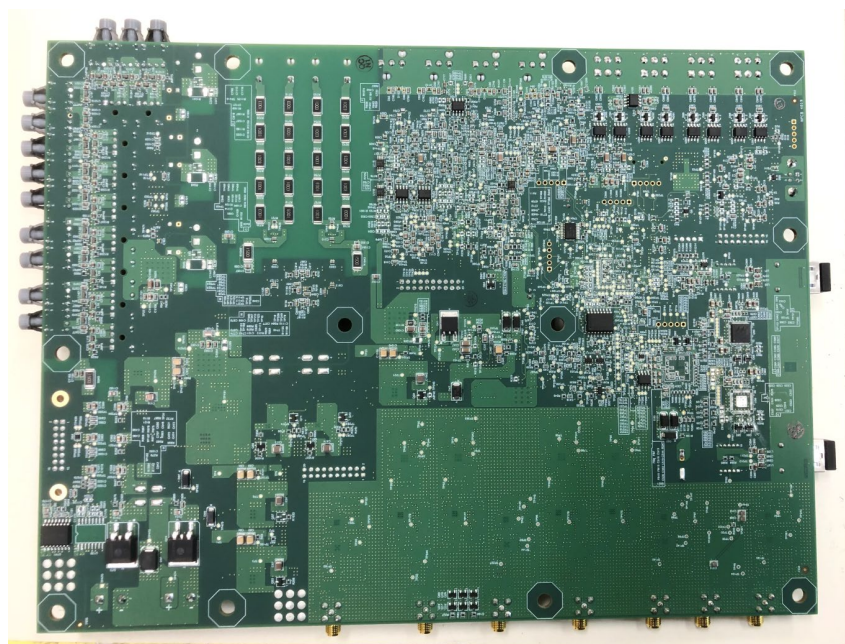

P110860 iDCE RF PCBA (bottom view)

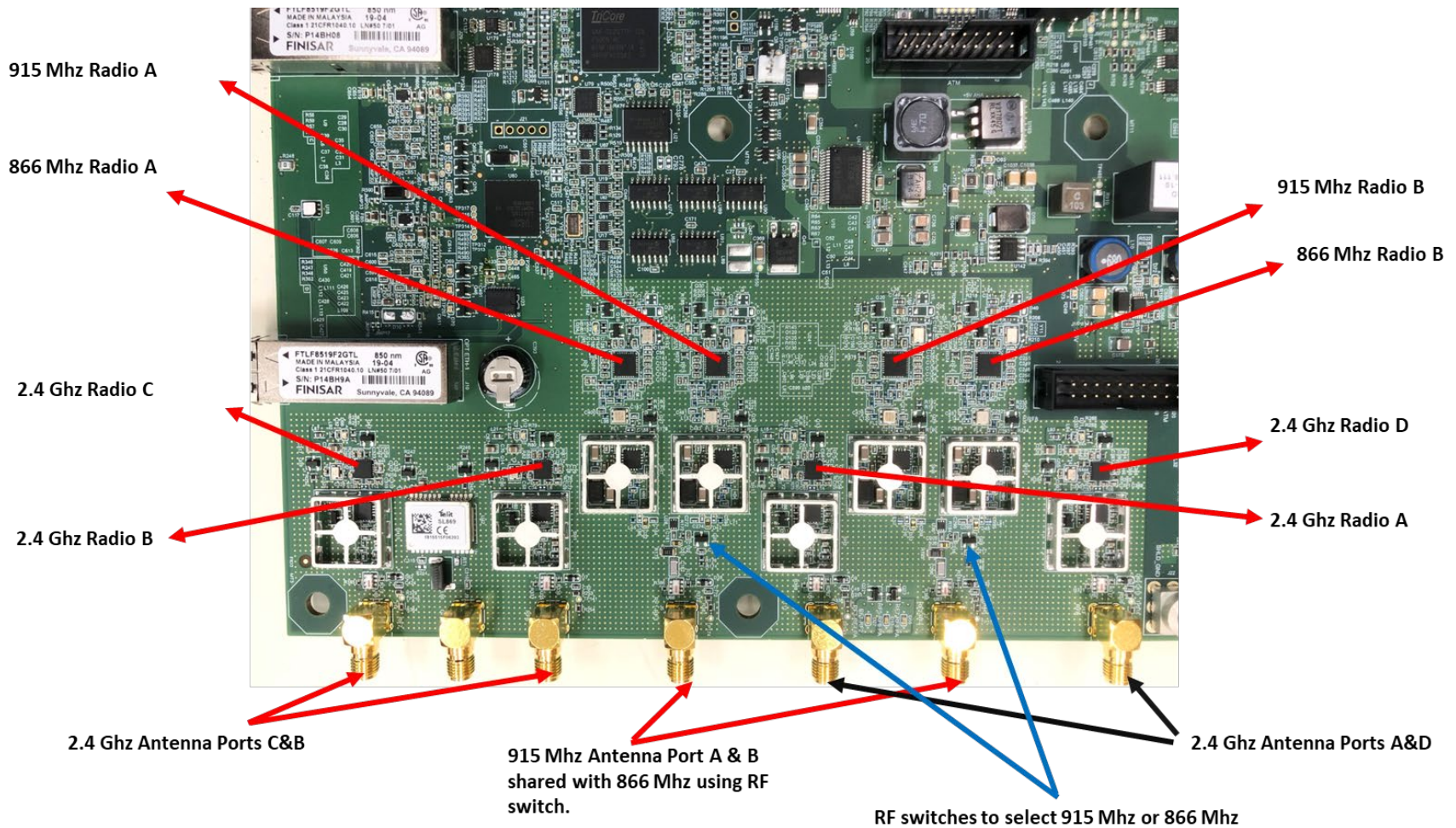

P110860 iDCE RF PCBA Radios (close up) EMC shields removed.

*. Note: 866 MHz radios are not supported in this version.



LCS side with panels removed



SV 10-3600i Main Internal Electromechanical systems

SmartValve 10-3600i Antennas

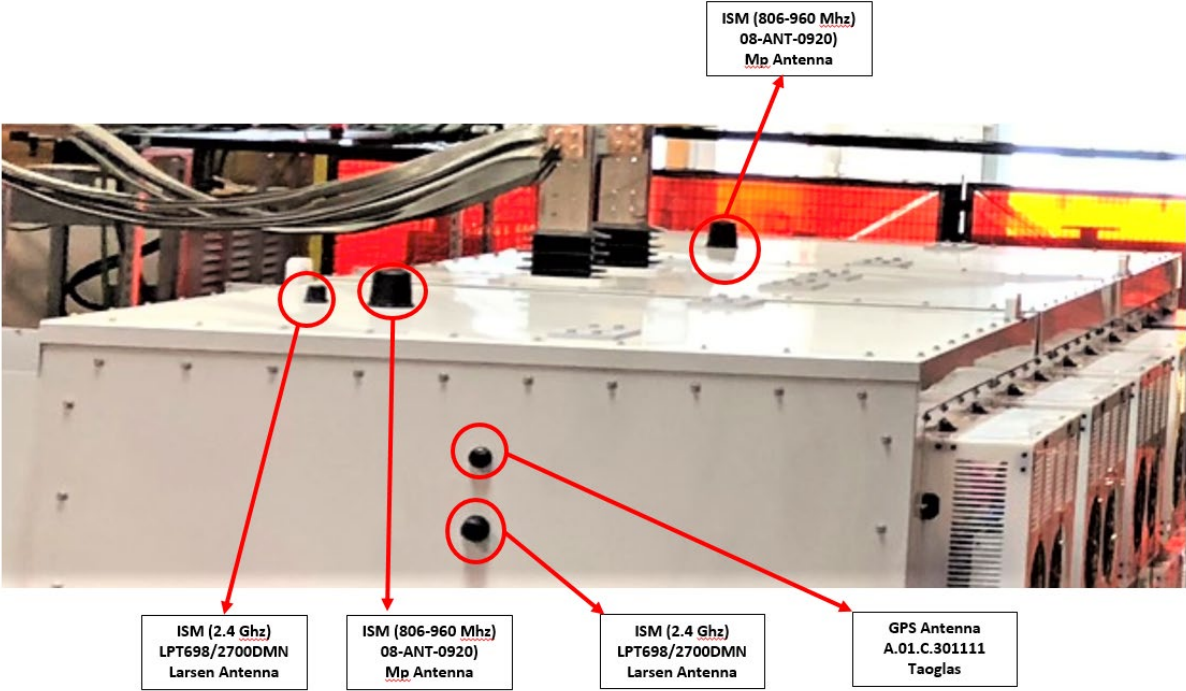
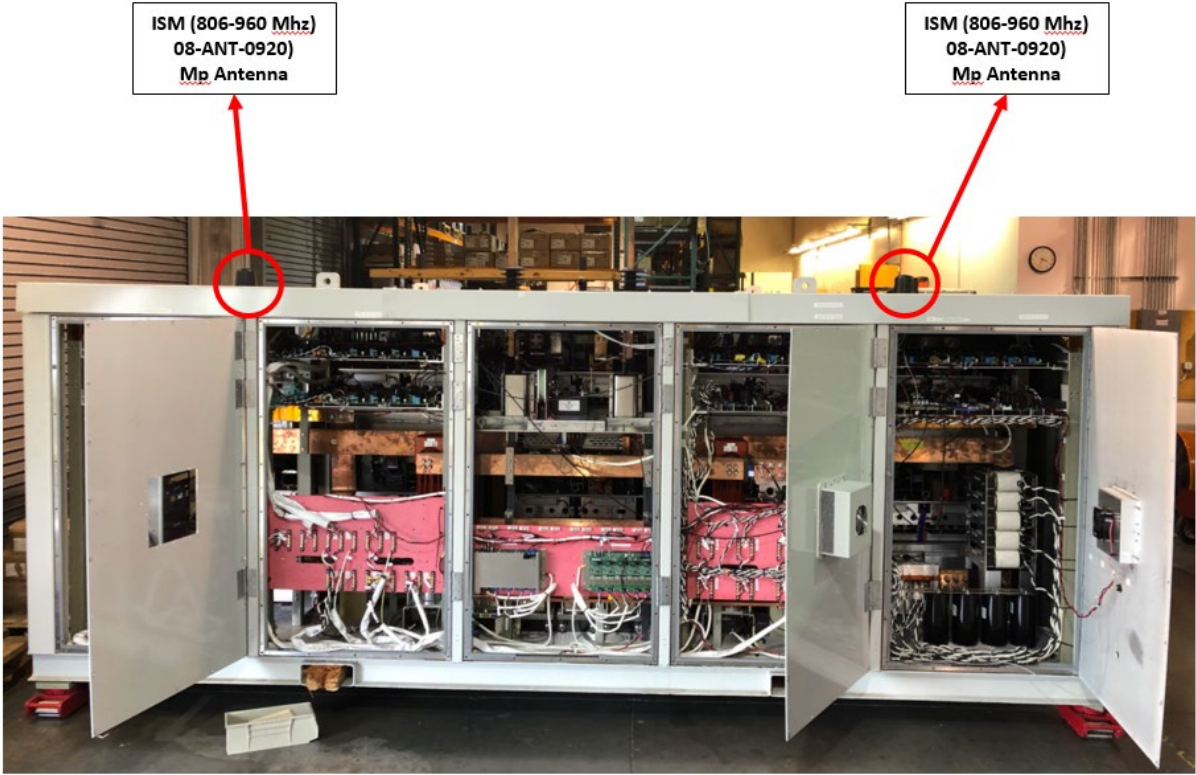

*. Note: 866 MHz radios are not supported in this version.