

(REVISED VERSION)

TEST REPORT FOR CERTIFICATION

On Behalf of

Jow Tong Technology Co., Ltd.

Digital FM Transmitter

Model No. : ST-26

FCC ID : QPRST26

Prepared for : Jow Tong Technology Co., Ltd.
46, Lane 337, Chung Cheng Rd., Yung Kang,
Tainan Hsien 710, Taiwan, R.O.C.

Prepared by : Audix Corporation
Technical Division EMC Department
No. 53-11, Tin-Fu Tsun, Lin-Kou,
Taipei Hsien, Taiwan, R.O.C.

Tel : (02) 2609-9301, 2609-2133

Fax: (02) 2609-9303

File Number : EM930105
Report Number : EM-F930021
Date of Test : Feb. 09 ~ Mar. 13, 2004 (Rev. 3)
Date of Report : Mar. 15, 2004

TABLE OF CONTENTS

Description	Page
TEST REPORT CERTIFICATION	3
1. GENERAL INFORMATION	4
1.1. Description of Device (EUT).....	4
1.2. Tested Supporting System Details	5
1.3. Description of Test Facility	5
1.4. Measurement Uncertainty.....	6
2. POWERLINE CONDUCTED EMISSION MEASUREMENT	7
3. RADIATED EMISSION MEASUREMENT	8
3.1. Test Equipment.....	8
3.2. Test Setup	8
3.3. Radiation Limit (Comply with §15.239 & §15.209)	9
3.4. EUT's Configuration during Compliance Measurement	10
3.5. Operating Condition of EUT	10
3.6. Test Procedure	10
3.7. Radiated Emission Noise Measurement Results.....	12
4. 26dB BANDWIDTH MEASUREMENT	14
4.1. Test Equipment.....	14
4.2. Block Diagram of Test Setup.....	14
4.3. Specification Limits (§15.239).....	14
4.4. EUT's Configuration during Compliance Measurement	14
4.5. 26dB Bandwidth Measurement Results.....	14
5. DEVIATION TO TEST SPECIFICATIONS.....	18
6. PHOTOGRAPHS.....	19
6.1. Photos of Radiated Measurement at Semi-Anechoic Chamber (30-1000MHz).....	19
6.2. Photos of Radiated Measurement at Semi-Anechoic Chamber (1-2GHz)	20
6.3. Photos of Bandwidth Measurement	21
APPENDIX (Radiated Test data At Semi-Anechoic Chamber).....	22

TEST REPORT CERTIFICATION

Applicant : Jow Tong Technology Co., Ltd.
 Manufacturer : Jow Tong Technology Co., Ltd.
 EUT Description : Digital FM Transmitter
 FCC ID : QPRST26
 (A) MODEL NO. : ST-26
 (B) SERIAL NO. : N/A
 (C) POWER SUPPLY : DC +10V~+16V

Measurement Procedure Used:

FCC RULES AND REGULATIONS PART 15 SUBPART C, DEC. 2003
 AND ANSI C63.4-2001
 (FCC CFR 47 Part 15C, §15.203, §15.207, §15.209 and §15.239)

The device described above was tested by AUDIX CORPORATION. to determine the maximum emission levels emanating from the device. The maximum emission levels were compared to the FCC Part 15 subpart C limits both radiated and conducted emissions.

The measurement results are contained in this test report and AUDIX CORPORATION. is assumed full responsibility for the accuracy and completeness of these measurements. Also, this report shows that the EUT to be technically compliant with the FCC official limits.

This report applies to above tested sample only. This report shall not be reproduced in part without written approval of AUDIX CORPORATION.

Date of Test: Feb. 09 ~ Mar. 13, 2004 (Rev. 3)

Prepared by: Cherry Wang Mar. 15, 2004
 (Cherry Wang/Assistant Manager)

Test Engineer: Ben Cheng Mar. 15, 2004
 (Ben Cheng/Assistant Manager)

Approved & Authorized Signer: Leon Liu Mar. 15 2004
 (Leon Liu/Assistant General Manager)

1. GENERAL INFORMATION

1.1. Description of Device (EUT)

Description	:	Digital FM Transmitter (It's a transmitting device to hold a MP3/iPod or CD player to transmit music signal that can accept by Car radio FM band)
Model Number	:	ST-26
FCC ID	:	QPRST26
Applicant	:	Jow Tong Technology Co., Ltd. 46, Lane 337, Chung Cheng Rd., Yung Kang, Tainan Hsien 710, Taiwan, R.O.C.
Manufacturer	:	Jow Tong Technology Co., Ltd. 46, Lane 337, Chung Cheng Rd., Yung Kang, Tainan Hsien 710, Taiwan, R.O.C.
Fundamental Frequency Range	:	FM: 88.1MHz~107.9MHz
Radio Frequency Adjustment	:	0.1MHz / Per Step.
Input Voltage & Current	:	DC +10V~+16V, 2A (Max.)
Power Plug for Car	:	Jow Tong 12V~24V
Date of Receipt of Sample	:	Jan. 08, 2004
Date of Test	:	Feb 09 ~ Mar. 13, 2004 (Rev. 3)

Remark:

Antenna requirement: This EUT's transmitter antenna is a kind of coil ANT and solder on PCB, comply with §15.203 and inform to user that any change and modify is prohibited.

1.2. Tested Supporting System Details

1.2.1. AUDIO PLAYER (MP3/iPod, 10GB)

Model Number : A1040
 Serial Number : GQ3270HVNRH
 FCC ID : By DoC
 Manufacturer : Apple Computer
 Power Supply : DC 8-30V, 1.0A (MAX)
 HDD Unit : Toshiba, M/N: MK1003GAL

1.2.2. DC POWER SUPPLY (DC 12V)

Model Number : 3303A
 Serial Number : N/A
 Manufacturer : Topward
 Power Wire (to EUT) : Non-Shielded, Detachable, 0.8m *2
 Power Cord : Non-Shielded, Detachable, 1.8m

1.2.3. EARPHONE

Model Number : N/A
 Serial Number : N/A
 Manufacturer : Panasonic
 Earphone Line : Non-Shielded, Undetachable, 1.1m

1.3. Description of Test Facility

Name of Firm : Audix Corporation
 Technical Division EMC Department
 No. 53-11, Tin-Fu Tsun, Lin-Kou Hsiang,
 Taipei Hsien 24443, Taiwan, R.O.C.

Test Location & Facility (AC) : **Semi-Anechoic Chamber**
 No. 53-11, Tin-Fu Tsun, Lin-Kou Hsiang,
 Taipei Hsien 24443, Taiwan, R.O.C.
 May. 16, 2003 Re-File on
 Federal Communication Commission
 Registration Number: 90993

NVLAP Lab. Code : 200077-0

1.4. Measurement Uncertainty

Test Item	Frequency Range	Uncertainty (dB)
Conduction Test	150kHz~30MHz	±2.66dB
Radiation Test (Distance: 3m)	30MHz~300MHz	+4.26dB / -4.22dB
	300MHz~1000MHz	+5.28dB / -4.0dB

Remark : Uncertainty = $k_{uc}(y)$

2. POWERLINE CONDUCTED EMISSION MEASUREMENT

【The EUT only employ battery power for operation, no conductive emissions limits are required according to FCC Part 15 Section §15.207】

3. RADIATED EMISSION MEASUREMENT

3.1. Test Equipment

The following test equipment was used during the radiated emission measurement:

3.1.1. For 30MHz~1000MHz Frequency (at Semi-Anechoic Chamber)

Item	Type	Manufacturer	Model No.	Serial No.	Last Cal.	Next Cal.
1.	Spectrum Analyzer	HP	8593EM	3826A00248	Sep.24, 03'	Sep.23, 04'
2.	Pre-Amplifier	HP	8447D	2944A06305	Mar.12, 04'	Mar.11, 05'
3.	Broadband Antenna	Schwarzbeck	BBA 9106	A3L	Feb.21, 04'	Feb.20, 05'
4.	Broadband Antenna	Schwarzbeck	UHALP9108-A	0138	Feb.21, 04'	Feb.20, 05'

3.1.2. For 1GHz~2GHz frequency (at Semi-Anechoic Chamber)

Item	Type	Manufacturer	Model No.	Serial No.	Last Cal.	Next Cal.
1.	Spectrum Analyzer	HP	8593EM	3826A00248	Sep.24, 03'	Sep.23, 04'
2.	Pre-Amplifier	HP	8449B	3008A01284	Jul. 02, 03'	Jul. 01, 04'
3.	Horn Antenna	EMCO	3115	9112-3775	Apr. 21, 03'	Apr.20, 04'

3.2. Test Setup

3.2.1. Block Diagram of connection between EUT and simulators

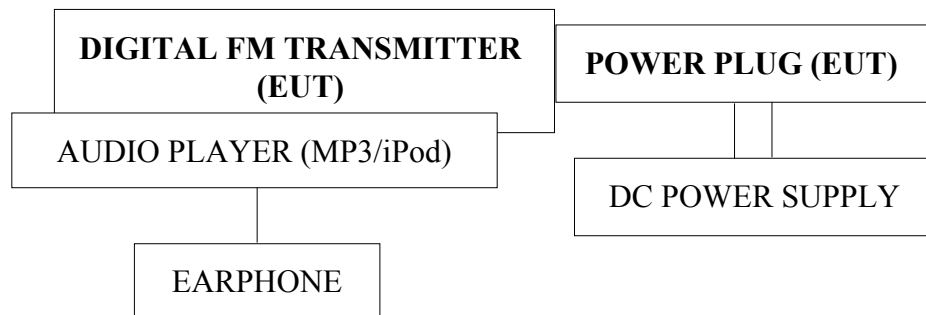

3.2.2. Semi-Anechoic Chamber (3m) Setup Diagram

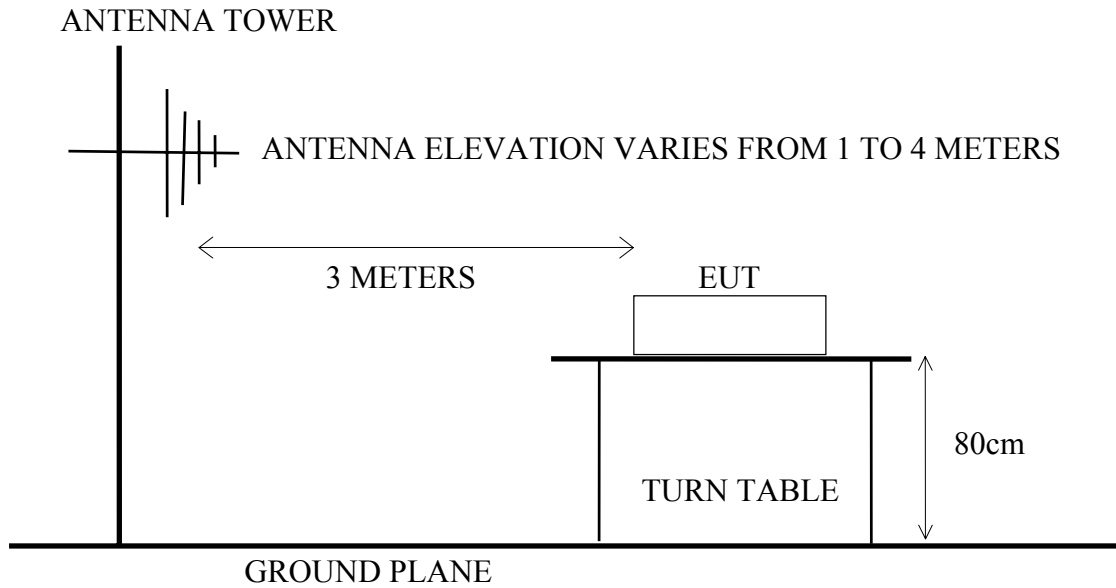

3.3. Radiation Limit (Comply with §15.239 & §15.209)

3.3.1. §15.239 Radiated Emission Limits (Fundamental Frequency)

FREQUENCY MHz	DISTANCE Meters	FIELD STRENGTHS LIMITS	
		μV/m	dBμV/m
Fundamental Freq.	3	250	48.0 (Average)
Fundamental Freq.	3	250	68.0 (Peak) ^{*(2)}

- Remark : (1) Emission level (dBμV/m) = 20 log Emission level (μV/m)
 (2) The provision in section 15.35 for limiting peak emission apply.

3.3.2. §15.209 Radiated Emission Limits (Spurious Frequency)

FREQUENCY MHz	DISTANCE Meters	FIELD STRENGTHS LIMITS	
		μV/m	dBμV/m
30 ~ 88	3	100	40.0
88 ~ 216	3	150	43.5
216 ~ 960	3	200	46.0
Above 960	3	500	54.0
1000 ~ 2000	3	---	54 (Average) ^{*(4)}
1000 ~ 2000	3	---	74 (Peak) ^{*(4)}

- Remark : (1) Emission level (dBμV/m) = 20 log Emission level (μV/m)
 (2) The tighter limit applies at the edge between two frequency bands.
 (3) Distance refers to the distance in meters between the measuring instrument antenna and the closed point of any part of the device or system.
 (4) The over 1GHz limit, FCC limit is used based on CFR 47 Part 15.35 (b) and 15.205(b) & Part 15.209(e).

3.4. EUT's Configuration during Compliance Measurement

The following equipment were installed on radiated measurement to meet the commission requirement and operating in a manner which tended to maximize its emission characteristics in a normal application.

3.4.1. Digital FM Transmitter (EUT)

Model Number	:	ST-26
Serial Number	:	N/A
FCC ID	:	QPRST26
Manufacturer	:	Jow Tong Technology Co., Ltd.
Fundamental Frequency	:	88.1MHz~107.9MHz
Power Plug for Car	:	Jow Tong 12V~24V

3.5. Operating Condition of EUT

- 3.5.1. Setup the EUT and simulator as shown on 3.2.
- 3.5.2. Turned on the power of all equipment.
- 3.5.3. The EUT linked to Audio Player and set the transmitting frequency tune in to 88.1MHz、98.0MHz、107.9MHz to measure field strength.
- 3.5.4. The other peripheral devices were drove and operated in turn during all testing.

3.6. Test Procedure

The EUT and its simulators were placed on a turn table which was 0.8 meter above the ground. The turn table rotated 360 degrees to determine the position of the maximum emission level. EUT was set 3 meters away from the receiving antenna which was mounted on a antenna tower. The antenna moved up and down between 1 to 4 meters to find out the maximum emission level. Broadband antenna such as calibrated biconical and log- periodical antenna or horn antenna were used as a receiving antenna. Both horizontal and vertical polarization of the antenna were set on measurement. In order to find the maximum emission, all of the interface cables were manipulated according to FCC ANSI C63.4-2001 regulations.

The bandwidth of test receiver was set at 120kHz and resolution bandwidth of spectrum analyzer was set at 1MHz.

The frequency range from 30MHz to 2000MHz was checked. All emissions not reported below are too low against the prescribed limits.

EUT with the following test modes were measured within Semi-Anechoic Chamber and all the scanning waveform were attached within Appendix, which include :

Mode	Transmitting Frequency	Power Supply
1.	88.1MHz	Power Plug for Car (DC 12V)
2.	98.0MHz	
※ 3.	107.9MHz	

Finally, re-measured the worst test mode (Mode 3) at Semi-Anechoic Chamber and all the test results are listed in section 3.7.

3.7. Radiated Emission Noise Measurement Results

PASSED. Please refer to the following pages.

The frequency spectrum from 30 MHz to 2000MHz is investigated. All the emissions not reported below are too low against the FCC Part 15 Subpart C official limits.

Date of Test : Mar. 13, 2004 Temperature : 19°C
 EUT : Digital FM Transmitter Humidity : 68%
 Test Mode : Transmitting frequency, 107.9MHz
(Power Plug for Car, DC 12V)

Frequency MHz	Antenna Factor dB/m	Cable Loss dB	Meter Reading		Emission Level		Margin dB
			Horizontal dBµV	Horizontal dBµV/m	Horizontal dBµV/m	Limits dBµV/m	

Fundamental Freq. (Average Value)							
107.900	17.58	2.20	23.10	42.88	48.00	5.12	
Fundamental Freq. (Peak Value)							
107.900	17.58	2.20	25.91	45.69	68.00	22.31	
Spurious Freq. (Quasi-Peak Value)							
120.180	18.83	2.30	7.41	28.54	43.50	14.96	
168.240	21.50	2.70	3.54	27.74	43.50	15.76	
215.800	22.70	3.20	9.57	35.47	46.00	10.53	
323.700	14.70	4.20	14.86	33.76	46.00	12.24	
431.600	17.20	5.20	8.85	31.25	46.00	14.75	
503.000	18.30	6.60	5.78	30.68	46.00	15.32	
539.500	18.70	7.07	2.78	28.55	46.00	17.45	
647.400	20.90	6.40	0.83	28.13	46.00	17.87	
701.800	21.10	6.50	8.04	35.64	46.00	10.36	
913.900	23.10	7.40	7.65	38.15	46.00	7.85	

Remark : 1. Emission Level = Antenna Factor + Cable Loss + Meter Reading.
 2. The emissions level are too low against the official limit and not report.

Date of Test : Mar. 13, 2004 Temperature : 19°C
 EUT : Digital FM Transmitter Humidity : 68%
 Test Mode : Transmitting frequency, 107.9MHz
(Power Plug for Car, DC 12V)

Frequency MHz	Antenna Factor dB/m	Cable Loss dB	Meter Reading Vertical dBμV	Emission Level Vertical dBμV/m	Limits dBμV/m	Margin dB

Fundamental Freq. (Average Value)						
107.900	17.36	2.20	19.86	39.42	48.00	8.58
Fundamental Freq. (Peak Value)						
107.900	17.36	2.20	27.70	47.26	68.00	20.74
Spurious Freq. (Quasi-Peak Value)						
58.080	15.54	1.60	5.90	23.04	40.00	16.96
193.840	21.29	3.00	4.36	28.65	43.50	14.85
215.800	22.82	3.20	3.12	29.14	46.00	16.86
323.700	14.50	4.20	9.07	27.77	46.00	18.23
406.400	16.30	4.90	3.81	25.01	46.00	20.99
431.600	16.60	5.20	4.43	26.23	46.00	19.77
502.300	17.97	6.52	6.40	30.89	46.00	15.11
539.500	18.70	7.07	0.44	26.21	46.00	19.79
647.400	20.45	6.30	- 1.23	25.52	46.00	20.48
675.900	20.70	6.40	10.25	37.35	46.00	8.65
729.800	21.20	6.60	8.28	36.08	46.00	9.92
783.700	21.88	6.90	9.69	38.47	46.00	7.53
806.800	21.50	7.00	9.86	38.36	46.00	7.64
913.900	23.13	7.40	6.36	36.89	46.00	9.11

Remark : 1. Emission Level = Antenna Factor + Cable Loss + Meter Reading.
 2. The emissions level are too low against the official limit and not report.

4. 26dB BANDWIDTH MEASUREMENT

4.1. Test Equipment

The following test equipment were used during the Emission Bandwidth Measurement:

Item	Type	Manufacturer	Model No.	Serial No.	Last Cal.	Next Cal.
1.	Spectrum Analyzer	HP	8564EC	3946A00249	Aug.28, 03'	Aug.27. 04'

4.2. Block Diagram of Test Setup

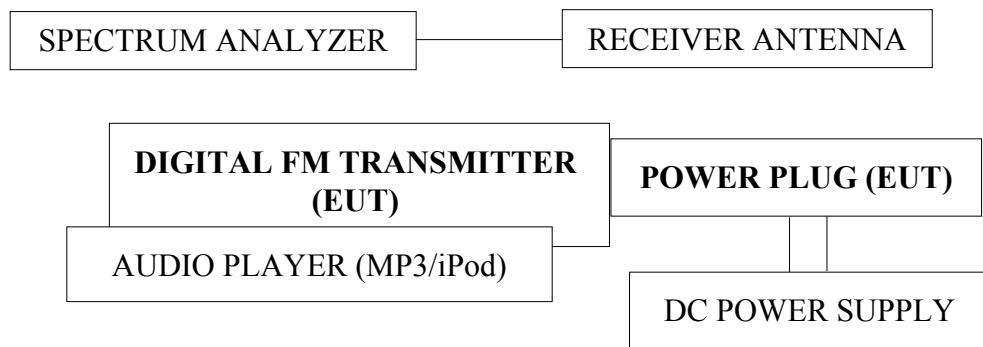

4.3. Specification Limits (§15.239)

The 26dB bandwidth of fundamental emission from the intentional radiator shall be confined within a band 200kHz wide centered on the operating frequency. The 200kHz band shall lie wholly within the frequency range of 88-107.9MHz.

4.4. EUT's Configuration during Compliance Measurement

The configuration of EUT were same as section 2.4.

4.5. 26dB Bandwidth Measurement Results

PASSED. The graph of bandwidth measured is attached in next pages.

Date of Test: Mar. 05, 2004 Temperature : 20°C Humidity : 68%

Mode	Center Frequency	26dB Bandwidth	Limits
1.	88.1063MHz	46.0kHz	200kHz
2.	98.0067MHz	45.3kHz	200kHz
3.	107.9080MHz	44.3kHz	200kHz

Remark: The lowest frequency is 88.0833MHz and the highest frequency is 107.93015MHz.

(Graph of Bandwidth Measurement)

Center Frequency 88.1063MHz, 26dB Bandwidth: 46.0kHz

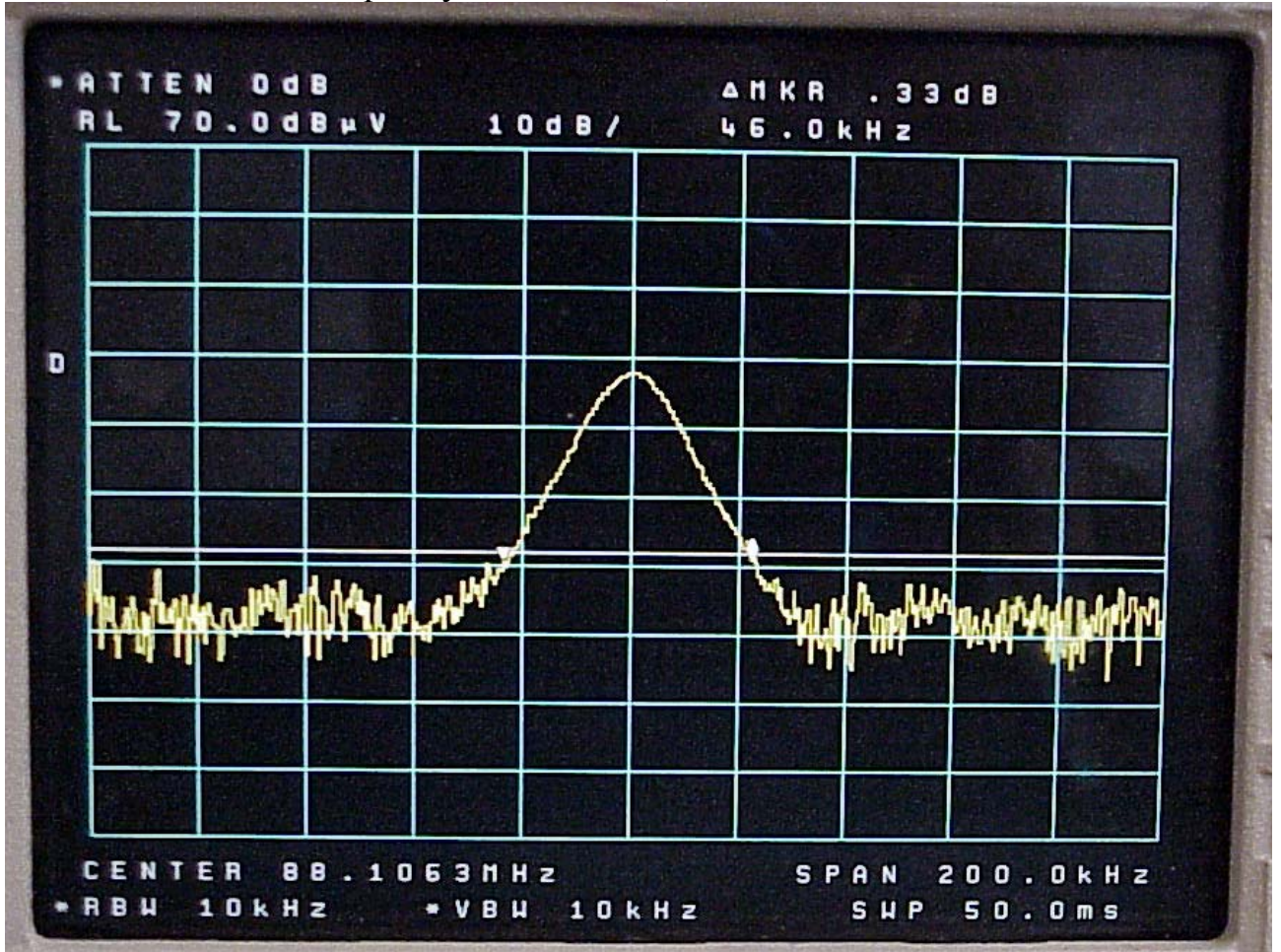

(Graph of Bandwidth Measurement)

Center Frequency 98.0067MHz, 26dB Bandwidth: 45.3kHz

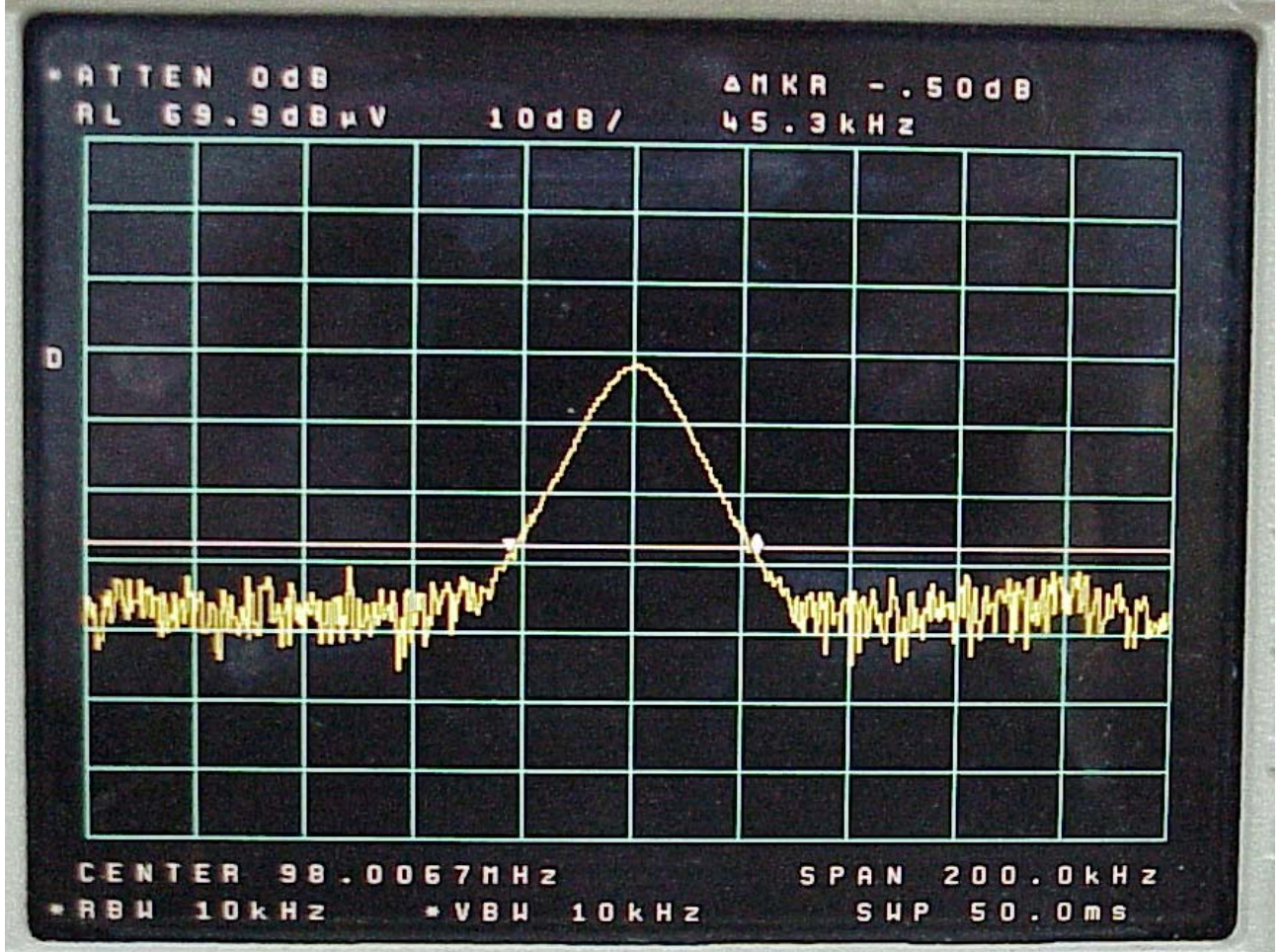

(Graph of Bandwidth Measurement)

Center Frequency 107.9080MHz, 26dB Bandwidth: 44.3kHz

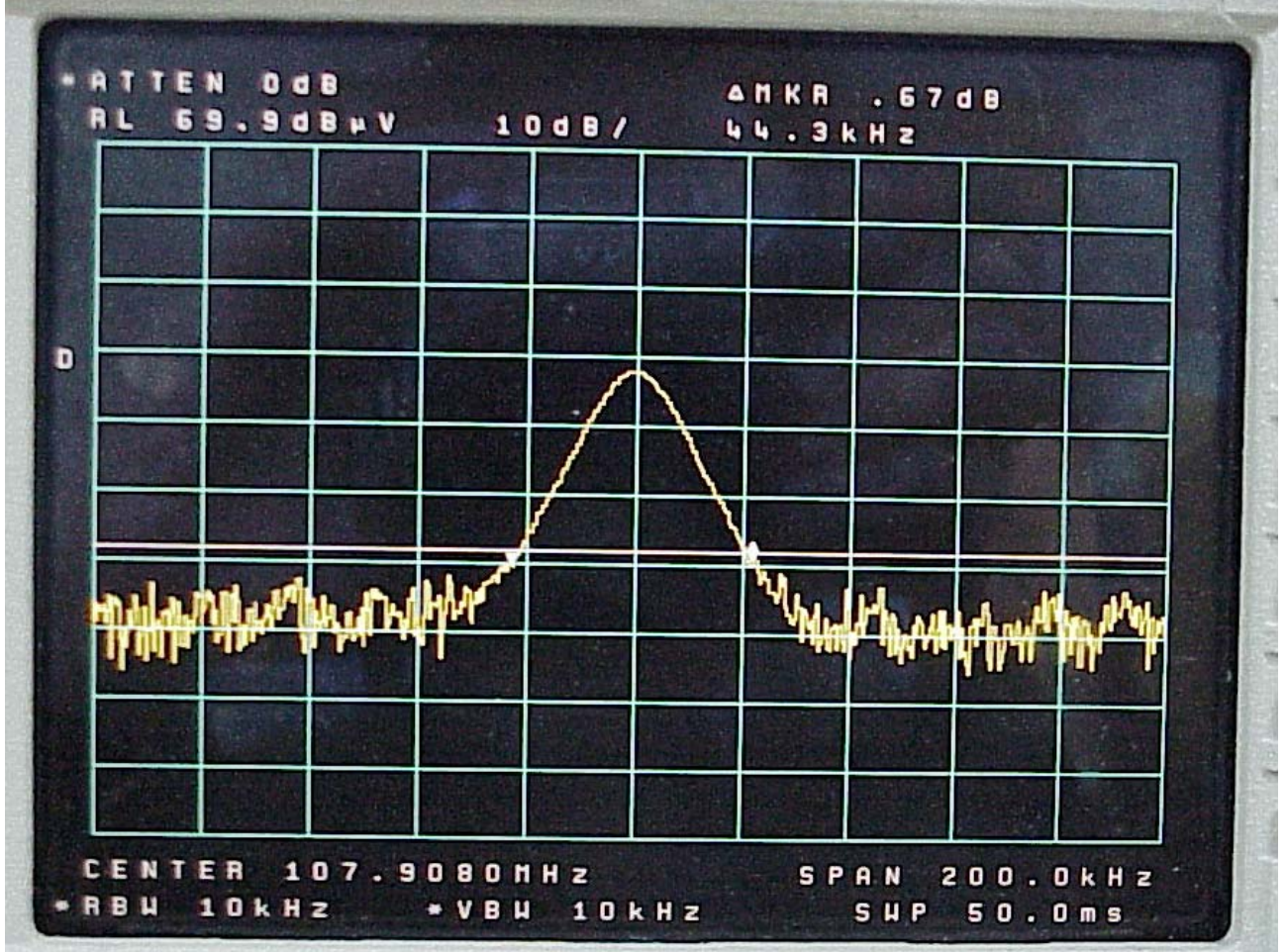

5. DEVIATION TO TEST SPECIFICATIONS

【NONE】

6. PHOTOGRAPHS

6.1. Photos of Radiated Measurement at Semi-Anechoic Chamber (30-1000MHz)



FRONT VIEW OF RADIATED MEASUREMENT



BACK VIEW OF RADIATED MEASUREMENT

6.2. Photos of Radiated Measurement at Semi-Anechoic Chamber (1-2GHz)

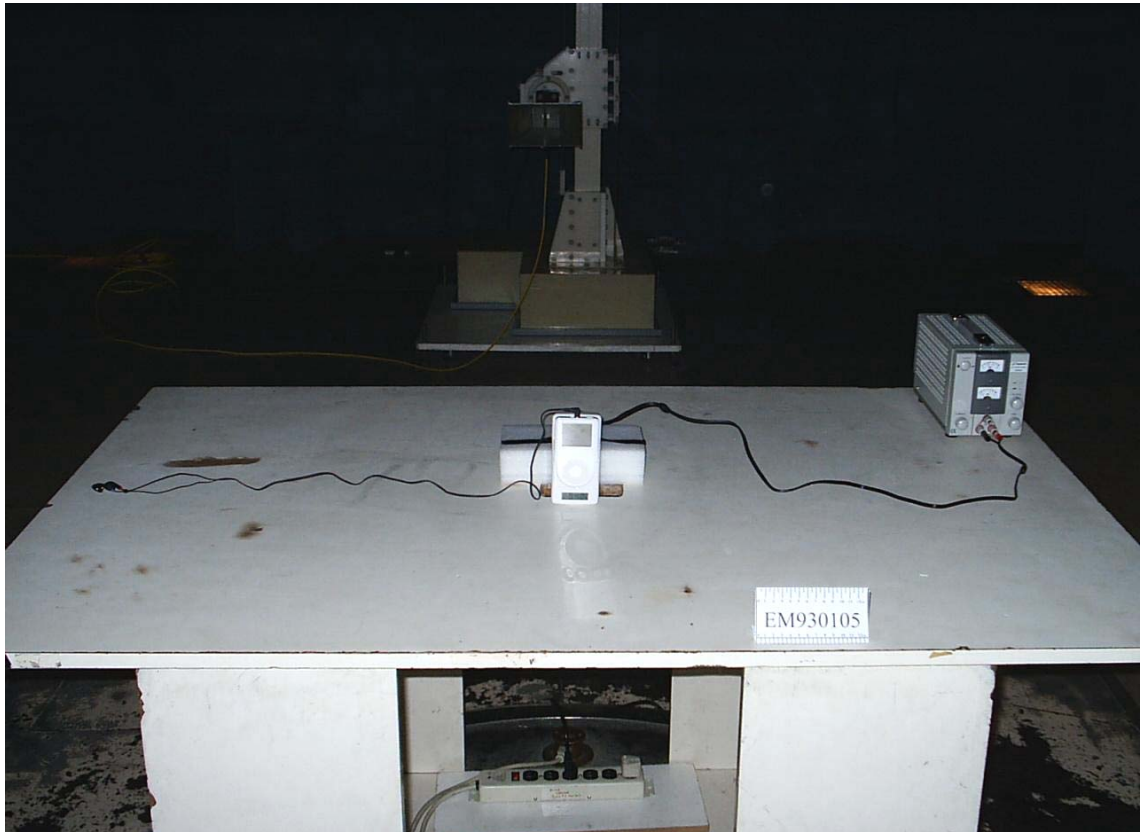

FRONT VIEW OF RADIATED MEASUREMENT

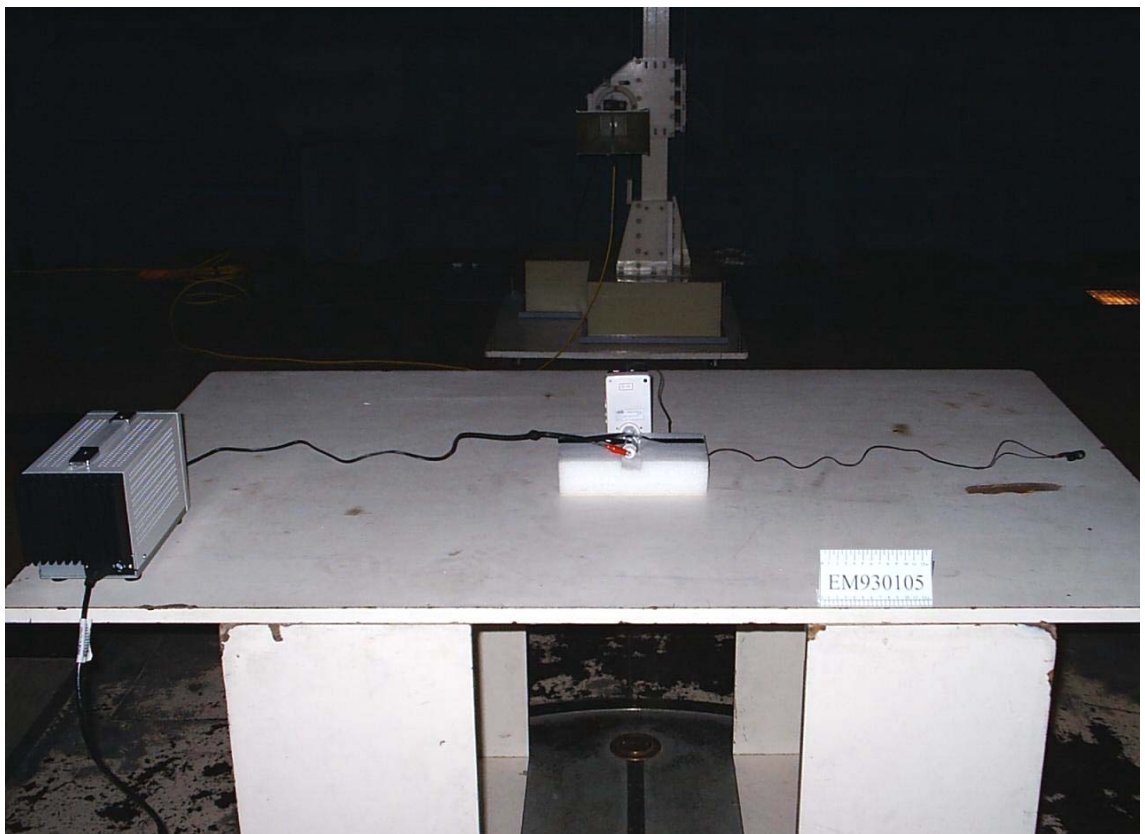

BACK VIEW OF RADIATED MEASUREMENT

6.3. Photos of Bandwidth Measurement



APPENDIX

Radiated Test Data At Semi-Anechoic Chamber

(Total Pages: 4)



EMC Laboratory
 No.53-11, Tin-fu Tsun, Lin-kou Hsiang, Taipei
 County, Taiwan R.O.C. Post Code:24443
 Tel:+886-2-26092133 Fax:+886-2-26099303
 Email:tttemc@tttemc.com.tw
 Web:www.tttemc.com.tw



EMC Laboratory
 No.53-11, Tin-fu Tsun, Lin-kou Hsiang, Taipei
 County, Taiwan R.O.C. Post Code:24443
 Tel:+886-2-26092133 Fax:+886-2-26099303
 Email:tttemc@tttemc.com.tw
 Web:www.tttemc.com.tw

Data#: 1 File#: C:\930105(EDITION-E2).EMI

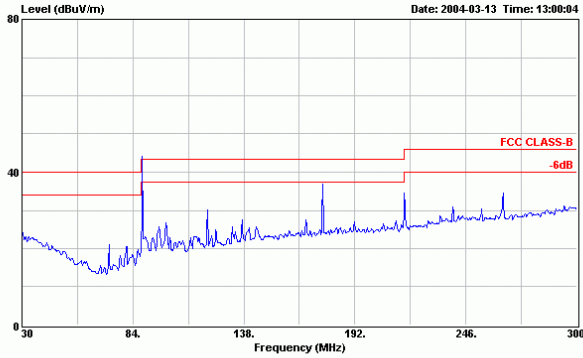

Site : Anechoic Chamber
 Condition : FCC CLASS-B 3m BBA9106(A3L) HORIZONTAL
 EUT : Universal Digital FM Transmitter
 POWER : M/N:ST-26 (TX:88.1MHz)
 MEMO : DC 12V
 ENVIRONMENT : 19°C/68%

Data#: 2 File#: C:\930105(EDITION-E2).EMI

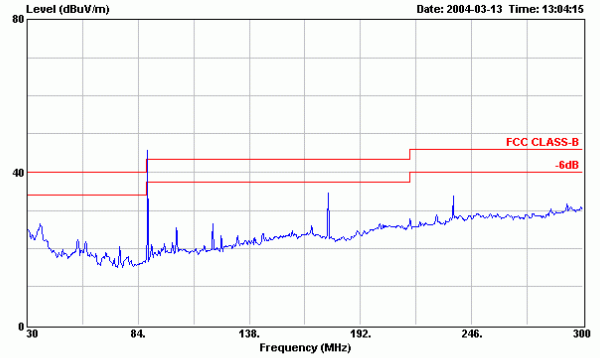

Site : Anechoic Chamber
 Condition : FCC CLASS-B 3m BBA9106(A3L) VERTICAL
 EUT : Universal Digital FM Transmitter
 POWER : M/N:ST-26 (TX:88.1MHz)
 MEMO : DC 12V
 ENVIRONMENT : 19°C/68%



EMC Laboratory
 No.53-11, Tin-fu Tsun, Lin-kou Hsiang, Taipei
 County, Taiwan R.O.C. Post Code:24443
 Tel:+886-2-26092133 Fax:+886-2-26099303
 Email:tttemc@tttemc.com.tw
 Web:www.tttemc.com.tw



EMC Laboratory
 No.53-11, Tin-fu Tsun, Lin-kou Hsiang, Taipei
 County, Taiwan R.O.C. Post Code:24443
 Tel:+886-2-26092133 Fax:+886-2-26099303
 Email:tttemc@tttemc.com.tw
 Web:www.tttemc.com.tw

Data#: 11 File#: C:\930105(EDITION-E2).EMI

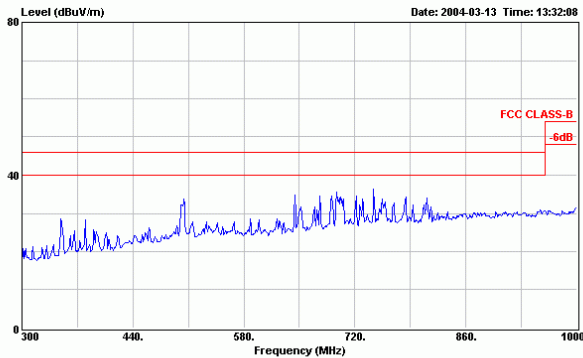

Site : Anechoic Chamber
 Condition : FCC CLASS-B 3m UHALP 9108-A 0138 HORIZONTAL
 EUT : Universal Digital FM Transmitter
 POWER : M/N:ST-26 (TX:88.1MHz)
 MEMO : DC 12V
 ENVIRONMENT : 19°C/68%

Data#: 12 File#: C:\930105(EDITION-E2).EMI

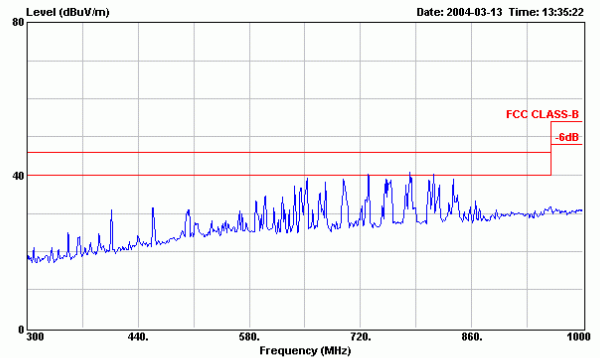

Site : Anechoic Chamber
 Condition : FCC CLASS-B 3m UHALP 9108-A 0138 VERTICAL
 EUT : Universal Digital FM Transmitter
 POWER : M/N:ST-26 (TX:88.1MHz)
 MEMO : DC 12V
 ENVIRONMENT : 19°C/68%



EMC Laboratory
 No.53-11, Tin-fu Tsun, Lin-kou Hsiang, Taipei
 County, Taiwan R.O.C. Post Code:24443
 Tel:+886-2-26092133 Fax:+886-2-26099303
 Email:ttenc@ttenc.com.tw
 Web:www.ttenc.com.tw



EMC Laboratory
 No.53-11, Tin-fu Tsun, Lin-kou Hsiang, Taipei
 County, Taiwan R.O.C. Post Code:24443
 Tel:+886-2-26092133 Fax:+886-2-26099303
 Email:ttenc@ttenc.com.tw
 Web:www.ttenc.com.tw

Data#: 4 File#: C:\930105(EDITION-E2).EMI

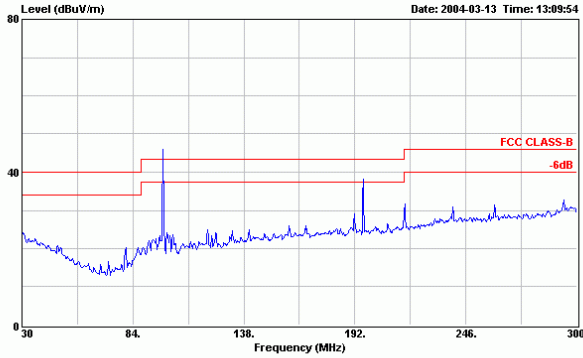

Site : Anechoic Chamber
 Condition : FCC CLASS-B 3m BBA9106(A3L) HORIZONTAL
 EUT : Universal Digital FM Transmitter
 POWER : M/N:ST-26 (TX:98MHz)
 MEMO : DC 12V
 ENVIRONMENT : 19°C/68%

Data#: 3 File#: C:\930105(EDITION-E2).EMI

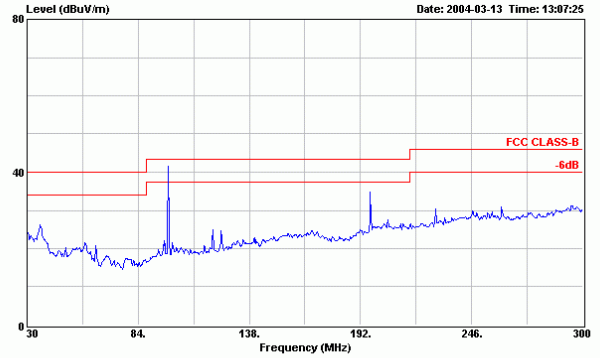

Site : Anechoic Chamber
 Condition : FCC CLASS-B 3m BBA9106(A3L) VERTICAL
 EUT : Universal Digital FM Transmitter
 POWER : M/N:ST-26 (TX:98MHz)
 MEMO : DC 12V
 ENVIRONMENT : 19°C/68%



EMC Laboratory
 No.53-11, Tin-fu Tsun, Lin-kou Hsiang, Taipei
 County, Taiwan R.O.C. Post Code:24443
 Tel:+886-2-26092133 Fax:+886-2-26099303
 Email:ttenc@ttenc.com.tw
 Web:www.ttenc.com.tw



EMC Laboratory
 No.53-11, Tin-fu Tsun, Lin-kou Hsiang, Taipei
 County, Taiwan R.O.C. Post Code:24443
 Tel:+886-2-26092133 Fax:+886-2-26099303
 Email:ttenc@ttenc.com.tw
 Web:www.ttenc.com.tw

Data#: 9 File#: C:\930105(EDITION-E2).EMI

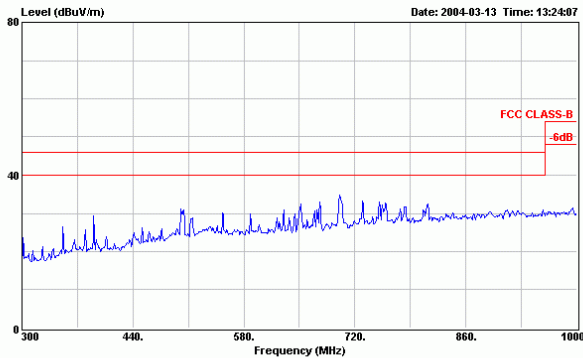

Site : Anechoic Chamber
 Condition : FCC CLASS-B 3m UHALP 9108-A 0138 HORIZONTAL
 EUT : Universal Digital FM Transmitter
 POWER : M/N:ST-26 (TX:98MHz)
 MEMO : DC 12V
 ENVIRONMENT : 19°C/68%

Data#: 10 File#: C:\930105(EDITION-E2).EMI

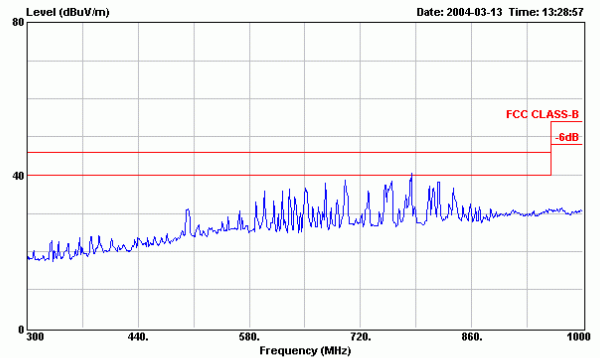

Site : Anechoic Chamber
 Condition : FCC CLASS-B 3m UHALP 9108-A 0138 VERTICAL
 EUT : Universal Digital FM Transmitter
 POWER : M/N:ST-26 (TX:98MHz)
 MEMO : DC 12V
 ENVIRONMENT : 19°C/68%



EMC Laboratory
 No.53-11, Tin-fu Tsun, Lin-kou Hsiang, Taipei
 County, Taiwan R.O.C. Post Code:24443
 Tel:+886-2-26092133 Fax:+886-2-26099303
 Email:tttemc@tttemc.com.tw
 Web:www.tttemc.com.tw



EMC Laboratory
 No.53-11, Tin-fu Tsun, Lin-kou Hsiang, Taipei
 County, Taiwan R.O.C. Post Code:24443
 Tel:+886-2-26092133 Fax:+886-2-26099303
 Email:tttemc@tttemc.com.tw
 Web:www.tttemc.com.tw

Data#: 5 File#: C:\930105(EDITION-E2).EMI

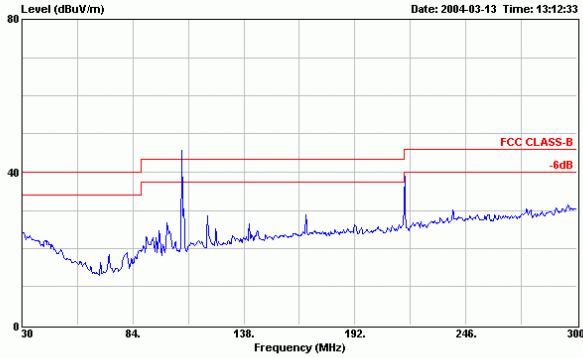

Site : Anechoic Chamber
 Condition : FCC CLASS-B 3m BBA9106(A3L) HORIZONTAL
 EUT : Universal Digital FM Transmitter
 POWER : M/N:ST-26 (TX:107.9MHz)
 MEMO : DC 12V
 ENVIRONMENT : 19°C/68%

Data#: 6 File#: C:\930105(EDITION-E2).EMI

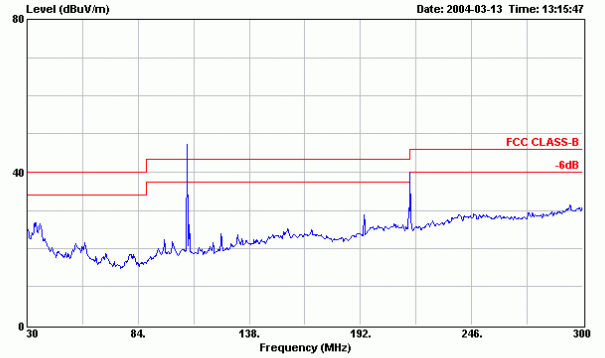

Site : Anechoic Chamber
 Condition : FCC CLASS-B 3m BBA9106(A3L) VERTICAL
 EUT : Universal Digital FM Transmitter
 POWER : M/N:ST-26 (TX:107.9MHz)
 MEMO : DC 12V
 ENVIRONMENT : 19°C/68%



EMC Laboratory
 No.53-11, Tin-fu Tsun, Lin-kou Hsiang, Taipei
 County, Taiwan R.O.C. Post Code:24443
 Tel:+886-2-26092133 Fax:+886-2-26099303
 Email:tttemc@tttemc.com.tw
 Web:www.tttemc.com.tw



EMC Laboratory
 No.53-11, Tin-fu Tsun, Lin-kou Hsiang, Taipei
 County, Taiwan R.O.C. Post Code:24443
 Tel:+886-2-26092133 Fax:+886-2-26099303
 Email:tttemc@tttemc.com.tw
 Web:www.tttemc.com.tw

Data#: 8 File#: C:\930105(EDITION-E2).EMI

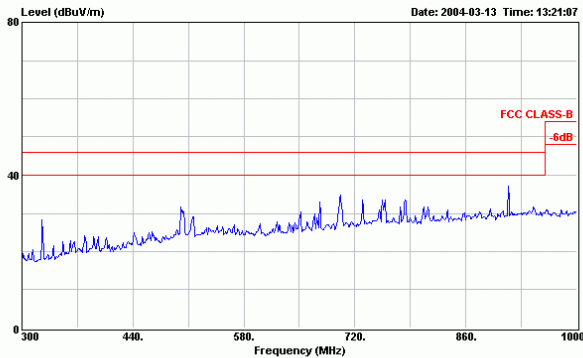

Site : Anechoic Chamber
 Condition : FCC CLASS-B 3m UHALP 9108-A 0138 HORIZONTAL
 EUT : Universal Digital FM Transmitter
 POWER : M/N:ST-26 (TX:107.9MHz)
 MEMO : DC 12V
 ENVIRONMENT : 19°C/68%

Data#: 7 File#: C:\930105(EDITION-E2).EMI

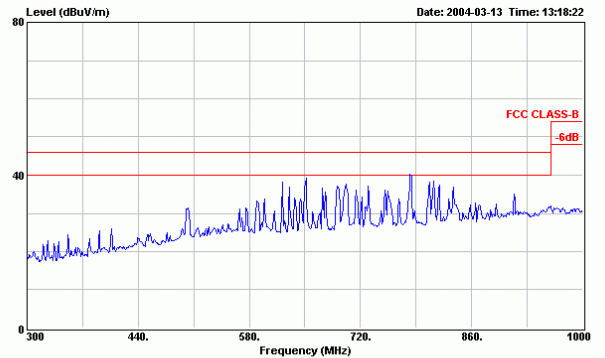

Site : Anechoic Chamber
 Condition : FCC CLASS-B 3m UHALP 9108-A 0138 VERTICAL
 EUT : Universal Digital FM Transmitter
 POWER : M/N:ST-26 (TX:107.9MHz)
 MEMO : DC 12V
 ENVIRONMENT : 19°C/68%



EMC Laboratory
 No.53-11, Tin-fu Tsun, Lin-kou Hsiang, Taipei
 County, Taiwan R.O.C. Post Code:24443
 Tel:+886-2-26092133 Fax:+886-2-26099303
 Email:tttemc@tttemc.com.tw
 Web:www.tttemc.com.tw



EMC Laboratory
 No.53-11, Tin-fu Tsun, Lin-kou Hsiang, Taipei
 County, Taiwan R.O.C. Post Code:24443
 Tel:+886-2-26092133 Fax:+886-2-26099303
 Email:tttemc@tttemc.com.tw
 Web:www.tttemc.com.tw

Data#: 13 File#: C:\930105(EDITION-E2).EMI

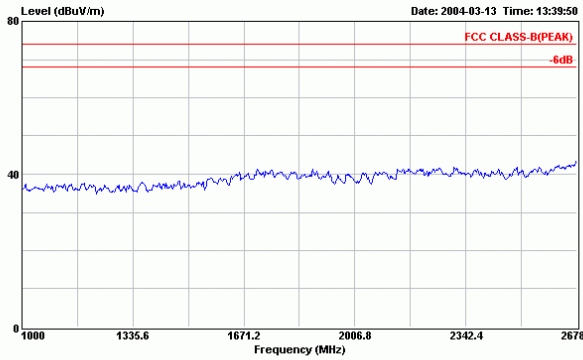

Site : Anechoic Chamber
 Condition : FCC CLASS-B(PEAK) 3m 3115 HORIZONTAL
 EUT : Universal Digital FM Transmitter
 POWER : M/N:ST-26 (TX:107.9MHz)
 MEMO : DC 12V
 ENVIRONMENT : 19°C/68%

Data#: 14 File#: C:\930105(EDITION-E2).EMI

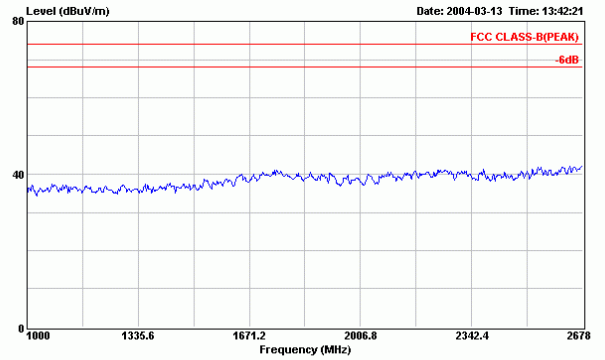

Site : Anechoic Chamber
 Condition : FCC CLASS-B(PEAK) 3m 3115 VERTICAL
 EUT : Universal Digital FM Transmitter
 POWER : M/N:ST-26 (TX:107.9MHz)
 MEMO : DC 12V
 ENVIRONMENT : 19°C/68%