



# **TEST REPORT**

**No. I19D00063-EMC01**

*For*

**Client : MobiWire SAS**

**Production: 4G Smart Phone**

**Model Name : MobiWire Nuna, Altice S42**

**Brand Name: MobiWire, Altice**

**FCC ID: QPN-NUNA**

**Hardware Version: V00**

**Software Version: ALTICE\_S42**

**Issued date: 2019-06-28**

## NOTE

1. The test results in this test report relate only to the devices specified in this report.
2. This report shall not be reproduced except in full without the written approval of East China Institute of Telecommunications.
3. The measurement uncertainty is not taken into account when deciding conformity, and the results of measurement (or the average of measurement results) are directly used as the criterion for the stating conformity.

**Test Laboratory:**

East China Institute of Telecommunications

Add: 7-8F, G Area, No.668, Beijing East Road, Huangpu District, Shanghai, P. R. China

Tel: +862163843300

FAX: +862163843301

E-Mail: [welcome@ecit.org.cn](mailto:welcome@ecit.org.cn)

**Revision Version**

<b>Report Number</b>	<b>Revision</b>	<b>Date</b>	<b>Memo</b>
I19D00063-EMC01	00	2019-06-28	Initial creation of test report

## CONTENTS

1. TEST LABORATORY .....	6
1.1. TESTING LOCATION .....	6
1.2. TESTING ENVIRONMENT .....	6
1.3. PROJECT DATA.....	6
1.4. SIGNATURE.....	6
2. CLIENT INFORMATION .....	7
2.1. APPLICANT INFORMATION.....	7
2.2. MANUFACTURER INFORMATION.....	7
3. EQUIPMENT UNDER TEST (EUT) AND ANCILLARY EQUIPMENT (AE) .....	8
3.1. ABOUT EUT.....	8
3.2. INTERNAL IDENTIFICATION OF EUT USED DURING THE TEST .....	8
3.3. INTERNAL IDENTIFICATION OF AE USED DURING THE TEST .....	8
4. REFERENCE DOCUMENTS.....	9
4.1. REFERENCE DOCUMENTS FOR TESTING .....	9
5. TEST RESULTS.....	10
5.1. SUMMARY OF TEST RESULTS.....	10
5.2. STATEMENTS.....	10
6. TEST EQUIPMENTS UTILIZED.....	11
6.1 RADIATED EMISSION EQUIPMENTS LIST.....	11
6.2 AC CONDUCTED EMISSION EQUIPMENTS LIST .....	11
7. SYSTEM CONFIGURATION DURING TEST.....	12
7.1 TEST MODE.....	12
7.2 CONNECTION DIAGRAM OF TEST SYSTEM.....	13
8. MEASUREMENT RESULTS.....	14
8.1 RADIATED EMISSION 30MHZ-18GHZ.....	14

**8.2 AC CONDUCTED EMISSION..... 18**

## 1. Test Laboratory

### 1.1. Testing Location

Company Name: ECIT Shanghai, East China Institute of Telecommunications  
Address: 7F, G Area, No. 668, Beijing East Road, Huangpu District, Shanghai,  
P. R. China  
Postal Code: 200001  
Telephone: 86-21-63843300  
Fax: 86-21-63843301  
FCC registration No: 958356

### 1.2. Testing Environment

Normal Temperature: 15-35°C  
Relative Humidity: 25-75%RH

### 1.3. Project data

Project Leader: Zhang Min  
Testing Start Date: 2019-05-27  
Testing End Date: 2019-06-02

### 1.4. Signature

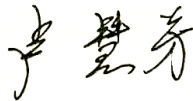

Lu Huifang

(Prepared this test report)



You Jinjun

(Reviewed this test report)

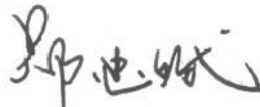

Zheng Zhongbin

(Approved this test report)

## 2. Client Information

### 2.1. Applicant Information

Company Name	MobiWire SAS
Address	79 AVENUE FRANCOIS ARAGO 92017 NANTERRE CEDEX France.
Telephone	+33668018722
Postcode	/

### 2.2. Manufacturer Information

Company Name	MobiWire SAS
Address	79 AVENUE FRANCOIS ARAGO 92017 NANTERRE CEDEX France.
Telephone	+33668018722
Postcode	/

### 3. Equipment under Test (EUT) and Ancillary Equipment (AE)

#### 3.1. About EUT

ProductName	4G Smart Phone
Model name	MobiWire Nuna, Altice S42
GSM Frequency Band	GSM850/GSM900/GSM1800/GSM1900
UMTS Frequency Band	WCDMA Band I / II / V / VIII
LTE FDD Frequency Band	LTE Band 1/2/3/7/8/20
Additional Communication Function	BT5.0; WIFI 802.11 a,b,g,n;GPS, GLONASS;FM;MP3;

#### 3.2. Internal Identification of EUT used during the test

EUT ID*	SN or IMEI	HW Version	SW Version	Date of receipt
N13	355647100001642/ 355647100001659	V00	ALTICE_S42	2019-05-17

\*EUT ID: is used to identify the test sample in the lab internally.

#### 3.3. Internal Identification of AE used during the test

AE ID*	Description	Model	SN
CA01	Adapter	A31A-050100U_US1	/
AA01	Earphone	JWEP0957-M01R	/
UA16	USB Cable	AM/MICRO5P	/
BA06	Battery	178159967 Veken2680mAH	59967V9033100467
AE1	Notebook PC	DELL Latitude E6510	/
AE2	Desktop PC	OptiPlex 790 DT	X8RP1 A01 APCC
AE3	LAN Cable	/	/
AE4	VGA Cable	/	/
AE5	RS232 Cable	/	/
AE6	Keyboard	KB212-B	CN-0Y88XT-65890-12I -005Q-A00
AE7	Mouse	MS111-P	CN-011D3V-71581-19 J-1A64
AE8	SanDiskUltra32GB	microSDHC UHS-I	/
AE9	Monitor	Dell E1709Wc	/

\*AE ID: is used to identify the test sample in the lab internally.



## 4. Reference Documents

### 4.1. Reference Documents for testing

The following documents listed in this section are referred for testing.

Reference	Title	Version
FCC Part 15, Subpart B	Radio frequency devices	April 2, 2019
ANSI C63.4	Method of Measurement of Radio-Noise Emissions from Low-Voltage Electrical and Electronic Equipment in the Range of 9 kHz to 40 GHz	2014

## 5. Test Results

### 5.1. Summary of Test Results

Items	Test List	Clause in FCC rules	Verdict
1	Radiated Emission	15.109(a)	Pass
2	AC Conducted Emission	15.107(a)	Pass

### 5.2. Statements

The MobiWire Nuna, Altice S42 supporting GSM/WCDMA/LTE.etc manufactured by MobiWire SAS is a new product for testing. ECIT performed test cases which identified with Pass/Fail/Inc result in section 5.1.

ECIT has verified that the compliance of the tested device specified in section 3 of this test report is successfully evaluated according to the procedure and test methods as defined in type certification requirement listed in section 4 of this test report.

## 6. Test Equipments Utilized

### 6.1 Radiated Emission Equipments list

No.	Name	Type	Series Number	Producer	Cal. Date	Cal. interval
1	Universal Radio Communication	CMU200	123126	R&S	2019-05-10	1 Year
2	Test Receiver	ESU40	100307	R&S	2019-05-10	1 Year
3	Trilog Antenna	VULB9163	VULB9163-515	Schwarzbeck	2017-02-25	3 Year
4	Double Ridged Guide	ETS-3117	00135890	ETS	2017-01-11	3 Year
5	EMI Test Software	EMC32 V9.15	NA	R&S	NA	NA
6	Signal Generator	SMF 100A	102314	R&S	2019-05-10	1 Year
7	GPS Simulator	GSS 4200	1182	SPIRENT	2018-12-17	1 Year
8	Signal Generator	SMBV100 A	257984	R&S	2019-03-06	1 Year

### 6.2 AC Conducted Emission Equipments list

No.	Name	Type	Series Number	Producer	Cal. Date	Cal. interval
1	Universal Radio	CMU200	123123	R&S	2019-05-10	1 Year
2	Test Receiver	ESCI	101235	R&S	2019-05-10	1 Year
3	2-Line V-Network	ENV216	101380	R&S	2019-05-10	1 Year
4	EMI Test Software	EMC32 V10.35.02	NA	R&S	NA	NA
6	Signal Generator	SMF 100A	102314	R&S	2019-05-10	1 Year
7	GPS Simulator	GSS 4200	1182	SPIRENT	2018-12-17	1 Year
8	Signal Generator	SMBV100 A	257984	R&S	2019-03-06	1 Year

## 7. System Configuration during Test

### 7.1 Test Mode

Test Item	Function Type
AC Conducted Emission	Mode 1: USB cable (Data Link with PC) <Figure 1> Mode 2: Adapter charging <Figure 2> Mode 3: FM mode(98MHz) <Figure 3> Mode 4: GPS mode <Figure 2> Mode 5: GLONASS mode <Figure 2>
Radiated Emission	Mode 1: USB cable (Data Link with PC) <Figure 1> Mode 2: Adapter charging <Figure 2> Mode 3: FM mode(98MHz) <Figure 3> Mode 4: GPS mode <Figure 2> Mode 5: GLONASS mode <Figure 2>
Remark: 1. All test modes are performed, only the worst cases test data are recorded in this report. 2. Data Link with PC means data application transferred mode between EUT and PC. 3. The EUT is synchronized to a FM signal generator. The EUT is keeping on demodulating the FM signal and outputting the audio signal through the headset. 4. Connect the EUT with GSS 4200 Communication. 5. EUT and GLONASS simulator (SMBV100A) connection is established.	

### 7.2 Connection Diagram of Test System

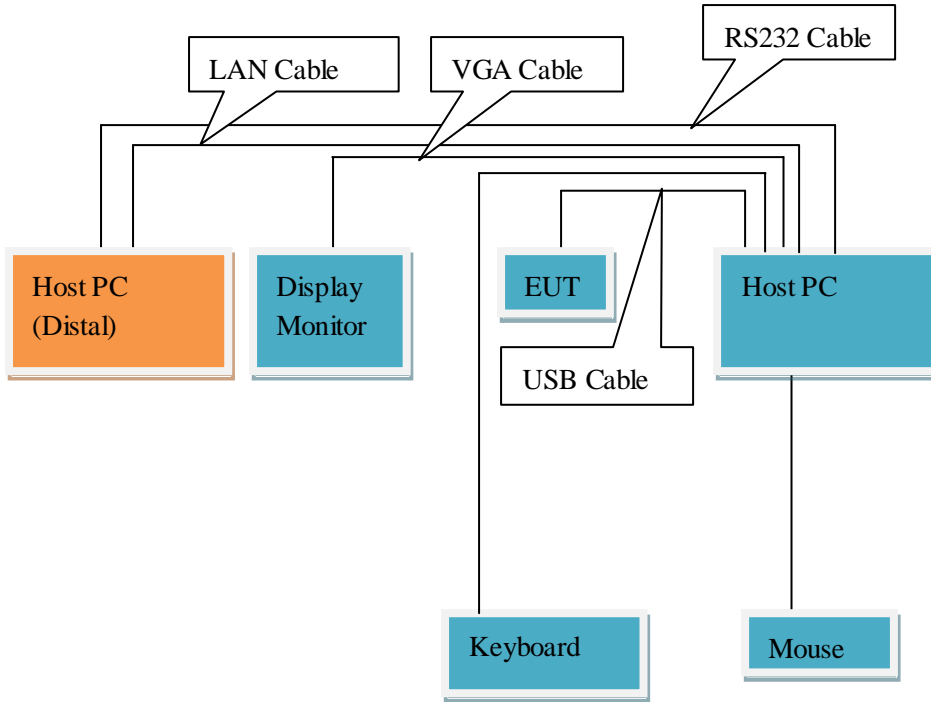

<Figure 1>

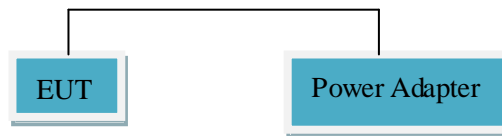

<Figure 2>

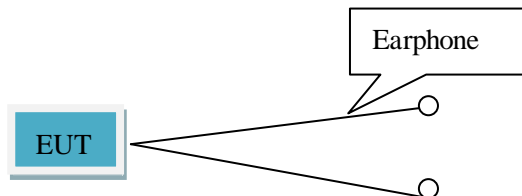

<Figure 3>

## 8. Measurement Results

Only the worst test result was shown in this report.

### 8.1 Radiated Emission 30MHz-18GHz

#### Method of Measurement

For 30MHz -1000MHz, the EUT was placed on the top of a rotating 0.8-m table above the ground at a semi-anechoic chamber. The distance between the EUT and the received antenna was 3 meters. The table was rotated 360 degree and the received antenna mounted on a variable-height antenna tower was varied from 1m to 4m to find the maximum value of the field strength. Both horizontal and vertical polarizations of the antenna were set during the measurement. Tested in accordance with the procedures of ANSI C63.4-2014, section 8.3.

For 1000MHz-18000MHz, The maximal emission value was acquired by adjusting the antenna height, The table was rotated 360 degree to determine the maximum value of the field strength. Both horizontal and vertical polarizations of the antenna were set during the measurement.

#### Limits for Radiated Emission at a measuring distance of 3m

Frequency Range (MHz)	Quasi-Peak (dBuV/m)
30-88	40
88-216	43.5
216-960	46
Above 960	54

Frequency Range (MHz)	Peak (dBuV/m)	Average (dBuV/m)
Above 1000	74	54

#### Test conditions

Frequency Range (MHz)	RBW/VBW	Sweep Time (s)
30-1000	120kHz/300kHz	Auto
1000-18000	1MHz/3MHz	Auto

#### Uncertainty Measurement

The measurement uncertainty (30MHz-1000MHz) is 4.98 dB (k=2).

The measurement uncertainty (1000MHz-18000MHz) is 5.06 dB (k=2).

### Test Results

Sweep the whole frequency band through the range from 30MHz to the 5<sup>th</sup> harmonic of the carrier, the Emissions in the frequency band 18GHz-40GHz is more than 20dB below the limit are not report.

Mode 1: USB cable (Data Link with PC)

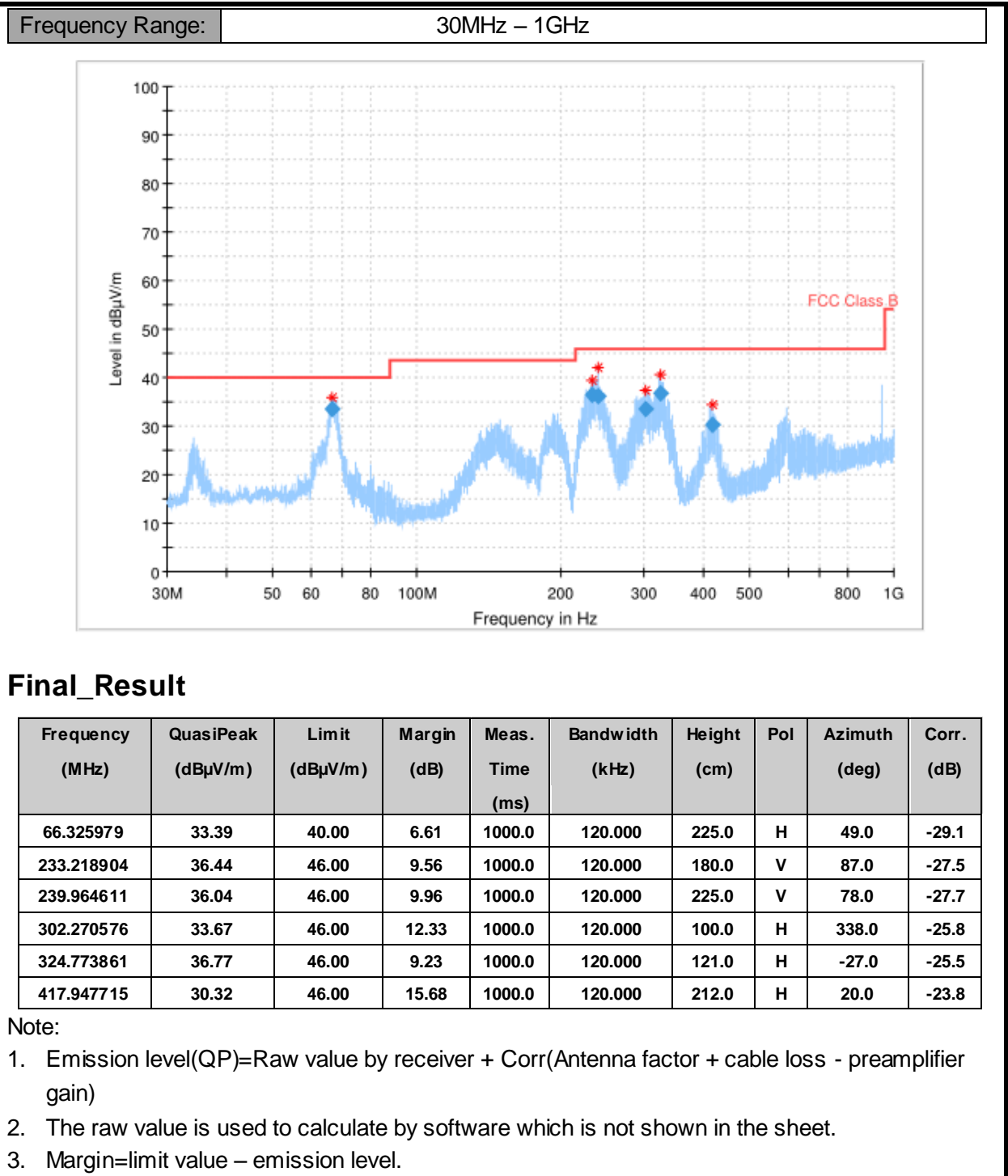

## Mode 2: Adapter charging

Frequency Range:

1GHz –18GHz, Horizontal

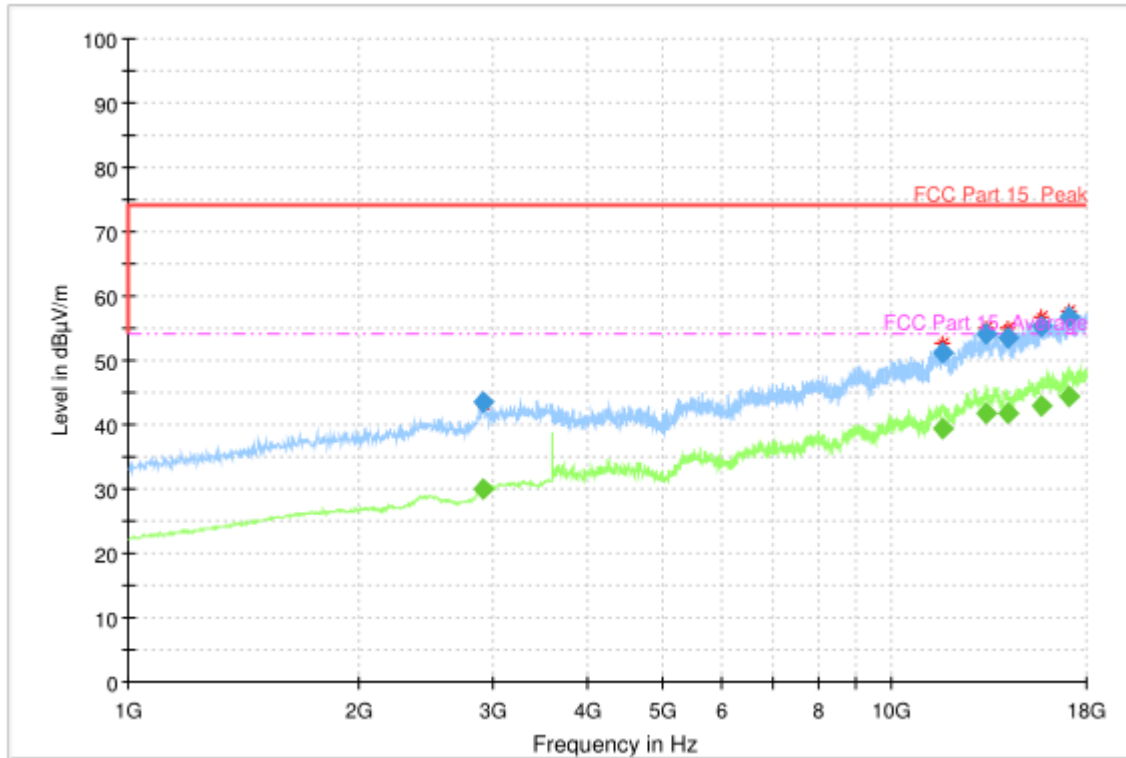
**Final Result**

Frequency (MHz)	MaxPeak (dBuV/m)	Average (dBuV/m)	Limit (dBuV/m)	Margin	Meas. Time	Bandwidth	Height	Po	Azimuth	Corr. (dB)
2921.800000	---	30.05	54.00	23.95	100.0	1000.000	155.0	H	188.0	-1.3
2921.800000	43.39	---	74.00	30.61	100.0	1000.000	155.0	H	188.0	-1.3
11662.200000	---	39.36	54.00	14.64	100.0	1000.000	155.0	H	10.0	15.1
11662.200000	51.15	---	74.00	22.85	100.0	1000.000	155.0	H	10.0	15.1
13300.600000	---	41.73	54.00	12.27	100.0	1000.000	155.0	H	251.0	18.2
13300.600000	54.19	---	74.00	19.81	100.0	1000.000	155.0	H	251.0	18.2
14188.200000	---	41.66	54.00	12.34	100.0	1000.000	155.0	H	116.0	19.2
14188.200000	53.50	---	74.00	20.50	100.0	1000.000	155.0	H	116.0	19.2
15729.600000	55.27	---	74.00	18.73	100.0	1000.000	155.0	H	147.0	21.9
15729.600000	---	43.04	54.00	10.96	100.0	1000.000	155.0	H	147.0	21.9
17024.600000	56.77	---	74.00	17.23	100.0	1000.000	155.0	H	0.0	23.8
17024.600000	---	44.49	54.00	9.51	100.0	1000.000	155.0	H	0.0	23.8

Note:

1. Emission level(peak or average)=Raw value by receiver + Corr(Antenna factor+ cable loss - preamplifier gain)
2. The raw value is used to calculate by software which is not shown in the sheet.
3. Margin=limit value – emission level.



Frequency Range:

1GHz –18GHz, Vertical

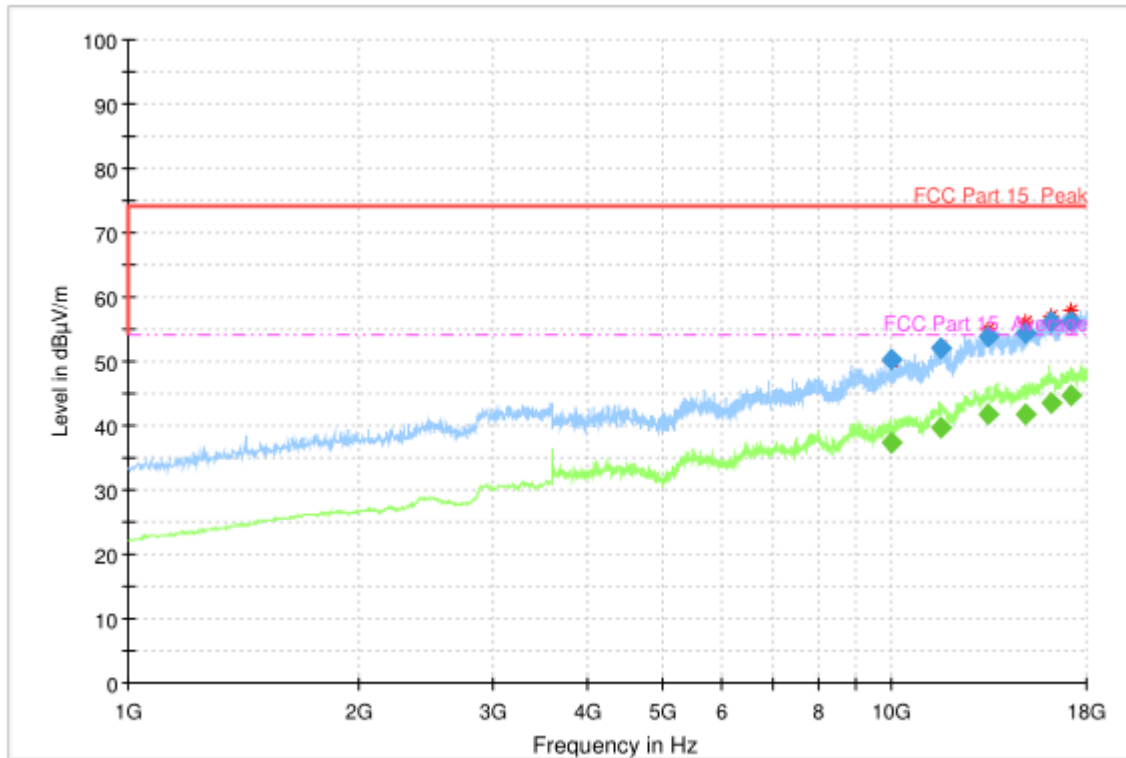

## Final Result

Frequency (MHz)	MaxPeak (dBuV/m)	Average (dBuV/m)	Limit (dBuV/m)	Margin (dB)	Meas. Time	Bandwidth (h)	Height (t)	Po (l)	Azimuth	Corr. (dB)
9990.400000	---	37.47	54.00	16.53	100.0	1000.000	155.0	V	86.0	11.3
9990.400000	50.38	---	74.00	23.62	100.0	1000.000	155.0	V	86.0	11.3
11587.600000	---	39.69	54.00	14.31	100.0	1000.000	155.0	V	315.0	15.2
11587.600000	51.92	---	74.00	22.08	100.0	1000.000	155.0	V	315.0	15.2
13348.000000	---	41.76	54.00	12.24	100.0	1000.000	155.0	V	25.0	18.0
13348.000000	53.97	---	74.00	20.03	100.0	1000.000	155.0	V	25.0	18.0
14942.800000	54.45	---	74.00	19.55	100.0	1000.000	155.0	V	0.0	20.2
14942.800000	---	41.76	54.00	12.24	100.0	1000.000	155.0	V	0.0	20.2
16148.000000	---	43.47	54.00	10.53	100.0	1000.000	155.0	V	6.0	22.4
16148.000000	56.09	---	74.00	17.91	100.0	1000.000	155.0	V	6.0	22.4
17172.800000	56.19	---	74.00	17.81	100.0	1000.000	155.0	V	106.0	24.1
17172.800000	---	44.60	54.00	9.40	100.0	1000.000	155.0	V	106.0	24.1

Note:

1. Emission level(peak or average)=Raw value by receiver + Corr(Antenna factor+ cable loss - preamplifier gain)
2. The raw value is used to calculate by software which is not shown in the sheet.
3. Margin=limit value – emission level.

## 8.2 AC Conducted Emission

### Method of Measurement

For equipment that is designed to be connected to the public utility (AC) power line, the radio frequency voltage that is conducted back onto the AC power line on any frequency or frequencies with the band 150 kHz to 30MHz shall not exceed the limits. Both lines of the power mains connected to the EUT were checked for maximum conducted interference. Tested in accordance with the procedures of ANSI C63.4-2014, section 7.3

### Limit of AC Conducted Emission

Frequency Range (MHz)	Conducted Limit (dBuV)	
	Quasi-peak	Average
0.15-0.5	66 to 56*	56 to 46*
0.5-5	56	46
5-30	60	50

\*Decreases with the logarithm of the frequency

### Test Condition in Charging Mode

Voltage (V)	Frequency (Hz)	RBW	Sweep Time (s)
120	60	9 kHz	Auto

### Uncertainty Measurement

The measurement uncertainty is 3.66dB (k=2).

### Test Results

## Mode 2: Adapter charging

Frequency Range:

150kHz – 30MHz

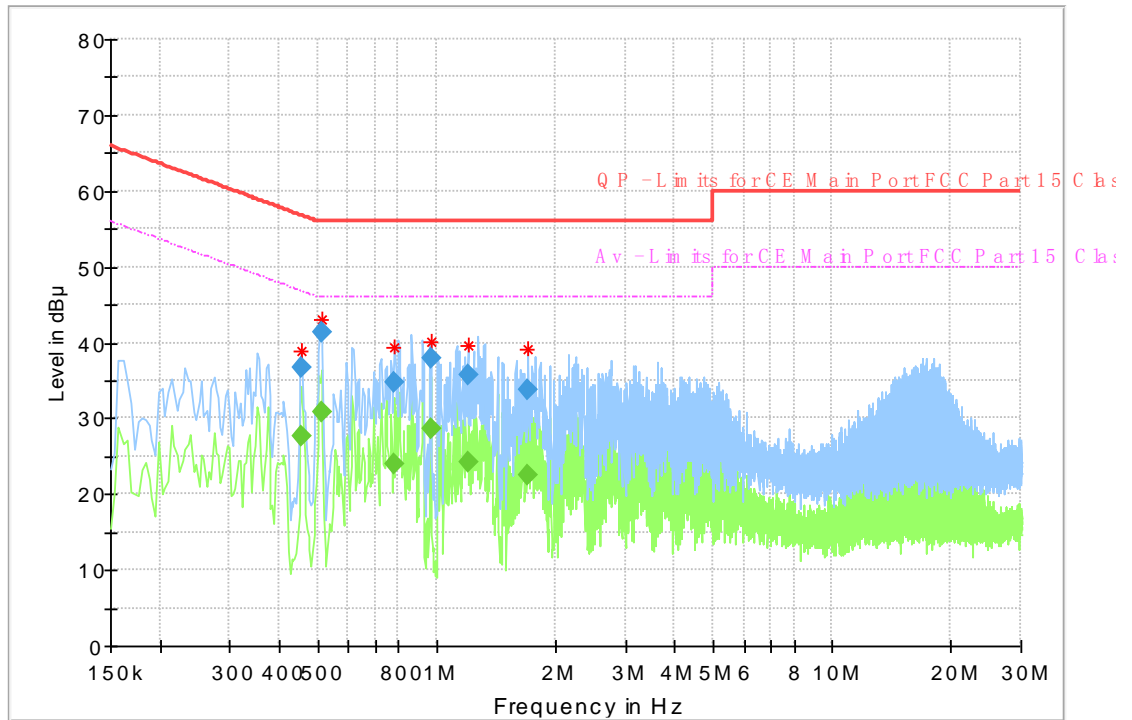

Frequency (MHz)	QuasiPeak (dBµ V)	Average (dBµ V)	Limit (dBµ V)	Margin (dB)	Meas. Time	Bandwidth (kHz)	Line	Filter	Corr. (dB)
0.455963	---	27.53	46.77	19.23	15000.	9.000	L1	ON	9.8
0.455963	36.76	---	56.77	20.00	15000.	9.000	L1	ON	9.8
0.511931	---	30.87	46.00	15.13	15000.	9.000	L1	ON	9.8
0.511931	41.41	---	56.00	14.59	15000.	9.000	L1	ON	9.8
0.780581	---	23.87	46.00	22.13	15000.	9.000	L1	ON	9.8
0.780581	34.69	---	56.00	21.31	15000.	9.000	L1	ON	9.8
0.967144	---	28.68	46.00	17.32	15000.	9.000	L1	ON	9.9
0.967144	37.88	---	56.00	18.12	15000.	9.000	L1	ON	9.9
1.198481	---	24.18	46.00	21.82	15000.	9.000	L1	ON	9.9
1.198481	35.74	---	56.00	20.26	15000.	9.000	L1	ON	9.9
1.702200	---	22.52	46.00	23.48	15000.	9.000	L1	ON	9.9
1.702200	33.73	---	56.00	22.27	15000.	9.000	L1	ON	9.9

## Note:

1. Emission level(quasi-peak or Average peak)=Raw value by receiver + Corr(Insertion loss+ cable loss)
2. The raw value is used to calculate by software which is not shown in the sheet.
3. Margin=limit value – emission level.
4. L1 and N line is all have been tested, the result of them is synthesized in the above data diagram.

\*\*\*\*\*END OF REPORT\*\*\*\*\*