

FCC SAR Test Report

APPLICANT : MobiWire SAS
EQUIPMENT : 4G Smart Phone
BRAND NAME : MobiWire
MODEL NAME : MobiWire Nuna Lite
FCC ID : QPN-NUNA-LITE
STANDARD : FCC 47 CFR Part 2 (2.1093)
ANSI/IEEE C95.1-1992
IEEE 1528-2013

The product was received on Mar. 09, 2020 and testing was started from Apr. 01, 2020 and completed on Jul. 12, 2020. We, Sporton International (Kunshan) Inc, would like to declare that the tested sample has been evaluated in accordance with the procedures and had been in compliance with the applicable technical standards.

The test results in this report apply exclusively to the tested model / sample. Without written approval of Sporton International (Kunshan) Inc., the test report shall not be reproduced except in full.

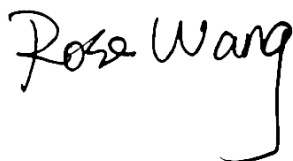

Reviewed by: Rose Wang / Supervisor



Approved by: Kat Yin / Manager



Sporton International (Kunshan) Inc.
No. 1098, Pengxi North Road, Kunshan Economic Development Zone Jiangsu Province 215300
People's Republic of China



Table of Contents

1. Statement of Compliance 4
2. Administration Data 5
3. Guidance Applied 5
4. Equipment Under Test (EUT) Information 6
4.1 General Information 6
4.2 General LTE SAR Test and Reporting Considerations 7
5. RF Exposure Limits 8
5.1 Uncontrolled Environment 8
5.2 Controlled Environment 8
6. Specific Absorption Rate (SAR) 9
6.1 Introduction 9
6.2 SAR Definition 9
7. System Description and Setup 10
7.1 E-Field Probe 11
7.2 Data Acquisition Electronics (DAE) 11
7.3 Phantom 12
7.4 Device Holder 13
8. Measurement Procedures 14
8.1 Spatial Peak SAR Evaluation 14
8.2 Power Reference Measurement 15
8.3 Area Scan 15
8.4 Zoom Scan 16
8.5 Volume Scan Procedures 16
8.6 Power Drift Monitoring 16
9. Test Equipment List 17
10. System Verification 18
10.1 Tissue Simulating Liquids 18
10.2 Tissue Verification 19
10.3 System Performance Check Results 20
11. RF Exposure Positions 21
11.1 Ear and handset reference point 21
11.2 Definition of the cheek position 22
11.3 Definition of the tilt position 23
11.4 Body Worn Accessory 24
11.5 Product Specific 10g SAR Exposure 25
11.6 Wireless Router 25
12. Conducted RF Output Power (Unit: dBm) 26
13. Antenna Location 34
14. SAR Test Results 35
14.1 Head SAR 37
14.2 Hotspot SAR 39
14.3 Body Worn Accessory SAR 42
14.4 Repeated SAR Measurement 44
15. Simultaneous Transmission Analysis 45
15.1 Head Exposure Conditions 46
15.2 Hotspot Exposure Conditions 47
15.3 Body-Worn Accessory Exposure Conditions 48
16. Uncertainty Assessment 49
17. References 50

- Appendix A. Plots of System Performance Check
Appendix B. Plots of High SAR Measurement
Appendix C. DASy Calibration Certificate
Appendix D. Test Setup Photos
Appendix E. Conducted RF Output Power Table



Revision History

REPORT NO.	VERSION	DESCRIPTION	ISSUED DATE
FA030903	Rev. 01	Initial issue of report	Jul. 13, 2020

1. Statement of Compliance

The maximum results of Specific Absorption Rate (SAR) found during testing for **MobiWire SAS, 4G Smart Phone, MobiWire Nuna Lite**, are as follows.

Highest 1g SAR Summary						
Equipment Class	Frequency Band		Head (Separation 0mm)	Hotspot (Separation 10mm)	Body-worn (Separation 10mm)	Highest Simultaneous Transmission 1g SAR (W/kg)
			1g SAR (W/kg)			
Licensed	GSM	GSM850	0.43	0.77	0.77	1.55
		GSM1900	0.26	0.83	0.83	
	WCDMA	Band II	0.34	0.88	0.88	
		Band V	0.23	0.46	0.46	
	LTE	Band 7	<0.10	1.09	1.09	
DTS	WLAN	2.4GHz WLAN	0.23	0.46	0.46	1.55
NII		5GHz WLAN	0.41	<0.10	0.14	1.23
DSS	Bluetooth	2.4GHz Bluetooth	<0.10	<0.10	<0.10	1.14
Date of Testing:			2020/4/1~2020/7/12			

Declaration of Conformity:

The test results with all measurement uncertainty excluded are presented in accordance with the regulation limits or requirements declared by manufacturers.

Comments and Explanations:

The declared of product specification for EUT presented in the report are provided by the manufacturer, and the manufacturer takes all the responsibilities for the accuracy of product specification.

This device is in compliance with Specific Absorption Rate (SAR) for general population/uncontrolled exposure limits (1.6 W/kg for Partial-Body 1g SAR) specified in FCC 47 CFR part 2 (2.1093) and ANSI/IEEE C95.1-1992, and had been tested in accordance with the measurement methods and procedures specified in IEEE 1528-2013 and FCC KDB publications.



2. Administration Data

Sporton International (Kunshan) Inc. is accredited to ISO/IEC 17025:2017 by American Association for Laboratory Accreditation with Certificate Number 5145.02.

Testing Laboratory		
Test Firm	Sporton International (Kunshan) Inc.	
Test Site Location	No. 1098, Pengxi North Road, Kunshan Economic Development Zone Jiangsu Province 215300 People's Republic of China TEL : +86-512-57900158 FAX : +86-512-57900958	
Test Site No.	FCC Designation No.	FCC Test Firm Registration No.
	CN1257	314309

Applicant	
Company Name	MobiWire SAS
Address	79 AVENUE FRANCOIS ARAGO 92017 NANTERRE CEDEX France

Manufacturer	
Company Name	MobiWire SAS
Address	79 AVENUE FRANCOIS ARAGO 92017 NANTERRE CEDEX France

3. Guidance Applied

The Specific Absorption Rate (SAR) testing specification, method, and procedure for this device is in accordance with the following standards:

- FCC 47 CFR Part 2 (2.1093)
- ANSI/IEEE C95.1-1992
- IEEE 1528-2013
- FCC KDB 865664 D01 SAR Measurement 100 MHz to 6 GHz v01r04
- FCC KDB 865664 D02 SAR Reporting v01r02
- FCC KDB 447498 D01 General RF Exposure Guidance v06
- FCC KDB 648474 D04 SAR Evaluation Considerations for Wireless Handsets v01r03
- FCC KDB 248227 D01 802.11 Wi-Fi SAR v02r02
- FCC KDB 941225 D01 3G SAR Procedures v03r01
- FCC KDB 941225 D05 SAR for LTE Devices v02r05
- FCC KDB 941225 D06 Hotspot Mode SAR v02r01

4. Equipment Under Test (EUT) Information

4.1 General Information

Product Feature & Specification	
Equipment Name	4G Smart Phone
Brand Name	MobiWire
Model Name	MobiWire Nuna Lite
FCC ID	QPN-NUNA-LITE
IMEI Code	354164110001084
Wireless Technology and Frequency Range	GSM850: 824.2 MHz ~ 848.8 MHz GSM1900: 1850.2 MHz ~ 1909.8 MHz WCDMA Band II: 1852.4 MHz ~ 1907.6 MHz WCDMA Band V: 826.4 MHz ~ 846.6 MHz LTE Band 7: 2502.5 MHz ~ 2567.5 MHz WLAN 2.4GHz Band: 2412 MHz ~ 2462 MHz WLAN 5.2GHz Band: 5180 MHz ~ 5240 MHz WLAN 5.3GHz Band: 5260 MHz ~ 5320 MHz WLAN 5.5GHz Band: 5500 MHz ~ 5700 MHz WLAN 5.8GHz Band: 5745 MHz ~ 5825 MHz Bluetooth: 2402 MHz ~ 2480 MHz
Mode	GSM/GPRS/EGPRS RMC/AMR 12.2Kbps HSDPA HSUPA DC-HSDPA HSPA+ LTE: QPSK, 16QAM, 64QAM WLAN 2.4GHz 802.11b/g/n HT20/HT40 WLAN 5GHz 802.11a/n HT20/HT40 Bluetooth BR/EDR/LE
GSM / (E)GPRS Transfer mode	Class B – EUT cannot support Packet Switched and Circuit Switched Network simultaneously but can automatically switch between Packet and Circuit Switched Network.
EUT Stage	Identical Prototype
Remark:	
<ol style="list-style-type: none"> 1. This device supports VoIP in GPRS, EGPRS, WCDMA and LTE (e.g. for 3rd-party VoIP), LTE supports VoLTE operation. 2. This device 2.4GHz WLAN support hotspot operation and Bluetooth support tethering applications. 3. This device 2.4GHz WLAN/5.2GHz WLAN/5.8GHz WLAN support hotspot operation, and 5.2GHz WLAN/5.8GHz WLAN supports WiFi Direct (GC/GO), and 5.3GHz / 5.5GHz supports WiFi Direct (GC only). 4. This device does not support DTM operation and supports GRPS/EGRPS mode up to multi-slot class 12. 	

4.2 General LTE SAR Test and Reporting Considerations

Summarized necessary items addressed in KDB 941225 D05 v02r05																																																															
FCC ID	QPN-NUNA-LITE																																																														
Equipment Name	4G Smart Phone																																																														
Operating Frequency Range of each LTE transmission band	LTE Band 7: 2502.5 MHz ~ 2567.5 MHz																																																														
Channel Bandwidth	LTE Band 7: 5MHz, 10MHz, 15MHz, 20MHz																																																														
uplink modulations used	QPSK / 16QAM / 64QAM																																																														
LTE Voice / Data requirements	Voice and Data																																																														
LTE Release Version	R9;Cat4																																																														
CA Support	Not supported																																																														
LTE MPR permanently built-in by design	<p align="center">Table 6.2.3-1: Maximum Power Reduction (MPR) for Power Class 1, 2 and 3</p> <table border="1"> <thead> <tr> <th rowspan="2">Modulation</th> <th colspan="6">Channel bandwidth / Transmission bandwidth (N_{RB})</th> <th rowspan="2">MPR (dB)</th> </tr> <tr> <th>1.4 MHz</th> <th>3.0 MHz</th> <th>5 MHz</th> <th>10 MHz</th> <th>15 MHz</th> <th>20 MHz</th> </tr> </thead> <tbody> <tr> <td>QPSK</td> <td>> 5</td> <td>> 4</td> <td>> 8</td> <td>> 12</td> <td>> 16</td> <td>> 18</td> <td>≤ 1</td> </tr> <tr> <td>16 QAM</td> <td>≤ 5</td> <td>≤ 4</td> <td>≤ 8</td> <td>≤ 12</td> <td>≤ 16</td> <td>≤ 18</td> <td>≤ 1</td> </tr> <tr> <td>16 QAM</td> <td>> 5</td> <td>> 4</td> <td>> 8</td> <td>> 12</td> <td>> 16</td> <td>> 18</td> <td>≤ 2</td> </tr> <tr> <td>64 QAM</td> <td>≤ 5</td> <td>≤ 4</td> <td>≤ 8</td> <td>≤ 12</td> <td>≤ 16</td> <td>≤ 18</td> <td>≤ 2</td> </tr> <tr> <td>64 QAM</td> <td>> 5</td> <td>> 4</td> <td>> 8</td> <td>> 12</td> <td>> 16</td> <td>> 18</td> <td>≤ 3</td> </tr> <tr> <td>256 QAM</td> <td colspan="6">≥ 1</td> <td>≤ 5</td> </tr> </tbody> </table>	Modulation	Channel bandwidth / Transmission bandwidth (N _{RB})						MPR (dB)	1.4 MHz	3.0 MHz	5 MHz	10 MHz	15 MHz	20 MHz	QPSK	> 5	> 4	> 8	> 12	> 16	> 18	≤ 1	16 QAM	≤ 5	≤ 4	≤ 8	≤ 12	≤ 16	≤ 18	≤ 1	16 QAM	> 5	> 4	> 8	> 12	> 16	> 18	≤ 2	64 QAM	≤ 5	≤ 4	≤ 8	≤ 12	≤ 16	≤ 18	≤ 2	64 QAM	> 5	> 4	> 8	> 12	> 16	> 18	≤ 3	256 QAM	≥ 1						≤ 5
	Modulation		Channel bandwidth / Transmission bandwidth (N _{RB})							MPR (dB)																																																					
		1.4 MHz	3.0 MHz	5 MHz	10 MHz	15 MHz	20 MHz																																																								
	QPSK	> 5	> 4	> 8	> 12	> 16	> 18	≤ 1																																																							
	16 QAM	≤ 5	≤ 4	≤ 8	≤ 12	≤ 16	≤ 18	≤ 1																																																							
	16 QAM	> 5	> 4	> 8	> 12	> 16	> 18	≤ 2																																																							
	64 QAM	≤ 5	≤ 4	≤ 8	≤ 12	≤ 16	≤ 18	≤ 2																																																							
64 QAM	> 5	> 4	> 8	> 12	> 16	> 18	≤ 3																																																								
256 QAM	≥ 1						≤ 5																																																								
LTE A-MPR	In the base station simulator configuration, Network Setting value is set to NS_01 to disable A-MPR during SAR testing and the LTE SAR tests was transmitting on all TTI frames (Maximum TTI)																																																														
Spectrum plots for RB configuration	A properly configured base station simulator was used for the SAR and power measurement; therefore, spectrum plots for each RB allocation and offset configuration are not included in the SAR report.																																																														

Transmission (H, M, L) channel numbers and frequencies in each LTE band								
LTE Band 7								
	Bandwidth 5 MHz		Bandwidth 10 MHz		Bandwidth 15 MHz		Bandwidth 20 MHz	
	Ch. #	Freq. (MHz)	Ch. #	Freq. (MHz)	Ch. #	Freq. (MHz)	Ch. #	Freq. (MHz)
L	20775	2502.5	20800	2505	20825	2507.5	20850	2510
M	21100	2535	21100	2535	21100	2535	21100	2535
H	21425	2567.5	21400	2565	21375	2562.5	21350	2560

5. RF Exposure Limits

5.1 Uncontrolled Environment

Uncontrolled Environments are defined as locations where there is the exposure of individuals who have no knowledge or control of their exposure. The general population/uncontrolled exposure limits are applicable to situations in which the general public may be exposed or in which persons who are exposed as a consequence of their employment may not be made fully aware of the potential for exposure or cannot exercise control over their exposure. Members of the general public would come under this category when exposure is not employment-related; for example, in the case of a wireless transmitter that exposes persons in its vicinity.

5.2 Controlled Environment

Controlled Environments are defined as locations where there is exposure that may be incurred by persons who are aware of the potential for exposure, (i.e. as a result of employment or occupation). In general, occupational/controlled exposure limits are applicable to situations in which persons are exposed as a consequence of their employment, who have been made fully aware of the potential for exposure and can exercise control over their exposure. The exposure category is also applicable when the exposure is of a transient nature due to incidental passage through a location where the exposure levels may be higher than the general population/uncontrolled limits, but the exposed person is fully aware of the potential for exposure and can exercise control over his or her exposure by leaving the area or by some other appropriate means.

Limits for Occupational/Controlled Exposure (W/kg)

Whole-Body	Partial-Body	Hands, Wrists, Feet and Ankles
0.4	8.0	20.0

Limits for General Population/Uncontrolled Exposure (W/kg)

Whole-Body	Partial-Body	Hands, Wrists, Feet and Ankles
0.08	1.6	4.0

Whole-Body SAR is averaged over the entire body, partial-body SAR is averaged over any 1gram of tissue defined as a tissue volume in the shape of a cube. SAR for hands, wrists, feet and ankles is averaged over any 10 grams of tissue defined as a tissue volume in the shape of a cube.

6. Specific Absorption Rate (SAR)

6.1 Introduction

SAR is related to the rate at which energy is absorbed per unit mass in an object exposed to a radio field. The SAR distribution in a biological body is complicated and is usually carried out by experimental techniques or numerical modeling. The standard recommends limits for two tiers of groups, occupational/controlled and general population/uncontrolled, based on a person's awareness and ability to exercise control over his or her exposure. In general, occupational/controlled exposure limits are higher than the limits for general population/uncontrolled.

6.2 SAR Definition

The SAR definition is the time derivative (rate) of the incremental energy (dW) absorbed by (dissipated in) an incremental mass (dm) contained in a volume element (dv) of a given density (ρ). The equation description is as below:

$$\text{SAR} = \frac{d}{dt} \left(\frac{dW}{dm} \right) = \frac{d}{dt} \left(\frac{dW}{\rho dv} \right)$$

SAR is expressed in units of Watts per kilogram (W/kg)

$$\text{SAR} = \frac{\sigma |E|^2}{\rho}$$

Where: σ is the conductivity of the tissue, ρ is the mass density of the tissue and E is the RMS electrical field strength.

7. System Description and Setup

The DASY system used for performing compliance tests consists of the following items:

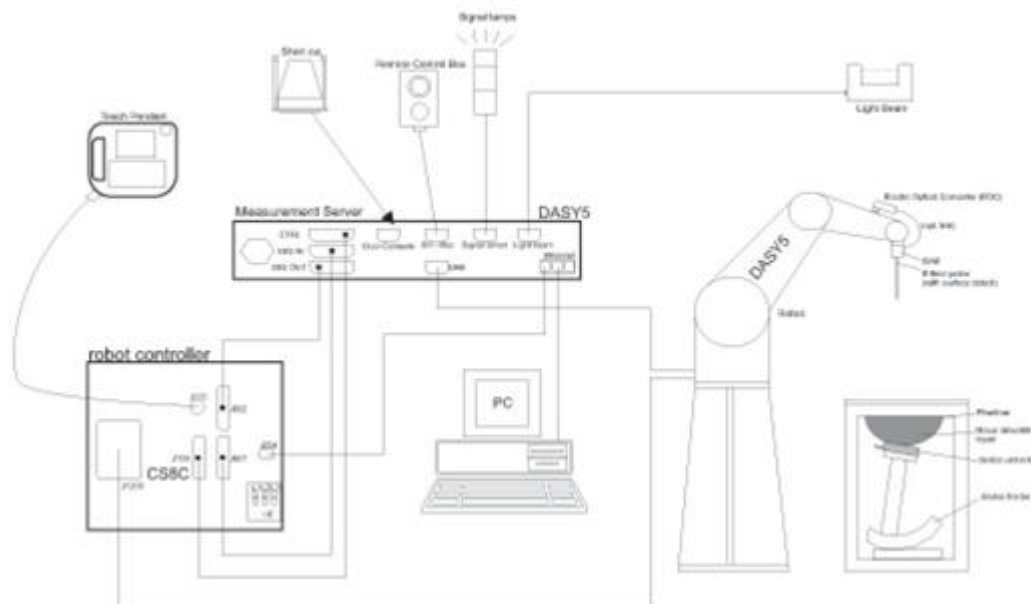

- A standard high precision 6-axis robot with controller, teach pendant and software. An arm extension for accommodating the data acquisition electronics (DAE).
- An isotropic Field probe optimized and calibrated for the targeted measurement.
- A data acquisition electronics (DAE) which performs the signal amplification, signal multiplexing, AD-conversion, offset measurements, mechanical surface detection, collision detection, etc. The unit is battery powered with standard or rechargeable batteries. The signal is optically transmitted to the EOC.
- The Electro-optical converter (EOC) performs the conversion from optical to electrical signals for the digital communication to the DAE. To use optical surface detection, a special version of the EOC is required. The EOC signal is transmitted to the measurement server.
- The function of the measurement server is to perform the time critical tasks such as signal filtering, control of the robot operation and fast movement interrupts.
- The Light Beam used is for probe alignment. This improves the (absolute) accuracy of the probe positioning.
- A computer running WinXP or Win7 and the DASY5 software.
- Remote control and teach pendant as well as additional circuitry for robot safety such as warning lamps, etc.
- The phantom, the device holder and other accessories according to the targeted measurement.

7.1 E-Field Probe

The SAR measurement is conducted with the dosimetric probe (manufactured by SPEAG).The probe is specially designed and calibrated for use in liquid with high permittivity. The dosimetric probe has special calibration in liquid at different frequency. This probe has a built in optical surface detection system to prevent from collision with phantom.

<EX3DV4 Probe>

Construction	Symmetric design with triangular core Built-in shielding against static charges PEEK enclosure material (resistant to organic solvents, e.g., DGBE)	
Frequency	10 MHz – >6 GHz Linearity: ±0.2 dB (30 MHz – 6 GHz)	
Directivity	±0.3 dB in TSL (rotation around probe axis) ±0.5 dB in TSL (rotation normal to probe axis)	
Dynamic Range	10 µW/g – >100 mW/g Linearity: ±0.2 dB (noise: typically <1 µW/g)	
Dimensions	Overall length: 337 mm (tip: 20 mm) Tip diameter: 2.5 mm (body: 12 mm) Typical distance from probe tip to dipole centers: 1 mm	

7.2 Data Acquisition Electronics (DAE)

The data acquisition electronics (DAE) consists of a highly sensitive electrometer-grade preamplifier with auto-zeroing, a channel and gain-switching multiplexer, a fast 16 bit AD-converter and a command decoder and control logic unit. Transmission to the measurement server is accomplished through an optical downlink for data and status information as well as an optical uplink for commands and the clock.

The input impedance of the DAE is 200 MOhm; the inputs are symmetrical and floating. Common mode rejection is above 80 dB.



Photo of DAE

7.3 Phantom

<SAM Twin Phantom>

Shell Thickness	2 ± 0.2 mm; Center ear point: 6 ± 0.2 mm	
Filling Volume	Approx. 25 liters	
Dimensions	Length: 1000 mm; Width: 500 mm; Height: adjustable feet	
Measurement Areas	Left Hand, Right Hand, Flat Phantom	

The bottom plate contains three pair of bolts for locking the device holder. The device holder positions are adjusted to the standard measurement positions in the three sections. A white cover is provided to tap the phantom during off-periods to prevent water evaporation and changes in the liquid parameters. On the phantom top, three reference markers are provided to identify the phantom position with respect to the robot.

<ELI Phantom>

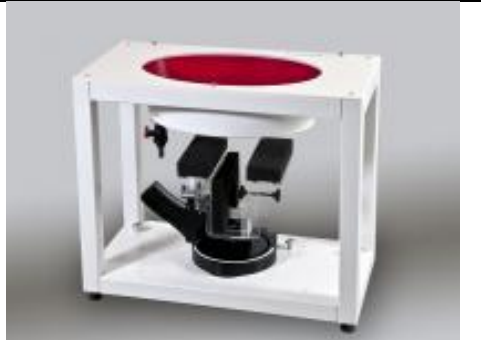
Shell Thickness	2 ± 0.2 mm (sagging: <1%)	
Filling Volume	Approx. 30 liters	
Dimensions	Major ellipse axis: 600 mm Minor axis: 400 mm	

The ELI phantom is intended for compliance testing of handheld and body-mounted wireless devices in the frequency range of 30 MHz to 6 GHz. ELI4 is fully compatible with standard and all known tissue simulating liquids.

7.4 Device Holder

<Mounting Device for Hand-Held Transmitter>

In combination with the Twin SAM V5.0/V5.0c or ELI phantoms, the Mounting Device for Hand-Held Transmitters enables rotation of the mounted transmitter device to specified spherical coordinates. At the heads, the rotation axis is at the ear opening. Transmitter devices can be easily and accurately positioned according to IEC 62209-1, IEEE 1528, FCC, or other specifications. The device holder can be locked for positioning at different phantom sections (left head, right head, flat). And upgrade kit to Mounting Device to enable easy mounting of wider devices like big smart-phones, e-books, small tablets, etc. It holds devices with width up to 140 mm.



Mounting Device for Hand-Held Transmitters



Mounting Device Adaptor for Wide-Phones

<Mounting Device for Laptops and other Body-Worn Transmitters>

The extension is lightweight and made of POM, acrylic glass and foam. It fits easily on the upper part of the mounting device in place of the phone positioned. The extension is fully compatible with the SAM Twin and ELI phantoms.



Mounting Device for Laptops

8. Measurement Procedures

The measurement procedures are as follows:

<Conducted power measurement>

- (a) For WWAN power measurement, use base station simulator to configure EUT WWAN transmission in conducted connection with RF cable, at maximum power in each supported wireless interface and frequency band.
- (b) Read the WWAN RF power level from the base station simulator.
- (c) For WLAN/BT power measurement, use engineering software to configure EUT WLAN/BT continuously transmission, at maximum RF power in each supported wireless interface and frequency band
- (d) Connect EUT RF port through RF cable to the power meter, and measure WLAN/BT output power

<SAR measurement>

- (a) Use base station simulator to configure EUT WWAN transmission in radiated connection, and engineering software to configure EUT WLAN/BT continuously transmission, at maximum RF power, in the highest power channel.
- (b) Place the EUT in the positions as Appendix D demonstrates.
- (c) Set scan area, grid size and other setting on the DASY software.
- (d) Measure SAR results for the highest power channel on each testing position.
- (e) Find out the largest SAR result on these testing positions of each band
- (f) Measure SAR results for other channels in worst SAR testing position if the reported SAR of highest power channel is larger than 0.8 W/kg

According to the test standard, the recommended procedure for assessing the peak spatial-average SAR value consists of the following steps:

- (a) Power reference measurement
- (b) Area scan
- (c) Zoom scan
- (d) Power drift measurement

8.1 Spatial Peak SAR Evaluation

The procedure for spatial peak SAR evaluation has been implemented according to the test standard. It can be conducted for 1g and 10g, as well as for user-specific masses. The DASY software includes all numerical procedures necessary to evaluate the spatial peak SAR value.

The base for the evaluation is a "cube" measurement. The measured volume must include the 1g and 10g cubes with the highest averaged SAR values. For that purpose, the center of the measured volume is aligned to the interpolated peak SAR value of a previously performed area scan.

The entire evaluation of the spatial peak values is performed within the post-processing engine (SEMCAD). The system always gives the maximum values for the 1g and 10g cubes. The algorithm to find the cube with highest averaged SAR is divided into the following stages:

- (a) Extraction of the measured data (grid and values) from the Zoom Scan
- (b) Calculation of the SAR value at every measurement point based on all stored data (A/D values and measurement parameters)
- (c) Generation of a high-resolution mesh within the measured volume
- (d) Interpolation of all measured values from the measurement grid to the high-resolution grid
- (e) Extrapolation of the entire 3-D field distribution to the phantom surface over the distance from sensor to surface
- (f) Calculation of the averaged SAR within masses of 1g and 10g

8.2 Power Reference Measurement

The Power Reference Measurement and Power Drift Measurements are for monitoring the power drift of the device under test in the batch process. The minimum distance of probe sensors to surface determines the closest measurement point to phantom surface. This distance cannot be smaller than the distance of sensor calibration points to probe tip as defined in the probe properties.

8.3 Area Scan

The area scan is used as a fast scan in two dimensions to find the area of high field values, before doing a fine measurement around the hot spot. The sophisticated interpolation routines implemented in DASY software can find the maximum found in the scanned area, within a range of the global maximum. The range (in dB0 is specified in the standards for compliance testing. For example, a 2 dB range is required in IEEE standard 1528 and IEC 62209 standards, whereby 3 dB is a requirement when compliance is assessed in accordance with the ARIB standard (Japan), if only one zoom scan follows the area scan, then only the absolute maximum will be taken as reference. For cases where multiple maximums are detected, the number of zoom scans has to be increased accordingly.

Area scan parameters extracted from FCC KDB 865664 D01v01r04 SAR measurement 100 MHz to 6 GHz.

	≤ 3 GHz	> 3 GHz
Maximum distance from closest measurement point (geometric center of probe sensors) to phantom surface	5 ± 1 mm	$\frac{1}{2} \cdot \delta \cdot \ln(2) \pm 0.5$ mm
Maximum probe angle from probe axis to phantom surface normal at the measurement location	$30^\circ \pm 1^\circ$	$20^\circ \pm 1^\circ$
Maximum area scan spatial resolution: $\Delta x_{Area}, \Delta y_{Area}$	≤ 2 GHz: ≤ 15 mm 2 – 3 GHz: ≤ 12 mm	3 – 4 GHz: ≤ 12 mm 4 – 6 GHz: ≤ 10 mm
	When the x or y dimension of the test device, in the measurement plane orientation, is smaller than the above, the measurement resolution must be \leq the corresponding x or y dimension of the test device with at least one measurement point on the test device.	

8.4 Zoom Scan

Zoom scans are used to assess the peak spatial SAR values within a cubic averaging volume containing 1 gram and 10 gram of simulated tissue. The zoom scan measures points (refer to table below) within a cube whose base faces are centered on the maxima found in a preceding area scan job within the same procedure. When the measurement is done, the zoom scan evaluates the averaged SAR for 1 gram and 10 gram and displays these values next to the job's label.

Zoom scan parameters extracted from FCC KDB 865664 D01v01r04 SAR measurement 100 MHz to 6 GHz.

		≤ 3 GHz	> 3 GHz	
Maximum zoom scan spatial resolution: Δx_{Zoom} , Δy_{Zoom}		≤ 2 GHz: ≤ 8 mm 2 – 3 GHz: ≤ 5 mm*	3 – 4 GHz: ≤ 5 mm* 4 – 6 GHz: ≤ 4 mm*	
Maximum zoom scan spatial resolution, normal to phantom surface	uniform grid: $\Delta z_{Zoom}(n)$	≤ 5 mm	3 – 4 GHz: ≤ 4 mm 4 – 5 GHz: ≤ 3 mm 5 – 6 GHz: ≤ 2 mm	
	graded grid	$\Delta z_{Zoom}(1)$: between 1 st two points closest to phantom surface	≤ 4 mm	3 – 4 GHz: ≤ 3 mm 4 – 5 GHz: ≤ 2.5 mm 5 – 6 GHz: ≤ 2 mm
		$\Delta z_{Zoom}(n>1)$: between subsequent points	$\leq 1.5 \cdot \Delta z_{Zoom}(n-1)$	
Minimum zoom scan volume	x, y, z	≥ 30 mm	3 – 4 GHz: ≥ 28 mm 4 – 5 GHz: ≥ 25 mm 5 – 6 GHz: ≥ 22 mm	
Note: δ is the penetration depth of a plane-wave at normal incidence to the tissue medium; see draft standard IEEE P1528-2011 for details. * When zoom scan is required and the <i>reported</i> SAR from the <i>area scan based 1-g SAR estimation</i> procedures of KDB 447498 is ≤ 1.4 W/kg, ≤ 8 mm, ≤ 7 mm and ≤ 5 mm zoom scan resolution may be applied, respectively, for 2 GHz to 3 GHz, 3 GHz to 4 GHz and 4 GHz to 6 GHz.				

8.5 Volume Scan Procedures

The volume scan is used to assess overlapping SAR distributions for antennas transmitting in different frequency bands. It is equivalent to an oversized zoom scan used in standalone measurements. The measurement volume will be used to enclose all the simultaneous transmitting antennas. For antennas transmitting simultaneously in different frequency bands, the volume scan is measured separately in each frequency band. In order to sum correctly to compute the 1g aggregate SAR, the EUT remain in the same test position for all measurements and all volume scan use the same spatial resolution and grid spacing. When all volume scan were completed, the software, SEMCAD postprocessor can combine and subsequently superpose these measurement data to calculating the multiband SAR.

8.6 Power Drift Monitoring

All SAR testing is under the EUT install full charged battery and transmit maximum output power. In DASYS measurement software, the power reference measurement and power drift measurement procedures are used for monitoring the power drift of EUT during SAR test. Both these procedures measure the field at a specified reference position before and after the SAR testing. The software will calculate the field difference in dB. If the power drifts more than 5%, the SAR will be retested.



9. Test Equipment List

Manufacturer	Name of Equipment	Type/Model	Serial Number	Calibration	
				Last Cal.	Due Date
SPEAG	835MHz System Validation Kit	D835V2	4d151	2019/3/27	2021/3/26
SPEAG	1900MHz System Validation Kit	D1900V2	5d170	2019/3/26	2021/3/25
SPEAG	2450MHz System Validation Kit	D2450V2	908	2019/3/25	2021/3/24
SPEAG	2600MHz System Validation Kit	D2600V2	1061	2018/12/7	2021/12/6
SPEAG	5000MHz System Validation Kit	D5GHzV2	1113	2019/9/24	2020/9/23
SPEAG	Data Acquisition Electronics	DAE4	1358	2019/4/17	2020/4/16
SPEAG	Data Acquisition Electronics	DAE4	799	2020/2/10	2021/2/9
SPEAG	Dosimetric E-Field Probe	EX3DV4	3843	2019/9/26	2020/9/25
SPEAG	Dosimetric E-Field Probe	EX3DV4	7592	2020/5/22	2021/5/21
SPEAG	SAM Twin Phantom	QD 000 P40 CB	TP-1697	NCR	NCR
SPEAG	SAM Twin Phantom	QD 000 P40 CB	TP-1503	NCR	NCR
SPEAG	SAM Twin Phantom	QD 000 P40 CB	TP-1753	NCR	NCR
SPEAG	Phone Positioner	N/A	N/A	NCR	NCR
Anritsu	Radio Communication Analyzer	MT8821C	6201432831	2019/4/17	2020/4/16
Agilent	Wireless Communication Test Set	E5515C	MY52102706	2019/4/17	2020/4/16
Agilent	ENA Series Network Analyzer	E5071C	MY46111157	2019/4/17	2020/4/16
Anritsu	Radio Communication Analyzer	MT8821C	6201432831	2020/4/16	2021/4/15
Agilent	Wireless Communication Test Set	E5515C	MY52102706	2020/4/16	2021/4/15
Agilent	ENA Series Network Analyzer	E5071C	MY46111157	2020/4/16	2021/4/15
SPEAG	Dielectric Probe Kit	DAK-3.5	1138	2019/10/28	2020/10/27
Anritsu	Vector Signal Generator	MG3710A	6201682672	2020/1/8	2021/1/7
Rohde & Schwarz	Power Meter	NRVD	102081	2019/8/15	2020/8/14
Rohde & Schwarz	Power Sensor	NRV-Z5	100538	2019/8/14	2020/8/13
Rohde & Schwarz	Power Sensor	NRV-Z5	100539	2019/8/14	2020/8/13
R&S	CBT BLUETOOTH TESTER	CBT	101641	2020/1/8	2021/1/7
EXA	Spectrum Analyzer	FSV7	101631	2020/1/8	2021/1/7
Testo	Hygrometer	608-H1	1241332088	2020/1/8	2021/1/7
FLUKE	DIGITAC THERMOMETER	51II	97240029	2019/8/15	2020/8/14
BONN	POWER AMPLIFIER	BLMA 0830-3	087193A	Note 1	
BONN	POWER AMPLIFIER	BLMA 2060-2	087193B	Note 1	
ARRA	Power Divider	A3200-2	N/A	Note 1	
MCL	Attenuation1	BW-S10W5+	N/A	Note 1	
MCL	Attenuation2	BW-S10W5+	N/A	Note 1	
MCL	Attenuation3	BW-S10W5+	N/A	Note 1	
Agilent	Dual Directional Coupler	778D	20500	Note 1	
Agilent	Dual Directional Coupler	11691D	MY48151020	Note 1	

Note:

1. Prior to system verification and validation, the path loss from the signal generator to the system check source and the power meter, which includes the amplifier, cable, attenuator and directional coupler, was measured by the network analyzer. The reading of the power meter was offset by the path loss difference between the path to the power meter and the path to the system check source to monitor the actual power level fed to the system check
2. Referring to KDB 865664 D01v01r04, the dipole calibration interval can be extended to 3 years with justification. The dipoles are also not physically damaged, or repaired during the interval.
3. The justification data of dipole can be found in appendix C. The return loss is < -20dB, within 20% of prior calibration, the impedance is within 5 ohm of prior calibration.

10. System Verification

10.1 Tissue Simulating Liquids

For the measurement of the field distribution inside the SAM phantom with DASY, the phantom must be filled with around 25 liters of homogeneous body tissue simulating liquid. For head SAR testing, the liquid height from the ear reference point (ERP) of the phantom to the liquid top surface is larger than 15 cm, which is shown in Fig. 11.1. For body SAR testing, the liquid height from the center of the flat phantom to the liquid top surface is larger than 15 cm, which is shown in Fig. 11.2.

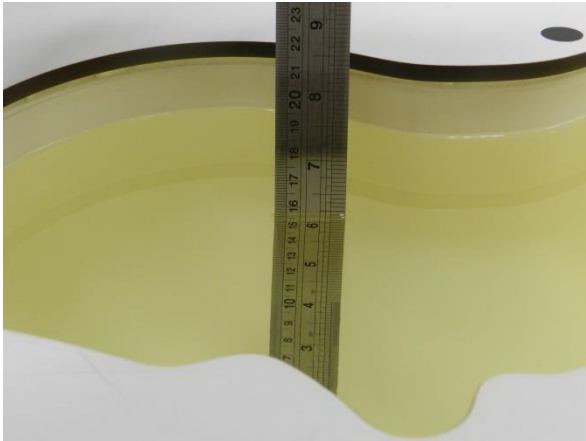

Fig 11.1 Photo of Liquid Height for Head SAR

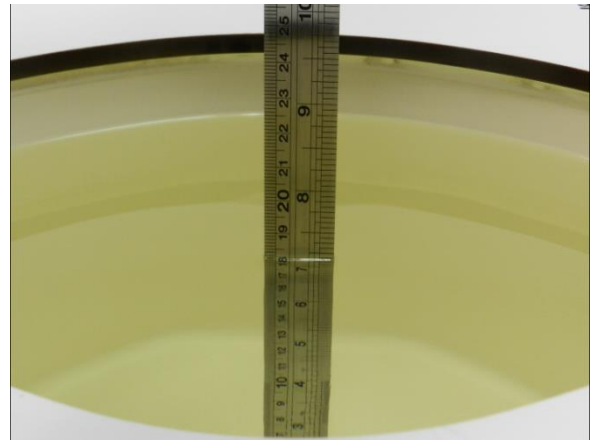

Fig 11.2 Photo of Liquid Height for Body SAR

10.2 Tissue Verification

The following tissue formulations are provided for reference only as some of the parameters have not been thoroughly verified. The composition of ingredients may be modified accordingly to achieve the desired target tissue parameters required for routine SAR evaluation.

Frequency (MHz)	Water (%)	Sugar (%)	Cellulose (%)	Salt (%)	Preventol (%)	DGBE (%)	Conductivity (σ)	Permittivity (ϵ_r)
For Head								
835	40.3	57.9	0.2	1.4	0.2	0	0.90	41.5
1800, 1900, 2000	55.2	0	0	0.3	0	44.5	1.40	40.0
2450	55.0	0	0	0	0	45.0	1.80	39.2
2600	54.8	0	0	0.1	0	45.1	1.96	39.0

Simulating Liquid for 5GHz, Manufactured by SPEAG

Ingredients	(% by weight)
Water	64~78%
Mineral oil	11~18%
Emulsifiers	9~15%
Additives and Salt	2~3%

<Tissue Dielectric Parameter Check Results>

Frequency (MHz)	Tissue Type	Liquid Temp. (°C)	Conductivity (σ)	Permittivity (ϵ_r)	Conductivity Target (σ)	Permittivity Target (ϵ_r)	Delta (σ) (%)	Delta (ϵ_r) (%)	Limit (%)	Date
835	Head	22.8	0.911	42.682	0.90	41.50	1.22	2.85	±5	2020/4/1
1900	Head	22.8	1.403	39.504	1.40	40.00	0.21	-1.24	±5	2020/4/3
2450	Head	22.8	1.762	40.678	1.80	39.20	-2.11	3.77	±5	2020/4/6
2600	Head	22.9	2.027	37.857	1.96	39.00	3.42	-2.93	±5	2020/4/6
5250	Head	22.6	4.678	36.999	4.71	35.90	-0.68	3.06	±5	2020/7/11
5600	Head	22.9	5.037	36.493	5.07	35.50	-0.65	2.80	±5	2020/7/12
5750	Head	22.7	5.200	36.307	5.22	35.40	-0.38	2.56	±5	2020/7/12

10.3 System Performance Check Results

Comparing to the original SAR value provided by SPEAG, the verification data should be within its specification of 10 %. Below table shows the target SAR and measured SAR after normalized to 1W input power. The table below indicates the system performance check can meet the variation criterion and the plots can be referred to Appendix A of this report.

Date	Frequency (MHz)	Tissue Type	Input Power (mW)	Dipole S/N	Probe S/N	DAE S/N	Measured 1g SAR (W/kg)	Targeted 1g SAR (W/kg)	Normalized 1g SAR (W/kg)	Deviation (%)
2020/4/1	835	Head	250	4d151	3843	1358	2.41	9.30	9.64	3.66
2020/4/3	1900	Head	250	5d170	3843	1358	10.00	39.00	40.00	2.56
2020/4/6	2450	Head	250	908	3843	1358	12.60	52.80	50.40	-4.55
2020/4/6	2600	Head	250	1061	3843	1358	14.30	57.70	57.20	-0.87
2020/7/11	5250	Head	100	1113	7592	799	8.59	80.50	85.9	6.71
2020/7/12	5600	Head	100	1113	7592	799	8.83	83.40	88.3	5.88
2020/7/12	5750	Head	100	1113	7592	799	7.98	80.00	79.8	-0.25

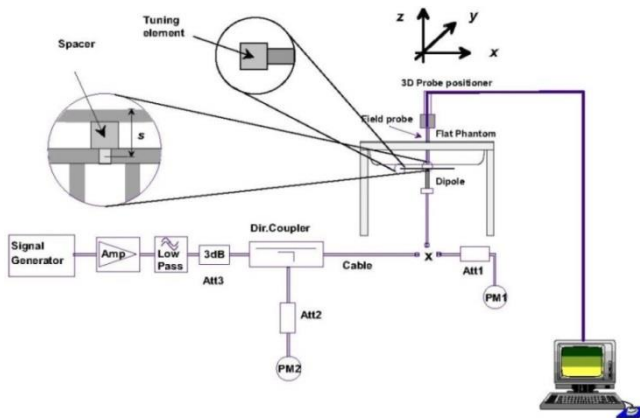

Fig 11.3.1 System Performance Check Setup



Fig 11.3.2 Setup Photo

11. RF Exposure Positions

11.1 Ear and handset reference point

Figure 12.1.1 shows the front, back, and side views of the SAM phantom. The center-of-mouth reference point is labeled “M,” the left ear reference point (ERP) is marked “LE,” and the right ERP is marked “RE.” Each ERP is 15 mm along the B-M (back-mouth) line behind the entrance-to-ear-canal (EEC) point, as shown in Figure 12.1.2 The Reference Plane is defined as passing through the two ear reference points and point M. The line N-F (neck-front), also called the reference pivoting line, is normal to the Reference Plane and perpendicular to both a line passing through RE and LE and the B-M line (see Figure 12.1.3). Both N-F and B-M lines should be marked on the exterior of the phantom shell to facilitate handset positioning. Posterior to the N-F line the ear shape is a flat surface with 6 mm thickness at each ERP, and forward of the N-F line the ear is truncated, as illustrated in Figure 12.1.2. The ear truncation is introduced to preclude the ear lobe from interfering with handset tilt, which could lead to unstable positioning at the cheek.

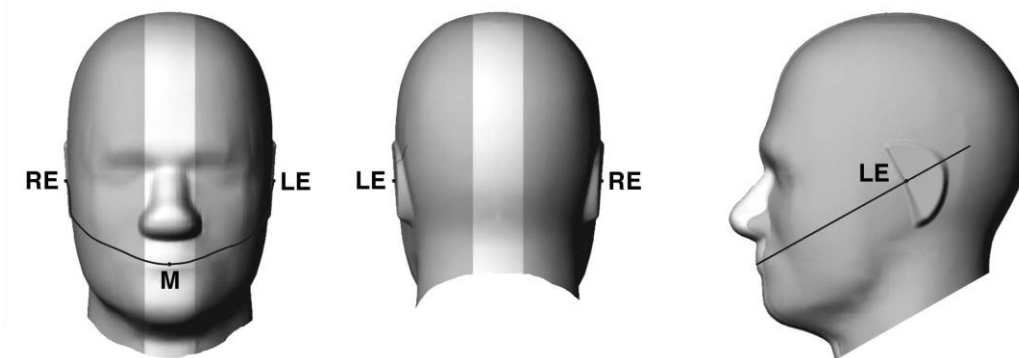

Fig 12.1.1 Front, back, and side views of SAM twin phantom

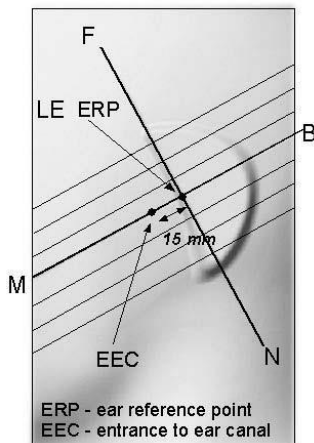

Fig 12.1.2 Close-up side view of phantom showing the ear region.

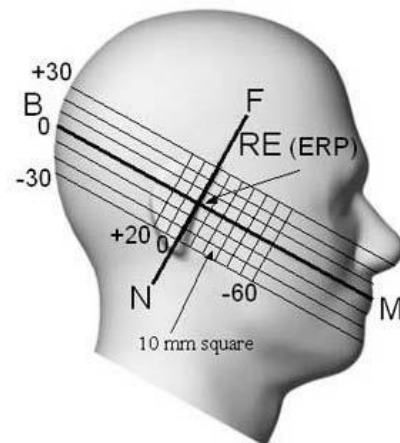

Fig 12.1.3 Side view of the phantom showing relevant markings and seven cross-sectional plane locations

11.2 Definition of the cheek position

1. Ready the handset for talk operation, if necessary. For example, for handsets with a cover piece (flip cover), open the cover. If the handset can transmit with the cover closed, both configurations must be tested.
2. Define two imaginary lines on the handset—the vertical centerline and the horizontal line. The vertical centerline passes through two points on the front side of the handset—the midpoint of the width w_t of the handset at the level of the acoustic output (point A in Figure 12.2.1 and Figure 12.2.2), and the midpoint of the width w_b of the bottom of the handset (point B). The horizontal line is perpendicular to the vertical centerline and passes through the center of the acoustic output (see Figure 12.2.1). The two lines intersect at point A. Note that for many handsets, point A coincides with the center of the acoustic output; however, the acoustic output may be located elsewhere on the horizontal line. Also note that the vertical centerline is not necessarily parallel to the front face of the handset (see Figure 12.2.2), especially for clamshell handsets, handsets with flip covers, and other irregularly-shaped handsets.
3. Position the handset close to the surface of the phantom such that point A is on the (virtual) extension of the line passing through points RE and LE on the phantom (see Figure 12.2.3), such that the plane defined by the vertical centerline and the horizontal line of the handset is approximately parallel to the sagittal plane of the phantom.
4. Translate the handset towards the phantom along the line passing through RE and LE until handset point A touches the pinna at the ERP.
5. While maintaining the handset in this plane, rotate it around the LE-RE line until the vertical centerline is in the plane normal to the plane containing B-M and N-F lines, i.e., the Reference Plane.
6. Rotate the handset around the vertical centerline until the handset (horizontal line) is parallel to the N-F line.
7. While maintaining the vertical centerline in the Reference Plane, keeping point A on the line passing through RE and LE, and maintaining the handset contact with the pinna, rotate the handset about the N-F line until any point on the handset is in contact with a phantom point below the pinna on the cheek. See Figure 12.2.3. The actual rotation angles should be documented in the test report.

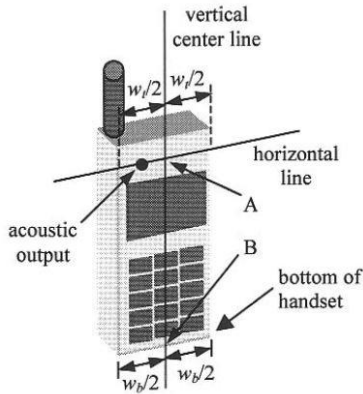

Fig 12.2.1 Handset vertical and horizontal reference lines—“fixed case”

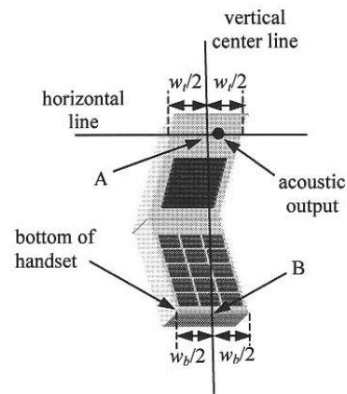

Fig 12.2.2 Handset vertical and horizontal reference lines—“clam-shell case”

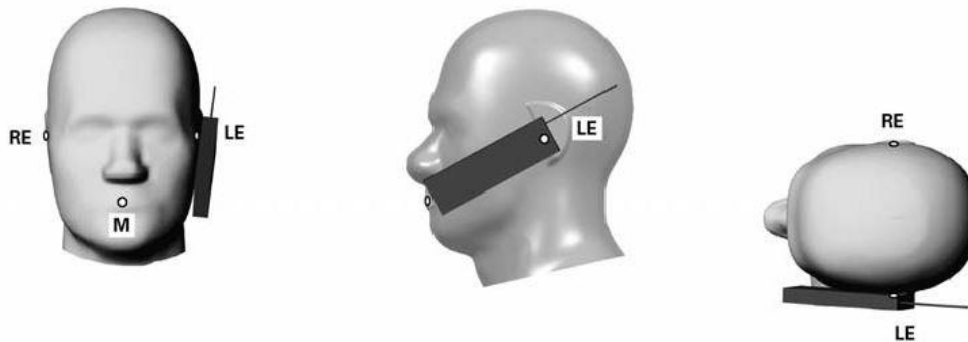

Fig 12.2.3 cheek or touch position. The reference points for the right ear (RE), left ear (LE), and mouth (M), which establish the Reference Plane for handset positioning, are indicated.

11.3 Definition of the tilt position

1. Ready the handset for talk operation, if necessary. For example, for handsets with a cover piece (flip cover), open the cover. If the handset can transmit with the cover closed, both configurations must be tested.
2. While maintaining the orientation of the handset, move the handset away from the pinna along the line passing through RE and LE far enough to allow a rotation of the handset away from the cheek by 15°.
3. Rotate the handset around the horizontal line by 15°.
4. While maintaining the orientation of the handset, move the handset towards the phantom on the line passing through RE and LE until any part of the handset touches the ear. The tilt position is obtained when the contact point is on the pinna. See Figure 12.3.1. If contact occurs at any location other than the pinna, e.g., the antenna at the back of the phantom head, the angle of the handset should be reduced. In this case, the tilt position is obtained if any point on the handset is in contact with the pinna and a second point

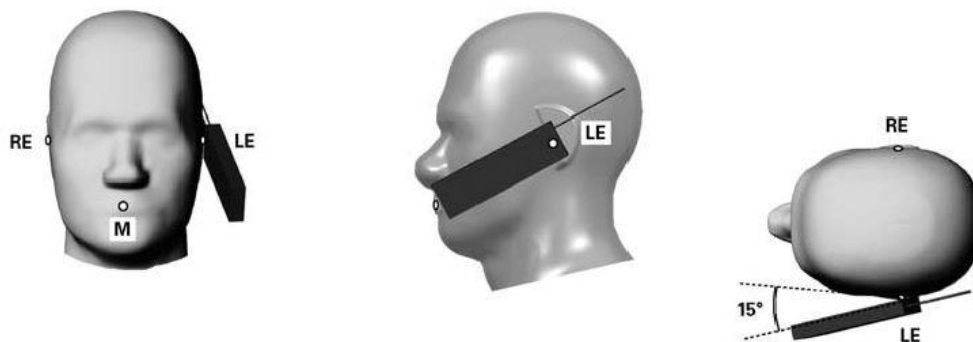

Fig 12.3.1 Tilt position. The reference points for the right ear (RE), left ear (LE), and mouth (M), which define the Reference Plane for handset positioning, are indicated.

11.4 Body Worn Accessory

Body-worn operating configurations are tested with the belt-clips and holsters attached to the device and positioned against a flat phantom in a normal use configuration (see Figure 12.4). Per KDB648474 D04v01r03, body-worn accessory exposure is typically related to voice mode operations when handsets are carried in body-worn accessories. The body-worn accessory procedures in FCC KDB 447498 D01v06 should be used to test for body-worn accessory SAR compliance, without a headset connected to it. This enables the test results for such configuration to be compatible with that required for hotspot mode when the body-worn accessory test separation distance is greater than or equal to that required for hotspot mode, when applicable. When the reported SAR for body-worn accessory, measured without a headset connected to the handset is $> 1.2 \text{ W/kg}$, the highest reported SAR configuration for that wireless mode and frequency band should be repeated for that body-worn accessory with a headset attached to the handset.

Accessories for body-worn operation configurations are divided into two categories: those that do not contain metallic components and those that do contain metallic components. When multiple accessories that do not contain metallic components are supplied with the device, the device is tested with only the accessory that dictates the closest spacing to the body. Then multiple accessories that contain metallic components are tested with the device with each accessory. If multiple accessories share an identical metallic component (i.e. the same metallic belt-clip used with different holsters with no other metallic components) only the accessory that dictates the closest spacing to the body is tested.

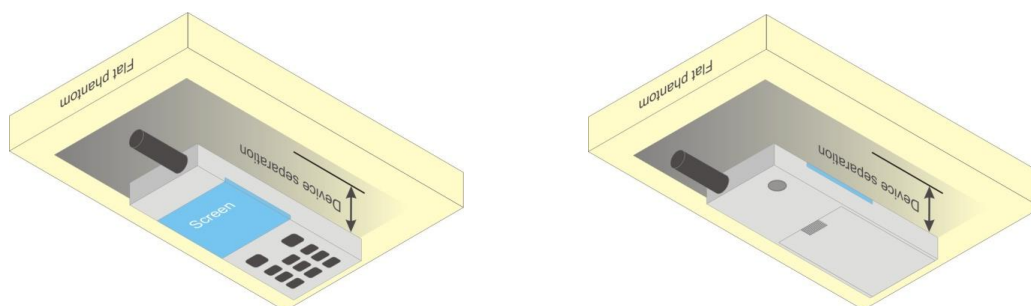

Fig 12.4 Body Worn Position



11.5 Product Specific 10g SAR Exposure

For smart phones with a display diagonal dimension > 15.0 cm or an overall diagonal dimension > 16.0 cm that provide similar mobile web access and multimedia support found in mini-tablets or UMPC mini-tablets that support voice calls next to the ear, According to KDB648474 D04v01r03, the following phablet procedures should be applied to evaluate SAR compliance for each applicable wireless modes and frequency band. Devices marketed as phablets, regardless of form factors and operating characteristics must be tested as a phablet to determine SAR compliance

1. The normally required head and body-worn accessory SAR test procedures for handsets, including hotspot mode, must be applied.
2. The UMPC mini-tablet procedures must also be applied to test the SAR of all surfaces and edges with an antenna located at ≤ 25 mm from that surface or edge, in direct contact with a flat phantom, for 10-g extremity SAR according to the body-equivalent tissue dielectric parameters in KDB 865664 to address interactive hand use exposure conditions.6 The UMPC mini-tablet 1-g SAR at 5 mm is not required. When hotspot mode applies, 10-g extremity SAR is required only for the surfaces and edges with hotspot mode 1-g reported SAR > 1.2 W/kg.

11.6 Wireless Router

Some battery-operated handsets have the capability to transmit and receive user through simultaneous transmission of WIFI simultaneously with a separate licensed transmitter. The FCC has provided guidance in FCC KDB Publication 941225 D06 v02r01 where SAR test considerations for handsets ($L \times W \geq 9 \text{ cm} \times 5 \text{ cm}$) are based on a composite test separation distance of 10mm from the front, back and edges of the device containing transmitting antennas within 2.5cm of their edges, determined from general mixed use conditions for this type of devices. Since the hotspot SAR results may overlap with the body-worn accessory SAR requirements, the more conservative configurations can be considered, thus excluding some body-worn accessory SAR tests.

When the user enables the personal wireless router functions for the handset, actual operations include simultaneous transmission of both the WIFI transmitter and another licensed transmitter. Both transmitters often do not transmit at the same transmitting frequency and thus cannot be evaluated for SAR under actual use conditions due to the limitations of the SAR assessment probes. Therefore, SAR must be evaluated for each frequency transmission and mode separately and spatially summed with the WIFI transmitter according to FCC KDB Publication 447498 D01v06 publication procedures. The "Portable Hotspot" feature on the handset was NOT activated during SAR assessments, to ensure the SAR measurements were evaluated for a single transmission frequency RF signal at a time.

12. Conducted RF Output Power (Unit: dBm)

The detailed conducted power table can refer to Appendix E.

<GSM Conducted Power>

1. Per KDB 447498 D01v06, the maximum output power channel is used for SAR testing and for further SAR test reduction.
2. Per KDB 941225 D01v03r01, for SAR test reduction for GSM / GPRS / EDGE modes is determined by the source-based time-averaged output power including tune-up tolerance. The mode with highest specified time-averaged output power should be tested for SAR compliance in the applicable exposure conditions. For modes with the same specified maximum output power and tolerance, the higher number time-slot configuration should be tested. Therefore, the GPRS 4Tx slots for GSM850/GSM1900 are considered as the primary mode.
3. Other configurations of GSM / GPRS / EDGE are considered as secondary modes. The 3G SAR test reduction procedure is applied, when the maximum output power and tune-up tolerance specified for production units in a secondary mode is $\leq \frac{1}{4}$ dB higher than the primary mode, SAR measurement is not required for the secondary mode.

<WCDMA Conducted Power>

1. The following tests were conducted according to the test requirements outlines in 3GPP TS 34.121 specification.
2. The procedures in KDB 941225 D01v03r01 are applied for 3GPP Rel. 6 HSPA to configure the device in the required sub-test mode(s) to determine SAR test exclusion.
3. For DC-HSDPA, the device was configured according to the H-Set 12, Fixed Reference Channel (FRC) configuration in Table C.8.1.12 of 3GPP TS 34.121-1, with the primary and the secondary serving HS-DSCH Cell enabled during the power measurement.

A summary of these settings are illustrated below:

HSDPA Setup Configuration:

- a. The EUT was connected to Base Station Agilent E5515C referred to the Setup Configuration.
- b. The RF path losses were compensated into the measurements.
- c. A call was established between EUT and Base Station with following setting:
 - i. Set Gain Factors (β_c and β_d) and parameters were set according to each
 - ii. Specific sub-test in the following table, C10.1.4, quoted from the TS 34.121
 - iii. Set RMC 12.2Kbps + HSDPA mode.
 - iv. Set Cell Power = -86 dBm
 - v. Set HS-DSCH Configuration Type to FRC (H-set 1, QPSK)
 - vi. Select HSDPA Uplink Parameters
 - vii. Set Delta ACK, Delta NACK and Delta CQI = 8
 - viii. Set Ack-Nack Repetition Factor to 3
 - ix. Set CQI Feedback Cycle (k) to 4 ms
 - x. Set CQI Repetition Factor to 2
 - xi. Power Ctrl Mode = All Up bits
- d. The transmitted maximum output power was recorded.

Table C.10.1.4: β values for transmitter characteristics tests with HS-DPCCH

Sub-test	β_c	β_d	β_d (SF)	β_c/β_d	β_{HS} (Note 1, Note 2)	CM (dB) (Note 3)	MPR (dB) (Note 3)
1	2/15	15/15	64	2/15	4/15	0.0	0.0
2	12/15 (Note 4)	15/15 (Note 4)	64	12/15 (Note 4)	24/15	1.0	0.0
3	15/15	8/15	64	15/8	30/15	1.5	0.5
4	15/15	4/15	64	15/4	30/15	1.5	0.5

Note 1: Δ_{ACK} , Δ_{NACK} and $\Delta_{CQI} = 30/15$ with $\beta_{HS} = 30/15 * \beta_c$.

Note 2: For the HS-DPCCH power mask requirement test in clause 5.2C, 5.7A, and the Error Vector Magnitude (EVM) with HS-DPCCH test in clause 5.13.1A, and HSDPA EVM with phase discontinuity in clause 5.13.1AA, Δ_{ACK} and $\Delta_{NACK} = 30/15$ with $\beta_{HS} = 30/15 * \beta_c$, and $\Delta_{CQI} = 24/15$ with $\beta_{HS} = 24/15 * \beta_c$.

Note 3: CM = 1 for $\beta_c/\beta_d = 12/15$, $\beta_{HS}/\beta_c = 24/15$. For all other combinations of DPDCCH, DPCCH and HS-DPCCH the MPR is based on the relative CM difference. This is applicable for only UEs that support HSDPA in release 6 and later releases.

Note 4: For subtest 2 the β_c/β_d ratio of 12/15 for the TFC during the measurement period (TF1, TF0) is achieved by setting the signalled gain factors for the reference TFC (TF1, TF1) to $\beta_c = 11/15$ and $\beta_d = 15/15$.

Setup Configuration

HSUPA Setup Configuration:

- a. The EUT was connected to Base Station Agilent E5515C referred to the Setup Configuration.
- b. The RF path losses were compensated into the measurements.
- c. A call was established between EUT and Base Station with following setting * :
 - i. Call Configs = 5.2B, 5.9B, 5.10B, and 5.13.2B with QPSK
 - ii. Set the Gain Factors (β_c and β_d) and parameters (AG Index) were set according to each specific sub-test in the following table, C11.1.3, quoted from the TS 34.121
 - iii. Set Cell Power = -86 dBm
 - iv. Set Channel Type = 12.2k + HSPA
 - v. Set UE Target Power
 - vi. Power Ctrl Mode= Alternating bits
 - vii. Set and observe the E-TFCI
 - viii. Confirm that E-TFCI is equal to the target E-TFCI of 75 for sub-test 1, and other subtest's E-TFCI
- d. The transmitted maximum output power was recorded.

Table C.11.1.3: β values for transmitter characteristics tests with HS-DPCCH and E-DCH

Sub-test	β_c	β_d	β_d (SF)	β_c/β_d	β_{HS} (Note1)	β_{ec}	β_{ed} (Note 4) (Note 5)	β_{ed} (SF)	β_{ed} (Codes)	CM (dB) (Note 2)	MPR (dB) (Note 2) (Note 6)	AG Index (Note 5)	E-TFCI
1	11/15 (Note 3)	15/15 (Note 3)	64	11/15 (Note 3)	22/15	209/25	1309/225	4	1	1.0	0.0	20	75
2	6/15	15/15	64	6/15	12/15	12/15	94/75	4	1	3.0	2.0	12	67
3	15/15	9/15	64	15/9	30/15	30/15	β_{ed1} : 47/15 β_{ed2} : 47/15	4 4	2	2.0	1.0	15	92
4	2/15	15/15	64	2/15	4/15	2/15	56/75	4	1	3.0	2.0	17	71
5	15/15	0	-	-	5/15	5/15	47/15	4	1	1.0	0.0	12	67

Note 1: For sub-test 1 to 4, Δ_{ACK} , Δ_{NACK} and $\Delta_{CQI} = 30/15$ with $\beta_{hs} = 30/15 * \beta_c$. For sub-test 5, Δ_{ACK} , Δ_{NACK} and $\Delta_{CQI} = 5/15$ with $\beta_{hs} = 5/15 * \beta_c$.

Note 2: CM = 1 for $\beta_c/\beta_d = 12/15$, $\beta_{hs}/\beta_c = 24/15$. For all other combinations of DPDCH, DPCCH, HS- DPCCH, E-DPDCH and E-DPCCH the MPR is based on the relative CM difference.

Note 3: For subtest 1 the β_c/β_d ratio of 11/15 for the TFC during the measurement period (TF1, TF0) is achieved by setting the signalled gain factors for the reference TFC (TF1, TF0) to $\beta_c = 10/15$ and $\beta_d = 15/15$.

Note 4: In case of testing by UE using E-DPDCH Physical Layer category 1, Sub-test 3 is omitted according to TS25.306 Table 5.1g.

Note 5: β_{ed} can not be set directly; it is set by Absolute Grant Value.

Note 6: For subtests 2, 3 and 4, UE may perform E-DPDCH power scaling at max power which could results in slightly smaller MPR values.

Setup Configuration

DC-HSDPA 3GPP release 8 Setup Configuration:

- a. The EUT was connected to Base Station referred to the Setup Configuration below
- b. The RF path losses were compensated into the measurements.
- c. A call was established between EUT and Base Station with following setting:
 - i. Set RMC 12.2Kbps + HSDPA mode.
 - ii. Set Cell Power = -25 dBm
 - iii. Set HS-DSCH Configuration Type to FRC (H-set 12, QPSK)
 - iv. Select HSDPA Uplink Parameters
 - v. Set Gain Factors (β_c and β_d) and parameters were set according to each Specific sub-test in the following table, C10.1.4, quoted from the TS 34.121
 - a). Subtest 1: $\beta_c/\beta_d=2/15$
 - b). Subtest 2: $\beta_c/\beta_d=12/15$
 - c). Subtest 3: $\beta_c/\beta_d=15/8$
 - d). Subtest 4: $\beta_c/\beta_d=15/4$
 - vi. Set Delta ACK, Delta NACK and Delta CQI = 8
 - vii. Set Ack-Nack Repetition Factor to 3
 - viii. Set CQI Feedback Cycle (k) to 4 ms
 - ix. Set CQI Repetition Factor to 2
 - x. Power Ctrl Mode = All Up bits
- d. The transmitted maximum output power was recorded.

The following tests were conducted according to the test requirements outlines in 3GPP TS 34.121 specification. A summary of these settings are illustrated below:

C.8.1.12 Fixed Reference Channel Definition H-Set 12

Table C.8.1.12: Fixed Reference Channel H-Set 12

Parameter	Unit	Value
Nominal Avg. Inf. Bit Rate	kbps	60
Inter-TTI Distance	TTI's	1
Number of HARQ Processes	Processes	6
Information Bit Payload (N_{INF})	Bits	120
Number Code Blocks	Blocks	1
Binary Channel Bits Per TTI	Bits	960
Total Available SML's in UE	SML's	19200
Number of SML's per HARQ Proc.	SML's	3200
Coding Rate		0.15
Number of Physical Channel Codes	Codes	1
Modulation		QPSK
Note 1: The RMC is intended to be used for DC-HSDPA mode and both cells shall transmit with identical parameters as listed in the table. Note 2: Maximum number of transmission is limited to 1, i.e., retransmission is not allowed. The redundancy and constellation version 0 shall be used.		

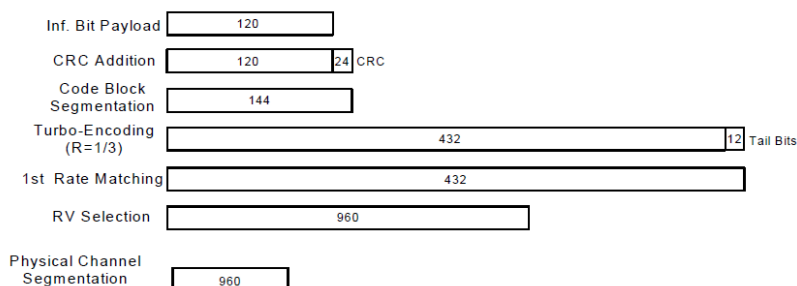

Figure C.8.19: Coding rate for Fixed reference Channel H-Set 12 (QPSK)

Setup Configuration

HSPA+ 3GPP release 7 (uplink category 7) 16QAM, Setup Configuration:

- a. The EUT was connected to Base Station Agilent E5515C referred to the Setup Configuration.
- b. The RF path losses were compensated into the measurements.
- c. A call was established between EUT and Base Station with following setting * :
 - i. Call Configs = 5.2E:HSPA+:UL with 16QAM
 - ii. Set the Gain Factors (β_c and β_d) and parameters (AG Index) were set according to each specific sub-test in the following table, C11.1.4, quoted from the TS 34.121-1 s5.2E
 - iii. Set Channel Parms
 - iv. Set Cell Power = -86 dBm
 - v. Set Channel Type = HSPA
 - vi. Set UE Target Power =21 dBm
 - vii. Power Ctrl Mode= All Up Bits
 - viii. Set Manual Uplink DPCH Bc/Bd = Manual
 - ix. Set Manual Uplink DPCH Bc and Bd=15,15(for 34.121-1 v8.10.0 table C11.1.4 sub-test 1)
 - x. Set HSPA Conn DL Channel Levels
 - xi. Set HS-SCCH Configs
 - xii. Set RB Test Mode Setup
 - xiii. Set Common HSUPA Parameters
 - xiv. Set Serving Grant
 - xv. Confirm that E-TFCI is equal to the target E-TFCI of 105 for sub-test 1, and other subtest's E-TFCI
- d. The transmitted maximum output power was recorded.

Table C.11.1.4: β values for transmitter characteristics tests with HS-DPCCH and E-DCH with 16QAM

Sub-test	β_c (Note3)	β_d	β_{HS} (Note1)	β_{ec}	β_{ed} (2xSF2) (Note 4)	β_{ed} (2xSF4) (Note 4)	CM (dB) (Note 2)	MPR (dB) (Note 2)	AG Index (Note 4)	E-TFCI (Note 5)	E-TFCI (boost)
1	1	0	30/15	30/15	β_{ed1} : 30/15 β_{ed2} : 30/15	β_{ed3} : 24/15 β_{ed4} : 24/15	3.5	2.5	14	105	105

Note 1: $\Delta_{ACK}, \Delta_{NACK}$ and $\Delta_{CQI} = 30/15$ with $\beta_{fs} = 30/15 * \beta_c$.

Note 2: CM = 3.5 and the MPR is based on the relative CM difference, MPR = MAX(CM-1,0).

Note 3: DPDCH is not configured, therefore the β_c is set to 1 and $\beta_d = 0$ by default.

Note 4: β_{ed} can not be set directly; it is set by Absolute Grant Value.

Note 5: All the sub-tests require the UE to transmit 2SF2+2SF4 16QAM EDCH and they apply for UE using E-DPDCH category 7. E-DCH TTI is set to 2ms TTI and E-DCH table index = 2. To support these E-DCH configurations DPDCH is not allocated. The UE is signaled to use the extrapolation algorithm.

Setup Configuration

<WCDMA Conducted Power>

General Note:

1. Per KDB 941225 D01v03r01, for SAR testing is measured using a 12.2 kbps RMC with TPC bits configured to all "1's".
2. Per KDB 941225 D01v03r01, RMC 12.2kbps setting is used to evaluate SAR. The maximum output power and tune-up tolerance specified for production units in HSDPA / HSUPA / DC-HSDPA is / HSPA+ $\leq 1/4$ dB higher than RMC 12.2Kbps or when the highest reported SAR of the RMC12.2Kbps is scaled by the ratio of specified maximum output power and tune-up tolerance of HSDPA / HSUPA / DC-HSDPA / HSPA+ to RMC12.2Kbps and the adjusted SAR is ≤ 1.2 W/kg, SAR measurement is not required for HSDPA / HSUPA / DC-HSDPA / HSPA+, and according to the following RF output power, the output power results of the secondary modes (HSDPA / HSUPA / DC-HSDPA / HSPA+) are less than $1/4$ dB higher than the primary modes; therefore, SAR measurement is not required for HSDPA / HSUPA / DC-HSDPA / HSPA+

<LTE Conducted Power>

General Note:

1. Anritsu MT8821C base station simulator was used to setup the connection with EUT; the frequency band, channel bandwidth, RB allocation configuration, modulation type are set in the base station simulator to configure EUT transmitting at maximum power and at different configurations which are requested to be reported to FCC, for conducted power measurement and SAR testing.
2. Per KDB 941225 D05v02r05, when a properly configured base station simulator is used for the SAR and power measurements, spectrum plots for each RB allocation and offset configuration is not required.
3. Per KDB 941225 D05v02r05, start with the largest channel bandwidth and measure SAR for QPSK with 1 RB allocation, using the RB offset and required test channel combination with the highest maximum output power for RB offsets at the upper edge, middle and lower edge of each required test channel.
4. Per KDB 941225 D05v02r05, 50% RB allocation for QPSK SAR testing follows 1RB QPSK allocation procedure.
5. Per KDB 941225 D05v02r05, for QPSK with 100% RB allocation, SAR is not required when the highest maximum output power for 100 % RB allocation is less than the highest maximum output power in 50% and 1 RB allocations and the highest reported SAR for 1 RB and 50% RB allocation are ≤ 0.8 W/kg. Otherwise, SAR is measured for the highest output power channel; and if the reported SAR is > 1.45 W/kg, the remaining required test channels must also be tested.
6. Per KDB 941225 D05v02r05, 16QAM/64QAM output power for each RB allocation configuration is $>$ not $\frac{1}{2}$ dB higher than the same configuration in QPSK and the reported SAR for the QPSK configuration is ≤ 1.45 W/kg; Per KDB 941225 D05v02r05, 16QAM/64QAM SAR testing is not required.
7. Per KDB 941225 D05v02r05, smaller bandwidth output power for each RB allocation configuration is $>$ not $\frac{1}{2}$ dB higher than the same configuration in the largest supported bandwidth, and the reported SAR for the largest supported bandwidth is ≤ 1.45 W/kg; Per KDB 941225 D05v02r05, smaller bandwidth SAR testing is not required.
8. According to 2017 TCB workshop, for 64 QAM and 16 QAM should be verified by checking the signal constellation with a call box to avoid incorrect maximum power levels due to MPR and other requirements associated with signal modulation, and the following figure is taken from the "Fundamental Measurement >> Modulation Analysis >> constellation" mode of the device connect to the MT8821C base station, therefore, the device 64QAM and 16QAM signal modulation are correct.

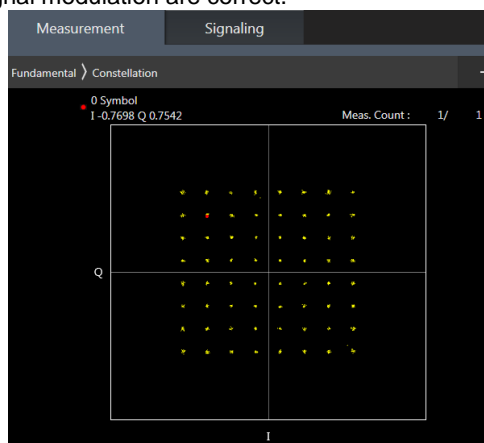

64QAM



16QAM

<WLAN Conducted Power>

General Note:

1. Per KDB 248227 D01v02r02, SAR test reduction is determined according to 802.11 transmission mode configurations and certain exposure conditions with multiple test positions. In the 2.4 GHz band, separate SAR procedures are applied to DSSS and OFDM configurations to simplify DSSS test requirements. For OFDM, in both 2.4 and 5 GHz bands, an initial test configuration must be determined for each standalone and aggregated frequency band, according to the transmission mode configuration with the highest maximum output power specified for production units to perform SAR measurements. If the same highest maximum output power applies to different combinations of channel bandwidths, modulations and data rates, additional procedures are applied to determine which test configurations require SAR measurement. When applicable, an initial test position may be applied to reduce the number of SAR measurements required for next to the ear, UMPC mini-tablet or hotspot mode configurations with multiple test positions.
2. For 2.4 GHz 802.11b DSSS, either the initial test position procedure for multiple exposure test positions or the DSSS procedure for fixed exposure position is applied; these are mutually exclusive. For 2.4 GHz and 5 GHz OFDM configurations, the initial test configuration is applied to measure SAR using either the initial test position procedure for multiple exposure test position configurations or the initial test configuration procedures for fixed exposure test conditions. Based on the reported SAR of the measured configurations and maximum output power of the transmission mode configurations that are not included in the initial test configuration, the subsequent test configuration and initial test position procedures are applied to determine if SAR measurements are required for the remaining OFDM transmission configurations. In general, the number of test channels that require SAR measurement is minimized based on maximum output power measured for the test sample(s).
3. For OFDM transmission configurations in the 2.4 GHz and 5 GHz bands, When the same maximum power is specified for multiple transmission modes in a frequency band, the largest channel bandwidth, lowest order modulation, lowest data rate and lowest order 802.11a/g/n/ac mode is used for SAR measurement, on the highest measured output power channel for each frequency band.
4. DSSS and OFDM configurations are considered separately according to the required SAR procedures. SAR is measured in the initial test position using the 802.11 transmission mode configuration required by the DSSS procedure or initial test configuration and subsequent test configuration(s) according to the OFDM procedures.18 The initial test position procedure is described in the following:
 - a. When the reported SAR of the initial test position is ≤ 0.4 W/kg, further SAR measurement is not required for the other test positions in that exposure configuration and 802.11 transmission mode combinations within the frequency band or aggregated band.
 - b. When the reported SAR of the test position is > 0.4 W/kg, SAR is repeated for the 802.11 transmission mode configuration tested in the initial test position to measure the subsequent next closet/smallest test separation distance and maximum coupling test position on the highest maximum output power channel, until the report SAR is ≤ 0.8 W/kg or all required test position are tested.
 - c. For all positions/configurations, when the reported SAR is > 0.8 W/kg, SAR is measured for these test positions/configurations on the subsequent next highest measured output power channel(s) until the reported SAR is ≤ 1.2 W/kg or all required channels are tested.

<2.4GHz Bluetooth>

General Note:

1. For 2.4GHz Bluetooth SAR testing was selected 1Mbps, due to its highest average power.
2. The Bluetooth duty cycle is 76.82% as following figure, according to 2016 Oct. TCB workshop for Bluetooth SAR scaling need further consideration and the theoretical duty cycle is 83.3%, therefore the actual duty cycle will be scaled up to the theoretical value of Bluetooth reported SAR calculation

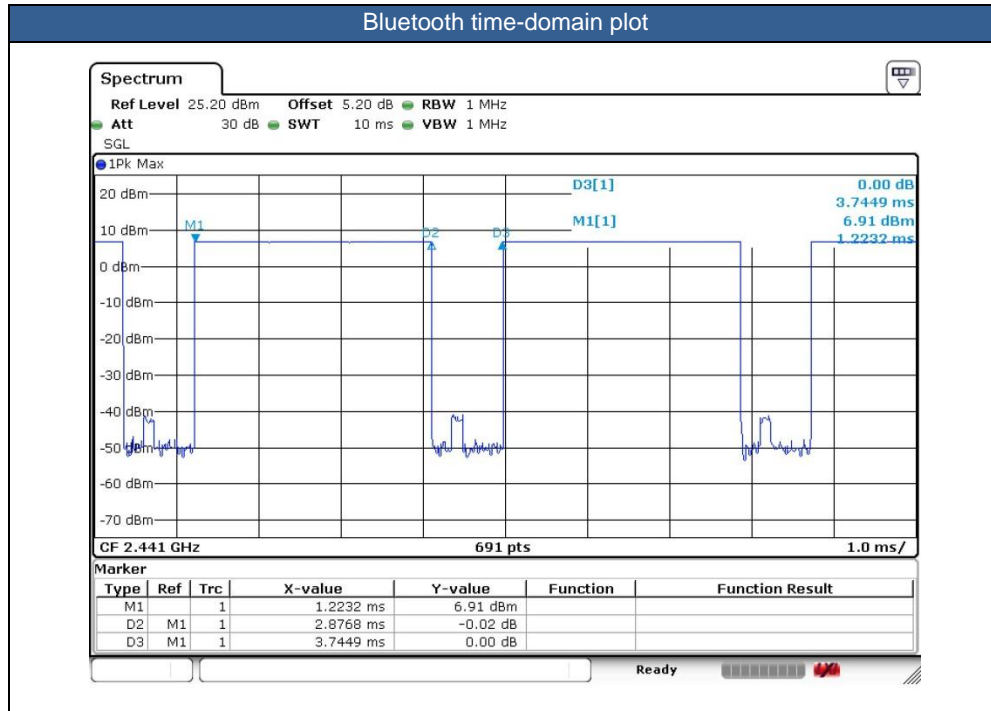

13. Antenna Location

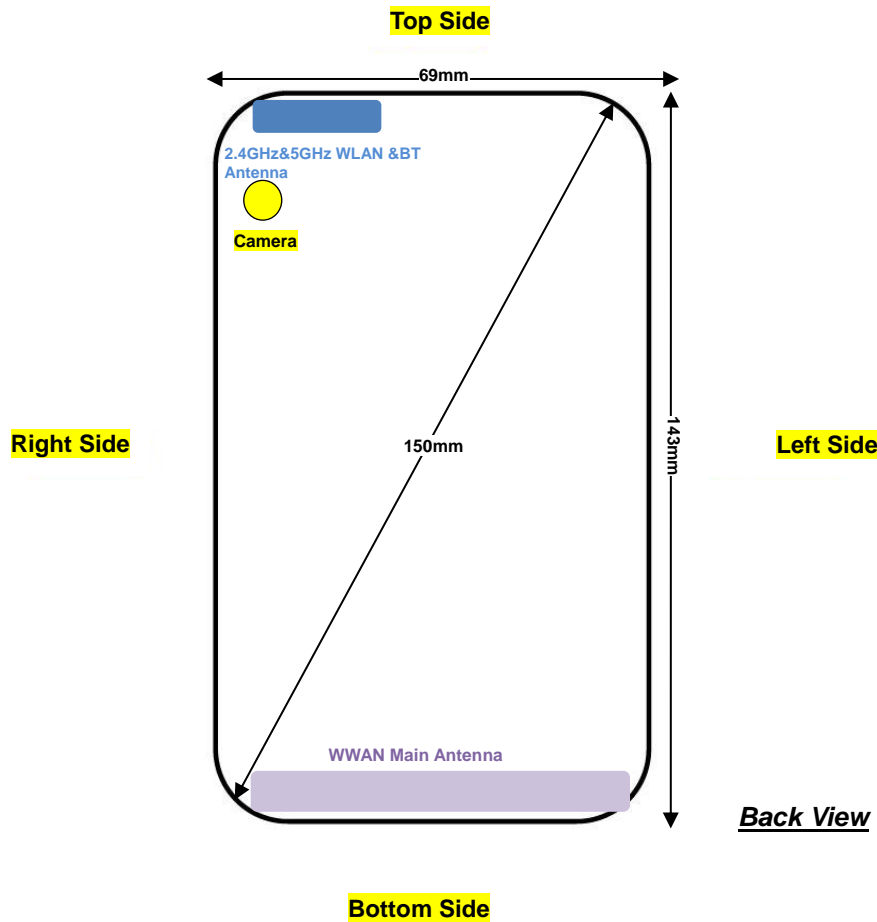

Distance of the Antenna to the EUT surface/edge						
Antennas	Back	Front	Top Side	Bottom Side	Right Side	Left Side
WWAN Main Antenna	≤ 25mm	≤ 25mm	>25mm	≤ 25mm	≤ 25mm	≤ 25mm
2.4GHz/5GHz WLAN & BT	≤ 25mm	≤ 25mm	≤ 25mm	>25mm	≤ 25mm	>25mm

Positions for SAR tests; Hotspot mode						
Antennas	Back	Front	Top Side	Bottom Side	Right Side	Left Side
WWAN Main Antenna	Yes	Yes	No	Yes	Yes	Yes
2.4GHz/5GHz WLAN & BT	Yes	Yes	Yes	No	Yes	No

General Note:

- Referring to KDB 941225 D06 v02r01, when the overall device length and width are $\geq 9\text{cm} \times 5\text{cm}$, the test distance is 10 mm. SAR must be measured for all sides and surfaces with a transmitting antenna located within 25mm from that surface or edge.

14. SAR Test Results

General Note:

- Per KDB 447498 D01v06, the reported SAR is the measured SAR value adjusted for maximum tune-up tolerance.
 - Tune-up scaling Factor = tune-up limit power (mW) / EUT RF power (mW), where tune-up limit is the maximum rated power among all production units.
 - For SAR testing of WLAN signal with non-100% duty cycle, the measured SAR is scaled-up by the duty cycle scaling factor which is equal to "1/(duty cycle)"
 - For WWAN: Reported SAR(W/kg)= Measured SAR(W/kg)*Tune-up Scaling Factor
 - For BT/WLAN: Reported SAR(W/kg)= Measured SAR(W/kg)* Duty Cycle scaling factor * Tune-up scaling factor
- Per KDB 447498 D01v06, for each exposure position, testing of other required channels within the operating mode of a frequency band is not required when the *reported* 1-g or 10-g SAR for the mid-band or highest output power channel is:
 - ≤ 0.8 W/kg or 2.0 W/kg, for 1-g or 10-g respectively, when the transmission band is ≤ 100 MHz
 - ≤ 0.6 W/kg or 1.5 W/kg, for 1-g or 10-g respectively, when the transmission band is between 100 MHz and 200 MHz
 - ≤ 0.4 W/kg or 1.0 W/kg, for 1-g or 10-g respectively, when the transmission band is ≥ 200 MHz
- Per KDB 865664 D01v01r04, for each frequency band, repeated SAR measurement is required when the measured SAR is ≥ 0.8W/kg. Per KDB 865664 D01v01r04, if the extremity repeated SAR is necessary, the same procedures should be adapted for measurements according to extremity and occupational exposure limits by applying a factor of 2.5 for extremity exposure and a factor of 5 for occupational exposure to the corresponding SAR thresholds.

GSM Note:

- Per KDB 941225 D01v03r01, for SAR test reduction for GSM / GPRS / EDGE modes is determined by the source-based time-averaged output power including tune-up tolerance. The mode with highest specified time-averaged output power should be tested for SAR compliance in the applicable exposure conditions. For modes with the same specified maximum output power and tolerance, the higher number time-slot configuration should be tested. Therefore, the GPRS 4Tx slots for GSM850/GSM1900 are considered as the primary mode.
- Other configurations of GSM / GPRS / EDGE are considered as secondary modes. The 3G SAR test reduction procedure is applied, when the maximum output power and tune-up tolerance specified for production units in a secondary mode is ≤ ¼ dB higher than the primary mode, SAR measurement is not required for the secondary mode.

WCDMA Note:

- Per KDB 941225 D01v03r01, for SAR testing is measured using a 12.2 kbps RMC with TPC bits configured to all "1's".
- Per KDB 941225 D01v03r01, RMC 12.2kbps setting is used to evaluate SAR. The maximum output power and tune-up tolerance specified for production units in HSDPA / HSUPA / DC-HSDPA / HSPA+ is ≤ ¼ dB higher than RMC 12.2Kbps or when the highest reported SAR of the RMC12.2Kbps is scaled by the ratio of specified maximum output power and tune-up tolerance of HSDPA / HSUPA / DC-HSDPA / HSPA+ to RMC12.2Kbps and the adjusted SAR is ≤ 1.2 W/kg, SAR measurement is not required for HSDPA / HSUPA / DC-HSDPA / HSPA+, and according to the following RF output power, the output power results of the secondary modes (HSDPA / HSUPA / DC-HSDPA / HSPA+) are less than ¼ dB higher than the primary modes; therefore, SAR measurement is not required for HSDPA / HSUPA / DC-HSDPA / HSPA+.

LTE Note:

1. Per KDB 941225 D05v02r05, start with the largest channel bandwidth and measure SAR for QPSK with 1 RB allocation, using the RB offset and required test channel combination with the highest maximum output power for RB offsets at the upper edge, middle and lower edge of each required test channel.
2. Per KDB 941225 D05v02r05, 50% RB allocation for QPSK SAR testing follows 1RB QPSK allocation procedure.
3. Per KDB 941225 D05v02r05, for QPSK with 100% RB allocation, SAR is not required when the highest maximum output power for 100 % RB allocation is less than the highest maximum output power in 50% and 1 RB allocations and the highest reported SAR for 1 RB and 50% RB allocation are ≤ 0.8 W/kg. Otherwise, SAR is measured for the highest output power channel; and if the reported SAR is > 1.45 W/kg, the remaining required test channels must also be tested.
4. Per KDB 941225 D05v02r05, 16QAM/64QAM output power for each RB allocation configuration is $>$ not $\frac{1}{2}$ dB higher than the same configuration in QPSK and the reported SAR for the QPSK configuration is ≤ 1.45 W/kg; Per KDB 941225 D05v02r05, 16QAM/64QAM SAR testing is not required.
5. Per KDB 941225 D05v02r05, smaller bandwidth output power for each RB allocation configuration is $>$ not $\frac{1}{2}$ dB higher than the same configuration in the largest supported bandwidth, and the reported SAR for the largest supported bandwidth is ≤ 1.45 W/kg; Per KDB 941225 D05v02r05, smaller bandwidth SAR testing is not required.

WLAN Note:

1. Per KDB 248227 D01v02r02, for 2.4GHz 802.11g/n SAR testing is not required when the highest reported SAR for DSSS is adjusted by the ratio of OFDM to DSSS specified maximum output power and the adjusted SAR is ≤ 1.2 W/kg.
2. Per KDB 248227 D01v02r02, U-NII-1 SAR testing is not required when the U-NII-2A band highest reported SAR for a test configuration is ≤ 1.2 W/kg, SAR is not required for U-NII-1 band.
3. When the reported SAR of the test position is > 0.4 W/kg, SAR is repeated for the 802.11 transmission mode configuration tested in the initial test position to measure the subsequent next closet/smallest test separation distance and maximum coupling test position on the highest maximum output power channel, until the report SAR is ≤ 0.8 W/kg or all required test position are tested.
4. For all positions / configurations, when the reported SAR is > 0.8 W/kg, SAR is measured for these test positions / configurations on the subsequent next highest measured output power channel(s) until the reported SAR is ≤ 1.2 W/kg or all required channels are tested.
5. During SAR testing the WLAN transmission was verified using a spectrum analyzer.

Bluetooth Note :

1. For Bluetooth SAR, only the worst case of WLAN 2.4GHz SAR was evaluated due to Bluetooth and WLAN 2.4GHz share the same antenna with consistent pattern.



14.1 Head SAR

<GSM SAR>

Plot No.	Band	Mode	Test Position	Gap (mm)	Ch.	Freq. (MHz)	Average Power (dBm)	Tune-Up Limit (dBm)	Tune-up Scaling Factor	Power Drift (dB)	Measured 1g SAR (W/kg)	Reported 1g SAR (W/kg)
01	GSM850	GPRS 4 Tx slot	Right Cheek	0mm	251	848.8	27.79	29.50	1.483	-0.05	0.292	0.433
	GSM850	GPRS 4 Tx slot	Right Tilted	0mm	251	848.8	27.79	29.50	1.483	0.01	0.166	0.246
	GSM850	GPRS 4 Tx slot	Left Cheek	0mm	251	848.8	27.79	29.50	1.483	0.02	0.258	0.382
	GSM850	GPRS 4 Tx slot	Left Tilted	0mm	251	848.8	27.79	29.50	1.483	0.02	0.171	0.254
	GSM1900	GPRS 4 Tx slot	Right Cheek	0mm	810	1909.8	25.07	26.00	1.239	0.17	0.209	0.259
	GSM1900	GPRS 4 Tx slot	Right Tilted	0mm	810	1909.8	25.07	26.00	1.239	0.01	0.084	0.104
02	GSM1900	GPRS 4 Tx slot	Left Cheek	0mm	810	1909.8	25.07	26.00	1.239	0.06	0.211	0.261
	GSM1900	GPRS 4 Tx slot	Left Tilted	0mm	810	1909.8	25.07	26.00	1.239	0.05	0.054	0.067

<WCDMA SAR>

Plot No.	Band	Mode	Test Position	Gap (mm)	Ch.	Freq. (MHz)	Average Power (dBm)	Tune-Up Limit (dBm)	Tune-up Scaling Factor	Power Drift (dB)	Measured 1g SAR (W/kg)	Reported 1g SAR (W/kg)
03	WCDMA II	RMC 12.2Kbps	Right Cheek	0mm	9262	1852.4	22.86	23.00	1.033	-0.09	0.324	0.335
	WCDMA II	RMC 12.2Kbps	Right Tilted	0mm	9262	1852.4	22.86	23.00	1.033	-0.07	0.135	0.139
	WCDMA II	RMC 12.2Kbps	Left Cheek	0mm	9262	1852.4	22.86	23.00	1.033	0.04	0.235	0.243
	WCDMA II	RMC 12.2Kbps	Left Tilted	0mm	9262	1852.4	22.86	23.00	1.033	0.03	0.131	0.135
04	WCDMA V	RMC 12.2Kbps	Right Cheek	0mm	4233	846.6	22.64	23.00	1.086	-0.18	0.208	0.226
	WCDMA V	RMC 12.2Kbps	Right Tilted	0mm	4233	846.6	22.64	23.00	1.086	0.04	0.135	0.147
	WCDMA V	RMC 12.2Kbps	Left Cheek	0mm	4233	846.6	22.64	23.00	1.086	0.01	0.182	0.198
	WCDMA V	RMC 12.2Kbps	Left Tilted	0mm	4233	846.6	22.64	23.00	1.086	0.03	0.122	0.133

<FDD LTE SAR>

Plot No.	Band	BW (MHz)	Modulation	RB Size	RB offset	Test Position	Gap (mm)	Ch.	Freq. (MHz)	Average Power (dBm)	Tune-Up Limit (dBm)	Tune-up Scaling Factor	Power Drift (dB)	Measured 1g SAR (W/kg)	Reported 1g SAR (W/kg)
05	LTE Band 7	20M	QPSK	1	0	Right Cheek	0mm	21100	2535	20.68	21.00	1.076	-0.01	0.063	0.067
	LTE Band 7	20M	QPSK	50	0	Right Cheek	0mm	21100	2535	19.75	20.00	1.059	0.09	0.054	0.058
	LTE Band 7	20M	QPSK	1	0	Right Tilted	0mm	21100	2535	20.68	21.00	1.076	0.13	0.030	0.032
	LTE Band 7	20M	QPSK	50	0	Right Tilted	0mm	21100	2535	19.75	20.00	1.059	0.01	0.026	0.027
	LTE Band 7	20M	QPSK	1	0	Left Cheek	0mm	21100	2535	20.68	21.00	1.076	-0.01	0.036	0.039
	LTE Band 7	20M	QPSK	50	0	Left Cheek	0mm	21100	2535	19.75	20.00	1.059	0.09	0.031	0.033
	LTE Band 7	20M	QPSK	1	0	Left Tilted	0mm	21100	2535	20.68	21.00	1.076	-0.09	0.018	0.019
	LTE Band 7	20M	QPSK	50	0	Left Tilted	0mm	21100	2535	19.75	20.00	1.059	0.01	0.015	0.016



<WLAN SAR>

Plot No.	Band	Mode	Test Position	Gap (mm)	Ch.	Freq. (MHz)	Average Power (dBm)	Tune-Up Limit (dBm)	Tune-up Scaling Factor	Duty Cycle %	Duty Cycle Scaling Factor	Power Drift (dB)	Measured 1g SAR (W/kg)	Reported 1g SAR (W/kg)
06	WLAN2.4GHz	802.11b 1Mbps	Right Cheek	0mm	11	2462	17.02	18.00	1.253	100	1.000	0.04	0.184	0.231
	WLAN2.4GHz	802.11b 1Mbps	Right Tilted	0mm	11	2462	17.02	18.00	1.253	100	1.000	0.01	0.102	0.128
	WLAN2.4GHz	802.11b 1Mbps	Left Cheek	0mm	11	2462	17.02	18.00	1.253	100	1.000	0.05	0.164	0.206
	WLAN2.4GHz	802.11b 1Mbps	Left Tilted	0mm	11	2462	17.02	18.00	1.253	100	1.000	0.09	0.149	0.187

<Bluetooth SAR>

Plot No.	Band	Mode	Test Position	Gap (mm)	Ch.	Freq. (MHz)	Average Power (dBm)	Tune-Up Limit (dBm)	Tune-up Scaling Factor	Duty Cycle %	Duty Cycle Scaling Factor	Power Drift (dB)	Measured 1g SAR (W/kg)	Reported 1g SAR (W/kg)
07	Bluetooth	1Mbps	Right Cheek	0mm	39	2441	6.87	8	1.297	76.82	1.084	0.04	0.015	0.021

<WLAN5G SAR>

Plot No.	Band	Mode	Test Position	Gap (mm)	Ch.	Freq. (MHz)	Average Power (dBm)	Tune-Up Limit (dBm)	Tune-up Scaling Factor	Duty Cycle %	Duty Cycle Scaling Factor	Power Drift (dB)	Measured 1g SAR (W/kg)	Reported 1g SAR (W/kg)
	WLAN5.3GHz	802.11a 6Mbps	Right Cheek	0mm	56	5280	13.89	15.00	1.291	97.46	1.026	0.06	0.211	0.280
	WLAN5.3GHz	802.11a 6Mbps	Right Tilted	0mm	56	5280	13.89	15.00	1.291	97.46	1.026	0.01	0.217	0.287
	WLAN5.3GHz	802.11a 6Mbps	Left Cheek	0mm	56	5280	13.89	15.00	1.291	97.46	1.026	0.09	0.224	0.297
08	WLAN5.3GHz	802.11a 6Mbps	Left Tilted	0mm	56	5280	13.89	15.00	1.291	97.46	1.026	-0.06	0.254	0.336
	WLAN5.5GHz	802.11a 6Mbps	Right Cheek	0mm	132	5660	13.54	15.00	1.400	97.46	1.026	-0.01	0.265	0.381
09	WLAN5.5GHz	802.11a 6Mbps	Right Tilted	0mm	132	5660	13.54	15.00	1.400	97.46	1.026	-0.01	0.287	0.412
	WLAN5.5GHz	802.11a 6Mbps	Left Cheek	0mm	132	5660	13.54	15.00	1.400	97.46	1.026	0.09	0.268	0.385
	WLAN5.5GHz	802.11a 6Mbps	Left Tilted	0mm	132	5660	13.54	15.00	1.400	97.46	1.026	-0.11	0.274	0.393
	WLAN5.8GHz	802.11n-HT40 MCS0	Right Cheek	0mm	159	5795	9.34	10.00	1.164	94.27	1.061	-0.11	0.124	0.153
	WLAN5.8GHz	802.11n-HT40 MCS0	Right Tilted	0mm	159	5795	9.34	10.00	1.164	94.27	1.061	0.02	0.136	0.168
10	WLAN5.8GHz	802.11n-HT40 MCS0	Left Cheek	0mm	159	5795	9.34	10.00	1.164	94.27	1.061	-0.15	0.183	0.226
	WLAN5.8GHz	802.11n-HT40 MCS0	Left Tilted	0mm	159	5795	9.34	10.00	1.164	94.27	1.061	0.06	0.138	0.170



14.2 Hotspot SAR

<GSM SAR>

Plot No.	Band	Mode	Test Position	Gap (mm)	Ch.	Freq. (MHz)	Average Power (dBm)	Tune-Up Limit (dBm)	Tune-up Scaling Factor	Power Drift (dB)	Measured 1g SAR (W/kg)	Reported 1g SAR (W/kg)
	GSM850	GPRS 4 Tx slot	Front	10mm	251	848.8	27.79	29.5	1.483	0.09	0.332	0.492
11	GSM850	GPRS 4 Tx slot	Back	10mm	251	848.8	27.79	29.5	1.483	0.04	0.519	0.769
	GSM850	GPRS 4 Tx slot	Left Side	10mm	251	848.8	27.79	29.5	1.483	0.07	0.283	0.420
	GSM850	GPRS 4 Tx slot	Right Side	10mm	251	848.8	27.79	29.5	1.483	0.05	0.393	0.583
	GSM850	GPRS 4 Tx slot	Bottom Side	10mm	251	848.8	27.79	29.5	1.483	0.13	0.098	0.145
	GSM1900	GPRS 4 Tx slot	Front	10mm	810	1909.8	25.07	26	1.239	0.01	0.373	0.462
12	GSM1900	GPRS 4 Tx slot	Back	10mm	810	1909.8	25.07	26	1.239	-0.01	0.671	0.831
	GSM1900	GPRS 4 Tx slot	Back	10mm	512	1850.2	24.97	26	1.268	0.03	0.594	0.753
	GSM1900	GPRS 4 Tx slot	Back	10mm	661	1880	24.89	26	1.291	0.01	0.566	0.731
	GSM1900	GPRS 4 Tx slot	Left Side	10mm	810	1909.8	25.07	26	1.239	-0.16	0.188	0.233
	GSM1900	GPRS 4 Tx slot	Right Side	10mm	810	1909.8	25.07	26	1.239	-0.12	0.183	0.227
	GSM1900	GPRS 4 Tx slot	Bottom Side	10mm	810	1909.8	25.07	26	1.239	0.1	0.446	0.553

<WCDMA SAR>

Plot No.	Band	Mode	Test Position	Gap (mm)	Ch.	Freq. (MHz)	Average Power (dBm)	Tune-Up Limit (dBm)	Tune-up Scaling Factor	Power Drift (dB)	Measured 1g SAR (W/kg)	Reported 1g SAR (W/kg)
	WCDMA II	RMC 12.2Kbps	Front	10mm	9262	1852.4	22.86	23	1.033	0.1	0.539	0.557
	WCDMA II	RMC 12.2Kbps	Back	10mm	9262	1852.4	22.86	23	1.033	-0.19	0.787	0.813
13	WCDMA II	RMC 12.2Kbps	Back	10mm	9400	1880	22.78	23	1.052	-0.01	0.837	0.880
	WCDMA II	RMC 12.2Kbps	Back	10mm	9538	1907.6	22.81	23	1.045	-0.01	0.828	0.865
	WCDMA II	RMC 12.2Kbps	Left Side	10mm	9262	1852.4	22.86	23	1.033	-0.14	0.224	0.231
	WCDMA II	RMC 12.2Kbps	Right Side	10mm	9262	1852.4	22.86	23	1.033	0.01	0.249	0.257
	WCDMA II	RMC 12.2Kbps	Bottom Side	10mm	9262	1852.4	22.86	23	1.033	-0.02	0.574	0.593
	WCDMA V	RMC 12.2Kbps	Front	10mm	4233	846.6	22.64	23	1.086	0.01	0.226	0.246
14	WCDMA V	RMC 12.2Kbps	Back	10mm	4233	846.6	22.64	23	1.086	-0.01	0.426	0.463
	WCDMA V	RMC 12.2Kbps	Left Side	10mm	4233	846.6	22.64	23	1.086	0.05	0.209	0.227
	WCDMA V	RMC 12.2Kbps	Right Side	10mm	4233	846.6	22.64	23	1.086	0.05	0.284	0.309
	WCDMA V	RMC 12.2Kbps	Bottom Side	10mm	4233	846.6	22.64	23	1.086	0.01	0.068	0.074

<FDD LTE SAR>

Plot No.	Band	BW (MHz)	Modulation	RB Size	RB offset	Test Position	Gap (mm)	Ch.	Freq. (MHz)	Average Power (dBm)	Tune-Up Limit (dBm)	Tune-up Scaling Factor	Power Drift (dB)	Measured 1g SAR (W/kg)	Reported 1g SAR (W/kg)
	LTE Band 7	20M	QPSK	1	0	Front	10mm	21100	2535	20.68	21.00	1.076	0.01	0.293	0.315
	LTE Band 7	20M	QPSK	50	0	Front	10mm	21100	2535	19.75	20.00	1.059	0.08	0.255	0.270
	LTE Band 7	20M	QPSK	1	0	Back	10mm	21100	2535	20.68	21.00	1.076	0.03	0.893	0.961
	LTE Band 7	20M	QPSK	1	0	Back	10mm	20850	2510	20.56	21.00	1.107	0.06	0.803	0.889
15	LTE Band 7	20M	QPSK	1	0	Back	10mm	21350	2560	20.60	21.00	1.096	-0.04	0.998	1.094
	LTE Band 7	20M	QPSK	50	0	Back	10mm	21100	2535	19.75	20.00	1.059	0.07	0.789	0.836
	LTE Band 7	20M	QPSK	50	0	Back	10mm	20850	2510	19.54	20.00	1.112	-0.09	0.719	0.799
	LTE Band 7	20M	QPSK	50	0	Back	10mm	21350	2560	19.58	20.00	1.102	0.01	0.888	0.978
	LTE Band 7	20M	QPSK	100	0	Back	10mm	21100	2535	19.65	20.00	1.084	0.02	0.806	0.874
	LTE Band 7	20M	QPSK	1	0	Left Side	10mm	21100	2535	20.68	21.00	1.076	-0.05	0.042	0.046
	LTE Band 7	20M	QPSK	50	0	Left Side	10mm	21100	2535	19.75	20.00	1.059	0.01	0.036	0.038
	LTE Band 7	20M	QPSK	1	0	Right Side	10mm	21100	2535	20.68	21.00	1.076	0.03	0.067	0.072
	LTE Band 7	20M	QPSK	50	0	Right Side	10mm	21100	2535	19.75	20.00	1.059	0.04	0.058	0.062
	LTE Band 7	20M	QPSK	1	0	Bottom Side	10mm	21100	2535	20.68	21.00	1.076	0.03	0.702	0.756
	LTE Band 7	20M	QPSK	50	0	Bottom Side	10mm	21100	2535	19.75	20.00	1.059	-0.09	0.616	0.653

<WLAN SAR>

Plot No.	Band	Mode	Test Position	Gap (mm)	Ch.	Freq. (MHz)	Average Power (dBm)	Tune-Up Limit (dBm)	Tune-up Scaling Factor	Duty Cycle %	Duty Cycle Scaling Factor	Power Drift (dB)	Measured 1g SAR (W/kg)	Reported 1g SAR (W/kg)
	WLAN2.4GHz	802.11b 1Mbps	Front	10mm	11	2462	17.02	18	1.253	100	1.000	0.08	0.128	0.160
16	WLAN2.4GHz	802.11b 1Mbps	Back	10mm	11	2462	17.02	18	1.253	100	1.000	0.02	0.366	0.459
	WLAN2.4GHz	802.11b 1Mbps	Left Side	10mm	11	2462	17.02	18	1.253	100	1.000	-0.09	0.037	0.046
	WLAN2.4GHz	802.11b 1Mbps	Right Side	10mm	11	2462	17.02	18	1.253	100	1.000	0.09	0.065	0.081
	WLAN2.4GHz	802.11b 1Mbps	Top Side	10mm	11	2462	17.02	18	1.253	100	1.000	0.07	0.192	0.241

<Bluetooth SAR>

Plot No.	Band	Mode	Test Position	Gap (mm)	Ch.	Freq. (MHz)	Average Power (dBm)	Tune-Up Limit (dBm)	Tune-up Scaling Factor	Duty Cycle %	Duty Cycle Scaling Factor	Power Drift (dB)	Measured 1g SAR (W/kg)	Reported 1g SAR (W/kg)
17	Bluetooth	1Mbps	Back	10mm	39	2441	6.87	8	1.297	76.82	1.084	0.01	0.034	0.048



<WLAN5G SAR>

Plot No.	Band	Mode	Test Position	Gap (mm)	Ch.	Freq. (MHz)	Average Power (dBm)	Tune-Up Limit (dBm)	Tune-up Scaling Factor	Duty Cycle %	Duty Cycle Scaling Factor	Power Drift (dB)	Measured 1g SAR (W/kg)	Reported 1g SAR (W/kg)
	WLAN5.2GHz	802.11n-HT40 MCS0	Front	10mm	38	5190	13.38	15.00	1.452	94.27	1.061	0.01	0.027	0.042
18	WLAN5.2GHz	802.11n-HT40 MCS0	Back	10mm	38	5190	13.38	15.00	1.452	94.27	1.061	0.19	0.056	0.087
	WLAN5.2GHz	802.11n-HT40 MCS0	Left Side	10mm	38	5190	13.38	15.00	1.452	94.27	1.061	0.03	0.048	0.074
	WLAN5.2GHz	802.11n-HT40 MCS0	Right Side	10mm	38	5190	13.38	15.00	1.452	94.27	1.061	-0.11	0.033	0.051
	WLAN5.2GHz	802.11n-HT40 MCS0	Top Side	10mm	38	5190	13.38	15.00	1.452	94.27	1.061	0.05	0.042	0.065
	WLAN5.8GHz	802.11n-HT40 MCS0	Front	10mm	159	5795	9.34	10.00	1.164	94.27	1.061	0.04	0.041	0.051
21	WLAN5.8GHz	802.11n-HT40 MCS0	Back	10mm	159	5795	9.34	10.00	1.164	94.27	1.061	-0.08	0.054	0.067
	WLAN5.8GHz	802.11n-HT40 MCS0	Left Side	10mm	159	5795	9.34	10.00	1.164	94.27	1.061	0.08	0.023	0.028
	WLAN5.8GHz	802.11n-HT40 MCS0	Right Side	10mm	159	5795	9.34	10.00	1.164	94.27	1.061	-0.08	0.038	0.047
	WLAN5.8GHz	802.11n-HT40 MCS0	Top Side	10mm	159	5795	9.34	10.00	1.164	94.27	1.061	0.03	0.046	0.057

14.3 Body Worn Accessory SAR

<GSM SAR>

Plot No.	Band	Mode	Test Position	Gap (mm)	Ch.	Freq. (MHz)	Average Power (dBm)	Tune-Up Limit (dBm)	Tune-up Scaling Factor	Power Drift (dB)	Measured 1g SAR (W/kg)	Reported 1g SAR (W/kg)
	GSM850	GPRS 4 Tx slot	Front	10mm	251	848.8	27.79	29.5	1.483	0.09	0.332	0.492
22	GSM850	GPRS 4 Tx slot	Back	10mm	251	848.8	27.79	29.5	1.483	0.04	0.519	0.769
	GSM1900	GPRS 4 Tx slot	Front	10mm	810	1909.8	25.07	26	1.239	0.01	0.373	0.462
23	GSM1900	GPRS 4 Tx slot	Back	10mm	810	1909.8	25.07	26	1.239	-0.01	0.671	0.831
	GSM1900	GPRS 4 Tx slot	Back	10mm	512	1850.2	24.97	26	1.268	0.03	0.594	0.753
	GSM1900	GPRS 4 Tx slot	Back	10mm	661	1880	24.89	26	1.291	0.01	0.566	0.731

<WCDMA SAR>

Plot No.	Band	Mode	Test Position	Gap (mm)	Ch.	Freq. (MHz)	Average Power (dBm)	Tune-Up Limit (dBm)	Tune-up Scaling Factor	Power Drift (dB)	Measured 1g SAR (W/kg)	Reported 1g SAR (W/kg)
	WCDMA II	RMC 12.2Kbps	Front	10mm	9262	1852.4	22.86	23	1.033	0.1	0.539	0.557
	WCDMA II	RMC 12.2Kbps	Back	10mm	9262	1852.4	22.86	23	1.033	-0.19	0.787	0.813
24	WCDMA II	RMC 12.2Kbps	Back	10mm	9400	1880	22.78	23	1.052	-0.01	0.837	0.880
	WCDMA II	RMC 12.2Kbps	Back	10mm	9538	1907.6	22.81	23	1.045	-0.01	0.828	0.865
	WCDMA V	RMC 12.2Kbps	Front	10mm	4233	846.6	22.64	23	1.086	0.01	0.226	0.246
25	WCDMA V	RMC 12.2Kbps	Back	10mm	4233	846.6	22.64	23	1.086	-0.01	0.426	0.463

<FDD LTE SAR>

Plot No.	Band	BW (MHz)	Modulation	RB Size	RB offset	Test Position	Gap (mm)	Ch.	Freq. (MHz)	Average Power (dBm)	Tune-Up Limit (dBm)	Tune-up Scaling Factor	Power Drift (dB)	Measured 1g SAR (W/kg)	Reported 1g SAR (W/kg)
	LTE Band 7	20M	QPSK	1	0	Front	10mm	21100	2535	20.68	21.00	1.076	0.01	0.293	0.315
	LTE Band 7	20M	QPSK	50	0	Front	10mm	21100	2535	19.75	20.00	1.059	0.08	0.255	0.270
	LTE Band 7	20M	QPSK	1	0	Back	10mm	21100	2535	20.68	21.00	1.076	0.03	0.893	0.961
	LTE Band 7	20M	QPSK	1	0	Back	10mm	20850	2510	20.56	21.00	1.107	0.06	0.803	0.889
26	LTE Band 7	20M	QPSK	1	0	Back	10mm	21350	2560	20.60	21.00	1.096	-0.04	0.998	1.094
	LTE Band 7	20M	QPSK	50	0	Back	10mm	21100	2535	19.75	20.00	1.059	0.07	0.789	0.836
	LTE Band 7	20M	QPSK	50	0	Back	10mm	20850	2510	19.54	20.00	1.112	-0.09	0.719	0.799
	LTE Band 7	20M	QPSK	50	0	Back	10mm	21350	2560	19.58	20.00	1.102	0.01	0.888	0.978
	LTE Band 7	20M	QPSK	100	0	Back	10mm	21100	2535	19.65	20.00	1.084	0.02	0.806	0.874



<WLAN SAR>

Plot No.	Band	Mode	Test Position	Gap (mm)	Ch.	Freq. (MHz)	Average Power (dBm)	Tune-Up Limit (dBm)	Tune-up Scaling Factor	Duty Cycle %	Duty Cycle Scaling Factor	Power Drift (dB)	Measured 1g SAR (W/kg)	Reported 1g SAR (W/kg)
	WLAN2.4GHz	802.11b 1Mbps	Front	10mm	11	2462	17.02	18	1.253	100	1.000	0.08	0.128	0.160
27	WLAN2.4GHz	802.11b 1Mbps	Back	10mm	11	2462	17.02	18	1.253	100	1.000	0.02	0.366	0.459

<Bluetooth SAR>

Plot No.	Band	Mode	Test Position	Gap (mm)	Ch.	Freq. (MHz)	Average Power (dBm)	Tune-Up Limit (dBm)	Tune-up Scaling Factor	Duty Cycle %	Duty Cycle Scaling Factor	Power Drift (dB)	Measured 1g SAR (W/kg)	Reported 1g SAR (W/kg)
28	Bluetooth	1Mbps	Back	10mm	39	2441	6.87	8	1.297	76.82	1.084	0.01	0.034	0.048

<WLAN5G SAR>

Plot No.	Band	Mode	Test Position	Gap (mm)	Ch.	Freq. (MHz)	Average Power (dBm)	Tune-Up Limit (dBm)	Tune-up Scaling Factor	Duty Cycle %	Duty Cycle Scaling Factor	Power Drift (dB)	Measured 1g SAR (W/kg)	Reported 1g SAR (W/kg)
	WLAN5.2GHz	802.11n-HT40 MCS0	Front	10mm	38	5190	13.38	15.00	1.452	94.27	1.061	0.01	0.027	0.042
29	WLAN5.2GHz	802.11n-HT40 MCS0	Back	10mm	38	5190	13.38	15.00	1.452	94.27	1.061	0.19	0.056	0.087
	WLAN5.3GHz	802.11a 6Mbps	Front	10mm	56	5280	13.89	15.00	1.291	97.46	1.026	0.01	0.062	0.082
30	WLAN5.3GHz	802.11a 6Mbps	Back	10mm	56	5280	13.89	15.00	1.291	97.46	1.026	0.08	0.068	0.090
	WLAN5.5GHz	802.11a 6Mbps	Front	10mm	132	5660	13.54	15.00	1.400	97.46	1.026	0.05	0.086	0.123
31	WLAN5.5GHz	802.11a 6Mbps	Back	10mm	132	5660	13.54	15.00	1.400	97.46	1.026	-0.08	0.095	0.136
	WLAN5.8GHz	802.11n-HT40 MCS0	Front	10mm	159	5795	9.34	10.00	1.164	94.27	1.061	0.04	0.041	0.051
32	WLAN5.8GHz	802.11n-HT40 MCS0	Back	10mm	159	5795	9.34	10.00	1.164	94.27	1.061	-0.08	0.054	0.067

14.4 Repeated SAR Measurement

No.	Band	BW (MHz)	Modulation	RB Size	RB offset	Mode	Test Position	Gap (mm)	Ch.	Freq. (MHz)	Average Power (dBm)	Tune-Up Limit (dBm)	Tune-up Scaling Factor	Duty Cycle %	Duty Cycle Scaling Factor	Power Drift (dB)	Measured 1g SAR (W/kg)	Ratio	Reported 1g SAR (W/kg)
1st	WCDMA II	-	-	-	-	RMC 12.2Kbps	Back	10mm	9400	1880	22.78	23	1.052	-	-	-0.01	0.837	1	0.880
2nd	WCDMA II	-	-	-	-	RMC 12.2Kbps	Back	10mm	9400	1880	22.78	23	1.052	-	-	0.12	0.811	1.032	0.853
1st	LTE Band 7	20M	QPSK	1	0	-	Back	10mm	21350	2560	20.60	21.00	1.096	-	-	-0.04	0.998	1	1.094
2nd	LTE Band 7	20M	QPSK	1	0	-	Back	10mm	21350	2560	20.60	21.00	1.096	-	-	-0.1	0.982	1.016	1.077

General Note:

1. Per KDB 865664 D01v01r04, for each frequency band, repeated SAR measurement is required only when the measured SAR is $\geq 0.8W/kg$.
2. Per KDB 865664 D01v01r04, if the ratio among the repeated measurement is ≤ 1.2 and the measured SAR $< 1.45W/kg$, only one repeated measurement is required.
3. Per KDB 865664 D01v01r04, if the extremity repeated SAR is necessary, the same procedures should be adapted for measurements according to extremity and occupational exposure limits by applying a factor of 2.5 for extremity exposure and a factor of 5 for occupational exposure to the corresponding SAR thresholds.
4. The ratio is the difference in percentage between original and repeated *measured SAR*.
5. All measurement SAR result is scaled-up to account for tune-up tolerance and is compliant.

15. Simultaneous Transmission Analysis

No.	Simultaneous Transmission Configurations	Portable Handset		
		Head	Body-worn	Hotspot
1.	GSM Voice + WLAN2.4GHz	Yes	Yes	
2.	GPRS/EDGE + WLAN2.4GHz	Yes	Yes	Yes
3.	WCDMA + WLAN2.4GHz	Yes	Yes	Yes
4.	LTE + WLAN2.4GHz	Yes	Yes	Yes
5.	GSM Voice + WLAN5GHz	Yes	Yes	
6.	GPRS/EDGE + WLAN5GHz	Yes	Yes	Yes
7.	WCDMA + WLAN5GHz	Yes	Yes	Yes
8.	LTE + WLAN5GHz	Yes	Yes	Yes
9.	GSM Voice + Bluetooth	Yes	Yes	
10.	GPRS/EDGE + Bluetooth	Yes	Yes	Yes
11.	WCDMA + Bluetooth	Yes	Yes	Yes
12.	LTE + Bluetooth	Yes	Yes	Yes

General Note:

1. This device supports VoIP in GPRS, EGPRS, WCDMA and LTE (e.g. for 3rd-party VoIP), LTE supports VoLTE operation.
2. EUT will choose each GSM, WCDMA and LTE according to the network signal condition; therefore, they will not operate simultaneously at any moment.
3. This device 2.4GHz WLAN support hotspot operation and Bluetooth support tethering applications.
4. This device 2.4GHz WLAN/ 5.2GHz WLAN/5.8GHz WLAN support hotspot operation, and 5.2GHz WLAN/5.8GHz WLAN supports WLAN Direct (GC/GO), and 5.3GHz / 5.5GHz supports WLAN Direct (GC only).
5. EUT will choose either WLAN 2.4GHz or WLAN 5GHz according to the network signal condition; therefore, 2.4GHz WLAN and 5GHz WLAN will not operate simultaneously at any moment though they have independent antenna.
6. WLAN 2.4GHz and Bluetooth share the same antenna so can't transmit simultaneously.
7. According to the EUT character, WLAN 5GHz and Bluetooth can't transmit simultaneously.
8. The reported SAR summation is calculated based on the same configuration and test position.
9. Per KDB 447498 D01v06, simultaneous transmission SAR is compliant if,
 - i) 1g Scalar SAR summation < 1.6W/kg.
 - ii) $SPLSR = (SAR1 + SAR2)^{1.5} / (\text{min. separation distance, mm})$, and the peak separation distance is determined from the square root of $[(x1-x2)^2 + (y1-y2)^2 + (z1-z2)^2]$, where (x1, y1, z1) and (x2, y2, z2) are the coordinates of the extrapolated peak SAR locations in the zoom scan.
 - iii) If $SPLSR \leq 0.04$ for 1g SAR, simultaneously transmission SAR measurement is not necessary.
 - iv) Simultaneously transmission SAR measurement, and the reported multi-band 1g SAR < 1.6W/kg.



15.1 Head Exposure Conditions

WWAN Band		Exposure Position	1	2	4	6	1+2 Summed 1g SAR (W/kg)	1+4 Summed 1g SAR (W/kg)	1+6 Summed 1g SAR (W/kg)
			WWAN	2.4GHz WLAN	5GHz WLAN	Bluetooth			
			1g SAR (W/kg)	1g SAR (W/kg)	1g SAR (W/kg)	1g SAR (W/kg)			
GSM	GSM850	Right Cheek	0.433	0.231	0.381	0.021	0.66	0.81	0.45
		Right Tilted	0.246	0.128	0.412	0.021	0.37	0.66	0.27
		Left Cheek	0.382	0.206	0.385	0.021	0.59	0.77	0.40
		Left Tilted	0.254	0.187	0.393	0.021	0.44	0.65	0.28
	GSM1900	Right Cheek	0.259	0.231	0.381	0.021	0.49	0.64	0.28
		Right Tilted	0.104	0.128	0.412	0.021	0.23	0.52	0.13
		Left Cheek	0.261	0.206	0.385	0.021	0.47	0.65	0.28
		Left Tilted	0.067	0.187	0.393	0.021	0.25	0.46	0.09
WCDMA	WCDMA II	Right Cheek	0.335	0.231	0.381	0.021	0.57	0.72	0.36
		Right Tilted	0.139	0.128	0.412	0.021	0.27	0.55	0.16
		Left Cheek	0.243	0.206	0.385	0.021	0.45	0.63	0.26
		Left Tilted	0.135	0.187	0.393	0.021	0.32	0.53	0.16
	WCDMA V	Right Cheek	0.226	0.231	0.381	0.021	0.46	0.61	0.25
		Right Tilted	0.147	0.128	0.412	0.021	0.28	0.56	0.17
		Left Cheek	0.198	0.206	0.385	0.021	0.40	0.58	0.22
		Left Tilted	0.133	0.187	0.393	0.021	0.32	0.53	0.15
LTE	LTE Band 7	Right Cheek	0.067	0.231	0.381	0.021	0.30	0.45	0.09
		Right Tilted	0.032	0.128	0.412	0.021	0.16	0.44	0.05
		Left Cheek	0.039	0.206	0.385	0.021	0.25	0.42	0.06
		Left Tilted	0.019	0.187	0.393	0.021	0.21	0.41	0.04

15.2 Hotspot Exposure Conditions

WWAN Band		Exposure Position	1	2	4	6	1+2 Summed 1g SAR (W/kg)	1+4 Summed 1g SAR (W/kg)	1+6 Summed 1g SAR (W/kg)
			WWAN	2.4GHz WLAN	5GHz WLAN	Bluetooth			
			1g SAR (W/kg)	1g SAR (W/kg)	1g SAR (W/kg)	1g SAR (W/kg)			
GSM	GSM850	Front	0.492	0.160	0.051	0.048	0.65	0.54	0.54
		Back	0.769	0.459	0.087	0.048	1.23	0.86	0.82
		Left side	0.420	0.046	0.074	0.048	0.47	0.49	0.47
		Right side	0.583	0.081	0.051	0.048	0.66	0.63	0.63
		Top side		0.241	0.065	0.048	0.24	0.07	0.05
		Bottom side	0.145				0.15	0.15	0.15
	GSM1900	Front	0.462	0.160	0.051	0.048	0.62	0.51	0.51
		Back	0.831	0.459	0.087	0.048	1.29	0.92	0.88
		Left side	0.233	0.046	0.074	0.048	0.28	0.31	0.28
		Right side	0.227	0.081	0.051	0.048	0.31	0.28	0.28
		Top side		0.241	0.065	0.048	0.24	0.07	0.05
		Bottom side	0.553				0.55	0.55	0.55
WCDMA	WCDMA II	Front	0.557	0.160	0.051	0.048	0.72	0.61	0.61
		Back	0.880	0.459	0.087	0.048	1.34	0.97	0.93
		Left side	0.231	0.046	0.074	0.048	0.28	0.31	0.28
		Right side	0.257	0.081	0.051	0.048	0.34	0.31	0.31
		Top side		0.241	0.065	0.048	0.24	0.07	0.05
		Bottom side	0.593				0.59	0.59	0.59
	WCDMA V	Front	0.246	0.160	0.051	0.048	0.41	0.30	0.29
		Back	0.463	0.459	0.087	0.048	0.92	0.55	0.51
		Left side	0.227	0.046	0.074	0.048	0.27	0.30	0.28
		Right side	0.309	0.081	0.051	0.048	0.39	0.36	0.36
		Top side		0.241	0.065	0.048	0.24	0.07	0.05
		Bottom side	0.074				0.07	0.07	0.07
LTE	LTE Band 7	Front	0.315	0.160	0.051	0.048	0.48	0.37	0.36
		Back	1.094	0.459	0.087	0.048	1.55	1.18	1.14
		Left side	0.046	0.046	0.074	0.048	0.09	0.12	0.09
		Right side	0.072	0.081	0.051	0.048	0.15	0.12	0.12
		Top side		0.241	0.065	0.048	0.24	0.07	0.05
		Bottom side	0.756				0.76	0.76	0.76

15.3 Body-Worn Accessory Exposure Conditions

WWAN Band		Exposure Position	1	2	4	6	1+2 Summed 1g SAR (W/kg)	1+4 Summed 1g SAR (W/kg)	1+6 Summed 1g SAR (W/kg)
			WWAN	2.4GHz WLAN	5GHz WLAN	Bluetooth			
			1g SAR (W/kg)	1g SAR (W/kg)	1g SAR (W/kg)	1g SAR (W/kg)			
GSM	GSM850	Front	0.492	0.160	0.123	0.048	0.65	0.62	0.54
		Back	0.769	0.459	0.136	0.048	1.23	0.91	0.82
	GSM1900	Front	0.462	0.160	0.123	0.048	0.62	0.59	0.51
		Back	0.831	0.459	0.136	0.048	1.29	0.97	0.88
WCDMA	WCDMA II	Front	0.557	0.160	0.123	0.048	0.72	0.68	0.61
		Back	0.880	0.459	0.136	0.048	1.34	1.02	0.93
	WCDMA V	Front	0.246	0.160	0.123	0.048	0.41	0.37	0.29
		Back	0.463	0.459	0.136	0.048	0.92	0.60	0.51
LTE	LTE Band 7	Front	0.315	0.160	0.123	0.048	0.48	0.44	0.36
		Back	1.094	0.459	0.136	0.048	1.55	1.23	1.14

Test Engineer: Nick Hu, Yuan Zhao, Jiaxing Chang, Yuankai Kong



16. Uncertainty Assessment

Per KDB 865664 D01 SAR measurement 100MHz to 6GHz, when the highest measured 1-g SAR within a frequency band is < 1.5 W/kg and the measured 10-g SAR within a frequency band is < 3.75 W/kg. The expanded SAR measurement uncertainty must be $\leq 30\%$, for a confidence interval of $k = 2$. If these conditions are met, extensive SAR measurement uncertainty analysis described in IEEE Std 1528-2013 is not required in SAR reports submitted for equipment approval. For this device, the highest measured 1-g SAR is less 1.5W/kg and highest measured 10-g SAR is less 3.75W/kg. Therefore, the measurement uncertainty table is not required in this report.



17. References

- [1] FCC 47 CFR Part 2 "Frequency Allocations and Radio Treaty Matters; General Rules and Regulations"
- [2] ANSI/IEEE Std. C95.1-1992, "IEEE Standard for Safety Levels with Respect to Human Exposure to Radio Frequency Electromagnetic Fields, 3 kHz to 300 GHz", September 1992
- [3] IEEE Std. 1528-2013, "IEEE Recommended Practice for Determining the Peak Spatial-Average Specific Absorption Rate (SAR) in the Human Head from Wireless Communications Devices: Measurement Techniques", Sep 2013
- [4] SPEAG DASY System Handbook
- [5] FCC KDB 865664 D01 v01r04, "SAR Measurement Requirements for 100 MHz to 6 GHz", Aug 2015.
- [6] FCC KDB 865664 D02 v01r02, "RF Exposure Compliance Reporting and Documentation Considerations" Oct 2015.
- [7] FCC KDB 447498 D01 v06, "Mobile and Portable Device RF Exposure Procedures and Equipment Authorization Policies", Oct 2015
- [8] FCC KDB 648474 D04 v01r03, "SAR Evaluation Considerations for Wireless Handsets", Oct 2015.
- [9] FCC KDB 248227 D01 v02r02, "SAR Guidance for IEEE 802.11 (WiFi) Transmitters", Oct 2015.
- [10] FCC KDB 941225 D01 v03r01, "3G SAR MEAUREMENT PROCEDURES", Oct 2015
- [11] FCC KDB 941225 D05 v02r05, "SAR Evaluation Considerations for LTE Devices", Dec 2015
- [12] FCC KDB 941225 D06 v02r01, "SAR Evaluation Procedures for Portable Devices with Wireless Router Capabilities", Oct 2015.

-----THE END-----



Appendix A. Plots of System Performance Check

The plots are shown as follows.

System Check_Head_835MHz

DUT: D835V2-SN:4d151

Communication System: UID 0, CW (0); Frequency: 835 MHz; Duty Cycle: 1:1
Medium: HSL_850 Medium parameters used: $f = 835 \text{ MHz}$; $\sigma = 0.911 \text{ S/m}$; $\epsilon_r = 42.682$;
 $\rho = 1000 \text{ kg/m}^3$
Ambient Temperature : $23.2 \text{ }^\circ\text{C}$; Liquid Temperature : $22.8 \text{ }^\circ\text{C}$

DASY5 Configuration:

- Probe: EX3DV4 - SN3843; ConvF(9.07, 9.07, 9.07); Calibrated: 2019.9.26
- Sensor-Surface: 1.4mm (Mechanical Surface Detection)
- Electronics: DAE4 Sn1358; Calibrated: 2019.4.17
- Phantom: SAM2; Type: SAM; Serial: TP-1503
- Measurement SW: DASY52, Version 52.10 (1); SEMCAD X Version 14.6.11 (7439)

Pin=250mW/Area Scan (61x61x1): Interpolated grid: $dx=1.500 \text{ mm}$, $dy=1.500 \text{ mm}$
Maximum value of SAR (interpolated) = 3.24 W/kg

Pin=250mW/Zoom Scan (5x5x7)/Cube 0: Measurement grid: $dx=8\text{mm}$, $dy=8\text{mm}$, $dz=5\text{mm}$
Reference Value = 61.20 V/m ; Power Drift = 0.06 dB
Peak SAR (extrapolated) = 3.65 W/kg
SAR(1 g) = 2.41 W/kg ; SAR(10 g) = 1.58 W/kg
Maximum value of SAR (measured) = 3.23 W/kg

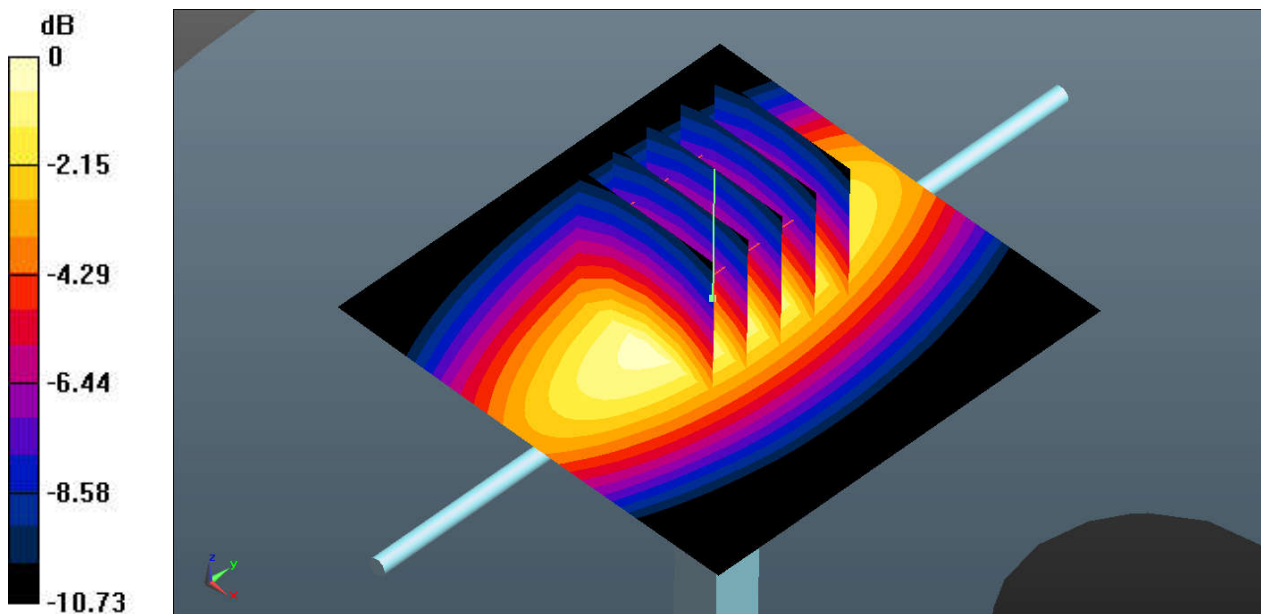

0 dB = $3.23 \text{ W/kg} = 5.09 \text{ dBW/kg}$

System Check_Head_1900MHz

DUT: D1900V2-SN:5d170

Communication System: UID 0, CW (0); Frequency: 1900 MHz; Duty Cycle: 1:1
Medium: HSL_1900 Medium parameters used: $f = 1900 \text{ MHz}$; $\sigma = 1.403 \text{ S/m}$; $\epsilon_r = 39.504$;
 $\rho = 1000 \text{ kg/m}^3$
Ambient Temperature : $23.2 \text{ }^\circ\text{C}$; Liquid Temperature : $22.8 \text{ }^\circ\text{C}$

DASY5 Configuration:

- Probe: EX3DV4 - SN3843; ConvF(7.67, 7.67, 7.67); Calibrated: 2019.9.26
- Sensor-Surface: 1.4mm (Mechanical Surface Detection)
- Electronics: DAE4 Sn1358; Calibrated: 2019.4.17
- Phantom: SAM2; Type: SAM; Serial: TP-1503
- Measurement SW: DASY52, Version 52.10 (1); SEMCAD X Version 14.6.11 (7439)

Pin=250mW/Area Scan (61x61x1): Interpolated grid: $dx=1.500 \text{ mm}$, $dy=1.500 \text{ mm}$
Maximum value of SAR (interpolated) = 13.0 W/kg

Pin=250mW/Zoom Scan (5x5x7)/Cube 0: Measurement grid: $dx=8\text{mm}$, $dy=8\text{mm}$, $dz=5\text{mm}$
Reference Value = 77.74 V/m ; Power Drift = 0.02 dB
Peak SAR (extrapolated) = 18.2 W/kg
SAR(1 g) = 10 W/kg ; SAR(10 g) = 5.19 W/kg
Maximum value of SAR (measured) = 12.5 W/kg

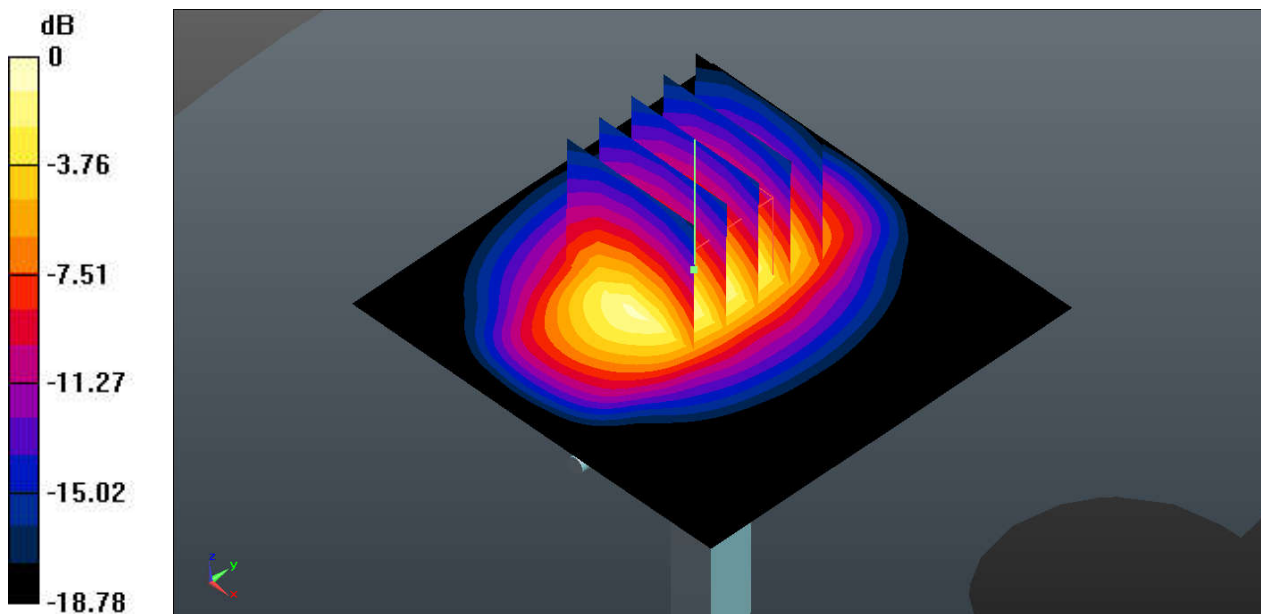

0 dB = $12.5 \text{ W/kg} = 10.97 \text{ dBW/kg}$

System Check_Head_2450MHz

DUT: D2450V2 - SN:908

Communication System: UID 0, CW (0); Frequency: 2450 MHz; Duty Cycle: 1:1
Medium: HSL_2450 Medium parameters used: $f = 2450$ MHz; $\sigma = 1.762$ S/m; $\epsilon_r = 40.678$;
 $\rho = 1000$ kg/m³
Ambient Temperature : 23.3 °C ; Liquid Temperature : 22.8 °C

DASY5 Configuration:

- Probe: EX3DV4 - SN3843; ConvF(7.06, 7.06, 7.06); Calibrated: 2019.9.26
- Sensor-Surface: 1.4mm (Mechanical Surface Detection)
- Electronics: DAE4 Sn1358; Calibrated: 2019.4.17
- Phantom: SAM2; Type: SAM; Serial: TP-1503
- Measurement SW: DASY52, Version 52.10 (1); SEMCAD X Version 14.6.11 (7439)

Pin=250mW/Area Scan (71x71x1): Interpolated grid: dx=1.200 mm, dy=1.200 mm
Maximum value of SAR (interpolated) = 17.6 W/kg

Pin=250mW/Zoom Scan (7x7x7)/Cube 0: Measurement grid: dx=5mm, dy=5mm, dz=5mm
Reference Value = 101.9 V/m; Power Drift = -0.09 dB
Peak SAR (extrapolated) = 27.2 W/kg
SAR(1 g) = 12.6 W/kg; SAR(10 g) = 5.67 W/kg
Maximum value of SAR (measured) = 16.8 W/kg

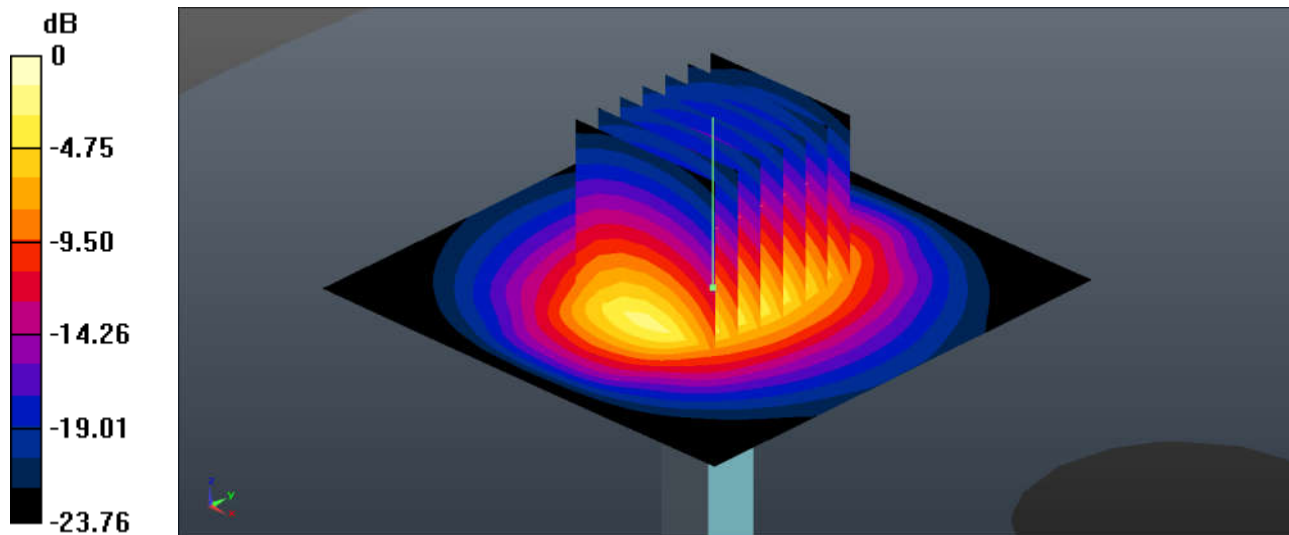

0 dB = 16.8 W/kg = 12.25 dBW/kg

System Check_Head_2600MHz

DUT: D2600V2 - SN:1061

Communication System: UID 0, CW (0); Frequency: 2600 MHz; Duty Cycle: 1:1
Medium: HSL_2600 Medium parameters used: $f = 2600$ MHz; $\sigma = 2.027$ S/m; $\epsilon_r = 37.857$;
 $\rho = 1000$ kg/m³
Ambient Temperature : 23.1 °C; Liquid Temperature : 22.9 °C

DASY5 Configuration:

- Probe: EX3DV4 - SN3843; ConvF(6.9, 6.9, 6.9); Calibrated: 2019.9.26
- Sensor-Surface: 1.4mm (Mechanical Surface Detection)
- Electronics: DAE4 Sn1358; Calibrated: 2019.4.17
- Phantom: SAM1; Type: SAM; Serial: TP-1697
- Measurement SW: DASY52, Version 52.10 (1); SEMCAD X Version 14.6.11 (7439)

Pin=250mW/Area Scan (81x81x1): Interpolated grid: dx=1.200 mm, dy=1.200 mm
Maximum value of SAR (interpolated) = 25.1 W/kg

Pin=250mW/Zoom Scan (7x7x7)/Cube 0: Measurement grid: dx=5mm, dy=5mm, dz=5mm
Reference Value = 116.2 V/m; Power Drift = -0.11 dB
Peak SAR (extrapolated) = 31.8 W/kg
SAR(1 g) = 14.3 W/kg; SAR(10 g) = 6.56 W/kg
Maximum value of SAR (measured) = 25.3 W/kg

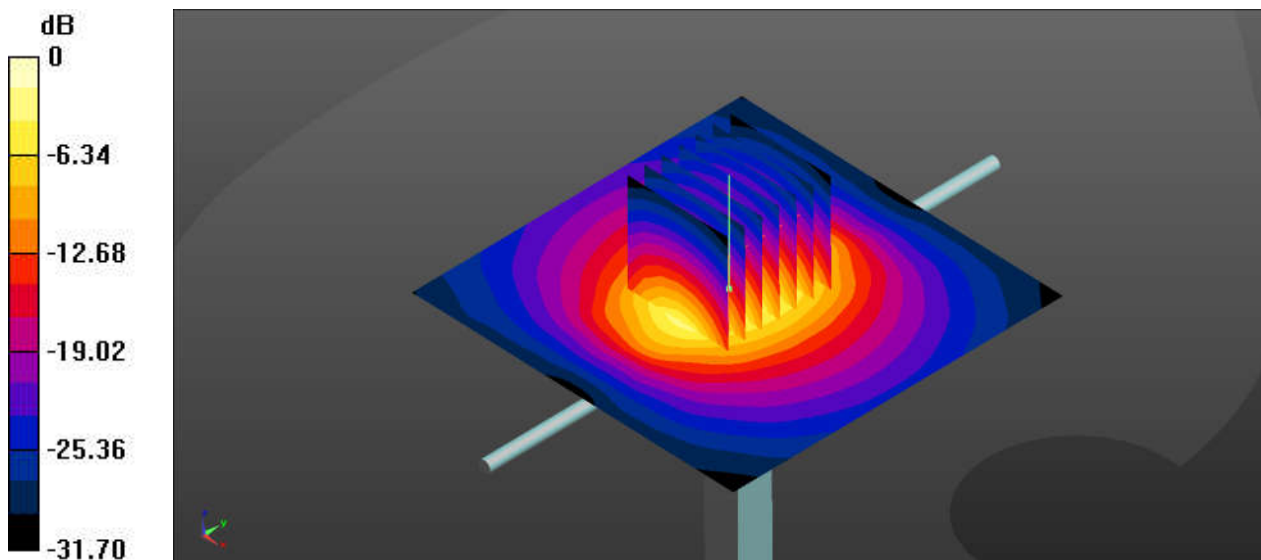

0 dB = 25.1 W/kg = 14.00 dBW/kg

System Check_Head_5250MHz

DUT: D5GHzV2 - SN:1113

Communication System: UID 0, CW (0); Frequency: 5250 MHz; Duty Cycle: 1:1

Medium: HSL_5000 Medium parameters used: $f = 5250$ MHz; $\sigma = 4.678$ S/m; $\epsilon_r = 36.999$; $\rho = 1000$ kg/m³

Ambient Temperature : 23.2 °C; Liquid Temperature : 22.6 °C

DASY5 Configuration:

- Probe: EX3DV4 - SN7592; ConvF(5.24, 5.24, 5.24); Calibrated: 2020.5.22
- Sensor-Surface: 1.4mm (Mechanical Surface Detection)
- Electronics: DAE4 Sn799; Calibrated: 2020.2.10
- Phantom: SAM1; Type: SAM; Serial: TP-1753
- Measurement SW: DASY52, Version 52.10 (4); SEMCAD X Version 14.6.14 (7483)

Pin=100mW/Area Scan (71x71x1): Interpolated grid: dx=1.000 mm, dy=1.000 mm

Maximum value of SAR (interpolated) = 20.2 W/kg

Pin=100mW/Zoom Scan (8x8x7)/Cube 0: Measurement grid: dx=4mm, dy=4mm, dz=1.4mm

Reference Value = 44.69 V/m; Power Drift = 0.02 dB

Peak SAR (extrapolated) = 31.2 W/kg

SAR(1 g) = 8.59 W/kg; SAR(10 g) = 2.53 W/kg

Maximum value of SAR (measured) = 19.0 W/kg

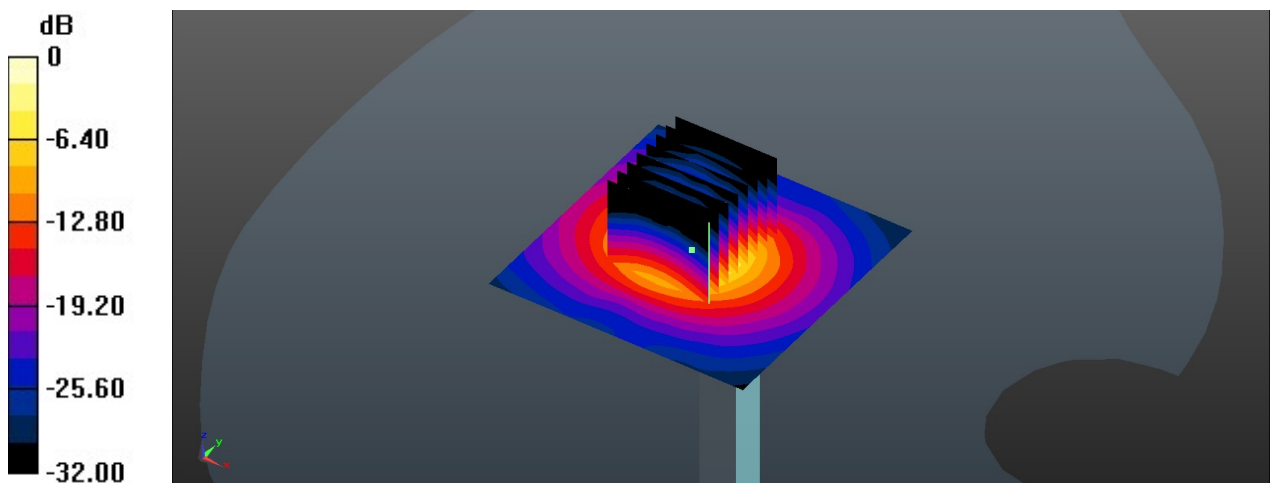

0 dB = 19.0 W/kg = 12.79 dBW/kg

System Check_Head_5600MHz

DUT: D5GHzV2 - SN:1113

Communication System: UID 0, CW (0); Frequency: 5600 MHz; Duty Cycle: 1:1

Medium: HSL_5000 Medium parameters used: $f = 5600$ MHz; $\sigma = 5.037$ S/m; $\epsilon_r = 36.493$; $\rho = 1000$ kg/m³

Ambient Temperature : 23.2 °C; Liquid Temperature : 22.9 °C

DASY5 Configuration:

- Probe: EX3DV4 - SN7592; ConvF(4.65, 4.65, 4.65); Calibrated: 2020.5.22
- Sensor-Surface: 1.4mm (Mechanical Surface Detection)
- Electronics: DAE4 Sn799; Calibrated: 2020.2.10
- Phantom: SAM1; Type: SAM; Serial: TP-1753
- Measurement SW: DASY52, Version 52.10 (4); SEMCAD X Version 14.6.14 (7483)

Pin=100mW/Area Scan (71x71x1): Interpolated grid: dx=1.000 mm, dy=1.000 mm

Maximum value of SAR (interpolated) = 21.3 W/kg

Pin=100mW/Zoom Scan (8x8x7)/Cube 0: Measurement grid: dx=4mm, dy=4mm, dz=1.4mm

Reference Value = 43.15 V/m; Power Drift = 0.16 dB

Peak SAR (extrapolated) = 34.0 W/kg

SAR(1 g) = 8.83 W/kg; SAR(10 g) = 2.58 W/kg

Maximum value of SAR (measured) = 20.2 W/kg

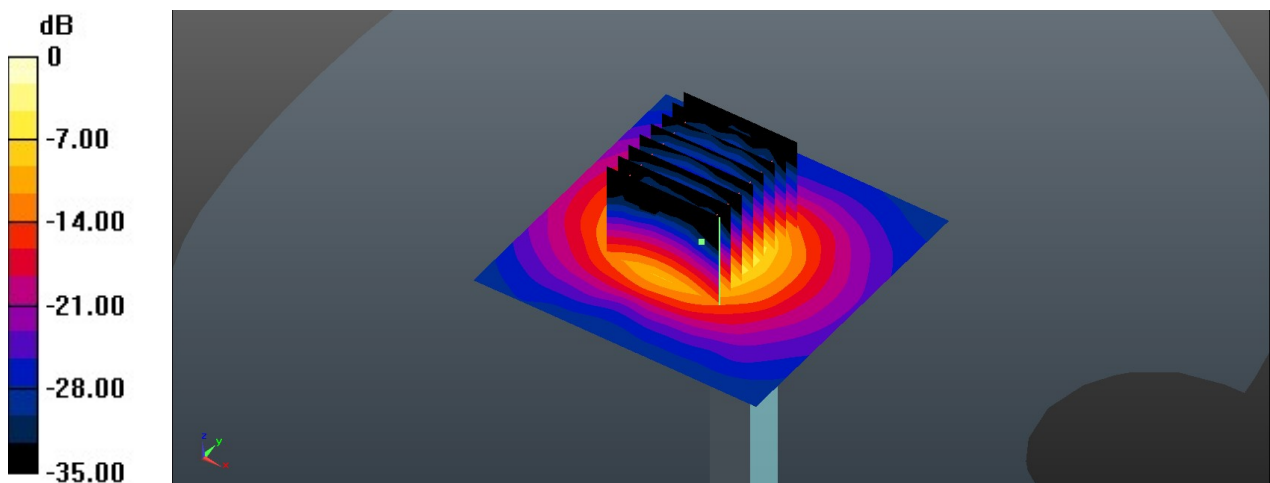

0 dB = 20.2 W/kg = 13.05 dBW/kg

System Check_Head_5750MHz

DUT: D5GHzV2 - SN:1113

Communication System: UID 0, CW (0); Frequency: 5750 MHz; Duty Cycle: 1:1

Medium: HSL_5000 Medium parameters used: $f = 5750$ MHz; $\sigma = 5.2$ S/m; $\epsilon_r = 36.307$; $\rho = 1000$ kg/m³

Ambient Temperature : 23.3 °C; Liquid Temperature : 22.7 °C

DASY5 Configuration:

- Probe: EX3DV4 - SN7592; ConvF(4.69, 4.69, 4.69); Calibrated: 2020.5.22
- Sensor-Surface: 1.4mm (Mechanical Surface Detection)
- Electronics: DAE4 Sn799; Calibrated: 2020.2.10
- Phantom: SAM1; Type: SAM; Serial: TP-1753
- Measurement SW: DASY52, Version 52.10 (4); SEMCAD X Version 14.6.14 (7483)

Pin=100mW/Area Scan (71x71x1): Interpolated grid: dx=1.000 mm, dy=1.000 mm

Maximum value of SAR (interpolated) = 19.3 W/kg

Pin=100mW/Zoom Scan (8x8x7)/Cube 0: Measurement grid: dx=4mm, dy=4mm, dz=1.4mm

Reference Value = 39.38 V/m; Power Drift = 0.17 dB

Peak SAR (extrapolated) = 31.7 W/kg

SAR(1 g) = 7.98 W/kg; SAR(10 g) = 2.32 W/kg

Maximum value of SAR (measured) = 18.3 W/kg

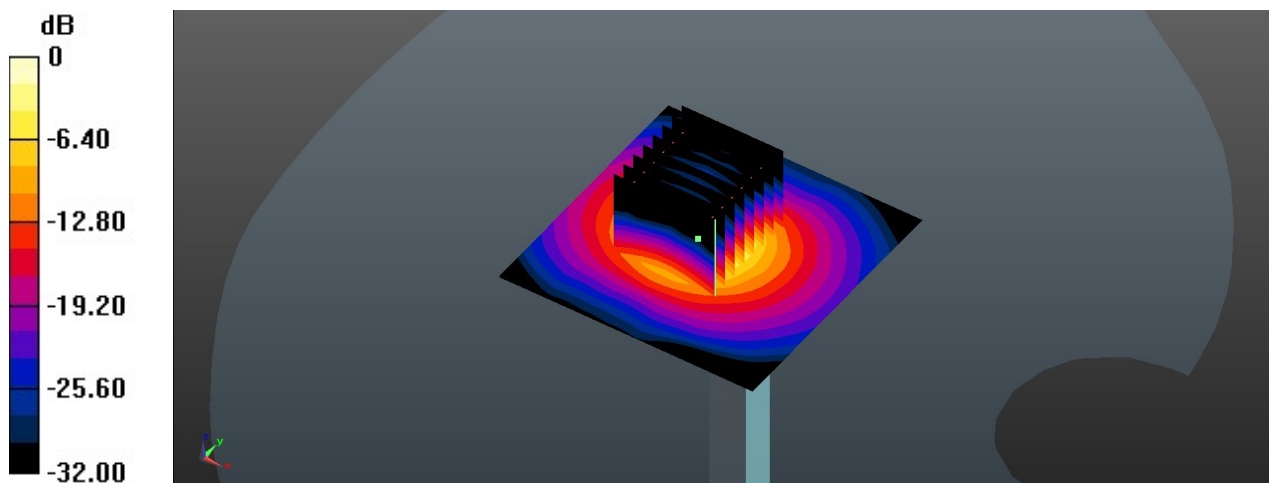

0 dB = 18.3 W/kg = 12.62 dBW/kg



Appendix B. Plots of High SAR Measurement

The plots are shown as follows.

01_GSM850_GPRS 4 Tx slot_Right Cheek_0mm_Ch251

Communication System: UID 0, GSM850-4UP (0); Frequency: 848.8 MHz; Duty Cycle: 1:2.08
Medium: HSL_850 Medium parameters used: $f = 849$ MHz; $\sigma = 0.925$ S/m; $\epsilon_r = 42.522$; $\rho = 1000$ kg/m³
Ambient Temperature : 23.2 °C; Liquid Temperature : 22.8 °C

DASY5 Configuration:

- Probe: EX3DV4 - SN3843; ConvF(9.07, 9.07, 9.07); Calibrated: 2019.9.26
- Sensor-Surface: 1.4mm (Mechanical Surface Detection)
- Electronics: DAE4 Sn1358; Calibrated: 2019.4.17
- Phantom: SAM2; Type: SAM; Serial: TP-1503
- Measurement SW: DASY52, Version 52.10 (1); SEMCAD X Version 14.6.11 (7439)

Ch251/Area Scan (71x81x1): Interpolated grid: dx=1.500 mm, dy=1.500 mm

Maximum value of SAR (interpolated) = 0.330 W/kg

Ch251/Zoom Scan (5x5x7)/Cube 0: Measurement grid: dx=8mm, dy=8mm, dz=5mm

Reference Value = 5.048 V/m; Power Drift = -0.05 dB

Peak SAR (extrapolated) = 0.381 W/kg

SAR(1 g) = 0.292 W/kg; SAR(10 g) = 0.216 W/kg

Maximum value of SAR (measured) = 0.323 W/kg

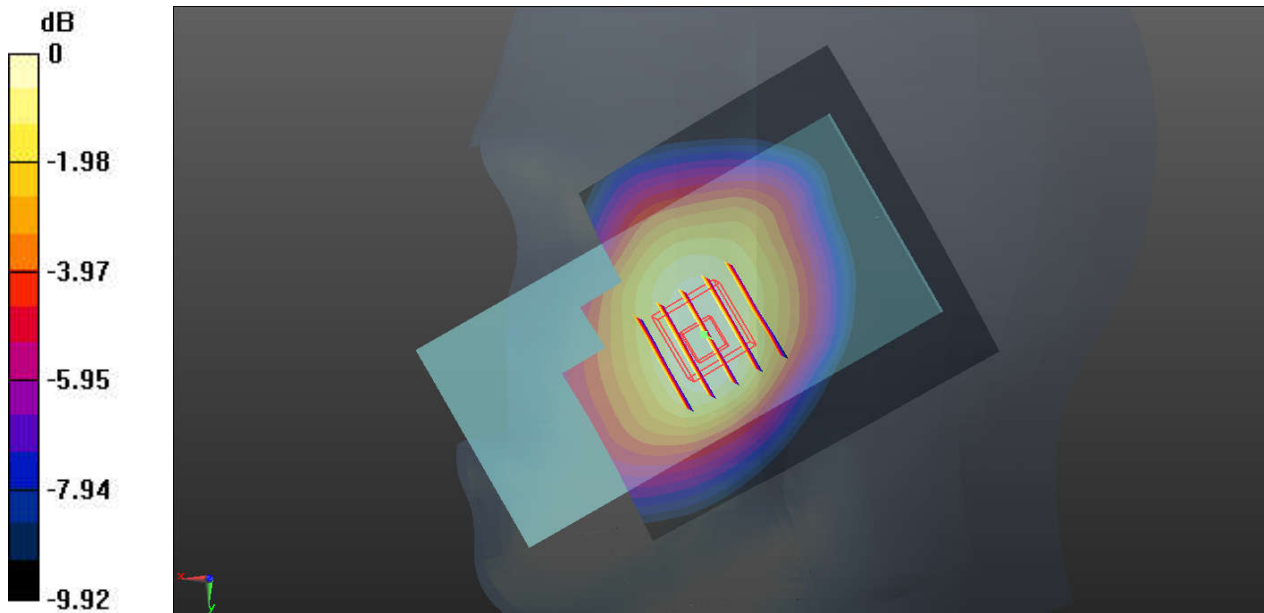

0 dB = 0.323 W/kg = -4.91 dBW/kg

02_GSM1900_GPRS 4 Tx slot_Left Cheek_0mm_Ch810

Communication System: UID 0, PCS-4UP (0); Frequency: 1909.8 MHz; Duty Cycle: 1:2.08
Medium: HSL_1900 Medium parameters used: $f = 1910$ MHz; $\sigma = 1.414$ S/m; $\epsilon_r = 39.451$; $\rho = 1000$ kg/m³
Ambient Temperature : 23.2 °C; Liquid Temperature : 22.8 °C

DASY5 Configuration:

- Probe: EX3DV4 - SN3843; ConvF(7.67, 7.67, 7.67); Calibrated: 2019.9.26
- Sensor-Surface: 1.4mm (Mechanical Surface Detection)
- Electronics: DAE4 Sn1358; Calibrated: 2019.4.17
- Phantom: SAM2; Type: SAM; Serial: TP-1503
- Measurement SW: DASY52, Version 52.10 (1); SEMCAD X Version 14.6.11 (7439)

Ch810/Area Scan (71x81x1): Interpolated grid: dx=1.500 mm, dy=1.500 mm

Maximum value of SAR (interpolated) = 0.247 W/kg

Ch810/Zoom Scan (5x5x7)/Cube 0: Measurement grid: dx=8mm, dy=8mm, dz=5mm

Reference Value = 4.779 V/m; Power Drift = 0.06 dB

Peak SAR (extrapolated) = 0.330 W/kg

SAR(1 g) = 0.211 W/kg; SAR(10 g) = 0.129 W/kg

Maximum value of SAR (measured) = 0.250 W/kg

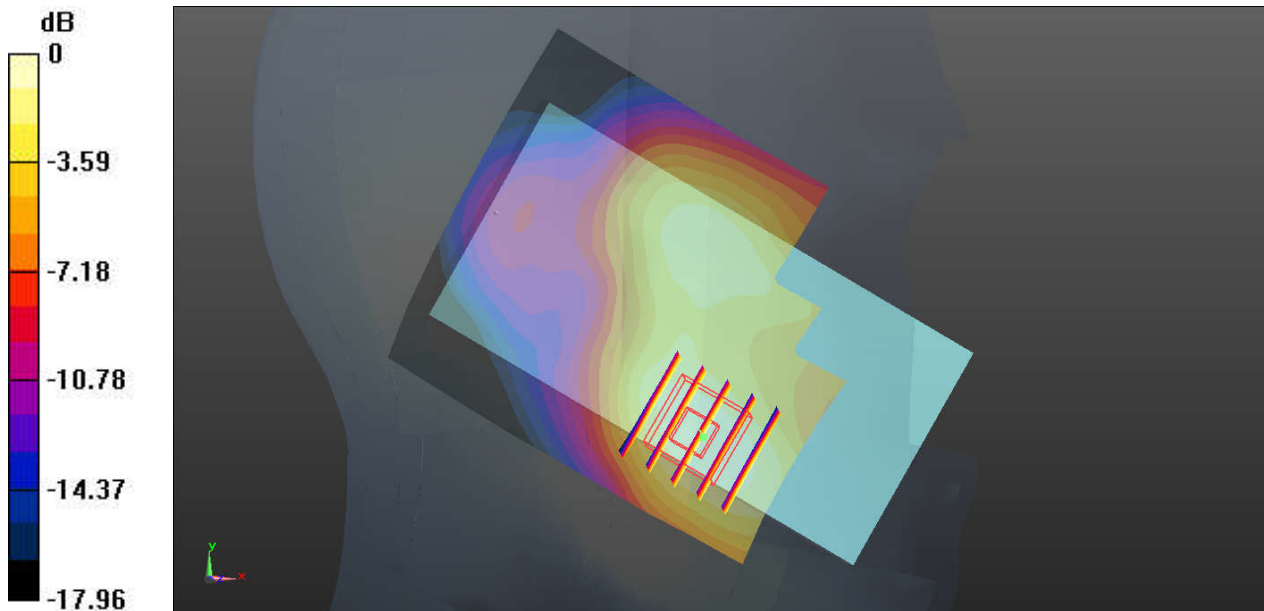

0 dB = 0.250 W/kg = -6.02 dBW/kg

03_WCDMA II_RMC 12.2Kbps_Right Cheek_0mm_Ch9262

Communication System: UID 0, WCDMA (0); Frequency: 1852.4 MHz; Duty Cycle: 1:1
Medium: HSL_1900 Medium parameters used: $f = 1852.4$ MHz; $\sigma = 1.352$ S/m; $\epsilon_r = 39.716$; $\rho = 1000$ kg/m³
Ambient Temperature : 23.2 °C; Liquid Temperature : 22.8 °C

DASY5 Configuration:

- Probe: EX3DV4 - SN3843; ConvF(7.67, 7.67, 7.67); Calibrated: 2019.9.26
- Sensor-Surface: 1.4mm (Mechanical Surface Detection)
- Electronics: DAE4 Sn1358; Calibrated: 2019.4.17
- Phantom: SAM2; Type: SAM; Serial: TP-1503
- Measurement SW: DASY52, Version 52.10 (1); SEMCAD X Version 14.6.11 (7439)

Ch9262/Area Scan (71x71x1): Interpolated grid: dx=1.500 mm, dy=1.500 mm

Maximum value of SAR (interpolated) = 0.404 W/kg

Ch9262/Zoom Scan (5x5x7)/Cube 0: Measurement grid: dx=8mm, dy=8mm, dz=5mm

Reference Value = 6.802 V/m; Power Drift = -0.09 dB

Peak SAR (extrapolated) = 0.524 W/kg

SAR(1 g) = 0.324 W/kg; SAR(10 g) = 0.190 W/kg

Maximum value of SAR (measured) = 0.388 W/kg

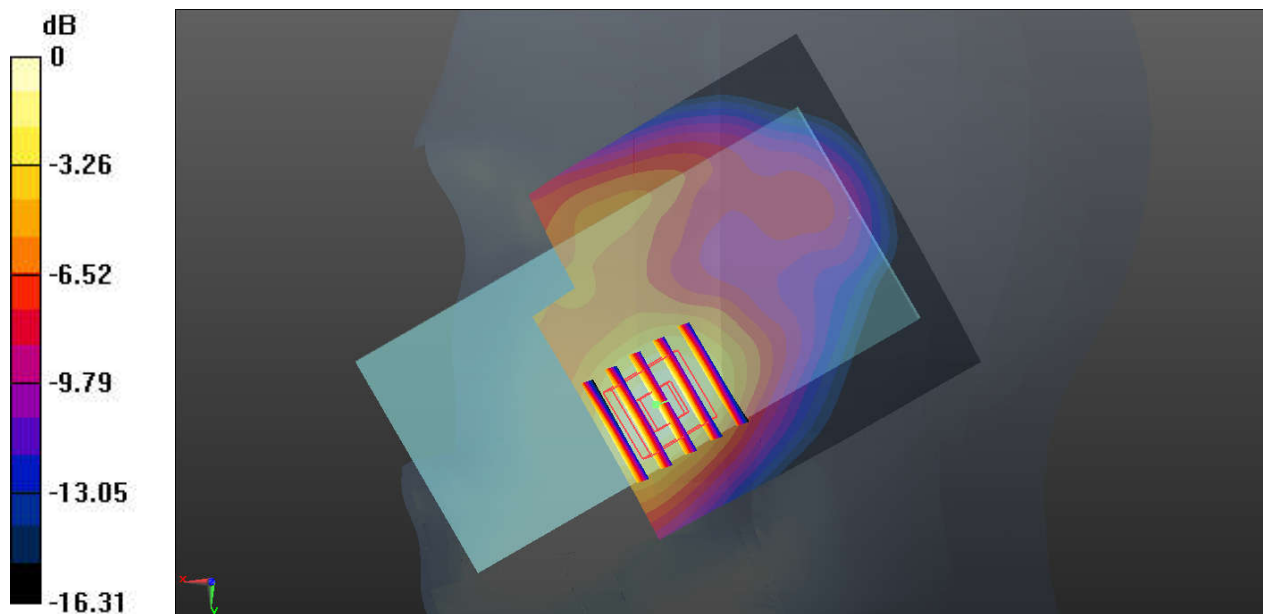

0 dB = 0.388 W/kg = -4.11 dBW/kg

04_WCDMA V_RMC 12.2Kbps_Right Cheek_0mm_Ch4233

Communication System: UID 0, WCDMA (0); Frequency: 846.6 MHz; Duty Cycle: 1:1
Medium: HSL_850 Medium parameters used: $f = 847 \text{ MHz}$; $\sigma = 0.923 \text{ S/m}$; $\epsilon_r = 42.546$; $\rho = 1000 \text{ kg/m}^3$
Ambient Temperature : $23.2 \text{ }^\circ\text{C}$; Liquid Temperature : $22.8 \text{ }^\circ\text{C}$

DASY5 Configuration:

- Probe: EX3DV4 - SN3843; ConvF(9.07, 9.07, 9.07); Calibrated: 2019.9.26
- Sensor-Surface: 1.4mm (Mechanical Surface Detection)
- Electronics: DAE4 Sn1358; Calibrated: 2019.4.17
- Phantom: SAM2; Type: SAM; Serial: TP-1503
- Measurement SW: DASY52, Version 52.10 (1); SEMCAD X Version 14.6.11 (7439)

Ch4233/Area Scan (71x81x1): Interpolated grid: $dx=1.500 \text{ mm}$, $dy=1.500 \text{ mm}$

Maximum value of SAR (interpolated) = 0.230 W/kg

Ch4233/Zoom Scan (5x5x7)/Cube 0: Measurement grid: $dx=8\text{mm}$, $dy=8\text{mm}$, $dz=5\text{mm}$

Reference Value = 5.279 V/m ; Power Drift = -0.18 dB

Peak SAR (extrapolated) = 0.269 W/kg

SAR(1 g) = 0.208 W/kg ; SAR(10 g) = 0.153 W/kg

Maximum value of SAR (measured) = 0.232 W/kg

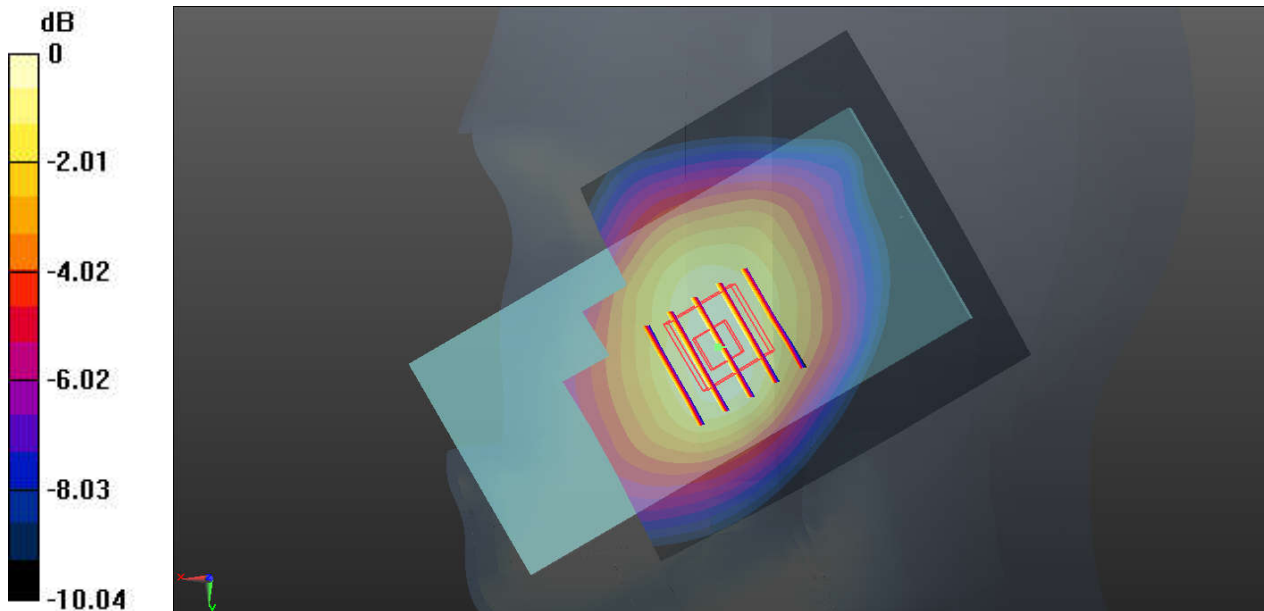

0 dB = $0.232 \text{ W/kg} = -6.35 \text{ dBW/kg}$

05_LTE Band 7_20M_QPSK_1RB_0Offset_Right Cheek_0mm_Ch21100

Communication System: UID 0, LTE-FDD (0); Frequency: 2535 MHz; Duty Cycle: 1:1
Medium: HSL_2600 Medium parameters used: $f = 2535$ MHz; $\sigma = 1.951$ S/m; $\epsilon_r = 38.117$; $\rho = 1000$ kg/m³
Ambient Temperature : 23.1 °C; Liquid Temperature : 22.9 °C

DASY5 Configuration:

- Probe: EX3DV4 - SN3843; ConvF(6.9, 6.9, 6.9); Calibrated: 2019.9.26
- Sensor-Surface: 1.4mm (Mechanical Surface Detection)
- Electronics: DAE4 Sn1358; Calibrated: 2019.4.17
- Phantom: SAM1; Type: SAM; Serial: TP-1697
- Measurement SW: DASY52, Version 52.10 (1); SEMCAD X Version 14.6.11 (7439)

Ch21100/Area Scan (91x101x1): Interpolated grid: dx=1.200 mm, dy=1.200 mm
Maximum value of SAR (interpolated) = 0.0823 W/kg

Ch21100/Zoom Scan (7x7x7)/Cube 0: Measurement grid: dx=5mm, dy=5mm, dz=5mm
Reference Value = 1.236 V/m; Power Drift = -0.01 dB
Peak SAR (extrapolated) = 0.126 W/kg
SAR(1 g) = 0.063 W/kg; SAR(10 g) = 0.031 W/kg
Maximum value of SAR (measured) = 0.0793 W/kg

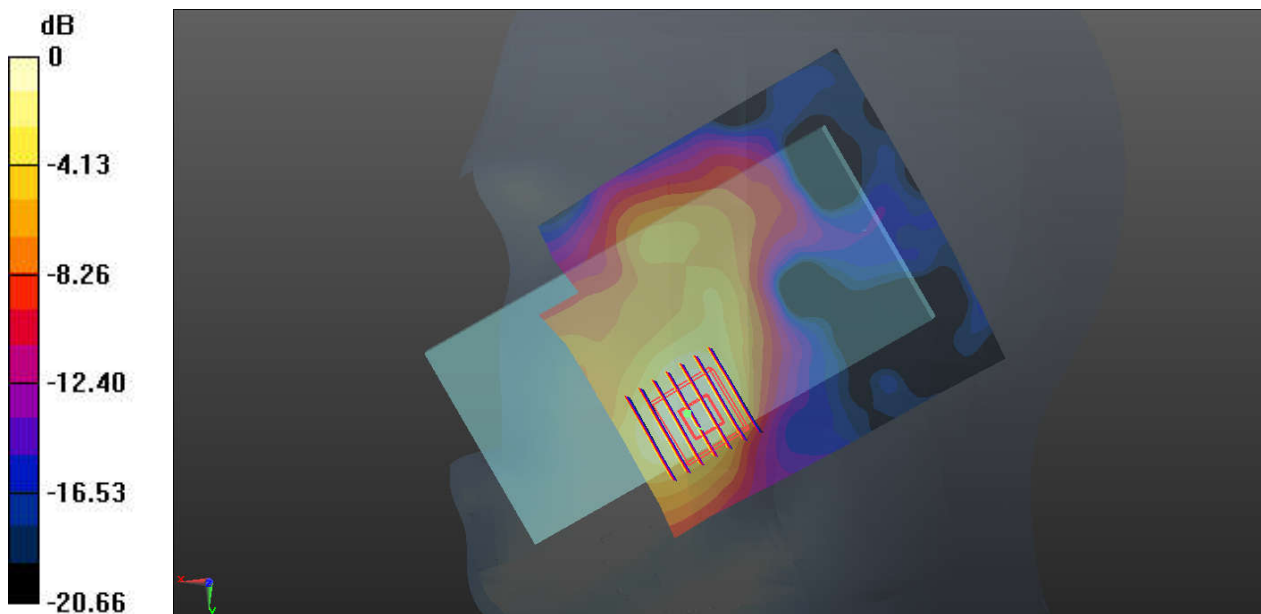

0 dB = 0.0793 W/kg = -11.01 dBW/kg

06_WLAN2.4GHz_802.11b 1Mbps_Right Cheek_0mm_Ch11

Communication System: UID 0, 802.11b (0); Frequency: 2462 MHz; Duty Cycle: 1:1
Medium: HSL_2450 Medium parameters used: $f = 2462$ MHz; $\sigma = 1.776$ S/m; $\epsilon_r = 40.646$; $\rho = 1000$ kg/m³
Ambient Temperature : 23.3 °C ; Liquid Temperature : 22.8 °C

DASY5 Configuration:

- Probe: EX3DV4 - SN3843; ConvF(7.06, 7.06, 7.06); Calibrated: 2019.9.26
- Sensor-Surface: 1.4mm (Mechanical Surface Detection)
- Electronics: DAE4 Sn1358; Calibrated: 2019.4.17
- Phantom: SAM2; Type: SAM; Serial: TP-1503
- Measurement SW: DASY52, Version 52.10 (1); SEMCAD X Version 14.6.11 (7439)

Ch11/Area Scan (81x81x1): Interpolated grid: dx=1.200 mm, dy=1.200 mm
Maximum value of SAR (interpolated) = 0.240 W/kg

Ch11/Zoom Scan (8x8x7)/Cube 0: Measurement grid: dx=5mm, dy=5mm, dz=5mm
Reference Value = 11.31 V/m; Power Drift = 0.04 dB
Peak SAR (extrapolated) = 0.376 W/kg
SAR(1 g) = 0.184 W/kg; SAR(10 g) = 0.102 W/kg
Maximum value of SAR (measured) = 0.231 W/kg

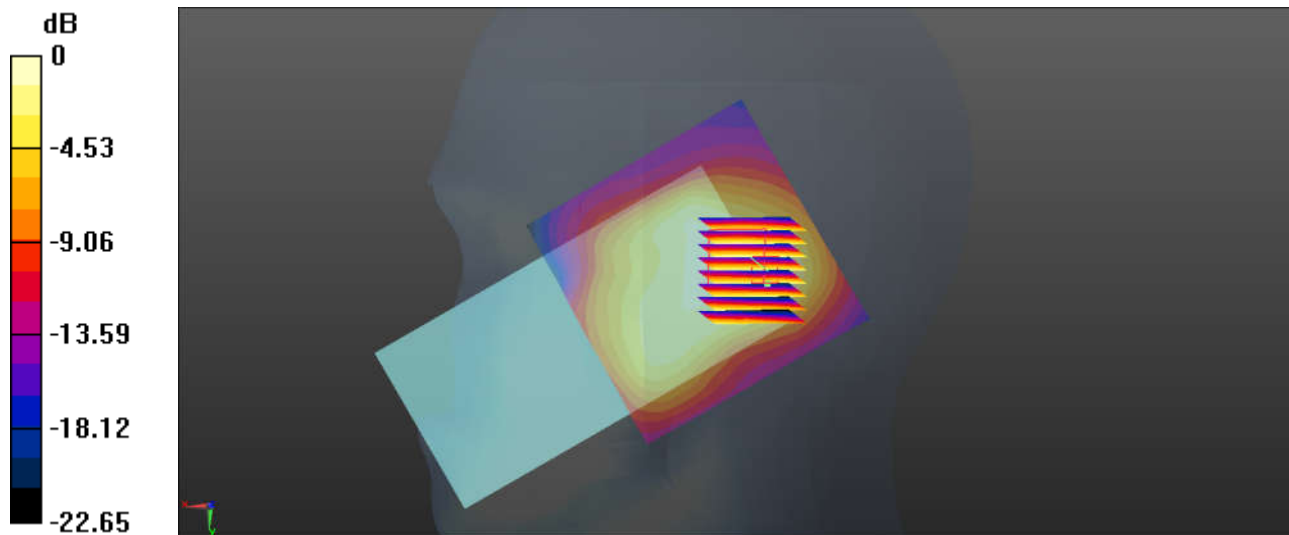

0 dB = 0.231 W/kg = -6.36 dBW/kg

07_Bluetooth_1Mbps_Right Cheek_0mm_Ch39

Communication System: UID 0, Bluetooth (0); Frequency: 2441 MHz; Duty Cycle: 1:1.302
Medium: HSL_2450 Medium parameters used: $f = 2441$ MHz; $\sigma = 1.751$ S/m; $\epsilon_r = 40.709$; $\rho = 1000$ kg/m³
Ambient Temperature : 23.3 °C ; Liquid Temperature : 22.8 °C

DASY5 Configuration:

- Probe: EX3DV4 - SN3843; ConvF(7.06, 7.06, 7.06); Calibrated: 2019.9.26
- Sensor-Surface: 1.4mm (Mechanical Surface Detection)
- Electronics: DAE4 Sn1358; Calibrated: 2019.4.17
- Phantom: SAM2; Type: SAM; Serial: TP-1503
- Measurement SW: DASY52, Version 52.10 (1); SEMCAD X Version 14.6.11 (7439)

Ch39/Area Scan (91x81x1): Interpolated grid: dx=1.200 mm, dy=1.200 mm
Maximum value of SAR (interpolated) = 0.0196 W/kg

Ch39/Zoom Scan (8x8x7)/Cube 0: Measurement grid: dx=5mm, dy=5mm, dz=5mm
Reference Value = 2.606 V/m; Power Drift = 0.04 dB
Peak SAR (extrapolated) = 0.0310 W/kg
SAR(1 g) = 0.015 W/kg; SAR(10 g) = 0.00793 W/kg
Maximum value of SAR (measured) = 0.0183 W/kg

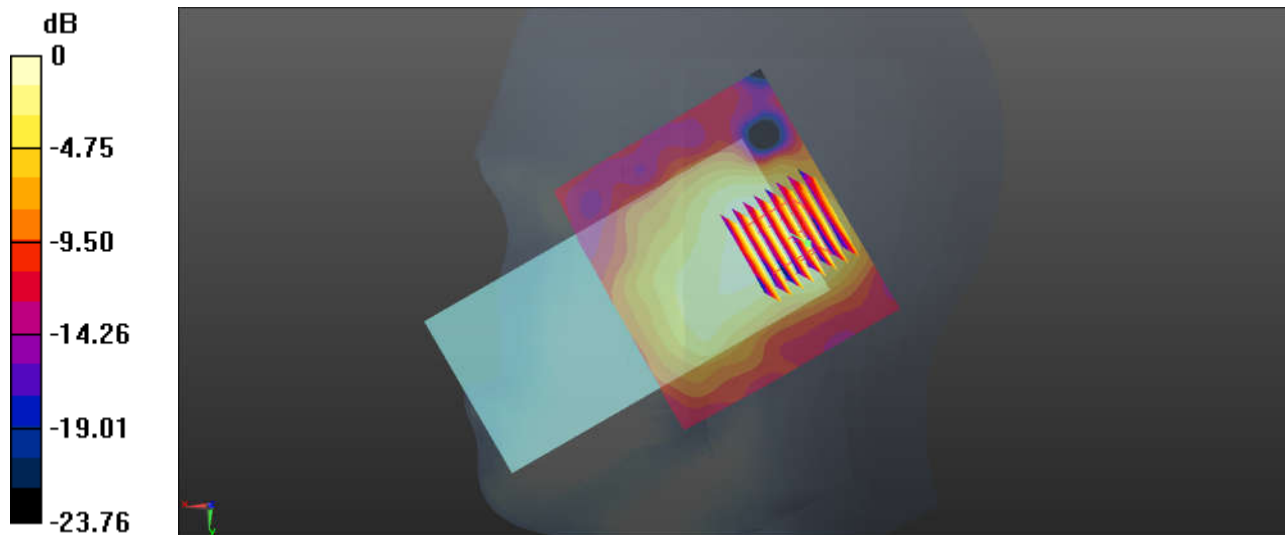

0 dB = 0.0183 W/kg = -17.38 dBW/kg

08_WLAN5GHz_802.11a 6Mbps_Left Tilted_0mm_Ch56

Communication System: UID 0, WLAN5G (0); Frequency: 5280 MHz; Duty Cycle: 1:1.026
Medium: HSL_5000 Medium parameters used: $f = 5280$ MHz; $\sigma = 4.711$ S/m; $\epsilon_r = 36.95$; $\rho = 1000$ kg/m³

Ambient Temperature : 23.2 °C; Liquid Temperature : 22.6 °C

DASY5 Configuration:

- Probe: EX3DV4 - SN7592; ConvF(5.24, 5.24, 5.24); Calibrated: 2020.5.22
- Sensor-Surface: 1.4mm (Mechanical Surface Detection)
- Electronics: DAE4 Sn799; Calibrated: 2020.2.10
- Phantom: SAM1; Type: SAM; Serial: TP-1753
- Measurement SW: DASY52, Version 52.10 (4); SEMCAD X Version 14.6.14 (7483)

Ch56/Area Scan (101x91x1): Interpolated grid: dx=1.000 mm, dy=1.000 mm

Maximum value of SAR (interpolated) = 0.574 W/kg

Ch56/Zoom Scan (9x9x7)/Cube 0: Measurement grid: dx=4mm, dy=4mm, dz=1.4mm

Reference Value = 2.380 V/m; Power Drift = -0.06 dB

Peak SAR (extrapolated) = 1.01 W/kg

SAR(1 g) = 0.254 W/kg; SAR(10 g) = 0.073 W/kg

Maximum value of SAR (measured) = 0.625 W/kg

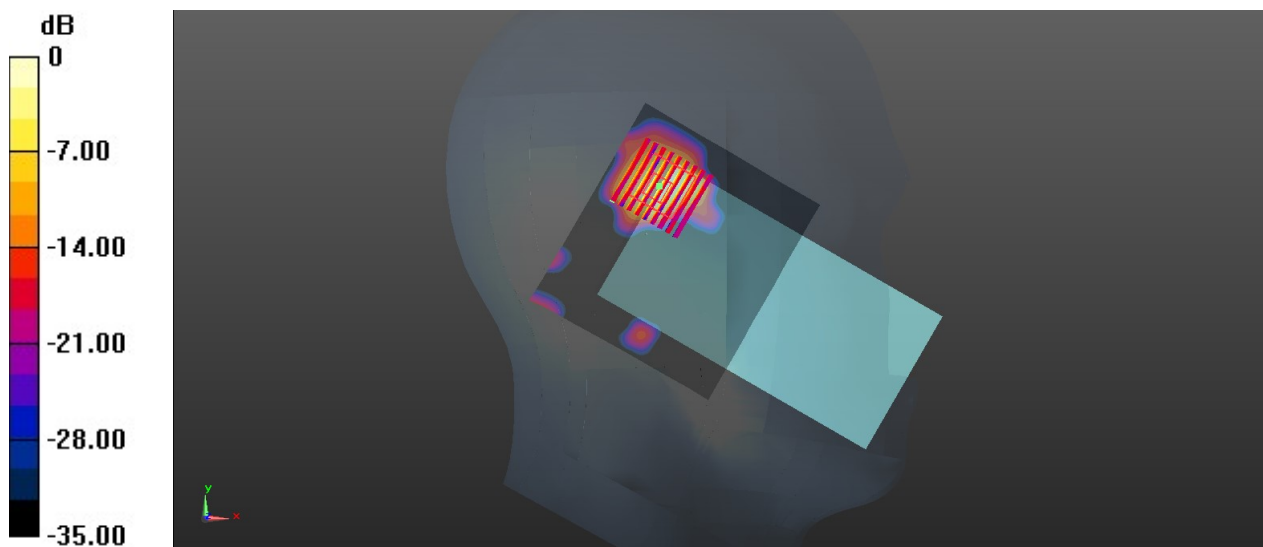

0 dB = 0.625 W/kg = -2.04 dBW/kg

09_WLAN5GHz_802.11a 6Mbps_Right Tilted_0mm_Ch132

Communication System: UID 0, WLAN5G (0); Frequency: 5660 MHz; Duty Cycle: 1:1.026
Medium: HSL_5000 Medium parameters used: $f = 5660$ MHz; $\sigma = 5.1$ S/m; $\epsilon_r = 36.439$; $\rho = 1000$ kg/m³

Ambient Temperature : 23.3 °C; Liquid Temperature : 22.7 °C

DASY5 Configuration:

- Probe: EX3DV4 - SN7592; ConvF(4.69, 4.69, 4.69); Calibrated: 2020.5.22
- Sensor-Surface: 1.4mm (Mechanical Surface Detection)
- Electronics: DAE4 Sn799; Calibrated: 2020.2.10
- Phantom: SAM1; Type: SAM; Serial: TP-1753
- Measurement SW: DASY52, Version 52.10 (4); SEMCAD X Version 14.6.14 (7483)

Ch132/Area Scan (101x91x1): Interpolated grid: dx=1.000 mm, dy=1.000 mm
Maximum value of SAR (interpolated) = 1.03 W/kg

Ch132/Zoom Scan (8x9x7)/Cube 0: Measurement grid: dx=4mm, dy=4mm, dz=1.4mm
Reference Value = 7.029 V/m; Power Drift = -0.01 dB
Peak SAR (extrapolated) = 1.07 W/kg
SAR(1 g) = 0.287 W/kg; SAR(10 g) = 0.095 W/kg
Maximum value of SAR (measured) = 0.686 W/kg

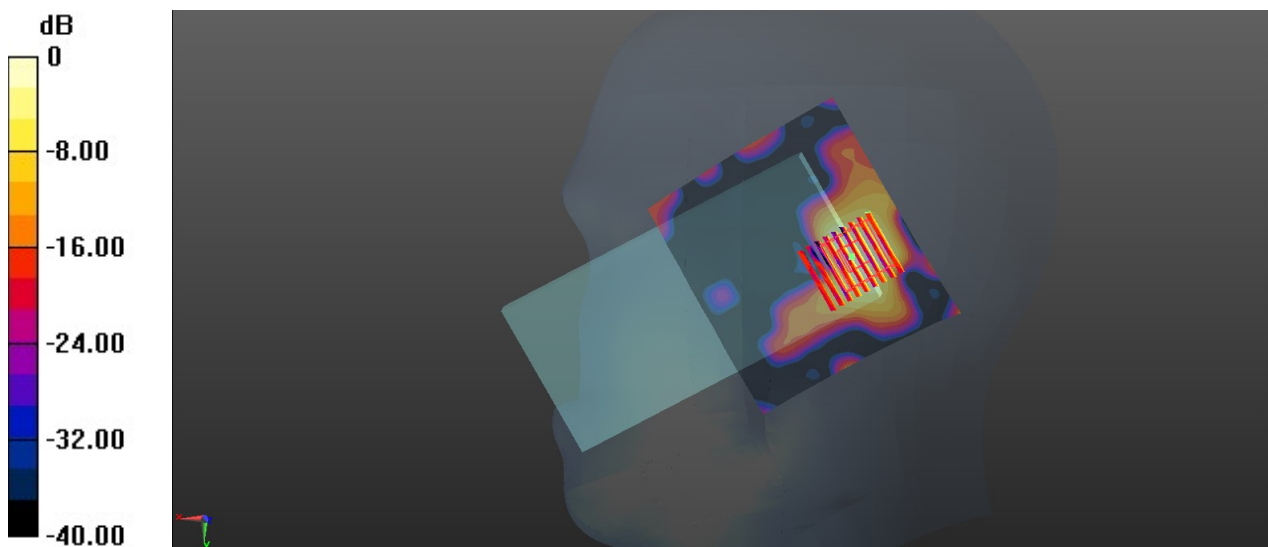

0 dB = 0.686 W/kg = -1.64 dBW/kg

10_WLAN5GHz_802.11n-HT40 MCS0_Left Cheek_0mm_Ch159

Communication System: UID 0, WLAN5G (0); Frequency: 5795 MHz; Duty Cycle: 1:1.061
Medium: HSL_5000 Medium parameters used: $f = 5795$ MHz; $\sigma = 5.238$ S/m; $\epsilon_r = 36.219$; $\rho = 1000$ kg/m³

Ambient Temperature : 23.3 °C; Liquid Temperature : 22.7 °C

DASY5 Configuration:

- Probe: EX3DV4 - SN7592; ConvF(4.69, 4.69, 4.69); Calibrated: 2020.5.22
- Sensor-Surface: 1.4mm (Mechanical Surface Detection)
- Electronics: DAE4 Sn799; Calibrated: 2020.2.10
- Phantom: SAM1; Type: SAM; Serial: TP-1753
- Measurement SW: DASY52, Version 52.10 (4); SEMCAD X Version 14.6.14 (7483)

Ch159/Area Scan (101x91x1): Interpolated grid: dx=1.000 mm, dy=1.000 mm

Maximum value of SAR (interpolated) = 0.704 W/kg

Ch159/Zoom Scan (8x9x7)/Cube 0: Measurement grid: dx=4mm, dy=4mm, dz=1.4mm

Reference Value = 3.057 V/m; Power Drift = -0.15 dB

Peak SAR (extrapolated) = 0.758 W/kg

SAR(1 g) = 0.183 W/kg; SAR(10 g) = 0.053 W/kg

Maximum value of SAR (measured) = 0.488 W/kg

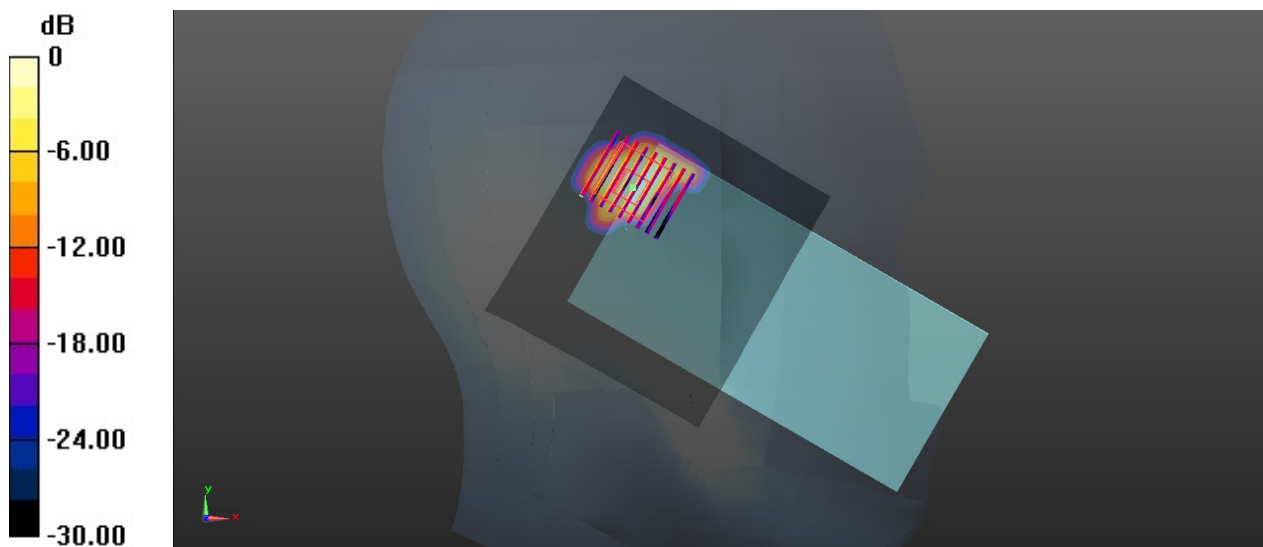

0 dB = 0.488 W/kg = -3.12 dBW/kg

11_GSM850_GPRS 4 Tx slot_Back_10mm_Ch251

Communication System: UID 0, GSM850-4UP (0); Frequency: 848.8 MHz; Duty Cycle: 1:2.08
Medium: HSL_850 Medium parameters used: $f = 849$ MHz; $\sigma = 0.925$ S/m; $\epsilon_r = 42.522$; $\rho = 1000$ kg/m³
Ambient Temperature : 23.2 °C; Liquid Temperature : 22.8 °C

DASY5 Configuration:

- Probe: EX3DV4 - SN3843; ConvF(9.07, 9.07, 9.07); Calibrated: 2019.9.26
- Sensor-Surface: 1.4mm (Mechanical Surface Detection)
- Electronics: DAE4 Sn1358; Calibrated: 2019.4.17
- Phantom: SAM2; Type: SAM; Serial: TP-1503
- Measurement SW: DASY52, Version 52.10 (1); SEMCAD X Version 14.6.11 (7439)

Ch251/Area Scan (71x81x1): Interpolated grid: dx=1.500 mm, dy=1.500 mm

Maximum value of SAR (interpolated) = 0.610 W/kg

Ch251/Zoom Scan (6x12x7)/Cube 0: Measurement grid: dx=8mm, dy=8mm, dz=5mm

Reference Value = 25.55 V/m; Power Drift = 0.04 dB

Peak SAR (extrapolated) = 0.826 W/kg

SAR(1 g) = 0.519 W/kg; SAR(10 g) = 0.389 W/kg

Maximum value of SAR (measured) = 0.572 W/kg

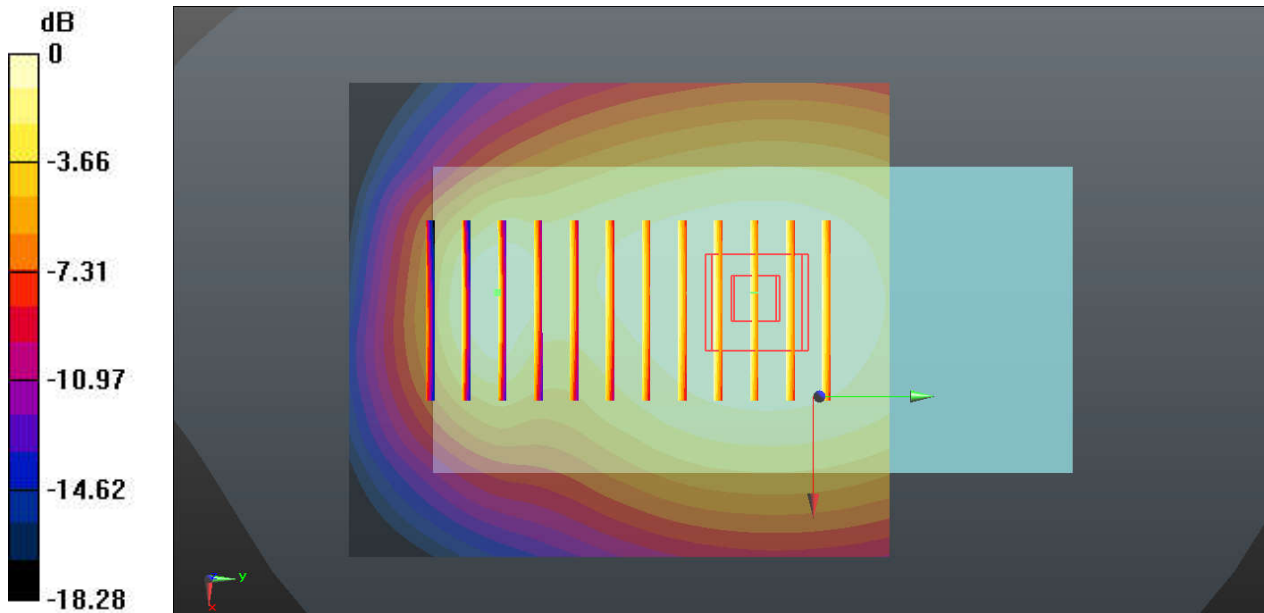

0 dB = 0.572 W/kg = -2.43 dBW/kg

12_GSM1900_GPRS 4 Tx slot_Back_10mm_Ch810

Communication System: UID 0, PCS-4UP (0); Frequency: 1909.8 MHz;Duty Cycle: 1:2.08
Medium: HSL_1900 Medium parameters used: $f = 1910$ MHz; $\sigma = 1.414$ S/m; $\epsilon_r = 39.451$; $\rho = 1000$ kg/m³
Ambient Temperature : 23.2 °C; Liquid Temperature : 22.8 °C

DASY5 Configuration:

- Probe: EX3DV4 - SN3843; ConvF(7.67, 7.67, 7.67); Calibrated: 2019.9.26
- Sensor-Surface: 1.4mm (Mechanical Surface Detection)
- Electronics: DAE4 Sn1358; Calibrated: 2019.4.17
- Phantom: SAM2; Type: SAM; Serial: TP-1503
- Measurement SW: DASY52, Version 52.10 (1); SEMCAD X Version 14.6.11 (7439)

Ch810/Area Scan (71x81x1): Interpolated grid: dx=1.500 mm, dy=1.500 mm

Maximum value of SAR (interpolated) = 0.907 W/kg

Ch810/Zoom Scan (5x5x7)/Cube 0: Measurement grid: dx=8mm, dy=8mm, dz=5mm

Reference Value = 12.68 V/m; Power Drift = -0.01 dB

Peak SAR (extrapolated) = 1.21 W/kg

SAR(1 g) = 0.671 W/kg; SAR(10 g) = 0.363 W/kg

Maximum value of SAR (measured) = 0.837 W/kg

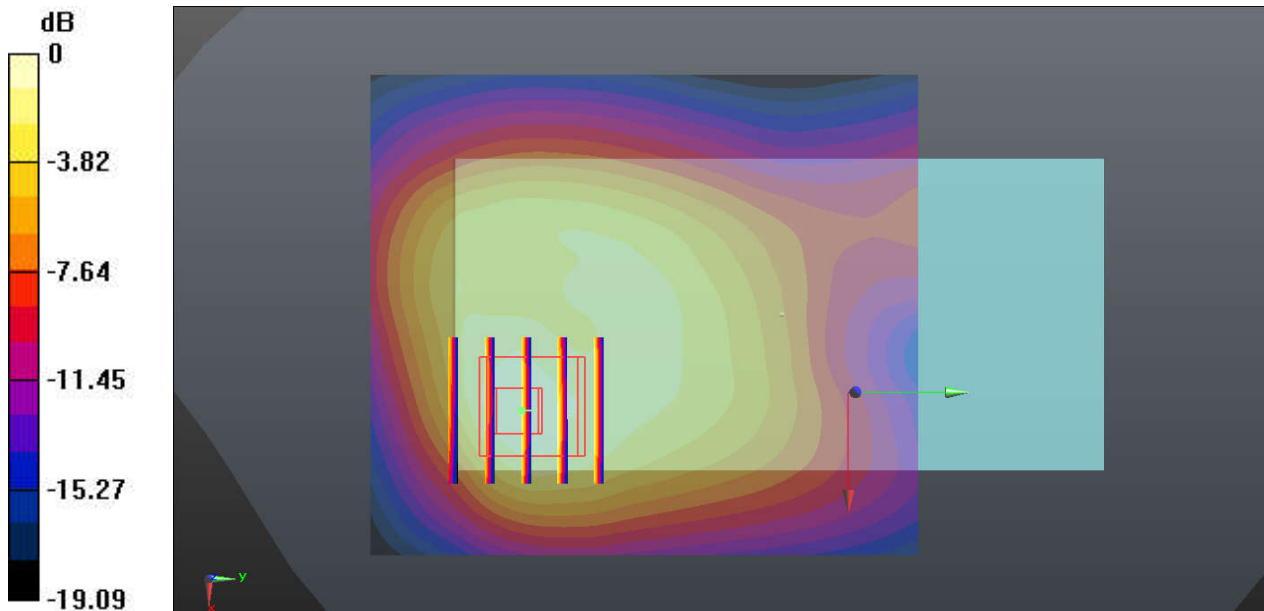

0 dB = 0.837 W/kg = -0.77 dBW/kg