

SAR Test Report

Applicant Name: MobiWire SAS.

Applicant Address: 79 avenue Francois Arago, 92000 NANTERRE France.

The following samples were submitted and identified on behalf of the client as:

Sample Description	MobiWire Mobiprinter
Model Number	MobiPrint²
Market Name	MobiWire
Final Software Version Tested	V00-M121106-MP2-MP
Final Hardware Version Tested	V03
FCC ID	QPN-MOBIPRINT2
Date Initial Sample Received	10-08, 2012
Testing Start Date	10-09, 2012
Testing End Date	10-29, 2012

According to:

FCC 47CFR § 2.1093, IEEE Std C95.1-1991, IEEE Std C95.3-2005

OET Bulletin 65 Supplement C

Comments/ Conclusion:

The configuration tested complied to the certification requirements specified in this report.

Signed for on behalf of SGS

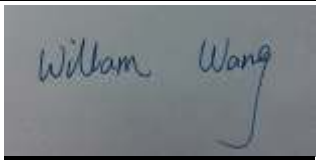
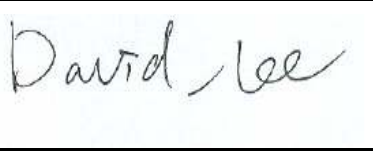
	
Prepared	approved

This document is issued by the Company subject to its General Conditions of Service printed overleaf, available on request or accessible at http://www.sgs.com/terms_and_conditions.htm. And, for electronic format documents to Terms and Conditions for Electronic Documents at www.sgs.com/terms_e-document.htm. Attention is drawn to the limitation of liability, indemnification and jurisdiction issues defined therein. Any holder of this document is advised that information contained hereon reflects the company's findings at the time of its intervention only and within the limits of Client's instructions, if any. The Company's sole responsibility is to its Client and this document does not exonerate parties to a transaction from exercising all their rights and obligation under the transaction documents. This document cannot be reproduced except in full, without prior written approval of the Company. Any unauthorized alteration, forgery or falsification of the content or appearance of this document is unlawful and offenders may be prosecuted to the fullest extent of the law. Unless otherwise stated the results shown in this test report refer only to the sample(s) tested and such sample(s) are retained for 30 days only

SHEMC

Table of Contents

Change History.....	4
1. Report Overview.....	5
2. Test Lab Declaration or Comments	5
3. Applicant Declaration or Comments	5
4. Full Test Report	5
5. Partial Test Report.....	5
6. Measurement Uncertainty.....	5
7. Testing Environment.....	7
8. Primary Test Laboratory	7
9. Details of Applicant	7
10. Details of Manufacturer	7
11. Other testing Locations	8
12. Referenced Documents	8
13. Primary Laboratory Accreditation Details	9
14. Test Equipment Information	10
14.1 SPEAG DASY4.....	10
14.2 The SAR Measurement System.....	11
14.3 Isotropic E-field Probe ES3DV3	13
14.4 RAM Twin Phantom.....	14
14.5 Device Holder for Transmitters	15
15. Detailed Test Results	16
15.1 Summary of Results.....	16
15.2 Maximum Results	18
15.3 Operation Configurations	19
15.4 Measurement procedure.....	21
15.5 Detailed Test Results	22
MobiPrint ² GSM 850+GPRS (1TS) Back Side Middle.....	22
MobiPrint ² GSM 850+GPRS (2TS) Back Side Middle.....	23
MobiPrint ² GSM 850+GPRS(3TS) Back Side Middle.....	24
MobiPrint ² GSM 850+GPRS (4TS) Back Side Middle.....	25
MobiPrint ² GSM 850+GPRS (4TS) Front Side Middle	26
MobiPrint ² GSM 850+GPRS (4TS) Back Side High	27
MobiPrint ² GSM 850+GPRS (4TS) Back Side Low	28
MobiPrint ² GSM 1900+GPRS (1TS) Back Side Middle.....	29
MobiPrint ² GSM 1900+GPRS (2TS) Back Side Middle.....	30
MobiPrint ² GSM 1900+GPRS(3TS) Back Side Middle.....	31
MobiPrint ² GSM 1900+GPRS (4TS) Back Side Middle.....	32
MobiPrint ² GSM 1900+GPRS(4TS) Front Side Middle	33
MobiPrint ² GSM 1900+GPRS(4TS) Back Side High	34
MobiPrint ² GSM 1900+GPRS(4TS) Back Side Low	35

SHEMC

MobiPrint ² 802.11b Back Side High	37
MobiPrint ² 802.11b Front Side High.....	38
MobiPrint ² 802.11g Front Side High.....	39
16. Identification of Samples.....	41
17. Photographs of EUT.....	42
Annex A Photographs of Test Setup.....	43
Annex B Tissue Simulant Liquid	45
Annex B.1 Recipes for Tissue Simulant Liquid	45
Annex B.2 Measurement for Tissue Simulant Liquid.....	46
Annex C SAR System Validation	47
System Performance Check at 835MHz Body	49
System Performance Check at 1900 MHz Body	50
System Performance Check at 2450MHzBody	52
System Performance Check at 2450MHzBody	52
Annex D Calibration certificate.....	54
Annex D.2 DAE Calibration certification	65
END OF REPORT.....	93

Change History

Version	Change Contents	Author	Date
V1.0	First edition	willam_wang	10-31, 2012

1. Report Overview

This report details the results of testing carried out on the samples listed in section 17, the results contained in this test report do not relate to other samples of the same product. The manufacturer should ensure that all products in series production are in conformity with the product sample detailed in this report.

This report may only be reproduced and distributed in full. If the product in this test report is used in any configuration other than that detailed in the test report, the manufacturer must ensure the new configuration complies with all relevant standards and certification requirements. Any mention of SGS Shanghai EMC lab or testing done by SGS Shanghai EMC lab made in connection with the distribution or use of the tested product must be approved in writing by SGS Shanghai EMC lab.

2. Test Lab Declaration or Comments

None

3. Applicant Declaration or Comments

None

4. Full Test Report

A full test report contains, within the results section, all the applicable test cases from the certification requirements of the permanent reference documents of the listed certification bodies.

5. Partial Test Report

A partial test report contains within the results section a sub-set of all the applicable test cases from the certification requirements of the permanent reference documents of the listed certification bodies.

6. Measurement Uncertainty

Measurements and results are all in compliance with the standards listed in section 12 of this report. All measurements and results are recorded and maintained at the laboratory performing the tests and measurement uncertainties are taken into account when comparing measurements to pass/ fail criteria.

A	b1	c	d	e = f(d,k)	g	i = cxg/e	k
Uncertainty Component	Section	Tol	Prob .	Div.	Ci	1g	Vi
	in P1528	(%)	Dist.		(1g)	ui (%)	(Veff)
Probe calibration	E.2.1	6.3	N	1	1	6.0	∞
Axial isotropy	E.2.2	0.5	R	$\sqrt{3}$	$(1-c_p)^{1/2}$	0.20	∞
hemispherical isotropy	E.2.2	2.6	R	$\sqrt{3}$	$\sqrt{c_p}$	1.06	∞
Boundary effect	E.2.3	0.8	R	$\sqrt{3}$	1	0.46	∞
Linearity	E.2.4	0.6	R	$\sqrt{3}$	1	0.35	∞
System detection limit	E.2.5	0.25	R	$\sqrt{3}$	1	0.15	∞
Readout electronics	E.2.6	0.3	N	1	1	0.3	∞
Response time	E.2.7	0	R	$\sqrt{3}$	1	0	∞
Integration time	E.2.8	2.6	R	$\sqrt{3}$	1	1.5	∞
RF ambient Condition –Noise	E.6.1	3	R	$\sqrt{3}$	1	1.73	∞
RF ambient Condition - reflections	E.6.1	3	R	$\sqrt{3}$	1	1.73	∞
Probe positioning- mechanical tolerance	E.6.2	1.5	R	$\sqrt{3}$	1	0.87	∞
Probe positioning- with respect to phantom	E.6.3	2.9	R	$\sqrt{3}$	1	1.67	∞
Max. SAR evaluation	E.5.2	1	R	$\sqrt{3}$	1	0.58	∞
Test sample positioning	E.4.2	4	N	1	1	3.7	9
Device holder uncertainty	E.4.1	3.6	N	1	1	3.6	∞
Output power variation –SAR drift measurement	6.62	5	R	$\sqrt{3}$	1	2.89	∞
Phantom uncertainty (shape and thickness tolerances)	E.3.1	4	R	$\sqrt{3}$	1	2.31	∞
Liquid conductivity - deviation from target values	E.3.2	5	R	$\sqrt{3}$	0.64	1.85	∞
Liquid conductivity - measurement uncertainty	E.3.2	4	N	1	0.64	2.56	5
Liquid permittivity - deviation from target values	E.3.3	5	R	$\sqrt{3}$	0.6	1.73	∞
Liquid permittivity - measurement uncertainty	E.3.3	4	N	1	0.6	2.40	5
Combined standard uncertainty	RSS					10.43	430

Expanded uncertainty (95% CONFIDENCE INTERVAL)	K=2	20.86
---	-----	-------

7. Testing Environment

Normal Temperature	+20 to +24 °C
Relative Humidity	35 to 60 %

8. Primary Test Laboratory

Name:	SGS-CSTC Standards Technical Services(Shanghai) Co., Ltd
Address:	No.588, West Jindu Road, Songjiang District, Shanghai, China 201612
Telephone:	+86 (0) 21 6191 5664
Fax:	+86 (0) 21 6191 5678
Internet:	http://www.cn.sgs.com
Contact:	Mr. David.Lee
Email:	David-jc.lee@sgs.com

9. Details of Applicant

Name:	MobiWire SAS
Address:	79 avenue Francois Arago, 92000 NANTERRE France
Telephone:	33688018722
Fax:	/
Contact:	Thomas CREPIN
Email:	thomas.crepin@mobiwire.com

10. Details of Manufacturer

Name:	MOBIWIRE MOBILES (NINGBO) Co. · Ltd
Address:	No.999,Dacheng East Road,Fenghua City,Zhejiang
Telephone:	0574 88916450
Fax:	0574 88918949
Contact:	Xu linzhong
Email:	linzhong.xu@mobiwire.com

11. Other testing Locations

Name:	Not Required
Address:	--
Telephone:	--
Contact:	--
Email:	--

12. Referenced Documents

The Equipment under Test (EUT) has been tested at SGS's (own or subcontracted) laboratories according to FCC 47CFR § 2.1093, IEEE Std C95.1-2005, IEEE1528-2003, IEEE Std1528a-2005, OET Bulletin 65 Supplement C,

The following table summarizes the specific reference documents such as harmonized standards or test specifications which were used for testing as SGS's (own or subcontracted) laboratories.

Identity	Document Title	Version
FCC 47CFR § 2.1093	Radiofrequency radiation exposure evaluation: portable devices	2001
IEEE Std C95.1-1991	IEEE Standard for Safety Levels with Respect to Human Exposure to Radio Frequency Electromagnetic Fields, 3 kHz to 300 GHz.	1991
IEEE Std1528-2003	IEEE Recommended Practice for Determining the Peak Spatial-Average Specific Absorption Rate (SAR) in the Human Head from Wireless Communications Devices: Measurement Techniques	2003
IEEE Std1528a-2005	IEEE Recommended Practice for Determining the Peak Spatial-Average Specific Absorption Rate (SAR) in the Human Head from Wireless Communications Devices: Measurement Techniques Amendment 1: CAD File for Human Head Model (SAM Phantom)	2005
OET Bulletin 65 Supplement C	Additional Information for Evaluating Compliance of Mobile and Portable Devices with FCC Limits for Human Exposure to Radiofrequency Emissions	2001
KDB 447498 D01	Mobile and Portable Device RF Exposure Procedures and Equipment Authorization Policies	--
KDB 248227 D01	SAR Measurement Procedures for 802.11a/b/g Transmitters	--
KDB 648474 D01	SAR Evaluation Considerations for Handsets with Multiple Transmitters and Antennas	--

Human Exposure	Uncontrolled Environment General Population
Spatial Peak SAR	1.60 W/kg (averaged over a mass of 1g)

Table 12-1 RF Exposure Limits

Notes:

Uncontrolled environments are defined as locations where there is potential exposure of individuals who have no knowledge or control of their potential exposure.

13. Primary Laboratory Accreditation Details

The test facility is recognized, certified, or accredited by the following organizations:

- **CNAS (No. CNAS L0599)**

CNAS has accredited SGS-CSTC Standards Technical Services (Shanghai) Co., Ltd. to ISO/IEC 17025:2005 General Requirements for the Competence of Testing and Calibration Laboratories (CNAS-CL01 Accreditation Criteria for the Competence of Testing and Calibration Laboratories) for the competence in the field of testing. Date of expiry: 2014-07-26.

14. Test Equipment Information

14.1 SPEAG DASY4

Test Platform	SPEAG DASY4 Professional			
Location	SGS SH Lab #8			
Manufacture	SPEAG			
Description	SAR Test System (Frequency range 300MHz-3GHz) 835, 900, 1800, 1900, 2000, 2450 frequency band HAC Extension			
Software Reference	DASY4: V4.7 Build 80 SEMCAD: V1.8 Build 186			
Hardware Reference				
Equipment	Model	Serial Number	Calibration Date	Due date of calibration
Robot	RX90L	F03/5V32A1/A01	n/a	n/a
Phantom	SAM 12	TP-1283	n/a	n/a
DAE	DAE3	569	2011-11-16	2012-11-15
E-Field Probe	ES3DV3	3088	2011-11-23	2012-11-22
Validation Kits	D835V2	4d105	2011-11-11	2012-11-10
Validation Kits	D1900V2	5d028	2011-11-10	2012-11-09
Validation Kits	D2450V2	733	2011-11-09	2012-11-08
Agilent Network Analyzer	E5071B	MY42100549	2011-11-01	2012-10-31
RF Bi-Directional Coupler	ZABDC20-252H	n/a	2012-05-18	2013-05-17
Agilent Signal Generator	E4438C	14438CATO-19719	2011-11-01	2012-10-31
Mini-Circuits Preamplifier	ZHL-42	D041905	2011-11-01	2012-10-31
Agilent Power Meter	E4416A	GB41292095	2011-11-01	2012-10-31
Agilent Power Sensor	8481H	MY41091234	2011-11-01	2012-10-31
R&S Power Sensor	NRP-Z92	100025	2012-04-13	2013-04-12
R&S Universal Radio Communication Tester	CMU200	103633	2011-11-01	2012-10-31

14.2 The SAR Measurement System

A photograph of the SAR measurement System is given in Fig. 15-1.

This SAR Measurement System uses a Computer-controlled 3-D stepper motor system (Speag Dasy 4 professional system). A Model ES3DV3 3088 E-field probe is used to determine the internal electric fields. The SAR can be obtained from the equation $SAR = \sigma (|E_i|^2) / \rho$ where σ and ρ are the conductivity and mass density of the tissue-stimulant.

The DASY4 system for performing compliance tests consists of the following items:

A standard high precision 6-axis robot (Stabile RX family) with controller, teach pendant and software. An arm extension is for accommodation the data acquisition electronics (DAE).

A dissymmetric probe, i.e., an isotropic E-field probe optimized and calibrated for usage in tissue simulating liquid. The probe is equipped with an optical surface detector system.

Data acquisition electronics (DAE) which performs the signal amplification signal multiplexing, AD-conversion, offset measurements, mechanical surface detection, collision detection, etc. The unit is battery powered with standard or rechargeable batteries. The signal is optically transmitted to the EOC.

The Electro-optical converter (EOC) performs the conversion between optical and electrical of the signals for the digital communication to DAE and for the analog signal from the optical surface detection. The EOC is connected to the measurement server.

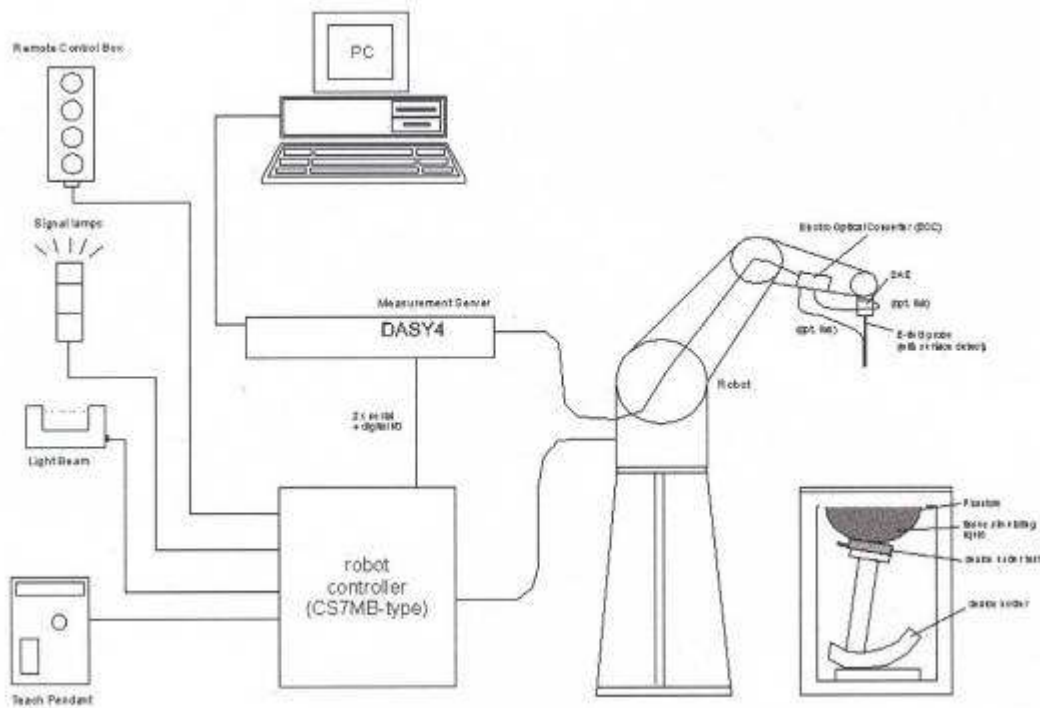

Fig. 14-1 SAR System Configuration

- The function of the measurement server is to perform the time critical tasks such as signal filtering, control of the robot operation and fast movement interrupts.
- A probe alignment unit which improves the (absolute) accuracy of the probe positioning.
- A computer operating Windows 2000.
- DASY4 software.
- Remote control with teach pendant and additional circuitry for robot safety such as warning lamps, etc.
- The SAM twin phantom enabling testing left-hand, right-hand and BodyWorn usage.
- The device holder for handheld mobile phones.
- Tissue simulating liquid mixed according to the given recipes.
- Validation dipole kits allowing to validating the proper functioning of the system.

14.3 Isotropic E-field Probe ES3DV3



Fig. 14-2 E-field Probe

Construction	Symmetrical design with triangular core Interleaved sensors Built-in shielding against static charges PEEK enclosure material (resistant to organic solvents, e.g., DGBE)
Calibration	Basic Broad Band Calibration in air Conversion Factors (CF) for HSL 900 and HSL 1810 Additional CF for other liquids and frequencies upon request
Frequency	10 MHz to 4 GHz; Linearity: ± 0.2 dB (30 MHz to 4 GHz)
Directivity	± 0.2 dB in HSL (rotation around probe axis) ± 0.3 dB in tissue material (rotation normal to probe axis)
Dynamic Range	5 μ W/g to > 100 mW/g; Linearity: ± 0.2 dB
Dimensions	Overall length: 330 mm (Tip: 20 mm) Tip diameter: 3.9 mm (Body: 12 mm) Distance from probe tip to dipole centers: 2.0 mm
Application	General dosimetry up to 4 GHz Dosimetry in strong gradient fields Compliance tests of mobile phones

14.4 RAM Twin Phantom



Fig. 14-3 SAM Twin Phantom

The SAM twin phantom is a fiberglass shell phantom with 2mm shell thickness (except the ear region where shell thickness increases to 6mm). It has three measurement areas:

- Left hand
- Right hand
- Flat phantom

A white cover is provided to tap the phantom during off-periods to prevent water evaporation and changes in the liquid parameters. Free space scans of devices on the cover are possible.

On the phantom top, three reference markers are provided to identify the phantom position with respect to the robot.

Phantom specification:

Description	The shell corresponds to the specifications of the Specific Anthropomorphic Mannequin (SAM) phantom defined in IEEE 1528-2003, CENELEC 50361 and IEC 62209. It enables the dosimetric evaluation of left and right hand phone usage as well as body mounted usage at the flat phantom region. A cover prevents evaporation of the liquid. Reference markings on the phantom allow the complete setup of all predefined phantom positions and measurement grids by teaching three points with the robot.
Shell Thickness	2+0.2mm, Center ear point: 6+0.2mm
Filling Volume	Approx.25 liters
Dimensions	Length: 1000mm, Width: 500mm, Height: 850mm

14.5 Device Holder for Transmitters



Fig. 14-4 Device Holder for Transmitters

The SAR in the phantom is approximately inversely proportional to the square of the distance between the source and the liquid surface. For a source in 5mm distance, a positioning uncertainty of $\pm 0.5\text{mm}$ would produce a SAR uncertainty of $\pm 20\%$. An accurate device positioning is therefore crucial for accurate and repeatable measurements. The positions, in which the devices must be measured, are defined by the standards.

The DASY device holder is designed to cope with different positions given in the standard. It has two scales for the device rotation (with respect to the body axis) and the device inclination (with respect to the line between the ear reference points). The rotation centers for both scales are the ear reference point (ERP). Thus the device needs no repositioning when changing the angles.

The DASY device holder has been made out of low-loss POM material having the following dielectric parameters: relative permittivity $\epsilon_r=3$ and loss tangent $\tan \delta=0.02$. The amount of dielectric material has been reduced in the closest vicinity of the device, since measurements have suggested that the influence of the clamp on the test results could thus be lowered.

15. Detailed Test Results

15.1 Summary of Results

15.1.1 Measurement of RF conducted Power (dBm)

GSM 850&1900

Mode		GPRS							
Slot (Uplink)		1		2		3		4	
/		Burst	Averaged	Burst	Averaged	Burst	Averaged	Burst	Averaged
Band	Channel	GMSK							
850	128	32.4	23.6	31.0	22.8	29.6	21.4	28.4	20.7
	190	32.5	23.7	31.1	22.7	29.5	21.6	28.2	20.8
	251	32.4	23.6	30.8	22.6	29.3	21.5	28.2	20.6
1900	512	28.8	20.3	27.5	19.6	26.3	18.4	25.3	17.8
	661	28.7	20.2	27.6	19.4	26.7	18.3	25.8	17.6
	810	28.7	20.2	27.4	19.5	26.5	18.5	25.6	17.5

WIFI

	Channel	Average Power (dBm) for Data Rates (Mbps)							
		1	2	5.5	11	/	/	/	/
802.11b	1	13.07	13.53	14.82	15.17				
	6	13.28	13.54	14.79	15.15				
	11	13.69	13.87	15.19	15.54				
	Channel	6	9	12	18	24	36	48	54
802.11g	1	14.09	14.15	14.29	14.38	14.62	14.39	14.87	14.65
	6	14.43	14.65	14.85	14.96	15.34	15.51	15.69	15.76
	11	15.22	15.31	15.40	15.47	15.55	15.62	15.70	15.78

15.1.2 Measurement of SAR average value

GSM 850

Band	EUT Position	Mode	Test Configuration	Averaged SAR over 1g (W/kg)			SAR limit 1g (W/kg)	Verdict
				CH128	CH190	CH251		
				824.2MHz	836.6MHz	848.8MHz		
GSM850	Body Worn	GPRS 1TS	Back of EUT facing phantom	--	0.019	--	1.6	Passed
		GPRS 2TS	Back of EUT facing phantom	--	0.034	--	1.6	Passed
		GPRS 3TS	Back of EUT facing phantom	--	0.037	--	1.6	Passed
		GPRS 4TS	Back of EUT facing phantom	0.033	0.069	0.057	1.6	Passed
		GPRS 4TS	Front of EUT facing phantom	--	0.043	--	1.6	Passed

GSM 1900

Band	EUT Position	Mode	Test Configuration	Averaged SAR over 1g (W/kg)			SAR limit 1g (W/kg)	Verdict
				CH512	CH661	CH810		
				1850.2MHz	1880MHz	1909.8MHz		
GSM1900	Body Worn	GPRS 1TS	Back of EUT facing phantom	--	0.098	--	1.6	Passed
		GPRS 2TS	Back of EUT facing phantom	--	0.175	--	1.6	Passed
		GPRS 3TS	Back of EUT facing phantom	--	0.197	--	1.6	Passed
		GPRS 4TS	Back of EUT facing phantom	0.241	0.229	0.215	1.6	Passed
		GPRS 4TS	Front of EUT facing phantom	--	0.203	--	1.6	Passed

WIFI

Band	EUT Position	Mode	Test Configuration	Averaged SAR over 10g (W/kg)			SAR limit 10g (W/kg)	Verdict
				CH1	CH6	CH11		
				2412MHz	2437MHz	2462MHz		
WIFI	Body Worn	802.11b(11M)	Front of EUT facing phantom	--	--	0.048	1.6	Passed
			Back of EUT facing phantom	--	--	0.028	1.6	Passed
		Worst case of 802.11b in 802.11g		--	--	0.045	1.6	Passed

15.2 Maximum Results

The maximum measured SAR values for BodyWorn configuration are given in section 15.2.1.

15.2.1 BodyWorn Configuration

Frequency Band	EUT Position	Conducted Power (dBm)	SAR, Averaged over 1g (W/kg)	Power Drift (dB)	SAR limit (W/kg)	Verdict
GSM850	GPRS 4TS/Back of EUT facing phantom/Middle	28.2	0.069	-0.395	1.6	Passed
GSM 1900	GPRS 4TS/ Back of EUT facing phantom/ Middle	25.8	0.241	-0.359	1.6	Passed
WIFI	802.11b/Front of EUT facing phantom//High(11M)	15.54	0.048	-0.375	1.6	Passed

According to 15.2.1 The Max Add WIFI SAR value and other SAR value together is Back Side Middle Condition. SAR value is 0.048w/kg and 0.241 w/kg Separately . so the sum of them is $0.048+0.241=0.289\text{w/kg} < 1.6\text{w/kg}$. According to KDB 648474 D01 the simultaneous transmission SAR are not required.

15.2.2 Maximum Drift

Maximum Drift during measurement	-0.395dB
----------------------------------	----------

15.2.3 Measurement Uncertainty

Extended Uncertainty (k=2) 95%	20.86%
--------------------------------	--------

15.3 Operation Configurations

15.3.1

The EUT is controlled by using a radio communication tester (CMU200) with air link, and the EUT is set to maximum output power by CMU200 during all tests.

1. Testing SAR at GSM mode for all bands at positions 15.3.3 shows.
2. SAR with accessories should be done at worstcase to identify maximum SAR value.
3. Test reduction has been adopted according to conducted output power and produced SAR level:

Low and High channel SAR are optional if SAR value produced in the middle channel is 3dB lower than the applicable SAR limit;

In GPRS mode, the multislot configuration which produces highest SAR value is regard as the worst case to be measured, other multislot configurations are selectively confirmed;

4. The (max.cube) labeling indicates that during the grid scanning an additional peak was found which within 2dB of the highest peak

15.3.2

The EUT is measured using chipset based test mode software to ensure the results are consistent and reliable, during the 802.11b/g/n mode tests.

1. The 802.11b mode is tested at 1,6,11 channels.
2. The 802.11g mode is checked at worst case of 802.11b mode.
3. The EUT is at the lowest data rate during test according the power of the EUT.
4. Test reduction has been adopted according to conducted output power and produced SAR level:

Low and High channel SAR are optional if SAR value produced in the middle channel is 3dB lower than the applicable SAR limit;

5. The (max. cube) labeling indicates that during the grid scanning an additional peak was found which within 2dB of the highest peak

15.3.3. Test positions of EUT (the distance between the EUT and the phantom is 0mm for the two sides)

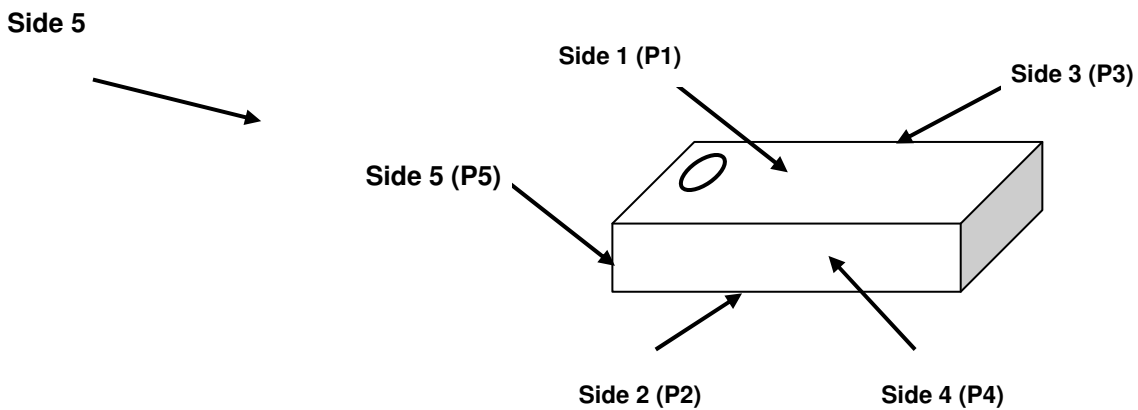
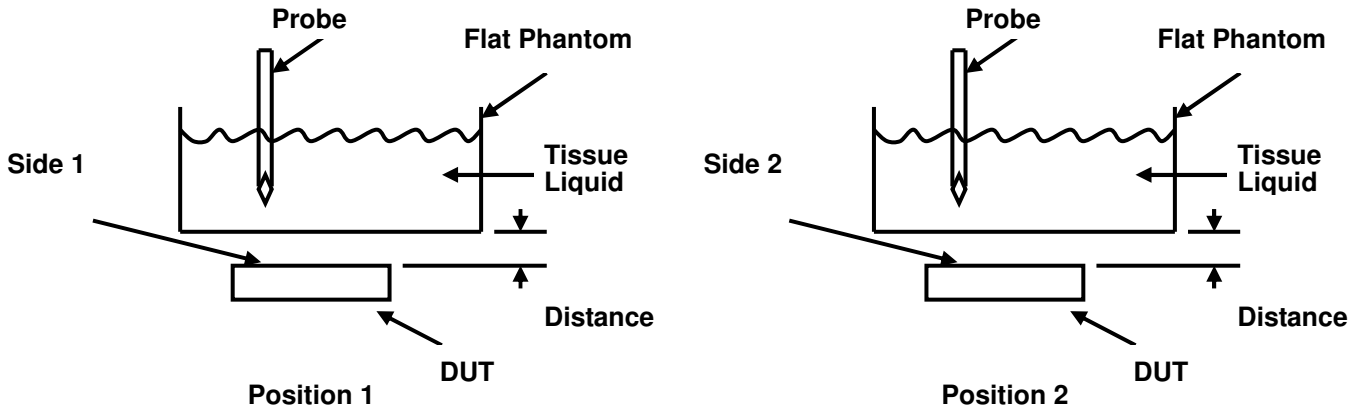

15.4 Measurement procedure

Step 1: Power reference measurement

The SAR measurement was taken at a selected spatial reference point to monitor power variations during testing. This fixed location point was measured and used as a reference value.

Step 2: Area scan

The SAR distribution at the exposed side of the head was measured at a distance of 4mm from the inner surface of the shell. The area covered the entire dimension of the head and the horizontal grid spacing was 15mm*15mm or 10mm*10mm. Based on the area scan data, the area of the maximum absorption was determined by spline interpolation.

Step 3: Zoom scan

Around this point, a volume of 30mm*30mm*30mm (fine resolution volume scan, zoom scan) was assessed by measuring 7*7*7 points. On this basis of this data set, the spatial peak SAR value was evaluated with the following procedure:

The data at the surface was extrapolated, since the center of the dipoles is 2.0mm away from the tip of the probe and the distance between the surface and the lowest measuring point is 1.2mm. (This can be variable. Refer to the probe specification) the extrapolation was based on a least square algorithm. A polynomial of the fourth order was calculated through the points in z-axes. This polynomial was then used to evaluate the points between the surface and the probe tip. The maximum interpolated value was searched with a straight-forward algorithm. Around this maximum the SAR values averaged over the spatial volumes (1g or 10g) were computed using the 3D-Spline interpolation algorithm. The volume was integrated with the trapezoidal algorithm. One thousand points (10*10*10) were interpolated to calculate the average. All neighboring volumes were evaluated until no neighboring volume with a higher average value was found.

Step 4: Power reference measurement (drift)

The SAR value at the same location as in step 1 was again measured. (If the value changed by more than 5%, the evaluation should be done repeatedly)

15.5 Detailed Test Results

16.5.1 GSM 850+GPRS 1TS-Bodyworn-BackSide-Middle

Date/Time: 2012-10-9 9:04:56

Test Laboratory: SGS-GSM

MobiPrint² GSM 850+GPRS (1TS) Back Side Middle

DUT: MobiPrint²; Type: GPRS; Serial: 359128040100097

Communication System: GSM850-GPRS Mode(1up); Frequency: 836.6 MHz; Duty Cycle: 1:8.3

Medium: HSL835_Body Medium parameters used: $f = 836.6$ MHz; $\sigma = 0.99$ mho/m; $\epsilon_r = 56.5$; $\rho = 1000$ kg/m³

Phantom section: Flat Section

DASY4 Configuration:

- Probe: ES3DV3 - SN3088; ConvF(6.13, 6.13, 6.13); Calibrated: 2011-11-23
- Sensor-Surface: 4mm (Mechanical Surface Detection)
- Electronics: DAE3 Sn569; Calibrated: 2011-11-16
- Phantom: ELI 4.0; Type: QDOVA001BA; Serial: xxxx
- Measurement SW: DASY4, V4.7 Build 80; Postprocessing SW: SEMCAD, V1.8 Build 186

Middle/Area Scan (81x161x1): Measurement grid: dx=15mm, dy=15mm

Maximum value of SAR (interpolated) = 0.020 mW/g

Middle/Zoom Scan (7x7x7)/Cube 0: Measurement grid: dx=5mm, dy=5mm, dz=5mm

Reference Value = 3.32 V/m; Power Drift = -0.362 dB

Peak SAR (extrapolated) = 0.025 W/kg

SAR(1 g) = 0.019 mW/g; SAR(10 g) = 0.014 mW/g

Maximum value of SAR (measured) = 0.021 mW/g

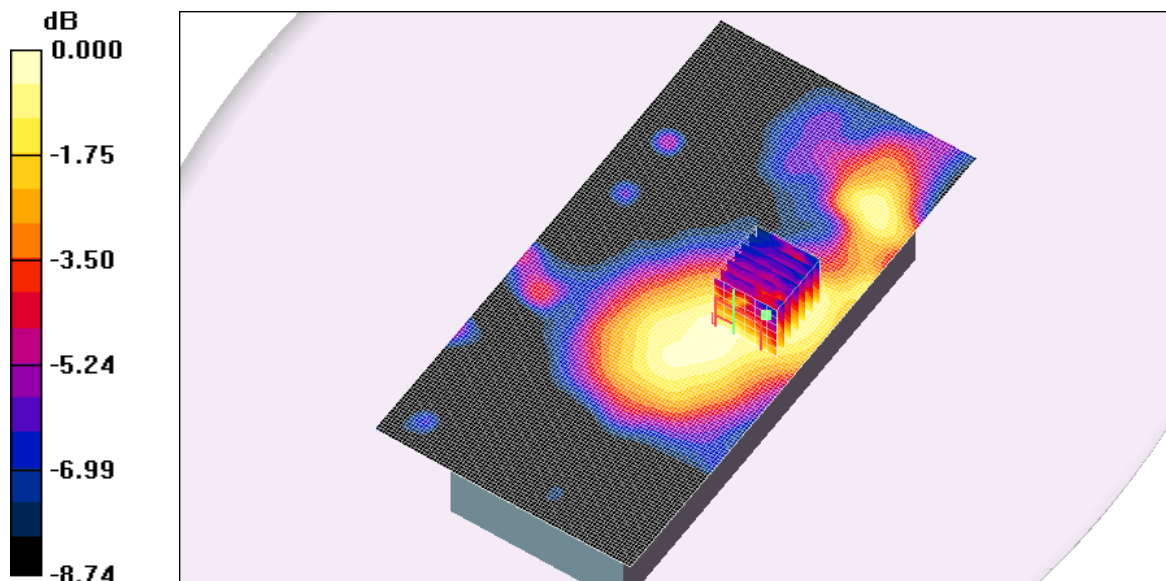

0 dB = 0.021mW/g

SHEMC

16.5.2 GSM 850+GPRS 2TS-Bodyworn- BackSide -Middle

Date/Time: 2012-10-9 9:50:50

Test Laboratory: SGS-GSM

MobiPrint² GSM 850+GPRS (2TS) Back Side Middle

DUT: MobiPrint²; Type: GPRS; Serial: 359128040100097

Communication System: GSM850-GPRS Mode(2up); Frequency: 836.6 MHz;Duty Cycle: 1:4.15

Medium: HSL835_Body Medium parameters used: f = 836.6 MHz; σ = 0.99 mho/m; ϵ_r = 56.5; ρ = 1000 kg/m³

Phantom section: Flat Section

DASY4 Configuration:

- Probe: ES3DV3 - SN3088; ConvF(6.13, 6.13, 6.13); Calibrated: 2011-11-23
- Sensor-Surface: 4mm (Mechanical Surface Detection)
- Electronics: DAE3 Sn569; Calibrated: 2011-11-16
- Phantom: ELI 4.0; Type: QDOVA001BA; Serial: xxxx
- Measurement SW: DASY4, V4.7 Build 80; Postprocessing SW: SEMCAD, V1.8 Build 186

Middle/Area Scan (81x161x1): **Measurement grid: dx=15mm, dy=15mm**

Maximum value of SAR (interpolated) = 0.035 mW/g

Middle/Zoom Scan (7x7x7)/Cube 0: **Measurement grid: dx=5mm, dy=5mm, dz=5mm**

Reference Value = 4.36 V/m; Power Drift = 0.202 dB

Peak SAR (extrapolated) = 0.044 W/kg

SAR(1 g) = 0.034 mW/g; SAR(10 g) = 0.026 mW/g

Maximum value of SAR (measured) = 0.038 mW/g

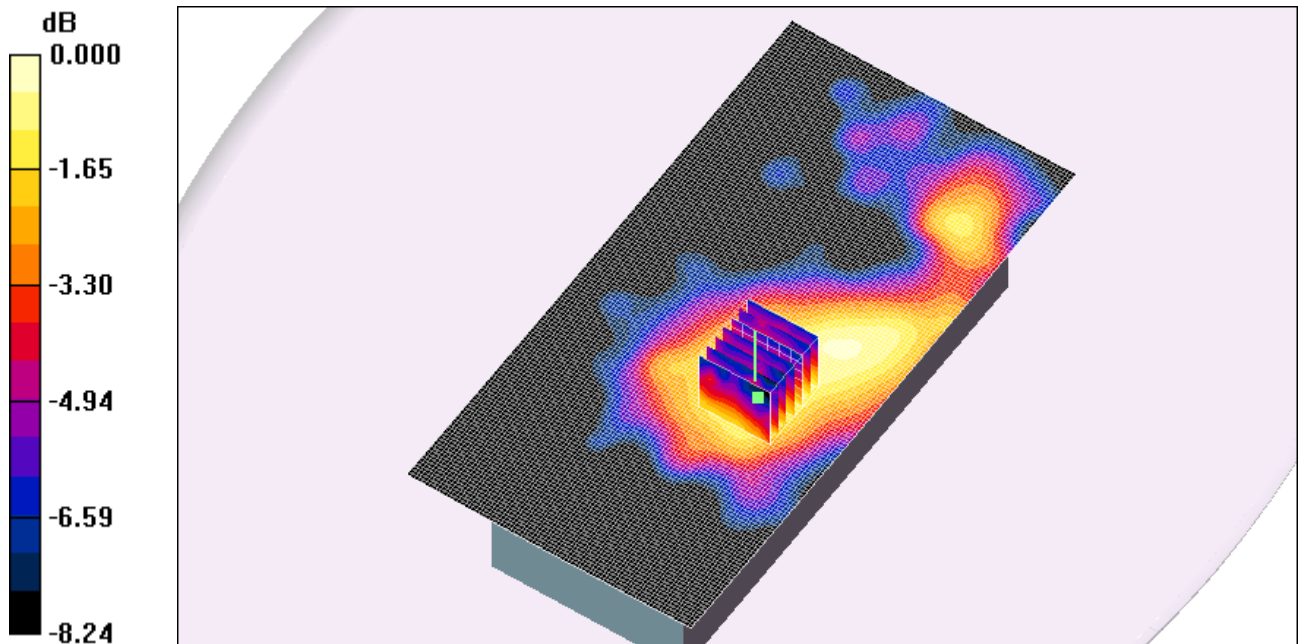

0 dB = 0.038mW/g

16.5.3 GSM 850+GPRS 3TS-Bodyworn- BackSide -Middle

Date/Time: 2012-10-9 10:56:21

Test Laboratory: SGS-GSM

MobiPrint² GSM 850+GPRS(3TS) Back Side Middle

DUT: MobiPrint²; Type: GPRS; Serial: 359128040100097

Communication System: GSM850-GPRS Mode(3up); Frequency: 836.6 MHz;Duty Cycle: 1:2.77

Medium: HSL835_Body Medium parameters used: f = 836.6 MHz; σ = 0.99 mho/m; ϵ_r = 56.5; ρ = 1000 kg/m³

Phantom section: Flat Section

DASY4 Configuration:

- Probe: ES3DV3 - SN3088; ConvF(6.13, 6.13, 6.13); Calibrated: 2011-11-23
- Sensor-Surface: 4mm (Mechanical Surface Detection)
- Electronics: DAE3 Sn569; Calibrated: 2011-11-16
- Phantom: ELI 4.0; Type: QDOVA001BA; Serial: xxxx
- Measurement SW: DASY4, V4.7 Build 80; Postprocessing SW: SEMCAD, V1.8 Build 186

Middle/Area Scan (81x161x1): **Measurement grid: dx=15mm, dy=15mm**

Maximum value of SAR (interpolated) = 0.040 mW/g

Middle/Zoom Scan (7x7x7)/Cube 0: **Measurement grid: dx=5mm, dy=5mm, dz=5mm**

Reference Value = 4.65 V/m; Power Drift = -0.231 dB

Peak SAR (extrapolated) = 0.050 W/kg

SAR(1 g) = 0.037 mW/g; SAR(10 g) = 0.028 mW/g

Maximum value of SAR (measured) = 0.040 mW/g

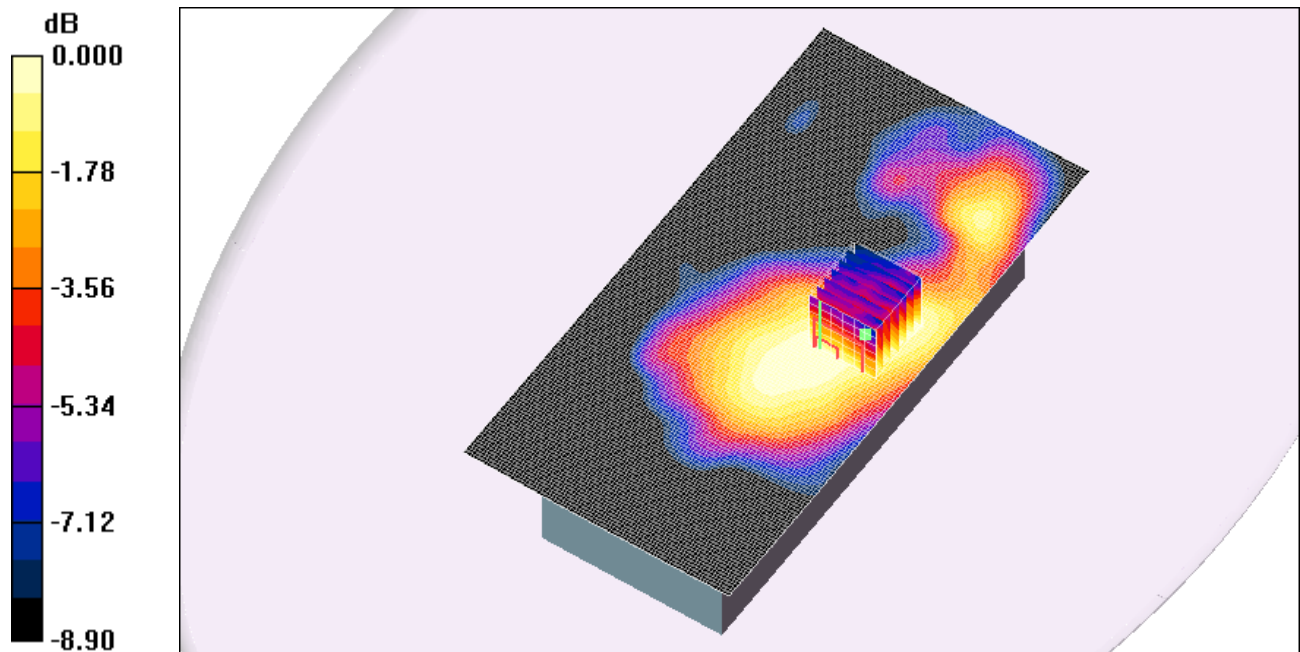

0 dB = 0.040mW/g

16.5.4 GSM 850+GPRS 4TS-Bodyworn- BackSide -Middle

Date/Time: 2012-10-9 12:02:00

Test Laboratory: SGS-GSM

MobiPrint² GSM 850+GPRS (4TS) Back Side Middle

DUT: MobiPrint²; Type: GPRS; Serial: 359128040100097

Communication System: GSM850-GPRS Mode(4UP); Frequency: 836.6 MHz; Duty Cycle: 1:2.075

Medium: HSL835_Body Medium parameters used: f = 836.6 MHz; σ = 0.99 mho/m; ϵ_r = 56.5; ρ = 1000 kg/m³

Phantom section: Flat Section

DASY4 Configuration:

- Probe: ES3DV3 - SN3088; ConvF(6.13, 6.13, 6.13); Calibrated: 2011-11-23
- Sensor-Surface: 4mm (Mechanical Surface Detection)
- Electronics: DAE3 Sn569; Calibrated: 2011-11-16
- Phantom: ELI 4.0; Type: QDOVA001BA; Serial: xxxx
- Measurement SW: DASY4, V4.7 Build 80; Postprocessing SW: SEMCAD, V1.8 Build 186

Middle/Area Scan (81x161x1): **Measurement grid: dx=15mm, dy=15mm**

Maximum value of SAR (interpolated) = 0.073 mW/g

Middle/Zoom Scan (7x7x7)/Cube 0: **Measurement grid: dx=5mm, dy=5mm, dz=5mm**

Reference Value = 6.31 V/m; Power Drift = -0.395 dB

Peak SAR (extrapolated) = 0.095 W/kg

SAR(1 g) = 0.069 mW/g; SAR(10 g) = 0.046 mW/g

Maximum value of SAR (measured) = 0.075 mW/g

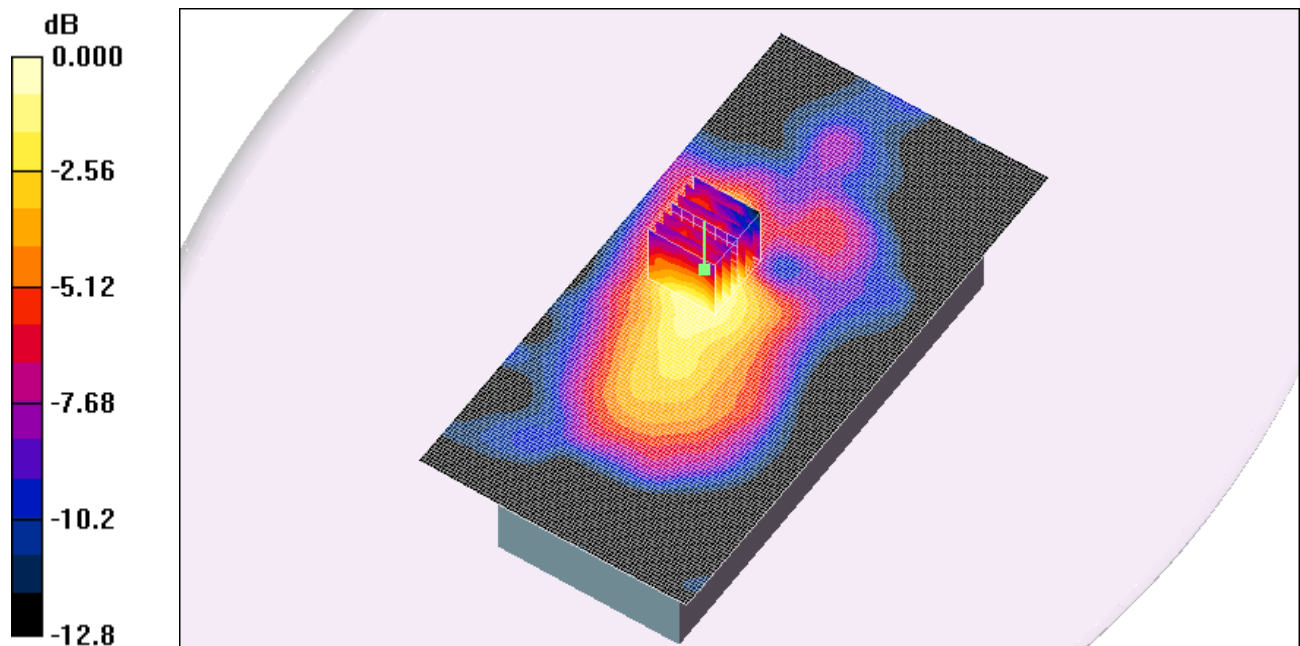

0 dB = 0.075mW/g

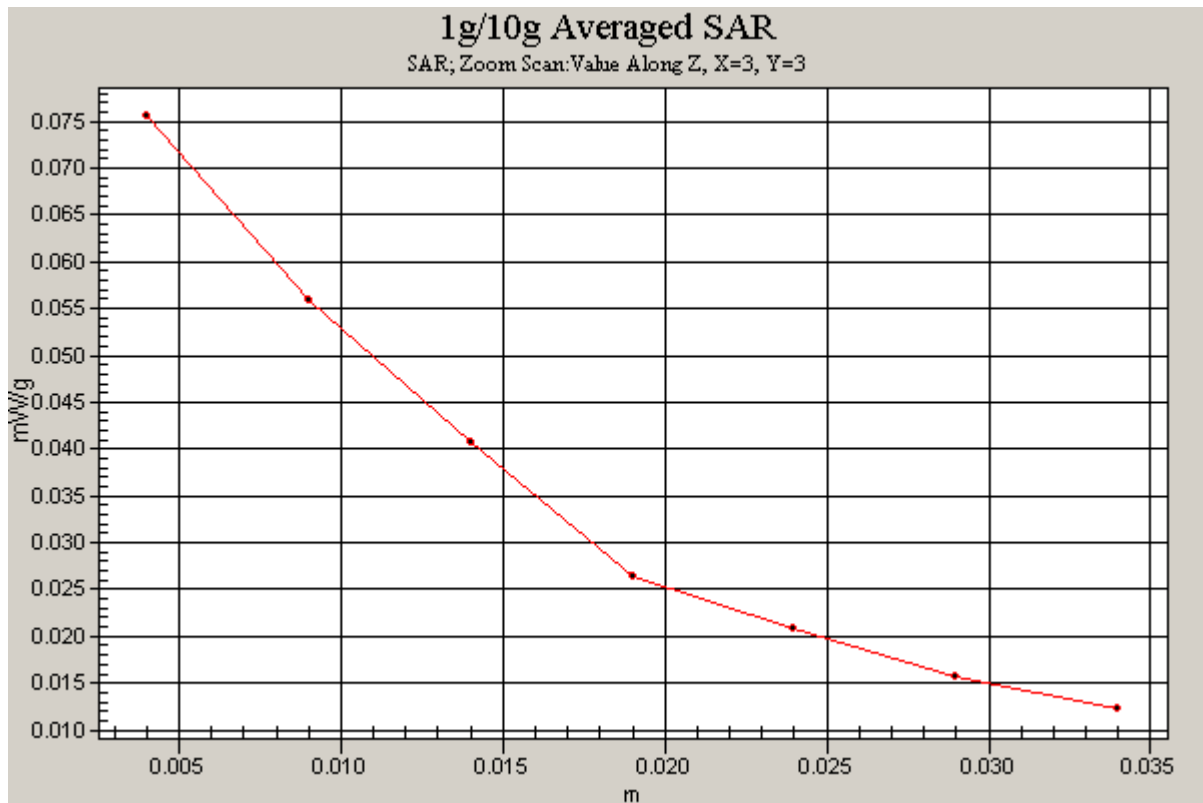

16.5.5 GSM 850+GPRS 4TS-Bodyworn-FrontSide-Middle

Date/Time: 2012-10-9 13:11:24

Test Laboratory: SGS-GSM

MobiPrint² GSM 850+GPRS (4TS) Front Side Middle

DUT: MobiPrint²; Type: GPRS; Serial: 359128040100097

Communication System: GSM850-GPRS Mode(4UP); Frequency: 836.6 MHz; Duty Cycle: 1:2.075

Medium: HSL835_Body Medium parameters used: $f = 836.6$ MHz; $\sigma = 0.99$ mho/m; $\epsilon_r = 56.5$; $\rho = 1000$ kg/m³

Phantom section: Flat Section

DASY4 Configuration:

- Probe: ES3DV3 - SN3088; ConvF(6.13, 6.13, 6.13); Calibrated: 2011-11-23
- Sensor-Surface: 4mm (Mechanical Surface Detection)
- Electronics: DAE3 Sn569; Calibrated: 2011-11-16
- Phantom: ELI 4.0; Type: QDOVA001BA; Serial: xxxx
- Measurement SW: DASY4, V4.7 Build 80; Postprocessing SW: SEMCAD, V1.8 Build 186

Middle/Area Scan (81x161x1): Measurement grid: dx=15mm, dy=15mm

Maximum value of SAR (interpolated) = 0.047 mW/g

Middle/Zoom Scan (7x7x7)/Cube 0: Measurement grid: dx=5mm, dy=5mm, dz=5mm

Reference Value = 4.98 V/m; Power Drift = -0.215 dB

SHEMC

Peak SAR (extrapolated) = 0.054 W/kg

SAR(1 g) = 0.043 mW/g; SAR(10 g) = 0.033 mW/g

Maximum value of SAR (measured) = 0.049 mW/g

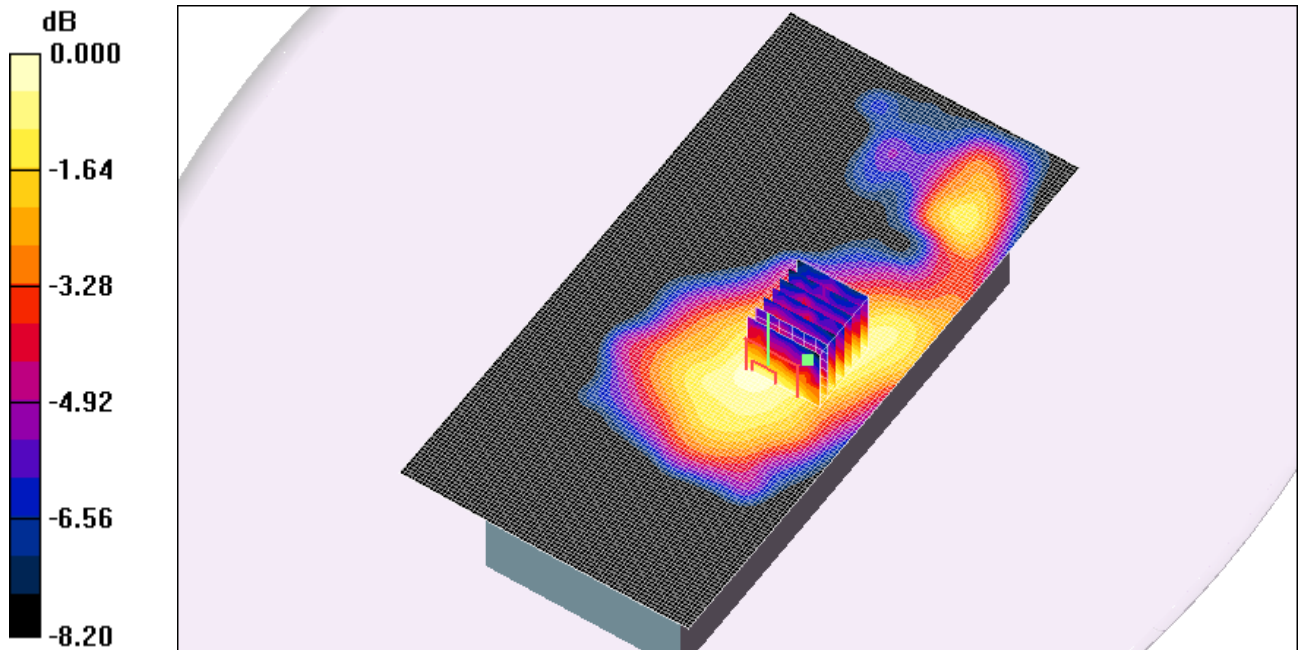

0 dB = 0.049mW/g

16.5.6 GSM 850+GPRS 4TS-Bodyworn-BackSide-High

Date/Time: 2012-10-9 14:02:14

Test Laboratory: SGS-GSM

MobiPrint² GSM 850+GPRS (4TS) Back Side High

DUT: MobiPrint²; Type: GPRS; Serial: 359128040100097

Communication System: GSM850-GPRS Mode(4UP); Frequency: 848.8 MHz; Duty Cycle: 1:2.075

Medium: HSL835_Body Medium parameters used: f = 848.8 MHz; $\sigma = 1$ mho/m; $\epsilon_r = 56.4$; $\rho = 1000$ kg/m³

Phantom section: Flat Section

DASY4 Configuration:

- Probe: ES3DV3 - SN3088; ConvF(6.13, 6.13, 6.13); Calibrated: 2011-11-23
- Sensor-Surface: 4mm (Mechanical Surface Detection)
- Electronics: DAE3 Sn569; Calibrated: 2011-11-16
- Phantom: ELI 4.0; Type: QDOVA001BA; Serial: xxxx
- Measurement SW: DASY4, V4.7 Build 80; Postprocessing SW: SEMCAD, V1.8 Build 186

High/Area Scan (81x161x1): **Measurement grid: dx=15mm, dy=15mm**

Maximum value of SAR (interpolated) = 0.065 mW/g

High/Zoom Scan (7x7x7)/Cube 0: **Measurement grid: dx=5mm, dy=5mm, dz=5mm**

Reference Value = 5.88 V/m; Power Drift = 0.092 dB

Peak SAR (extrapolated) = 0.070 W/kg

SHEMC

SAR(1 g) = 0.057 mW/g; SAR(10 g) = 0.044 mW/g

Maximum value of SAR (measured) = 0.062 mW/g

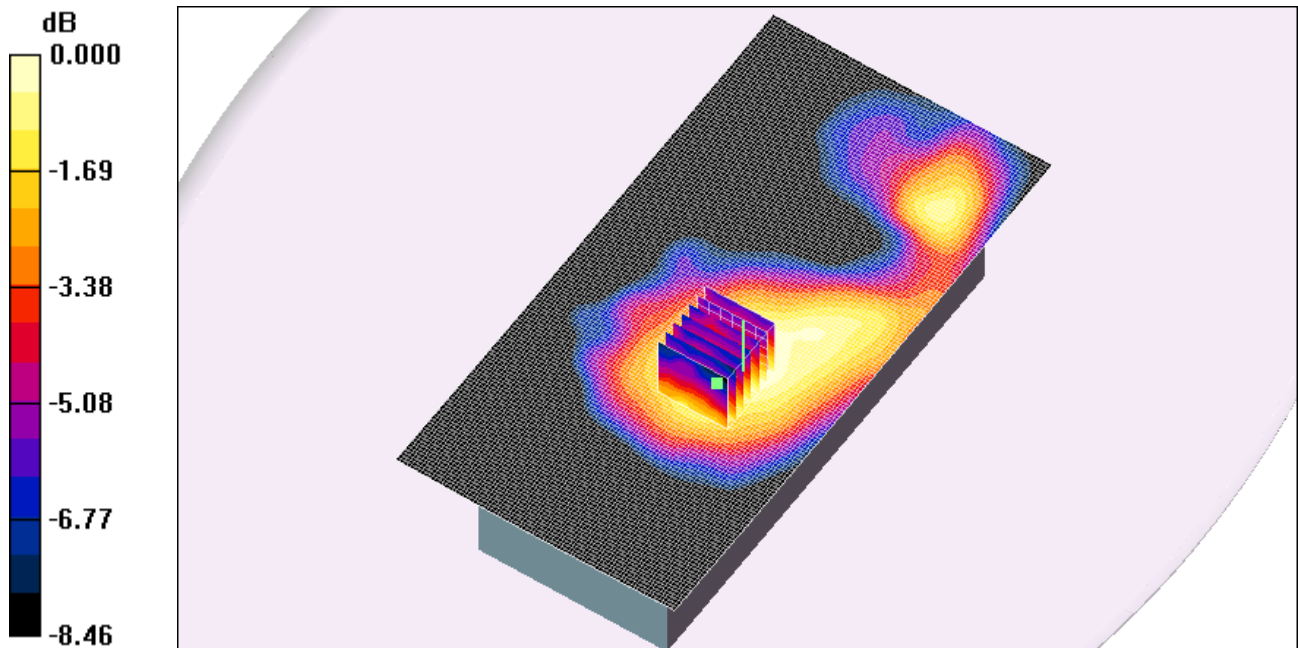

0 dB = 0.062mW/g

16.5.7 GSM 850+GPRS 4TS-Bodyworn- BackSide-Low

Date/Time: 2012-10-9 15:21:13

Test Laboratory: SGS-GSM

MobiPrint² GSM 850+GPRS (4TS) Back Side Low

DUT: MobiPrint²; Type: GPRS; Serial: 359128040100097

Communication System: GSM850-GPRS Mode(4UP); Frequency: 824.2 MHz; Duty Cycle: 1:2.075

Medium: HSL835_Body Medium parameters used: f = 824.2 MHz; σ = 0.978 mho/m; ε_r = 56.6; ρ = 1000 kg/m³

Phantom section: Flat Section

DASY4 Configuration:

- Probe: ES3DV3 - SN3088; ConvF(6.13, 6.13, 6.13); Calibrated: 2011-11-23
- Sensor-Surface: 4mm (Mechanical Surface Detection)
- Electronics: DAE3 Sn569; Calibrated: 2011-11-16
- Phantom: ELI 4.0; Type: QDOVA001BA; Serial: xxxx
- Measurement SW: DASY4, V4.7 Build 80; Postprocessing SW: SEMCAD, V1.8 Build 186

Low/Area Scan (81x161x1): **Measurement grid: dx=15mm, dy=15mm**

Maximum value of SAR (interpolated) = 0.036 mW/g

Low/Zoom Scan (7x7x7)/Cube 0: **Measurement grid: dx=5mm, dy=5mm, dz=5mm**

Reference Value = 4.32 V/m; Power Drift = -0.369 dB

SHEMC

Peak SAR (extrapolated) = 0.043 W/kg

SAR(1 g) = 0.033 mW/g; SAR(10 g) = 0.025 mW/g

Maximum value of SAR (measured) = 0.035 mW/g

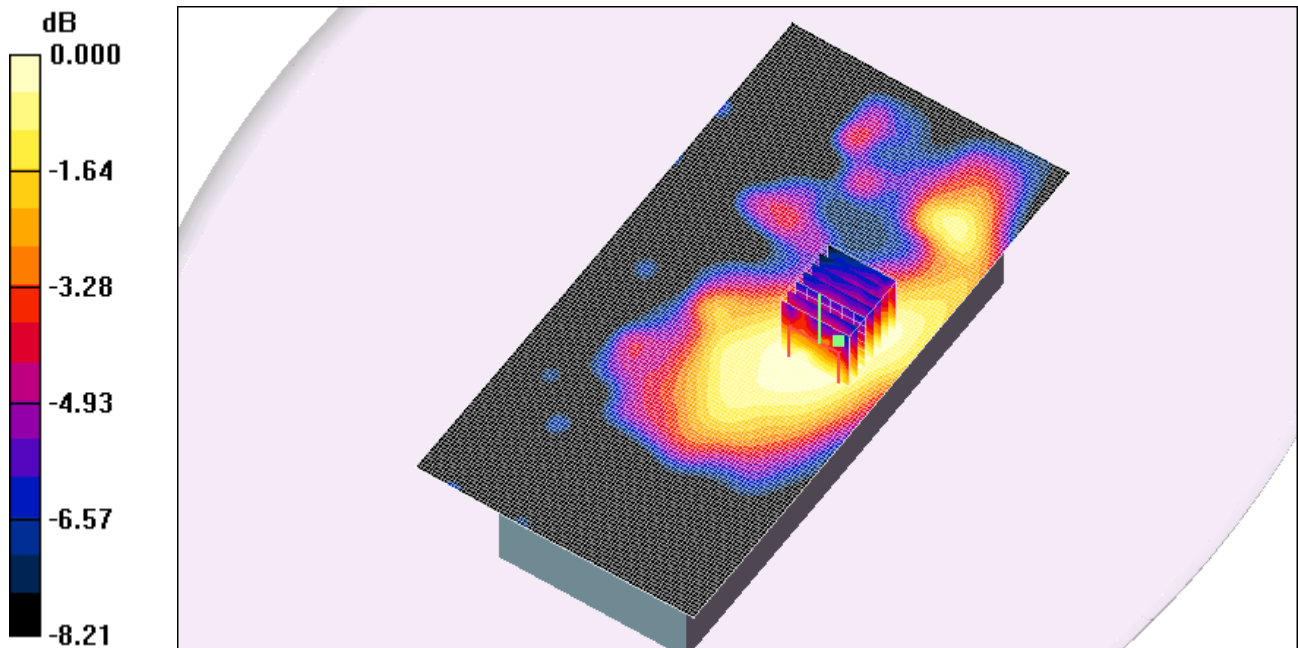

0 dB = 0.035mW/g

16.5.8 GSM 1900+GPRS 1TS-Bodyworn-BackSide-Middle

Date/Time: 2012-10-10 9:11:58

Test Laboratory: SGS-GSM

MobiPrint² GSM 1900+GPRS (1TS) Back Side Middle

DUT: MobiPrint²; Type: GPRS; Serial: 359128040100097

Communication System: PCS1900-GPRS Mode; Frequency: 1880 MHz; Duty Cycle: 1:8.3

Medium: HSL1900-Body Medium parameters used: f = 1880 MHz; σ = 1.58 mho/m; ϵ_r = 50.1; ρ = 1000 kg/m³

Phantom section: Flat Section

DASY4 Configuration:

- Probe: ES3DV3 - SN3088; ConvF(4.8, 4.8, 4.8); Calibrated: 2011-11-23
- Sensor-Surface: 4mm (Mechanical Surface Detection)
- Electronics: DAE3 Sn569; Calibrated: 2011-11-16
- Phantom: ELI 4.0; Type: QDOVA001BA; Serial: xxxx
- Measurement SW: DASY4, V4.7 Build 80; Postprocessing SW: SEMCAD, V1.8 Build 186

Middle/Area Scan (81x161x1): **Measurement grid: dx=15mm, dy=15mm**

Maximum value of SAR (interpolated) = 0.112 mW/g

Middle/Zoom Scan (7x7x7)/Cube 0: **Measurement grid: dx=5mm, dy=5mm, dz=5mm**

Reference Value = 6.25 V/m; Power Drift = -0.276 dB

SHEMC

Peak SAR (extrapolated) = 0.130 W/kg

SAR(1 g) = 0.098 mW/g; SAR(10 g) = 0.069 mW/g

Maximum value of SAR (measured) = 0.107 mW/g

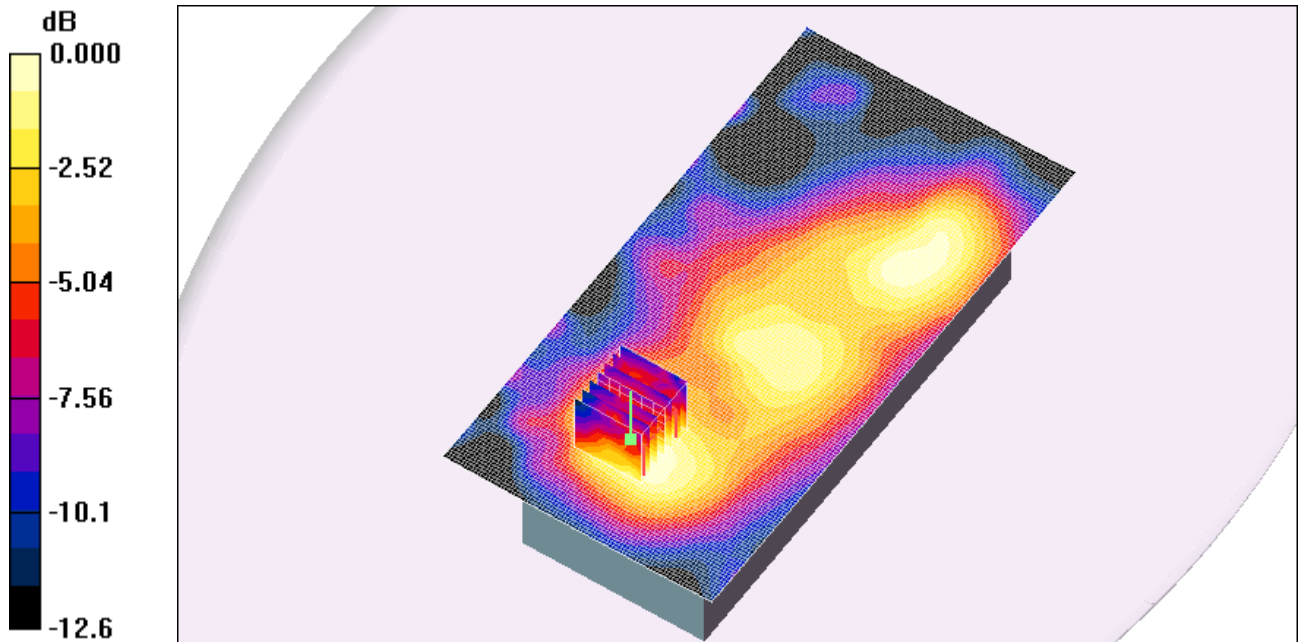

0 dB = 0.107mW/g

16.5.9 GSM 1900+GPRS 2TS-Bodyworn- BackSide -Middle

Date/Time: 2012-10-10 11:00:42

Test Laboratory: SGS-GSM

MobiPrint² GSM 1900+GPRS (2TS) Back Side Middle

DUT: MobiPrint²; Type: GPRS; Serial: 359128040100097

Communication System: PCS1900-GPRS Mode(2 ts); Frequency: 1880 MHz;Duty Cycle: 1:4.15

Medium: HSL1900-Body Medium parameters used: f = 1880 MHz; $\sigma = 1.58$ mho/m; $\epsilon_r = 50.1$; $\rho = 1000$ kg/m³

Phantom section: Flat Section

DASY4 Configuration:

- Probe: ES3DV3 - SN3088; ConvF(4.8, 4.8, 4.8); Calibrated: 2011-11-23
- Sensor-Surface: 4mm (Mechanical Surface Detection)
- Electronics: DAE3 Sn569; Calibrated: 2011-11-16
- Phantom: ELI 4.0; Type: QDOVA001BA; Serial: xxxx
- Measurement SW: DASY4, V4.7 Build 80; Postprocessing SW: SEMCAD, V1.8 Build 186

Middle/Area Scan (81x161x1): **Measurement grid: dx=15mm, dy=15mm**

Maximum value of SAR (interpolated) = 0.207 mW/g

Middle/Zoom Scan (7x7x7)/Cube 0: **Measurement grid: dx=5mm, dy=5mm, dz=5mm**

Reference Value = 8.06 V/m; Power Drift = -0.145 dB

SHEMC

Peak SAR (extrapolated) = 0.222 W/kg

SAR(1 g) = 0.175 mW/g; SAR(10 g) = 0.121 mW/g

Maximum value of SAR (measured) = 0.192 mW/g

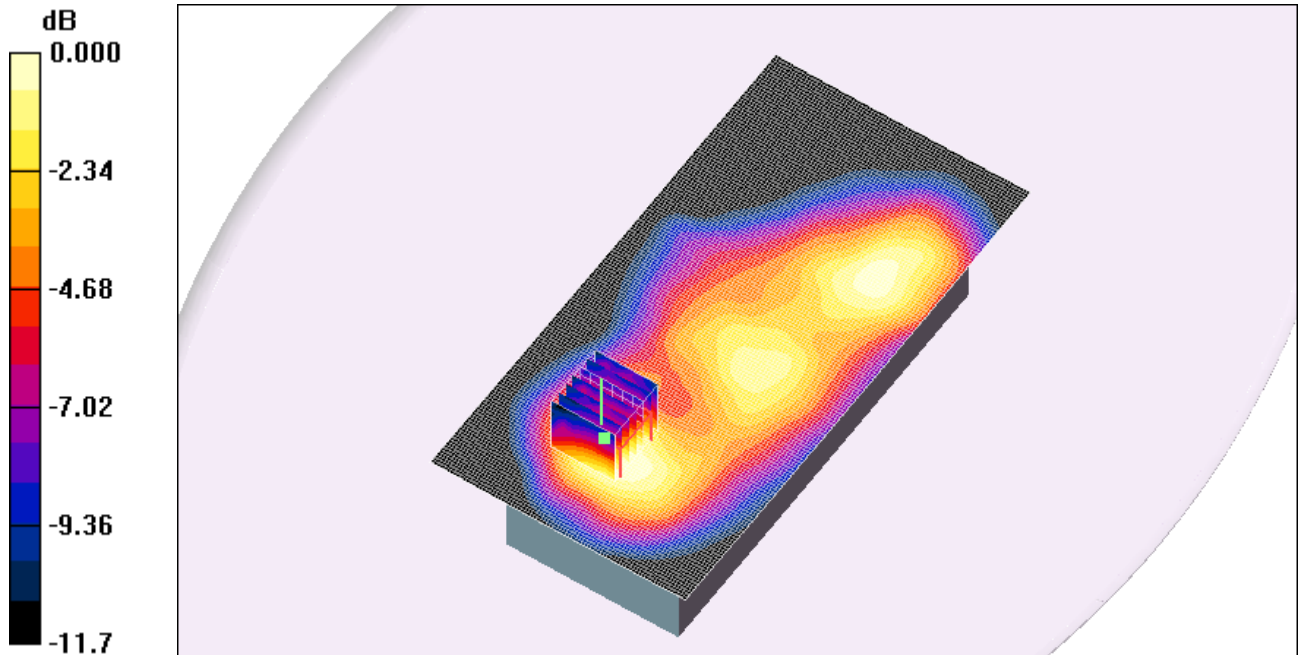

0 dB = 0.192mW/g

16.5.10 GSM 1900+GPRS 3TS-Bodyworn- BackSide -Middle

Date/Time: 2012-10-10 12:01:09

Test Laboratory: SGS-GSM

MobiPrint² GSM 1900+GPRS(3TS) Back Side Middle

DUT: MobiPrint² ; Type: GPRS; Serial: 359128040100097

Communication System: PCS1900-GPRS Mode; Frequency: 1880 MHz;Duty Cycle: 1:2.77

Medium: HSL1900-Body Medium parameters used: f = 1880 MHz; σ = 1.58 mho/m; ϵ_r = 50.1; ρ = 1000 kg/m³

Phantom section: Flat Section

DASY4 Configuration:

- Probe: ES3DV3 - SN3088; ConvF(4.8, 4.8, 4.8); Calibrated: 2011-11-23
- Sensor-Surface: 4mm (Mechanical Surface Detection)
- Electronics: DAE3 Sn569; Calibrated: 2011-11-16
- Phantom: ELI 4.0; Type: QDOVA001BA; Serial: xxxx
- Measurement SW: DASY4, V4.7 Build 80; Postprocessing SW: SEMCAD, V1.8 Build 186

Middle/Area Scan (81x161x1): **Measurement grid: dx=15mm, dy=15mm**

Maximum value of SAR (interpolated) = 0.229 mW/g

Middle/Zoom Scan (7x7x7)/Cube 0: **Measurement grid: dx=5mm, dy=5mm, dz=5mm**

Reference Value = 8.62 V/m; Power Drift = -0.239 dB

SHEMC

Peak SAR (extrapolated) = 0.266 W/kg

SAR(1 g) = 0.197 mW/g; SAR(10 g) = 0.137 mW/g

Maximum value of SAR (measured) = 0.215 mW/g

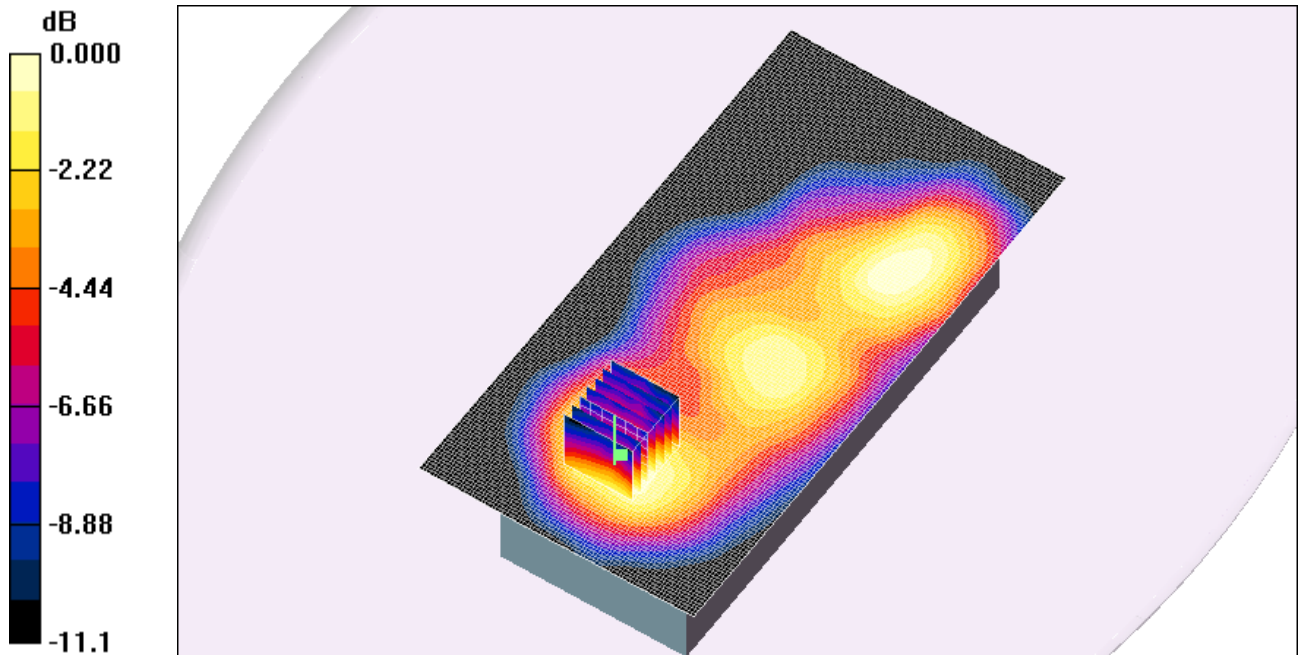

0 dB = 0.215mW/g

16.5.11 GSM 1900+GPRS 4TS-Bodyworn- BackSide -Middle

Date/Time: 2012-10-10 13:09:12

Test Laboratory: SGS-GSM

MobiPrint² GSM 1900+GPRS (4TS) Back Side Middle

DUT: MobiPrint²; Type: GPRS; Serial: 359128040100097

Communication System: PCS1900-GPRS Mode(4 ts); Frequency: 1880 MHz;Duty Cycle: 1:2.075

Medium: HSL1900-Body Medium parameters used: f = 1880 MHz; $\sigma = 1.58$ mho/m; $\epsilon_r = 50.1$; $\rho = 1000$ kg/m³

Phantom section: Flat Section

DASY4 Configuration:

- Probe: ES3DV3 - SN3088; ConvF(4.8, 4.8, 4.8); Calibrated: 2011-11-23
- Sensor-Surface: 4mm (Mechanical Surface Detection)
- Electronics: DAE3 Sn569; Calibrated: 2011-11-16
- Phantom: ELI 4.0; Type: QDOVA001BA; Serial: xxxx
- Measurement SW: DASY4, V4.7 Build 80; Postprocessing SW: SEMCAD, V1.8 Build 186

Middle/Area Scan (81x161x1): **Measurement grid: dx=15mm, dy=15mm**

Maximum value of SAR (interpolated) = 0.266 mW/g

Middle/Zoom Scan (7x7x7)/Cube 0: **Measurement grid: dx=5mm, dy=5mm, dz=5mm**

Reference Value = 8.91 V/m; Power Drift = -0.059 dB

SHEMC

Peak SAR (extrapolated) = 0.302 W/kg

SAR(1 g) = 0.229 mW/g; SAR(10 g) = 0.159 mW/g

Maximum value of SAR (measured) = 0.250 mW/g

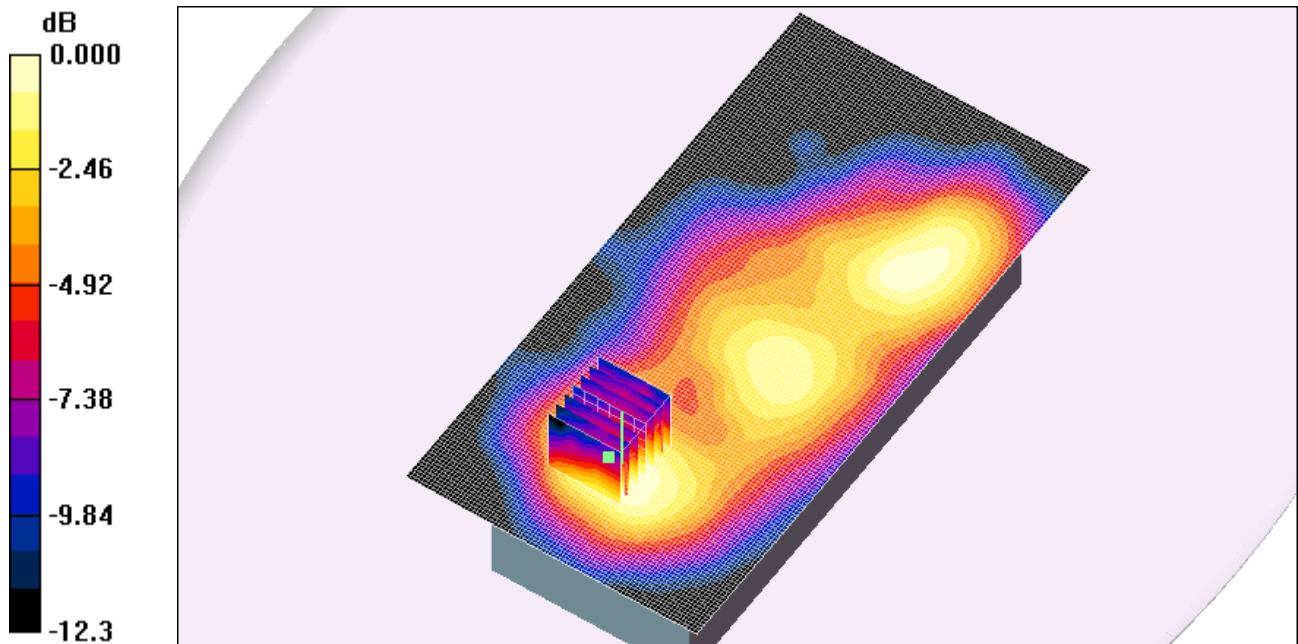

0 dB = 0.250mW/g

16.5.12 GSM 1900+GPRS 4TS-Bodyworn-FrontSide-Middle

Date/Time: 2012-10-10 14:24:51

Test Laboratory: SGS-GSM

MobiPrint² GSM 1900+GPRS(4TS) Front Side Middle

DUT: MobiPrint²; Type: GPRS; Serial: 359128040100097

Communication System: PCS1900-GPRS Mode(4 ts); Frequency: 1880 MHz; Duty Cycle: 1:2.075

Medium: HSL1900-Body Medium parameters used: f = 1880 MHz; $\sigma = 1.58$ mho/m; $\epsilon_r = 50.1$; $\rho = 1000$ kg/m³

Phantom section: Flat Section

DASY4 Configuration:

- Probe: ES3DV3 - SN3088; ConvF(4.8, 4.8, 4.8); Calibrated: 2011-11-23
- Sensor-Surface: 4mm (Mechanical Surface Detection)
- Electronics: DAE3 Sn569; Calibrated: 2011-11-16
- Phantom: ELI 4.0; Type: QDOVA001BA; Serial: xxxx
- Measurement SW: DASY4, V4.7 Build 80; Postprocessing SW: SEMCAD, V1.8 Build 186

Middle/Area Scan (81x161x1): **Measurement grid: dx=15mm, dy=15mm**

Maximum value of SAR (interpolated) = 0.225 mW/g

Middle/Zoom Scan (7x7x7)/Cube 0: **Measurement grid: dx=5mm, dy=5mm, dz=5mm**

Reference Value = 10.1 V/m; Power Drift = -0.265 dB

SHEMC

Peak SAR (extrapolated) = 0.267 W/kg

SAR(1 g) = 0.203 mW/g; SAR(10 g) = 0.140 mW/g

Maximum value of SAR (measured) = 0.229 mW/g

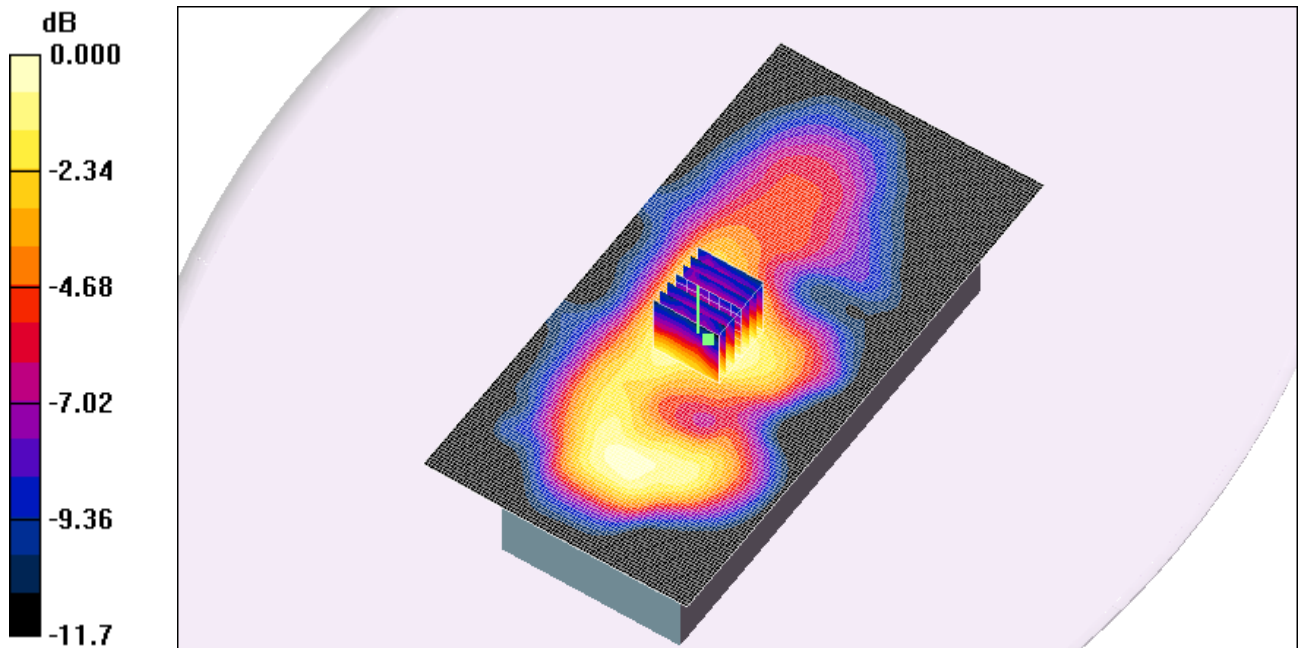

0 dB = 0.229mW/g

16.5.13 GSM 1900+GPRS 4TS-Bodyworn-BackSide-High

Date/Time: 2012-10-10 15:30:16

Test Laboratory: SGS-GSM

MobiPrint² GSM 1900+GPRS(4TS) Back Side High

DUT: MobiPrint²; Type: GPRS; Serial: 359128040100097

Communication System: PCS1900-GPRS Mode(4 ts); Frequency: 1909.8 MHz; Duty Cycle: 1:2.075

Medium: HSL1900-Body Medium parameters used (interpolated): f = 1909.8 MHz; σ = 1.61 mho/m; ϵ_r = 50; ρ = 1000 kg/m³

Phantom section: Flat Section

DASY4 Configuration:

- Probe: ES3DV3 - SN3088; ConvF(4.8, 4.8, 4.8); Calibrated: 2011-11-23
- Sensor-Surface: 4mm (Mechanical Surface Detection)
- Electronics: DAE3 Sn569; Calibrated: 2011-11-16
- Phantom: ELI 4.0; Type: QDOVA001BA; Serial: xxxx
- Measurement SW: DASY4, V4.7 Build 80; Postprocessing SW: SEMCAD, V1.8 Build 186

High/Area Scan (81x161x1): **Measurement grid: dx=15mm, dy=15mm**

Maximum value of SAR (interpolated) = 0.255 mW/g

High/Zoom Scan (7x7x7)/Cube 0: **Measurement grid: dx=5mm, dy=5mm, dz=5mm**

Reference Value = 9.05 V/m; Power Drift = -0.219 dB

SHEMC

Peak SAR (extrapolated) = 0.281 W/kg

SAR(1 g) = 0.215 mW/g; SAR(10 g) = 0.148 mW/g

Maximum value of SAR (measured) = 0.245 mW/g

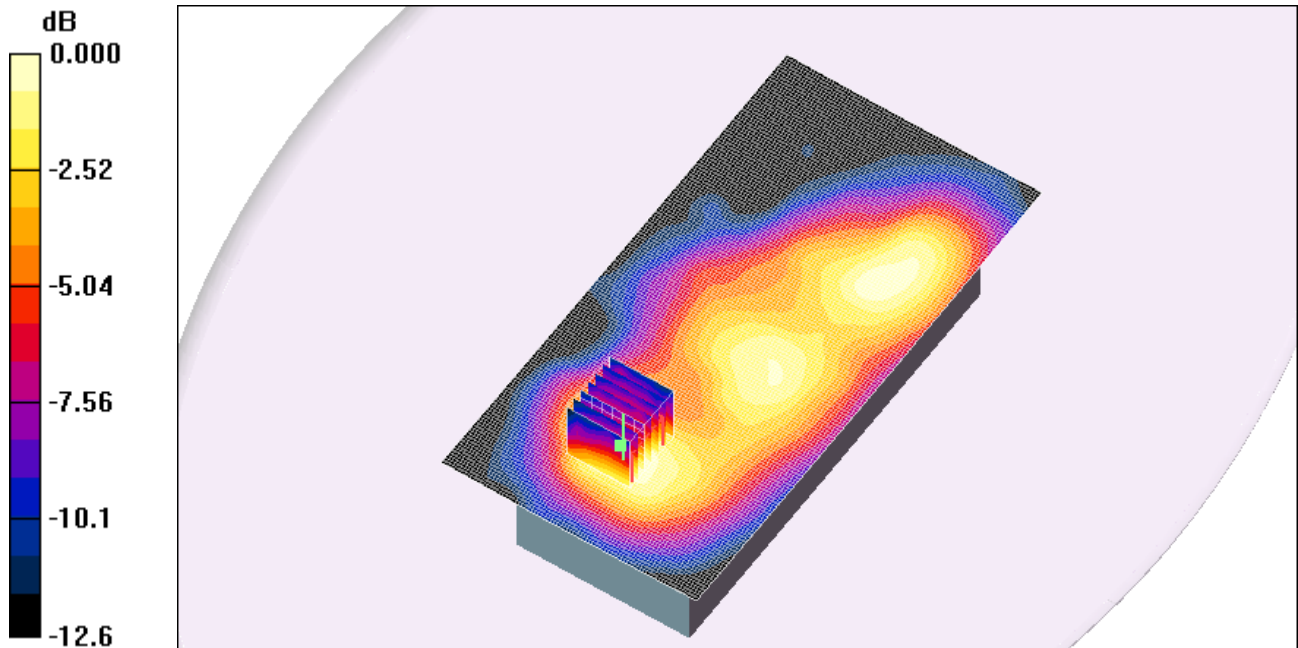

0 dB = 0.245mW/g

16.5.14 GSM 1900+GPRS 4TS-Bodyworn--BackSide-Low

Date/Time: 2012-10-10 16:20:47

Test Laboratory: SGS-GSM

MobiPrint² GSM 1900+GPRS(4TS) Back Side Low

DUT: MobiPrint²; Type: GPRS; Serial: 359128040100097

Communication System: PCS1900-GPRS Mode(4 ts); Frequency: 1850.2 MHz; Duty Cycle: 1:2.075

Medium: HSL1900-Body Medium parameters used (interpolated): f = 1850.2 MHz; $\sigma = 1.55$ mho/m; $\epsilon_r = 50.2$; $\rho = 1000$ kg/m³

Phantom section: Flat Section

DASY4 Configuration:

- Probe: ES3DV3 - SN3088; ConvF(4.8, 4.8, 4.8); Calibrated: 2011-11-23
- Sensor-Surface: 4mm (Mechanical Surface Detection)
- Electronics: DAE3 Sn569; Calibrated: 2011-11-16
- Phantom: ELI 4.0; Type: QDOVA001BA; Serial: xxxx
- Measurement SW: DASY4, V4.7 Build 80; Postprocessing SW: SEMCAD, V1.8 Build 186

Low/Area Scan (81x161x1): **Measurement grid: dx=15mm, dy=15mm**

Maximum value of SAR (interpolated) = 0.273 mW/g

Low/Zoom Scan (7x7x7)/Cube 0: **Measurement grid: dx=5mm, dy=5mm, dz=5mm**

Reference Value = 9.46 V/m; Power Drift = -0.359 dB

SHEMC

Peak SAR (extrapolated) = 0.326 W/kg

SAR(1 g) = 0.241 mW/g; SAR(10 g) = 0.169 mW/g

Maximum value of SAR (measured) = 0.267 mW/g

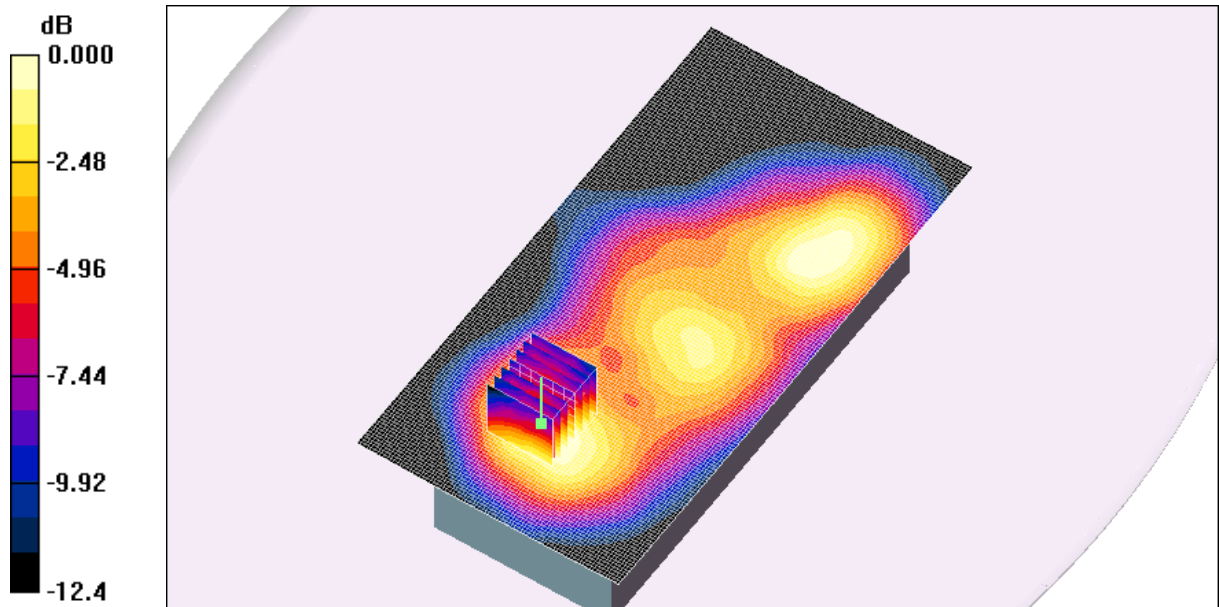

0 dB = 0.267mW/g

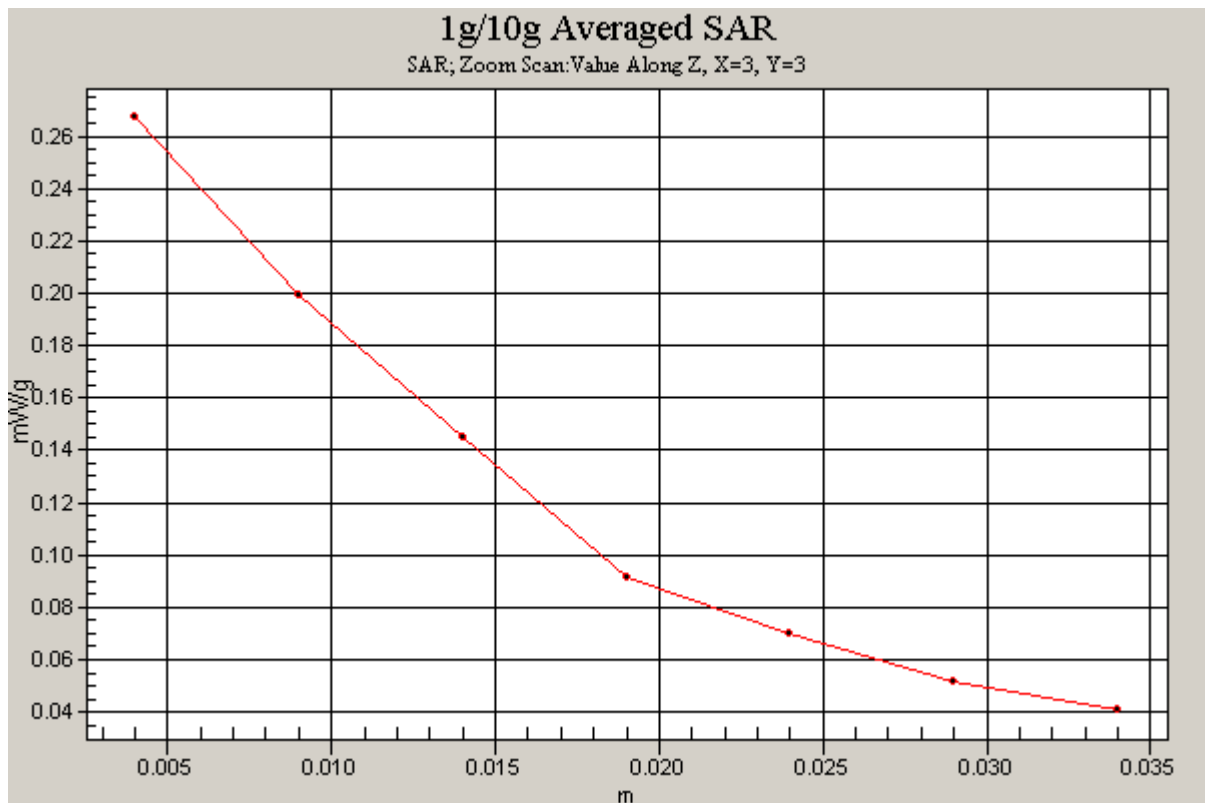

16.5.15 802.11b-Bodyworn-BackSide-High

Date/Time: 2012-10-19 15:27:41

Test Laboratory: SGS-GSM

MobiPrint² 802.11b Back Side High

DUT: MobiPrint²; Type: GPRS; Serial: 359128040100097

Communication System: 802.11b/g; Frequency: 2462 MHz; Duty Cycle: 1:1

Medium: HSL2450-Body Medium parameters used: f = 2462 MHz; σ = 2.01 mho/m; ϵ_r = 51.1; ρ = 1000 kg/m³

Phantom section: Flat Section

DASY4 Configuration:

- Probe: ES3DV3 - SN3088; ConvF(4.35, 4.35, 4.35); Calibrated: 2011-11-23
- Sensor-Surface: 4mm (Mechanical Surface Detection)
- Electronics: DAE3 Sn569; Calibrated: 2011-11-16
- Phantom: SAM 12; Type: SAM V4.0; Serial: TP-1283
- Measurement SW: DASY4, V4.7 Build 80; Postprocessing SW: SEMCAD, V1.8 Build 186

High/Area Scan (71x151x1): **Measurement grid: dx=15mm, dy=15mm**

Maximum value of SAR (interpolated) = 0.027 mW/g

High/Zoom Scan (7x7x7)/Cube 0: **Measurement grid: dx=5mm, dy=5mm, dz=5mm**

Reference Value = 1.34 V/m; Power Drift = 0.16 dB

Peak SAR (extrapolated) = 0.091 W/kg

SAR(1 g) = 0.028 mW/g; SAR(10 g) = 0.016 mW/g

Maximum value of SAR (measured) = 0.038 mW/g

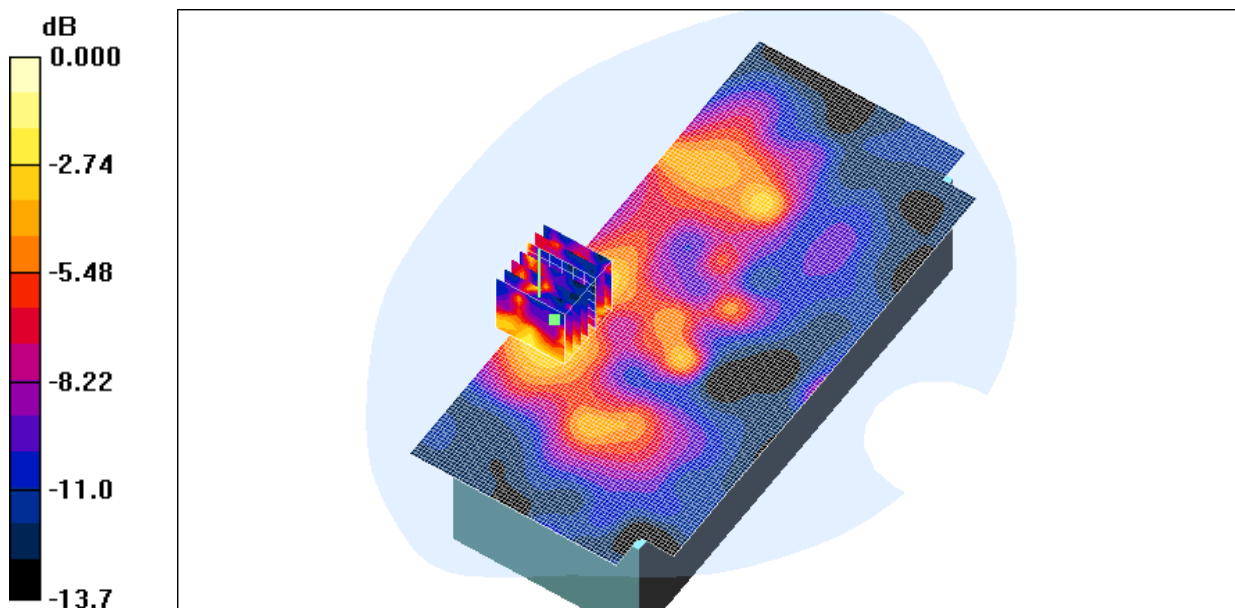

0 dB = 0.038mW/g

SHEMC

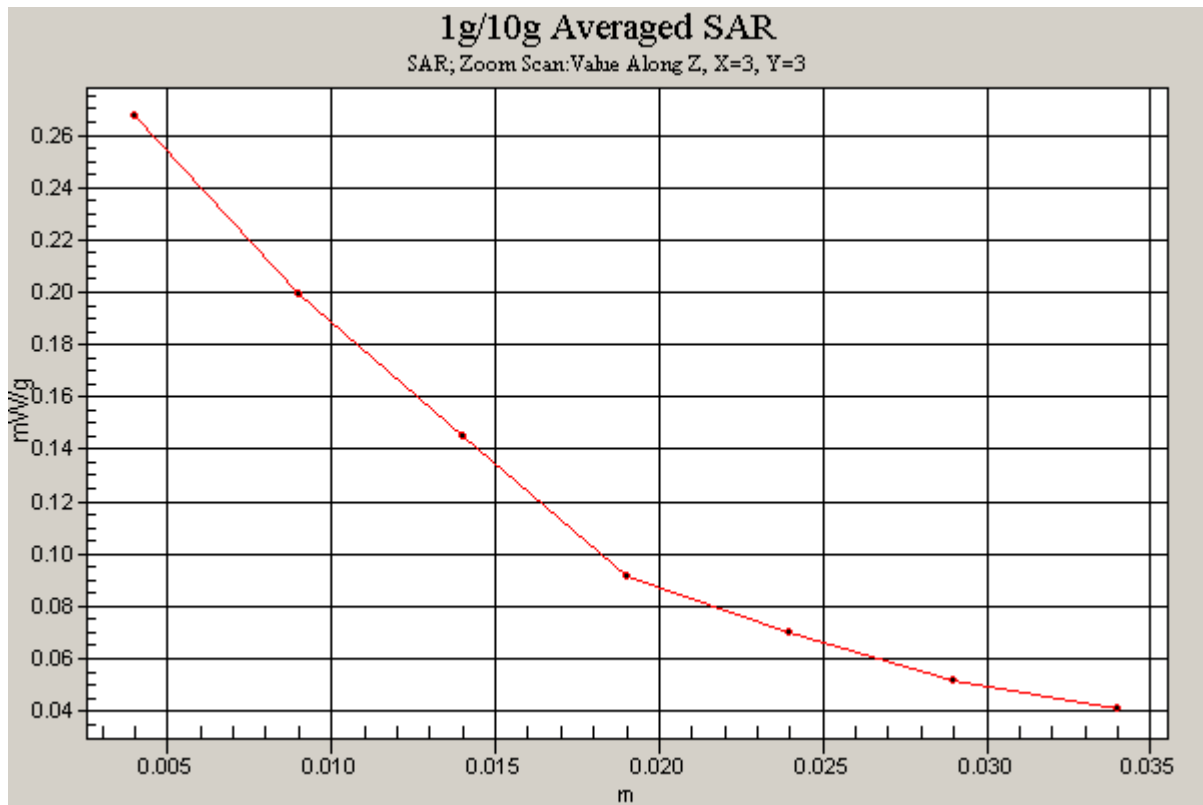

16.5.16 802.11b-Bodyworn-FrontSide-High

Date/Time: 2012-10-19 16:59:10

Test Laboratory: SGS-GSM

MobiPrint² 802.11b Front Side High

DUT: MobiPrint²; Type: GPRS; Serial: 359128040100097

Communication System: 802.11b/g; Frequency: 2462 MHz; Duty Cycle: 1:1

Medium: HSL2450-Body Medium parameters used: f = 2462 MHz; σ = 2.01 mho/m; ϵ_r = 51.1; ρ = 1000 kg/m³

Phantom section: Flat Section

DASY4 Configuration:

- Probe: ES3DV3 - SN3088; ConvF(4.35, 4.35, 4.35); Calibrated: 2011-11-23
- Sensor-Surface: 4mm (Mechanical Surface Detection)
- Electronics: DAE3 Sn569; Calibrated: 2011-11-16
- Phantom: SAM 12; Type: SAM V4.0; Serial: TP-1283
- Measurement SW: DASY4, V4.7 Build 80; Postprocessing SW: SEMCAD, V1.8 Build 186

High/Area Scan (71x151x1): **Measurement grid: dx=15mm, dy=15mm**

Maximum value of SAR (interpolated) = 0.057 mW/g

High/Zoom Scan (7x7x7)/Cube 0: **Measurement grid: dx=5mm, dy=5mm, dz=5mm**

Reference Value = 2.36 V/m; Power Drift = -0.375 dB

SHEMC

Peak SAR (extrapolated) = 0.085 W/kg

SAR(1 g) = 0.048 mW/g; SAR(10 g) = 0.026 mW/g

Maximum value of SAR (measured) = 0.055 mW/g

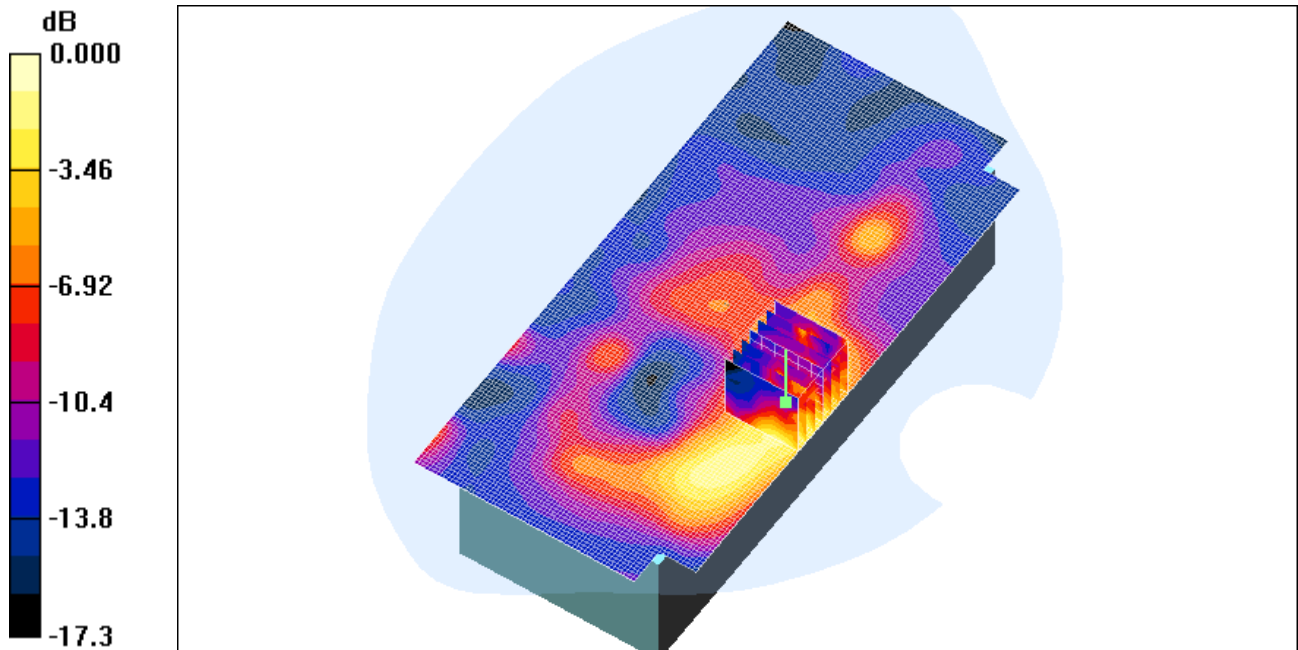

0 dB = 0.055mW/g

16.5.17 802.11g-Bodyworn-FrontSide-High

Date/Time: 2012-10-19 18:32:21

Test Laboratory: SGS-GSM

MobiPrint² 802.11g Front Side High

DUT: MobiPrint²; Type: GPRS; Serial: 359128040100097

Communication System: 802.11b/g; Frequency: 2462 MHz; Duty Cycle: 1:1

Medium: HSL2450-Body Medium parameters used: f = 2462 MHz; σ = 2.01 mho/m; ϵ_r = 51.1; ρ = 1000 kg/m³

Phantom section: Flat Section

DASY4 Configuration:

- Probe: ES3DV3 - SN3088; ConvF(4.35, 4.35, 4.35); Calibrated: 2011-11-23
- Sensor-Surface: 4mm (Mechanical Surface Detection)
- Electronics: DAE3 Sn569; Calibrated: 2011-11-16
- Phantom: SAM 12; Type: SAM V4.0; Serial: TP-1283
- Measurement SW: DASY4, V4.7 Build 80; Postprocessing SW: SEMCAD, V1.8 Build 186

High/Area Scan (71x151x1): **Measurement grid: dx=15mm, dy=15mm**

Maximum value of SAR (interpolated) = 0.053 mW/g

High/Zoom Scan (7x7x7)/Cube 0: **Measurement grid: dx=5mm, dy=5mm, dz=5mm**

Reference Value = 2.33 V/m; Power Drift = -0.312 dB

SHEMC

Peak SAR (extrapolated) = 0.075 W/kg

SAR(1 g) = 0.045 mW/g; SAR(10 g) = 0.024 mW/g

Maximum value of SAR (measured) = 0.055 mW/g

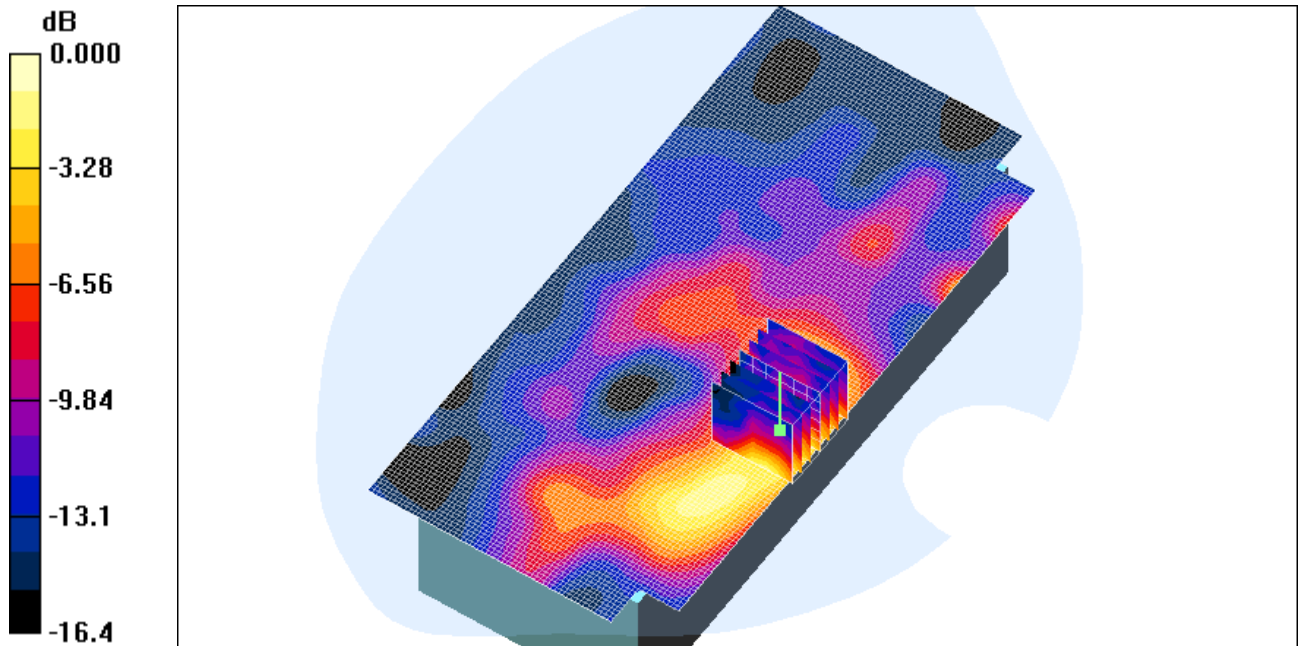

0 dB = 0.055mW/g

16. Identification of Samples

Product Definition	Production Unit	
Device Type	Portable	
Limit Type	General Population/Uncontrolled	
Product Name	MobiWire Mobprinter	
Brand Name	MobiWire	
Marketing Name	MobiWire Mobprinter	
Model Name	MobiPrint ²	
Final Software Version Tested	V00-M121106-MP2-MP	
Final Hardware Version Tested	V03	
Battery Type	N/A	
	N/A	
Antenna Type	Inner antenna	
GSM Frequency Bands	GSM850	Tx: 824~849MHz
		Rx: 869~894MHz
	PCS1900	Tx:1850~1910MHz
		Rx:1930~1990MHz
WIFI Frequency Bands	802.11b	Tx/Rx: 2.412~2.462GHz
	802.11g	Tx/Rx: 2.412~2.462GHz
Modulation Mode	GMSK/OFDM	
Power Class	GSM 850	4
	PCS 1900	1
GPRS Multislot class	12	
IMEI	359128040100097	
Date of receipt	10-08, 2012	
Date of Testing Start	10-09, 2012	
Date of Testing End	10-19, 2012	

17. Photographs of EUT



Fig.18-1 Front Side of EUT



Fig.18-2 Back Side of EUT

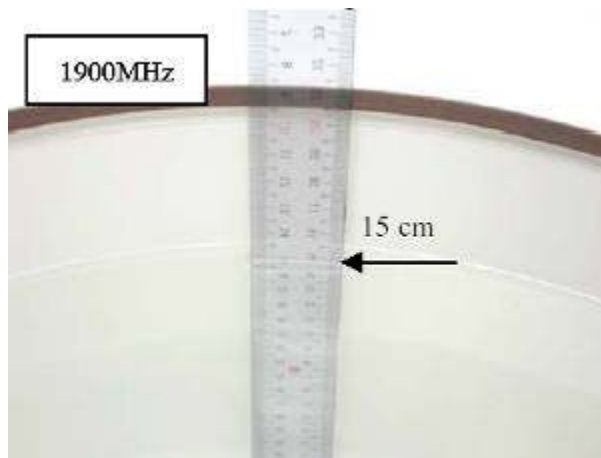
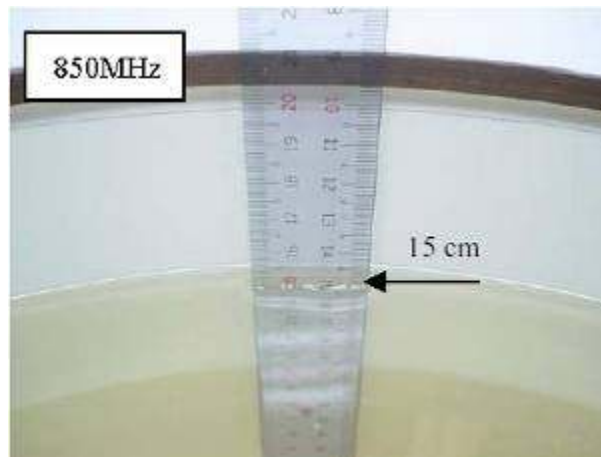

Fig.18-3 Battery

Annex A Photographs of Test Setup



Fig.A-1 Photograph of the SAR measurement System



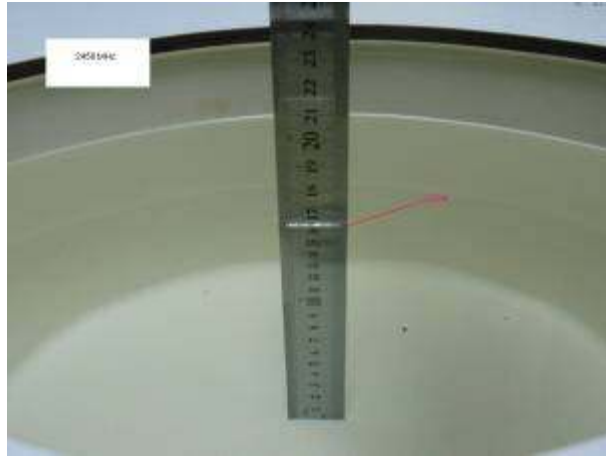

Fig.A-2 Photograph of the Tissue Simulant Liquid depth 15cm for Body Worn



Fig.A-3a Photograph of the Front Side status



Fig.A-3b Photograph of the Back Side status

Annex B

Tissue Simulant Liquid

**Annex B.1
Liquid**

Recipes for Tissue Simulant

The following tables give the recipes for tissue simulating liquids to be used in different frequency bands.

Frequency (MHz)	835		900		1800-2000		2450	
Tissue Type	Head	Body	Head	Body	Head	Body	Head	Body
Ingredient (% by weight)								
Water	40.30	50.75	40.30	50.75	55.24	70.17	62.7	73.26
Salt (NaCl)	1.38	0.94	1.38	0.94	0.31	0.39	0.5	0.04
Sucrose	57.90	48.21	57.90	48.21	0	0	0	0
HEC	0.24	0	0.24	0	0	0	0	0
Bactericide	0.18	0.10	0.10	0.10	0	0	0	0
DGBE	0	0	0	0	44.45	29.44	36.8	26.7
Measurement dielectric parameters								
Dielectric Constant	41.9	55.0	41.1	54.5	39.2	53.2	39.8	52.5
Conductivity (S/m)	0.93	0.97	1.04	1.06	1.45	1.59	1.88	1.78
Target values								
Dielectric Constant	41.5	55.2	41.5	55.0	40.0	53.3	39.2	52.7
Conductivity (S/m)	0.90	0.97	0.97	1.05	1.40	1.52	1.80	1.95
Salt: 99+% Pure Sodium Chloride					Sucrose: 98+% Pure Sucrose			
Water: De-ionized, 16 MΩ ⁺ resistivity					HEC: Hydroxyethyl Cellulose			
DGBE: 99+% Di(ethylene glycol) butyl ether, [2-(2-butoxyethoxy)ethanol]								

Table B-1 Recipe of Tissue Simulat Liquid

**Annex B.2
Simulant Liquid**

Measurement for Tissue

The dielectric properties for this Tissue Simulant Liquids were measured by using the Agilent Model 85070D Dielectric Probe (rates frequency band 200 MHz to 20 GHz) in conjunction with Agilent E5071B Network Analyzer (300 KHz-8500 MHz). The Conductivity (σ) and Permittivity (ρ) are listed in Table 1. For the SAR measurement given in this report. The temperature variation of the Tissue Simulant Liquids was $22 \pm 2^\circ\text{C}$.

Frequency (MHz)	Tissue Type	Limit/Measured	Permittivity (ρ)	Conductivity (σ)	Temp ($^\circ\text{C}$)
835	Body	Recommended Limit	55.2 \pm 5% (52.44~57.96)	0.97 \pm 5% (0.922~1.02)	22 \pm 2
		Measured, 10-09,2012	56.5	0.988	21.5
1900	Body	Recommended Limit	53.3 \pm 5% (50.64~55.97)	1.52 \pm 5% (1.44~1.60)	22 \pm 2
		Measured, 10-10,2012	53.4	1.52	21.6
2450	Body	Recommended Limit	52.7 \pm 5% (50.07~55.34)	1.95 \pm 5% (1.85~2.05)	22 \pm 2
		Measured, 10-19,2012	51.3	2.01	21.5

Table B-2 Measurement result of Tissue electric parameters

Annex C

SAR System Validation

The microwave circuit arrangement for system verification is sketched in Fig. C-1. The daily system accuracy verification occurs within the flat section of the SAM phantom. A SAR measurement was performed to see if the measured SAR was within +/- 10% from the target SAR values. These tests were done at 835&1900MHz. The tests were conducted on the same days as the measurement of the EUT. The obtained results from the system accuracy verification are displayed in the table C-1 (A power level of 250mw was input to the dipole antenna). During the tests, the ambient temperature of the laboratory was in the range 22°C, the relative humidity was in the range 60% and the liquid depth above the ear reference points was above 15 cm in all the cases. It is seen that the system is operating within its specification, as the results are within acceptable tolerance of the reference values.

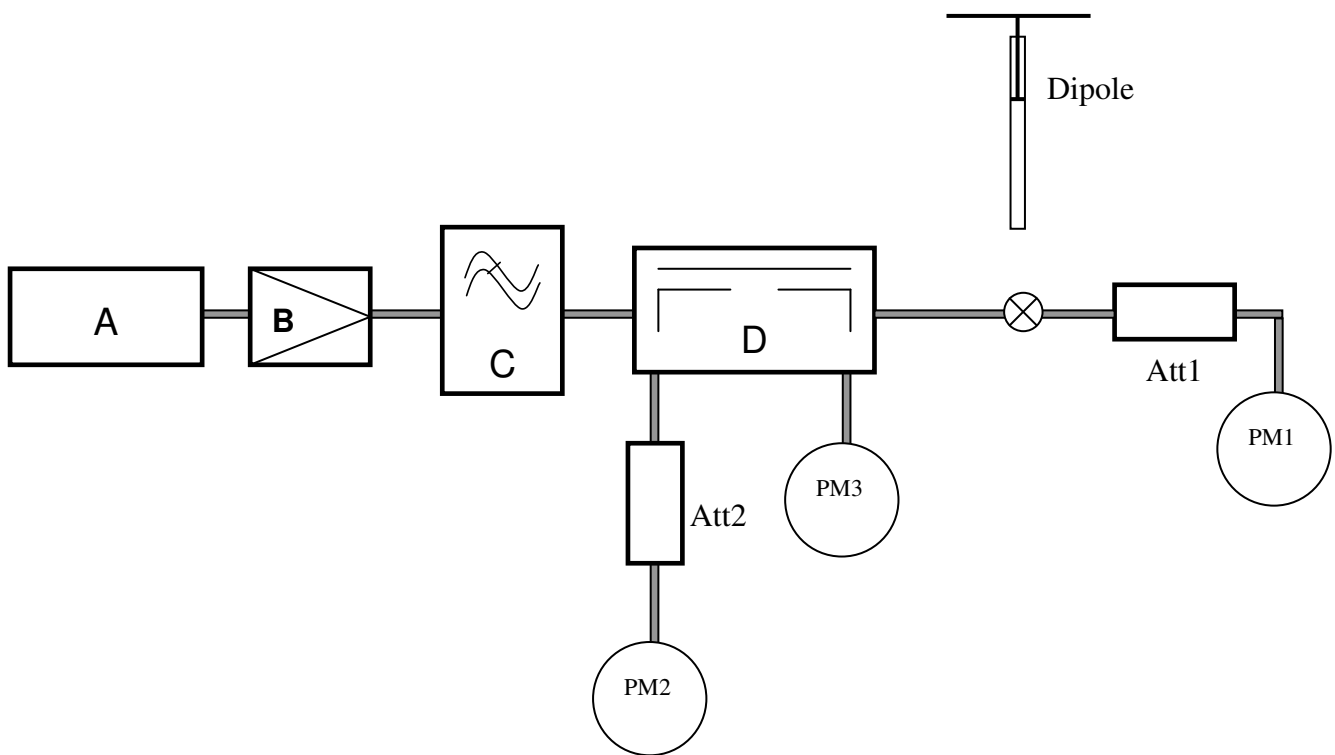

Fig. C-1 the microwave circuit arrangement used for SAR system verification

- | | |
|------|---|
| A. | Agilent E4438C Signal Generator |
| B. | Mini-Circuit ZHL-42 Preamplifier |
| C. | Mini-Circuit VLF-2500+ Low Pass Filter |
| D. | Mini-Circuits ZABDC20-252H-N+ Bi-DIR Coupling |
| PM1. | Power Sensor NRP-Z92 |

PM2. Agilent Model E4416A Power Meter

PM3. Power Sensor NRP-Z92

Validation Kit	Frequency (MHz)	Tissue Type	Limit/Measurement		
			Condition	Recommended/Measured	1g
D835V2	835	Body	Calibration data		2.43
			Nomalized to 1mW(for nominal Head TSL parameters)	Recommended Limit	9.72±10% (8.75~10.69)
			Nomalized to 1W(for nominal Head TSL parameters)	-	9.8
			250mW input power	Measured, 10-09, 2012	2.45
D1900V2	1900	Body	Calibration data		10.6
			Nomalized to 1mW(for nominal Head TSL parameters)	Recommended Limit	42.4±10% (38.16~46.64)
			Nomalized to 1W(for nominal Head TSL parameters)	-	42
			250mW input power	Measured, 10-10, 2012	10.5
D2450V2	2450	Body	Calibration data		13.2
			Nomalized to 1mW(for nominal Head TSL parameters)	Recommended Limit	52.8±10% (47.52-58.08)
			Nomalized to 1W(for nominal Head TSL parameters)	-	49.2
			250mW input power	Measured, 10-19, 2012	12.3

Table C-1 SAR System Validation Result

System Validation for 835MHz-Body

Date/Time: 2012-10-9 7:56:03

Test Laboratory: SGS-GSM

System Performance Check at 835MHz Body

DUT: Dipole 835MHz; Type: D835V2; Serial: D835V2 - SN:4d105

Communication System: CW; Frequency: 835 MHz; Duty Cycle: 1:1

Medium: HSL835_Body Medium parameters used: $f = 835 \text{ MHz}$; $\sigma = 0.988 \text{ mho/m}$; $\epsilon_r = 56.5$; $\rho = 1000 \text{ kg/m}^3$

Phantom section: Flat Section

DASY4 Configuration:

- Probe: ES3DV3 - SN3088; ConvF(6.13, 6.13, 6.13); Calibrated: 2011-11-23
- Sensor-Surface: 4mm (Mechanical Surface Detection)
- Electronics: DAE3 Sn569; Calibrated: 2011-11-16
- Phantom: SAM 12; Type: SAM V4.0; Serial: TP-1283
- Measurement SW: DASY4, V4.7 Build 80; Postprocessing SW: SEMCAD, V1.8 Build 186

$d=15\text{mm}$, $P_{in}=250\text{mW}$ 2/Area Scan (61x121x1): **Measurement grid: $dx=15\text{mm}$, $dy=15\text{mm}$**

Maximum value of SAR (interpolated) = 2.68 mW/g

$d=15\text{mm}$, $P_{in}=250\text{mW}$ /Zoom Scan (7x7x7) (7x7x7)/Cube 0: **Measurement grid: $dx=5\text{mm}$, $dy=5\text{mm}$, $dz=5\text{mm}$**

Reference Value = 52.1 V/m; Power Drift = 0.175 dB

Peak SAR (extrapolated) = 3.66 W/kg

SAR(1 g) = 2.45 mW/g; SAR(10 g) = 1.56 mW/g

Maximum value of SAR (measured) = 2.63 mW/g

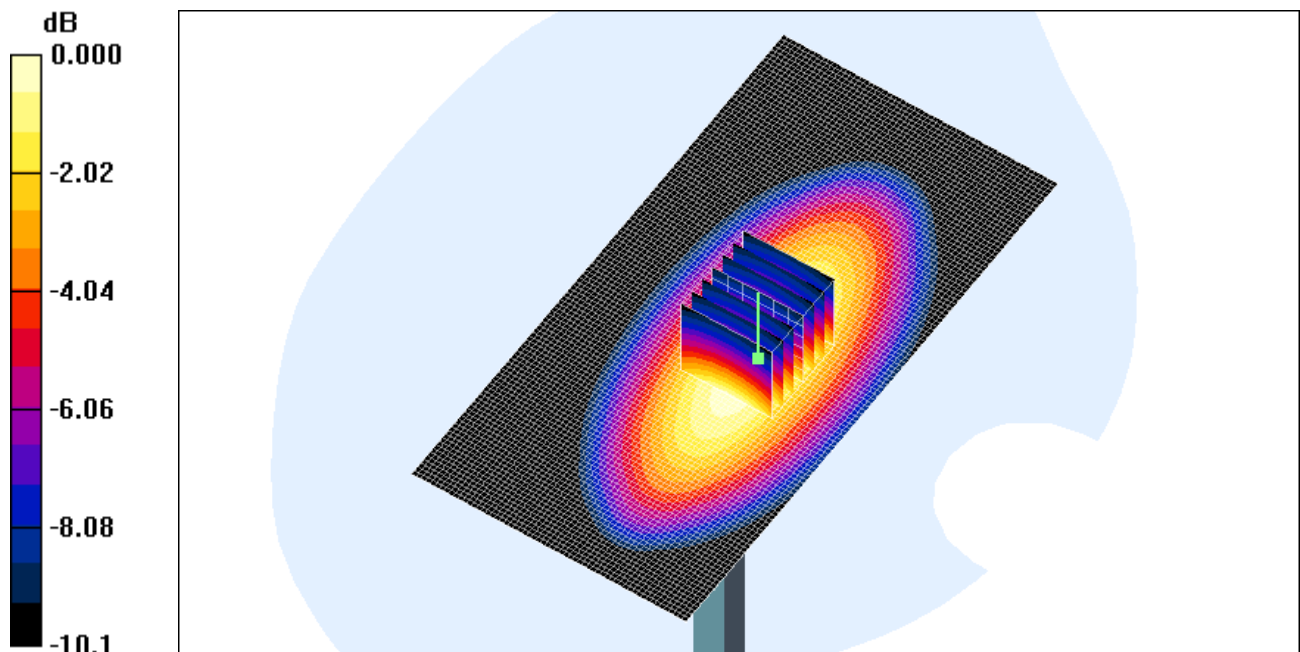

0 dB = 2.63mW/g

SHEMC

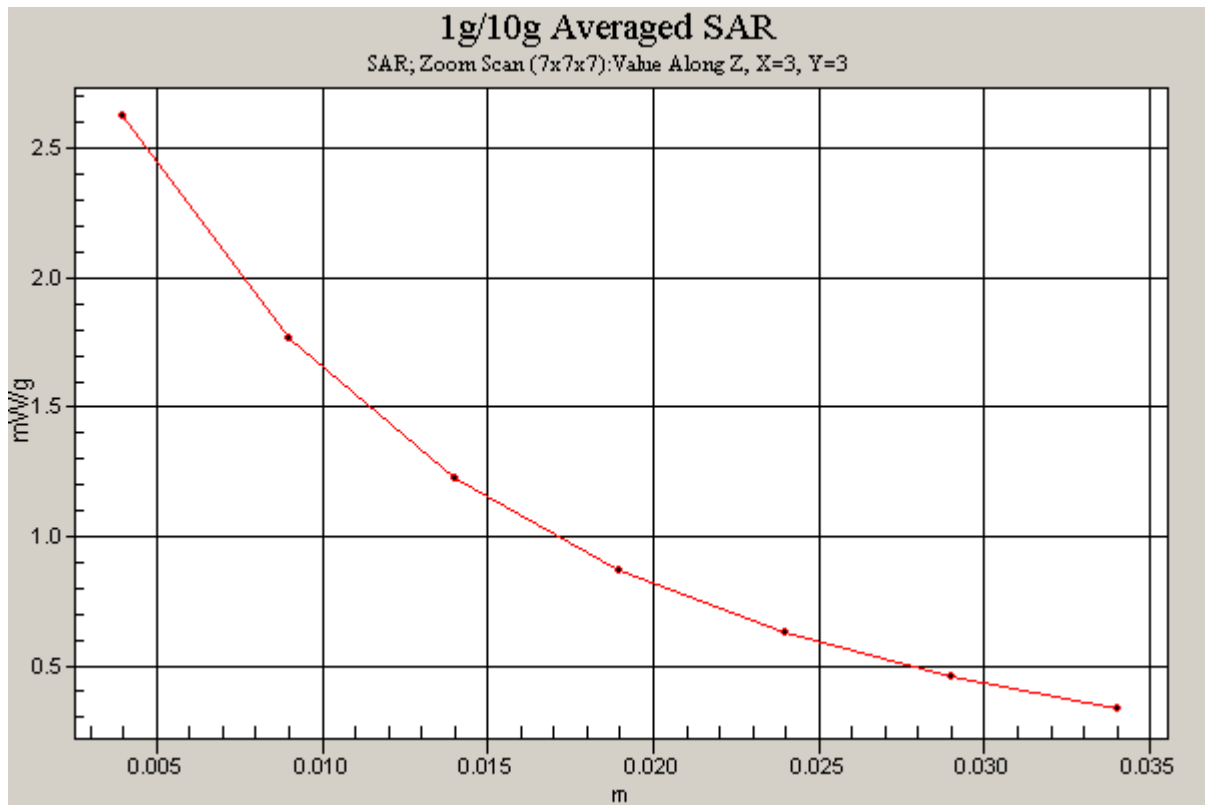

System Validation for 1900MHz-Body

Date/Time: 2012-10-10 8:35:24

Test Laboratory: SGS-GSM

System Performance Check at 1900 MHz Body

DUT: Dipole 1900 MHz; Type: D1900V2; Serial: D1900V2 - SN:5d028

Communication System: CW; Frequency: 1900 MHz; Duty Cycle: 1:1

Medium: HSL1900-Body Medium parameters used: $f = 1900 \text{ MHz}$; $\sigma = 1.52 \text{ mho/m}$; $\epsilon_r = 53.4$; $\rho = 1000 \text{ kg/m}^3$

Phantom section: Flat Section

DASY4 Configuration:

- Probe: ES3DV3 - SN3088; ConvF(4.8, 4.8, 4.8); Calibrated: 2011-11-23
- Sensor-Surface: 4mm (Mechanical Surface Detection)
- Electronics: DAE3 Sn569; Calibrated: 2011-11-16
- Phantom: SAM 12; Type: SAM V4.0; Serial: TP-1283
- Measurement SW: DASY4, V4.7 Build 80; Postprocessing SW: SEMCAD, V1.8 Build 186

$d=10\text{mm}$, $P_{in}=250\text{mW}$ /Area Scan (61x101x1): **Measurement grid: $dx=15\text{mm}$, $dy=15\text{mm}$**

Maximum value of SAR (interpolated) = 12.7 mW/g

SHEMC

d=10mm, Pin=250mW/Zoom Scan (7x7x7) (7x7x7)/Cube 0: Measurement grid: dx=5mm, dy=5mm, dz=5mm

Reference Value = 77.1 V/m; Power Drift = 0.169 dB

Peak SAR (extrapolated) = 19.2 W/kg

SAR(1 g) = 10.5 mW/g; SAR(10 g) = 5.44 mW/g

Maximum value of SAR (measured) = 12.8 mW/g

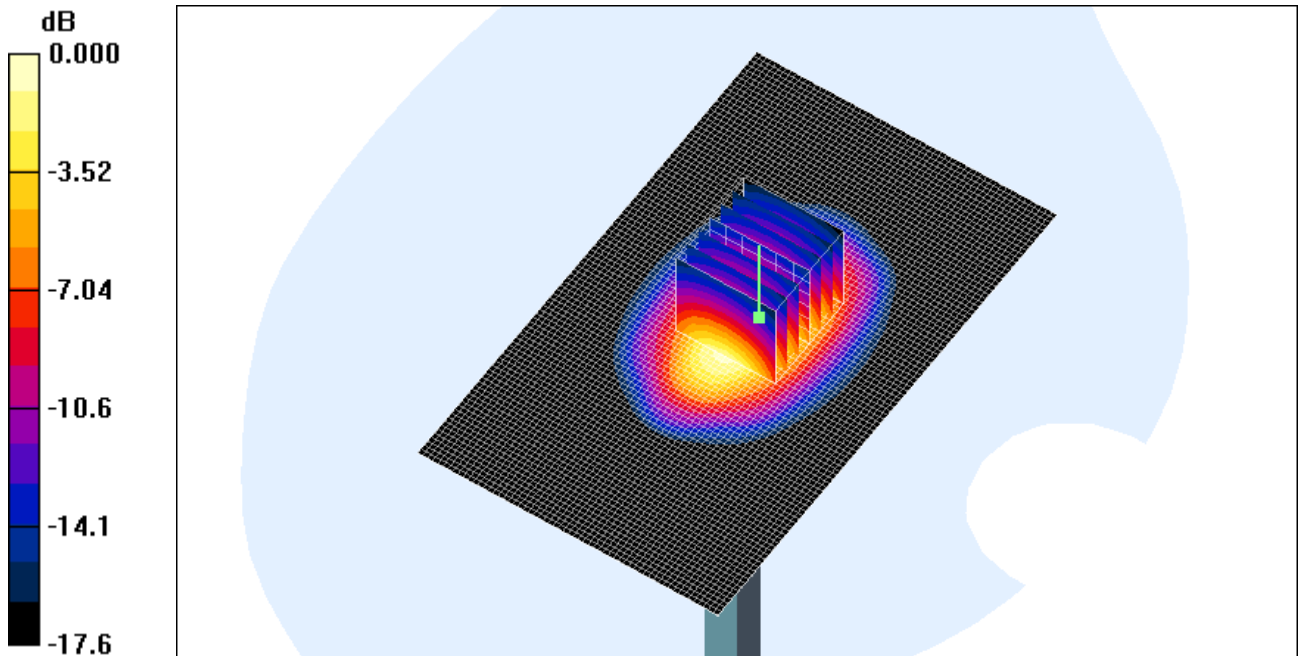

0 dB = 12.8mW/g

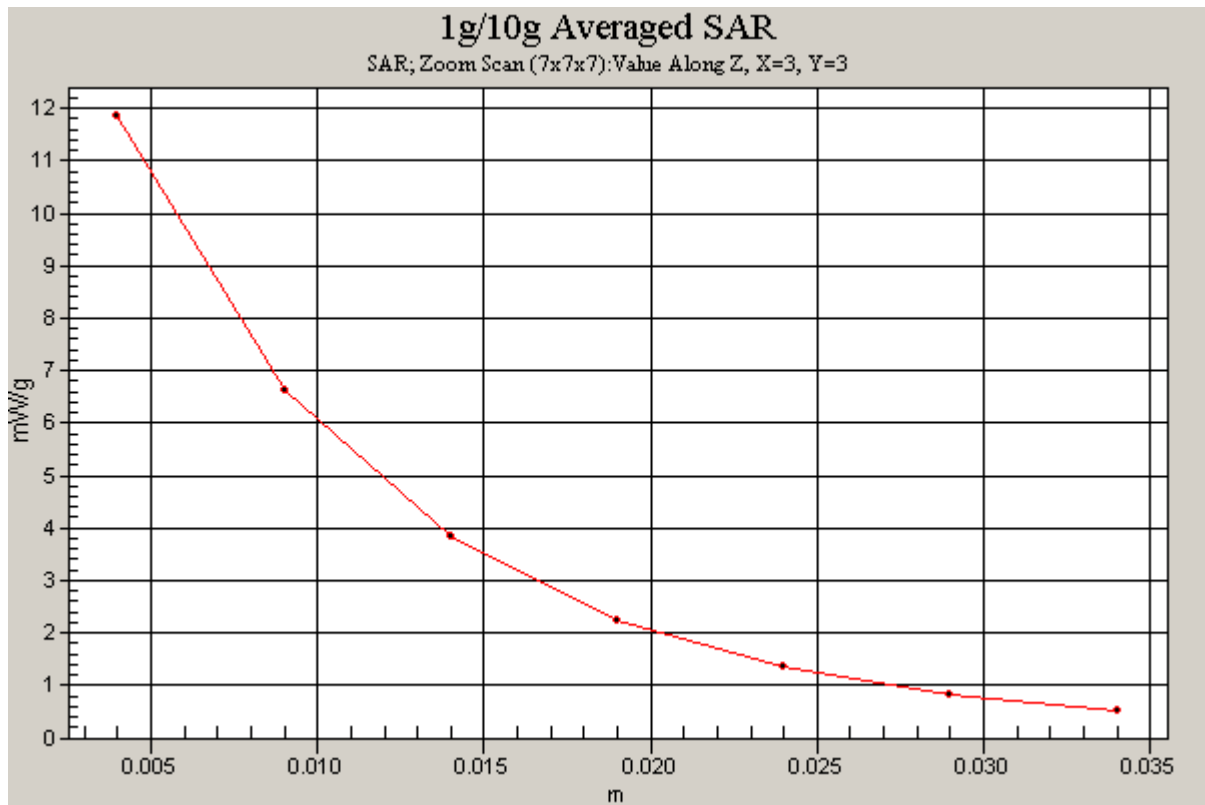

System Performance Check at 2450MHzBody

Date/Time: 2012-10-19 8:04:40

Test Laboratory: SGS-GSM

System Performance Check at 2450MHzBody

DUT: Dipole 2450 MHz; Type: D2450V2; Serial: D2450V2 - SN:733

Communication System: CW; Frequency: 2450 MHz; Duty Cycle: 1:1

Medium: HSL2450-Body Medium parameters used: f = 2450 MHz; $\sigma = 2.01$ mho/m; $\epsilon_r = 51.3$; $\rho = 1000$ kg/m³

Phantom section: Flat Section

DASY4 Configuration:

- Probe: ES3DV3 - SN3088; ConvF(4.35, 4.35, 4.35); Calibrated: 2011-11-23
- Sensor-Surface: 4mm (Mechanical Surface Detection)
- Electronics: DAE3 Sn569; Calibrated: 2011-11-16
- Phantom: ELI 4.0; Type: QDOVA001BA; Serial: xxxx
- Measurement SW: DASY4, V4.7 Build 80; Postprocessing SW: SEMCAD, V1.8 Build 186

d=10mm, Pin=250mW /Area Scan (61x101x1): **Measurement grid: dx=15mm, dy=15mm**

Maximum value of SAR (interpolated) = 15.2 mW/g

d=10mm, Pin=250mW /Zoom Scan (7x7x7) (7x7x7)/Cube 0: **Measurement grid: dx=5mm, dy=5mm, dz=5mm**

SHEMC

Reference Value = 83.8 V/m; Power Drift = -0.181 dB

Peak SAR (extrapolated) = 23.5W/kg

SAR(1 g) = 12.3 mW/g; SAR(10 g) = 5.75 mW/g

Maximum value of SAR (measured) = 14.1 mW/g

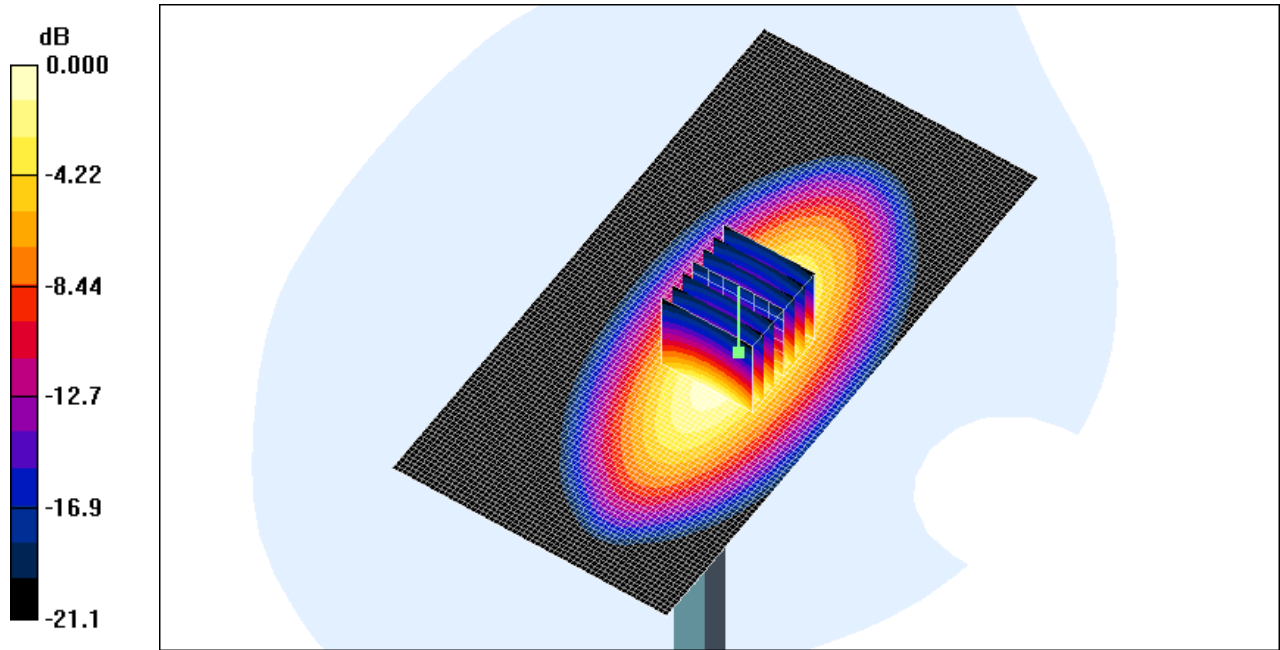

0 dB = 14.1mW/g

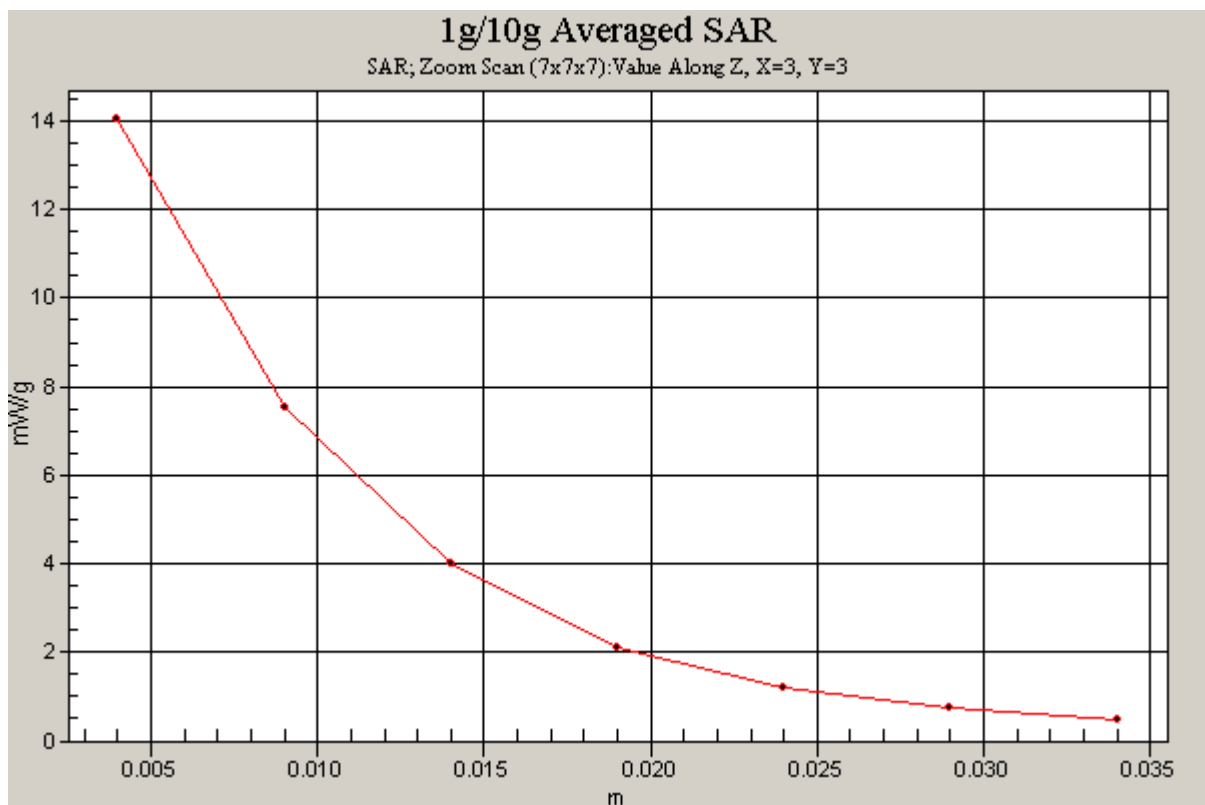

Annex D Calibration certificate

Annex D.1 Probe Calibration certificate

**Calibration Laboratory of
Schmid & Partner
Engineering AG**
Zeughausstrasse 43, 8004 Zurich, Switzerland



S Schweizerischer Kalibrierdienst
C Service suisse d'étalonnage
S Servizio svizzero di taratura
Swiss Calibration Service

Accredited by the Swiss Accreditation Service (SAS)
The Swiss Accreditation Service is one of the signatories to the EA
Multilateral Agreement for the recognition of calibration certificates

Accreditation No.: **SCS 108**

Client **SGS-SH (Auden)**

Certificate No: **ES3-3088_Nov11**

CALIBRATION CERTIFICATE

Object **ES3DV3 - SN:3088**

Calibration procedure(s) **QA CAL-01.v8, QA CAL-23.v4, QA CAL-25.v4
Calibration procedure for dosimetric E-field probes**

Calibration date: **November 23, 2011**

This calibration certificate documents the traceability to national standards, which realize the physical units of measurements (SI).
The measurements and the uncertainties with confidence probability are given on the following pages and are part of the certificate.

All calibrations have been conducted in the closed laboratory facility: environment temperature (22 ± 3)°C and humidity < 70%.

Calibration Equipment used (M&TE critical for calibration)

Primary Standards	ID	Cal Date (Certificate No.)	Scheduled Calibration
Power meter E4419B	GB41293874	31-Mar-11 (No. 217-01372)	Apr-12
Power sensor E4412A	MY41498067	31-Mar-11 (No. 217-01372)	Apr-12
Reference 3 dB Attenuator	SN: 85084 (30a)	29-Mar-11 (No. 217-01369)	Apr-12
Reference 20 dB Attenuator	SN: 55086 (20b)	29-Mar-11 (No. 217-01367)	Apr-12
Reference 30 dB Attenuator	SN: 55129 (30b)	29-Mar-11 (No. 217-01370)	Apr-12
Reference Probe ES3DV2	SN: 3013	29-Dec-10 (No. ES3-3013_Dec10)	Dec-11
DAE4	SN: 654	3-May-11 (No. DAE4-654_May11)	May-12
Secondary Standards	ID	Check Date (in house)	Scheduled Check
RF generator HP 8640C	US3642U01700	4-Aug-99 (in house check Apr-11)	In house check: Apr-13
Network Analyzer HP 8753E	US37390585	18-Oct-01 (in house check Oct-11)	In house check: Oct-12

	Name	Function	Signature
Calibrated by:	Jeton Kasrati	Laboratory Technician	
Approved by:	Katja Pokovic	Technical Manager	

Issued: November 23, 2011

This calibration certificate shall not be reproduced except in full without written approval of the laboratory.

**Calibration Laboratory of
Schmid & Partner
Engineering AG**
Zeughausstrasse 43, 8004 Zurich, Switzerland



S Schweizerischer Kalibrierdienst
C Service suisse d'étalonnage
S Servizio svizzero di taratura
S Swiss Calibration Service

Accredited by the Swiss Accreditation Service (SAS)

Accreditation No.: **SCS 108**

The Swiss Accreditation Service is one of the signatories to the EA
Multilateral Agreement for the recognition of calibration certificates

Glossary:

TSL	tissue simulating liquid
NORM _{x,y,z}	sensitivity in free space
ConvF	sensitivity in TSL / NORM _{x,y,z}
DCP	diode compression point
CF	crest factor (1/duty_cycle) of the RF signal
A, B, C	modulation dependent linearization parameters
Polarization φ	φ rotation around probe axis
Polarization θ	θ rotation around an axis that is in the plane normal to probe axis (at measurement center), i.e., $\theta = 0$ is normal to probe axis

Calibration is Performed According to the Following Standards:

- IEEE Std 1528-2003, "IEEE Recommended Practice for Determining the Peak Spatial-Averaged Specific Absorption Rate (SAR) in the Human Head from Wireless Communications Devices: Measurement Techniques", December 2003
- IEC 62209-1, "Procedure to measure the Specific Absorption Rate (SAR) for hand-held devices used in close proximity to the ear (frequency range of 300 MHz to 3 GHz)", February 2005

Methods Applied and Interpretation of Parameters:

- NORM_{x,y,z}:** Assessed for E-field polarization $\theta = 0$ ($f \leq 900$ MHz in TEM-cell; $f > 1800$ MHz: R22 waveguide). NORM_{x,y,z} are only intermediate values, i.e., the uncertainties of NORM_{x,y,z} does not affect the E²-field uncertainty inside TSL (see below ConvF).
- NORM(f)_{x,y,z} = NORM_{x,y,z} * frequency_response** (see Frequency Response Chart). This linearization is implemented in DASY4 software versions later than 4.2. The uncertainty of the frequency response is included in the stated uncertainty of ConvF.
- DCP_{x,y,z}:** DCP are numerical linearization parameters assessed based on the data of power sweep with CW signal (no uncertainty required). DCP does not depend on frequency nor media.
- PAR:** PAR is the Peak to Average Ratio that is not calibrated but determined based on the signal characteristics
- A_{x,y,z}; B_{x,y,z}; C_{x,y,z}; VR_{x,y,z}:** A, B, C are numerical linearization parameters assessed based on the data of power sweep for specific modulation signal. The parameters do not depend on frequency nor media. VR is the maximum calibration range expressed in RMS voltage across the diode.
- ConvF and Boundary Effect Parameters:** Assessed in flat phantom using E-field (or Temperature Transfer Standard for $f \leq 800$ MHz) and inside waveguide using analytical field distributions based on power measurements for $f > 800$ MHz. The same setups are used for assessment of the parameters applied for boundary compensation (alpha, depth) of which typical uncertainty values are given. These parameters are used in DASY4 software to improve probe accuracy close to the boundary. The sensitivity in TSL corresponds to NORM_{x,y,z} * ConvF whereby the uncertainty corresponds to that given for ConvF. A frequency dependent ConvF is used in DASY version 4.4 and higher which allows extending the validity from ± 50 MHz to ± 100 MHz.
- Spherical isotropy (3D deviation from isotropy):** in a field of low gradients realized using a flat phantom exposed by a patch antenna.
- Sensor Offset:** The sensor offset corresponds to the offset of virtual measurement center from the probe tip (on probe axis). No tolerance required.

ES3DV3 – SN:3088

November 23, 2011

Probe ES3DV3

SN:3088

Manufactured: July 20, 2005
Calibrated: November 23, 2011

Calibrated for DASYS/EASY Systems
(Note: non-compatible with DASYS2 system!)

ES3DV3- SN:3088

November 23, 2011

DASY/EASY - Parameters of Probe: ES3DV3 - SN:3088

Basic Calibration Parameters

	Sensor X	Sensor Y	Sensor Z	Unc (k=2)
Norm ($\mu\text{V}/(\text{V}/\text{m})^2$) ^A	1.29	1.27	1.20	$\pm 10.1\%$
DCP (mV) ^B	95.8	94.9	95.8	

Modulation Calibration Parameters

UID	Communication System Name	PAR		A dB	B dB	C dB	VR mV	Unc ^E (k=2)
10000	CW	0.00	X	0.00	0.00	1.00	147.7	$\pm 2.5\%$
			Y	0.00	0.00	1.00	112.2	
			Z	0.00	0.00	1.00	138.9	

The reported uncertainty of measurement is stated as the standard uncertainty of measurement multiplied by the coverage factor k=2, which for a normal distribution corresponds to a coverage probability of approximately 95%.

^A The uncertainties of NormX, Y, Z do not affect the E²-field uncertainty inside TSL. (see Pages 5 and 6).

^B Numerical linearization parameter: uncertainty not required.

^E Uncertainty is determined using the max. deviation from linear response applying rectangular distribution and is expressed for the square of the field value.

ES3DV3-SN:3088

November 23, 2011

DASY/EASY - Parameters of Probe: ES3DV3 - SN:3088

Calibration Parameter Determined in Head Tissue Simulating Media

f (MHz) ^C	Relative Permittivity ^F	Conductivity (S/m) ^F	ConvF X	ConvF Y	ConvF Z	Alpha	Depth (mm)	Unct. (k=2)
835	41.5	0.90	6.09	6.09	6.09	0.80	1.00	± 12.0 %
900	41.5	0.97	5.96	5.96	5.96	0.80	1.22	± 12.0 %
1810	40.0	1.40	5.13	5.13	5.13	0.80	1.26	± 12.0 %
1900	40.0	1.40	5.05	5.05	5.05	0.80	1.23	± 12.0 %
1950	40.0	1.40	4.90	4.90	4.90	0.80	1.24	± 12.0 %
2450	39.2	1.80	4.41	4.41	4.41	0.80	1.26	± 12.0 %

^C Frequency validity of ± 100 MHz only applies for DASY v4.4 and higher (see Page 2), else it is restricted to ± 50 MHz. The uncertainty is the RSS of the ConvF uncertainty at calibration frequency and the uncertainty for the indicated frequency band.

^F At frequencies below 3 GHz, the validity of tissue parameters (ϵ and σ) can be relaxed to ± 10% if liquid compensation formula is applied to measured SAR values. At frequencies above 3 GHz, the validity of tissue parameters (ϵ and σ) is restricted to ± 5%. The uncertainty is the RSS of the ConvF uncertainty for indicated target tissue parameters.

ES3DV3- SN:3088

November 23, 2011

DASY/EASY - Parameters of Probe: ES3DV3- SN:3088

Calibration Parameter Determined in Body Tissue Simulating Media

f (MHz) ^c	Relative Permittivity ^f	Conductivity (S/m) ^f	ConvF X	ConvF Y	ConvF Z	Alpha	Depth (mm)	Unct. (k=2)
835	55.2	0.97	6.13	6.13	6.13	0.80	1.00	± 12.0 %
1900	53.3	1.52	4.80	4.80	4.80	0.80	1.31	± 12.0 %
2450	52.7	1.95	4.35	4.35	4.35	0.80	1.22	± 12.0 %

^c Frequency validity of ± 100 MHz only applies for DASY v4.4 and higher (see Page 2), else it is restricted to ± 50 MHz. The uncertainty is the RSS of the ConvF uncertainty at calibration frequency and the uncertainty for the indicated frequency band.

^f At frequencies below 3 GHz, the validity of tissue parameters (ϵ and σ) can be relaxed to ± 10% if liquid compensation formula is applied to measured SAR values. At frequencies above 3 GHz, the validity of tissue parameters (ϵ and σ) is restricted to ± 5%. The uncertainty is the RSS of the ConvF uncertainty for indicated target tissue parameters.

ES3DV3- SN:3088

November 23, 2011

Frequency Response of E-Field (TEM-Cell:ifi110 EXX, Waveguide: R22)

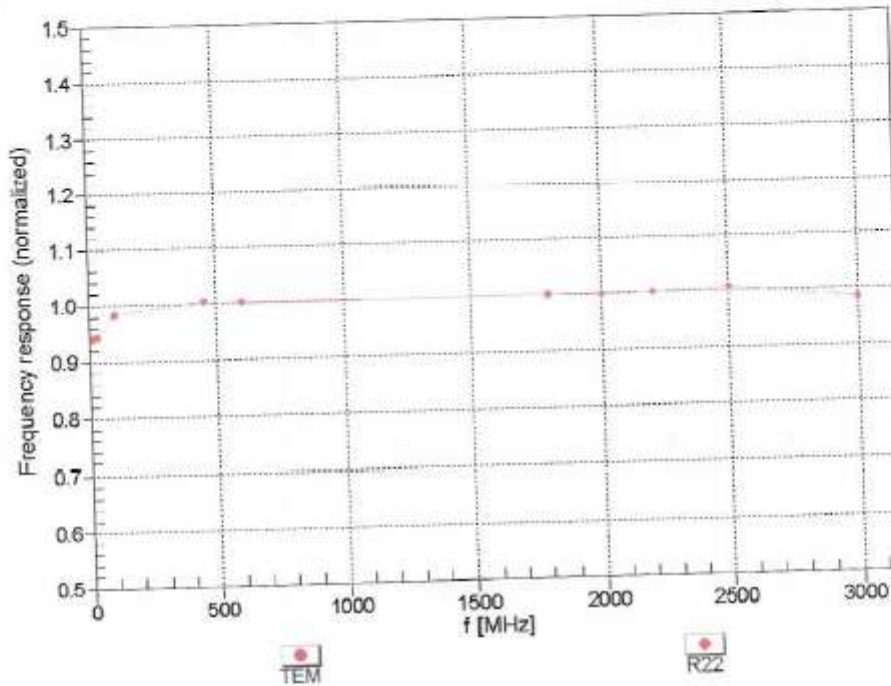

Uncertainty of Frequency Response of E-field: $\pm 6.3\%$ (k=2)

ES3DV3- SN:3088

November 23, 2011

Receiving Pattern (ϕ), $\theta = 0^\circ$

f=600 MHz,TEM

f=1800 MHz,R22

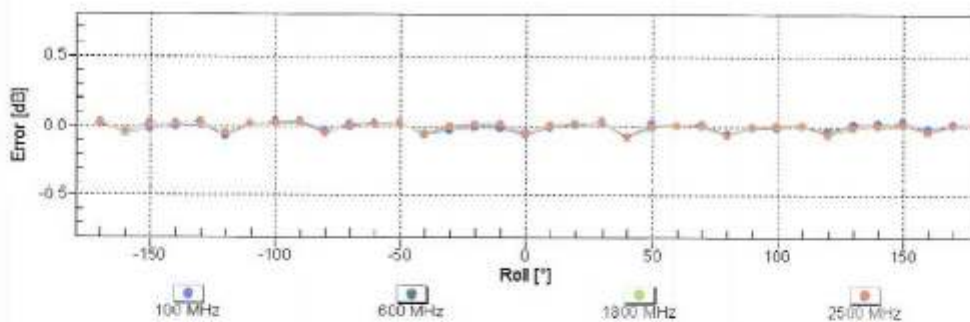
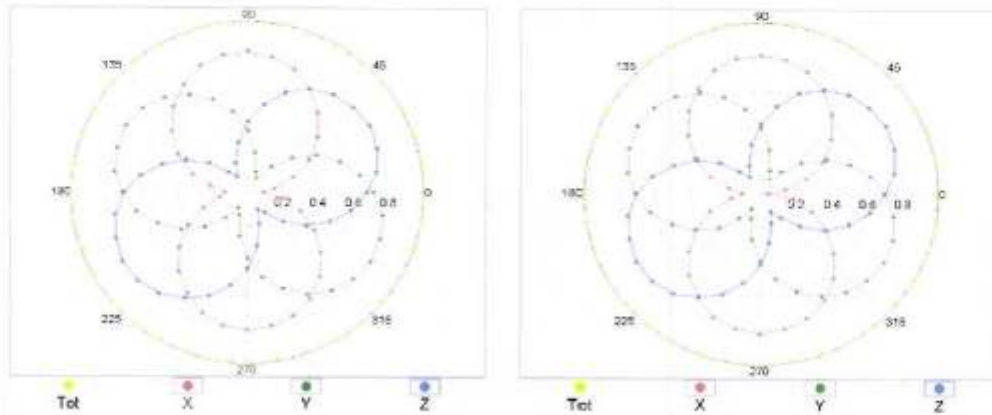

Uncertainty of Axial Isotropy Assessment: $\pm 0.5\%$ (k=2)

ES3DV3- SN:3088

November 23, 2011

Dynamic Range f(SAR_{head}) (TEM cell , f = 900 MHz)

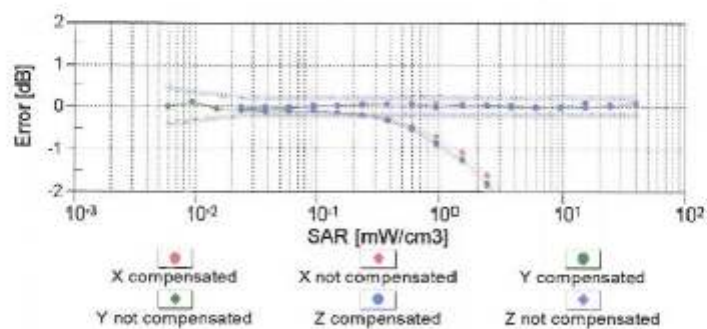
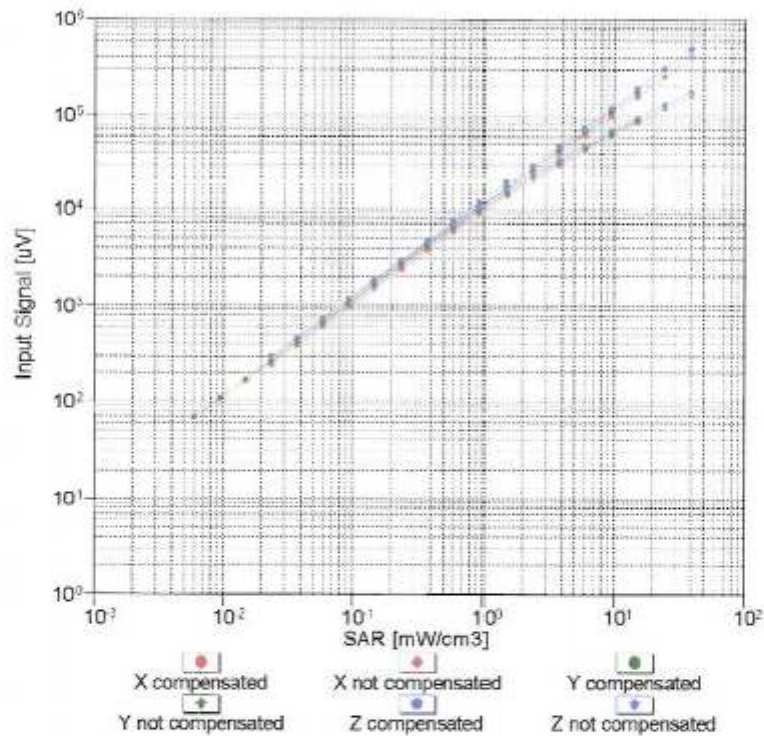

Uncertainty of Linearity Assessment: ± 0.6% (k=2)

ES3DV3-SN:3088

November 23, 2011

Conversion Factor Assessment

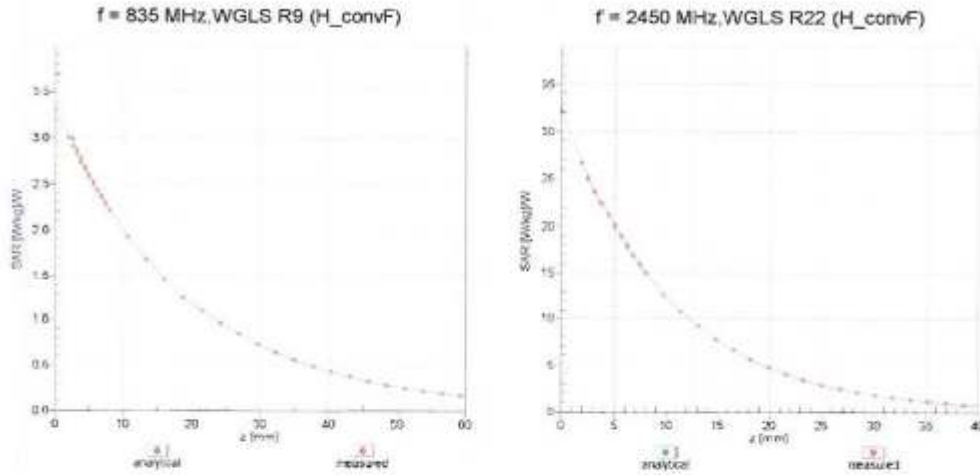

Deviation from Isotropy in Liquid

Error (ϕ, θ), f = 900 MHz

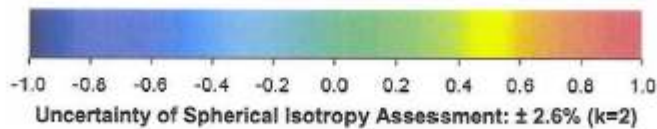
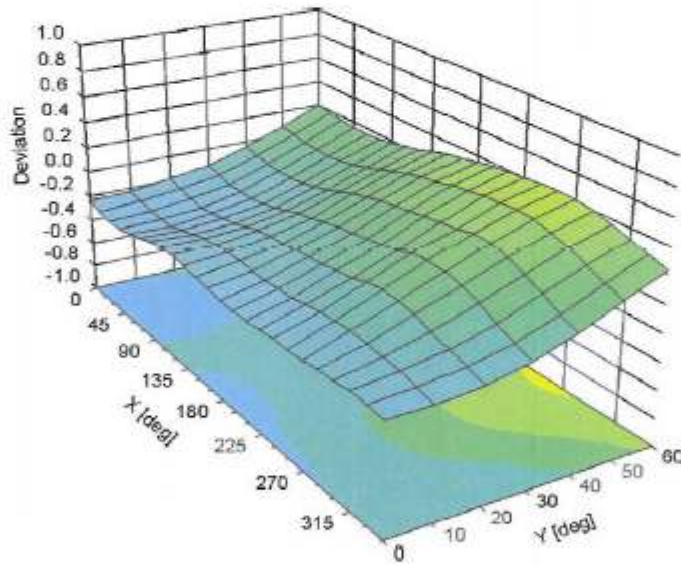

ES3DV3- SN:3088

November 23, 2011

DASY/EASY - Parameters of Probe: ES3DV3 - SN:3088

Other Probe Parameters

Sensor Arrangement	Triangular
Connector Angle (°)	Not applicable
Mechanical Surface Detection Mode	enabled
Optical Surface Detection Mode	disabled
Probe Overall Length	337 mm
Probe Body Diameter	10 mm
Tip Length	10 mm
Tip Diameter	4 mm
Probe Tip to Sensor X Calibration Point	2 mm
Probe Tip to Sensor Y Calibration Point	2 mm
Probe Tip to Sensor Z Calibration Point	2 mm
Recommended Measurement Distance from Surface	3 mm

Annex D.2 DAE Calibration certification

**Calibration Laboratory of
 Schmid & Partner
 Engineering AG**
 Zeughausstrasse 43, 8004 Zurich, Switzerland



S Schweizerischer Kalibrierdienst
C Service suisse d'étalonnage
S Servizio svizzero di taratura
S Swiss Calibration Service

Accredited by the Swiss Accreditation Service (SAS)
 The Swiss Accreditation Service is one of the signatories to the EA
 Multilateral Agreement for the recognition of calibration certificates

Accreditation No.: **SCS 108**

Client **SGS - SH (Auden)**

Certificate No: **DAE3-569_Nov11**

CALIBRATION CERTIFICATE

Object: **DAE3 - SD 000 D03 AA - SN: 569**

Calibration procedure(s): **QA CAL-06.v23
 Calibration procedure for the data acquisition electronics (DAE)**

Calibration date: **November 16, 2011**

This calibration certificate documents the traceability to national standards, which realize the physical units of measurements (SI).
 The measurements and the uncertainties with confidence probability are given on the following pages and are part of the certificate.

All calibrations have been conducted in the closed laboratory facility: environment temperature (22 ± 3)°C and humidity < 70%.

Calibration Equipment used (M&TE critical for calibration)

Primary Standards	ID #	Cal Date (Certificate No.)	Scheduled Calibration
Keithley Multimeter Type 2001	SN: 0810278	28-Sep-11 (No:11450)	Sep-12
Secondary Standards	ID #	Check Date (in house)	Scheduled Check
Calibrator Box V1.1	SE UMS 006 AB 1004	08-Jun-11 (in house check)	In house check: Jun-12

Calibrated by:	Name Andrea Guntli	Function Technician	Signature
Approved by:	Name Fin Bornholt	Function R&D Director	Signature

Issued: November 16, 2011

This calibration certificate shall not be reproduced except in full without written approval of the laboratory.

**Calibration Laboratory of
Schmid & Partner
Engineering AG**
Zeughausstrasse 43, 8004 Zurich, Switzerland



S Schweizerischer Kalibrierdienst
S Service suisse d'étalonnage
S Servizio svizzero di taratura
S Swiss Calibration Service

Accredited by the Swiss Accreditation Service (SAS)
The Swiss Accreditation Service is one of the signatories to the EA
Multilateral Agreement for the recognition of calibration certificates

Accreditation No.: **SCS 108**

Glossary

DAE data acquisition electronics
Connector angle information used in DASY system to align probe sensor X to the robot coordinate system.

Methods Applied and Interpretation of Parameters

- **DC Voltage Measurement:** Calibration Factor assessed for use in DASY system by comparison with a calibrated instrument traceable to national standards. The figure given corresponds to the full scale range of the voltmeter in the respective range.
- **Connector angle:** The angle of the connector is assessed measuring the angle mechanically by a tool inserted. Uncertainty is not required.
- The following parameters as documented in the Appendix contain technical information as a result from the performance test and require no uncertainty.
 - **DC Voltage Measurement Linearity:** Verification of the Linearity at +10% and -10% of the nominal calibration voltage. Influence of offset voltage is included in this measurement.
 - **Common mode sensitivity:** Influence of a positive or negative common mode voltage on the differential measurement.
 - **Channel separation:** Influence of a voltage on the neighbor channels not subject to an input voltage.
 - **AD Converter Values with inputs shorted:** Values on the internal AD converter corresponding to zero input voltage
 - **Input Offset Measurement:** Output voltage and statistical results over a large number of zero voltage measurements.
 - **Input Offset Current:** Typical value for information; Maximum channel input offset current, not considering the input resistance.
 - **Input resistance:** Typical value for information: DAE input resistance at the connector, during internal auto-zeroing and during measurement.
 - **Low Battery Alarm Voltage:** Typical value for information. Below this voltage, a battery alarm signal is generated.
 - **Power consumption:** Typical value for information. Supply currents in various operating modes.

DC Voltage Measurement

A/D - Converter Resolution nominal

High Range: 1LSB = 6.1μV, full range = -100...+300 mV

Low Range: 1LSB = 61nV, full range = -1.....+3mV

DASY measurement parameters: Auto Zero Time: 3 sec; Measuring time: 3 sec

Calibration Factors	X	Y	Z
High Range	402.918 ± 0.1% (k=2)	403.325 ± 0.1% (k=2)	403.506 ± 0.1% (k=2)
Low Range	3.94257 ± 0.7% (k=2)	3.94078 ± 0.7% (k=2)	3.92857 ± 0.7% (k=2)

Connector Angle

Connector Angle to be used in DASY system	263.0 ° ± 1 °
---	---------------

Appendix

1. DC Voltage Linearity

High Range	Reading (μV)	Difference (μV)	Error (%)
Channel X + Input	200007.5	1.98	0.00
Channel X + Input	19999.63	-1.17	-0.01
Channel X - Input	-19997.26	2.24	-0.01
Channel Y + Input	200006.9	2.80	0.00
Channel Y + Input	20001.35	1.55	0.01
Channel Y - Input	-19997.50	2.70	-0.01
Channel Z + Input	200004.2	0.86	0.00
Channel Z + Input	19994.71	-4.99	-0.02
Channel Z - Input	-20001.67	-1.57	0.01

Low Range	Reading (μV)	Difference (μV)	Error (%)
Channel X + Input	1999.4	-0.60	-0.03
Channel X + Input	200.87	1.07	0.53
Channel X - Input	-199.13	0.77	-0.39
Channel Y + Input	2000.1	0.21	0.01
Channel Y + Input	200.59	0.59	0.29
Channel Y - Input	-201.62	-1.72	0.86
Channel Z + Input	2000.1	0.03	0.00
Channel Z + Input	198.40	-1.60	-0.80
Channel Z - Input	-201.77	-1.97	0.99

2. Common mode sensitivity

DASY measurement parameters: Auto Zero Time: 3 sec; Measuring time: 3 sec

	Common mode Input Voltage (mV)	High Range Average Reading (μV)	Low Range Average Reading (μV)
Channel X	200	-0.68	-2.49
	-200	3.05	1.36
Channel Y	200	5.33	4.90
	-200	-6.28	-6.47
Channel Z	200	-13.18	-13.80
	-200	11.54	11.47

3. Channel separation

DASY measurement parameters: Auto Zero Time: 3 sec; Measuring time: 3 sec

	Input Voltage (mV)	Channel X (μV)	Channel Y (μV)	Channel Z (μV)
Channel X	200	-	2.33	-0.60
Channel Y	200	2.89	-	1.02
Channel Z	200	3.15	0.34	-

4. AD-Converter Values with inputs shorted

DASY measurement parameters: Auto Zero Time: 3 sec; Measuring time: 3 sec

	High Range (LSB)	Low Range (LSB)
Channel X	16177	17130
Channel Y	16550	16855
Channel Z	15783	17570

5. Input Offset Measurement

DASY measurement parameters: Auto Zero Time: 3 sec; Measuring time: 3 sec

Input 10MΩ

	Average (μV)	min. Offset (μV)	max. Offset (μV)	Std. Deviation (μV)
Channel X	-0.10	-1.63	1.64	0.67
Channel Y	-0.72	-2.14	0.76	0.67
Channel Z	-1.16	-2.30	0.64	0.50

6. Input Offset Current

Nominal input circuitry offset current on all channels: <25fA

7. Input Resistance (Typical values for information)

	Zeroing (kOhm)	Measuring (MOhm)
Channel X	200	200
Channel Y	200	200
Channel Z	200	200

8. Low Battery Alarm Voltage (Typical values for information)

Typical values	Alarm Level (VDC)
Supply (+ Vcc)	+7.9
Supply (- Vcc)	-7.6

9. Power Consumption (Typical values for information)

Typical values	Switched off (mA)	Stand by (mA)	Transmitting (mA)
Supply (+ Vcc)	+0.01	+6	+14
Supply (- Vcc)	-0.01	-8	-9

Annex D.3 Dipole Calibration certification

D835V2

Calibration Laboratory of
 Schmid & Partner
 Engineering AG
 Zeughausstrasse 43, 8004 Zurich, Switzerland



S Schweizerischer Kalibrierdienst
 C Service suisse d'étalonnage
 S Servizio svizzero di taratura
 S Swiss Calibration Service

Accredited by the Swiss Accreditation Service (SAS)
 The Swiss Accreditation Service is one of the signatories to the EA
 Multilateral Agreement for the recognition of calibration certificates

Accreditation No.: SCS 108

Client: SGS-SH (Auden)

Certificate No: D835V2-4d105_Nov11

CALIBRATION CERTIFICATE			
Object	D835V2 - SN: 4d105		
Calibration procedure(s)	QA CAL-05.v8 Calibration procedure for dipole validation kits above 700 MHz		
Calibration date:	November 11, 2011		
<p>This calibration certificate documents the traceability to national standards, which realize the physical units of measurements (SI). The measurements and the uncertainties with confidence probability are given on the following pages and are part of the certificate.</p> <p>All calibrations have been conducted in the closed laboratory facility: environment temperature (22 ± 3)°C and humidity < 70%.</p> <p>Calibration Equipment used (M&TE critical for calibration)</p>			
Primary Standards	ID #	Cal Date (Certificate No.)	Scheduled Calibration
Power meter EPM-442A	GB37480704	05-Oct-11 (No. 217-01451)	Oct-12
Power sensor HP 8481A	US37292763	05-Oct-11 (No. 217-01451)	Oct-12
Reference 20 dB Attenuator	SN: 5086 (20g)	29-Mar-11 (No. 217-01368)	Apr-12
Type-N mismatch combination	SN: 5047.2 / 06327	29-Mar-11 (No. 217-01371)	Apr-12
Reference Probe ES3DV3	SN: 3205	29-Apr-11 (No. ES3-3205_Apr11)	Apr-12
DAE4	SN: 601	04-Jul-11 (No. DAE4-601_Jul11)	Jul-12
Secondary Standards	ID #	Check Date (in house)	Scheduled Check
Power sensor HP 8481A	MY41092317	18-Oct-02 (in house check Oct-11)	In house check: Oct-13
RF generator R&S SMT-06	100005	04-Aug-99 (in house check Oct-11)	In house check: Oct-13
Network Analyzer HP 8753E	US37390585 S4206	18-Oct-01 (in house check Oct-11)	In house check: Oct-12
Calibrated by:	Name Dimca Iliev	Function Laboratory Technician	Signature
Approved by:	Name Katja Pokovic	Function Technical Manager	Signature
			Issued: November 11, 2011
This calibration certificate shall not be reproduced except in full without written approval of the laboratory.			

Certificate No: D835V2-4d105_Nov11

Page 1 of 8

SHEMC

**Calibration Laboratory of
Schmid & Partner
Engineering AG**
Zeughausstrasse 43, 8004 Zurich, Switzerland



S Schweizerischer Kalibrierdienst
C Service suisse d'étalonnage
S Servizio svizzero di taratura
S Swiss Calibration Service

Accredited by the Swiss Accreditation Service (SAS)
The Swiss Accreditation Service is one of the signatories to the EA
Multilateral Agreement for the recognition of calibration certificates

Accreditation No.: **SCS 108**

Glossary:

TSL tissue simulating liquid
ConvF sensitivity in TSL / NORM x,y,z
N/A not applicable or not measured

Calibration is Performed According to the Following Standards:

- a) IEEE Std 1528-2003, "IEEE Recommended Practice for Determining the Peak Spatial-Averaged Specific Absorption Rate (SAR) in the Human Head from Wireless Communications Devices: Measurement Techniques", December 2003
- b) IEC 62209-1, "Procedure to measure the Specific Absorption Rate (SAR) for hand-held devices used in close proximity to the ear (frequency range of 300 MHz to 3 GHz)", February 2005
- c) Federal Communications Commission Office of Engineering & Technology (FCC OET), "Evaluating Compliance with FCC Guidelines for Human Exposure to Radiofrequency Electromagnetic Fields; Additional Information for Evaluating Compliance of Mobile and Portable Devices with FCC Limits for Human Exposure to Radiofrequency Emissions", Supplement C (Edition 01-01) to Bulletin 65

Additional Documentation:

- d) DASY4/5 System Handbook

Methods Applied and Interpretation of Parameters:

- *Measurement Conditions:* Further details are available from the Validation Report at the end of the certificate. All figures stated in the certificate are valid at the frequency indicated.
- *Antenna Parameters with TSL:* The dipole is mounted with the spacer to position its feed point exactly below the center marking of the flat phantom section, with the arms oriented parallel to the body axis.
- *Feed Point Impedance and Return Loss:* These parameters are measured with the dipole positioned under the liquid filled phantom. The impedance stated is transformed from the measurement at the SMA connector to the feed point. The Return Loss ensures low reflected power. No uncertainty required.
- *Electrical Delay:* One-way delay between the SMA connector and the antenna feed point. No uncertainty required.
- *SAR measured:* SAR measured at the stated antenna input power.
- *SAR normalized:* SAR as measured, normalized to an input power of 1 W at the antenna connector.
- *SAR for nominal TSL parameters:* The measured TSL parameters are used to calculate the nominal SAR result.

Measurement Conditions

DASY system configuration, as far as not given on page 1.

DASY Version	DASY5	V52.6.2
Extrapolation	Advanced Extrapolation	
Phantom	Modular Flat Phantom	
Distance Dipole Center - TSL	15 mm	with Spacer
Zoom Scan Resolution	dx, dy, dz = 5 mm	
Frequency	835 MHz ± 1 MHz	

Head TSL parameters

The following parameters and calculations were applied.

	Temperature	Permittivity	Conductivity
Nominal Head TSL parameters	22.0 °C	41.5	0.90 mho/m
Measured Head TSL parameters	(22.0 ± 0.2) °C	41.4 ± 6 %	0.90 mho/m ± 6 %
Head TSL temperature change during test	< 0.5 °C	----	----

SAR result with Head TSL

SAR averaged over 1 cm ³ (1 g) of Head TSL	Condition	
SAR measured	250 mW input power	2.34 mW / g
SAR for nominal Head TSL parameters	normalized to 1W	9.36 mW / g ± 17.0 % (k=2)

SAR averaged over 10 cm ³ (10 g) of Head TSL	condition	
SAR measured	250 mW input power	1.53 mW / g
SAR for nominal Head TSL parameters	normalized to 1W	6.12 mW / g ± 16.5 % (k=2)

Body TSL parameters

The following parameters and calculations were applied.

	Temperature	Permittivity	Conductivity
Nominal Body TSL parameters	22.0 °C	55.2	0.97 mho/m
Measured Body TSL parameters	(22.0 ± 0.2) °C	53.3 ± 6 %	0.99 mho/m ± 6 %
Body TSL temperature change during test	< 0.5 °C	----	----

SAR result with Body TSL

SAR averaged over 1 cm ³ (1 g) of Body TSL	Condition	
SAR measured	250 mW input power	2.43 mW / g
SAR for nominal Body TSL parameters	normalized to 1W	9.50 mW / g ± 17.0 % (k=2)

SAR averaged over 10 cm ³ (10 g) of Body TSL	condition	
SAR measured	250 mW input power	1.60 mW / g
SAR for nominal Body TSL parameters	normalized to 1W	6.23 mW / g ± 16.5 % (k=2)

Appendix

Antenna Parameters with Head TSL

Impedance, transformed to feed point	52.1 Ω - 3.6 j Ω
Return Loss	- 27.8 dB

Antenna Parameters with Body TSL

Impedance, transformed to feed point	48.0 Ω - 5.1 j Ω
Return Loss	- 25.1 dB

General Antenna Parameters and Design

Electrical Delay (one direction)	1.396 ns
----------------------------------	----------

After long term use with 100W radiated power, only a slight warming of the dipole near the feedpoint can be measured.

The dipole is made of standard semirigid coaxial cable. The center conductor of the feeding line is directly connected to the second arm of the dipole. The antenna is therefore short-circuited for DC-signals.

No excessive force must be applied to the dipole arms, because they might bend or the soldered connections near the feedpoint may be damaged.

Additional EUT Data

Manufactured by	SPEAG
Manufactured on	May 26, 2010

DASY5 Validation Report for Head TSL

Date: 11.11.2011

Test Laboratory: SPEAG, Zurich, Switzerland

DUT: Dipole 835 MHz; Type: D835V2; Serial: D835V2 - SN: 4d105

Communication System: CW; Frequency: 835 MHz

Medium parameters used: $f = 835 \text{ MHz}$; $\sigma = 0.9 \text{ mho/m}$; $\epsilon_r = 41.4$; $\rho = 1000 \text{ kg/m}^3$

Phantom section: Flat Section

Measurement Standard: DASY5 (IEEE/IEC/ANSI C63.19-2007)

DASY52 Configuration:

- Probe: ES3DV3 - SN3205; ConvF(6.07, 6.07, 6.07); Calibrated: 29.04.2011
- Sensor-Surface: 3mm (Mechanical Surface Detection)
- Electronics: DAE4 Sn601; Calibrated: 04.07.2011
- Phantom: Flat Phantom 4.9L; Type: QD000P49AA; Serial: 1001
- DASY52 52.6.2(482); SEMCAD X 14.4.5(3634)

Dipole Calibration for Head Tissue/Pin=250 mW, d=15mm/Zoom Scan (7x7x7)/Cube 0:

Measurement grid: $dx=5\text{mm}$, $dy=5\text{mm}$, $dz=5\text{mm}$

Reference Value = 56.666 V/m; Power Drift = 0.02 dB

Peak SAR (extrapolated) = 3.442 W/kg

SAR(1 g) = 2.34 mW/g; SAR(10 g) = 1.53 mW/g

Maximum value of SAR (measured) = 2.708 mW/g

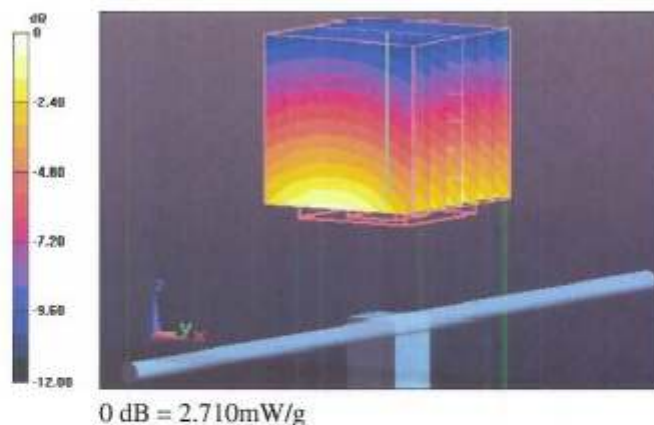

Impedance Measurement Plot for Head TSL

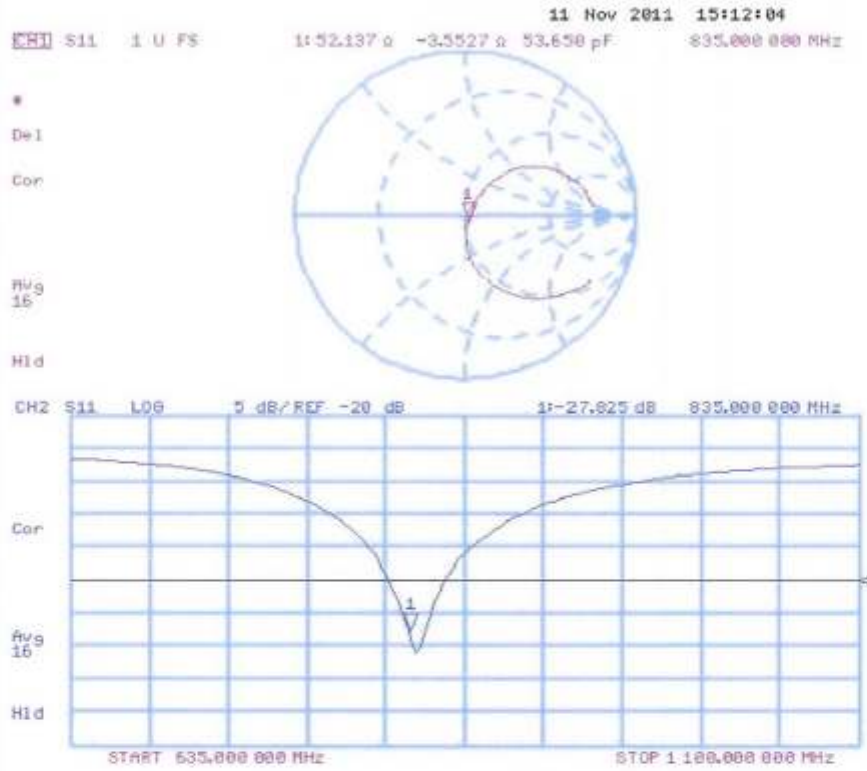

DASY5 Validation Report for Body TSL

Date: 11.11.2011

Test Laboratory: SPEAG, Zurich, Switzerland

DUT: Dipole 835 MHz; Type: D835V2; Serial: D835V2 - SN: 4d105

Communication System: CW; Frequency: 835 MHz

Medium parameters used: $f = 835 \text{ MHz}$; $\sigma = 0.99 \text{ mho/m}$; $\epsilon_r = 53.3$; $\rho = 1000 \text{ kg/m}^3$

Phantom section: Flat Section

Measurement Standard: DASY5 (IEEE/IEC/ANSI C63.19-2007)

DASY52 Configuration:

- Probe: ES3DV3 - SN3205; ConvF(6.02, 6.02, 6.02); Calibrated: 29.04.2011
- Sensor-Surface: 3mm (Mechanical Surface Detection)
- Electronics: DAE4 Sn601; Calibrated: 04.07.2011
- Phantom: Flat Phantom 4.9L; Type: QD000P49AA; Serial: 1001
- DASY52 52.6.2(482); SEMCAD X 14.4.5(3634)

Dipole Calibration for Body Tissue/Pin=250 mW, d=15mm/Zoom Scan (7x7x7)/Cube 0:

Measurement grid: $dx=5\text{mm}$, $dy=5\text{mm}$, $dz=5\text{mm}$

Reference Value = 55.161 V/m; Power Drift = 0.02 dB

Peak SAR (extrapolated) = 3.527 W/kg

SAR(1 g) = 2.43 mW/g; SAR(10 g) = 1.6 mW/g

Maximum value of SAR (measured) = 2.801 mW/g

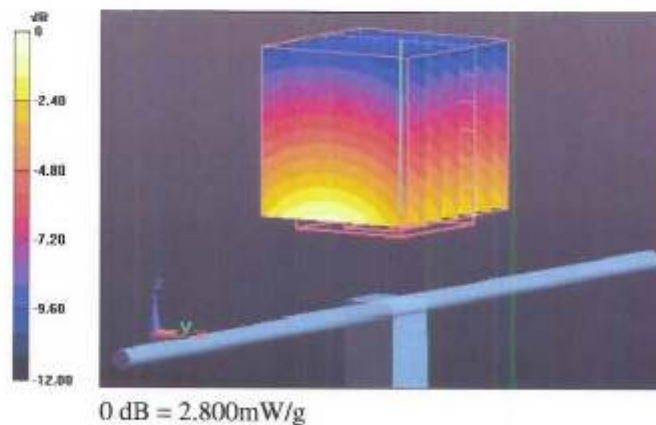

Impedance Measurement Plot for Body TSL

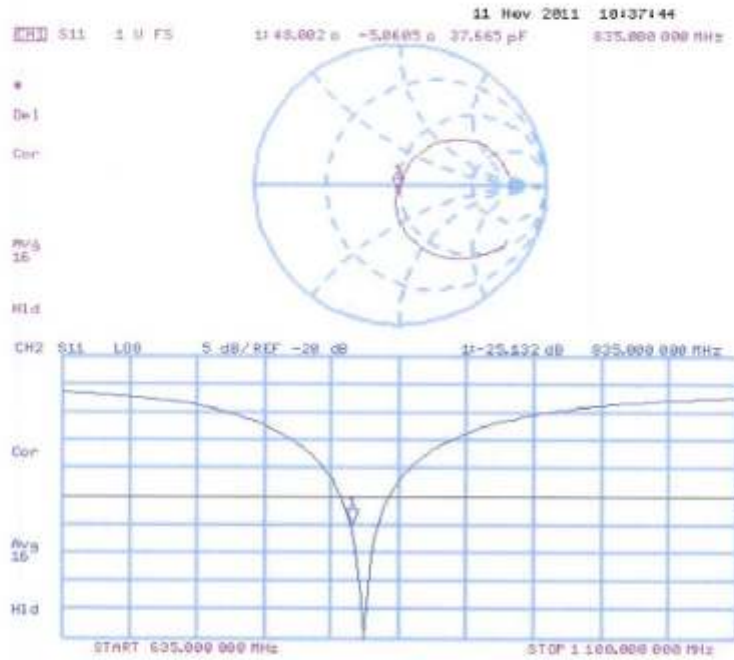

D1900V2

**Calibration Laboratory of
 Schmid & Partner
 Engineering AG**
 Zeughausstrasse 43, 8004 Zurich, Switzerland



S Schweizerischer Kalibrierdienst
C Service suisse d'étalonnage
S Servizio svizzero di taratura
S Swiss Calibration Service

Accredited by the Swiss Accreditation Service (SAS)
 The Swiss Accreditation Service is one of the signatories to the EA
 Multilateral Agreement for the recognition of calibration certificates

Accreditation No.: **SCS 108**

Client **SGS-SH (Auden)**

Certificate No: **D1900V2-5d028_Nov11**

CALIBRATION CERTIFICATE																																															
Object	D1900V2 - SN: 5d028																																														
Calibration procedure(s)	QA CAL-05.v8 Calibration procedure for dipole validation kits above 700 MHz																																														
Calibration date:	November 10, 2011																																														
<p>This calibration certificate documents the traceability to national standards, which realize the physical units of measurements (SI). The measurements and the uncertainties with confidence probability are given on the following pages and are part of the certificate.</p> <p>All calibrations have been conducted in the closed laboratory facility: environment temperature (22 ± 3)°C and humidity < 70%.</p> <p>Calibration Equipment used (M&TE critical for calibration)</p> <table border="1"> <thead> <tr> <th>Primary Standards</th> <th>ID #</th> <th>Cal Date (Certificate No.)</th> <th>Scheduled Calibration</th> </tr> </thead> <tbody> <tr> <td>Power meter EPM-442A</td> <td>GB37480704</td> <td>05-Oct-11 (No. 217-01451)</td> <td>Oct-12</td> </tr> <tr> <td>Power sensor HP 8481A</td> <td>US37292783</td> <td>05-Oct-11 (No. 217-01451)</td> <td>Oct-12</td> </tr> <tr> <td>Reference 20 dB Attenuator</td> <td>SN: 5086 (20g)</td> <td>29-Mar-11 (No. 217-01368)</td> <td>Apr-12</td> </tr> <tr> <td>Type-N mismatch combination</td> <td>SN: 5047.2 / 06327</td> <td>29-Mar-11 (No. 217-01371)</td> <td>Apr-12</td> </tr> <tr> <td>Reference Probe ES30V3</td> <td>SN: 3205</td> <td>29-Apr-11 (No. ES3-3205_Apr11)</td> <td>Apr-12</td> </tr> <tr> <td>DAE4</td> <td>SN: 601</td> <td>04-Jul-11 (No. DAE4-601_Jul11)</td> <td>Jul-12</td> </tr> </tbody> </table> <table border="1"> <thead> <tr> <th>Secondary Standards</th> <th>ID #</th> <th>Check Date (in house)</th> <th>Scheduled Check</th> </tr> </thead> <tbody> <tr> <td>Power sensor HP 8481A</td> <td>MY41092317</td> <td>18-Oct-02 (in house check Oct-11)</td> <td>In house check: Oct-13</td> </tr> <tr> <td>RF generator R&S SMT-06</td> <td>100005</td> <td>04-Aug-99 (in house check Oct-11)</td> <td>In house check: Oct-13</td> </tr> <tr> <td>Network Analyzer HP 8753E</td> <td>US37390585 S4206</td> <td>18-Oct-01 (in house check Oct-11)</td> <td>In house check: Oct-12</td> </tr> </tbody> </table>				Primary Standards	ID #	Cal Date (Certificate No.)	Scheduled Calibration	Power meter EPM-442A	GB37480704	05-Oct-11 (No. 217-01451)	Oct-12	Power sensor HP 8481A	US37292783	05-Oct-11 (No. 217-01451)	Oct-12	Reference 20 dB Attenuator	SN: 5086 (20g)	29-Mar-11 (No. 217-01368)	Apr-12	Type-N mismatch combination	SN: 5047.2 / 06327	29-Mar-11 (No. 217-01371)	Apr-12	Reference Probe ES30V3	SN: 3205	29-Apr-11 (No. ES3-3205_Apr11)	Apr-12	DAE4	SN: 601	04-Jul-11 (No. DAE4-601_Jul11)	Jul-12	Secondary Standards	ID #	Check Date (in house)	Scheduled Check	Power sensor HP 8481A	MY41092317	18-Oct-02 (in house check Oct-11)	In house check: Oct-13	RF generator R&S SMT-06	100005	04-Aug-99 (in house check Oct-11)	In house check: Oct-13	Network Analyzer HP 8753E	US37390585 S4206	18-Oct-01 (in house check Oct-11)	In house check: Oct-12
Primary Standards	ID #	Cal Date (Certificate No.)	Scheduled Calibration																																												
Power meter EPM-442A	GB37480704	05-Oct-11 (No. 217-01451)	Oct-12																																												
Power sensor HP 8481A	US37292783	05-Oct-11 (No. 217-01451)	Oct-12																																												
Reference 20 dB Attenuator	SN: 5086 (20g)	29-Mar-11 (No. 217-01368)	Apr-12																																												
Type-N mismatch combination	SN: 5047.2 / 06327	29-Mar-11 (No. 217-01371)	Apr-12																																												
Reference Probe ES30V3	SN: 3205	29-Apr-11 (No. ES3-3205_Apr11)	Apr-12																																												
DAE4	SN: 601	04-Jul-11 (No. DAE4-601_Jul11)	Jul-12																																												
Secondary Standards	ID #	Check Date (in house)	Scheduled Check																																												
Power sensor HP 8481A	MY41092317	18-Oct-02 (in house check Oct-11)	In house check: Oct-13																																												
RF generator R&S SMT-06	100005	04-Aug-99 (in house check Oct-11)	In house check: Oct-13																																												
Network Analyzer HP 8753E	US37390585 S4206	18-Oct-01 (in house check Oct-11)	In house check: Oct-12																																												
Calibrated by:	Name Claudio Leubler	Function Laboratory Technician	Signature 																																												
Approved by:	Name Katja Pokovic	Function Technical Manager	Signature 																																												
			Issued: November 10, 2011																																												
This calibration certificate shall not be reproduced except in full without written approval of the laboratory.																																															

Certificate No: D1900V2-5d028_Nov11

Page 1 of 8

Calibration Laboratory of
Schmid & Partner
Engineering AG
 Zeughausstrasse 43, 8004 Zurich, Switzerland



S Schweizerischer Kalibrierdienst
S Service suisse d'étalonnage
C Servizio svizzero di taratura
S Swiss Calibration Service

Accredited by the Swiss Accreditation Service (SAS)
 The Swiss Accreditation Service is one of the signatories to the EA
 Multilateral Agreement for the recognition of calibration certificates

Accreditation No.: **SCS 108**

Glossary:

TSL tissue simulating liquid
 ConvF sensitivity in TSL / NORM x,y,z
 N/A not applicable or not measured

Calibration is Performed According to the Following Standards:

- a) IEEE Std 1528-2003, "IEEE Recommended Practice for Determining the Peak Spatial-Averaged Specific Absorption Rate (SAR) in the Human Head from Wireless Communications Devices: Measurement Techniques", December 2003
- b) IEC 62209-1, "Procedure to measure the Specific Absorption Rate (SAR) for hand-held devices used in close proximity to the ear (frequency range of 300 MHz to 3 GHz)", February 2005
- c) Federal Communications Commission Office of Engineering & Technology (FCC OET), "Evaluating Compliance with FCC Guidelines for Human Exposure to Radiofrequency Electromagnetic Fields; Additional Information for Evaluating Compliance of Mobile and Portable Devices with FCC Limits for Human Exposure to Radiofrequency Emissions", Supplement C (Edition 01-01) to Bulletin 65

Additional Documentation:

- d) DASY4/5 System Handbook

Methods Applied and Interpretation of Parameters:

- *Measurement Conditions:* Further details are available from the Validation Report at the end of the certificate. All figures stated in the certificate are valid at the frequency indicated.
- *Antenna Parameters with TSL:* The dipole is mounted with the spacer to position its feed point exactly below the center marking of the flat phantom section, with the arms oriented parallel to the body axis.
- *Feed Point Impedance and Return Loss:* These parameters are measured with the dipole positioned under the liquid filled phantom. The impedance stated is transformed from the measurement at the SMA connector to the feed point. The Return Loss ensures low reflected power. No uncertainty required.
- *Electrical Delay:* One-way delay between the SMA connector and the antenna feed point. No uncertainty required.
- *SAR measured:* SAR measured at the stated antenna input power.
- *SAR normalized:* SAR as measured, normalized to an input power of 1 W at the antenna connector.
- *SAR for nominal TSL parameters:* The measured TSL parameters are used to calculate the nominal SAR result.

Measurement Conditions

DASY system configuration, as far as not given on page 1.

DASY Version	DASY5	V52.6.2
Extrapolation	Advanced Extrapolation	
Phantom	Modular Flat Phantom	
Distance Dipole Center - TSL	10 mm	with Spacer
Zoom Scan Resolution	dx, dy, dz = 5 mm	
Frequency	1900 MHz ± 1 MHz	

Head TSL parameters

The following parameters and calculations were applied.

	Temperature	Permittivity	Conductivity
Nominal Head TSL parameters	22.0 °C	40.0	1.40 mho/m
Measured Head TSL parameters	(22.0 ± 0.2) °C	39.5 ± 6 %	1.42 mho/m ± 6 %
Head TSL temperature change during test	< 0.5 °C	----	----

SAR result with Head TSL

SAR averaged over 1 cm ³ (1 g) of Head TSL	Condition	
SAR measured	250 mW input power	10.1 mW / g
SAR for nominal Head TSL parameters	normalized to 1W	39.9 mW / g ± 17.0 % (k=2)

SAR averaged over 10 cm ³ (10 g) of Head TSL	condition	
SAR measured	250 mW input power	5.26 mW / g
SAR for nominal Head TSL parameters	normalized to 1W	20.9 mW / g ± 16.5 % (k=2)

Body TSL parameters

The following parameters and calculations were applied.

	Temperature	Permittivity	Conductivity
Nominal Body TSL parameters	22.0 °C	53.3	1.52 mho/m
Measured Body TSL parameters	(22.0 ± 0.2) °C	54.2 ± 6 %	1.59 mho/m ± 6 %
Body TSL temperature change during test	< 0.5 °C	----	----

SAR result with Body TSL

SAR averaged over 1 cm ³ (1 g) of Body TSL	Condition	
SAR measured	250 mW input power	10.6 mW / g
SAR for nominal Body TSL parameters	normalized to 1W	41.4 mW / g ± 17.0 % (k=2)

SAR averaged over 10 cm ³ (10 g) of Body TSL	condition	
SAR measured	250 mW input power	5.54 mW / g
SAR for nominal Body TSL parameters	normalized to 1W	21.9 mW / g ± 16.5 % (k=2)

Appendix

Antenna Parameters with Head TSL

Impedance, transformed to feed point	52.3 Ω + 5.8 jΩ
Return Loss	- 24.4 dB

Antenna Parameters with Body TSL

Impedance, transformed to feed point	47.4 Ω + 6.4 jΩ
Return Loss	- 23.0 dB

General Antenna Parameters and Design

Electrical Delay (one direction)	1.200 ns
----------------------------------	----------

After long term use with 100W radiated power, only a slight warming of the dipole near the feedpoint can be measured.

The dipole is made of standard semirigid coaxial cable. The center conductor of the feeding line is directly connected to the second arm of the dipole. The antenna is therefore short-circuited for DC-signals.

No excessive force must be applied to the dipole arms, because they might bend or the soldered connections near the feedpoint may be damaged.

Additional EUT Data

Manufactured by	SPEAG
Manufactured on	December 17, 2002

DASY5 Validation Report for Head TSL

Date: 10.11.2011

Test Laboratory: SPEAG, Zurich, Switzerland

DUT: Dipole 1900 MHz; Type: D1900V2; Serial: D1900V2 - SN: 5d028

Communication System: CW; Frequency: 1900 MHz

Medium parameters used: $f = 1900$ MHz; $\sigma = 1.42$ mho/m; $\epsilon_r = 39.5$; $\rho = 1000$ kg/m³

Phantom section: Flat Section

Measurement Standard: DASY5 (IEEE/IEC/ANSI C63.19-2007)

DASY52 Configuration:

- Probe: ES3DV3 - SN3205; ConvT(5.01, 5.01, 5.01); Calibrated: 29.04.2011
- Sensor-Surface: 3mm (Mechanical Surface Detection)
- Electronics: DAE4 Sn601; Calibrated: 04.07.2011
- Phantom: Flat Phantom 5.0 (front); Type: QD000P50AA; Serial: 1001
- DASY52 52.6.2(482); SEMCAD X 14.4.5(3634)

Dipole Calibration for Head Tissue/Pin=250 mW, d=10mm/Zoom Scan (7x7x7)/Cube 0:

Measurement grid: dx=5mm, dy=5mm, dz=5mm

Reference Value = 98.632 V/m; Power Drift = 0.03 dB

Peak SAR (extrapolated) = 18.531 W/kg

SAR(1 g) = 10.1 mW/g; SAR(10 g) = 5.26 mW/g

Maximum value of SAR (measured) = 12.753 mW/g

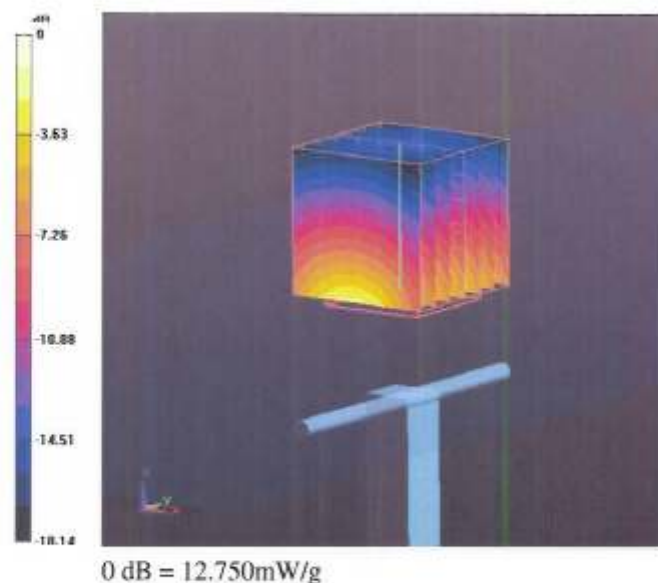

Impedance Measurement Plot for Head TSL

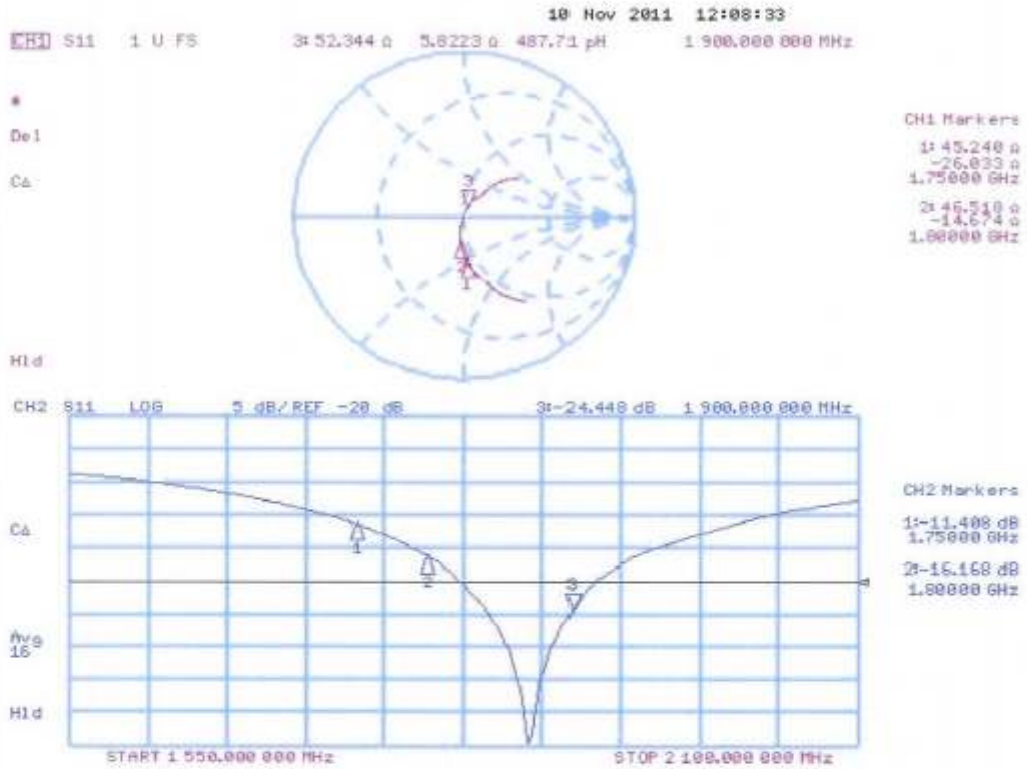

DASY5 Validation Report for Body TSL

Date: 10.11.2011

Test Laboratory: SPEAG, Zurich, Switzerland

DUT: Dipole 1900 MHz; Type: D1900V2; Serial: D1900V2 - SN: 5d028

Communication System: CW; Frequency: 1900 MHz
 Medium parameters used: $f = 1900$ MHz; $\sigma = 1.59$ mho/m; $\epsilon_r = 54.2$; $\rho = 1000$ kg/m³
 Phantom section: Flat Section
 Measurement Standard: DASY5 (IEEE/IEC/ANSI C63.19-2007)

DASY52 Configuration:

- Probe: ES3DV3 - SN3205; ConvF(4.62, 4.62, 4.62), Calibrated: 29.04.2011
- Sensor-Surface: 3mm (Mechanical Surface Detection)
- Electronics: DAE4 Sn601; Calibrated: 04.07.2011
- Phantom: Flat Phantom 5.0 (back); Type: QD000P50AA; Serial: 1002
- DASY52 52.6.2(482); SEMCAD X 14.4.5(3634)

Dipole Calibration for Body Tissue/Pin=250 mW, d=10mm/Zoom Scan (7x7x7)/Cube 0:

Measurement grid: dx=5mm, dy=5mm, dz=5mm
 Reference Value = 96.757 V/m; Power Drift = -0.02 dB
 Peak SAR (extrapolated) = 18.957 W/kg
SAR(1 g) = 10.6 mW/g; SAR(10 g) = 5.54 mW/g
 Maximum value of SAR (measured) = 13.554 mW/g

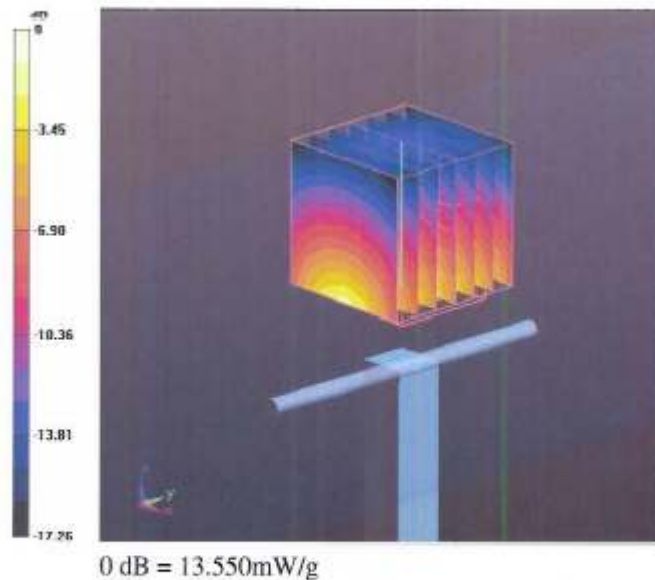

Impedance Measurement Plot for Body TSL

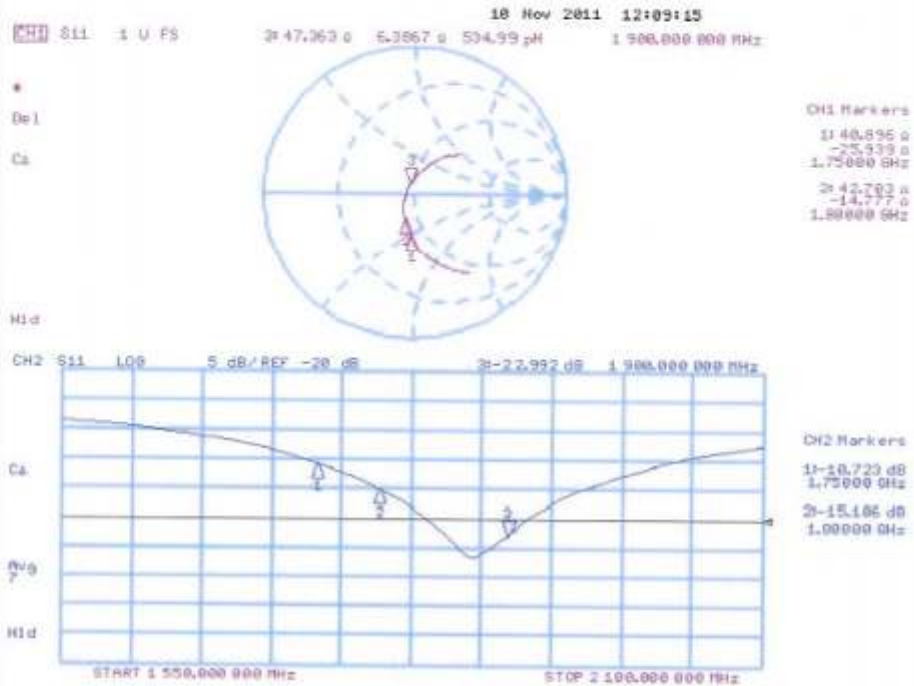

D2450V2

**Calibration Laboratory of
Schmid & Partner
Engineering AG**
Zeughausstrasse 43, 8004 Zurich, Switzerland



S Schweizerischer Kalibrierdienst
C Service suisse d'étalonnage
S Servizio svizzero di taratura
S Swiss Calibration Service

Accredited by the Swiss Accreditation Service (SAS)
The Swiss Accreditation Service is one of the signatories to the EA
Multilateral Agreement for the recognition of calibration certificates

Accreditation No.: **SCS 108**

Client: **SGS-SH (Auden)**

Certificate No: **D2450V2-733_Nov11**

CALIBRATION CERTIFICATE

Object: **D2450V2 - SN: 733**

Calibration procedure(s): **QA CAL-05.v8
Calibration procedure for dipole validation kits above 700 MHz**

Calibration date: **November 09, 2011**

This calibration certificate documents the traceability to national standards, which realize the physical units of measurements (SI).
The measurements and the uncertainties with confidence probability are given on the following pages and are part of the certificate.

All calibrations have been conducted in the closed laboratory facility: environment temperature (22 ± 3)°C and humidity < 70%.

Calibration Equipment used (M&TE critical for calibration)

Primary Standards	ID #	Cal Date (Certificate No.)	Scheduled Calibration
Power meter EPM-442A	GB37480704	05-Oct-11 (No. 217-01451)	Oct-12
Power sensor HP B4B1A	US37292783	05-Oct-11 (No. 217-01451)	Oct-12
Reference 20 dB Attenuator	SN: 5086 (20g)	29-Mar-11 (No. 217-01368)	Apr-12
Type-N mismatch combination	SN: 5047.2 / 06327	29-Mar-11 (No. 217-01371)	Apr-12
Reference Probe ES3DV3	SN: 3205	29-Apr-11 (No. ES3-3205_Apr11)	Apr-12
DAE4	SN: 601	04-Jul-11 (No. DAE4-601_Jul11)	Jul-12
Secondary Standards	ID #	Check Date (in house)	Scheduled Check
Power sensor HP B4B1A	MY41092317	18-Oct-02 (in house check Oct-11)	In house check: Oct-13
RF generator R&S SMT-06	100005	04-Aug-99 (in house check Oct-11)	In house check: Oct-13
Network Analyzer HP 8753E	US37390585 S4206	18-Oct-01 (in house check Oct-11)	In house check: Oct-12

	Name	Function	Signature
Calibrated by:	Jeton Kastrati	Laboratory Technician	
Approved by:	Katja Pokovic	Technical Manager	

Issued: November 9, 2011

This calibration certificate shall not be reproduced except in full without written approval of the laboratory.

Certificate No: D2450V2-733_Nov11

Page 1 of 8

SHEMC

**Calibration Laboratory of
Schmid & Partner
Engineering AG**
Zeughausstrasse 43, 8004 Zurich, Switzerland



S Schweizerischer Kalibrierdienst
C Service suisse d'étalonnage
S Servizio svizzero di taratura
S Swiss Calibration Service

Accredited by the Swiss Accreditation Service (SAS)
The Swiss Accreditation Service is one of the signatories to the EA
Multilateral Agreement for the recognition of calibration certificates

Accreditation No.: **SCS 108**

Glossary:

TSL	tissue simulating liquid
ConvF	sensitivity in TSL / NORM x,y,z
N/A	not applicable or not measured

Calibration is Performed According to the Following Standards:

- a) IEEE Std 1528-2003, "IEEE Recommended Practice for Determining the Peak Spatial-Averaged Specific Absorption Rate (SAR) in the Human Head from Wireless Communications Devices: Measurement Techniques", December 2003
- b) IEC 62209-1, "Procedure to measure the Specific Absorption Rate (SAR) for hand-held devices used in close proximity to the ear (frequency range of 300 MHz to 3 GHz)", February 2005
- c) Federal Communications Commission Office of Engineering & Technology (FCC OET), "Evaluating Compliance with FCC Guidelines for Human Exposure to Radiofrequency Electromagnetic Fields; Additional Information for Evaluating Compliance of Mobile and Portable Devices with FCC Limits for Human Exposure to Radiofrequency Emissions", Supplement C (Edition 01-01) to Bulletin 65

Additional Documentation:

- d) DASY4/5 System Handbook

Methods Applied and Interpretation of Parameters:

- *Measurement Conditions:* Further details are available from the Validation Report at the end of the certificate. All figures stated in the certificate are valid at the frequency indicated.
- *Antenna Parameters with TSL:* The dipole is mounted with the spacer to position its feed point exactly below the center marking of the flat phantom section, with the arms oriented parallel to the body axis.
- *Feed Point Impedance and Return Loss:* These parameters are measured with the dipole positioned under the liquid filled phantom. The impedance stated is transformed from the measurement at the SMA connector to the feed point. The Return Loss ensures low reflected power. No uncertainty required.
- *Electrical Delay:* One-way delay between the SMA connector and the antenna feed point. No uncertainty required.
- *SAR measured:* SAR measured at the stated antenna input power.
- *SAR normalized:* SAR as measured, normalized to an input power of 1 W at the antenna connector.
- *SAR for nominal TSL parameters:* The measured TSL parameters are used to calculate the nominal SAR result.

Measurement Conditions

DASY system configuration, as far as not given on page 1.

DASY Version	DASY5	V52.6.2
Extrapolation	Advanced Extrapolation	
Phantom	Modular Flat Phantom	
Distance Dipole Center - TSL	10 mm	with Spacer
Zoom Scan Resolution	dx, dy, dz = 5 mm	
Frequency	2450 MHz ± 1 MHz	

Head TSL parameters

The following parameters and calculations were applied.

	Temperature	Permittivity	Conductivity
Nominal Head TSL parameters	22.0 °C	39.2	1.80 mho/m
Measured Head TSL parameters	(22.0 ± 0.2) °C	37.7 ± 6 %	1.84 mho/m ± 6 %
Head TSL temperature change during test	< 0.5 °C	----	----

SAR result with Head TSL

SAR averaged over 1 cm ³ (1 g) of Head TSL	Condition	
SAR measured	250 mW input power	13.7 mW / g
SAR for nominal Head TSL parameters	normalized to 1W	53.7 mW / g ± 17.0 % (k=2)

SAR averaged over 10 cm ³ (10 g) of Head TSL	condition	
SAR measured	250 mW input power	6.33 mW / g
SAR for nominal Head TSL parameters	normalized to 1W	25.0 mW / g ± 16.5 % (k=2)

Body TSL parameters

The following parameters and calculations were applied.

	Temperature	Permittivity	Conductivity
Nominal Body TSL parameters	22.0 °C	52.7	1.95 mho/m
Measured Body TSL parameters	(22.0 ± 0.2) °C	50.9 ± 6 %	2.01 mho/m ± 6 %
Body TSL temperature change during test	< 0.5 °C	----	----

SAR result with Body TSL

SAR averaged over 1 cm ³ (1 g) of Body TSL	Condition	
SAR measured	250 mW input power	13.2 mW / g
SAR for nominal Body TSL parameters	normalized to 1W	51.6 mW / g ± 17.0 % (k=2)

SAR averaged over 10 cm ³ (10 g) of Body TSL	condition	
SAR measured	250 mW input power	6.11 mW / g
SAR for nominal Body TSL parameters	normalized to 1W	24.1 mW / g ± 16.6 % (k=2)

Appendix

Antenna Parameters with Head TSL

Impedance, transformed to feed point	54.0 Ω + 2.2 j Ω
Return Loss	- 27,1 dB

Antenna Parameters with Body TSL

Impedance, transformed to feed point	49.5 Ω + 3.7 j Ω
Return Loss	- 28.6 dB

General Antenna Parameters and Design

Electrical Delay (one direction)	1.151 ns
----------------------------------	----------

After long term use with 100W radiated power, only a slight warming of the dipole near the feedpoint can be measured.

The dipole is made of standard semirigid coaxial cable. The center conductor of the feeding line is directly connected to the second arm of the dipole. The antenna is therefore short-circuited for DC-signals.

No excessive force must be applied to the dipole arms, because they might bend or the soldered connections near the feedpoint may be damaged.

Additional EUT Data

Manufactured by	SPEAG
Manufactured on	May 07, 2003

DASY5 Validation Report for Head TSL

Date: 09.11.2011

Test Laboratory: SPEAG, Zurich, Switzerland

DUT: Dipole 2450 MHz; Type: D2450V2; Serial: D2450V2 - SN: 733

Communication System: CW; Frequency: 2450 MHz

Medium parameters used: $f = 2450$ MHz; $\sigma = 1.84$ mho/m; $\epsilon_r = 37.7$; $\rho = 1000$ kg/m³

Phantom section: Flat Section

Measurement Standard: DASY5 (IEEE/IEC/ANSI C63.19-2007)

DASY52 Configuration:

- Probe: E33DV3 - SN3205, ConvF(4.45, 4.45, 4.45), Calibrated: 29.04.2011
- Sensor-Surface: 3mm (Mechanical Surface Detection)
- Electronics: DAE4 Sn601; Calibrated: 04.07.2011
- Phantom: Flat Phantom 5.0 (front); Type: QD000P50AA; Serial: 1001
- DASY52 52.6.2(482); SEMCAD X 14.4.5(3634)

Dipole Calibration for Head Tissue/Pin=250 mW, d=10mm/Zoom Scan (7x7x7)/Cube 0:

Measurement grid: dx=5mm, dy=5mm, dz=5mm

Reference Value = 102.3 V/m; Power Drift = 0.03 dB

Peak SAR (extrapolated) = 28.483 W/kg

SAR(1 g) = 13.7 mW/g; SAR(10 g) = 6.33 mW/g

Maximum value of SAR (measured) = 17.733 mW/g



Impedance Measurement Plot for Head TSL

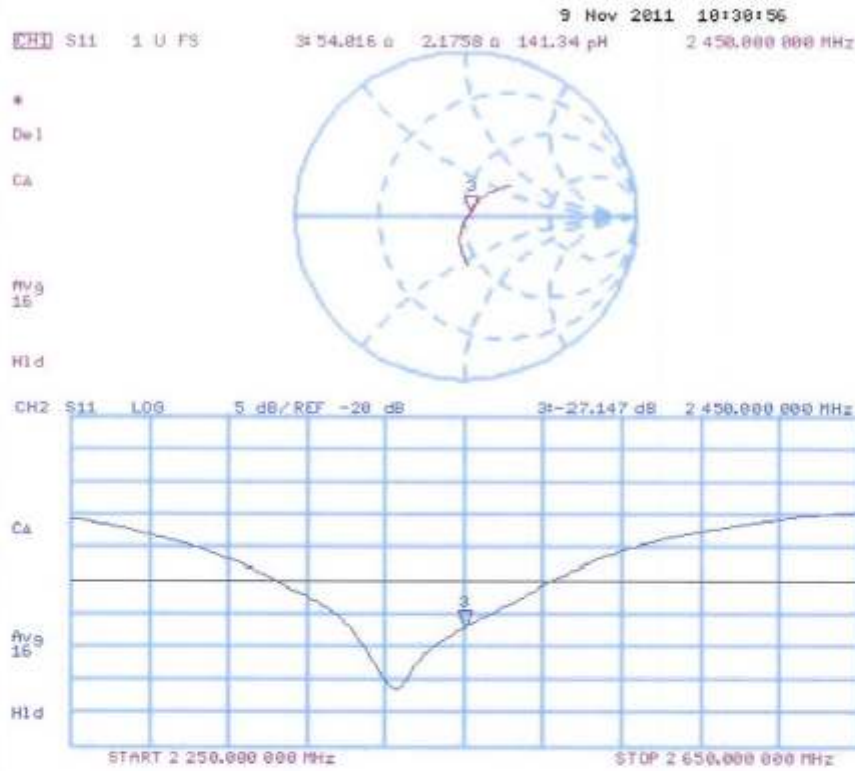

DASY5 Validation Report for Body TSL

Date: 09.11.2011

Test Laboratory: SPEAG, Zurich, Switzerland

DUT: Dipole 2450 MHz; Type: D2450V2; Serial: D2450V2 - SN: 733

Communication System: CW; Frequency: 2450 MHz

Medium parameters used: $f = 2450$ MHz; $\sigma = 2.01$ mho/m; $\epsilon_r = 50.9$; $\rho = 1000$ kg/m³

Phantom section: Flat Section

Measurement Standard: DASY5 (IEEE/IEC/ANSI C63.19-2007)

DASY52 Configuration:

- Probc: ES3DV3 - SN3205; ConvF(4.26, 4.26, 4.26); Calibrated: 29.04.2011
- Sensor-Surface: 3mm (Mechanical Surface Detection)
- Electronics: DAE4 Sn601; Calibrated: 04.07.2011
- Phantom: Flat Phantom 5.0 (back); Type: QD000P50AA; Serial: 1002
- DASY52 52.6.2(482); SEMCAD X 14.4.5(3634)

Dipole Calibration for Body Tissue/Pin=250 mW, d=10mm/Zoom Scan (7x7x7)/Cube 0:

Measurement grid: dx=5mm, dy=5mm, dz=5mm

Reference Value = 96.475 V/m; Power Drift = -0.01 dB

Peak SAR (extrapolated) = 27.319 W/kg

SAR(1 g) = 13.2 mW/g; SAR(10 g) = 6.11 mW/g

Maximum value of SAR (measured) = 17.446 mW/g

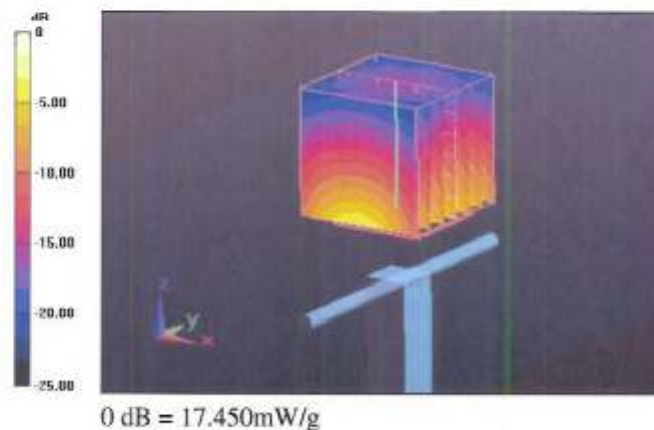

Impedance Measurement Plot for Body TSL

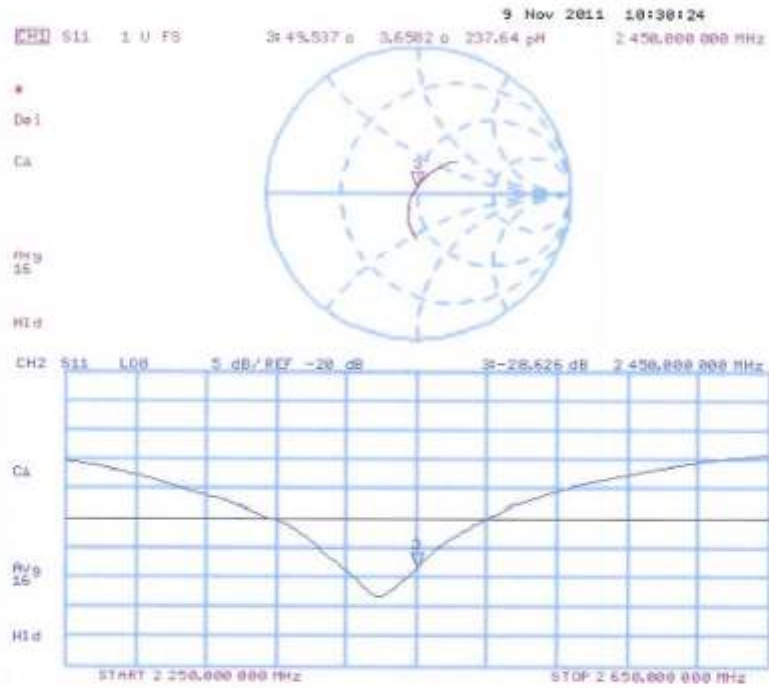

END OF REPORT

SHEMC