



TEST REPORT

No. I18D00043-EMC01

For

Client : Mobiwire SAS

Production: 3G Smartphone

Model Name : MobiWire Mahpee, Altice S11

Hardware Version: V00

Software Version: VP403_GH4032

FCC ID: QPN-MAHPEE

Issued date: 2018-04-13

Note:

The test results in this test report relate only to the devices specified in this report. This report shall not be reproduced except in full without the written approval of ECIT Shanghai.

Test Laboratory:

ECIT Shanghai, East China Institute of Telecommunications

Add: 7F, G Area, No.668, Beijing East Road, Huangpu District, Shanghai, P. R. China

Tel: (+86)-021-63843300, E-Mail: welcome@ecit.org.cn

Revision Version

Report Number	Revision	Date	Memo
I18D00043-EMC01	00	2018-04-13	Initial creation of test report

CONTENTS

1. TEST LABORATORY	5
1.1. TESTING LOCATION	5
1.2. TESTING ENVIRONMENT	5
1.3. PROJECT DATA	5
1.4. SIGNATURE	5
2. CLIENT INFORMATION	6
2.1. APPLICANT INFORMATION	6
2.2. MANUFACTURER INFORMATION	6
3. EQUIPMENT UNDER TEST (EUT) AND ANCILLARY EQUIPMENT (AE)	7
3.1. ABOUT EUT	7
3.2. INTERNAL IDENTIFICATION OF EUT USED DURING THE TEST	7
3.3. INTERNAL IDENTIFICATION OF AE USED DURING THE TEST	7
4. REFERENCE DOCUMENTS.....	8
4.1. REFERENCE DOCUMENTS FOR TESTING	8
5. TEST RESULTS.....	9
5.1. SUMMARY OF TEST RESULTS.....	9
5.2. STATEMENTS.....	9
6. TEST EQUIPMENTS UTILIZED.....	10
6.1 RADIATED EMISSION EQUIPMENTS LIST.....	10
6.2 AC CONDUCTED EMISSION EQUIPMENTS LIST.....	10
7. SYSTEM CONFIGURATION DURING TEST	11
7.1 TEST MODE.....	11
7.2 CONNECTION DIAGRAM OF TEST SYSTEM.....	12
8. MEASUREMENT RESULTS	13
8.1 RADIATED EMISSION 30MHZ-18GHZ.....	13

8.2 AC CONDUCTED EMISSION..... 17

1. Test Laboratory

1.1. Testing Location

Company Name: ECIT Shanghai, East China Institute of Telecommunications
Address: 7F, G Area, No. 668, Beijing East Road, Huangpu District, Shanghai,
P. R. China
Postal Code: 200001
Telephone: 86-21-63843300
Fax: 86-21-63843301
FCC registration No: 489729

1.2. Testing Environment

Normal Temperature: 15-35°C
Relative Humidity: 30-60%RH

1.3. Project data

Project Leader: Yu Anlu
Testing Start Date: 2018-03-30
Testing End Date: 2018-04-03

1.4. Signature

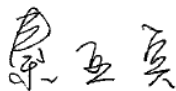

Qin Yabin

(Prepared this test report)



You Jinjun

(Reviewed this test report)

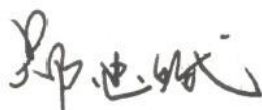

Zheng Zhongbin

Director of the laboratory

(Approved this test report)

2. Client Information

2.1. Applicant Information

Company Name: Mobewire SAS
Address : 79 AVENUE FRANCOIS ARAGO 92017 NANTERRE CEDEX
France.
Telephone: +33668018722
Postcode: /

2.2. Manufacturer Information

Company Name: Mobewire SAS
Address : 79 AVENUE FRANCOIS ARAGO 92017 NANTERRE CEDEX
France.
Telephone: +33668018722
Postcode: /

3. Equipment under Test (EUT) and Ancillary Equipment (AE)

3.1. About EUT

EUT Description	3G Smartphone
Model name	MobiWire Mahpee, Altice S11
GSM Frequency Band	GSM850/GSM1900/GSM900/GSM1800
WCDMA Frequency Band	WCDMA BAND I / VIII
Additional Communication Function	BT 2.1,EDR,3.0,4.0,BLE;WIFI 802.11b/g/n;GPS;FM

3.2. Internal Identification of EUT used during the test

EUT ID*	SN or IMEI	HW Version	SW Version	Date of receipt
N01	357012090000161/ 357012090000179	V00	VP403_GH4032	2018-03-08

*EUT ID: is used to identify the test sample in the lab internally.

3.3. Internal Identification of AE used during the test

AE ID*	Description	Model	SN
CA04	Adapter	A31A-050055U-US1	/
AE1	Desktop PC	OptiPlex 790 DT	X8RP1 A01 APCC
AE2	Notebook PC	DELL Latitude E5250	/
AE3	LAN Cable	/	/
AE4	VGA Cable	/	/
AE5	RS232 Cable	/	/
AE6	Keyboard	KB212-B	CN-0Y88XT-65890-12I -005Q-A00
AE7	Mouse	MS111-P	CN-011D3V-71581-19 J-1A64
AE8	SanDiskUltra32GB	microSDHC UHS-I	/
AE9	USB Cable	/	/
AE10	Monitor	Dell E1709Wc	/

*AE ID: is used to identify the test sample in the lab internally.

4. Reference Documents

4.1. Reference Documents for testing

The following documents listed in this section are referred for testing.

Reference	Title	Version
FCC Part 15, Subpart B	Radio frequency devices	10-1-10 Edition
ANSI C63.4	Method of Measurement of Radio-Noise Emissions from Low-Voltage Electrical and Electronic Equipment in the Range of 9 kHz to 40 GHz	2014

5. Test Results

5.1. Summary of Test Results

Items	Test List	Clause in FCC rules	Verdict
1	Radiated Emission	15.109(a)	Pass
2	AC Conducted Emission	15.107(a)	Pass

5.2. Statements

The MobiWire Mahpee, Altice S11, manufactured by Mobiwire SAS is a new product for testing. ECIT performed test cases which identified with Pass/Fail/Inc result in section 5.1.

ECIT has verified that the compliance of the tested device specified in section 3 of this test report is successfully evaluated according to the procedure and test methods as defined in type certification requirement listed in section 4 of this test report.

6. Test Equipments Utilized

6.1 Radiated Emission Equipments list

No.	Name	Type	Series Number	Producer	Cal. Date	Cal. interval
1	Universal Radio Communication	CMU200	123126	R&S	2017-05-11	1 Year
2	Test Receiver	ESU40	100307	R&S	2017-05-11	1 Year
3	Trilog Antenna	VULB9163	VULB9163-515	Schwarzbeck	2017-02-25	3 Year
4	Double Ridged Guide	ETS-3117	00135890	ETS	2017-01-11	3 Year
5	EMI Test Software	EMC32 V9.15	NA	R&S	NA	NA

6.2 AC Conducted Emission Equipments list

No.	Name	Type	Series Number	Producer	Cal. Date	Cal. interval
1	Universal Radio	CMU200	123123	R&S	2017-05-11	1 Year
2	Test Receiver	ESCI	101235	R&S	2017-05-11	1 Year
3	2-Line V-Network	ENV216	101380	R&S	2017-05-11	1 Year
4	EMI Test Software	EMC32 V9.12	NA	R&S	NA	NA

7. System Configuration during Test

7.1 Test Mode

Test Item	Function Type
AC Conducted Emission	Mode 1: USB cable (Data Link with PC) <Figure 1> Mode 2: Adapter charging <Figure 2>
Radiated Emission	Mode 1: USB cable (Data Link with PC) <Figure 1> Mode 2: Adapter charging <Figure 2>
Remark: 1. All test modes are performed, only the worst cases test data are recorded in this report. 2. Data Link with PC means data application transferred mode between EUT and PC.	

7.2 Connection Diagram of Test System

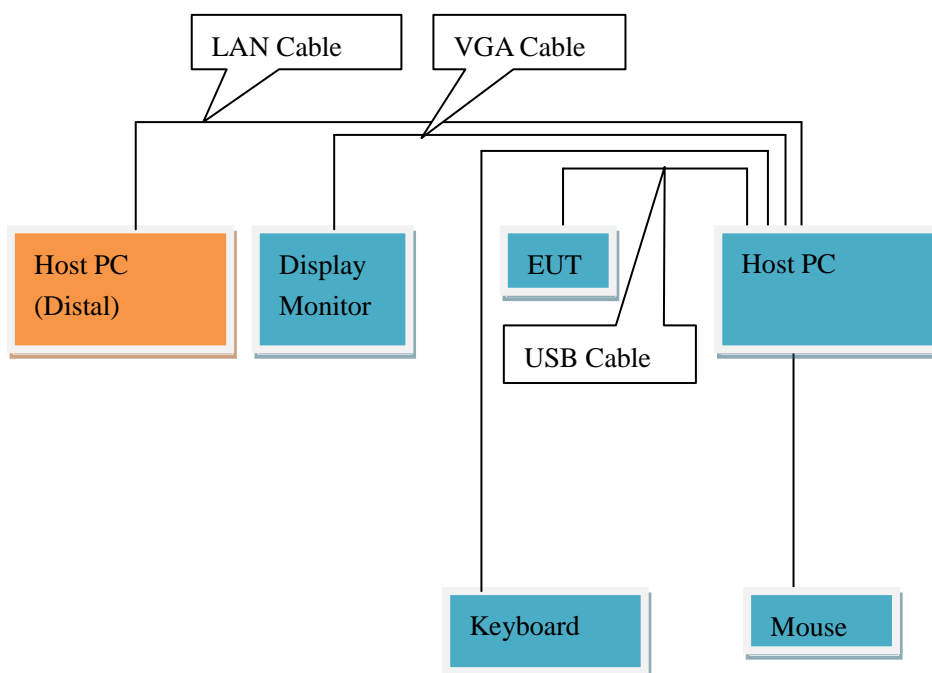

<Figure 1>



<Figure 2>

8. Measurement Results

Only the worst test result was shown in this report.

8.1 Radiated Emission 30MHz-18GHz

Method of Measurement

For 30-1000MHz, the EUT was placed on the top of a rotating 0.8-m table above the ground at a semi-anechoic chamber. The distance between the EUT and the received antenna was 3 meters. The table was rotated 360 degree and the received antenna mounted on a variable-height antenna tower was varied from 1m to 4m to find the maximum value of the field strength. Both horizontal and vertical polarizations of the antenna were set during the measurement. Tested in accordance with the procedures of ANSI C63.4-2014, section 8.3.

For 1000-18000MHz, The maximal emission value was acquired by adjusting the antenna height, The table was rotated 360 degree to determine the maximum value of the field strength. Both horizontal and vertical polarizations of the antenna were set during the measurement.

Limits for Radiated Emission at a measuring distance of 3m

Frequency Range (MHz)	Quasi-Peak (dBuV/m)
30-88	40
88-216	43.5
216-960	46
Above 960	54

Frequency Range (MHz)	Peak (dBuV/m)	Average (dBuV/m)
Above 1000	74	54

Test conditions

Frequency Range (MHz)	RBW/VBW	Sweep Time (s)
30-1000	120KHz/300KHz	Auto
1000-18000	1MHz/3MHz	Auto

Uncertainty Measurement

The measurement uncertainty is 5.48dB (30MHz -1000MHz) and 5.20dB (1GHz -18GHz) (k=2)

Test Results

Mode 1: USB cable (Data Link with PC)

Frequency Range: 30MHz – 1GHz

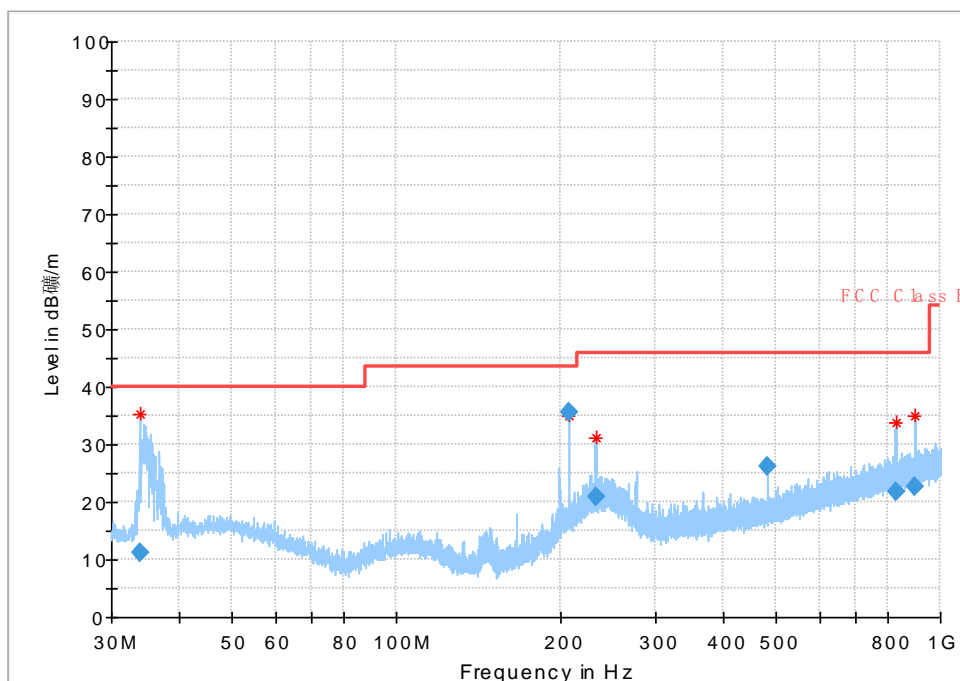

Frequency (MHz)	QuasiPeak (dBµV/m)	Limit (dBµV/m)	Margin (dB)	Meas. Time (ms)	Bandwidth (kHz)	Height (cm)	Pol	Azimuth (deg)	Corr. (dB)
33.887976	11.05	40.00	28.95	1000.0	120.000	224.0	V	194.0	-22.0
207.993480	35.47	43.50	8.03	1000.0	120.000	125.0	H	83.0	-24.3
232.413485	21.00	46.00	25.00	1000.0	120.000	125.0	H	-2.0	-23.6
479.994701	26.04	46.00	19.96	1000.0	120.000	175.0	V	39.0	-17.6
827.679155	21.68	46.00	24.32	1000.0	120.000	181.0	H	82.0	-10.8
897.771320	22.72	46.00	23.28	1000.0	120.000	181.0	H	-10.0	-9.8

Note:

1. Emission level(QP)=Raw value by receiver + Corr(Antenna factor + cable loss - preamplifier gain)
2. The raw value is used to calculate by software which is not shown in the sheet.
3. Margin=limit value – emission level.

Mode 1: USB cable (Data Link with PC)

Frequency Range:	1GHz –18GHz, Horizontal
------------------	-------------------------

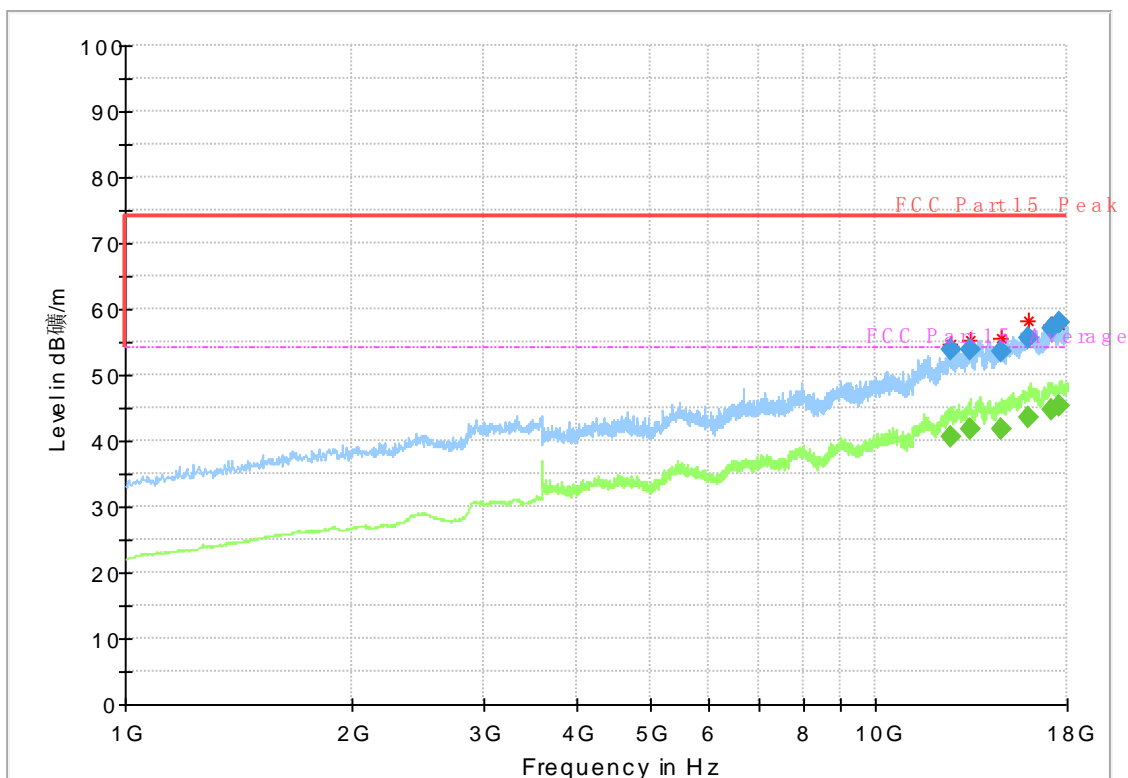

Final Result

Frequency (MHz)	MaxPeak (dBuV/m)	Average (dBuV/m)	Limit (dBuV/m)	Margin (dB)	Meas. Time	Bandwidth (h)	Heigh t	Po l	Azim uth	Corr. (dB)
12607.800000	---	40.66	54.00	13.34	50.0	1000.000	200.0	H	249.0	16.7
12607.800000	53.69	---	74.00	20.31	50.0	1000.000	200.0	H	249.0	16.7
13337.600000	53.91	---	74.00	20.09	50.0	1000.000	200.0	H	168.0	18.0
13337.600000	---	41.67	54.00	12.33	50.0	1000.000	200.0	H	168.0	18.0
14731.600000	53.43	---	74.00	20.57	50.0	1000.000	200.0	H	179.0	19.9
14731.600000	---	41.87	54.00	12.13	50.0	1000.000	200.0	H	179.0	19.9
16021.800000	---	43.65	54.00	10.35	50.0	1000.000	100.0	H	0.0	22.4
16021.800000	55.45	---	74.00	18.55	50.0	1000.000	100.0	H	0.0	22.4
17149.800000	56.97	---	74.00	17.03	50.0	1000.000	100.0	H	127.0	24.1
17149.800000	---	44.62	54.00	9.38	50.0	1000.000	100.0	H	127.0	24.1
17605.000000	57.92	---	74.00	16.08	50.0	1000.000	100.0	H	11.0	24.5
17605.000000	---	45.41	54.00	8.59	50.0	1000.000	100.0	H	11.0	24.5

Note:

1. Emission level(peak or average)=Raw value by receiver + Corr(Antenna factor+ cable loss - preamplifier gain)
2. The raw value is used to calculate by software which is not shown in the sheet.
3. Margin=limit value – emission level.

Frequency Range:

1GHz –18GHz, Vertical

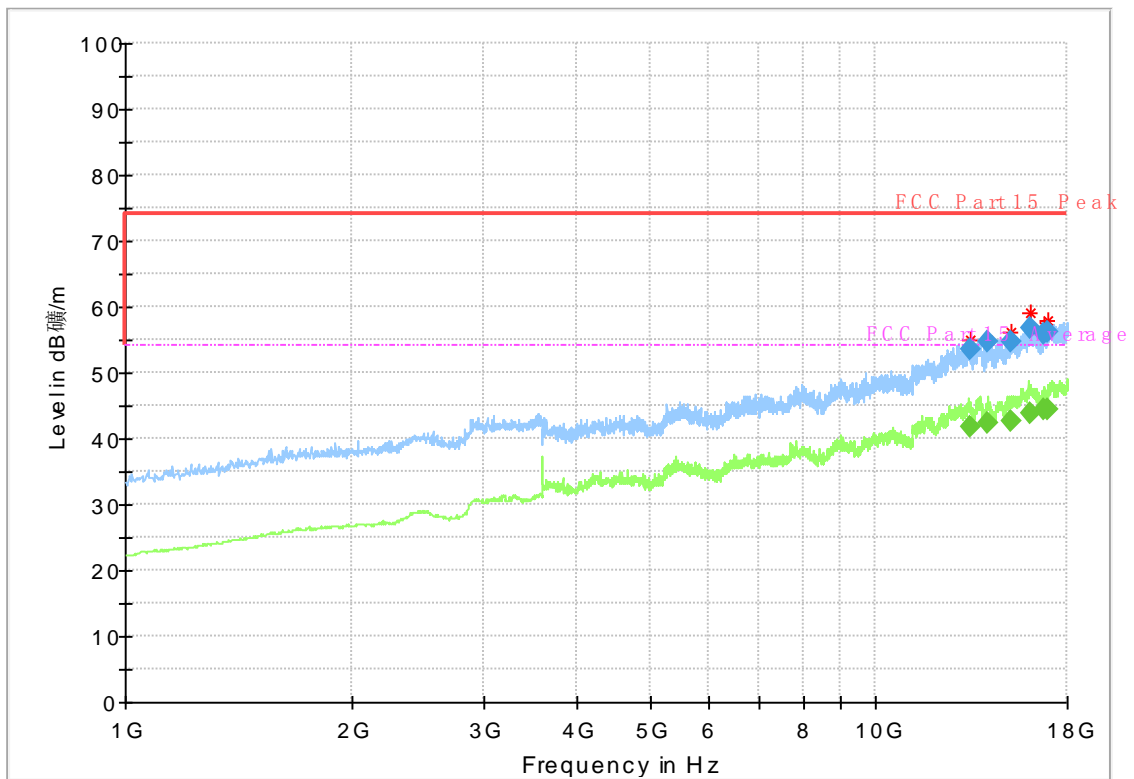

Final Result

Frequency (MHz)	MaxPeak (dBuV/m)	Average (dBuV/m)	Limit (dBuV/m)	Margin (dB)	Meas. Time	Bandwidth h	Heigh t	Po l	Azim uth	Corr. (dB)
13349.400000	53.45	---	74.00	20.55	50.0	1000.000	100.0	V	198.0	18.0
13349.400000	---	41.73	54.00	12.27	50.0	1000.000	100.0	V	198.0	18.0
14096.200000	54.58	---	74.00	19.42	50.0	1000.000	200.0	V	326.0	19.3
14096.200000	---	42.49	54.00	11.51	50.0	1000.000	200.0	V	326.0	19.3
15188.400000	54.57	---	74.00	19.43	50.0	1000.000	100.0	V	116.0	20.7
15188.400000	---	42.65	54.00	11.35	50.0	1000.000	100.0	V	116.0	20.7
16072.400000	---	43.91	54.00	10.09	50.0	1000.000	200.0	V	268.0	22.5
16072.400000	56.65	---	74.00	17.35	50.0	1000.000	200.0	V	268.0	22.5
16760.000000	55.93	---	74.00	18.07	50.0	1000.000	100.0	V	186.0	23.5
16760.000000	---	44.44	54.00	9.56	50.0	1000.000	100.0	V	186.0	23.5
17011.200000	---	44.28	54.00	9.72	50.0	1000.000	200.0	V	338.0	23.8
17011.200000	56.27	---	74.00	17.73	50.0	1000.000	200.0	V	338.0	23.8

Note:

1. Emission level(peak or average)=Raw value by receiver + Corr(Antenna factor+ cable loss - preamplifier gain)
2. The raw value is used to calculate by software which is not shown in the sheet.
3. Margin=limit value – emission level.

8.2 AC Conducted Emission

Method of Measurement

For equipment that is designed to be connected to the public utility (AC) power line, the radio frequency voltage that is conducted back onto the AC power line on any frequency or frequencies with the band 150 kHz to 30MHz shall not exceed the limits. Both lines of the power mains connected to the EUT were checked for maximum conducted interference. Tested in accordance with the procedures of ANSI C63.4-2014, section 7.3

Limit of AC Conducted Emission

Frequency Range (MHz)	Conducted Limit (dBuV)	
	Quasi-peak	Average
0.15-0.5	66 to 56*	56 to 46*
0.5-5	56	46
5-30	60	50

*Decreases with the logarithm of the frequency

Test Condition in Charging Mode

Voltage (V)	Frequency (Hz)	RBW	Sweep Time (s)
120	60	9 KHz	Auto

Uncertainty Measurement

The measurement uncertainty is 3.68dB (k=2).

Test Results

Mode 2: Adapter charging

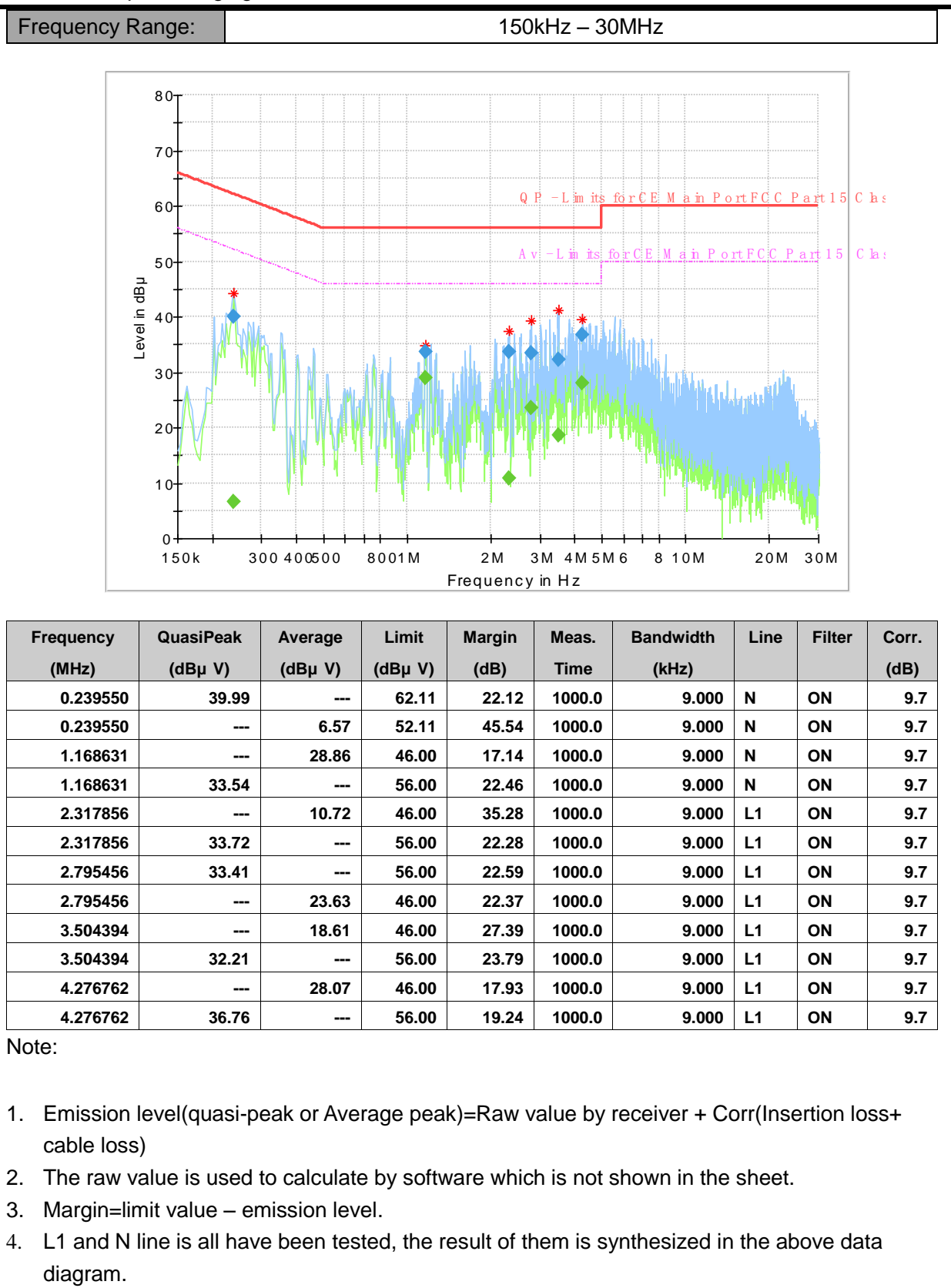

*****END OF REPORT*****