



# RF TEST REPORT

**Applicant**      Mobiwire SAS  
**FCC ID**          QPN-HOTAH  
**Product**        MobiWire Hotah  
**Brand**            MobiWire  
**Model**            MobiWire Hotah  
**Report No.**      R1809A0432-R5  
**Issue Date**      November 23, 2018

TA Technology (Shanghai) Co., Ltd. tested the above equipment in accordance with the requirements in **FCC CFR47 Part 15C (2018)**. The test results show that the equipment tested is capable of demonstrating compliance with the requirements as documented in this report.

*Performed by: Peng Tao*

*Approved by: Kai Xu*

---

## TA Technology (Shanghai) Co., Ltd.

*No.145, Jintang Rd, Tangzhen Industry Park, Pudong Shanghai, China*

*TEL: +86-021-50791141/2/3*

*FAX: +86-021-50791141/2/3-8000*



## TABLE OF CONTENT

1. Test Laboratory .....	4
1.1. Notes of the test report.....	4
1.2. Test facility .....	4
1.3. Testing Location .....	5
2. General Description of Equipment under Test.....	6
3. Applied Standards .....	8
4. Test Configuration .....	9
5. Test Case Results .....	10
5.1. Maximum conducted output power .....	10
5.2. 6dB Bandwidth .....	13
5.3. Band Edge .....	18
5.4. Power Spectral Density .....	21
5.5. Spurious RF Conducted Emissions.....	26
5.6. Unwanted Emission .....	31
5.7. Conducted Emission .....	70
6. Main Test Instruments .....	72
ANNEX A: EUT Appearance and Test Setup .....	73
A.1 EUT Appearance .....	73
A.2 Test Setup .....	77



## Summary of measurement results

Number	Summary of measurements of results	Clause in FCC rules	Verdict
1	Maximum conducted output power	15.247(b)(3)	PASS
2	6 dB bandwidth	15.247(a)(2)	PASS
3	Power spectral density	15.247(e)	PASS
4	Band Edge	15.247(d)	PASS
5	Spurious RF Conducted Emissions	15.247(d)	PASS
6	Unwanted Emissions	15.247(d),15.205,15.209	PASS
7	Conducted Emissions	15.207	PASS
Date of Testing: September 24, 2018 ~November 5, 2018			



## 1. Test Laboratory

### 1.1. Notes of the test report

This report shall not be reproduced in full or partial, without the written approval of **TA technology (shanghai) co., Ltd.** The results documented in this report apply only to the tested sample, under the conditions and modes of operation as described herein .Measurement Uncertainties were not taken into account and are published for informational purposes only. This report is written to support regulatory compliance of the applicable standards stated above.

### 1.2. Test facility

#### **CNAS (accreditation number: L2264)**

TA Technology (Shanghai) Co., Ltd. has obtained the accreditation of China National Accreditation Service for Conformity Assessment (CNAS).

#### **FCC (Designation number: CN1179, Test Firm Registration Number: 446626)**

TA Technology (Shanghai) Co., Ltd. has been listed on the US Federal Communications Commission list of test facilities recognized to perform electromagnetic emissions measurements.

#### **IC (recognition number is 8510A)**

TA Technology (Shanghai) Co., Ltd. has been listed by industry Canada to perform electromagnetic emission measurement.

#### **VCCI (recognition number is C-4595, T-2154, R-4113, G-10766)**

TA Technology (Shanghai) Co., Ltd. has been listed by industry Japan to perform electromagnetic emission measurement.

#### **A2LA (Certificate Number: 3857.01)**

TA Technology (Shanghai) Co., Ltd. has been listed by American Association for Laboratory Accreditation to perform electromagnetic emission measurement.



### 1.3. Testing Location

Company: TA Technology (Shanghai) Co., Ltd.  
Address: No.145, Jintang Rd, Tangzhen Industry Park, Pudong  
City: Shanghai  
Post code: 201201  
Country: P. R. China  
Contact: Xu Kai  
Telephone: +86-021-50791141/2/3  
Fax: +86-021-50791141/2/3-8000  
Website: <http://www.ta-shanghai.com>  
E-mail: [xukai@ta-shanghai.com](mailto:xukai@ta-shanghai.com)

## 2. General Description of Equipment under Test

### Client Information

Applicant	Mobiwire SAS
Applicant address	79 avenue Francois Arago, 92000 NANTERRE France
Manufacturer	Mobiwire SAS
Manufacturer address	79 avenue Francois Arago, 92000 NANTERRE France

### General information

EUT Description	
Model	MobiWire Hotah
IMEI	IMEI 1: 352361100000124 IMEI 2: 352361100000132
Hardware Version	V01
Software Version	V01
Power Supply	Battery/AC adapter
Antenna Type	Internal Antenna
Antenna Connector	A permanently attached antenna (meet with the standard FCC Part 15.203 requirement)
Antenna Gain	0.00 dBi
additional beamforming gain	NA
Test Mode	Bluetooth V4.2 LE 802.11b 802.11g, 802.11n(HT20/HT40);
Modulation Type	BLE :GFSK 802.11b: DSSS; 802.11g/n(HT20/HT40): OFDM
Max. Conducted Power	Wi-Fi 2.4G :16.28dBm BLE : 6.29dBm
Operating Frequency Range(s)	802.11b/g/n(HT20): 2412 ~ 2462 MHz 802.11n(HT40): 2422 ~ 2452 MHz BLE: 2402 ~2480 MHz
EUT Accessory	
Battery	Manufacturer: Ningbo Veken Battery Co.,LTD Model: 178144515
Adapter 1	Manufacturer: DongGuan Aohai Power Technology Co.,Ltd Model: A88-502000



Adapter 2	Manufacturer: Dongguan Aohai Power Technology CO., LTD Model: A824-050200U
Adapter 3	Manufacturer: Dongguan Aohai Power Technology CO., LTD Model: A70-502000
Earphone	Manufacturer: Shenzhen Juwei Electronics Co.,Ltd Model: JWEP0752-M01
USB Cable	Manufacturer: Shenzhen Juwei Electronics Co.,Ltd Model: USB2.0 A/M TO TYPE C/M CABLE 1M
Note: The information of the EUT is declared by the manufacturer. 2. There is more than one Adapter, each one should be applied throughout the compliance test respectively, and however, only the worst case (Adapter 1) will be recorded in this report.	

### 3. Applied Standards

According to the specifications of the manufacturer, it must comply with the requirements of the following standards:

#### Test standards

- **FCC CFR47 Part 15C (2018) Radio Frequency Devices**
- **ANSI C63.10 (2013)**
- **KDB 558074 D01 DTS Meas Guidance v05**



## 4. Test Configuration

### Test Mode

The EUT has been associated with peripherals and configuration operated in a manner tended to maximize its emission characteristics in a typical application.

The radiated emission was measured in the following position: EUT stand-up position (Z axis), lie-down position (X, Y axis). The worst emission was found in lie-down position (X axis) and the worst case was recorded.

In order to find the worst case condition, Pre-tests are needed at the presence of different data rate. Preliminary tests have been done on all the configuration for confirming worst case. Data rate below means worst-case rate of each test item.

Worst-case data rates are shown as following table.

Band	Data Rate
Bluetooth(Low Energy)	1 Mbps
802.11b	1 Mbps
802.11g	6 Mbps
802.11n HT20	MCS0
802.11n HT40	MCS0

## 5. Test Case Results

### 5.1. Maximum output power

#### Ambient condition

Temperature	Relative humidity	Pressure
23°C ~25°C	45%~50%	101.5kPa

#### Methods of Measurement

During the process of the testing, The EUT was connected to Average Power meter with a known loss. The EUT is max power transmission with proper modulation. The signal transmission is continuous.

#### Test Setup

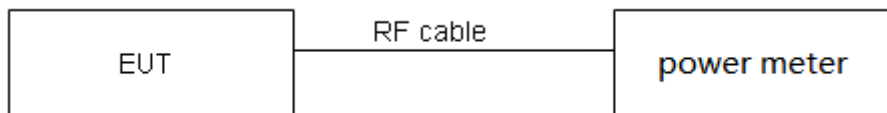

#### Limits

Rule Part 15.247 (b) (3) specifies that " For systems using digital modulation in the 902–928 MHz, 2400–2483.5 MHz: 1 Watt."

Average Output Power	$\leq 1W$ (30dBm)
----------------------	-------------------

#### Measurement Uncertainty

The assessed measurement uncertainty to ensure 95% confidence level for the normal distribution is with the coverage factor  $k = 2$ ,  $U = 0.44$  dB.

**Test Results**

<b>Single Antenna Power Index</b>			
<b>Packet Type</b>	<b>CH1</b>	<b>CH6</b>	<b>CH11</b>
802.11b	19	19	19
802.11g	17	17	17
802.11n HT20	17	17	17
<b>Packet Type</b>	<b>CH3</b>	<b>CH6</b>	<b>CH9</b>
802.11n HT40	16.5	16.5	16.5

<b>Band</b>	<b>T<sub>on</sub> (ms)</b>	<b>T<sub>(on+off)</sub> (ms)</b>	<b>Duty cycle</b>	<b>Duty cycle correction Factor(dB)</b>
802.11b	8.38	8.42	1.00	0.00
802.11g	1.39	1.43	0.97	0.11
802.11n HT20	1.30	1.34	0.97	0.12
802.11n HT40	0.65	0.68	0.95	0.23
BLE	0.38	0.62	0.609	2.154

Note: when Duty cycle>0.98, Duty cycle correction Factor not required.



Network Standards	Carrier frequency (MHz)	Average Power Measured (dBm)	Average Power with duty factor (dBm)	Limit (dBm)	Conclusion
802.11b	2412	16.15	16.15	30	PASS
	2437	16.28	16.28	30	PASS
	2462	16.24	16.24	30	PASS
802.11g	2412	12.03	12.14	30	PASS
	2437	14.28	14.39	30	PASS
	2462	11.94	12.05	30	PASS
802.11n HT20	2412	12.18	12.30	30	PASS
	2437	14.53	14.65	30	PASS
	2462	11.89	12.01	30	PASS
802.11n HT40	2422	10.63	10.86	30	PASS
	2437	13.22	13.45	30	PASS
	2452	10.72	10.95	30	PASS
Bluetooth (Low Energy)	2402	3.74	5.89	30	PASS
	2440	4.14	6.29	30	PASS
	2480	2.85	5.00	30	PASS

Note: Average Power with duty factor = Average Power Measured +Duty cycle correction factor

## 5.2. 6dB Bandwidth

### Ambient condition

Temperature	Relative humidity	Pressure
23°C ~25°C	45%~50%	101.5kPa

### Method of Measurement

The EUT was connected to the spectrum analyzer through an external attenuator (20dB) and a known loss cable. RBW is set to 100 kHz; VBW is set to 300 kHz on spectrum analyzer. Dector=Peak, Trace mode=max hold.

### Test Setup

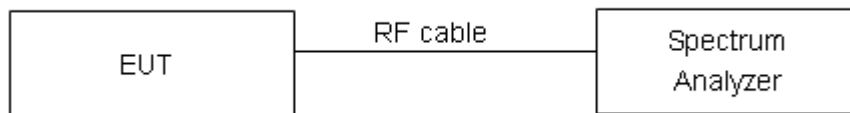

### Limits

Rule Part 15.247 (a) (2) specifies that “Systems using digital modulation techniques may operate in the 902–928 MHz, 2400–2483.5 MHz bands. The minimum 6 dB bandwidth shall be at least 500 kHz.”

minimum 6 dB bandwidth	≥ 500 kHz
------------------------	-----------

### Measurement Uncertainty

The assessed measurement uncertainty to ensure 95% confidence level for the normal distribution is with the coverage factor  $k = 2$ ,  $U = 936$  Hz.

**Test Results:**

Network Standards	Carrier frequency (MHz)	99% bandwidth (MHz)	Minimum 6 dB bandwidth (MHz)	Limit (kHz)	Conclusion
802.11b	2412	12.383	9.565	500	PASS
	2437	12.605	10.07	500	PASS
	2462	12.450	9.091	500	PASS
802.11g	2412	16.382	15.71	500	PASS
	2437	16.450	15.81	500	PASS
	2462	16.334	15.45	500	PASS
802.11n HT20	2412	17.517	16.05	500	PASS
	2437	17.595	16.81	500	PASS
	2462	17.446	15.13	500	PASS
802.11n HT40	2422	35.834	35.17	500	PASS
	2437	36.119	35.59	500	PASS
	2452	35.790	35.15	500	PASS
Bluetooth (Low Energy)	2402	1.0385	0.7030	500	PASS
	2440	1.0394	0.7051	500	PASS
	2480	1.0366	0.7086	500	PASS

802.11b, Carrier frequency (MHz): 2412



802.11g, Carrier frequency (MHz): 2412



802.11b, Carrier frequency (MHz): 2437



802.11g, Carrier frequency (MHz): 2437



802.11b, Carrier frequency (MHz): 2462



802.11g, Carrier frequency (MHz): 2462





802.11n(HT20), Carrier frequency (MHz): 2412



802.11n(HT40), Carrier frequency (MHz): 2422



802.11n(HT20), Carrier frequency (MHz): 2437

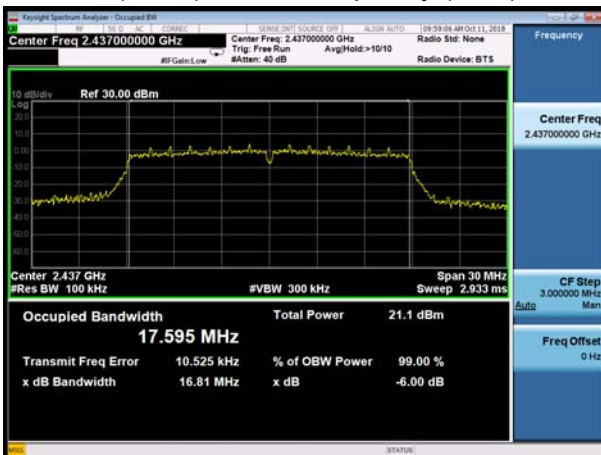

802.11n(HT40), Carrier frequency (MHz): 2437

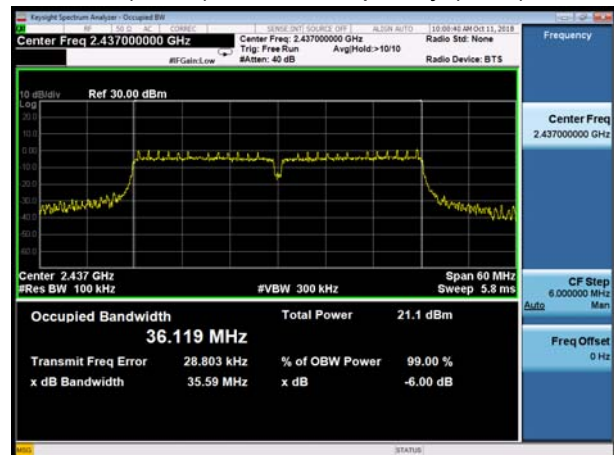

802.11n(HT20), Carrier frequency (MHz):2462



802.11n(HT40), Carrier frequency (MHz):2452







BLE Carrier frequency (MHz): 2402



BLE Carrier frequency (MHz): 2440



BLE Carrier frequency (MHz): 2480



### 5.3. Band Edge

#### Ambient condition

Temperature	Relative humidity	Pressure
23°C ~25°C	45%~50%	101.5kPa

#### Method of Measurement

The EUT was connected to the spectrum analyzer through an external attenuator (20dB) and a known loss cable the band edge of the lowest and highest channels were measured. The peak detector is used and RBW is set to 100 kHz and VBW is set to 300 kHz on spectrum analyzer. Spectrum analyzer plots are included on the following pages.

#### Test Setup

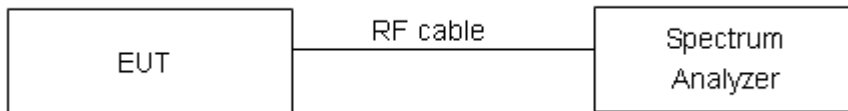

#### Limits

Rule Part 15.247(d) specifies that “In any 100 kHz bandwidth outside the frequency band in which the spread spectrum or digitally modulated intentional radiator is operating, the radio frequency power that is produced by the intentional radiator shall be at least 20 dB below that in the 100 kHz bandwidth within the band that contains the highest level of the desired power, based on either an RF conducted or a radiated measurement, provided the transmitter demonstrates compliance with the peak conducted power limits.” If the transmitter complies with the conducted power limits based on the use of RMS averaging over a time interval, as permitted under paragraph (b)(3) of this section, the attenuation required under this paragraph shall be 30 dB instead of 20 dB.”

#### Measurement Uncertainty

The assessed measurement uncertainty to ensure 95% confidence level for the normal distribution is with the coverage factor  $k = 1.96$ .

Frequency	Uncertainty
2GHz-3GHz	1.407 dB



Test Results: PASS

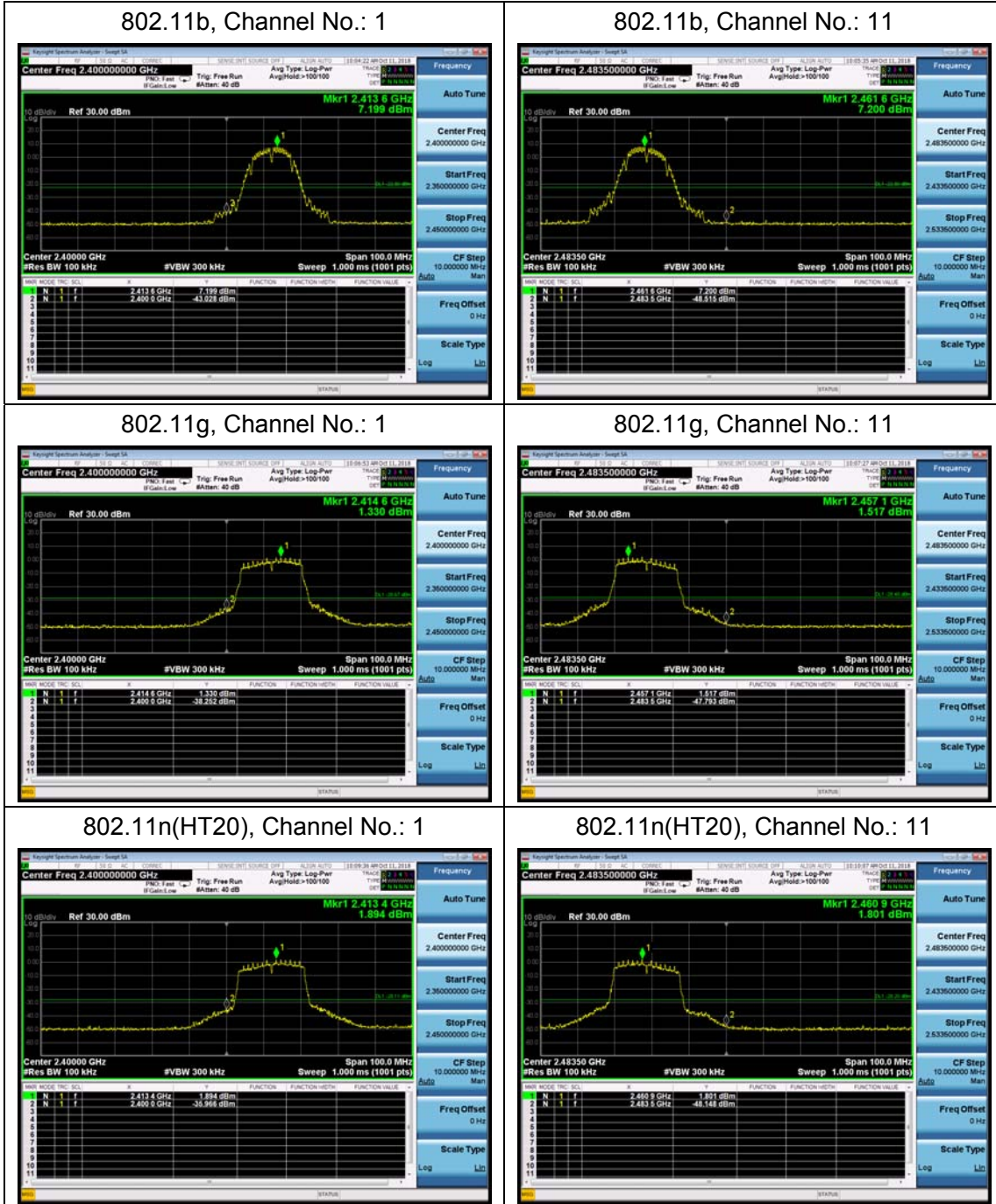



802.11n(HT40), Channel No.: 3

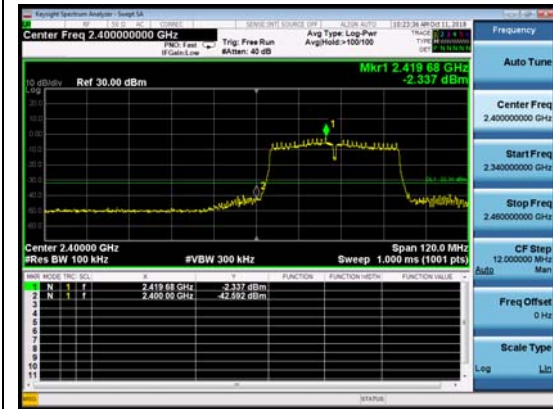

802.11n(HT40), Channel No.: 9

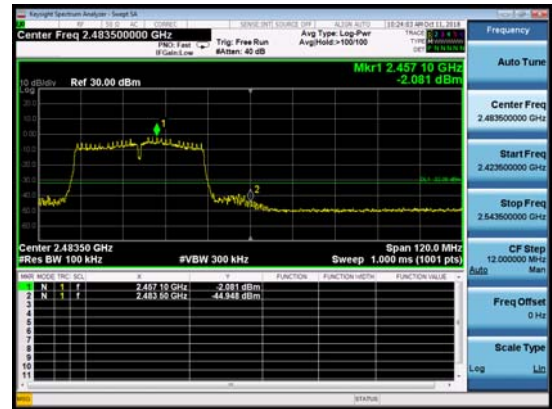

BLE, Channel No.: 0

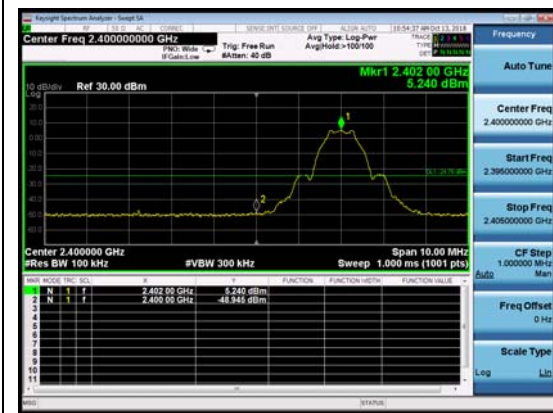

BLE, Channel No.: 39

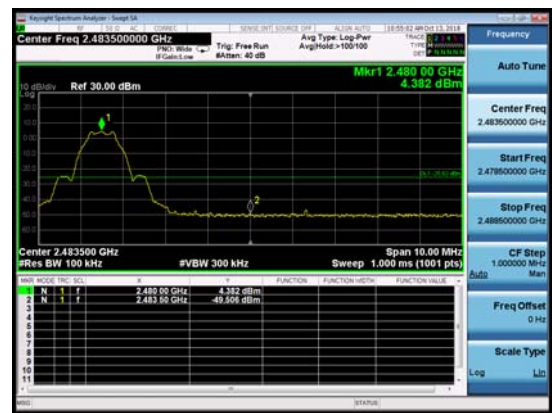

### 5.4. Power Spectral Density

#### Ambient condition

Temperature	Relative humidity	Pressure
23°C ~25°C	45%~50%	101.5kPa

#### Method of Measurement

During the process of the testing, The EUT was connected to Spectrum Analyzer with a known loss. The EUT is max power transmission with proper modulation. Method AVGPSD-2 in KDB558074 D01 was used for this test.

#### Test setup

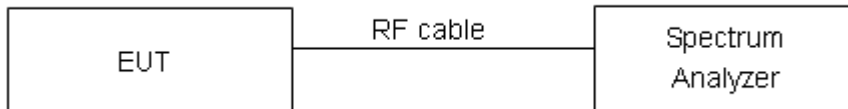

#### Limits

Rule Part 15.247(e) specifies that” For digitally modulated systems, the power spectral density conducted from the intentional radiator to the antenna shall not be greater than 8 dBm in any 3 kHz band during any time interval of continuous transmission. ”

Limits	≤ 8 dBm / 3kHz
--------	----------------

#### Measurement Uncertainty

The assessed measurement uncertainty to ensure 95% confidence level for the normal distribution is with the coverage factor  $k = 2$ ,  $U = 0.75\text{dB}$ .

**Test Results:**

Network Standards	Channel Number	Read Value (dBm / 3kHz)	Power Spectral Density (dBm / 3kHz)	Limit (dBm / 3kHz)	Conclusion
802.11b	1	-16.64	-16.64	8	PASS
	6	-16.33	-16.33	8	PASS
	11	-16.59	-16.59	8	PASS
802.11g	1	-22.39	-22.28	8	PASS
	6	-20.01	-19.90	8	PASS
	11	-21.83	-21.72	8	PASS
802.11n HT20	1	-21.73	-21.61	8	PASS
	6	-19.31	-19.19	8	PASS
	11	-21.44	-21.32	8	PASS
802.11n HT40	3	-26.13	-25.90	8	PASS
	6	-24.51	-24.27	8	PASS
	9	-26.16	-25.92	8	PASS
Bluetooth (Low Energy)	0	-13.37	-11.22	8	PASS
	19	-13.30	-11.15	8	PASS
	39	-14.41	-12.25	8	PASS

Note: Power Spectral Density =Read Value+Duty cycle correction factor





802.11b, Channel No.: 1



802.11g, Channel No.: 1



802.11b, Channel No.: 6



802.11g, Channel No.: 6



802.11b, Channel No.: 11



802.11g, Channel No.: 11

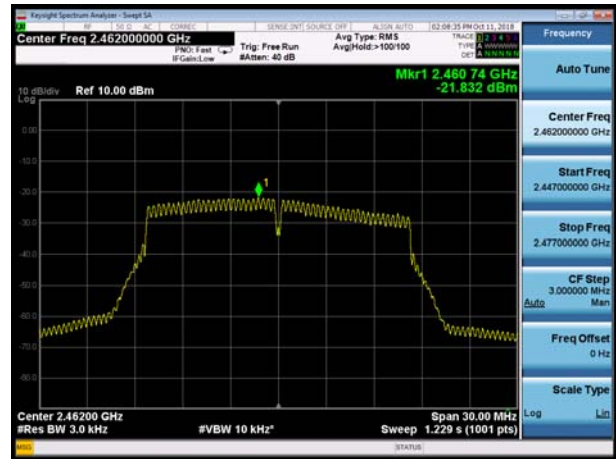



802.11n(HT20), Channel No. 1



802.11n(HT40), Channel No. 3

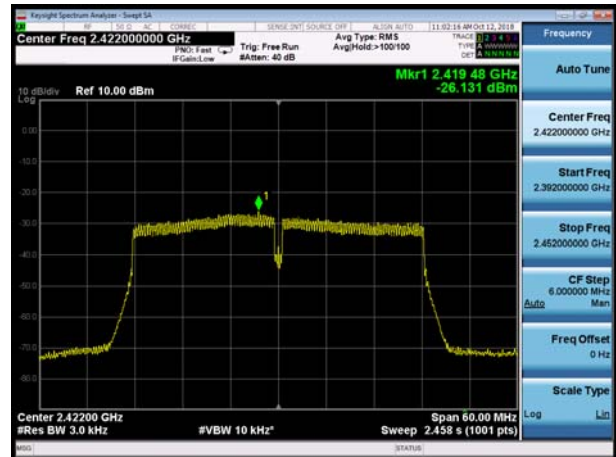

802.11n(HT20), Channel No. 6



802.11n(HT40), Channel No. 6



802.11n(HT20), Channel No. 11



802.11n(HT40), Channel No. 9

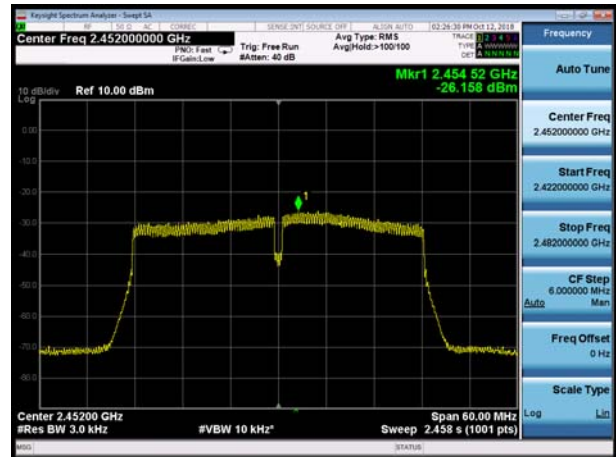





BLE, Channel No.: 0

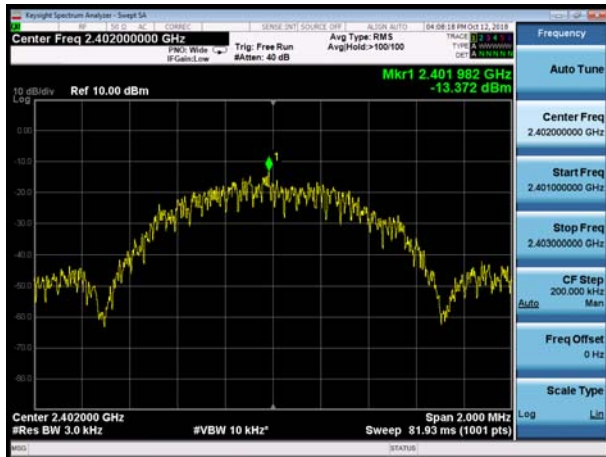

BLE, Channel No.: 19

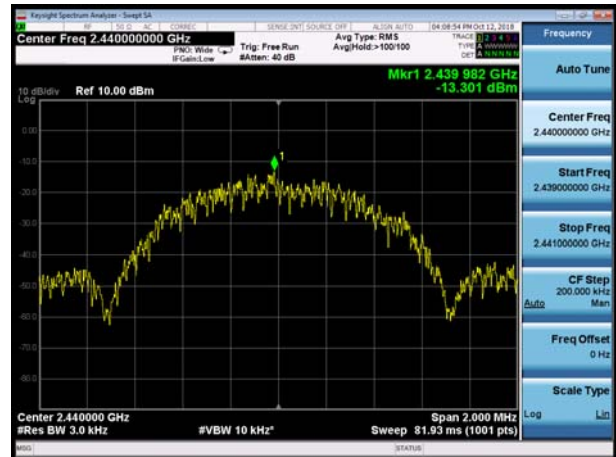

BLE, Channel No.: 39

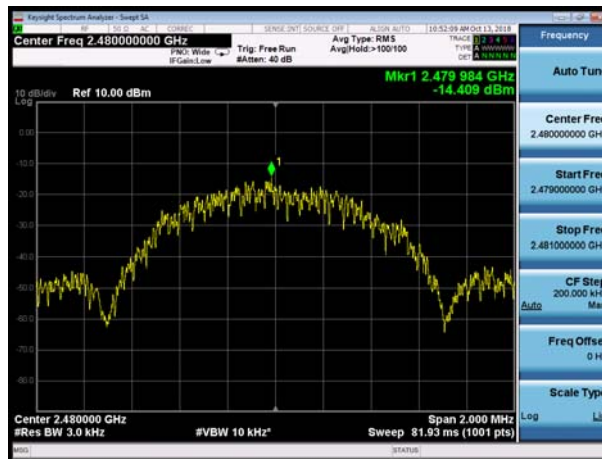

### 5.5. Spurious RF Conducted Emissions

**Ambient condition**

Temperature	Relative humidity	Pressure
23°C ~25°C	45%~50%	101.5kPa

**Method of Measurement**

The EUT was connected to the spectrum analyzer with a known loss. The spectrum analyzer scans from 30MHz to the 10th harmonic of the carrier. The peak detector is used. Set RBW to 100 kHz and VBW to 300 kHz, Sweep is set to ATUO.

The test is in transmitting mode.

**Test setup**



**Limits**

Rule Part 15.247(d) pacifies that “In any 100 kHz bandwidth outside the frequency band in which the spread spectrum or digitally modulated intentional radiator is operating, the radio frequency power that is produced by the intentional radiator shall be at least 20 dB below that in the 100 kHz bandwidth within the band that contains the highest level of the desired power, based on either an RF conducted or a radiated measurement, provided the transmitter demonstrates compliance with the peak conducted power limits. If the transmitter complies with the conducted power limits based on the use of RMS averaging over a time interval, as permitted under paragraph (b)(3) of this section, the attenuation required under this paragraph shall be 30 dB instead of 20 dB. ”

Network Standards	Carrier frequency (MHz)	Reference value (dBm)	Limit
802.11b	2412	7.60	-22.40
	2437	7.15	-22.85
	2462	7.71	-22.29
802.11g	2412	1.49	-28.51
	2437	3.04	-26.96
	2462	-0.70	-30.70
802.11n HT20	2412	1.49	-28.51
	2437	3.97	-26.03
	2462	1.85	-28.15
802.11n HT40	2422	-2.33	-32.33
	2437	0.12	-29.88
	2452	-1.84	-31.84



Bluetooth (Low Energy)	2402	4.83	-25.17
	2440	5.92	-24.08
	2480	4.18	-25.82

### Measurement Uncertainty

The assessed measurement uncertainty to ensure 95% confidence level for the normal distribution is with the coverage factor  $k = 1.96$ .

Frequency	Uncertainty
100kHz-2GHz	0.684 dB
2GHz-26GHz	1.407 dB



Test Results:

802.11b, Channel No.: 1

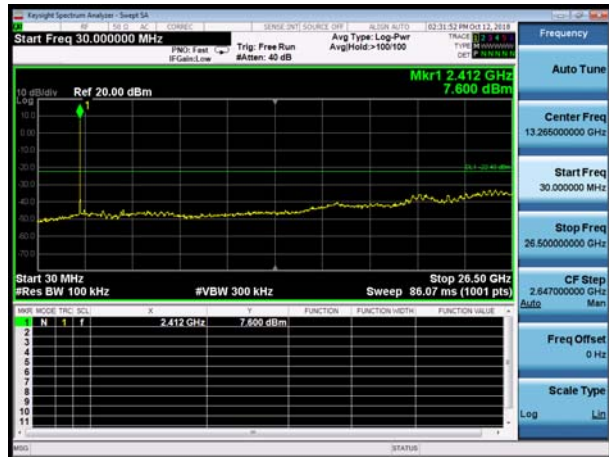

802.11g, Channel No.: 1

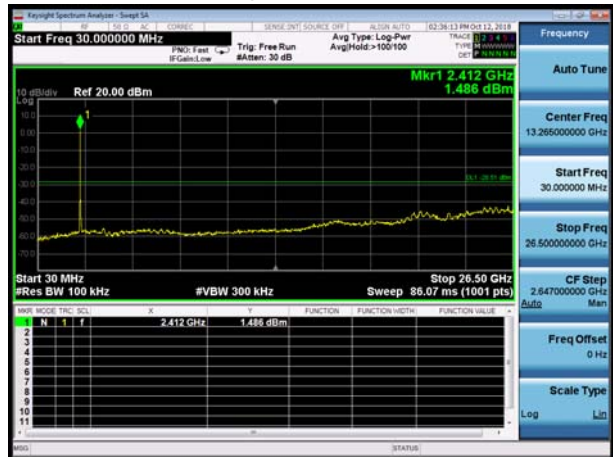

802.11b, Channel No.: 6

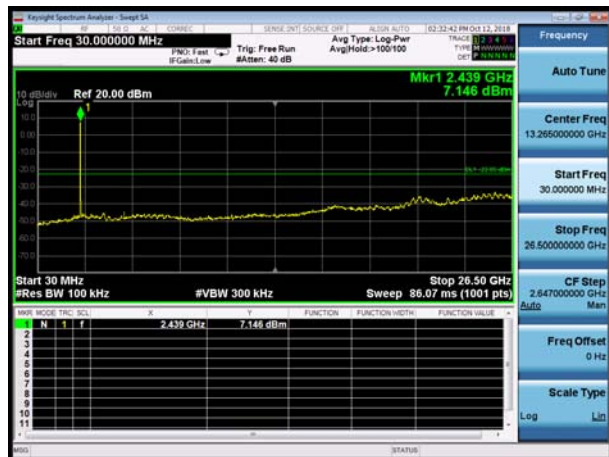

802.11g, Channel No.: 6

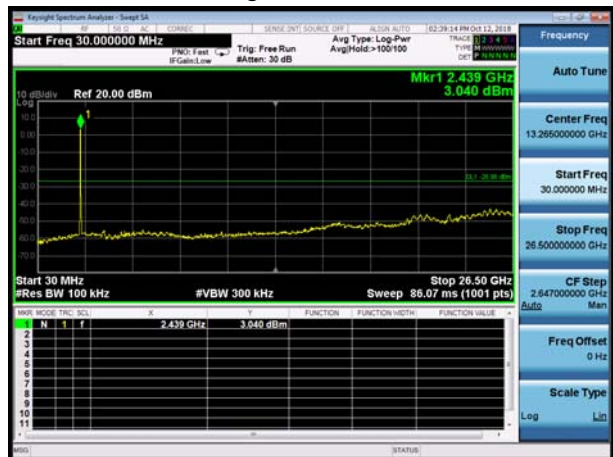

802.11b, Channel No.: 11

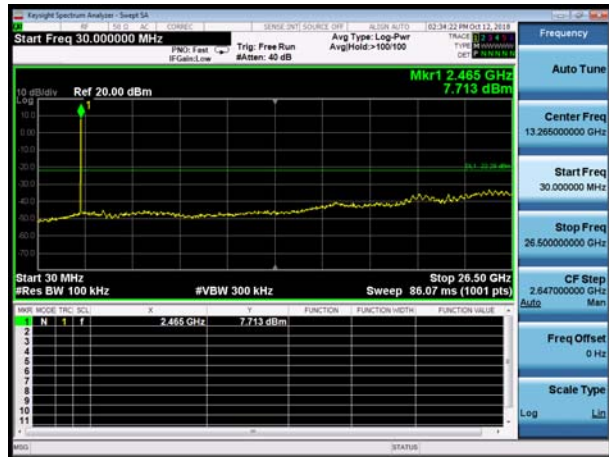

802.11g, Channel No.: 11

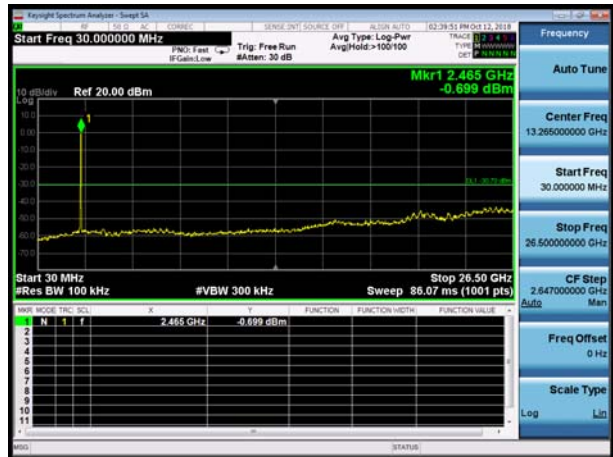



802.11n(HT20), Channel No. 1

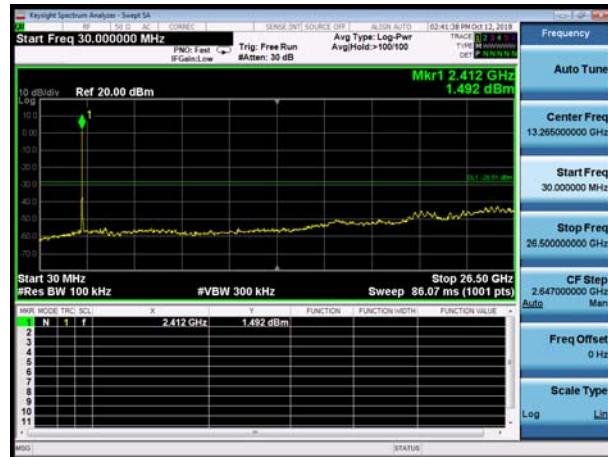

802.11n(HT40), Channel No. 3

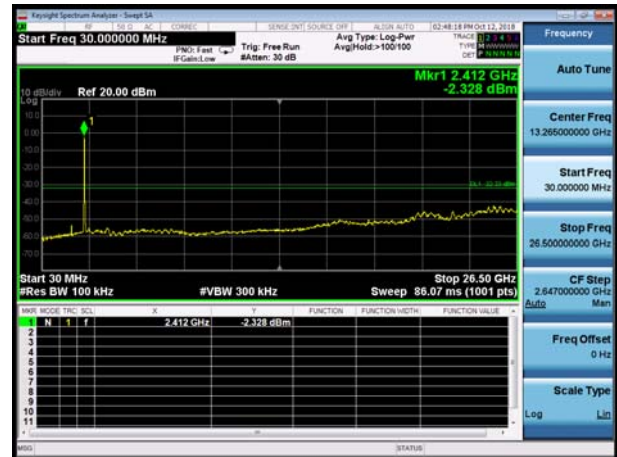

802.11n(HT20), Channel No. 6

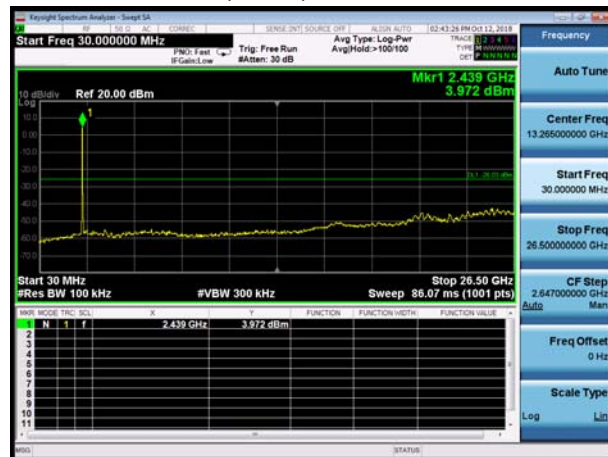

802.11n(HT40), Channel No. 6

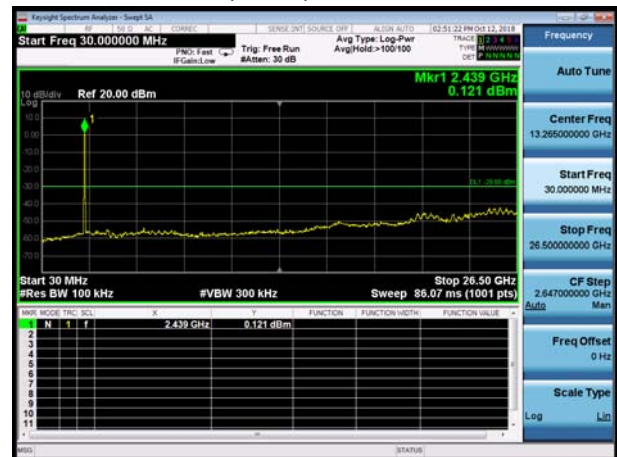

802.11n(HT20), Channel No. 11

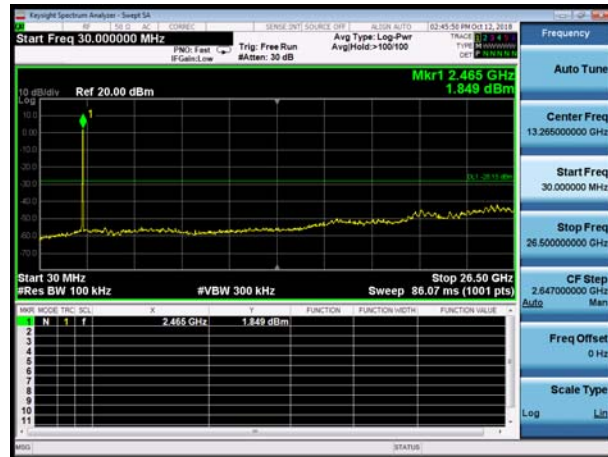

802.11n(HT40), Channel No. 9

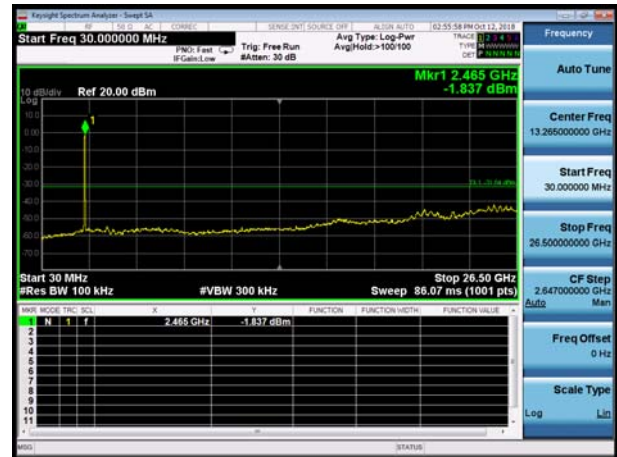





BLE, Channel No.: 0

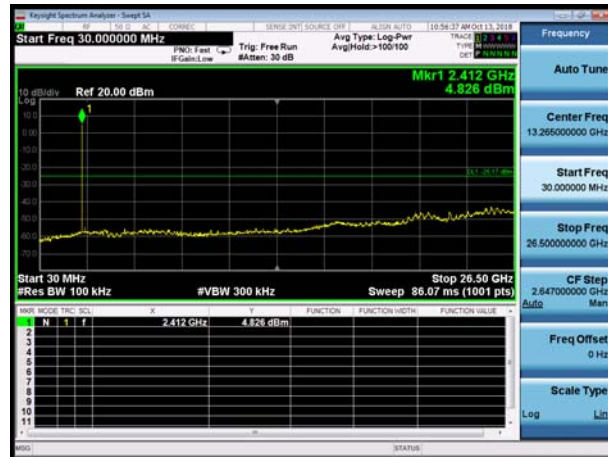

BLE, Channel No.: 19

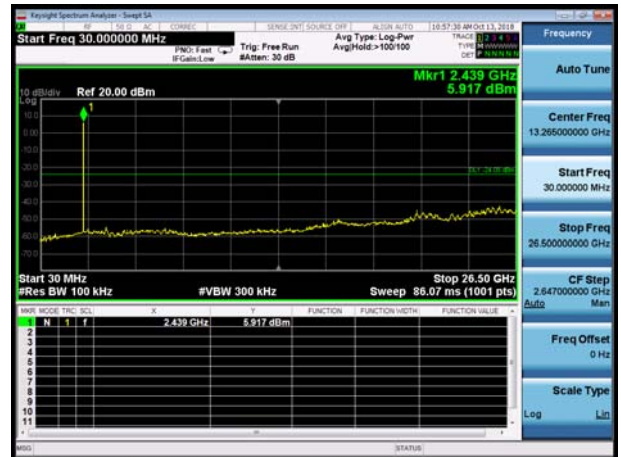

BLE, Channel No.: 39

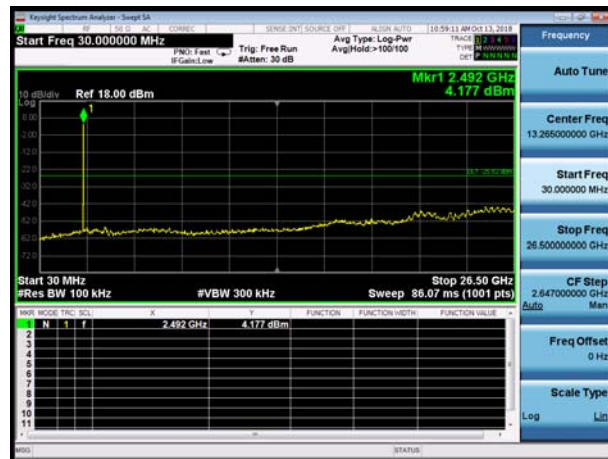

## 5.6. Unwanted Emission

### Ambient condition

Temperature	Relative humidity	Pressure
23°C ~25°C	45%~50%	102.5kPa

### Method of Measurement

The test set-up was made in accordance to the general provisions of ANSI C63.10-2013. The Equipment Under Test (EUT) was set up on a non-conductive table in the semi-anechoic chamber. The test was performed at the distance of 3 m between the EUT and the receiving antenna.

The turntable shall be rotated from 0 to 360 degrees for detecting the maximum of radiated spurious signal level. The measurements shall be repeated with orthogonal polarization of the test antenna. The data of cable loss and antenna factor has been calibrated in full testing frequency range before the testing. Sweep the Restricted Band and the emissions less than 20 dB below the permissible value are reported.

The radiated emissions measurements were made in a typical installation configuration. Sweep the whole frequency band through the range from 9 kHz to the 10th harmonic of the carrier, and the emissions less than 20 dB below the permissible value are reported.

This method refer to ANSI C63.10-2013.

The procedure for peak unwanted emissions measurements above 1000 MHz is as follows:

I) Peak emission levels are measured by setting the instrument as follows:

- 1) RBW = 1 MHz.
- 2) VBW  $\geq$  [3  $\times$  RBW]
- 3) Detector = peak.
- 4) Sweep time = auto.
- 5) Trace mode = max hold.
- 6) Allow sweeps to continue until the trace stabilizes. Note that if the transmission is not continuous, then the time required for the trace to stabilize will increase by a factor of approximately 1 / D, where D is the duty cycle.

II) Average emission levels are measured by setting the instrument as follows:

- a) RBW = 1 MHz.
- b) VBW  $\geq$  [3  $\times$  RBW].
- c) Detector = RMS (power averaging), if [span / (# of points in sweep)]  $\leq$  RBW / 2. Satisfying this condition can require increasing the number of points in the sweep or reducing the span. If the condition is not satisfied, then the detector mode shall be set to peak.
- d) Averaging type = power (i.e., rms) (As an alternative, the detector and averaging type may be set for linear voltage averaging. Some instruments require linear display mode to use linear voltage



averaging. Log or dB averaging shall not be used.)

e) Sweep time = auto.

f) Perform a trace average of at least 100 traces if the transmission is continuous. If the transmission is not continuous, then the number of traces shall be increased by a factor of  $1 / D$ , where  $D$  is the duty cycle. For example, with 50% duty cycle, at least 200 traces shall be averaged. (If a specific emission is demonstrated to be continuous—i.e., 100% duty cycle—then rather than turning ON and OFF with the transmit cycle, at least 100 traces shall be averaged.)

g) If tests are performed with the EUT transmitting at a duty cycle less than 98%, then a correction factor shall be added to the measurement results prior to comparing with the emission limit, to compute the emission level that would have been measured had the test been performed at 100% duty cycle. The correction factor is computed as follows:

1) If power averaging (rms) mode was used in the preceding step e), then the correction factor is  $[10 \log (1 / D)]$ , where  $D$  is the duty cycle. For example, if the transmit duty cycle was 50%, then 3 dB shall be added to the measured emission levels.

2) If linear voltage averaging mode was used in the preceding step e), then the correction factor is  $[20 \log (1 / D)]$ , where  $D$  is the duty cycle. For example, if the transmit duty cycle was 50%, then 6 dB shall be added to the measured emission levels.

3) If a specific emission is demonstrated to be continuous (100% duty cycle) rather than turning ON and OFF with the transmit cycle, then no duty cycle correction is required for that emission.

The field strength of spurious emission was measured in the following position: EUT stand-up position (Z axis), lie-down position (X, Y axis). The worst emission was found in lie-down position (X axis) and the loop antenna is vertical, the other antennas are vertical and horizontal.

The test is in transmitting mode.



**Test setup**

**9KHz ~ 30MHz**

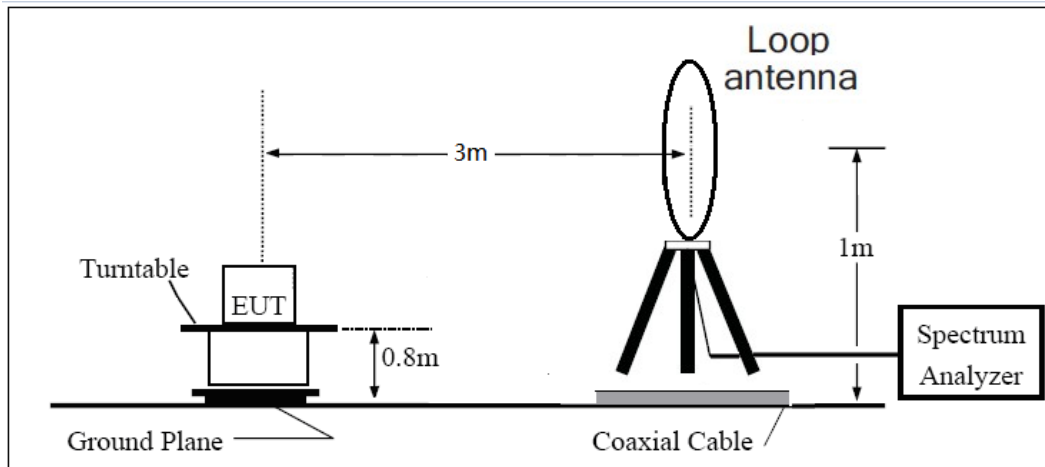

**30MHz ~ 1GHz**

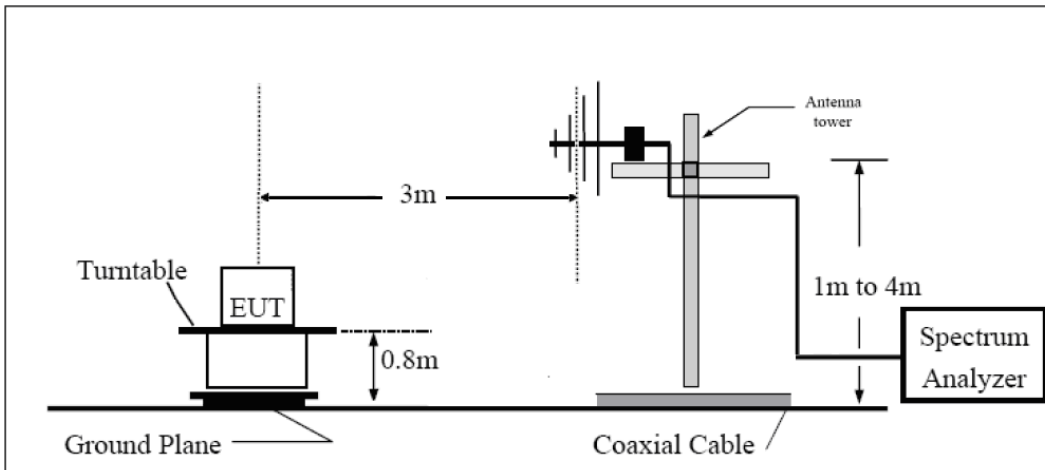

**Above 1GHz**

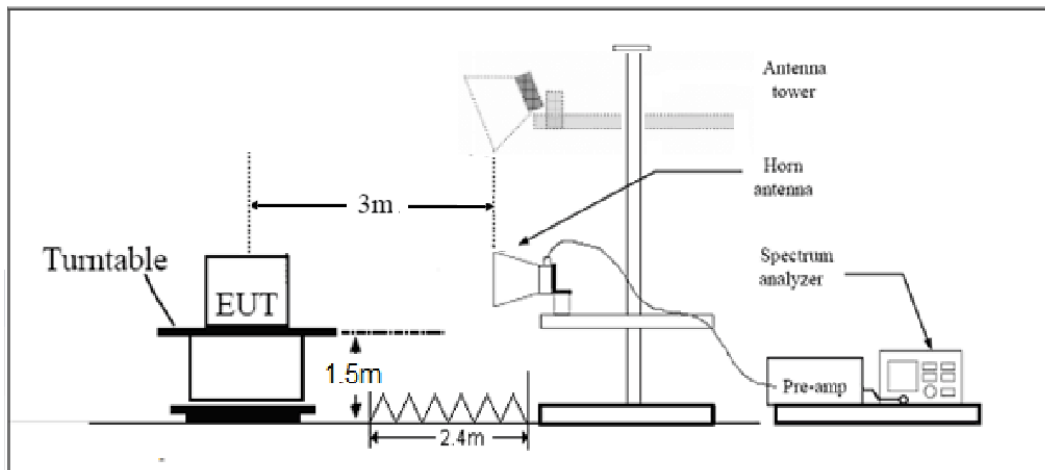

Note: Area side:2.4mX3.6m

**Limits**

Rule Part 15.247(d) specifies that “In addition, radiated emissions which fall in the restricted bands, as defined in § 15.205(a), must also comply with the radiated emission limits specified in § 15.209(a) (see § 15.205(c)).”

Limit in restricted band

Frequency of emission (MHz)	Field strength(uV/m)	Field strength(dBuV/m)
0.009–0.490	2400/F(kHz)	/
0.490–1.705	24000/F(kHz)	/
1.705–30.0	30	/
30-88	100	40
88-216	150	43.5
216-960	200	46
Above960	500	54

§15.35(b)

There is also a limit on the radio frequency emissions, as measured using instrumentation with a peak detector function, corresponding to 20 dB above the maximum permitted average limit.

Peak Limit=74 dBuV/m

Average Limit=54 dBuV/m

Spurious Radiated Emissions are permitted in any of the frequency bands listed below:

MHz	MHz	MHz	GHz
0.090 - 0.110	16.42 - 16.423	399.9 - 410	4.5 - 5.15
<sup>1</sup> 0.495 - 0.505	16.69475 - 16.69525	608 - 614	5.35 - 5.46
2.1735 - 2.1905	16.80425 - 16.80475	960 - 1240	7.25 - 7.75
4.125 - 4.128	25.5 - 25.67	1300 - 1427	8.025 - 8.5
4.17725 - 4.17775	37.5 - 38.25	1435 - 1626.5	9.0 - 9.2
4.20725 - 4.20775	73 - 74.6	1645.5 - 1646.5	9.3 - 9.5
6.215 - 6.218	74.8 - 75.2	1660 - 1710	10.6 - 12.7
6.26775 - 6.26825	108 - 121.94	1718.8 - 1722.2	13.25 - 13.4
6.31175 - 6.31225	123 - 138	2200 - 2300	14.47 - 14.5
8.291 - 8.294	149.9 - 150.05	2310 - 2390	15.35 - 16.2
8.362 - 8.366	156.52475 - 156.52525	2483.5 - 2500	17.7 - 21.4
8.37625 - 8.38675	156.7 - 156.9	2690 - 2900	22.01 - 23.12
8.41425 - 8.41475	162.0125 - 167.17	3260 - 3267	23.6 - 24.0
12.29 - 12.293	167.72 - 173.2	3332 - 3339	31.2 - 31.8
12.51975 - 12.52025	240 - 285	3345.8 - 3358	36.43 - 36.5
12.57675 - 12.57725	322 - 335.4	3600 - 4400	( <sup>2</sup> )
13.36 - 13.41			

**Measurement Uncertainty**

The assessed measurement uncertainty to ensure 95% confidence level for the normal distribution is with the coverage factor  $k = 1.96$ .

Frequency	Uncertainty
9KHz-30MHz	3.55 dB
30MHz-200MHz	4.016 dB
200MHz-1GHz	3.28 dB
1-18GHz	3.70 dB
18-26.5GHz	5.78 dB



Test Results:

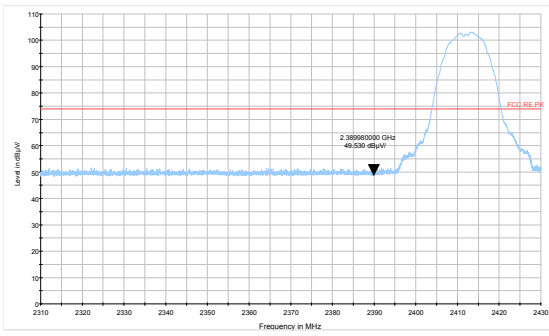

802.11b-Channel 1 Peak

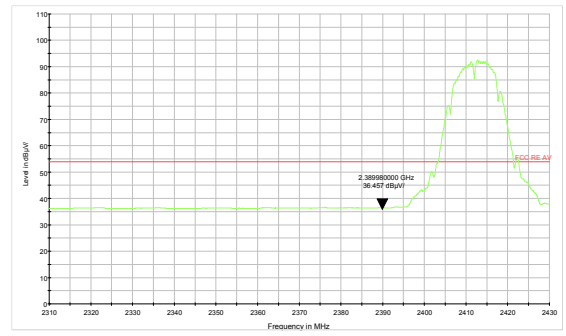

802.11b-Channel 1 Average

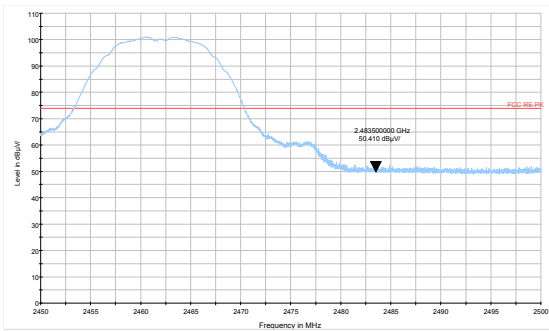

802.11b-Channel 11 Peak

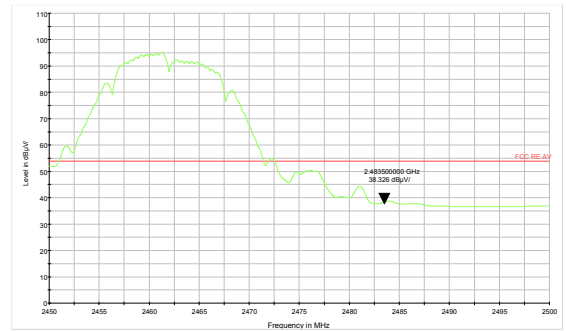

802.11b-Channel 11 Average

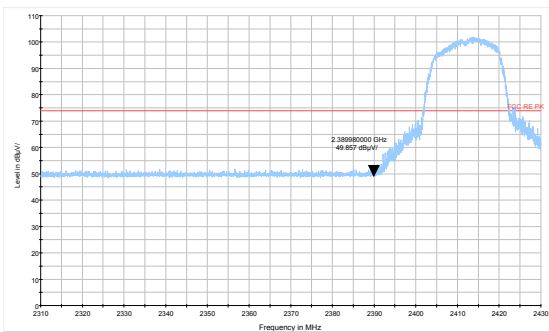

802.11g-Channel 1 Peak

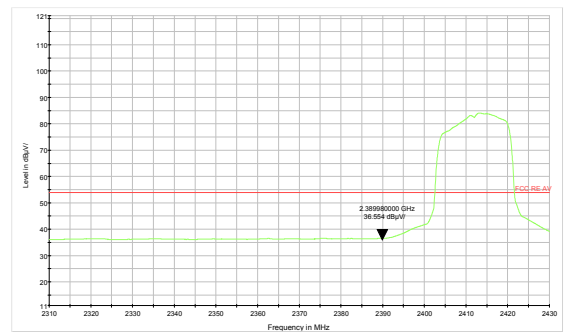

802.11g-Channel 1 Average

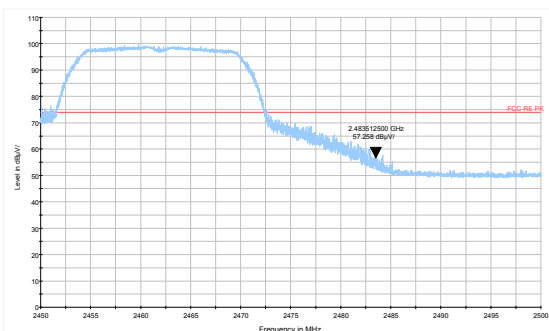

802.11g-Channel 11 Peak

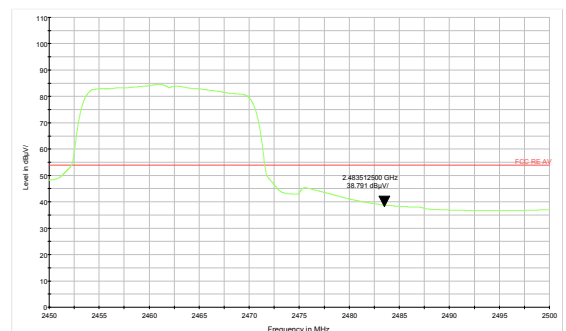

802.11g-Channel 11 Average

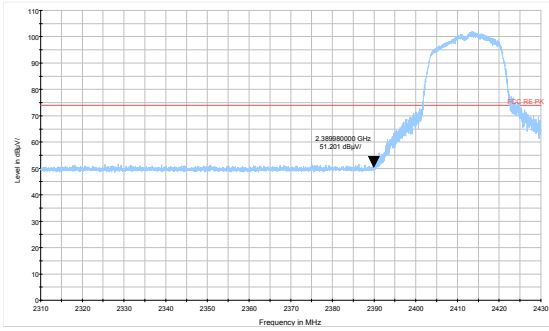

802.11n HT20 -Channel 1 Peak

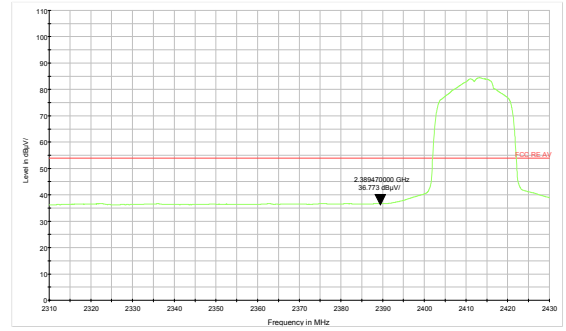

802.11n HT20 -Channel 1 Average

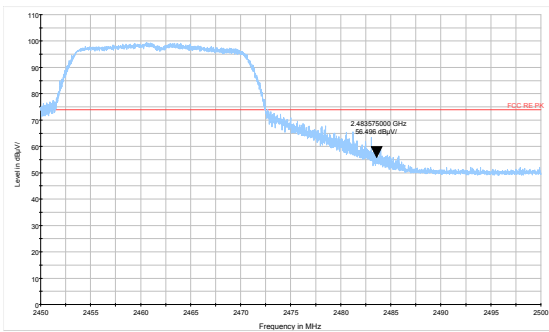

802.11n HT20 -Channel 11 Peak

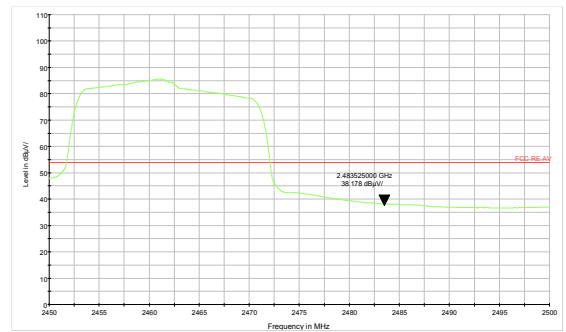

802.11n HT20 -Channel 11 Average

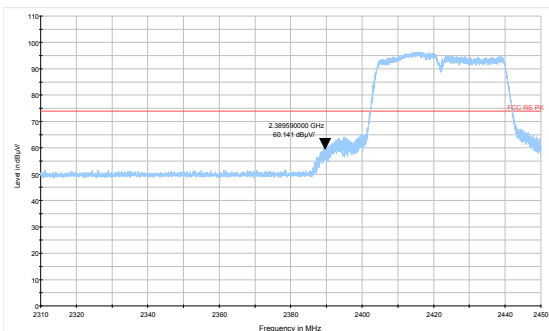

802.11n HT40 -Channel 3 Peak

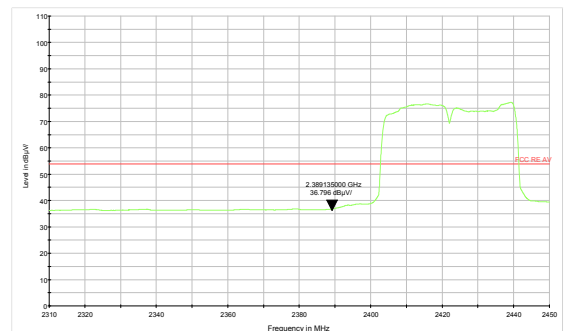

802.11n HT40 -Channel 3 Average

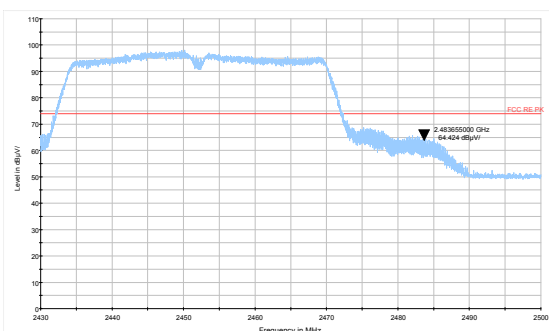

802.11n HT40 -Channel 9 Peak

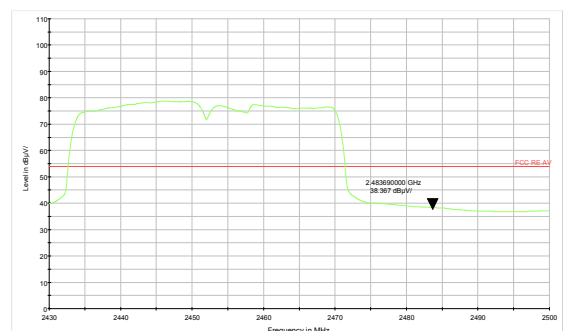

802.11n HT40 -Channel 9 Average

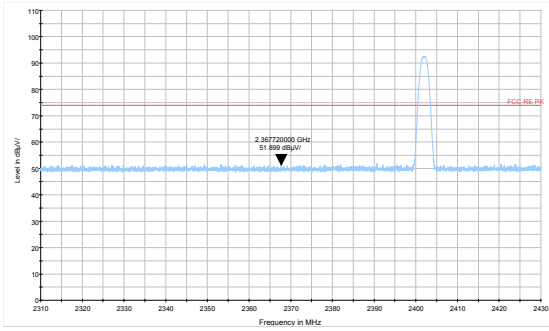

BLE Channel 0 Peak

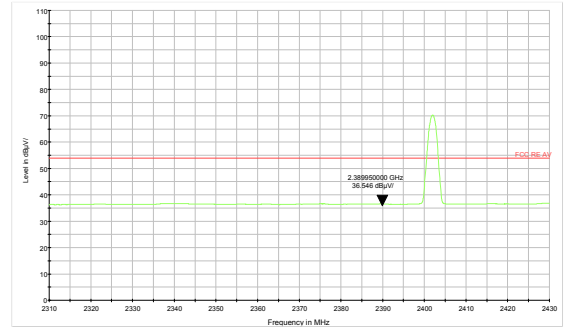

BLE Channel 0 Average

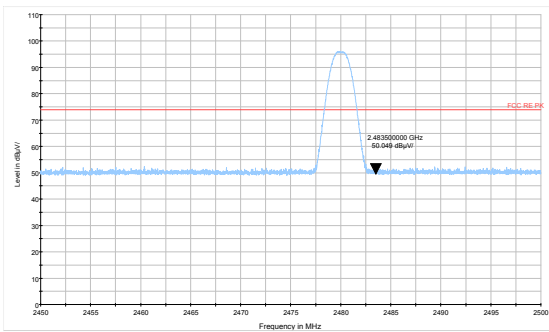

BLE Channel 39 Peak

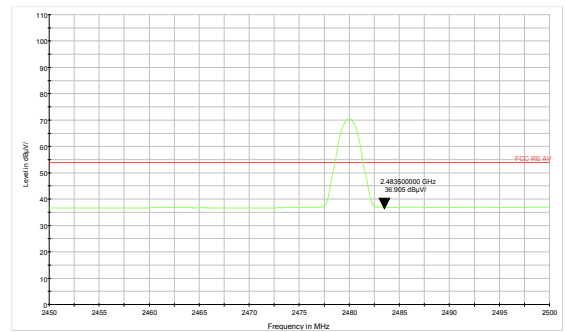

BLE Channel 39 Average

**Result of RE**

**Test result**

Sweep the whole frequency band through the range from 9kHz to the 10th harmonic of the carrier, the Emissions in the frequency band 9kHz-30MHz and 18GHz-26.5GHz are more than 20dB below the limit are not reported.

The following graphs display the maximum values of horizontal and vertical by software. For above 1GHz, Blue trace uses the peak detection, Green trace uses the average detection.

During the test, the Radiates Emission from 30MHz to 1GHz was performed in all modes with all channels, 802.11b, Channel 6 are selected as the worst condition. The test data of the worst-case condition was recorded in this report.

**Continuous TX mode:**

RE 0.03-1GHz QP Class B

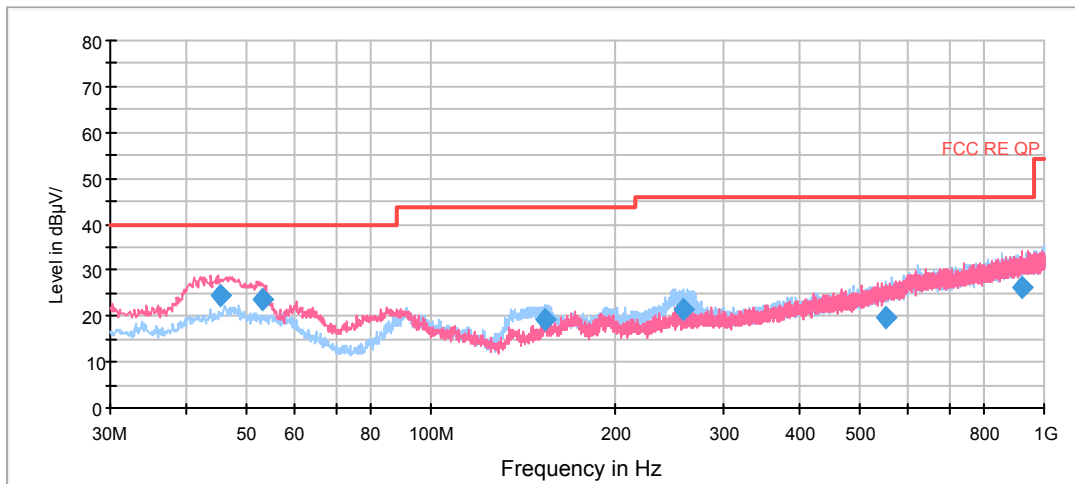

Radiates Emission from 30MHz to 1GHz

Frequency (MHz)	Quasi-Peak (dBuV/m)	Reading value (dBuV/m)	Height (cm)	Polarization	Azimuth (deg)	Correct Factor (dB)	Margin (dB)	Limit (dBuV/m)
45.313750	24.6	11.4	100.0	V	81.0	13.2	15.4	40.0
53.286250	23.7	10.9	100.0	V	252.0	12.8	16.3	40.0
153.477500	19.2	9.7	200.0	H	79.0	9.5	24.3	43.5
258.268750	21.5	6.9	100.0	H	269.0	14.6	24.5	46.0
553.438750	19.6	-2.1	200.0	H	313.0	21.7	26.4	46.0
921.992500	26.4	-0.5	200.0	V	354.0	26.9	19.6	46.0

- Remark: 1. Quasi-Peak = Reading value + Correction factor
- 2. Correction Factor = Antenna factor+ Insertion loss(cable loss+amplifier gain)
- 3. Margin = Limit – Quasi-Peak

802.11b CH1

FCC RE 1G-3GHz PK+AV Class B

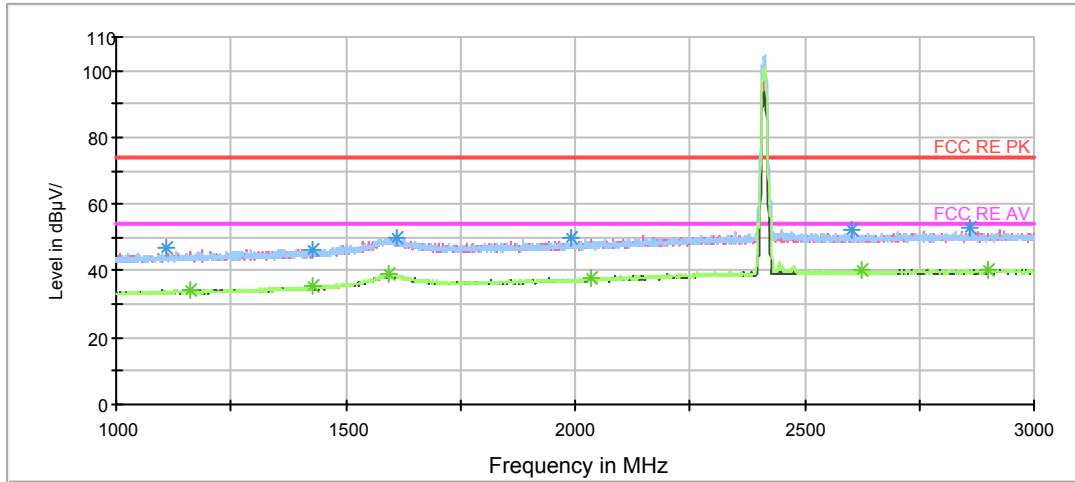

Note: The signal beyond the limit is carrier.  
Radiates Emission from 1GHz to 3GHz

RE 1G-18GHz PK+AV Class B

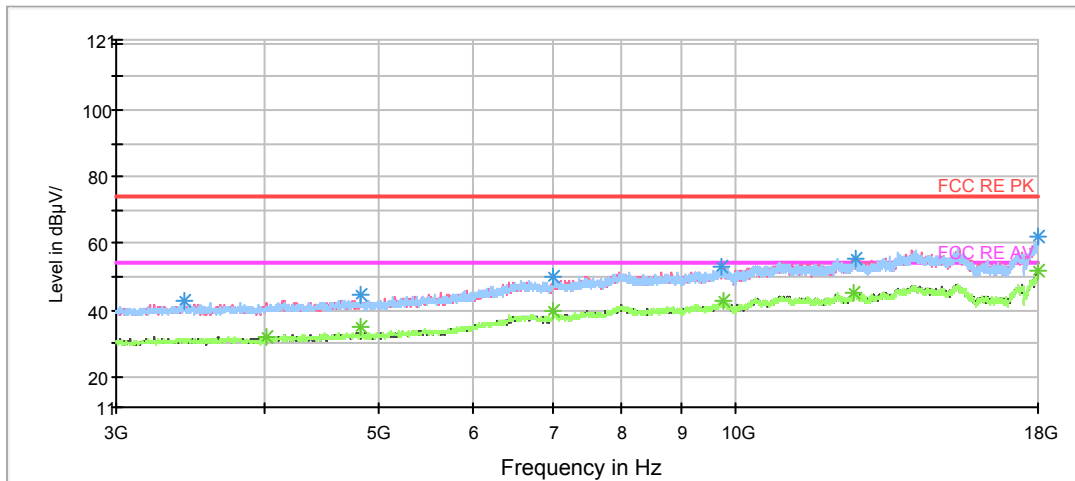

Radiates Emission from 3GHz to 18GHz

Frequency (MHz)	Peak (dBuV/m)	Height (cm)	Polarization	Azimuth (deg)	Reading value (dBuV/m)	Correct Factor (dB)	Margin (dB)	Limit (dBuV/m)
1428.000000	46.6	200.0	H	349.0	50.6	-4.0	27.4	74
1590.500000	49.5	200.0	V	18.0	49.8	-0.3	24.5	74
2232.000000	49.9	100.0	V	269.0	49.3	0.6	24.1	74
2351.000000	51.4	100.0	H	11.0	50.2	1.2	22.6	74
2701.000000	51.7	200.0	H	266.0	49.6	2.1	22.3	74
2861.500000	53.0	200.0	V	11.0	50.5	2.5	21.0	74

Remark: 1. Correction Factor = Antenna factor+ Insertion loss (cable loss + amplifier gain)





Frequency (MHz)	Average (dBuV/m)	Height (cm)	Polarization	Azimuth (deg)	Reading value (dBuV/m)	Correct Factor (dB)	Margin (dB)	Limit (dBuV/m)
1427.500000	35.6	200.0	H	349.0	39.6	-4.0	18.4	54
1596.000000	38.9	200.0	H	358.0	39.1	-0.2	15.1	54
2232.500000	38.8	100.0	H	70.0	38.2	0.6	15.2	54
2338.500000	39.6	100.0	H	265.0	38.4	1.2	14.4	54
2711.500000	40.2	100.0	H	70.0	38.0	2.2	13.8	54
2899.500000	40.4	100.0	H	1.0	37.9	2.5	13.6	54

**Remark: 1. Correction Factor = Antenna factor+ Insertion loss (cable loss + amplifier gain)**

802.11b CH6

FCC RE 1G-3GHz PK+AV Class B

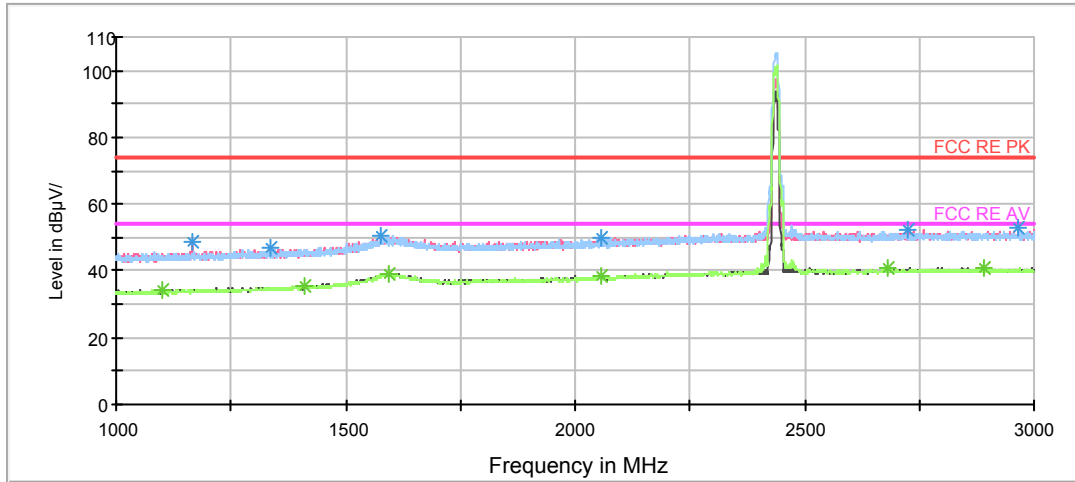

Note: The signal beyond the limit is carrier.  
Radiates Emission from 1GHz to 3GHz

RE 1G-18GHz PK+AV Class B

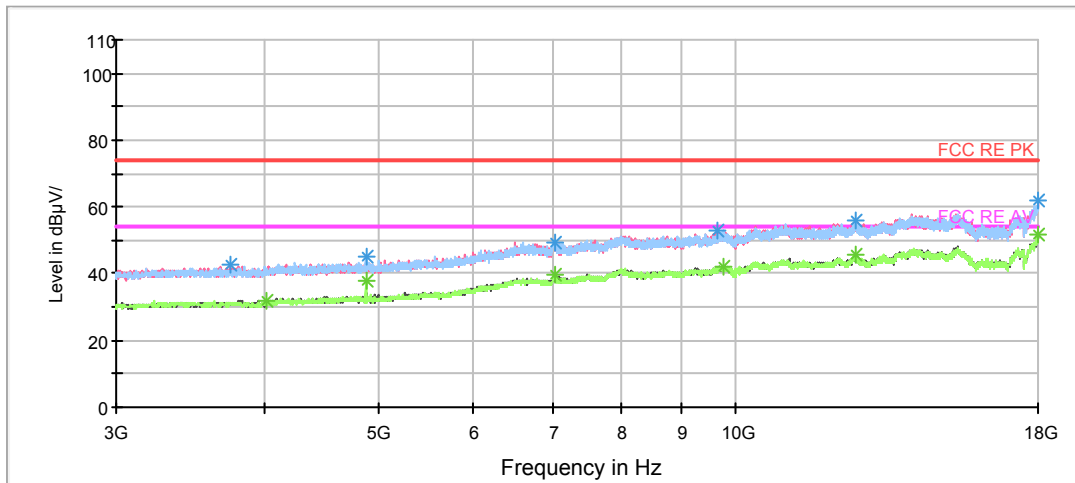

Radiates Emission from 3GHz to 18GHz

Frequency (MHz)	Peak (dBuV/m)	Height (cm)	Polarization	Azimuth (deg)	Reading value (dBuV/m)	Correct Factor (dB)	Margin (dB)	Limit (dBuV/m)
1337.500000	46.8	200.0	V	58.0	51.6	-4.8	27.2	74
1577.500000	50.8	100.0	V	132.0	51.3	-0.5	23.2	74
2230.500000	50.2	200.0	V	193.0	49.6	0.6	23.8	74
2334.500000	51.1	200.0	H	339.0	50.0	1.1	22.9	74
2726.000000	52.3	200.0	V	48.0	50.1	2.2	21.7	74
2874.000000	51.4	200.0	H	339.0	48.9	2.5	22.6	74

Remark: 1. Correction Factor = Antenna factor+ Insertion loss (cable loss + amplifier gain)



Frequency (MHz)	Average (dBuV/m)	Height (cm)	Polarization	Azimuth (deg)	Reading value (dBuV/m)	Correct Factor (dB)	Margin (dB)	Limit (dBuV/m)
1410.500000	35.6	100.0	V	209.0	39.8	-4.2	18.4	54
1594.500000	39.1	100.0	H	57.0	39.3	-0.2	14.9	54
2243.000000	39.2	100.0	V	209.0	38.6	0.6	14.8	54
2336.500000	39.6	200.0	H	37.0	38.5	1.1	14.4	54
2730.500000	40.7	200.0	V	0.0	38.5	2.2	13.3	54
2893.000000	40.9	100.0	V	267.0	38.4	2.5	13.1	54

Remark: 1. Correction Factor = Antenna factor+ Insertion loss (cable loss + amplifier gain)

802.11b CH11

FCC RE 1G-3GHz PK+AV Class B

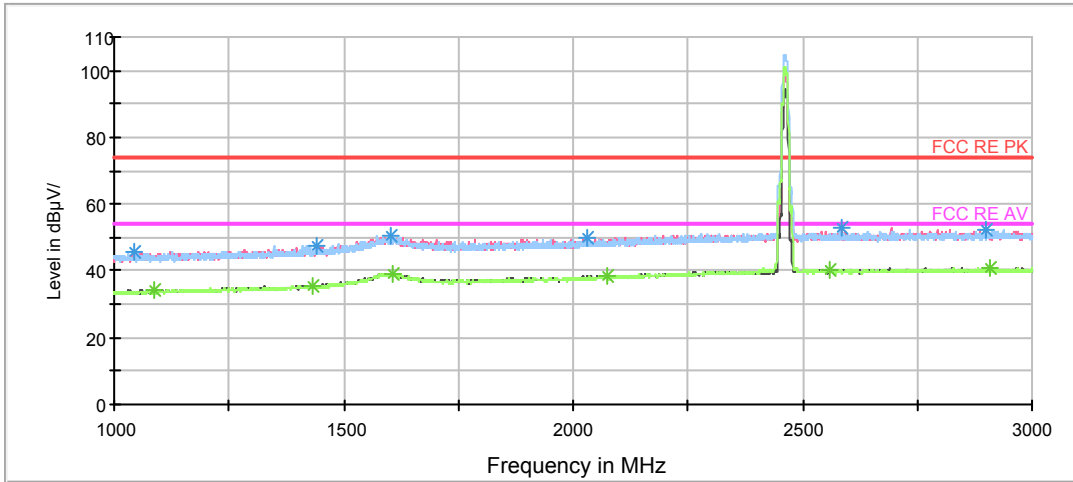

Note: The signal beyond the limit is carrier.  
Radiates Emission from 1GHz to 3GHz

RE 1G-18GHz PK+AV Class B

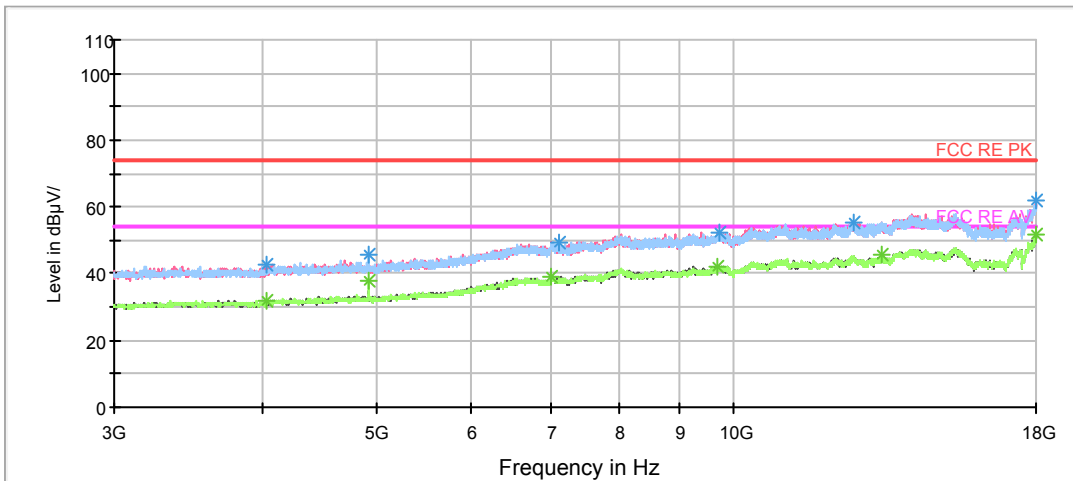

Radiates Emission from 3GHz to 18GHz

Frequency (MHz)	Peak (dBuV/m)	Height (cm)	Polarization	Azimuth (deg)	Reading value (dBuV/m)	Correct Factor (dB)	Margin (dB)	Limit (dBuV/m)
1440.000000	47.4	200.0	V	43.0	51.4	-4.0	26.6	74
1603.000000	50.5	100.0	V	190.0	50.6	-0.1	23.5	74
2244.500000	50.6	200.0	H	269.0	50.0	0.6	23.4	74
2346.500000	50.4	100.0	V	342.0	49.2	1.2	23.6	74
2733.500000	52.1	200.0	H	54.0	49.9	2.2	21.9	74
2834.500000	51.8	200.0	H	269.0	49.3	2.5	22.2	74

Remark: 1. Correction Factor = Antenna factor+ Insertion loss (cable loss + amplifier gain)



Frequency (MHz)	Average (dBuV/m)	Height (cm)	Polarization	Azimuth (deg)	Reading value (dBuV/m)	Correct Factor (dB)	Margin (dB)	Limit (dBuV/m)
1444.000000	35.5	100.0	V	276.0	39.4	-3.9	18.5	54
1605.500000	39.2	200.0	V	20.0	39.3	-0.1	14.8	54
2253.500000	39.4	200.0	H	165.0	38.7	0.7	14.6	54
2364.000000	39.5	100.0	V	30.0	38.2	1.3	14.5	54
2728.000000	40.5	100.0	V	58.0	38.3	2.2	13.5	54
2847.000000	40.7	100.0	V	132.0	38.2	2.5	13.3	54

**Remark: 1. Correction Factor = Antenna factor+ Insertion loss (cable loss + amplifier gain)**



802.11g CH1

FCC RE 1G-3GHz PK+AV Class B

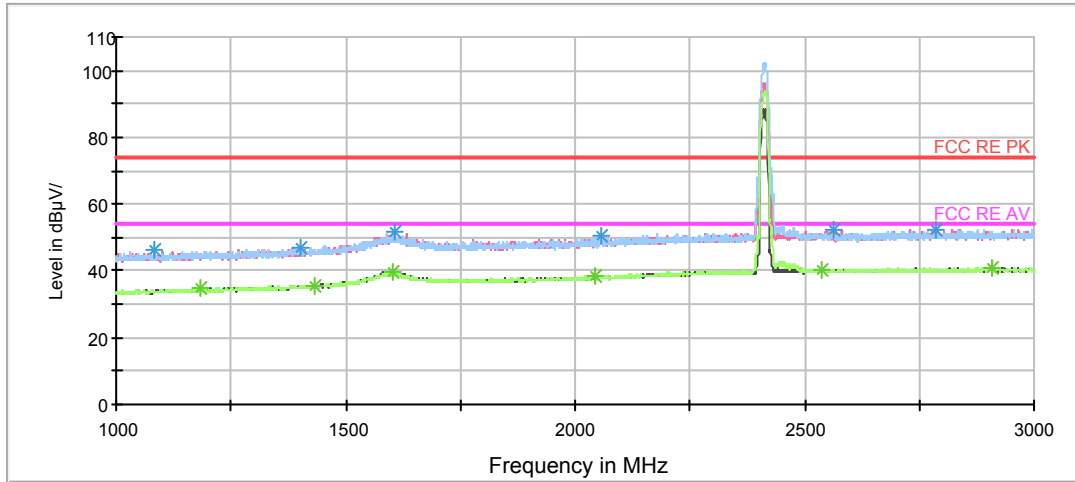

Note: The signal beyond the limit is carrier.  
Radiates Emission from 1GHz to 3GHz

RE 1G-18GHz PK+AV Class B

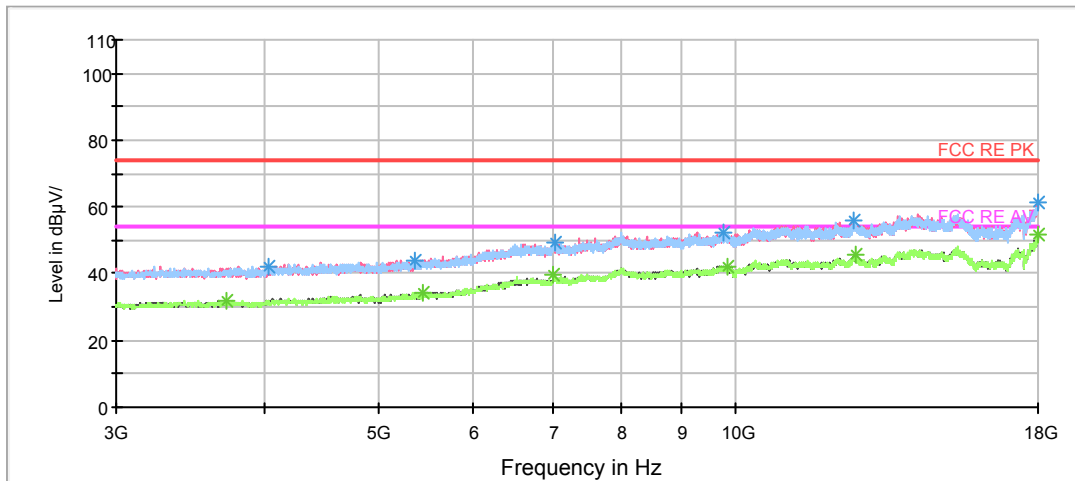

Radiates Emission from 3GHz to 18GHz

Frequency (MHz)	Peak (dBuV/m)	Height (cm)	Polarization	Azimuth (deg)	Reading value (dBuV/m)	Correct Factor (dB)	Margin (dB)	Limit (dBuV/m)
1403.500000	47.0	100.0	H	59.0	51.3	-4.3	27.0	74
1606.000000	51.4	100.0	V	183.0	51.5	-0.1	22.6	74
2221.500000	50.8	100.0	H	3.0	50.3	0.5	23.2	74
2362.500000	51.1	100.0	V	347.0	49.8	1.3	22.9	74
2730.000000	52.2	100.0	V	288.0	50.0	2.2	21.8	74
2876.000000	52.3	200.0	H	124.0	49.8	2.5	21.7	74

Remark: 1. Correction Factor = Antenna factor+ Insertion loss (cable loss + amplifier gain)



Frequency (MHz)	Average (dBuV/m)	Height (cm)	Polarization	Azimuth (deg)	Reading value (dBuV/m)	Correct Factor (dB)	Margin (dB)	Limit (dBuV/m)
1403.000000	35.4	200.0	H	249.0	39.7	-4.3	18.6	54
1603.500000	39.6	100.0	H	92.0	39.7	-0.1	14.4	54
2235.000000	39.6	200.0	V	312.0	39.0	0.6	14.4	54
2367.000000	40.0	100.0	H	18.0	38.7	1.3	14.0	54
2742.000000	40.8	200.0	V	68.0	38.5	2.3	13.2	54
2886.500000	40.7	100.0	V	135.0	38.2	2.5	13.3	54

**Remark: 1. Correction Factor = Antenna factor+ Insertion loss (cable loss + amplifier gain)**



802.11g CH6

FCC RE 1G-3GHz PK+AV Class B

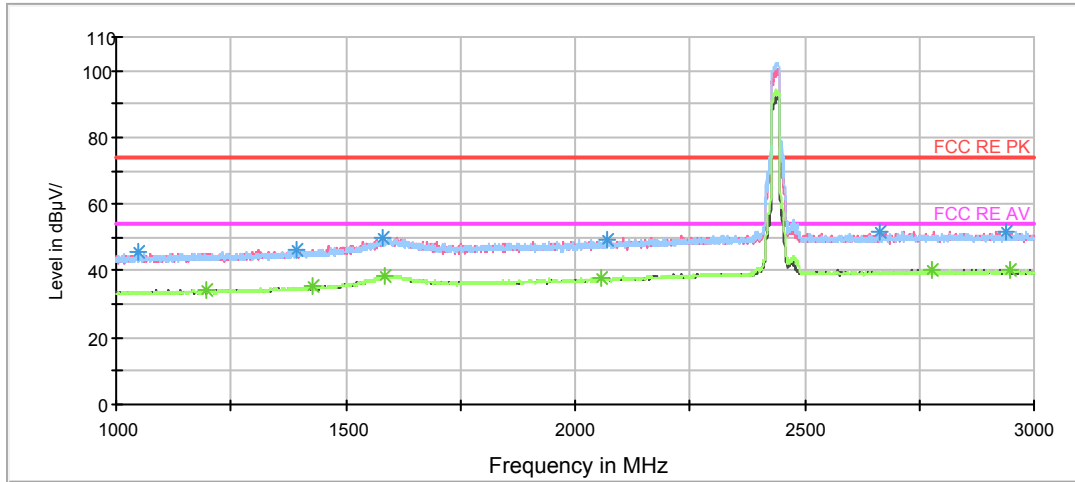

Note: The signal beyond the limit is carrier.  
Radiates Emission from 1GHz to 3GHz

RE 1G-18GHz PK+AV Class B

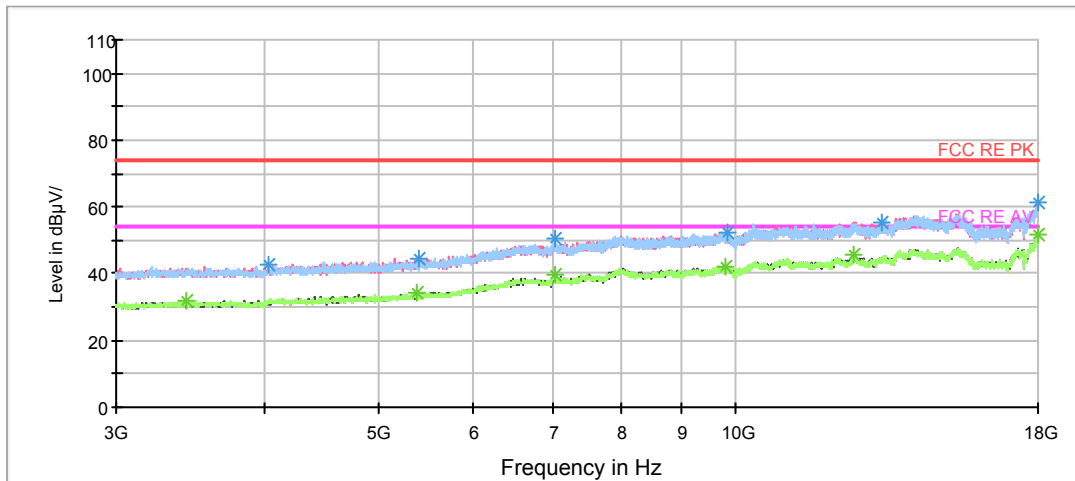

Radiates Emission from 3GHz to 18GHz

Frequency (MHz)	Peak (dBuV/m)	Height (cm)	Polarization	Azimuth (deg)	Reading value (dBuV/m)	Correct Factor (dB)	Margin (dB)	Limit (dBuV/m)
1393.500000	46.5	100.0	V	299.0	50.9	-4.4	27.5	74
1582.000000	49.8	100.0	V	308.0	50.2	-0.4	24.2	74
2232.000000	50.3	200.0	V	172.0	49.7	0.6	23.7	74
2349.500000	50.4	100.0	H	7.0	49.2	1.2	23.6	74
2765.000000	51.1	200.0	V	114.0	48.8	2.3	22.9	74
2858.000000	51.0	100.0	H	2.0	48.5	2.5	23.0	74

Remark: 1. Correction Factor = Antenna factor+ Insertion loss (cable loss + amplifier gain)





Frequency (MHz)	Average (dBuV/m)	Height (cm)	Polarization	Azimuth (deg)	Reading value (dBuV/m)	Correct Factor (dB)	Margin (dB)	Limit (dBuV/m)
1377.000000	34.9	100.0	V	164.0	39.4	-4.5	19.1	54
1585.500000	38.7	100.0	H	74.0	39.1	-0.4	15.3	54
2236.500000	38.7	100.0	H	274.0	38.1	0.6	15.3	54
2362.500000	39.2	100.0	V	65.0	37.9	1.3	14.8	54
2777.500000	40.3	100.0	V	359.0	37.9	2.4	13.7	54
2863.000000	40.1	100.0	V	135.0	37.6	2.5	13.9	54

**Remark: 1. Correction Factor = Antenna factor+ Insertion loss (cable loss + amplifier gain)**



802.11g CH11

FCC RE 1G-3GHz PK+AV Class B

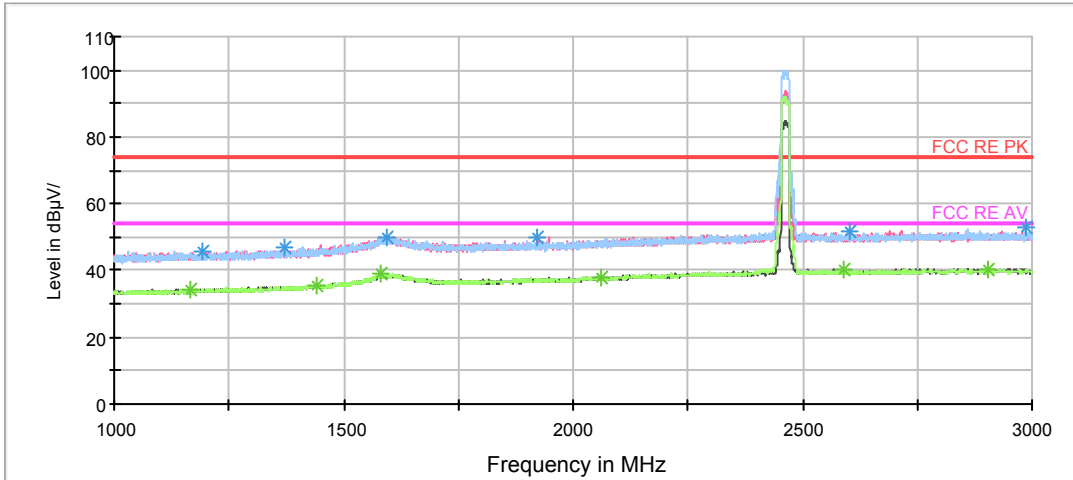

Note: The signal beyond the limit is carrier.  
Radiates Emission from 1GHz to 3GHz

RE 1G-18GHz PK+AV Class B

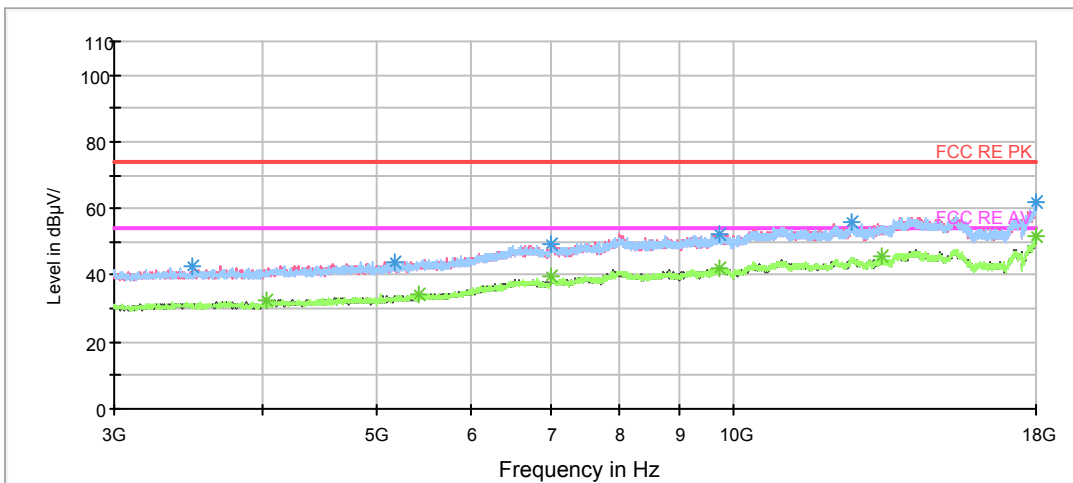

Radiates Emission from 3GHz to 18GHz

Frequency (MHz)	Peak (dBuV/m)	Height (cm)	Polarization	Azimuth (deg)	Reading value (dBuV/m)	Correct Factor (dB)	Margin (dB)	Limit (dBuV/m)
1369.000000	46.7	200.0	H	357.0	51.3	-4.6	27.3	74
1593.000000	49.9	100.0	H	14.0	50.2	-0.3	24.1	74
2234.000000	50.2	200.0	H	320.0	49.6	0.6	23.8	74
2375.500000	50.6	200.0	V	0.0	49.3	1.3	23.4	74
2717.000000	51.5	200.0	V	357.0	49.3	2.2	22.5	74
2860.500000	52.0	100.0	H	243.0	49.5	2.5	22.0	74



Remark: 1. Correction Factor = Antenna factor+ Insertion loss (cable loss + amplifier gain)

Frequency (MHz)	Average (dBuV/m)	Height (cm)	Polarization	Azimuth (deg)	Reading value (dBuV/m)	Correct Factor (dB)	Margin (dB)	Limit (dBuV/m)
1351.500000	34.9	200.0	V	305.0	39.6	-4.7	19.1	54
1580.000000	38.9	100.0	H	2.0	39.4	-0.5	15.1	54
2239.500000	38.9	100.0	H	31.0	38.3	0.6	15.1	54
2378.000000	39.7	200.0	V	196.0	38.4	1.3	14.3	54
2722.000000	40.0	200.0	V	158.0	37.8	2.2	14.0	54
2862.000000	40.2	100.0	V	163.0	37.7	2.5	13.8	54

Remark: 1. Correction Factor = Antenna factor+ Insertion loss (cable loss + amplifier gain)

802.11n (HT20) CH1

FCC RE 1G-3GHz PK+AV Class B

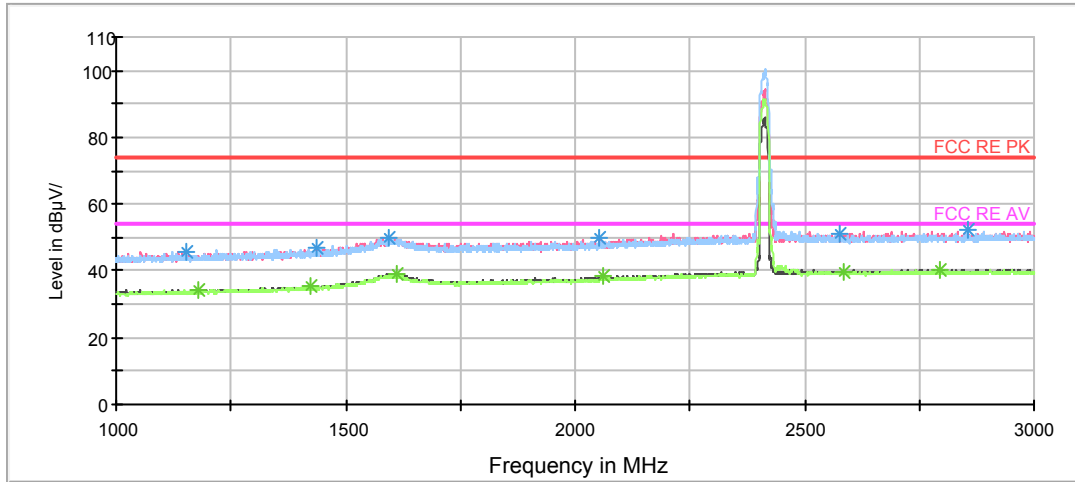

Note: The signal beyond the limit is carrier.  
Radiates Emission from 1GHz to 3GHz

RE 1G-18GHz PK+AV Class B

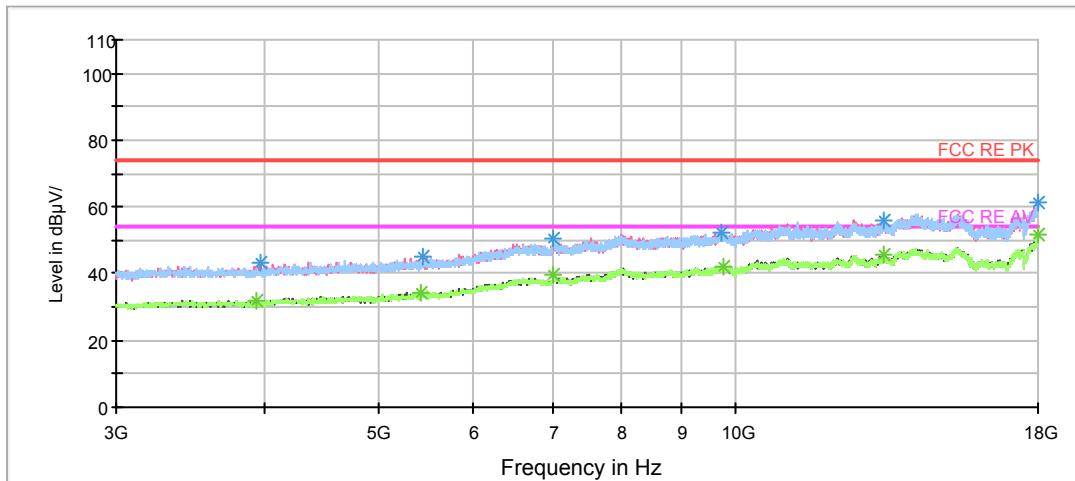

Radiates Emission from 3GHz to 18GHz

Frequency (MHz)	Peak (dBuV/m)	Height (cm)	Polarization	Azimuth (deg)	Reading value (dBuV/m)	Correct Factor (dB)	Margin (dB)	Limit (dBuV/m)
1349.500000	46.4	100.0	H	142.0	51.1	-4.7	27.6	74
1595.000000	50.0	200.0	V	192.0	50.2	-0.2	24.0	74
2213.500000	50.9	200.0	V	211.0	50.4	0.5	23.1	74
2372.500000	50.7	200.0	V	172.0	49.4	1.3	23.3	74
2739.500000	51.4	100.0	V	353.0	49.1	2.3	22.6	74
2857.000000	52.1	200.0	H	0.0	49.6	2.5	21.9	74

Remark: 1. Correction Factor = Antenna factor+ Insertion loss (cable loss + amplifier gain)



Frequency (MHz)	Average (dBuV/m)	Height (cm)	Polarization	Azimuth (deg)	Reading value (dBuV/m)	Correct Factor (dB)	Margin (dB)	Limit (dBuV/m)
1355.500000	35.0	200.0	V	71.0	39.7	-4.7	19.0	54
1610.500000	39.0	100.0	V	348.0	39.2	-0.2	15.0	54
2219.500000	39.0	100.0	V	348.0	38.5	0.5	15.0	54
2356.500000	39.8	100.0	V	237.0	38.6	1.2	14.2	54
2585.500000	39.7	100.0	V	246.0	37.8	1.9	14.3	54
2744.500000	40.0	100.0	H	4.0	37.7	2.3	14.0	54

**Remark: 1. Correction Factor = Antenna factor+ Insertion loss (cable loss + amplifier gain)**



802.11n (HT20) CH6

FCC RE 1G-3GHz PK+AV Class B

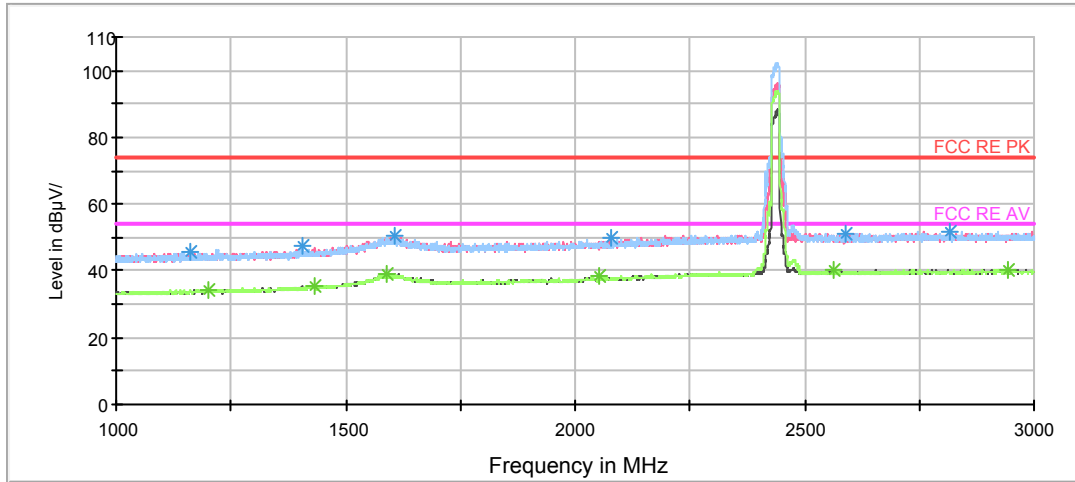

Note: The signal beyond the limit is carrier.  
Radiates Emission from 1GHz to 3GHz

RE 1G-18GHz PK+AV Class B

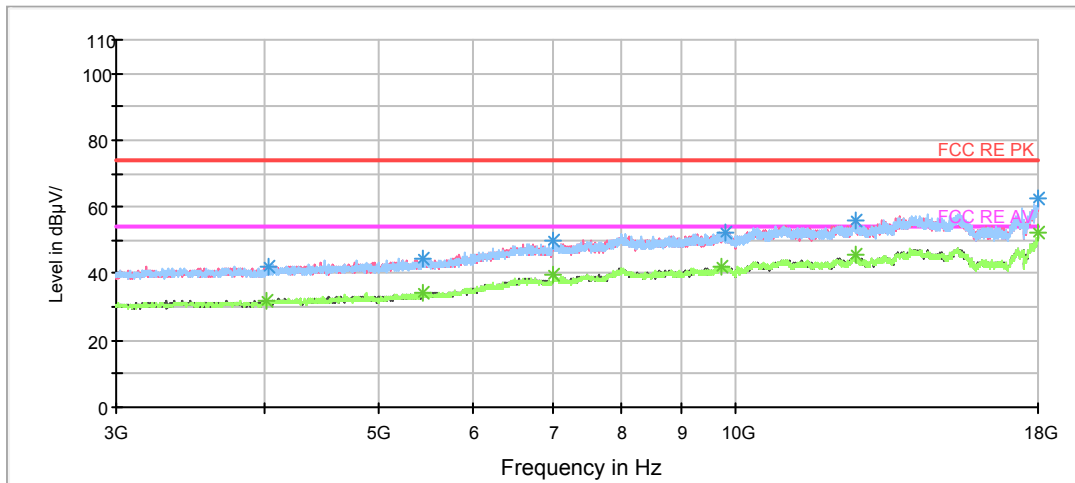

Radiates Emission from 3GHz to 18GHz

Frequency (MHz)	Peak (dBuV/m)	Height (cm)	Polarization	Azimuth (deg)	Reading value (dBuV/m)	Correct Factor (dB)	Margin (dB)	Limit (dBuV/m)
1406.500000	47.5	100.0	H	6.0	51.8	-4.3	26.5	74
1607.500000	50.6	200.0	H	252.0	50.7	-0.1	23.4	74
2816.000000	51.8	100.0	V	358.0	49.4	2.4	22.2	74
2235.500000	50.3	200.0	V	41.0	49.7	0.6	23.7	74
2359.000000	50.6	200.0	V	22.0	49.4	1.2	23.4	74
2735.000000	50.9	200.0	V	0.0	48.7	2.2	23.1	74

Remark: 1. Correction Factor = Antenna factor+ Insertion loss (cable loss + amplifier gain)



Frequency (MHz)	Average (dBuV/m)	Height (cm)	Polarization	Azimuth (deg)	Reading value (dBuV/m)	Correct Factor (dB)	Margin (dB)	Limit (dBuV/m)
1430.500000	35.4	100.0	V	0.0	39.4	-4.0	18.6	54
1591.000000	39.1	200.0	V	233.0	39.4	-0.3	14.9	54
2243.500000	39.2	200.0	V	147.0	38.6	0.6	14.8	54
2346.500000	39.4	200.0	V	79.0	38.2	1.2	14.6	54
2733.000000	40.2	100.0	H	71.0	38.0	2.2	13.8	54
2827.500000	40.0	100.0	V	286.0	37.5	2.5	14.0	54

**Remark: 1. Correction Factor = Antenna factor+ Insertion loss (cable loss + amplifier gain)**

802.11n (HT20) CH11

FCC RE 1G-3GHz PK+AV Class B

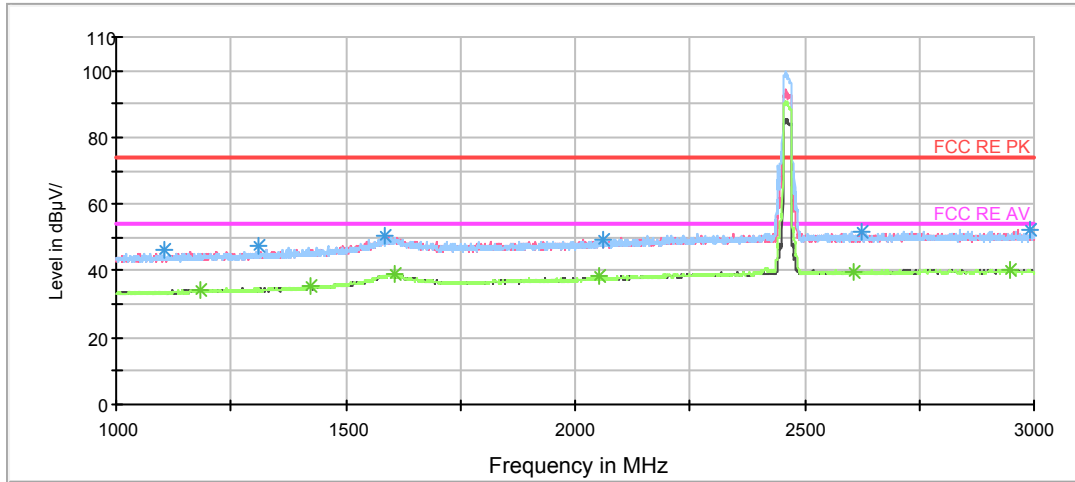

Note: The signal beyond the limit is carrier.  
Radiates Emission from 1GHz to 3GHz

RE 1G-18GHz PK+AV Class B

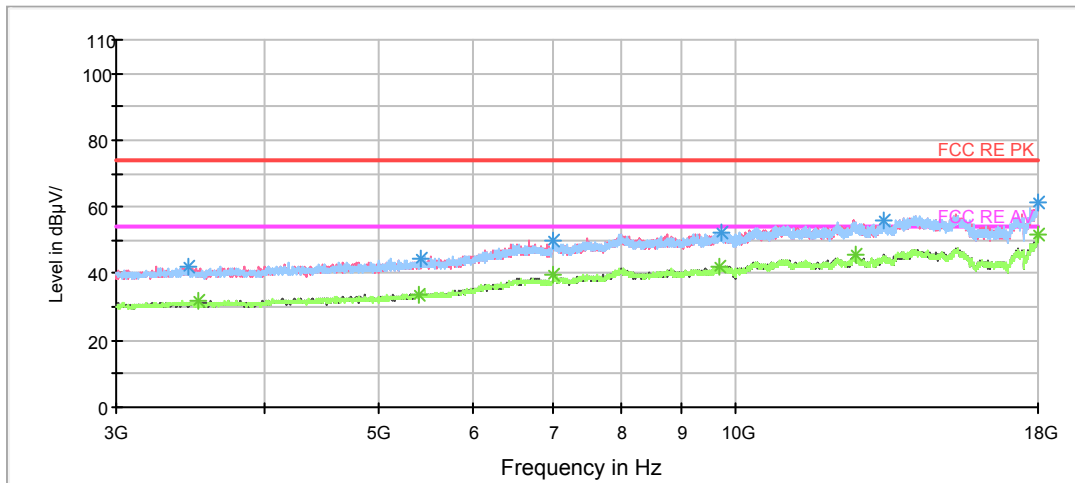

Radiates Emission from 3GHz to 18GHz

Frequency (MHz)	Peak (dBuV/m)	Height (cm)	Polarization	Azimuth (deg)	Reading value (dBuV/m)	Correct Factor (dB)	Margin (dB)	Limit (dBuV/m)
1375.500000	46.9	100.0	H	0.0	51.4	-4.5	27.1	74
1584.500000	50.3	200.0	V	87.0	50.7	-0.4	23.7	74
2266.000000	51.1	100.0	H	2.0	50.3	0.8	22.9	74
2344.000000	51.1	200.0	V	4.0	49.9	1.2	22.9	74
2716.500000	51.8	200.0	H	254.0	49.6	2.2	22.2	74
2854.500000	51.6	200.0	H	355.0	49.1	2.5	22.4	74

Remark: 1. Correction Factor = Antenna factor+ Insertion loss (cable loss + amplifier gain)





Frequency (MHz)	Average (dBuV/m)	Height (cm)	Polarization	Azimuth (deg)	Reading value (dBuV/m)	Correct Factor (dB)	Margin (dB)	Limit (dBuV/m)
1378.500000	34.9	100.0	V	0.0	39.4	-4.5	19.1	54
1597.000000	39.0	100.0	H	11.0	39.2	-0.2	15.0	54
2244.500000	39.0	200.0	V	202.0	38.4	0.6	15.0	54
2341.000000	39.3	200.0	V	183.0	38.1	1.2	14.7	54
2720.500000	40.3	200.0	V	302.0	38.1	2.2	13.7	54
2844.500000	40.3	200.0	V	57.0	37.8	2.5	13.7	54

**Remark: 1. Correction Factor = Antenna factor+ Insertion loss (cable loss + amplifier gain)**

802.11n (HT40) CH3

FCC RE 1G-3GHz PK+AV Class B

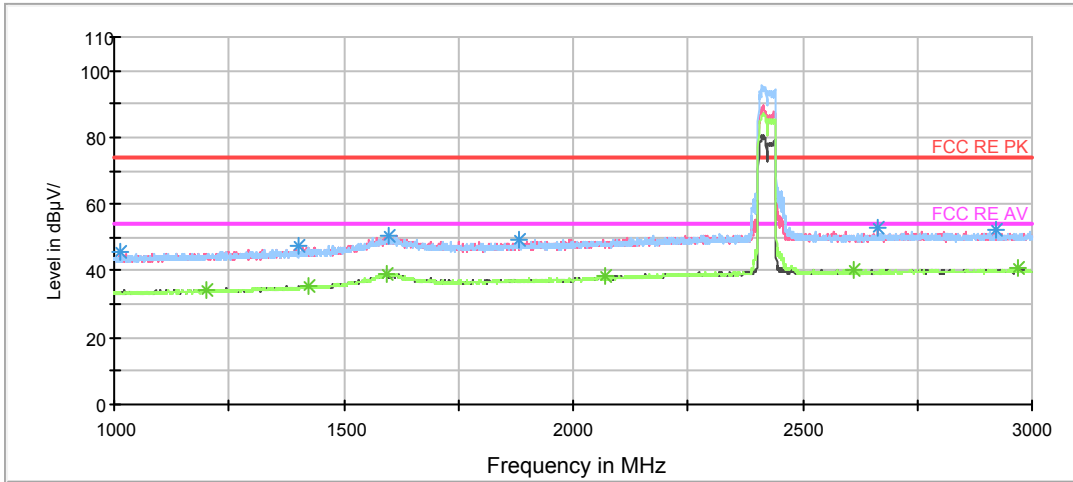

Note: The signal beyond the limit is carrier.  
Radiates Emission from 1GHz to 3GHz

RE 1G-18GHz PK+AV Class B

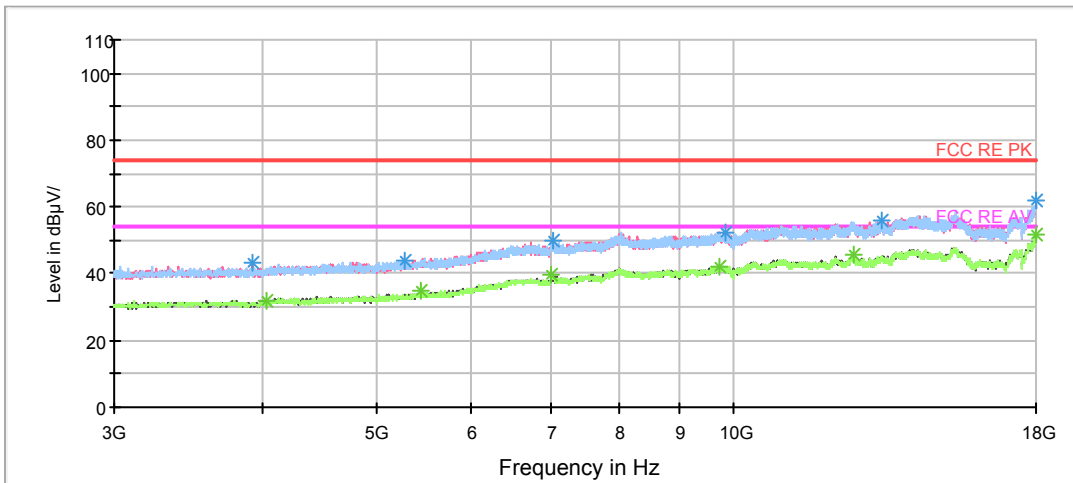

Radiates Emission from 3GHz to 18GHz

Frequency (MHz)	Peak (dBuV/m)	Height (cm)	Polarization	Azimuth (deg)	Reading value (dBuV/m)	Correct Factor (dB)	Margin (dB)	Limit (dBuV/m)
1401.500000	47.2	200.0	H	30.0	51.5	-4.3	26.8	74
1599.500000	50.4	100.0	H	8.0	50.6	-0.2	23.6	74
2242.500000	50.6	100.0	V	0.0	50.0	0.6	23.4	74
2353.500000	50.4	100.0	H	129.0	49.2	1.2	23.6	74
2724.500000	51.5	100.0	V	184.0	49.3	2.2	22.5	74
2856.000000	51.9	100.0	V	135.0	49.4	2.5	22.1	74

Remark: 1. Correction Factor = Antenna factor+ Insertion loss (cable loss + amplifier gain)



Frequency (MHz)	Average (dBuV/m)	Height (cm)	Polarization	Azimuth (deg)	Reading value (dBuV/m)	Correct Factor (dB)	Margin (dB)	Limit (dBuV/m)
1393.500000	35.1	200.0	H	231.0	39.5	-4.4	18.9	54
1594.000000	39.3	200.0	V	1.0	39.5	-0.2	14.7	54
2231.000000	39.1	100.0	H	32.0	38.5	0.6	14.9	54
2362.000000	39.7	200.0	H	145.0	38.4	1.3	14.3	54
2728.000000	39.9	200.0	H	241.0	37.7	2.2	14.1	54
2861.000000	40.3	100.0	H	32.0	37.8	2.5	13.7	54

**Remark: 1. Correction Factor = Antenna factor+ Insertion loss (cable loss + amplifier gain)**

802.11n (HT40) CH6

FCC RE 1G-3GHz PK+AV Class B

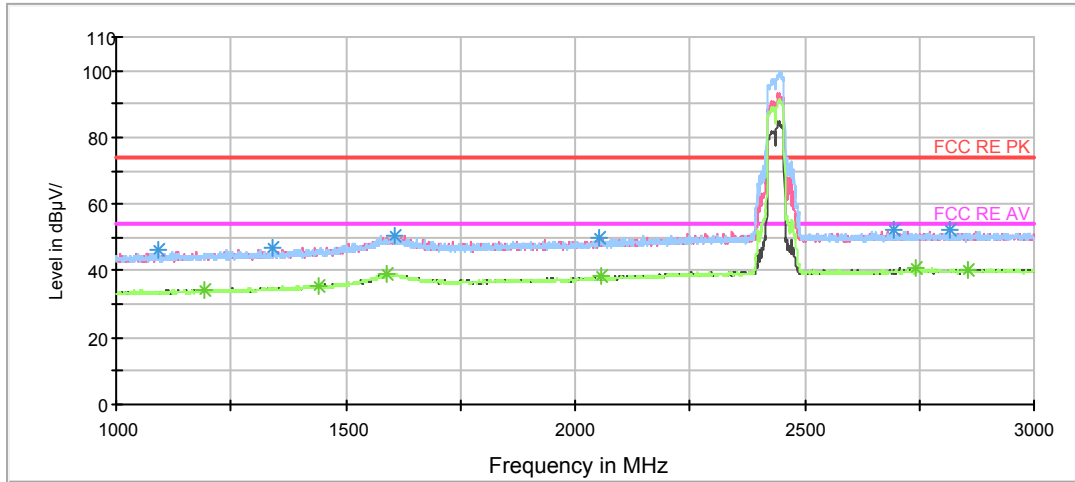

Note: The signal beyond the limit is carrier.  
Radiates Emission from 1GHz to 3GHz

RE 1G-18GHz PK+AV Class B

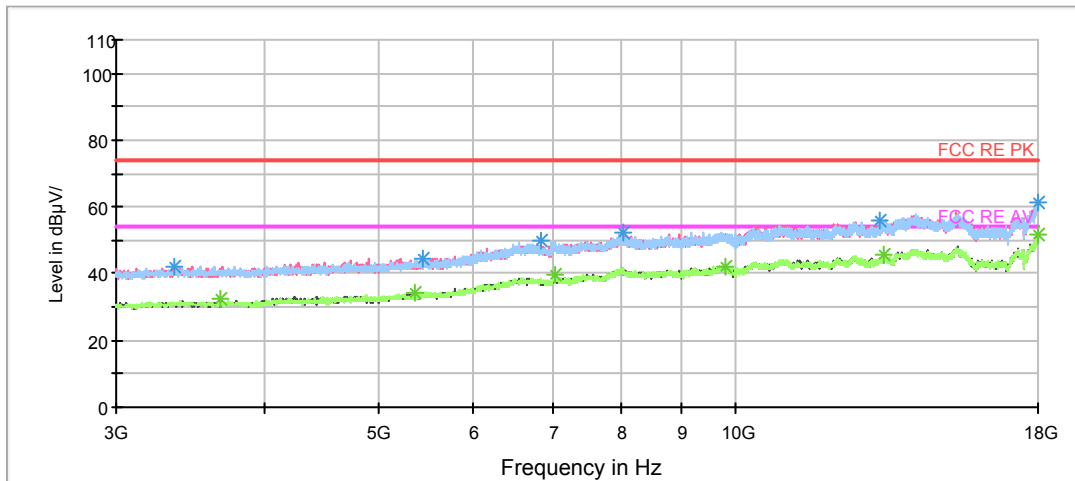

Radiates Emission from 3GHz to 18GHz

Frequency (MHz)	Peak (dBuV/m)	Height (cm)	Polarization	Azimuth (deg)	Reading value (dBuV/m)	Correct Factor (dB)	Margin (dB)	Limit (dBuV/m)
1340.500000	46.7	200.0	H	351.0	51.5	-4.8	27.3	74
1607.500000	50.8	100.0	H	116.0	50.9	-0.1	23.2	74
2246.500000	51.3	200.0	V	148.0	50.7	0.6	22.7	74
2342.500000	51.6	100.0	V	236.0	50.4	1.2	22.4	74
2723.500000	51.5	100.0	V	0.0	49.3	2.2	22.5	74
2816.500000	52.1	100.0	V	197.0	49.7	2.4	21.9	74

Remark: 1. Correction Factor = Antenna factor+ Insertion loss (cable loss + amplifier gain)



Frequency (MHz)	Average (dBuV/m)	Height (cm)	Polarization	Azimuth (deg)	Reading value (dBuV/m)	Correct Factor (dB)	Margin (dB)	Limit (dBuV/m)
1338.500000	34.8	200.0	V	187.0	39.6	-4.8	19.2	54
1590.000000	39.1	200.0	H	0.0	39.4	-0.3	14.9	54
2253.000000	39.4	100.0	V	79.0	38.7	0.7	14.6	54
2342.500000	39.4	200.0	H	232.0	38.2	1.2	14.6	54
2741.000000	40.6	200.0	H	318.0	38.3	2.3	13.4	54
2857.500000	40.3	200.0	V	60.0	37.8	2.5	13.7	54

**Remark: 1. Correction Factor = Antenna factor+ Insertion loss (cable loss + amplifier gain)**

802.11n (HT40) CH9

FCC RE 1G-3GHz PK+AV Class B

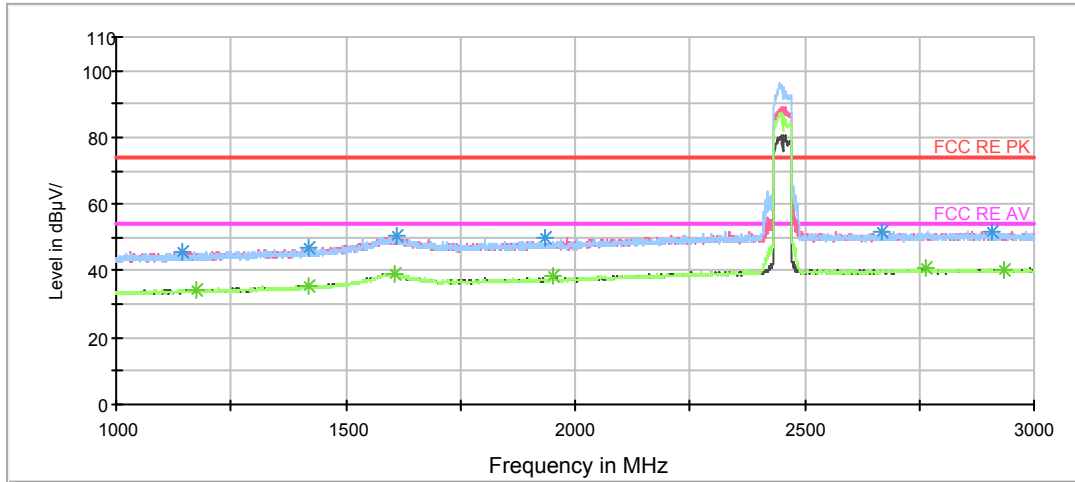

Note: The signal beyond the limit is carrier.  
Radiates Emission from 1GHz to 3GHz

RE 1G-18GHz PK+AV Class B

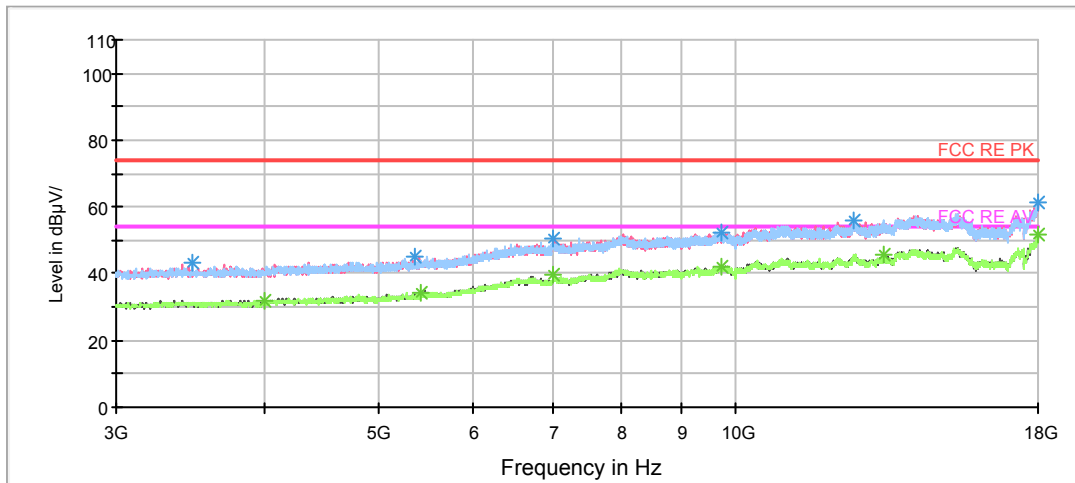

Radiates Emission from 3GHz to 18GHz

Frequency (MHz)	Peak (dBuV/m)	Height (cm)	Polarization	Azimuth (deg)	Reading value (dBuV/m)	Correct Factor (dB)	Margin (dB)	Limit (dBuV/m)
1420.500000	46.7	100.0	V	135.0	50.8	-4.1	27.3	74
1613.000000	50.4	100.0	V	232.0	50.7	-0.3	23.6	74
2243.000000	50.2	200.0	H	160.0	49.6	0.6	23.8	74
2335.000000	51.5	100.0	V	318.0	50.4	1.1	22.5	74
2770.000000	51.7	200.0	H	349.0	49.3	2.4	22.3	74
2864.000000	51.5	200.0	V	213.0	49.0	2.5	22.5	74

Remark: 1. Correction Factor = Antenna factor+ Insertion loss (cable loss + amplifier gain)



Frequency (MHz)	Average (dBuV/m)	Height (cm)	Polarization	Azimuth (deg)	Reading value (dBuV/m)	Correct Factor (dB)	Margin (dB)	Limit (dBuV/m)
1421.000000	35.6	200.0	H	353.0	39.7	-4.1	18.4	54
1608.500000	39.2	100.0	H	213.0	39.3	-0.1	14.8	54
2253.500000	39.4	200.0	V	122.0	38.7	0.7	14.6	54
2348.500000	39.9	200.0	H	0.0	38.7	1.2	14.1	54
2764.500000	40.7	100.0	V	337.0	38.4	2.3	13.3	54
2856.000000	40.5	200.0	H	342.0	38.0	2.5	13.5	54

**Remark: 1. Correction Factor = Antenna factor+ Insertion loss (cable loss + amplifier gain)**

**BLE-Channel 0**

FCC RE 1G-3GHz PK+AV Class B

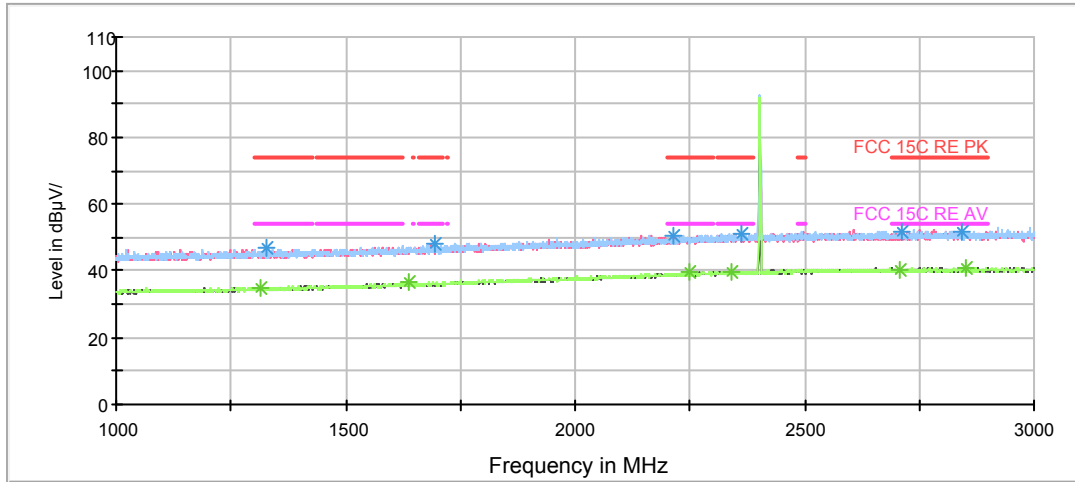

Note: The signal beyond the limit is carrier.  
Radiates Emission from 1GHz to 3GHz

FCC RE 1G-18GHz PK+AV Class B

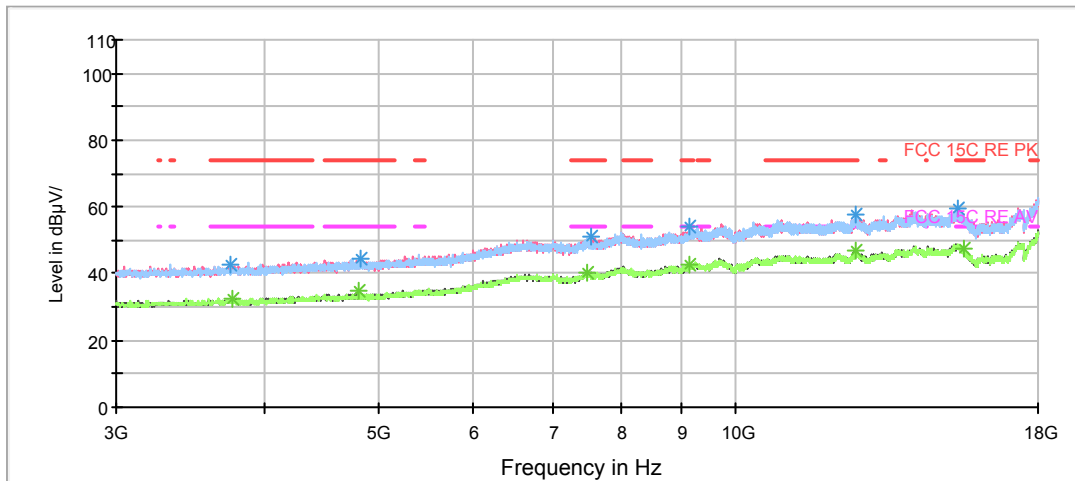

Radiates Emission from 3GHz to 18GHz

Frequency (MHz)	Peak (dBuV/m)	Height (cm)	Polarization	Azimuth (deg)	Reading value (dBuV/m)	Correct Factor (dB)	Margin (dB)	Limit (dBuV/m)
1328.500000	46.8	200.0	V	1.0	47.2	-0.4	27.2	74
1694.500000	48.2	200.0	H	348.0	46.5	1.7	25.8	74
2213.000000	50.3	200.0	V	286.0	45.8	4.5	23.7	74
2360.500000	51.2	200.0	H	264.0	45.9	5.3	22.8	74
2710.000000	51.8	200.0	V	247.0	45.7	6.1	22.2	74
2844.000000	51.9	100.0	H	6.0	45.6	6.3	22.1	74

**Remark: 1. Correction Factor = Antenna factor+ Insertion loss (cable loss + amplifier gain)**





Frequency (MHz)	Average (dBuV/m)	Height (cm)	Polarization	Azimuth (deg)	Reading value (dBuV/m)	Correct Factor (dB)	Margin (dB)	Limit (dBuV/m)
1314.500000	35.1	100.0	V	264.0	35.5	-0.4	18.9	54
1635.500000	36.5	100.0	H	9.0	35.2	1.3	17.5	54
2248.500000	39.6	100.0	V	196.0	34.9	4.7	14.4	54
2341.000000	39.9	200.0	V	197.0	34.7	5.2	14.1	54
2708.500000	40.5	100.0	V	226.0	34.4	6.1	13.5	54
2853.500000	41.0	200.0	H	322.0	34.7	6.3	13.0	54

**Remark: 1. Correction Factor = Antenna factor+ Insertion loss (cable loss + amplifier gain)**

**BLE-Channel 19**

FCC RE 1G-3GHz PK+AV Class B

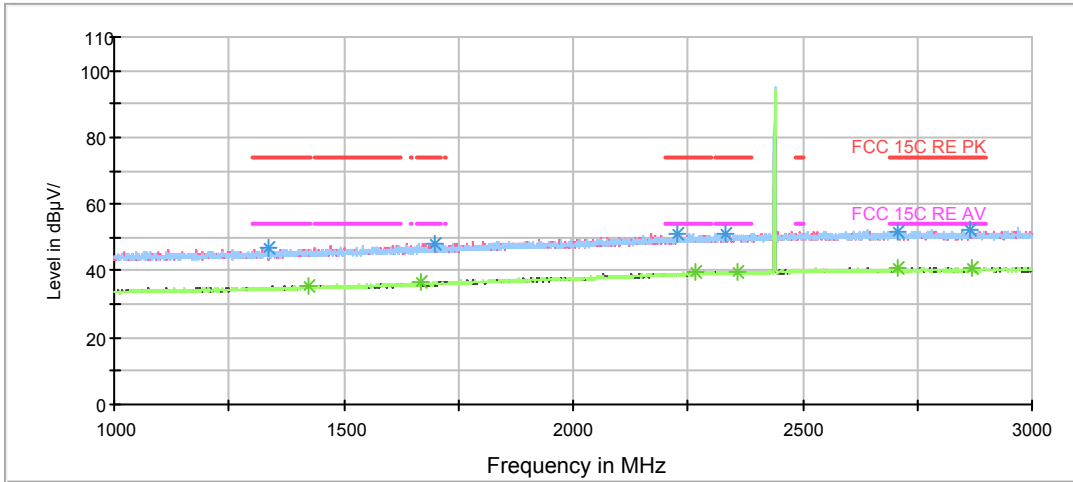

Note: The signal beyond the limit is carrier.  
Radiates Emission from 1GHz to 3GHz

FCC RE 1G-18GHz PK+AV Class B

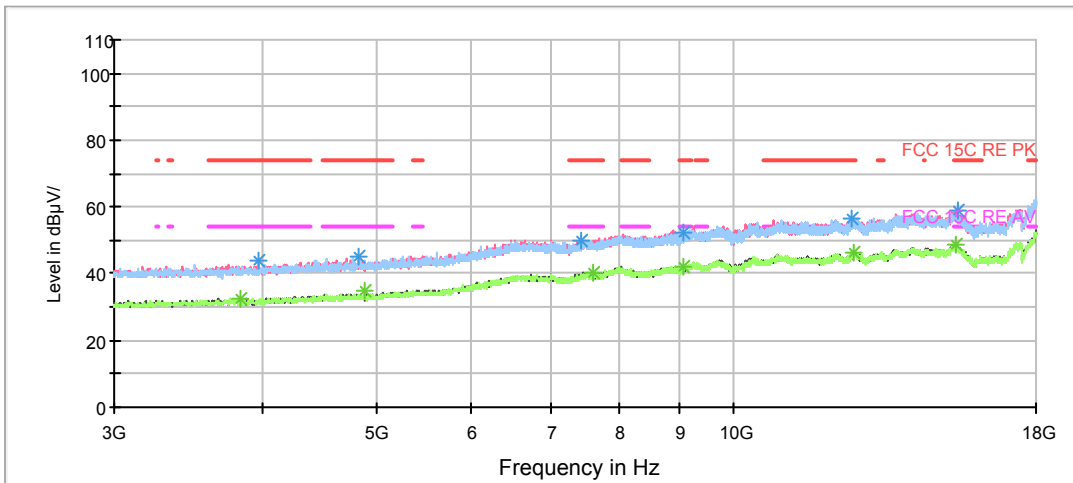

Radiates Emission from 3GHz to 18GHz

Frequency (MHz)	Peak (dBuV/m)	Height (cm)	Polarization	Azimuth (deg)	Reading value (dBuV/m)	Correct Factor (dB)	Margin (dB)	Limit (dBuV/m)
1337.000000	46.7	100.0	V	225.0	47.0	-0.3	27.3	74
1697.500000	48.3	200.0	H	264.0	46.6	1.7	25.7	74
2226.000000	51.3	100.0	V	138.0	46.7	4.6	22.7	74
2332.000000	51.3	200.0	V	195.0	46.2	5.1	22.7	74
2706.500000	51.7	200.0	V	118.0	45.6	6.1	22.3	74
2866.000000	52.4	100.0	H	5.0	46.1	6.3	21.6	74

**Remark: 1. Correction Factor = Antenna factor+ Insertion loss (cable loss + amplifier gain)**



Frequency (MHz)	Average (dBuV/m)	Height (cm)	Polarization	Azimuth (deg)	Reading value (dBuV/m)	Correct Factor (dB)	Margin (dB)	Limit (dBuV/m)
1425.500000	35.7	100.0	V	311.0	35.6	0.1	18.3	54
1670.000000	36.9	100.0	V	148.0	35.4	1.5	17.1	54
2264.500000	39.8	200.0	H	226.0	35.0	4.8	14.2	54
2357.500000	39.8	200.0	V	234.0	34.6	5.2	14.2	54
2706.500000	40.6	200.0	V	118.0	34.5	6.1	13.4	54
2868.500000	40.9	100.0	H	50.0	34.6	6.3	13.1	54

**Remark: 1. Correction Factor = Antenna factor+ Insertion loss (cable loss + amplifier gain)**

**BLE-Channel 39**

FCC RE 1G-3GHz PK+AV Class B

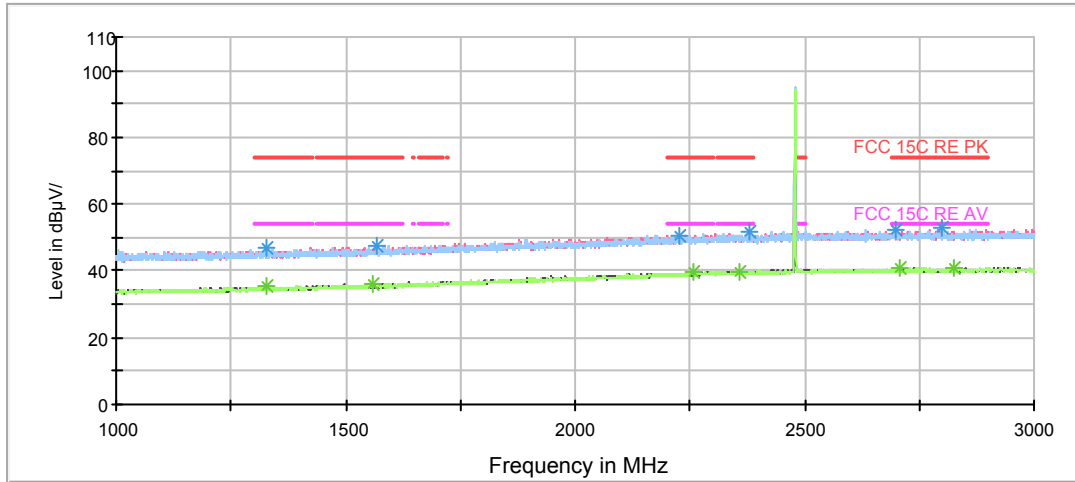

Note: The signal beyond the limit is carrier.  
Radiates Emission from 1GHz to 3GHz

FCC RE 1G-18GHz PK+AV Class B

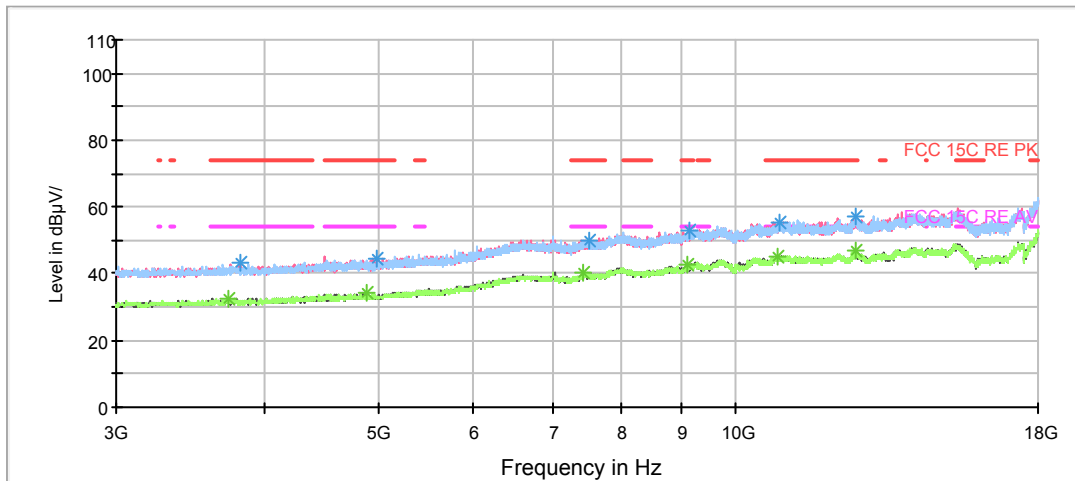

Radiates Emission from 3GHz to 18GHz

Frequency (MHz)	Peak (dBuV/m)	Height (cm)	Polarization	Azimuth (deg)	Reading value (dBuV/m)	Correct Factor (dB)	Margin (dB)	Limit (dBuV/m)
1326.500000	46.7	200.0	V	223.0	47.1	-0.4	27.3	74
1568.000000	47.6	200.0	V	156.0	46.7	0.9	26.4	74
2228.500000	50.8	200.0	H	349.0	46.2	4.6	23.2	74
2378.500000	51.7	100.0	H	90.0	46.4	5.3	22.3	74
2700.500000	52.1	200.0	H	5.0	46.0	6.1	21.9	74
2800.500000	52.8	100.0	H	52.0	46.6	6.2	21.2	74

Remark: 1. Correction Factor = Antenna factor+ Insertion loss (cable loss + amplifier gain)



Frequency (MHz)	Average (dBuV/m)	Height (cm)	Polarization	Azimuth (deg)	Reading value (dBuV/m)	Correct Factor (dB)	Margin (dB)	Limit (dBuV/m)
1328.000000	35.2	100.0	V	0.0	35.6	-0.4	18.8	54
1560.000000	36.0	200.0	V	16.0	35.2	0.8	18.0	54
2258.000000	39.6	200.0	V	10.0	34.9	4.7	14.4	54
2357.500000	39.9	100.0	H	339.0	34.7	5.2	14.1	54
2707.000000	40.7	200.0	H	123.0	34.6	6.1	13.3	54
2824.000000	40.6	100.0	V	314.0	34.3	6.3	13.4	54

**Remark: 1. Correction Factor = Antenna factor+ Insertion loss (cable loss + amplifier gain)**

### 5.7. Conducted Emission

#### Ambient condition

Temperature	Relative humidity	Pressure
23°C ~25°C	45%~50%	101.5kPa

#### Methods of Measurement

The EUT is placed on a non-metallic table of 80cm height above the horizontal metal reference ground plane. During the test, the EUT was operating in its typical mode. The test method is according to ANSI C63.10-2013. Connect the AC power line of the EUT to the L.I.S.N. Use EMI receiver to detect the average and Quasi-peak value. RBW is set to 9 kHz, VBW is set to 30kHz. The measurement result should include both L line and N line. The test is in transmitting mode.

#### Test Setup

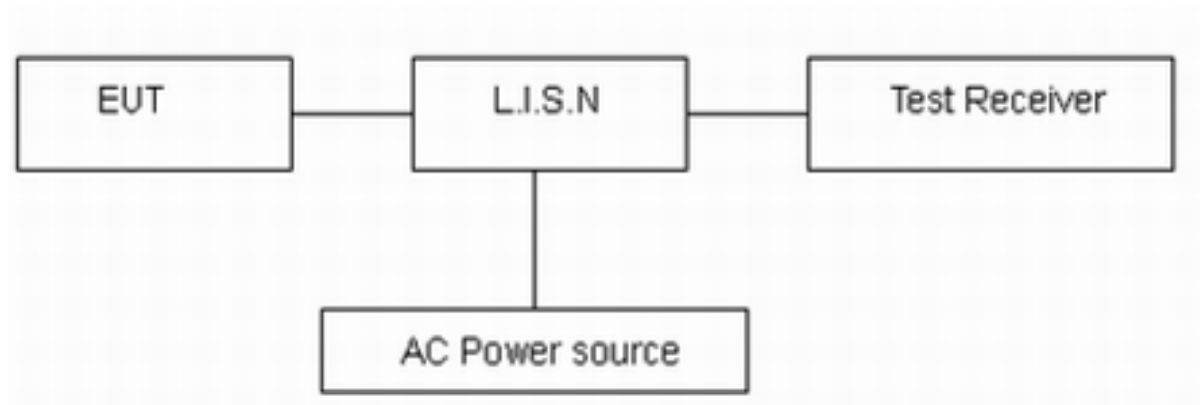

Note: AC Power source is used to change the voltage 110V/60Hz.

#### Limits

Frequency (MHz)	Conducted Limits(dBµV)	
	Quasi-peak	Average
0.15 - 0.5	66 to 56 *	56 to 46*
0.5 - 5	56	46
5 - 30	60	50

\*: Decreases with the logarithm of the frequency.

#### Measurement Uncertainty

The assessed measurement uncertainty to ensure 95% confidence level for the normal distribution is with the coverage factor  $k = 1.96$ ,  $U = 2.69$  dB.

**Test Results:**

Following plots, Blue trace uses the peak detection and Green trace uses the average detection. During the test, the Conducted Emission was performed in all modes (WIFI 2.4G /BLE) with all channels, 802.11b, Channel 6 are selected as the worst condition. The test data of the worst-case condition was recorded in this report.

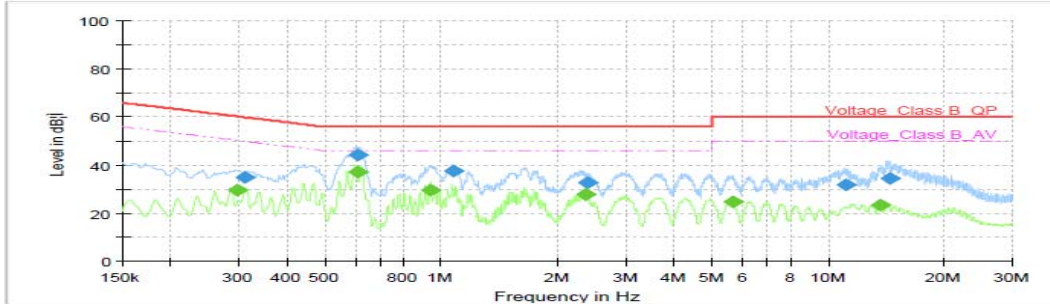

Frequency (MHz)	QuasiPeak (dB; i V)	Average (dB; i V)	Limit (dB; i V)	Margin (dB)	Meas. Time (ms)	Bandwidth (kHz)	Line	Filter	Corr. (dB)
0.296750	---	29.43	50.33	20.90	1000.0	9.000	L1	ON	19.2
0.310500	34.94	---	59.96	25.02	1000.0	9.000	L1	ON	19.2
0.607000	44.30	---	56.00	11.70	1000.0	9.000	L1	ON	19.3
0.610500	---	37.19	46.00	8.81	1000.0	9.000	L1	ON	19.3
0.934750	---	29.43	46.00	16.57	1000.0	9.000	L1	ON	19.2
1.074750	37.41	---	56.00	18.59	1000.0	9.000	L1	ON	19.2
2.375750	---	27.75	46.00	18.25	1000.0	9.000	L1	ON	19.0
2.379000	32.78	---	56.00	23.22	1000.0	9.000	L1	ON	19.0
5.680500	---	24.72	50.00	25.28	1000.0	9.000	L1	ON	19.1
11.072000	31.73	---	60.00	28.27	1000.0	9.000	L1	ON	19.4
13.731250	---	23.32	50.00	26.68	1000.0	9.000	L1	ON	19.5
14.430750	34.57	---	60.00	25.43	1000.0	9.000	L1	ON	19.5

L line

Conducted Emission from 150 KHz to 30 MHz

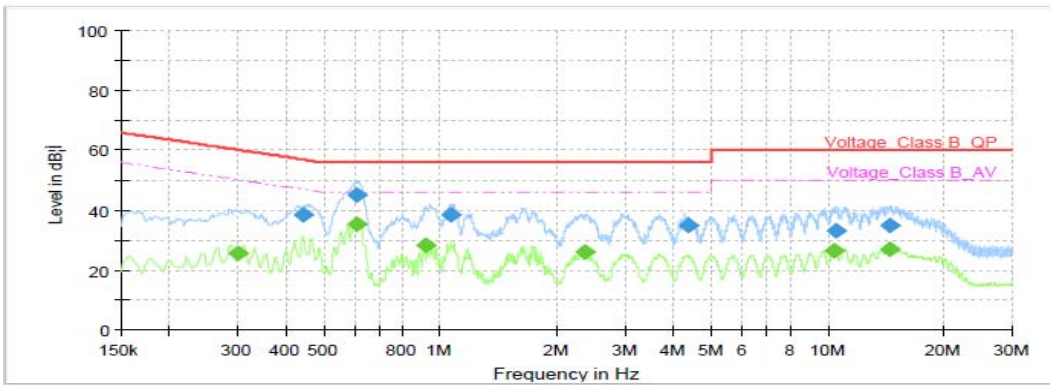

Frequency (MHz)	QuasiPeak (dB; i V)	Average (dB; i V)	Limit (dB; i V)	Margin (dB)	Meas. Time (ms)	Bandwidth (kHz)	Line	Filter	Corr. (dB)
0.299750	---	25.65	50.25	24.60	1000.0	9.000	N	ON	19.2
0.441750	38.34	---	57.03	18.69	1000.0	9.000	N	ON	19.2
0.610248	---	35.21	46.00	10.79	1000.0	9.000	N	ON	19.3
0.612499	45.01	---	56.00	10.99	1000.0	9.000	N	ON	19.3
0.923250	---	28.36	46.00	17.64	1000.0	9.000	N	ON	19.2
1.059750	38.56	---	56.00	17.44	1000.0	9.000	N	ON	19.2
2.353244	---	26.07	46.00	19.93	1000.0	9.000	N	ON	19.0
4.385246	35.02	---	56.00	20.98	1000.0	9.000	N	ON	19.1
10.412250	---	26.64	50.00	23.36	1000.0	9.000	N	ON	19.4
10.456981	33.24	---	60.00	26.76	1000.0	9.000	N	ON	19.4
14.407957	---	26.90	50.00	23.10	1000.0	9.000	N	ON	19.5
14.495976	35.11	---	60.00	24.89	1000.0	9.000	N	ON	19.5

N line

Conducted Emission from 150 KHz to 30 MHz



## 6. Main Test Instruments

Name	Manufacturer	Type	Serial Number	Calibration Date	Expiration Date
Spectrum Analyzer	R&S	FSV30	100815	2017-12-17	2018-12-16
EMI Test Receiver	R&S	ESCI	100948	2018-05-20	2019-05-19
Loop Antenna	SCHWARZBECK	FMZB1519	1519-047	2017-09-26	2019-09-25
TRILOG Broadband Antenna	Schwarzbeck	VULB 9163	9163-201	2017-11-18	2019-11-17
Double Ridged Waveguide Horn Antenna	R&S	HF907	100126	2018-07-07	2020-07-06
Standard Gain Horn	ETS-Lindgren	3160-09	00102643	2018-06-20	2020-06-19
EMI Test Receiver	R&S	ESR	101667	2018-05-20	2019-05-19
LISN	R&S	ENV216	101171	2016-12-16	2019-12-15
Spectrum Analyzer	Agilent	N9010A	MY47191109	2018-05-20	2019-05-19
Power Meter	R&S	NRP	104306	2018-05-20	2019-05-19
Power Sensor	R&S	NRP-Z21	104799	2018-05-20	2019-05-19
RF Cable	Agilent	SMA 15cm	0001	/	/
Software	R&S	EMC32	9.26.0	/	/

\*\*\*\*\*END OF REPORT \*\*\*\*\*



## ANNEX A: EUT Appearance and Test Setup

### A.1 EUT Appearance



Front Side



Back Side

a: EUT



Adapter 1



Adapter 2





Adapter 3  
b: Adapter



c. Earphone



d. USB Cable

Picture 1 EUT and Accessory

## A.2 Test Setup



30MHz-1GHz

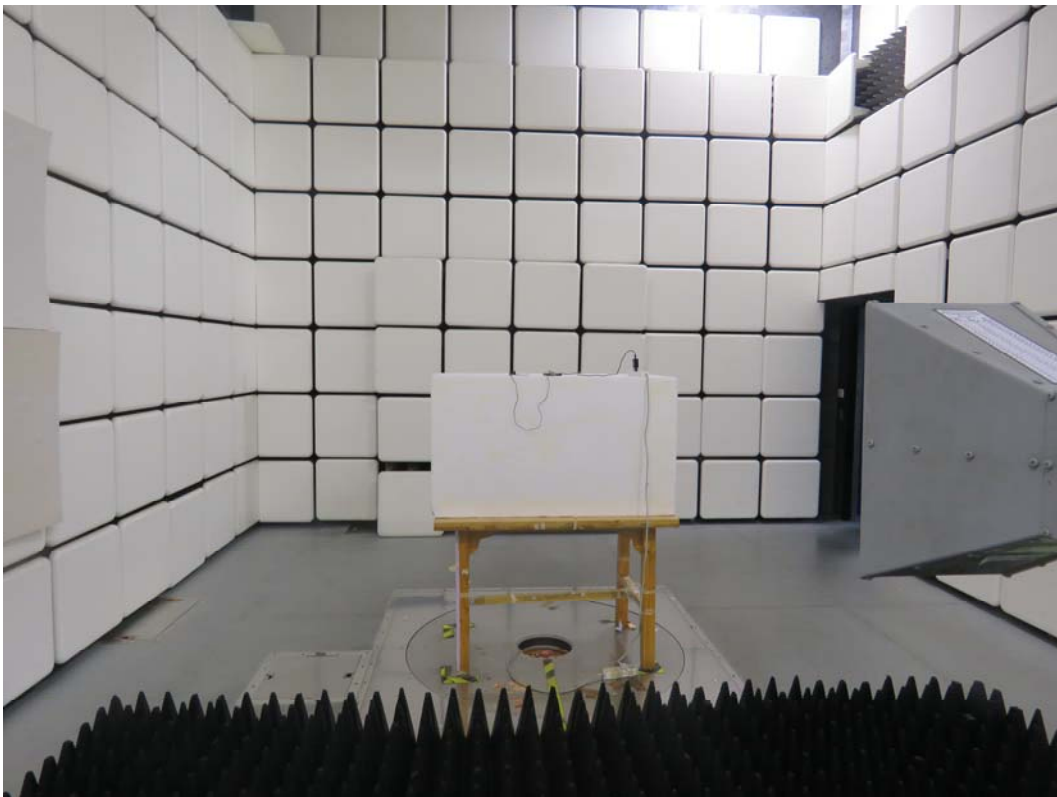

Above 1GHz

**Picture 2 Radiated Emission Test Setup**





**Picture 3 Conducted Emission Test Setup**