



In Collaboration with  
 Add: No.51 Xueyuan Road, Haidian District, Beijing, 100191, China  
 Tel: +86-10-62304633-2218 Fax: +86-10-62304633-2209  
 E-mail: cttl@chinattl.com [Http://www.chinattl.cn](http://www.chinattl.cn)

## Conversion Factor Assessment

f=850 MHz, WGLS R9(H\_convF)

f=1750 MHz, WGLS R22(H\_convF)

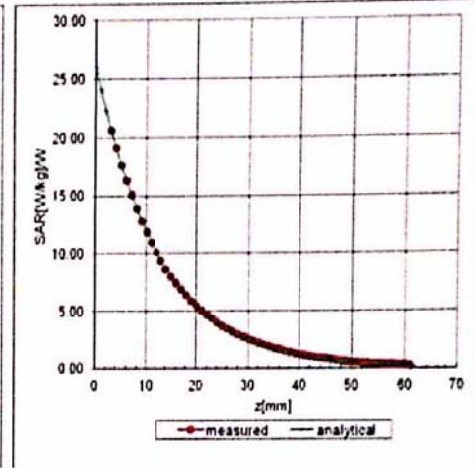
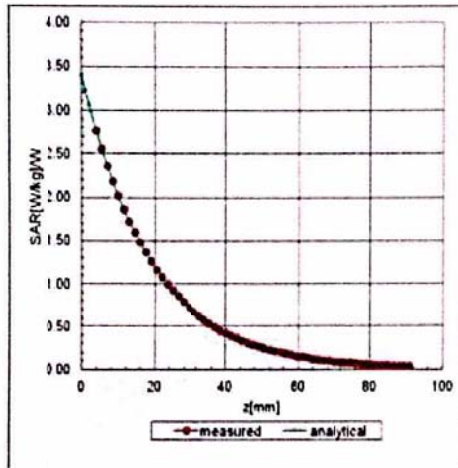

## Deviation from Isotropy in Liquid

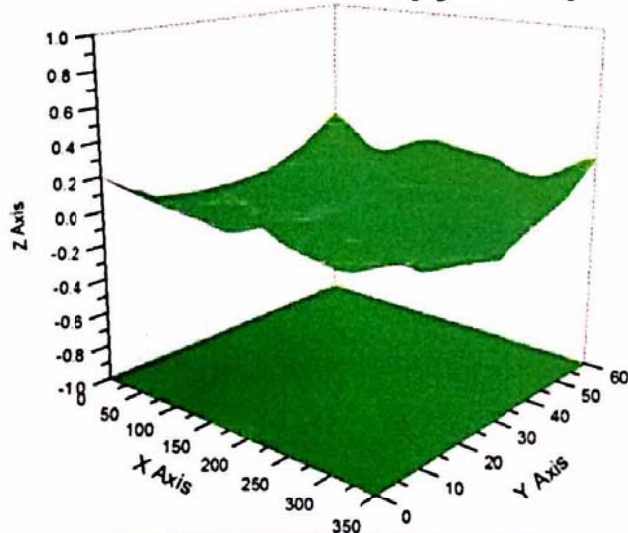

Uncertainty of Spherical Isotropy Assessment:  $\pm 2.8\%$  (K=2)



Add: No.51 Xueyuan Road, Haidian District, Beijing, 100191, China  
Tel: +86-10-62304633-2218 Fax: +86-10-62304633-2209  
E-mail: [ctl@chinattl.com](mailto:ctl@chinattl.com) <http://www.chinattl.cn>

## DASY/EASY – Parameters of Probe: EX3DV4 – SN: 3677

### Other Probe Parameters

Sensor Arrangement	Triangular
Connector Angle (°)	118.5
Mechanical Surface Detection Mode	enabled
Optical Surface Detection Mode	disable
Probe Overall Length	337mm
Probe Body Diameter	10mm
Tip Length	9mm
Tip Diameter	2.5mm
Probe Tip to Sensor X Calibration Point	1mm
Probe Tip to Sensor Y Calibration Point	1mm
Probe Tip to Sensor Z Calibration Point	1mm
Recommended Measurement Distance from Surface	1.4mm



# ANNEX E: D835V2 Dipole Calibration Certificate



Add: No.51 Xueyuan Road, Haidian District, Beijing, 100191, China  
Tel: +86-10-62304633-2079 Fax: +86-10-62304633-2504  
E-mail: cttl@chinattl.com Http://www.chinattl.cn



Client **TA(Shanghai)** Certificate No: **Z14-97073**

## CALIBRATION CERTIFICATE

Object: **D835V2 - SN: 4d020**

Calibration Procedure(s): **TMC-OS-E-02-194**  
**Calibration procedure for dipole validation kits**

Calibration date: **August 28, 2014**

This calibration Certificate documents the traceability to national standards, which realize the physical units of measurements(SI). The measurements and the uncertainties with confidence probability are given on the following pages and are part of the certificate.

All calibrations have been conducted in the closed laboratory facility: environment temperature(22±3)°C and humidity<70%.

Calibration Equipment used (M&TE critical for calibration)

Primary Standards	ID #	Cal Date(Calibrated by, Certificate No.)	Scheduled Calibration
Power Meter NRVD	102083	11-Sep-13 (TMC, No.JZ13-443)	Sep-14
Power sensor NRV-Z5	100595	11-Sep-13 (TMC, No. JZ13-443)	Sep -14
Reference Probe ES3DV3	SN 3149	5- Sep-13 (SPEAG, No.ES3-3149_Sep13)	Sep-14
DAE3	SN 536	23-Jan-14 (SPEAG, DAE3-536_Jan14)	Jan -15
Signal Generator E4438C	MY49070393	13-Nov-13 (TMC, No.JZ'3-394)	Nov-14
Network Analyzer E8362B	MY43021135	19-Oct-13 (TMC, No.JZ13-278)	Oct-14

	Name	Function	Signature
Calibrated by:	Zhao Jing	SAR Test Engineer	
Reviewed by:	Qi Dianyuan	SAR Project Leader	
Approved by:	Lu Bingsong	Deputy Director of the laboratory	

Issued: September 4, 2014

This calibration certificate shall not be reproduced except in full without written approval of the laboratory.



Add: No.51 Xueyuan Road, Haidian District, Beijing, 100191, China  
Tel: +86-10-62304633-2079 Fax: +86-10-62304633-2504  
E-mail: cttl@chinattl.com Http://www.chinattl.cn

**Glossary:**

TSL	tissue simulating liquid
ConyF	sensitivity in TSL / NORM <sub>x,y,z</sub>
N/A	not applicable or not measured

**Calibration is Performed According to the Following Standards:**

- IEEE Std 1528-2013, "IEEE Recommended Practice for Determining the Peak Spatial-Averaged Specific Absorption Rate (SAR) in the Human Head from Wireless Communications Devices: Measurement Techniques", June 2013
- IEC 62209-1, "Procedure to measure the Specific Absorption Rate (SAR) For hand-held devices used in close proximity to the ear (frequency range of 300MHz to 3GHz)", February 2005
- KDB865664, SAR Measurement Requirements for 100 MHz to 6 GHz

**Additional Documentation:**

- DASY4/5 System Handbook

**Methods Applied and Interpretation of Parameters:**

- Measurement Conditions:* Further details are available from the Validation Report at the end of the certificate. All figures stated in the certificate are valid at the frequency indicated.
- Antenna Parameters with TSL:* The dipole is mounted with the spacer to position its feed point exactly below the center marking of the flat phantom section, with the arms oriented parallel to the body axis.
- Feed Point Impedance and Return Loss:* These parameters are measured with the dipole positioned under the liquid filled phantom. The impedance stated is transformed from the measurement at the SMA connector to the feed point. The Return Loss ensures low reflected power. No uncertainty required.
- Electrical Delay:* One-way delay between the SMA connector and the antenna feed point. No uncertainty required.
- SAR measured:* SAR measured at the stated antenna input power.
- SAR normalized:* SAR as measured, normalized to an input power of 1 W at the antenna connector.
- SAR for nominal TSL parameters:* The measured TSL parameters are used to calculate the nominal SAR result.

The reported uncertainty of measurement is stated as the standard uncertainty of Measurement multiplied by the coverage factor  $k=2$ , which for a normal distribution corresponds to a coverage probability of approximately 95%.



Add: No.51 Xueyuan Road, Haidian District, Beijing, 100191, China  
 Tel: +86-10-62304633-2079 Fax: +86-10-62304633-2504  
 E-mail: cttl@chinattl.com Http://www.chinattl.cn



**Measurement Conditions**

DASY system configuration, as far as not given on page 1.

DASY Version	DASY52	52.8.8.1222
Extrapolation	Advanced Extrapolation	
Phantom	Triple Flat Phantom 5.1C	
Distance Dipole Center - TSL	15 mm	with Spacer
Zoom Scan Resolution	dx, dy, dz = 5 mm	
Frequency	835 MHz ± 1 MHz	

**Head TSL parameters**

The following parameters and calculations were applied.

	Temperature	Permittivity	Conductivity
Nominal Head TSL parameters	22.0 °C	41.5	0.90 mho/m
Measured Head TSL parameters	(22.0 ± 0.2) °C	42.5 ± 6 %	0.91 mho/m ± 6 %
Head TSL temperature change during test	<1.0 °C	----	----

**SAR result with Head TSL**

<b>SAR averaged over 1 cm<sup>3</sup> (1 g) of Head TSL</b>	Condition	
SAR measured	250 mW input power	2.39 mW / g
SAR for nominal Head TSL parameters	normalized to 1W	<b>9.54 mW/g ± 20.8 % (k=2)</b>
<b>SAR averaged over 10 cm<sup>3</sup> (10 g) of Head TSL</b>	Condition	
SAR measured	250 mW input power	1.57 mW / g
SAR for nominal Head TSL parameters	normalized to 1W	<b>6.26 mW/g ± 20.4 % (k=2)</b>

**Body TSL parameters**

The following parameters and calculations were applied.

	Temperature	Permittivity	Conductivity
Nominal Body TSL parameters	22.0 °C	55.2	0.97 mho/m
Measured Body TSL parameters	(22.0 ± 0.2) °C	56.7 ± 6 %	0.97 mho/m ± 6 %
Body TSL temperature change during test	<1.0 °C	----	----

**SAR result with Body TSL**

<b>SAR averaged over 1 cm<sup>3</sup> (1 g) of Body TSL</b>	Condition	
SAR measured	250 mW input power	2.37 mW / g
SAR for nominal Body TSL parameters	normalized to 1W	<b>9.54 mW/g ± 20.8 % (k=2)</b>
<b>SAR averaged over 10 cm<sup>3</sup> (10 g) of Body TSL</b>	Condition	
SAR measured	250 mW input power	1.57 mW / g
SAR for nominal Body TSL parameters	normalized to 1W	<b>6.31 mW/g ± 20.4 % (k=2)</b>



Add: No.51 Xueyuan Road, Haidian District, Beijing, 100191, China  
Tel: +86-10-62304633-2079 Fax: +86-10-62304633-2504  
E-mail: ttl@chinattl.com Http://www.chinattl.cn



## Appendix

### Antenna Parameters with Head TSL

Impedance, transformed to feed point	48.6Ω + 2.75jΩ
Return Loss	- 30.1 dB

### Antenna Parameters with Body TSL

Impedance, transformed to feed point	54.0Ω + 5.88jΩ
Return Loss	- 23.3dB

### General Antenna Parameters and Design

Electrical Delay (one direction)	1.242 ns
----------------------------------	----------

After long term use with 100W radiated power, only a slight warming of the dipole near the feedpoint can be measured.

The dipole is made of standard semirigid coaxial cable. The center conductor of the feeding line is directly connected to the second arm of the dipole. The antenna is therefore short-circuited for DC-signals. On some of the dipoles, small end caps are added to the dipole arms in order to improve matching when loaded according to the position as explained in the "Measurement Conditions" paragraph. The SAR data are not affected by this change. The overall dipole length is still according to the Standard.

No excessive force must be applied to the dipole arms, because they might bend or the soldered connections near the feedpoint may be damaged.

### Additional EUT Data

Manufactured by	SPEAG
-----------------	-------



Add: No.51 Xueyuan Road, Haidian District, Beijing, 100191, China  
 Tel: +86-10-62304633-2079 Fax: +86-10-62304633-2504  
 E-mail: cttl@chinattl.com Http://www.chinattl.cn



**DASY5 Validation Report for Head TSL**

Date: 28.08.2014

Test Laboratory: CTTL, Beijing, China

**DUT: Dipole 835 MHz; Type: D835V2; Serial: D835V2 - SN: 4d020**

Communication System: UID 0, CW (0); Frequency: 835 MHz; Duty Cycle: 1:1  
 Medium parameters used:  $f = 835 \text{ MHz}$ ;  $\sigma = 0.909 \text{ S/m}$ ;  $\epsilon_r = 42.49$ ;  $\rho = 1000 \text{ kg/m}^3$   
 Phantom section: Left Section  
 Measurement Standard: DASY5 (IEEE/IEC/ANSI C63.19-2007)

**DASY5 Configuration:**

- Probe: ES3DV3 - SN3149; ConvF(6.21, 6.21, 6.21); Calibrated: 2013-09-05;
- Sensor-Surface: 3mm (Mechanical Surface Detection)
- Electronics: DAE3 Sn536; Calibrated: 2014-01-23
- Phantom: Triple Flat Phantom 5.1C; Type: QD 000 P51 CA; Serial: 1161/1
- Measurement SW: DASY52, Version 52.8 (8); SEMCAD X Version 14.6.10 (7331)

**System Performance Check at Frequencies below 1 GHz/d=15mm, Pin=250 mW, dist=3.0mm (ES-Probe)/Zoom Scan (7x7x7) (7x7x7)/Cube 0: Measurement grid: dx=5mm, dy=5mm, dz=5mm**

Reference Value = 55.88 V/m; Power Drift = -0.01 dB

Peak SAR (extrapolated) = 3.54 W/kg

**SAR(1 g) = 2.39 W/kg; SAR(10 g) = 1.57 W/kg**

Maximum value of SAR (measured) = 2.79 W/kg

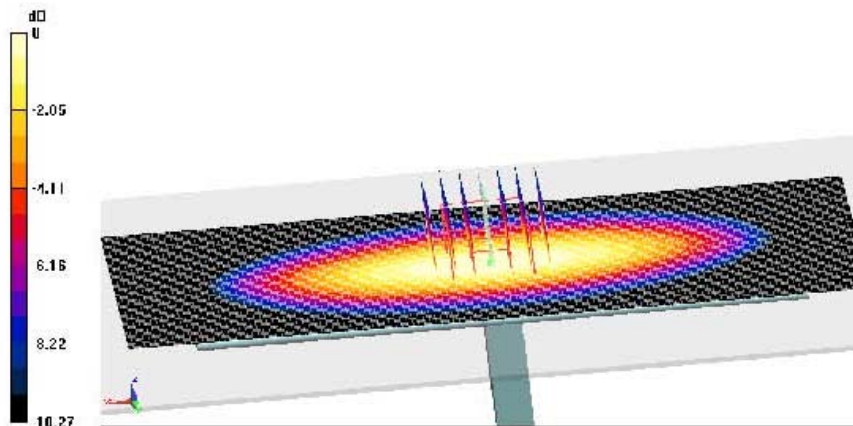

0 dB = 2.79 W/kg = 4.46 dBW/kg

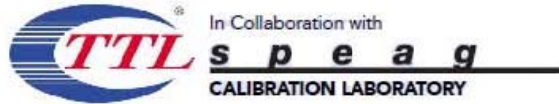

Add: No.51 Xueyuan Road, Haidian District, Beijing, 100191, China  
Tel: +86-10-62304633-2079 Fax: +86-10-62304633-2504  
E-mail: cttl@chinattl.com Http://www.chinattl.cn



Impedance Measurement Plot for Head TSL

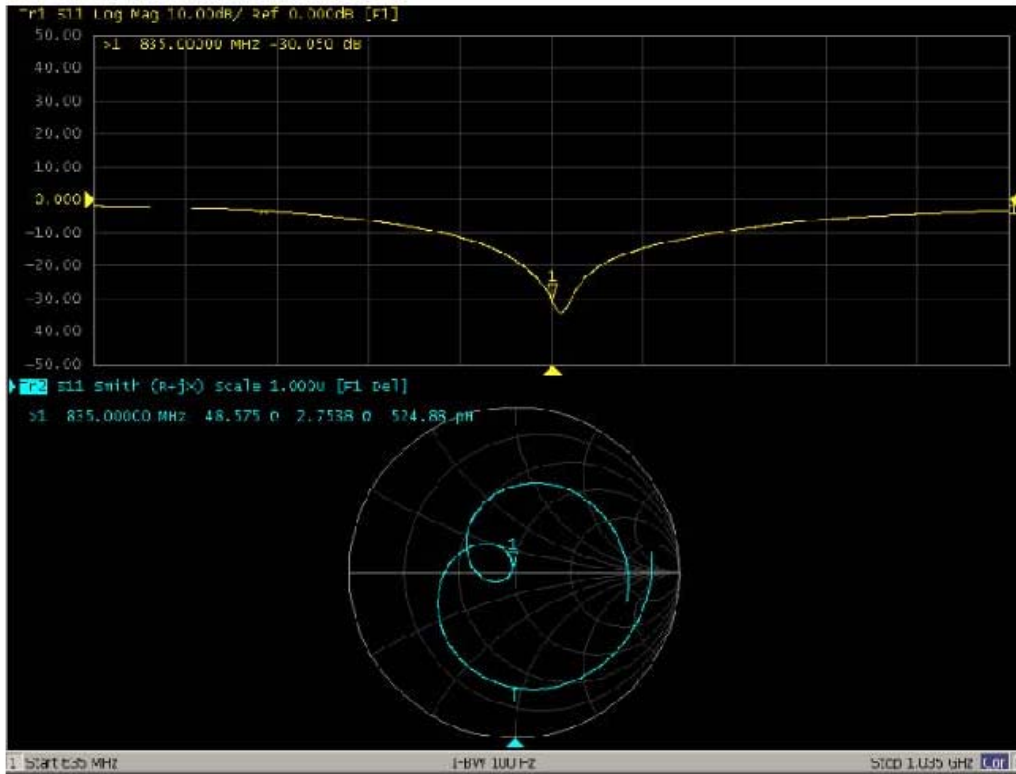





Add: No.51 Xueyuan Road, Haidian District, Beijing, 100191, China  
 Tel: +86-10-62304633-2079 Fax: +86-10-62304633-2504  
 E-mail: cttl@chinattl.com Http://www.chinattl.cn



**DASY5 Validation Report for Body TSL**

Date: 28.08.2014

Test Laboratory: CTTL, Beijing, China

**DUT: Dipole 835 MHz; Type: D835V2; Serial: D835V2 - SN: 4d020**

Communication System: UID 0, CW (0); Frequency: 835 MHz; Duty Cycle: 1:1  
 Medium parameters used:  $f = 835 \text{ MHz}$ ;  $\sigma = 0.97 \text{ S/m}$ ;  $\epsilon_r = 56.745$ ;  $\rho = 1000 \text{ kg/m}^3$   
 Phantom section: Center Section  
 Measurement Standard: DASY5 (IEEE/IEC/ANSI C63.19-2007)

DASY5 Configuration:

- Probe: ES3DV3 - SN3149; ConvF(5.98, 5.98, 5.98); Calibrated: 2013-09-05;
- Sensor-Surface: 3mm (Mechanical Surface Detection)
- Electronics: DAE3 Sn536; Calibrated: 2014-01-23
- Phantom: Triple Flat Phantom 5.1C; Type: QD 000 P51 CA; Serial: 1161/2
- Measurement SW: DASY52, Version 52.8 (8); SEMCAD X Version 14.6.10 (7331)

**System Performance Check at Frequencies below 1 GHz/d=15mm, Pin=250 mW, dist=3.0mm (ES-Probe)/Zoom Scan (7x7x7) (7x7x7)/Cube 0: Measurement grid: dx=5mm, dy=5mm, dz=5mm**

Reference Value = 53.515 V/m; Power Drift = -0.01 dB

Peak SAR (extrapolated) = 3.45 W/kg

**SAR(1 g) = 2.37 W/kg; SAR(10 g) = 1.57 W/kg**

Maximum value of SAR (measured) = 2.74 W/kg

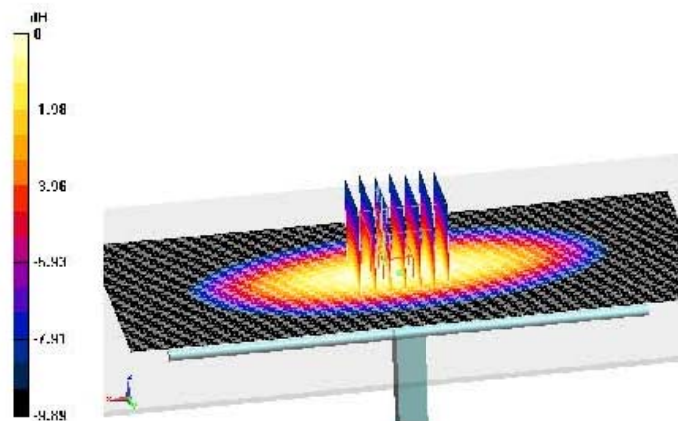

0 dB = 2.74 W/kg = 4.38 dBW/kg



Add: No.51 Xueyuan Road, Haidian District, Beijing, 100191, China  
Tel: +86-10-62304633-2079 Fax: +86-10-62304633-2504  
E-mail: cttl@chinattl.com Http://www.chinattl.cn



### Impedance Measurement Plot for Body TSL

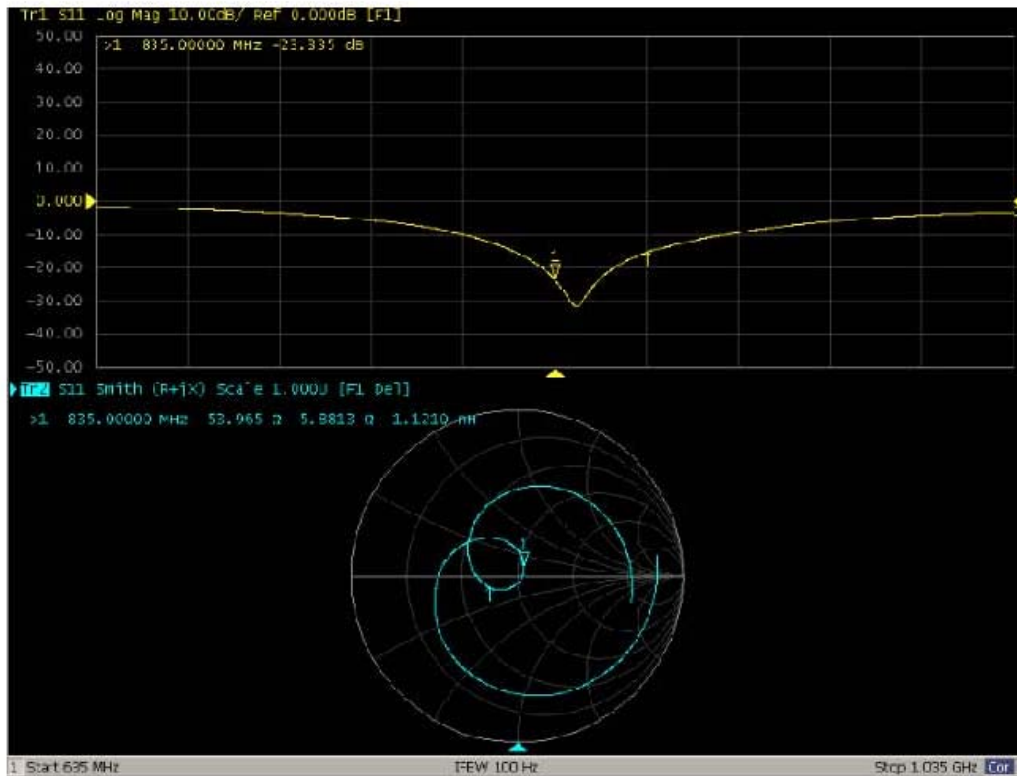



# ANNEX F: D1900V2 Dipole Calibration Certificate



Add: No.51 Xueyuan Road, Haidian District, Beijing, 100191, China  
Tel: +86-10-62304633-2079 Fax: +86-10-62304633-2504  
E-mail: cttl@chinattl.com Http://www.chinattl.cn



Client **TA(Shanghai)** Certificate No: **Z14-97074**

## CALIBRATION CERTIFICATE

Object: **D1900V2 - SN: 5d060**

Calibration Procedure(s): **TMC-OS-E-02-194  
Calibration procedure for dipole validation kits**

Calibration date: **September 1, 2014**

This calibration Certificate documents the traceability to national standards, which realize the physical units of measurements(SI). The measurements and the uncertainties with confidence probability are given on the following pages and are part of the certificate.

All calibrations have been conducted in the closed laboratory facility: environment temperature(22±3)°C and humidity<70%.

Calibration Equipment used (M&TE critical for calibration)

Primary Standards	ID #	Cal Date(Calibrated by, Certificate No.)	Scheduled Calibration
Power Meter NRVD	102083	11-Sep-13 (TMC, No.JZ13-443)	Sep-14
Power sensor NRV-Z5	100595	11-Sep-13 (TMC, No. JZ13-443)	Sep -14
Reference Probe ES3DV3	SN 3149	5- Sep-13 (SPEAG, No.ES3-3149_Sep13)	Sep-14
DAE3	SN 536	23-Jan-14 (SPEAG, DAE3-536_Jan14)	Jan -15
Signal Generator E4438C	MY49070393	13-Nov-13 (TMC, No.JZ13-394)	Nov-14
Network Analyzer E8362B	MY43021135	19-Oct-13 (TMC, No.JZ13-278)	Oct-14

	Name	Function	Signature
Calibrated by:	Zhao Jing	SAR Test Engineer	
Reviewed by:	Qi Dianyuan	SAR Project Leader	
Approved by:	Lu Bingsong	Deputy Director of the laboratory	

Issued: September 4, 2014

This calibration certificate shall not be reproduced except in full without written approval of the laboratory.



Add: No.51 Xueyuan Road, Haidian District, Beijing, 100191, China  
Tel: +86-10-62304633-2079 Fax: +86-10-62304633-2504  
E-mail: cttl@chinattl.com Http://www.chinattl.cn

**Glossary:**

TSL	tissue simulating liquid
ConyF	sensitivity in TSL / NORM <sub>x,y,z</sub>
N/A	not applicable or not measured

**Calibration is Performed According to the Following Standards:**

- IEEE Std 1528-2013, "IEEE Recommended Practice for Determining the Peak Spatial-Averaged Specific Absorption Rate (SAR) in the Human Head from Wireless Communications Devices: Measurement Techniques", June 2013
- IEC 62209-1, "Procedure to measure the Specific Absorption Rate (SAR) For hand-held devices used in close proximity to the ear (frequency range of 300MHz to 3GHz)", February 2005
- KDB865664, SAR Measurement Requirements for 100 MHz to 6 GHz

**Additional Documentation:**

- DASY4/5 System Handbook

**Methods Applied and Interpretation of Parameters:**

- Measurement Conditions:* Further details are available from the Validation Report at the end of the certificate. All figures stated in the certificate are valid at the frequency indicated.
- Antenna Parameters with TSL:* The dipole is mounted with the spacer to position its feed point exactly below the center marking of the flat phantom section, with the arms oriented parallel to the body axis.
- Feed Point Impedance and Return Loss:* These parameters are measured with the dipole positioned under the liquid filled phantom. The impedance stated is transformed from the measurement at the SMA connector to the feed point. The Return Loss ensures low reflected power. No uncertainty required.
- Electrical Delay:* One-way delay between the SMA connector and the antenna feed point. No uncertainty required.
- SAR measured:* SAR measured at the stated antenna input power.
- SAR normalized:* SAR as measured, normalized to an input power of 1 W at the antenna connector.
- SAR for nominal TSL parameters:* The measured TSL parameters are used to calculate the nominal SAR result.

The reported uncertainty of measurement is stated as the standard uncertainty of Measurement multiplied by the coverage factor  $k=2$ , which for a normal distribution Corresponds to a coverage probability of approximately 95%.



Add: No.51 Xueyuan Road, Haidian District, Beijing, 100191, China  
 Tel: +86-10-62304633-2079 Fax: +86-10-62304633-2504  
 E-mail: cttl@chinattl.com Http://www.chinattl.cn



**Measurement Conditions**

DASY system configuration, as far as not given on page 1.

<b>DASY Version</b>	DASY52	52.8.8.1222
<b>Extrapolation</b>	Advanced Extrapolation	
<b>Phantom</b>	Triple Flat Phantom 5.1C	
<b>Distance Dipole Center - TSL</b>	10 mm	with Spacer
<b>Zoom Scan Resolution</b>	dx, dy, dz = 5 mm	
<b>Frequency</b>	1900 MHz ± 1 MHz	

**Head TSL parameters**

The following parameters and calculations were applied.

	Temperature	Permittivity	Conductivity
<b>Nominal Head TSL parameters</b>	22.0 °C	40.0	1.40 mho/m
<b>Measured Head TSL parameters</b>	(22.0 ± 0.2) °C	39.8 ± 6 %	1.37 mho/m ± 6 %
<b>Head TSL temperature change during test</b>	<1.0 °C	----	----

**SAR result with Head TSL**

<b>SAR averaged over 1 cm<sup>3</sup> (1 g) of Head TSL</b>	Condition	
SAR measured	250 mW input power	9.69 mW / g
SAR for nominal Head TSL parameters	normalized to 1W	<b>39.2 mW/g ± 20.8 % (k=2)</b>
<b>SAR averaged over 10 cm<sup>3</sup> (10 g) of Head TSL</b>	Condition	
SAR measured	250 mW input power	5.14 mW / g
SAR for nominal Head TSL parameters	normalized to 1W	<b>20.7 mW/g ± 20.4 % (k=2)</b>

**Body TSL parameters**

The following parameters and calculations were applied.

	Temperature	Permittivity	Conductivity
<b>Nominal Body TSL parameters</b>	22.0 °C	53.3	1.52 mho/m
<b>Measured Body TSL parameters</b>	(22.0 ± 0.2) °C	51.8 ± 6 %	1.50 mho/m ± 6 %
<b>Body TSL temperature change during test</b>	<1.0 °C	----	----

**SAR result with Body TSL**

<b>SAR averaged over 1 cm<sup>3</sup> (1 g) of Body TSL</b>	Condition	
SAR measured	250 mW input power	9.98 mW / g
SAR for nominal Body TSL parameters	normalized to 1W	<b>40.0 mW/g ± 20.8 % (k=2)</b>
<b>SAR averaged over 10 cm<sup>3</sup> (10 g) of Body TSL</b>	Condition	
SAR measured	250 mW input power	5.28 mW / g
SAR for nominal Body TSL parameters	normalized to 1W	<b>21.1 mW/g ± 20.4 % (k=2)</b>



Add: No.51 Xueyuan Road, Haidian District, Beijing, 100191, China  
Tel: +86-10-62304633-2079 Fax: +86-10-62304633-2504  
E-mail: ttl@chinattl.com Http://www.chinattl.cn



## Appendix

### Antenna Parameters with Head TSL

Impedance, transformed to feed point	54.1Ω- 6.34jΩ
Return Loss	- 22.8dB

### Antenna Parameters with Body TSL

Impedance, transformed to feed point	57.6Ω- 4.76jΩ
Return Loss	- 21.6dB

### General Antenna Parameters and Design

Electrical Delay (one direction)	1.248 ns
----------------------------------	----------

After long term use with 100W radiated power, only a slight warming of the dipole near the feedpoint can be measured.

The dipole is made of standard semirigid coaxial cable. The center conductor of the feeding line is directly connected to the second arm of the dipole. The antenna is therefore short-circuited for DC-signals. On some of the dipoles, small end caps are added to the dipole arms in order to improve matching when loaded according to the position as explained in the "Measurement Conditions" paragraph. The SAR data are not affected by this change. The overall dipole length is still according to the Standard.

No excessive force must be applied to the dipole arms, because they might bend or the soldered connections near the feedpoint may be damaged.

### Additional EUT Data

Manufactured by	SPEAG
-----------------	-------



Add: No.51 Xueyuan Road, Haidian District, Beijing, 100191, China  
 Tel: +86-10-62304633-2079 Fax: +86-10-62304633-2504  
 E-mail: cttl@chinattl.com Http://www.chinattl.cn



**DASY5 Validation Report for Head TSL**

Date: 01.09.2014

Test Laboratory: CTTL, Beijing, China

**DUT: Dipole 1900 MHz; Type: D1900V2; Serial: D1900V2 - SN: 5d060**

Communication System: UID 0, CW; Frequency: 1900 MHz; Duty Cycle: 1:1

Medium parameters used:  $f = 1900 \text{ MHz}$ ;  $\sigma = 1.371 \text{ S/m}$ ;  $\epsilon_r = 39.83$ ;  $\rho = 1000 \text{ kg/m}^3$

Phantom section: Left Section

Measurement Standard: DASY5 (IEEE/IEC/ANSI C63.19-2007)

DASY5 Configuration:

- Probe: ES3DV3 - SN3149; ConvF(5.06, 5.06, 5.06); Calibrated: 2013-09-05;
- Sensor-Surface: 3mm (Mechanical Surface Detection)
- Electronics: DAE3 Sn536; Calibrated: 2014-01-23
- Phantom: Triple Flat Phantom 5.1C; Type: QD 000 P51 CA; Serial: 1161/1
- Measurement SW: DASY52, Version 52.8 (8); SEMCAD X Version 14.6.10 (7331)

**System Performance Check at Frequencies above 1 GHz/d=10mm, Pin=250 mW,**

**dist=3.0mm (ES-Probe)/Zoom Scan (7x7x7) (7x7x7)/Cube 0: Measurement grid:**

$dx=5\text{mm}$ ,  $dy=5\text{mm}$ ,  $dz=5\text{mm}$

Reference Value = 99.911 V/m; Power Drift = -0.06 dB

Peak SAR (extrapolated) = 17.5 W/kg

**SAR(1 g) = 9.69 W/kg; SAR(10 g) = 5.14 W/kg**

Maximum value of SAR (measured) = 12.2 W/kg

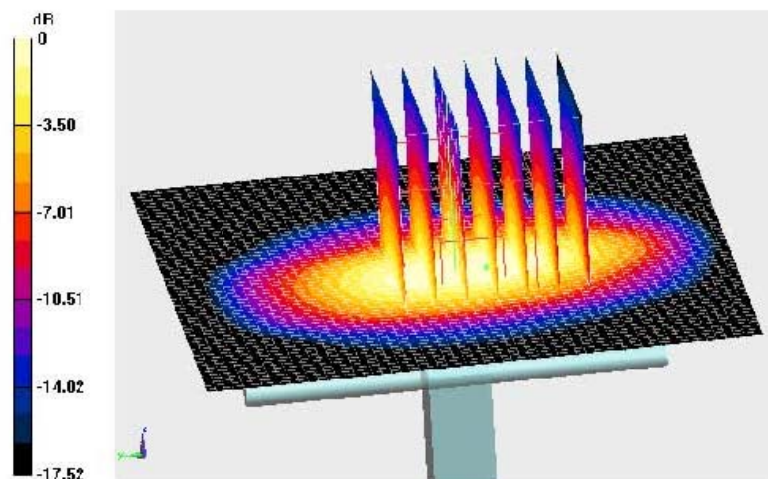

0 dB = 12.2 W/kg = 10.86 dB W/kg

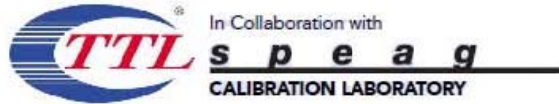

Add: No.51 Xueyuan Road, Haidian District, Beijing, 100191, China  
 Tel: +86-10-62304633-2079 Fax: +86-10-62304633-2504  
 E-mail: cttl@chinattl.com Http://www.chinattl.cn



**Impedance Measurement Plot for Head TSL**

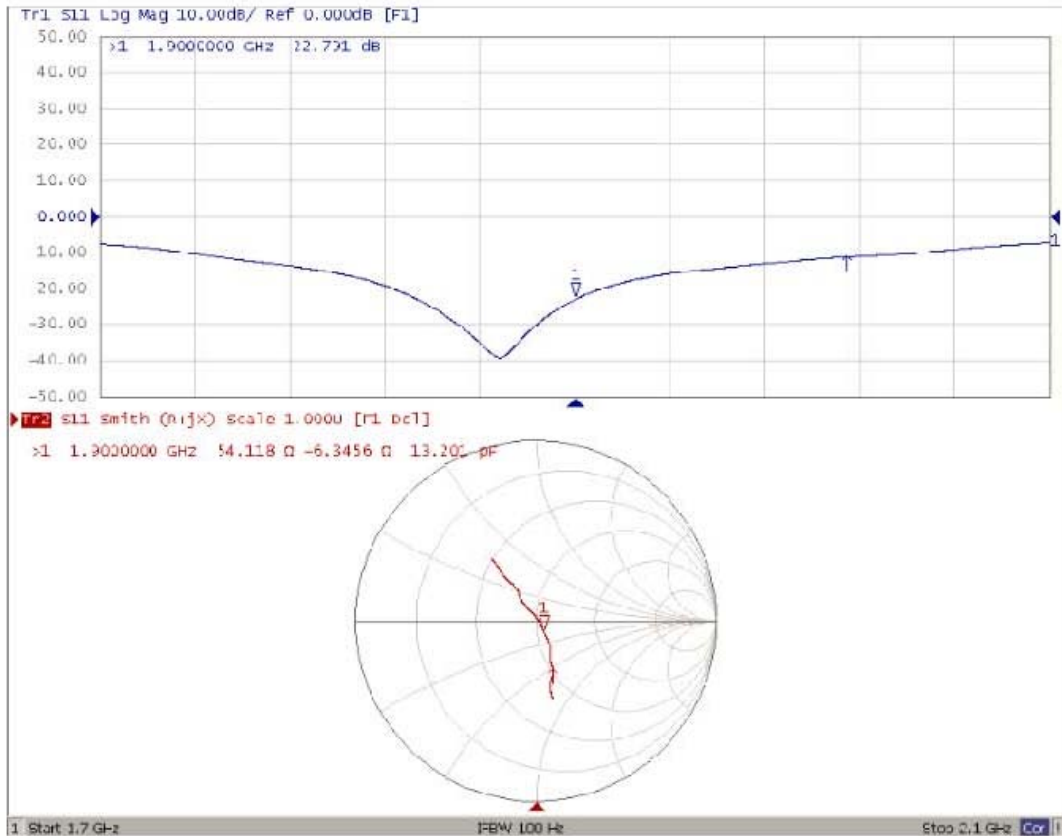





Add: No.51 Xueyuan Road, Haidian District, Beijing, 100191, China  
 Tel: +86-10-62304633-2079 Fax: +86-10-62304633-2504  
 E-mail: cttl@chinattl.com Http://www.chinattl.cn



**DASY5 Validation Report for Body TSL**

Date: 01.09.2014

Test Laboratory: CTTL, Beijing, China

**DUT: Dipole 1900 MHz; Type: D1900V2; Serial: D1900V2 - SN: 5d060**

Communication System: UID 0, CW, Frequency: 1900 MHz; Duty Cycle: 1:1

Medium parameters used:  $f = 1900 \text{ MHz}$ ;  $\sigma = 1.5 \text{ S/m}$ ;  $\epsilon_r = 51.78$ ;  $\rho = 1000 \text{ kg/m}^3$

Phantom section: Center Section

Measurement Standard: DASY5 (IEEE/IEC/ANSI C63.19-2007)

DASY5 Configuration:

- Probe: ES3DV3 - SN3149; ConvF(4.72, 4.72, 4.72); Calibrated: 2013-09-03;
- Sensor-Surface: 3mm (Mechanical Surface Detection)
- Electronics: DAE3 Sn536; Calibrated: 2014-01-23
- Phantom: Triple Flat Phantom 5.1C; Type: QD 000 P51 CA; Serial: 1161/2
- Measurement SW: DASY52, Version 52.8 (8); SEMCAD X Version 14.6.10 (7331)

**System Performance Check at Frequencies above 1 GHz/d=10mm, Pin=250 mW,**

**dist=3.0mm (ES-Probe)/Zoom Scan (7x7x7) (7x7x7)/Cube 0: Measurement grid:**

$dx=5\text{mm}$ ,  $dy=5\text{mm}$ ,  $dz=5\text{mm}$

Reference Value = 93.668 V/m; Power Drift = -0.01 dB

Peak SAR (extrapolated) = 17.6 W/kg

**SAR(1 g) = 9.98 W/kg; SAR(10 g) = 5.28 W/kg**

Maximum value of SAR (measured) = 12.6 W/kg

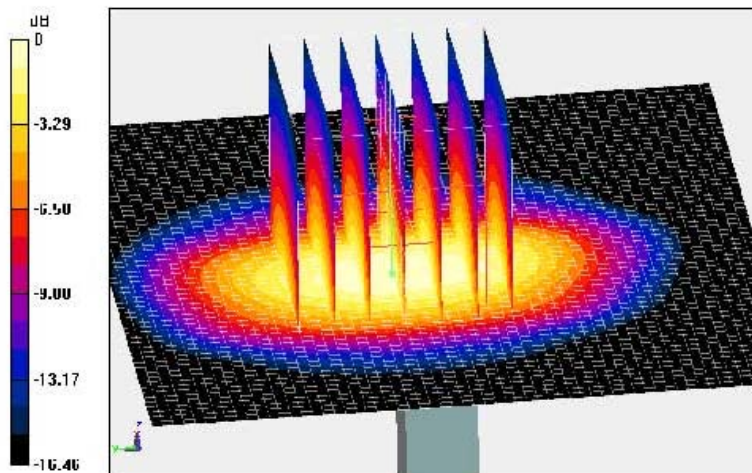

0 dB = 12.6 W/kg = 11.00 dB W/kg



Add: No.51 Xueyuan Road, Haidian District, Beijing, 100191, China  
Tel: +86-10-62304633-2079 Fax: +86-10-62304633-2504  
E-mail: cttl@chinattl.com Http://www.chinattl.cn



### Impedance Measurement Plot for Body TSL

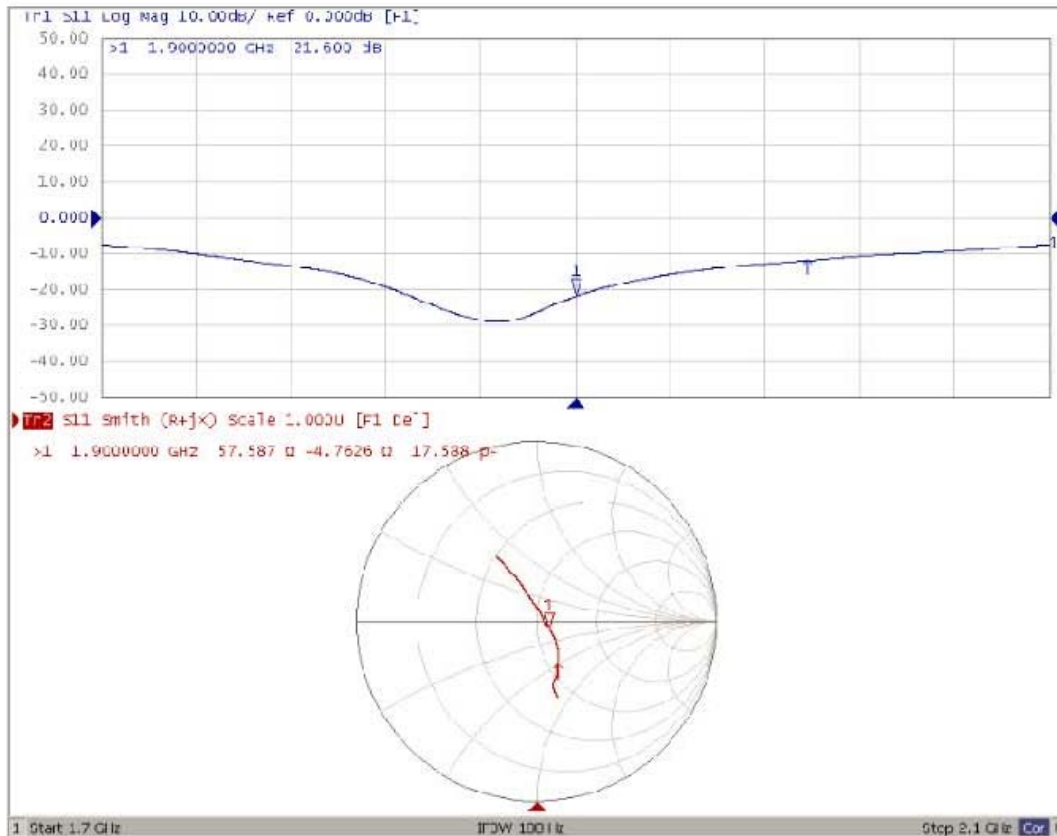



# ANNEX G: D2450V2 Dipole Calibration Certificate



In Collaboration with  
**s p e a g**  
CALIBRATION LABORATORY



Add: No.51 Xueyuan Road, Haidian District, Beijing, 100191, China  
Tel: +86-10-62304633-2079 Fax: +86-10-62304633-2504  
E-mail: cttl@chinattl.com Http://www.chinattl.cn

Client **TA(Shanghai)** Certificate No: **Z14-97075**

## CALIBRATION CERTIFICATE

Object: **D2450V2 - SN: 786**

Calibration Procedure(s): **TMC-OS-E-02-194**  
**Calibration procedure for dipole ventication kits**

Calibration date: **September 1, 2014**

This calibration Certificate documents the traceability to national standards, which realize the physical units of measurements(SI). The measurements and the uncertainties with confidence probability are given on the following pages and are part of the certificate.

All calibrations have been conducted in the closed laboratory facility: environment temperature(22±3)°C and humidity<70%.

Calibration Equipment used (M&TE critical for calibration)

Primary Standards	ID #	Cal Date(Calibrated by, Certificate No.)	Scheduled Calibration
Power Meter NRVD	102083	11-Sep-13 (TMC, No.JZ13-443)	Sep-14
Power sensor NRV-Z5	100595	11-Sep-13 (TMC, No. JZ13-443)	Sep -14
Reference Probe ES3DV3	SN 3149	5- Sep-13 (SPEAG, No.ES3-3149_Sep13)	Sep-14
DAE3	SN 536	23-Jan-14 (SPEAG, DAE3-536_Jan14)	Jan -15
Signal Generator E4438C	MY49070393	13-Nov-13 (TMC, No.JZ13-394)	Nov-14
Network Analyzer E8362B	MY43021135	19-Oct-13 (TMC, No.JZ13-278)	Oct-14

	Name	Function	Signature
Calibrated by:	Zhao Jing	SAR Test Engineer	
Reviewed by:	Ci Dianyuan	SAR Project Leader	
Approved by:	Lu Bingsong	Deputy Director of the laboratory	

Issued: September 4, 2014

This calibration certificate shall not be reproduced except in full without written approval of the laboratory.



Add: No.51 Xueyuan Road, Haidian District, Beijing, 100191, China  
Tel: +86-10-62304633-2079 Fax: +86-10-62304633-2504  
E-mail: cttl@chinattl.com Http://www.chinattl.cn

**Glossary:**

TSL	tissue simulating liquid
ConyF	sensitivity in TSL / NORM <sub>x,y,z</sub>
N/A	not applicable or not measured

**Calibration is Performed According to the Following Standards:**

- IEEE Std 1528-2013, "IEEE Recommended Practice for Determining the Peak Spatial-Averaged Specific Absorption Rate (SAR) in the Human Head from Wireless Communications Devices: Measurement Techniques", June 2013
- IEC 62209-1, "Procedure to measure the Specific Absorption Rate (SAR) For hand-held devices used in close proximity to the ear (frequency range of 300MHz to 3GHz)", February 2005
- KDB865664, SAR Measurement Requirements for 100 MHz to 6 GHz

**Additional Documentation:**

- DASY4/5 System Handbook

**Methods Applied and Interpretation of Parameters:**

- Measurement Conditions:* Further details are available from the Validation Report at the end of the certificate. All figures stated in the certificate are valid at the frequency indicated.
- Antenna Parameters with TSL:* The dipole is mounted with the spacer to position its feed point exactly below the center marking of the flat phantom section, with the arms oriented parallel to the body axis.
- Feed Point Impedance and Return Loss:* These parameters are measured with the dipole positioned under the liquid filled phantom. The impedance stated is transformed from the measurement at the SMA connector to the feed point. The Return Loss ensures low reflected power. No uncertainty required.
- Electrical Delay:* One-way delay between the SMA connector and the antenna feed point. No uncertainty required.
- SAR measured:* SAR measured at the stated antenna input power.
- SAR normalized:* SAR as measured, normalized to an input power of 1 W at the antenna connector.
- SAR for nominal TSL parameters:* The measured TSL parameters are used to calculate the nominal SAR result.

The reported uncertainty of measurement is stated as the standard uncertainty of Measurement multiplied by the coverage factor  $k=2$ , which for a normal distribution corresponds to a coverage probability of approximately 95%.



Add: No.51 Xueyuan Road, Haidian District, Beijing, 100191, China  
 Tel: +86-10-62304633-2079 Fax: +86-10-62304633-2504  
 E-mail: ttl@chinattl.com Http://www.chinattl.cn



**Measurement Conditions**

DASY system configuration, as far as not given on page 1.

<b>DASY Version</b>	DASY52	52.8.8.1222
<b>Extrapolation</b>	Advanced Extrapolation	
<b>Phantom</b>	Triple Flat Phantom 5.1C	
<b>Distance Dipole Center - TSL</b>	10 mm	with Spacer
<b>Zoom Scan Resolution</b>	dx, dy, dz = 5 mm	
<b>Frequency</b>	2450 MHz ± 1 MHz	

**Head TSL parameters**

The following parameters and calculations were applied.

	Temperature	Permittivity	Conductivity
<b>Nominal Head TSL parameters</b>	22.0 °C	39.2	1.80 mho/m
<b>Measured Head TSL parameters</b>	(22.0 ± 0.2) °C	40.2 ± 6 %	1.84 mho/m ± 6 %
<b>Head TSL temperature change during test</b>	<1.0 °C	----	----

**SAR result with Head TSL**

<b>SAR averaged over 1 cm<sup>3</sup> (1 g) of Head TSL</b>	Condition	
SAR measured	250 mW input power	13.2 mW / g
SAR for nominal Head TSL parameters	normalized to 1W	<b>52.5 mW/g ± 20.8 % (k=2)</b>
<b>SAR averaged over 10 cm<sup>3</sup> (10 g) of Head TSL</b>	Condition	
SAR measured	250 mW input power	6.20 mW / g
SAR for nominal Head TSL parameters	normalized to 1W	<b>24.8 mW/g ± 20.4 % (k=2)</b>

**Body TSL parameters**

The following parameters and calculations were applied.

	Temperature	Permittivity	Conductivity
<b>Nominal Body TSL parameters</b>	22.0 °C	52.7	1.95 mho/m
<b>Measured Body TSL parameters</b>	(22.0 ± 0.2) °C	51.3 ± 6 %	2.00 mho/m ± 6 %
<b>Body TSL temperature change during test</b>	<1.0 °C	----	----

**SAR result with Body TSL**

<b>SAR averaged over 1 cm<sup>3</sup> (1 g) of Body TSL</b>	Condition	
SAR measured	250 mW input power	13.3 mW / g
SAR for nominal Body TSL parameters	normalized to 1W	<b>52.4 mW/g ± 20.8 % (k=2)</b>
<b>SAR averaged over 10 cm<sup>3</sup> (10 g) of Body TSL</b>	Condition	
SAR measured	250 mW input power	6.20 mW / g
SAR for nominal Body TSL parameters	normalized to 1W	<b>24.6 mW/g ± 20.4 % (k=2)</b>



Add: No.51 Xueyuan Road, Haidian District, Beijing, 100191, China  
 Tel: +86-10-62304633-2079 Fax: +86-10-62304633-2504  
 E-mail: ttl@chinattl.com Http://www.chinattl.cn



**Appendix**

**Antenna Parameters with Head TSL**

Impedance, transformed to feed point	57.1Ω- 0.57jΩ
Return Loss	- 23.6dB

**Antenna Parameters with Body TSL**

Impedance, transformed to feed point	56.0Ω+3.31jΩ
Return Loss	- 23.7dB

**General Antenna Parameters and Design**

Electrical Delay (one direction)	1.192 ns
----------------------------------	----------

After long term use with 100W radiated power, only a slight warming of the dipole near the feedpoint can be measured.

The dipole is made of standard semirigid coaxial cable. The center conductor of the feeding line is directly connected to the second arm of the dipole. The antenna is therefore short-circuited for DC-signals. On some of the dipoles, small end caps are added to the dipole arms in order to improve matching when loaded according to the position as explained in the "Measurement Conditions" paragraph. The SAR data are not affected by this change. The overall dipole length is still according to the Standard.

No excessive force must be applied to the dipole arms, because they might bend or the soldered connections near the feedpoint may be damaged.

**Additional EUT Data**

Manufactured by	SPEAG
-----------------	-------



Add: No.51 Xueyuan Road, Haidian District, Beijing, 100191, China  
 Tel: +86-10-62304633-2079 Fax: +86-10-62304633-2504  
 E-mail: cttl@chinattl.com Http://www.chinattl.cn



**DASY5 Validation Report for Head TSL**

Date: 01.09.2014

Test Laboratory: CTTL, Beijing, China

**DUT: Dipole 2450 MHz; Type: D2450V2; Serial: D2450V2 - SN: 786**

Communication System: UID 0, CW; Frequency: 2450 MHz; Duty Cycle: 1:1

Medium parameters used:  $f = 2450 \text{ MHz}$ ;  $\sigma = 1.84 \text{ S/m}$ ;  $\epsilon_r = 40.2$ ;  $\rho = 1000 \text{ kg/m}^3$

Phantom section: Left Section

Measurement Standard: DASY5 (IEEE/IEC/ANSI C63.19-2007)

DASY5 Configuration:

- Probe: ES3DV3 - SN3149; ConvF(4.48, 4.48, 4.48); Calibrated: 2013-09-05;
- Sensor-Surface: 3mm (Mechanical Surface Detection)
- Electronics: DAE3 Sn536; Calibrated: 2014-01-23
- Phantom: Triple Flat Phantom 5.1C; Type: QD 000 P51 CA; Serial: 1161/1
- Measurement SW: DASY52, Version 52.8 (8); SEMCAD X Version 14.6.10 (7331)

**System Performance Check at Frequencies above 1 GHz/d=10mm, Pin=250 mW,**

**dist=3.0mm (ES-Probe)/Zoom Scan (7x7x7) (7x7x7)/Cube 0: Measurement grid:**

$dx=5\text{mm}$ ,  $dy=5\text{mm}$ ,  $dz=5\text{mm}$

Reference Value = 99.583 V/m; Power Drift = -0.08 dB

Peak SAR (extrapolated) = 26.6 W/kg

**SAR(1 g) = 13.2 W/kg; SAR(10 g) = 6.2 W/kg**

Maximum value of SAR (measured) = 17.3 W/kg

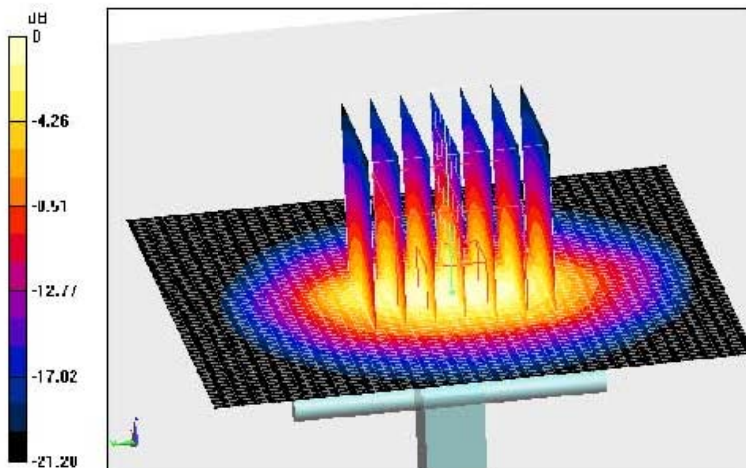

0 dB = 17.3 W/kg = 12.38 dBW/kg

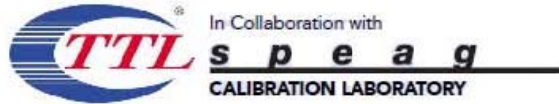

Add: No.51 Xueyuan Road, Haidian District, Beijing, 100191, China  
Tel: +86-10-62304633-2079 Fax: +86-10-62304633-2504  
E-mail: ttl@chinattl.com Http://www.chinattl.cn



### Impedance Measurement Plot for Head TSL

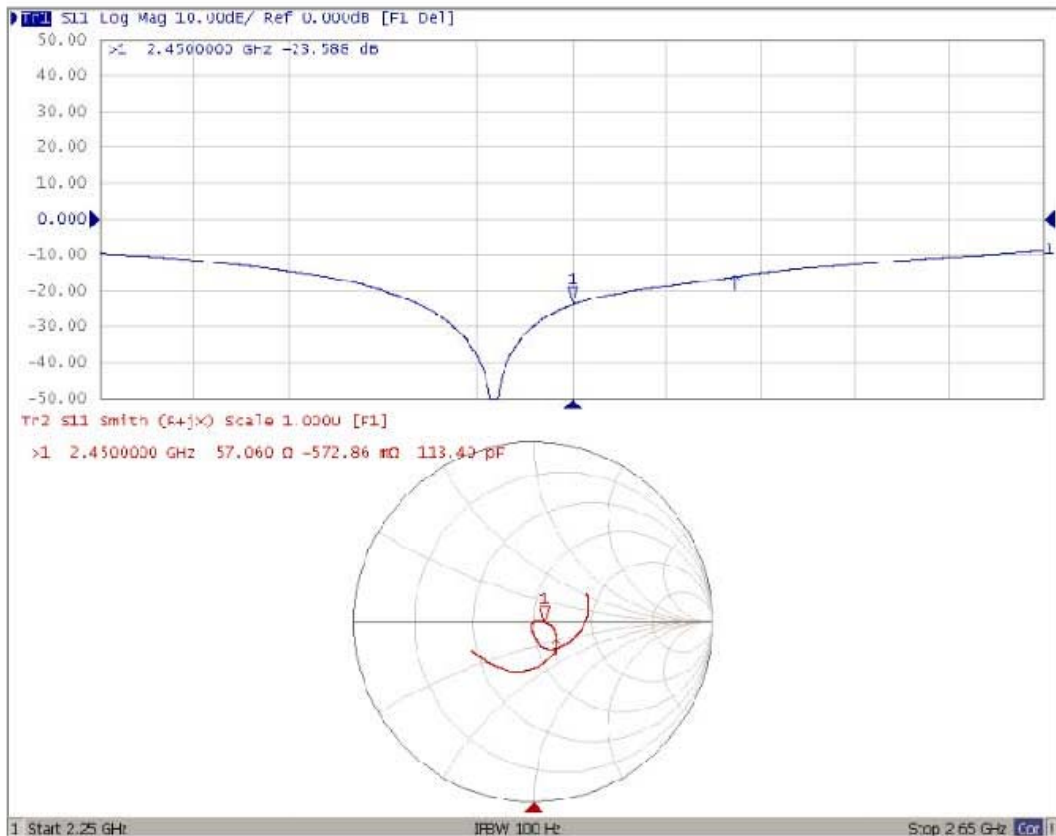





Add: No.51 Xueyuan Road, Haidian District, Beijing, 100191, China  
 Tel: +86-10-62304633-2079 Fax: +86-10-62304633-2504  
 E-mail: cttl@chinattl.com Http://www.chinattl.cn



**DASY5 Validation Report for Body TSL**

Date: 01.09.2014

Test Laboratory: CTTL, Beijing, China

**DUT: Dipole 2450 MHz; Type: D2450V2; Serial: D2450V2 - SN: 786**

Communication System: UID 0, CW, Frequency: 2450 MHz; Duty Cycle: 1:1

Medium parameters used:  $f = 2450 \text{ MHz}$ ;  $\sigma = 1.988 \text{ S/m}$ ;  $\epsilon_r = 51.25$ ;  $\rho = 1000 \text{ kg/m}^3$

Phantom section: Center Section

Measurement Standard: DASY5 (IEEE/IEC/ANSI C63.19-2007)

DASY5 Configuration:

- Probe: ES3DV3 - SN3149; ConvF(4.21, 4.21, 4.21); Calibrated: 2013-09-03;
- Sensor-Surface: 3mm (Mechanical Surface Detection)
- Electronics: DAE3 Sn536; Calibrated: 2014-01-23
- Phantom: Triple Flat Phantom 5.1C; Type: QD 000 P51 CA; Serial: 1161/2
- Measurement SW: DASY52, Version 52.8 (8); SEMCAD X Version 14.6.10 (7331)

**System Performance Check at Frequencies above 1 GHz/d=10mm, Pin=250 mW,**

**dist=3.0mm (ES-Probe)/Zoom Scan (7x7x7) (7x7x7)/Cube 0: Measurement grid:**

$dx=5\text{mm}$ ,  $dy=5\text{mm}$ ,  $dz=5\text{mm}$

Reference Value = 97.120 V/m; Power Drift = -0.05 dB

Peak SAR (extrapolated) = 27.8 W/kg

**SAR(1 g) = 13.3 W/kg; SAR(10 g) = 6.2 W/kg**

Maximum value of SAR (measured) = 17.7 W/kg

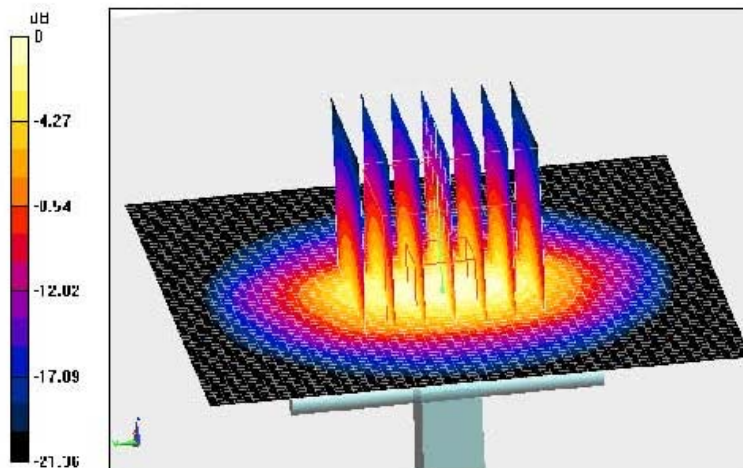

0 dB = 17.7 W/kg = 12.48 dBW/kg



Add: No.51 Xueyuan Road, Haidian District, Beijing, 100191, China  
Tel: +86-10-62304633-2079 Fax: +86-10-62304633-2504  
E-mail: cttl@chinattl.com Http://www.chinattl.cn



### Impedance Measurement Plot for Body TSL

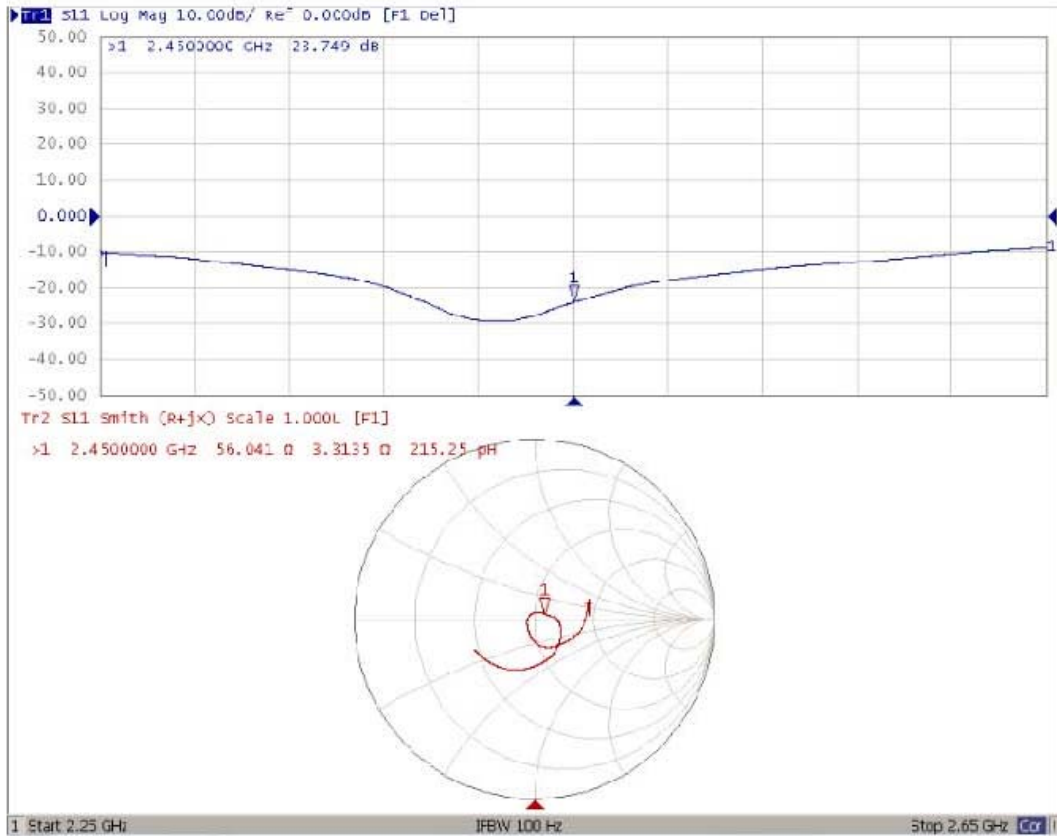



# ANNEX H: DAE4 Calibration Certificate

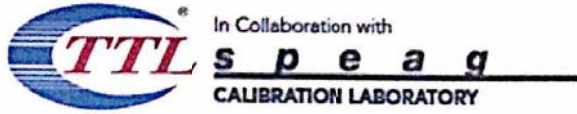

Add: No.51 Xueyuan Road, Haidian District, Beijing, 100191, China  
Tel: +86-10-62304633-2218 Fax: +86-10-62304633-2209  
E-mail: cttl@chinattl.com Http://www.chinattl.cn



Client : TA(Shanghai)

Certificate No: Z15-97194

## CALIBRATION CERTIFICATE

Object: DAE4 - SN: 871

Calibration Procedure(s): FD-Z11-2-002-01  
Calibration Procedure for the Data Acquisition Electronics (DAEx)

Calibration date: November 17, 2015

This calibration Certificate documents the traceability to national standards, which realize the physical units of measurements(SI). The measurements and the uncertainties with confidence probability are given on the following pages and are part of the certificate.

All calibrations have been conducted in the closed laboratory facility: environment temperature(22±3)°C and humidity<70%.

Calibration Equipment used (M&TE critical for calibration)

Primary Standards	ID #	Cal Date(Calibrated by, Certificate No.)	Scheduled Calibration
Process Calibrator 753	1971018	06-July-15 (CTTL, No:J15X04257)	July-16

	Name	Function	Signature
Calibrated by:	Yu Zongying	SAR Test Engineer	
Reviewed by:	Qi Dianyuan	SAR Project Leader	
Approved by:	Lu Bingsong	Deputy Director of the laboratory	

Issued: November 18, 2015

This calibration certificate shall not be reproduced except in full without written approval of the laboratory.

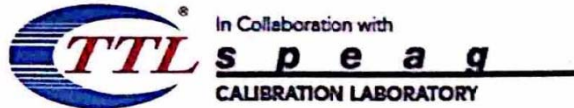

Add: No.51 Xueyuan Road, Haidian District, Beijing, 100191, China  
Tel: +86-10-62304633-2218 Fax: +86-10-62304633-2209  
E-mail: [ctl@chinattl.com](mailto:ctl@chinattl.com) Http://[www.chinattl.cn](http://www.chinattl.cn)

**Glossary:**

DAE data acquisition electronics  
Connector angle information used in DASY system to align probe sensor X to the robot coordinate system.

**Methods Applied and Interpretation of Parameters:**

- *DC Voltage Measurement:* Calibration Factor assessed for use in DASY system by comparison with a calibrated instrument traceable to national standards. The figure given corresponds to the full scale range of the voltmeter in the respective range.
- *Connector angle:* The angle of the connector is assessed measuring the angle mechanically by a tool inserted. Uncertainty is not required.
- The report provide only calibration results for DAE, it does not contain other performance test results.

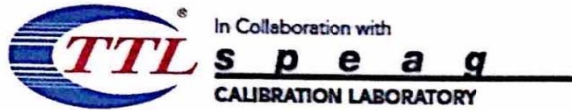

Add: No.51 Xueyuan Road, Haidian District, Beijing, 100191, China  
Tel: +86-10-62304633-2218 Fax: +86-10-62304633-2209  
E-mail: cttl@chinattl.com Http://www.chinattl.cn

### DC Voltage Measurement

A/D - Converter Resolution nominal

High Range: 1LSB = 6.1 $\mu$ V, full range = -100...+300 mV

Low Range: 1LSB = 61nV, full range = -1.....+3mV

DASY measurement parameters: Auto Zero Time: 3 sec; Measuring time: 3 sec

Calibration Factors	X	Y	Z
High Range	404.728 $\pm$ 0.15% (k=2)	404.712 $\pm$ 0.15% (k=2)	405.156 $\pm$ 0.15% (k=2)
Low Range	3.98308 $\pm$ 0.7% (k=2)	3.93782 $\pm$ 0.7% (k=2)	3.97048 $\pm$ 0.7% (k=2)

### Connector Angle

Connector Angle to be used in DASY system	90.5 $^{\circ}$ $\pm$ 1 $^{\circ}$
---	------------------------------------

## ANNEX I: The EUT Appearances and Test Configuration



Front Side



Back Side  
a: EUT



b: Battery



c: Earphone

Picture 9: Constituents of EUT



Picture 10: Left Hand Touch Cheek Position



Picture 11: Left Hand Tilt 15 Degree Position





Picture 12: Right Hand Touch Cheek Position



Picture 13: Right Hand Tilt 15 Degree Position



Picture 14: Back Side, the distance from handset to the bottom of the Phantom is 10mm



Picture 15: Front Side, the distance from handset to the bottom of the Phantom is 10mm



Picture 16: Left Side, the distance from handset to the bottom of the Phantom is 10mm



Picture 17: Right Side, the distance from handset to the bottom of the Phantom is 10mm



Picture 18: Top Side, the distance from handset to the bottom of the Phantom is 10mm



Picture 19: Bottom Side, the distance from handset to the bottom of the Phantom is 10mm

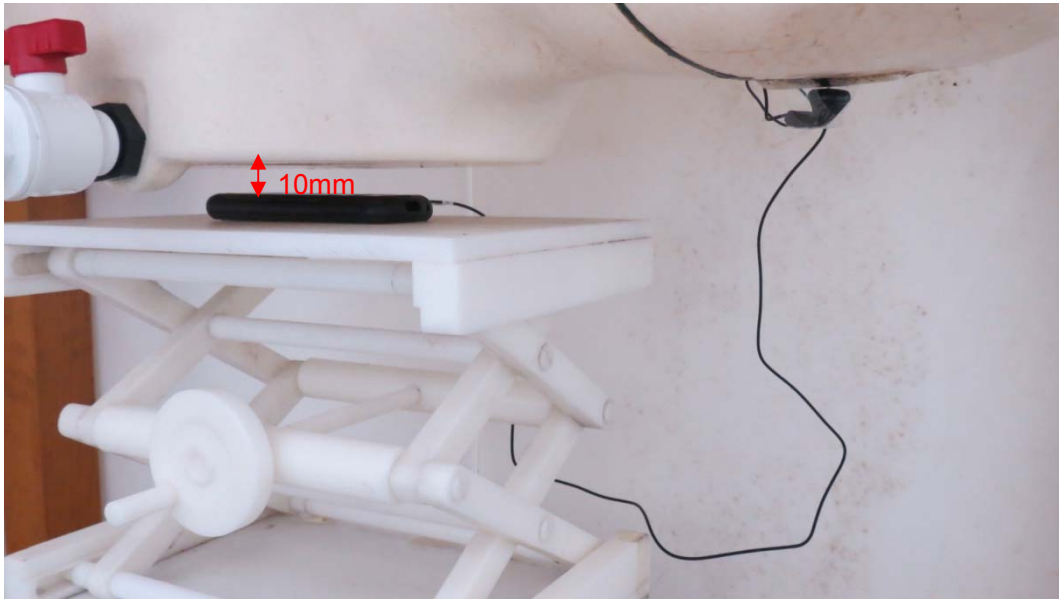

Picture 20: Back Side with Earphone, the distance from handset to the bottom of the Phantom is 10mm