



TEST REPORT

No. I17D00003-SAR

For

Client: Mobewire SAS

Production: Connected mobile with printer

Model Name: Mobiprint3

FCC ID: QPN-3Q-MOBIPRINT3

Hardware Version: V02

Software Version: V03

Issued date: 2017-7-17

Note:

The test results in this test report relate only to the devices specified in this report. This report shall not be reproduced except in full without the written approval of ECIT Shanghai.

Test Laboratory:

ECIT Shanghai, East China Institute of Telecommunications

Add: 7-8F, G Area, No.668, Beijing East Road, Huangpu District, Shanghai, P. R. China

Tel: (+86)-021-63843300, E-Mail: welcome@ecit.org.cn

Revision Version

Report Number	Revision	Date	Memo
I17D00003-SAR	00	2017-7-17	Initial creation of test report

CONTENTS

1.	TEST LABORATORY	6
1.1.	TESTING LOCATION	6
1.2.	TESTING ENVIRONMENT	6
1.3.	PROJECT DATA	6
1.4.	SIGNATURE.....	6
2.	STATEMENT OF COMPLIANCE.....	7
3.	CLIENT INFORMATION	9
3.1.	APPLICANT INFORMATION.....	9
3.2.	MANUFACTURER INFORMATION.....	9
4.	EQUIPMENT UNDER TEST (EUT) AND ANCILLARY EQUIPMENT (AE).....	10
4.1.	ABOUT EUT.....	10
4.2.	INTERNAL IDENTIFICATION OF EUT USED DURING THE TEST	11
4.3.	INTERNAL IDENTIFICATION OF AE USED DURING THE TEST.....	11
5.	TEST METHODOLOGY.....	12
5.1.	APPLICABLE LIMIT REGULATIONS.....	12
5.2.	APPLICABLE MEASUREMENT STANDARDS	12
6.	SPECIFIC ABSORPTION RATE (SAR)	13
6.1.	INTRODUCTION	13
6.2.	SAR DEFINITION.....	13
7.	TISSUE SIMULATING LIQUIDS.....	14
7.1.	TARGETS FOR TISSUE SIMULATING LIQUID	14
7.2.	DIELECTRIC PERFORMANCE.....	14
8.	SYSTEM VERIFICATION.....	17
8.1.	SYSTEM SETUP	17
8.2.	SYSTEM VERIFICATION.....	17
9.	MEASUREMENT PROCEDURES.....	19

9.1.	TESTS TO BE PERFORMED.....	19
9.2.	GENERAL MEASUREMENT PROCEDURE	20
9.3.	WCDMA MEASUREMENT PROCEDURES FOR SAR	21
9.4.	SAR MEASUREMENT FOR LTE	23
9.5.	BLUETOOTH & WI-FI MEASUREMENT PROCEDURES FOR SAR	24
9.6.	POWER DRIFT	25
10.	AREA SCAN BASED 1-G SAR.....	26
11.	CONDUCTED OUTPUT POWER	27
11.1.	MANUFACTURING TOLERANCE	27
11.2.	GSM MEASUREMENT RESULT.....	31
11.3.	WCDMA MEASUREMENT RESULT.....	32
11.4.	WI-FI AND BT MEASUREMENT RESULT.....	33
12.	SIMULTANEOUS TX SAR CONSIDERATIONS	36
12.1.	INTRODUCTION	36
12.2.	TRANSMIT ANTENNA SEPARATION DISTANCES	36
13.	EVALUATION OF SIMULTANEOUS	39
14.	SAR TEST RESULT.....	42
15.	SAR MEASUREMENT VARIABILITY	49
16.	MEASUREMENT UNCERTAINTY.....	50
17.	MAIN TEST INSTRUMENT	51
ANNEX A.	GRAPH RESULTS.....	52
ANNEX B.	SYSTEM VALIDATION RESULTS	63
ANNEX C.	SAR MEASUREMENT SETUP	66
ANNEX D.	POSITION OF THE WIRELESS DEVICE IN RELATION TO THE PHANTOM	75
ANNEX E.	EQUIVALENT MEDIA RECIPES.....	77
ANNEX F.	SYSTEM VALIDATION	78
ANNEX G.	PROBE AND DAE CALIBRATION CERTIFICATE	80

ANNEX F. ACCREDITATION CERTIFICATE 129

1. Test Laboratory

1.1. Testing Location

Company Name:	ECIT Shanghai, East China Institute of Telecommunications
Address:	7-8F, G Area, No. 668, Beijing East Road, Huangpu District, Shanghai, P. R. China
Postal Code:	200001
Telephone:	(+86)-021-63843300
Fax:	(+86)-021-63843301

1.2. Testing Environment

Normal Temperature:	18-25°C
Relative Humidity:	30-70%
Ambient noise & Reflection:	< 0.012 W/kg

1.3. Project Data

Project Leader:	Yu Anlu
Testing Start Date:	2017-7-10
Testing End Date:	2017-7-12

1.4. Signature



Yan Hang
(Prepared this test report)



Song Kaihua
(Reviewed this test report)

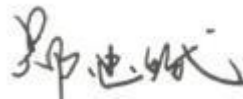

Zheng Zhongbin
Director of the laboratory
(Approved this test report)

2. Statement of Compliance

The maximum results of Specific Absorption Rate (SAR) found during testing for **Mobiprint3** are as follows (with expanded uncertainty 22.4%)

Table 2.1: Max. Reported SAR (10g)

Band	Position	SAR 10g (W/Kg)
GSM 850	Body 0mm	0.494
GSM 1900	Body 0mm	0.993
WCDMA Band2	Body 0mm	1.086
WCDMA Band5	Body 0mm	0.364
Wi-Fi	Body 0mm	0.256

Table 2.2: Max. Reported SAR (1g)

Band	Position	SAR 1g (W/Kg)
GSM 850	Body 5mm	0.509
GSM 1900	Body 5mm	0.931
WCDMA Band2	Body 5mm	0.594
WCDMA Band5	Body 5mm	0.236
Wi-Fi	Body 5mm	0.242

The SAR values found for the EUT are below the maximum recommended levels of 1.6 W/Kg as averaged over any 1g tissue and 4.0 W/Kg as averaged over any 10g tissue according to the ANSI C95.1:1999.

For body worn operation, this device has been tested and meets FCC RF exposure guidelines when used with any accessory that contains no metal. Use of other accessories may not ensure compliance with FCC RF exposure guidelines.

The measurement together with the test system set-up is described in chapter 7 of this test report. A detailed description of the equipment under test can be found in chapter 3 of this test report.

The sample has Two antennas. One is main antenna for GSM/WCDMA, and the other is for WiFi/BT. So simultaneous transmission is GSM/WCDMA and WiFi/BT.

Table 2.3: Simultaneous SAR (1g)

Transmission SAR(W/Kg)						
Test Position		2G	3G	WIFI	BT	SUM
Body 0mm	Phantom Side	0.281	0.274	0.030	0.167	0.448
	Ground Side	0.493	0.571	0.024	0.167	0.738
	Ground Tilt Side	0.993	1.086	--	0.167	1.253
	Left Side	0.530	0.708	---	0.167	0.875
	Right Side	0.494	0.364	0.256	0.167	0.750
	Bottom Side	0.436	0.435	--	0.167	0.603
	Top Side	--	--	--	0.167	0.167
Body 5mm	Phantom Side	0.395	0.294	0.022	0.167	0.562
	Ground Side	0.608	0.562	0.024	0.167	0.775
	Ground Tilt Side	0.931	0.594	--	0.167	1.098
	Left Side	0.622	0.577	--	0.167	0.789
	Right Side	0.509	0.287	0.242	0.167	0.751
	Bottom Side	0.465	0.160	--	0.167	0.632
	Top Side	--	--	--	0.167	0.167

According to the above table, the maximum sum of reported SAR values for GSM/WCDMA and WiFi is **1.253 W/kg** (10g); **1.098 W/kg** (1g). The detail for simultaneous transmission consideration is described in chapter 12.

3. Client Information

3.1. Applicant Information

Company Name: Mobiwire SAS
Address: 79 AVENUE FRANCOIS ARAGO 92017 NANTERRE CEDEX France.
Email: di.ai@mobiwire.com

3.2. Manufacturer Information

Company Name: MOBIWIRE MOBILES (NINGBO) CO.,LTD
Address: No.999,Dacheng East Road,Fenghua City,Zhejiang
Email: Linzhong.xu@mobiwire.com.cn

4. Equipment Under Test (EUT) and Ancillary Equipment (AE)

4.1. About EUT

Description:	Connected mobile with printer
Model name:	Mobiprint3
Operation Model(s):	GSM850/1900,WCDMA Band II/V,WIFI2450
Tx Frequency:	824.2-848.8MHz(GSM850) 1850.2-1909.8MHz (GSM1900) 1852.4-1907.6 MHz (WCDMA Band II) 826.4-846.6MHz (WCDMA Band V) 2412- 2472 MHz (Wi-Fi) 2400-2483.5 MHz (BT)
Test device Production information:	Production unit
GPRS/EGPRS Class Mode:	B
GPRS/ EGPRS Multislot Class:	12
Device type:	Portable device
UE category:	3
Antenna type:	Inner antenna
Accessories/Body-worn configurations:	Battery
Dimensions:	18cm×7.2cm×6.5cm
Hotspot Mode:	Support simultaneous transmission of hotspot and data
FCC ID:	QPN-3Q-MOBIPRINT3

4.2. Internal Identification of EUT used during the test

EUT ID*	SN or IMEI	HW Version	SW Version	Receive Date
N05	353007061648232 353007061648240	V02	V03	2017-01-06

*EUT ID: is used to identify the test sample in the lab internally.

4.3. Internal Identification of AE used during the test

AE ID*	Description	Model	SN	Manufacturer
B08	N/A	N/A	JDMP316264017536	N/A

*AE ID: is used to identify the test sample in the lab internally.

5. TEST METHODOLOGY

5.1. Applicable Limit Regulations

ANSI C95.1–1999: IEEE Standard for Safety Levels with Respect to Human Exposure to Radio Frequency Electromagnetic Fields, 3 kHz to 300 GHz.

It specifies the maximum exposure limit of **1.6 W/kg** as averaged over any 1 gram of tissue and **4.0 W/kg** as averaged over any 10 gram of tissue for portable devices being used within 20 cm of the user in the uncontrolled environment.

5.2. Applicable Measurement Standards

IEEE 1528–2013: Recommended Practice for Determining the Peak Spatial-Average Specific Absorption Rate (SAR) in the Human Body Due to Wireless Communications Devices: Experimental Techniques.

KDB248227 D01 802.11 Wi-Fi SAR v02r02: SAR measurement procedures for 802.112abg transmitters.

KDB447498 D01 General RF Exposure Guidance v06: Mobile and Portable Devices RF Exposure Procedures and Equipment Authorization Policies.

KDB865664 D01 SAR Measurement 100 MHz to 6 GHz v01r04: SAR Measurement Requirements for 100 MHz to 6 GHz

KDB865664 D02 RF Exposure Reporting v01r02: provides general reporting requirements as well as certain specific information required to support MPE and SAR compliance.

KDB941225 D01 3G SAR Procedures v03r01: 3G SAR Measurement Procedures.

NOTE: KDB is not in A2LA Scope List.

6. Specific Absorption Rate (SAR)

6.1. Introduction

SAR is related to the rate at which energy is absorbed per unit mass in an object exposed to a radio field. The SAR distribution in a biological body is complicated and is usually carried out by experimental techniques or numerical modeling. The standard recommends limits for two tiers of groups, occupational/controlled and general population/uncontrolled, based on a person's awareness and ability to exercise control over his or her exposure. In general, occupational/controlled exposure limits are higher than the limits for general population/uncontrolled.

6.2. SAR Definition

The SAR definition is the time derivative (rate) of the incremental energy (dW) absorbed by (dissipated in) an incremental mass (dm) contained in a volume element (dv) of a given density (ρ). The equation description is as below:

$$SAR = \frac{d}{dt} \left(\frac{dW}{dm} \right) = \frac{d}{dt} \left(\frac{dW}{\rho dv} \right)$$

SAR is expressed in units of Watts per kilogram (W/kg)

SAR measurement can be either related to the temperature elevation in tissue by

$$SAR = c \left(\frac{\delta T}{\delta t} \right)$$

Where: C is the specific heat capacity, δT is the temperature rise and δt is the exposure duration, or related to the electrical field in the tissue by

$$SAR = \frac{\sigma |E|^2}{\rho}$$

Where: σ is the conductivity of the tissue, ρ is the mass density of tissue and E is the RMS electrical field strength.

However for evaluating SAR of low power transmitter, electrical field measurement is typically applied.

7. Tissue Simulating Liquids

7.1. Targets for tissue simulating liquid

Table 7.1: Targets for tissue simulating liquid

Frequency (MHz)	Liquid Type	Conductivity(σ)	$\pm 5\%$ Range	Permittivity(ϵ)	$\pm 5\%$ Range
835	Body	0.97	0.92~1.02	55.2	52.4~58.0
1900	Body	1.52	1.44~1.60	53.3	50.6~56.0
2450	Body	1.95	1.85~2.05	52.7	50.1~55.3

7.2. Dielectric Performance

Table 7.2: Dielectric Performance of Tissue Simulating Liquid

Measurement Value						
Liquid Temperature: 22.5 °C						
Type	Frequency	Permittivity ϵ	Drift (%)	Conductivity σ	Drift (%)	Test Date
Body	835 MHz	57.108	3.46%	1.001	3.09%	2017-07-10
Body	1900 MHz	53.237	-0.12%	1.524	0.26%	2017-07-11
Body	2450 MHz	52.879	0.34%	1.978	1.44%	2017-07-12



Picture 7-1: Liquid depth in the Flat Phantom (835 MHz Body)

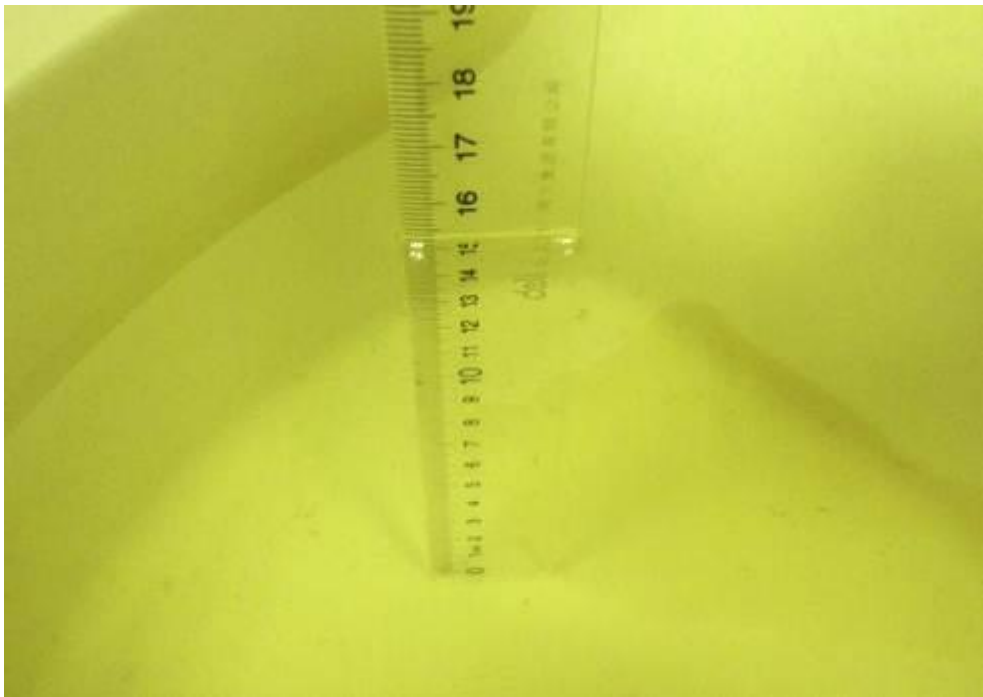

Picture 7-2: Liquid depth in the Flat Phantom (1900 MHz Body)

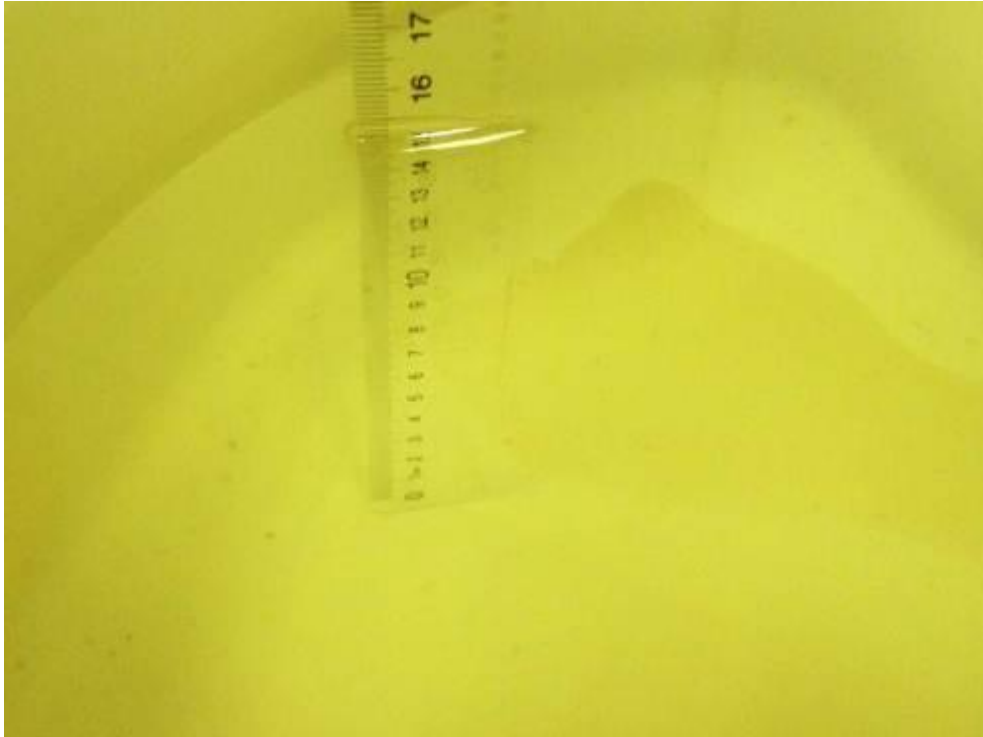

Picture 7-3: Liquid depth in the Flat Phantom (2450 MHz Body)

8. System verification

8.1. System Setup

In the simplified setup for system evaluation, the DUT is replaced by a calibrated dipole and the power source is replaced by a continuous wave that comes from a signal generator. The calibrated dipole must be placed beneath the flat phantom section of the SAM twin phantom with the correct distance holder. The distance holder should touch the phantom surface with a light pressure at the reference marking and be oriented parallel to the long side of the phantom. The equipment setup is shown below:

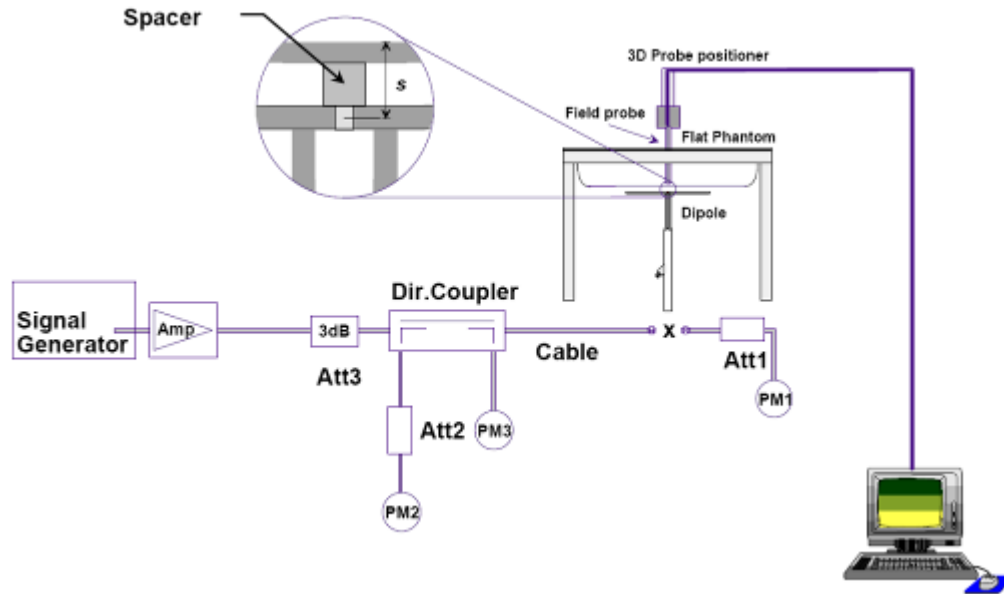

Picture 8.1 System Setup for System Evaluation

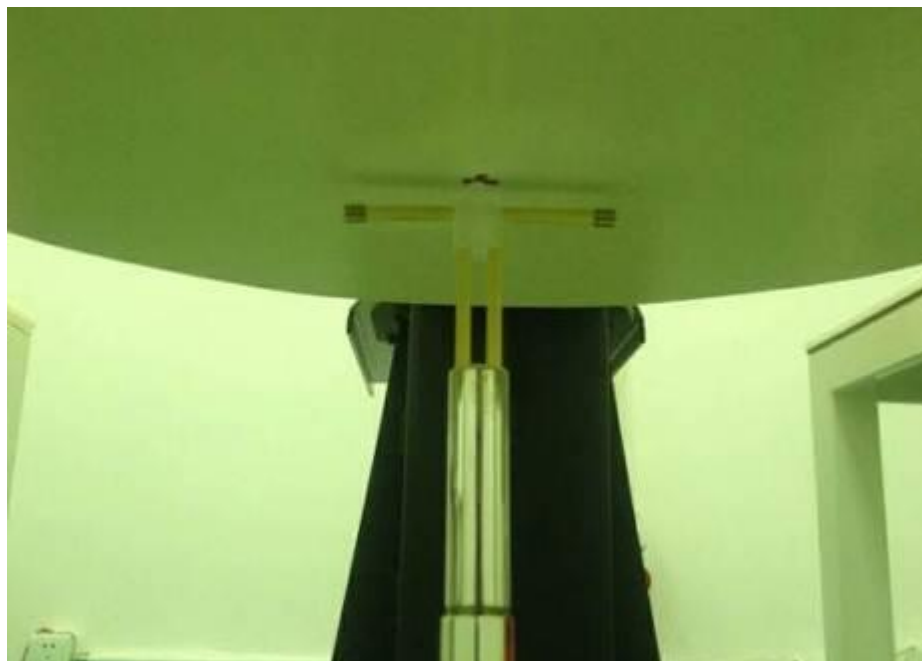

Picture 8.2 Photo of Dipole Setup

8.2. System Verification

SAR system verification is required to confirm measurement accuracy, according to the tissue dielectric media, probe calibration points and other system operating parameters required for measuring the SAR of

test device. The system verification must be performed for each frequency band and within the valid range of each probe calibration point required for testing the device.

Table 8.1: System Verification of Body

Verification Results							
Input power level: 1W							
Frequency	Target value (W/kg)		Measured value (W/kg)		Deviation		Test date
	10 g Average	1 g Average	10 g Average	1 g Average	10 g Average	1 g Average	
835 MHz	6.29	9.57	6.36	9.68	1.11%	1.15%	2017-07-10
1900 MHz	21.3	41.1	20.84	40.8	-2.16%	-0.73%	2017-07-11
2450 MHz	24.7	53.1	24.16	52.0	-2.19%	-2.07%	2017-07-12

9. Measurement Procedures

9.1. Tests to be performed

In order to determine the highest value of the peak spatial-average SAR of a handset, all device positions, configurations and operational modes shall be tested for each frequency band according to steps 1 to 3 below. A flowchart of the test process is shown in Picture 11.1.

Step 1: The tests described in 11.2 shall be performed at the channel that is closest to the centre of the transmit frequency band (f_c) for:

- a) all device positions (cheek and tilt, for both left and right sides of the SAM phantom, as described in Chapter 8),
- b) all configurations for each device position in a), e.g., antenna extended and retracted, and
- c) all operational modes, e.g., analogue and digital, for each device position in a) and configuration in b) in each frequency band.

If more than three frequencies need to be tested according to 11.1 (i.e., $N_c > 3$), then all frequencies, configurations and modes shall be tested for all of the above test conditions.

Step 2: For the condition providing highest peak spatial-average SAR determined in Step 1, perform all tests described in 11.2 at all other test frequencies, i.e., lowest and highest frequencies. In addition, for all other conditions (device position, configuration and operational mode) where the peak spatial-average SAR value determined in Step 1 is within 3 dB of the applicable SAR limit, it is recommended that all other test frequencies shall be tested as well.

Step 3: Examine all data to determine the highest value of the peak spatial-average SAR found in Steps 1 to 2.

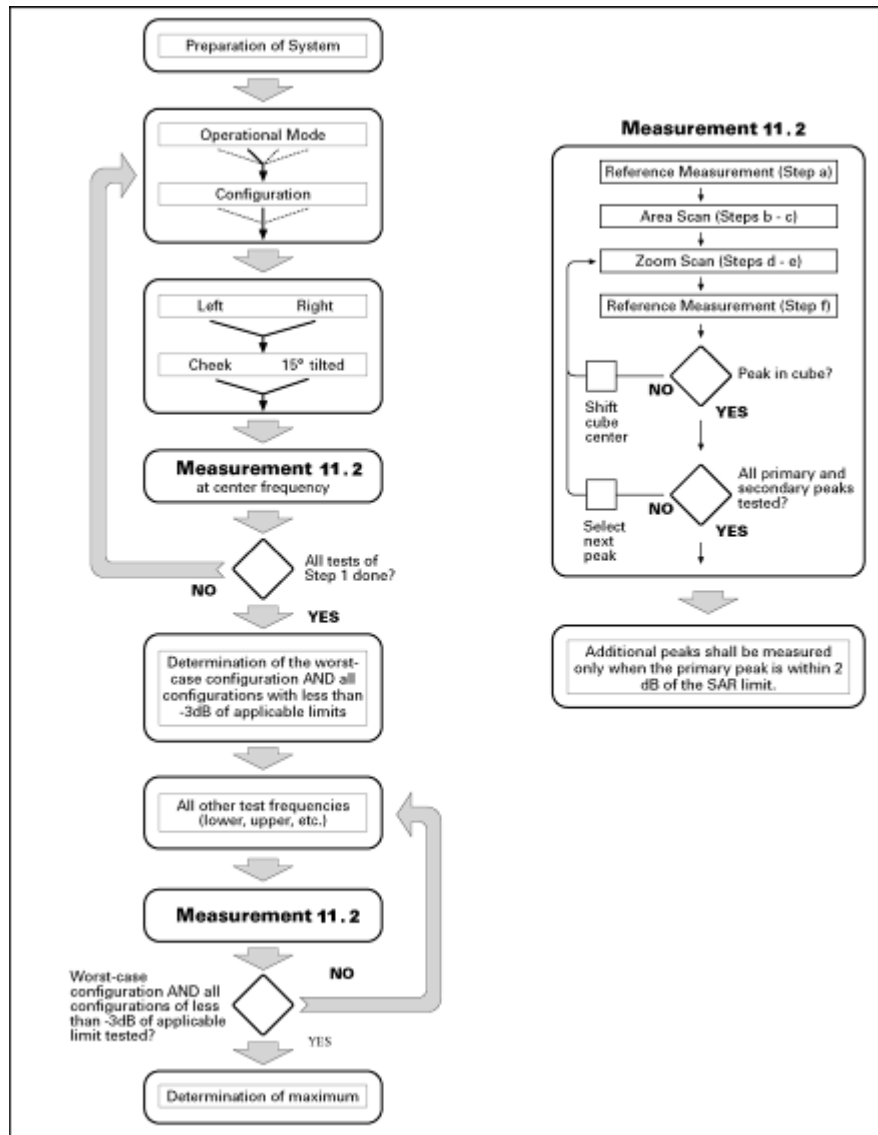

Picture 9.1 Block diagram of the tests to be performed

9.2. General Measurement Procedure

The following procedure shall be performed for each of the test conditions (see Picture 11.1) described in 11.1:

- a) Measure the local SAR at a test point within 8 mm or less in the normal direction from the inner surface of the phantom.
- b) Measure the two-dimensional SAR distribution within the phantom (area scan procedure). The boundary of the measurement area shall not be closer than 20 mm from the phantom side walls. The distance between the measurement points should enable the detection of the location of local maximum with an accuracy of better than half the linear dimension of the tissue cube after interpolation. A maximum grid spacing of 20 mm for frequencies below 3 GHz and $(60/f \text{ [GHz]})$ mm for frequencies of 3GHz and greater is recommended. The maximum distance between the geometrical centre of the probe detectors and the inner surface of the phantom shall be 5 mm for frequencies below 3 GHz and $\delta \ln(2)/2$ mm for frequencies of 3 GHz and greater, where δ is the plane wave skin depth and $\ln(x)$ is the natural logarithm. The maximum variation of the sensor-phantom surface shall be ± 1 mm for frequencies below 3 GHz and

± 0.5 mm for frequencies of 3 GHz and greater. At all measurement points the angle of the probe with respect to the line normal to the surface should be less than 5° . If this cannot be achieved for a measurement distance to the phantom inner surface shorter than the probe diameter, additional uncertainty evaluation is needed.

c) From the scanned SAR distribution, identify the position of the maximum SAR value, in addition identify the positions of any local maxima with SAR values within 2 dB of the maximum value that are not within the zoom-scan volume; additional peaks shall be measured only when the primary peak is within 2 dB of the SAR limit. This is consistent with the 2 dB threshold already stated;

d) Measure the three-dimensional SAR distribution at the local maxima locations identified in step c). The horizontal grid step shall be $(24/f[\text{GHz}])$ mm or less but not more than 8 mm. The minimum zoom size of 30 mm by 30 mm and 30 mm for frequencies below 3 GHz. For higher frequencies, the minimum zoom size of 22 mm by 22 mm and 22 mm. The grid step in the vertical direction shall be $(8-f[\text{GHz}])$ mm or less but not more than 5 mm, if uniform spacing is used. If variable spacing is used in the vertical direction, the maximum spacing between the two closest measured points to the phantom shell shall be $(12 / f[\text{GHz}])$ mm or less but not more than 4 mm, and the spacing between further points shall increase by an incremental factor not exceeding 1.5. When variable spacing is used, extrapolation routines shall be tested with the same spacing as used in measurements. The maximum distance between the geometrical centre of the probe detectors and the inner surface of the phantom shall be 5 mm for frequencies below 3 GHz and $\delta \ln(2)/2$ mm for frequencies of 3 GHz and greater, where δ is the plane wave skin depth and $\ln(x)$ is the natural logarithm. Separate grids shall be centered on each of the local SAR maxima found in step c). Uncertainties due to field distortion between the media boundary and the dielectric enclosure of the probe should also be minimized, which is achieved if the distance between the phantom surface and physical tip of the probe is larger than probe tip diameter. Other methods may utilize correction procedures for these boundary effects that enable high precision measurements closer than half the probe diameter. For all measurement points, the angle of the probe with respect to the flat phantom surface shall be less than 5° . If this cannot be achieved an additional uncertainty evaluation is needed.

e) Use post processing(e.g. interpolation and extrapolation) procedures to determine the local SAR values at the spatial resolution needed for mass averaging.

9.3. WCDMA Measurement Procedures for SAR

The following procedures are applicable to WCDMA handsets operating under 3GPP Release99, Release 5 and Release 6. The default test configuration is to measure SAR with an established radio link between the DUT and a communication test set using a 12.2kbps RMC (reference measurement channel) configured in Test Loop Mode 1. SAR is selectively confirmed for other physical channel configurations (DPCCH & DPDCH_n), HSDPA and HSPA (HSUPA/HSDPA) modes according to output power, exposure conditions and device operating capabilities. Both uplink and downlink should be configured with the same RMC or AMR, when required. SAR for Release 5 HSDPA and Release 6 HSPA are measured using the applicable FRC (fixed reference channel) and E-DCH reference channel configurations. Maximum output power is verified according to applicable versions of 3GPP TS 34.121 and SAR must be measured according to these maximum output conditions. When Maximum Power Reduction (MPR) is not implemented according to Cubic Metric (CM) requirements for Release 6 HSPA, the following procedures do not apply.

For Release 5 HSDPA Data Devices:

Sub-test	β_c	β_d	β_d (SF)	β_c / β_d	β_{hs}	CM/dB	MPR/dB
1	2/15	15/15	64	2/15	4/15	2.0	0.0
2	12/15	15/15	64	12/15	24/25	2.0	0.0
3	15/15	8/15	64	15/8	30/15	2.0	0.0
4	15/15	4/15	64	15/4	30/15	2.0	0.0

For Release 6 HSPA Data Devices

Sub-test	β_c	β_d	β_d (SF)	β_c / β_d	β_{hs}	β_{ec}	β_{ed}	β_{ed} (SF)	β_{ed} (codes)	CM (dB)	MPR (dB)	AG Index	E-TFCI
1	11/15	15/15	64	11/15	22/15	209/225	1039/225	4	1	2.0	0.0	20	75
2	6/15	15/15	64	6/15	12/15	12/15	12/15	4	1	2.0	0.0	12	67
3	15/15	9/15	64	15/9	30/15	30/15	$\beta_{ed1}:47/15$ $\beta_{ed2}:47/15$	4	2	2.0	0.0	15	92
4	2/15	15/15	64	2/15	4/15	4/15	56/75	4	1	2.0	0.0	17	71
5	15/15	15/15	64	15/15	24/15	30/15	134/15	4	1	2.0	0.0	21	81

HSPA, HSPA+ Test Configuration

Measurement is required for HSPA, HSPA+, a KDB inquiry is required to confirm that the wireless mode configurations in the test setup have remained stable throughout the SAR measurements without prior KDB confirmation to determine the SAR results are acceptable, a PBA is required for TCB approval.

SAR test exclusion for HSPA, HSPA+ is determined according to the following:

- 1) The HSPA procedures are applied to configure 3GPP Rel. 6 HSPA devices in the required sub-test mode(s) to determine SAR test exclusion.
- 2) SAR is required for Rel. 7 HSPA+ when SAR is required for Rel. 6 HSPA; otherwise, the 3G SAR test reduction procedure is applied to (uplink) HSPA+ with 12.2 kbps RMC as the primary mode. Power is measured for HSPA+ that supports uplink 16 QAM according to configurations in Table C.11.1.4 of 3GPP TS 34.121-1 to determine SAR test reduction.
- 3) Regardless of whether a PBA is required, the following information must be verified and included in the SAR report for devices supporting HSPA, HSPA+:
 - a) The output power measurement results and applicable release version(s) of 3GPP TS 34.121.
 - a) Power measurement difficulties due to test equipment setup or availability must be resolved between the grantee and its test lab.
 - b) The power measurement results are in agreement with the individual device implementation and specifications. When Enhanced MPR (E-MPR) applies, the normal MPR targets may be modified according to the Cubic Metric (CM) measured by the device, which must be taken into consideration.
 - c) The UE category, operating parameters, such as the _ and values used to configure the device for

testing, power setback procedures described in 3GPP TS 34.121 for the power measurements, and HSPA/HSPA+ channel conditions (active and stable) for the entire duration of the measurement according to the required E-TCI and AG index values.

- 4) When SAR measurement is required, the test configurations, procedures and power measurement results must be clearly described to confirm that the required test parameters are used, including E-TCI and AG index stability and output power conditions.

9.4. SAR Measurement for LTE

SAR tests for LTE are performed with a base station simulator, Anritsu 8820. Closed loop power control was used so the UE transmits with maximum output power during SAR testing. All powers were measured with the Anritsu 8820

It is performed for conducted power and SAR based on the KDB941225 D05.

SAR is evaluated separately according to the following procedures for the different test positions in each exposure condition – head, body, body-worn accessories and other use conditions. The procedures in the following subsections are applied separately to test each LTE frequency band

1) QPSK with 1 RB allocation

Start with the largest channel bandwidth and measure SAR for QPSK with 1 RB allocation, using the RB offset and required test channel combination with the highest maximum output power among RB offsets at the upper edge, middle and lower edge of each required test channel. When the reported SAR is ≤ 0.8 W/kg, testing of the remaining RB offset configurations and required test channels is not required for 1 RB allocation; otherwise, SAR is required for the remaining required test channels and only for the RB offset configuration with the highest output power for that channel. When the reported SAR of a required test channel is > 1.45 W/kg, SAR is required for all three RB offset configurations for that required test channel.

2) QPSK with 50% RB allocation

The procedures required for 1 RB allocation in 1) are applied to measure the SAR for QPSK with 50% RB allocation.

3) QPSK with 100% RB allocation

For QPSK with 100% RB allocation, SAR is not required when the highest maximum output power for 100 % RB allocation is less than the highest maximum output power in 50% and 1 RB allocations and the highest reported SAR for 1 RB and 50% RB allocation in 1) and 2) are ≤ 0.8 W/kg. Otherwise, SAR is measured for the highest output power channel; and if the reported SAR is > 1.45 W/kg, the remaining required test channels must also be tested.

9.5. Bluetooth & Wi-Fi Measurement Procedures for SAR

Normal network operating configurations are not suitable for measuring the SAR of 802.11 transmitters in general. Unpredictable fluctuations in network traffic and antenna diversity conditions can introduce undesirable variations in SAR results. The SAR for these devices should be measured using chipset based test mode software to ensure that the results are consistent and reliable.

Chipset based test mode software is hardware dependent and generally varies among manufacturers. The device operating parameters established in a test mode for SAR measurements must be identical to those programmed in production units, including output power levels, amplifier gain settings and other RF performance tuning parameters. The test frequencies should correspond to actual channel frequencies defined for domestic use. SAR for devices with switched diversity should be measured with only one antenna transmitting at a time during each SAR measurement, according to a fixed modulation and data rate. The same data pattern should

be used for all measurements.

9.6. Power Drift

To control the output power stability during the SAR test, DASY5 system calculates the power drift by measuring the E-field at the same location at the beginning and at the end of the measurement for each test position. These drift values can be found in Section 14 labeled as: (Power Drift [dB]). This ensures that the power drift during one measurement is within 5%.

10. Area Scan Based 1-g SAR

10.1 Requirement of KDB

According to the KDB447498 D01 v06, when the implementation is based the specific polynomial fit algorithm as presented at the 29th Bioelectromagnetics Society meeting (2007) and the estimated 1-g SAR is ≤ 1.2 W/kg, a zoom scan measurement is not required provided it is also not needed for any other purpose; for example, if the peak SAR location required for simultaneous transmission SAR test exclusion can be determined accurately by the SAR system or manually to discriminate between distinctive peaks and scattered noisy SAR distributions from area scans.

There must not be any warning or alert messages due to various measurement concerns identified by the SAR system; for example, noise in measurements, peaks too close to scan boundary, peaks are too sharp, spatial resolution and uncertainty issues etc. The SAR system verification must also demonstrate that the area scan estimated 1-g SAR is within 3% of the zoom scan 1-g SAR (See Annex B). When all the SAR results for each exposure condition in a frequency band and wireless mode are based on estimated 1-g SAR, the 1-g SAR for the highest SAR configuration must be determined by a zoom scan.

10.2 Fast SAR Algorithms

The approach is based on the area scan measurement applying a frequency dependent attenuation parameter. This attenuation parameter was empirically determined by analyzing a large number of phones. The MOTOROLA FAST SAR was developed and validated by the MOTOROLA Research Group in Ft. Lauderdale.

In the initial study, an approximation algorithm based on Linear fit was developed. The accuracy of the algorithm has been demonstrated across a broad frequency range (136-2450 MHz) and for both 1- and 10-g averaged SAR using a sample of 264 SAR measurements from 55 wireless handsets. For the sample size studied, the root-mean-squared errors of the algorithm are 1.2% and 5.8% for 1- and 10-g averaged SAR, respectively. The paper describing the algorithm in detail is expected to be published in August 2004 within the Special Issue of Transactions on MTT.

In the second step, the same research group optimized the fitting algorithm to an Polynomial fit whereby the frequency validity was extended to cover the range 30-6000MHz. Details of this study can be found in the BEMS 2007 Proceedings.

Both algorithms are implemented in DASY software.

11. Conducted Output Power

11.1. Manufacturing tolerance

Table 11.1: GPRS/EGPRS (GMSK Modulation)

GSM 850				
Channel		128	190	251
1 Txslots	Maximum Target Value (dBm)	32	32	32
2 Txslots	Maximum Target Value (dBm)	31.5	31.5	31.5
3 Txslots	Maximum Target Value (dBm)	30	30	30
4 Txslots	Maximum Target Value (dBm)	29	29	29
GSM 1900				
Channel		512	661	810
1 Txslots	Maximum Target Value (dBm)	28.5	28.5	28.5
2 Txslots	Maximum Target Value (dBm)	28	28	28
3 Txslots	Maximum Target Value (dBm)	27	27	27
4 Txslots	Maximum Target Value (dBm)	26	26	26

Table 11.2: EGPRS (8PSK Modulation)

GSM 850 EGPRS				
Channel		975	38	124
1 Txslots	Maximum Target Value (dBm)	27	27	27
2 Txslots	Maximum Target Value (dBm)	26	26	26
3 Txslots	Maximum Target Value (dBm)	24	24	24
4 Txslots	Maximum Target Value (dBm)	23	23	23
GSM 1900 EGPRS				
Channel		512	661	810
1 Txslots	Maximum Target Value (dBm)	26.5	26.5	26.5
2 Txslots	Maximum Target Value (dBm)	25.5	25.5	25.5
3 Txslots	Maximum Target Value (dBm)	22.5	22.5	22.5
4 Txslots	Maximum Target Value (dBm)	21.5	21.5	21.5

Table 11.3: WCDMA

WCDMA Band II			
Channel	Channel 9262	Channel 9400	Channel 9538
Maximum Target Value (dBm)	21	21	21

Table 11.4: HSDPA

WCDMA Band II					MPR (dB)
Channel		9262	9400	9538	
1	Maximum Target Value (dBm)	20	20	20	0
2	Maximum Target Value (dBm)	20	20	20	0
3	Maximum Target Value (dBm)	20	20	20	0
4	Maximum Target Value (dBm)	20	20	20	0

Table 11.5: HSUPA

WCDMA Band II					MPR (dB)
Channel		9262	9400	9538	
1	Maximum Target Value (dBm)	20	20	20	0
2	Maximum Target Value (dBm)	20	20	20	0
3	Maximum Target Value (dBm)	20	20	20	0
4	Maximum Target Value (dBm)	20	20	20	0
5	Maximum Target Value (dBm)	20	20	20	0

Table 11.6: HSPA+

WCDMA Band II			
Channel	Channel 9262	Channel 9400	Channel 9538
Maximum Target Value (dBm)	20	20	20

Table 11.7: WCDMA

WCDMA Band V			
Channel	4233	4182	4132
Maximum Target Value (dBm)	21	21	21

Table 11.8: HSDPA

WCDMA Band V					MPR (dB)
Channel		4233	4182	4132	
1	Maximum Target Value (dBm)	20	20	20	0
2	Maximum Target Value (dBm)	20	20	20	0
3	Maximum Target Value (dBm)	20	20	20	0
4	Maximum Target Value (dBm)	20	20	20	0

Table 11.9: HSUPA

WCDMA Band V					MPR (dB)
Channel		4233	4182	4132	
1	Maximum Target Value (dBm)	20	20	20	0

2	Maximum Target Value (dBm)	20	20	20	0
3	Maximum Target Value (dBm)	20	20	20	0
4	Maximum Target Value (dBm)	20	20	20	0
5	Maximum Target Value (dBm)	20	20	20	0

Table 11.10: HSPA+

WCDMA Band V			
Channel	4233	4182	4132
Maximum Target Value (dBm)	20	20	20

Table 11.11: WiFi

WiFi 802.11b					
Channel	Channel 1	Channel 6	Channel 11	Channel 12	Channel 13
Maximum Target Value (dBm)	15	15	14	13.5	13.5
WiFi 802.11g					
Channel	Channel 1	Channel 6	Channel 11	Channel 12	Channel 13
Maximum Target Value (dBm)	13	13	13	11.5	11.5
WiFi 802.11n 20M					
Channel	Channel 1	Channel 6	Channel 11	Channel 12	Channel 13
Maximum Target Value (dBm)	11	11	11	10	10
WiFi 802.11n 40M					
Channel	Channel 3	Channel 6	Channel 9	Channel 10	Channel 11
Maximum Target Value (dBm)	11	11	11	9.5	9.5

Table 11.12: Bluetooth 2.1

Bluetooth			
Channel	Channel 0	Channel 19	Channel 38
Maximum Target Value (dBm)	6	6	6

Table 11.13: Bluetooth 4.0

Bluetooth			
Channel	Channel 0	Channel 19	Channel 38
Maximum Target Value (dBm)	-2	-2	-2

11.2. GSM Measurement result

During the process of testing, the EUT was controlled via Agilent Digital Radio Communication tester (E5515C) to ensure the maximum power transmission and proper modulation. This result contains conducted output power for the EUT. In all cases, the measured peak output power should be greater and within 5% than EMI measurement.

Table 11.14: The conducted power measurement results for GPRS/EGPRS(GMSK)

GSM 850	Measured Power (dBm)			calculation	Averaged Power (dBm)		
	128	190	251		128	190	251
1 Txslot	31.89	31.96	31.73	-9.03dB	22.86	22.93	22.70
2 Txslots	31.13	31.05	31.01	-6.02dB	25.11	25.03	24.99
3 Txslots	29.63	29.54	29.44	-4.26dB	25.37	25.28	25.18
4 Txslots	28.85	28.76	28.69	-3.01dB	25.84	25.75	25.68
GSM 1900	Measured Power (dBm)			calculation	Averaged Power (dBm)		
	512	661	810		512	661	810
1 Txslot	28.45	28.42	28.31	-9.03dB	19.42	19.39	19.28
2 Txslots	27.86	27.72	27.54	-6.02dB	21.84	21.70	21.52
3 Txslots	26.64	26.24	25.93	-4.26dB	22.38	21.98	21.67
4 Txslots	25.51	25.41	25.38	-3.01dB	22.50	22.40	22.07

Table 11.15: The conducted power measurement results for EDGE(8PSK)

GSM 850 EDGE	Measured Power (dBm)			calculation	Averaged Power (dBm)		
	128	190	251		128	190	251
1 Txslot	26.85	26.99	26.83	-9.03dB	17.82	17.96	17.80
2 Txslots	25.82	25.96	25.81	-6.02dB	19.80	19.94	19.79
3 Txslots	23.79	23.66	23.78	-4.26dB	19.63	19.50	19.62
4 Txslots	22.97	22.86	22.03	-3.01dB	20.06	19.85	19.02
GSM 1900 EDGE	Measured Power (dBm)			calculation	Averaged Power (dBm)		
	512	661	810		512	661	810
1 Txslot	25.31	25.29	26.05	-9.03dB	16.28	16.26	17.02
2 Txslots	23.96	24.18	25.45	-6.02dB	17.94	18.16	19.43
3 Txslots	21.66	21.99	22.41	-4.26dB	17.40	17.73	18.15
4 Txslots	20.51	20.57	21.38	-3.01dB	17.50	17.56	18.37

NOTES:

1) Division Factors

To average the power, the division factor is as follows:

1TX-slot = 1 transmit time slot out of 8 time slots=> conducted power divided by (8/1) => -9.03dB

2TX-slots = 2 transmit time slots out of 8 time slots=> conducted power divided by (8/2) => -6.02dB

3TX-slots = 3 transmit time slots out of 8 time slots=> conducted power divided by (8/3) => -4.26dB

4TX-slots = 4 transmit time slots out of 8 time slots=> conducted power divided by (8/4) => -3.01dB

According to the conducted power as above, the body measurements are performed with 4Txslots for 850MHz ; 4Txslots for1900MHz;

11.3. WCDMA Measurement result

Table 11.16: The conducted Power for WCDMA

Item	band	WCDMA BAND II result(dBm)		
	ARFCN	9612 (1922.4MHz)	9750 (1950.0MHz)	9888 (1977.6MHz)
WCDMA	\	20.49	20.56	20.27
HSDPA	1	19.81	19.87	19.57
	2	19.92	19.98	19.69
	3	19.86	19.93	19.64
	4	19.89	19.95	19.65
HSUPA	1	19.78	19.86	19.57
	2	19.96	19.99	19.80
	3	19.85	19.92	19.66
	4	19.92	19.95	19.71
	5	19.83	19.90	19.61
HSPA+	QPSK	19.72	19.78	19.60
	16QAM	19.69	19.75	19.58
Item	band	WCDMA BAND V result(dBm)		
	ARFCN	4133 (862.4MHz)	4183 (836.6MHz)	4232 (846.6MHz)
WCDMA	\	20.47	20.54	20.45
HSDPA	1	19.82	19.83	19.74
	2	19.92	19.93	19.86
	3	19.87	19.88	19.81
	4	19.90	19.91	19.82
HSUPA	1	19.80	19.81	19.74
	2	19.95	19.98	19.97
	3	19.90	19.91	19.83
	4	19.93	19.94	19.88
	5	19.84	19.85	19.78
HSPA+	QPSK	19.37	19.34	19.35
	16QAM	19.32	19.31	19.32

11.4. Wi-Fi and BT Measurement result

Table 11.17: The conducted power for Bluetooth 2.1

GFSK			
Channel	Ch0 (2402 MHz)	Ch39 (2441MHz)	CH78 (2480MHz)
Conducted Output Power (dBm)	5.35	5.95	5.24
$\pi/4$ DQPSK			
Channel	Ch0 (2402 MHz)	Ch39 (2441MHz)	CH78 (2480MHz)
Conducted Output Power (dBm)	5.32	5.98	5.20
8DPSK			
Channel	Ch0 (2402 MHz)	Ch39 (2441MHz)	CH78 (2480MHz)
Conducted Output Power (dBm)	4.32	4.97	4.21

Table 11.18: The conducted power for Bluetooth 4.0

GFSK			
Channel	Ch0 2402 MHz	Ch19 2440 MHz	CH39 2480 MHz
Conducted Output Power (dBm)	-2.75	-2.42	-2.87

NOTE: According to KDB447498 D01 BT standalone SAR are not required, because maximum average output power is less than 10mW.

When the standalone SAR test exclusion is applied to an antenna that transmits simultaneously with other antennas, the standalone SAR must be estimated according to the following to determine simultaneous transmission SAR test exclusion:

(max. power of channel, including tune-up tolerance, mW)/(min. test separation distance, mm) • [$\sqrt{f(\text{GHz})/x}$] W/kg for test separation distances ≤ 50 mm;
 where x = 7.5 for 1-g SAR, and x = 18.75 for 10-g SAR.

SAR body value of BT is 0.167 W/Kg.

The default power measurement procedures are:

a) Power must be measured at each transmit antenna port according to the DSSS and OFDM transmission configurations in each standalone and aggregated frequency band.

b) Power measurement is required for the transmission mode configuration with the highest maximum output power specified for production units.

1) When the same highest maximum output power specification applies to multiple transmission modes, the largest channel bandwidth configuration with the lowest order modulation and lowest data rate is measured.

2) When the same highest maximum output power is specified for multiple largest channel bandwidth configurations with the same lowest order modulation or lowest order modulation and lowest data rate, power measurement is required for all equivalent 802.11 configurations with the same maximum output power.

c) For each transmission mode configuration, power must be measured for the highest and lowest channels; and at the mid-band channel(s) when there are at least 3 channels. For configurations with multiple mid-band channels, due to an even number of channels, both channels should be measured.

During WLAN SAR testing EUT is configured with the WLAN continuous TX tool, and the transmission duty factor was monitored on the spectrum analyzer with zero-span setting, the duty cycle is 100%.

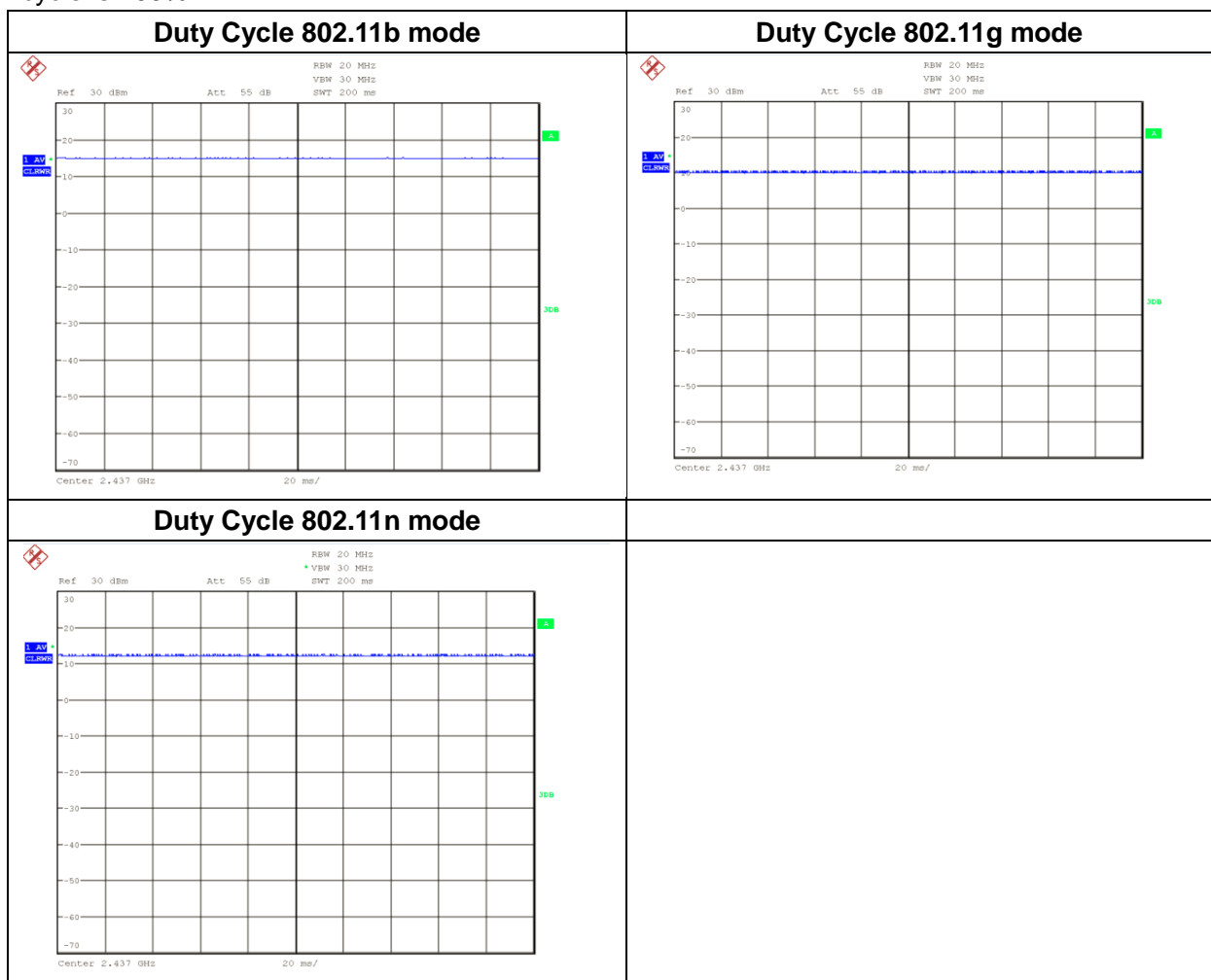

Table 11.19: The average conducted power for WiFi

Mode	Channel	Frequency	Average power(dBm)
802.11 b	1	2412 MHZ	14.75
	6	2437 MHZ	14.26
	11	2462 MHZ	13.64
	12	2467 MHZ	13.37
	13	2472 MHZ	13.18
802.11 g	1	2412 MHZ	12.81
	6	2437 MHZ	12.22
	11	2462 MHZ	11.67
	12	2467 MHZ	11.29
	13	2472 MHZ	11.07
802.11 n 20M	1	2412 MHZ	10.96
	6	2437 MHZ	10.25
	11	2462 MHZ	9.46
	12	2467 MHZ	9.88
	13	2472 MHZ	9.63
802.11 n 40M	3	2422 MHZ	10.66
	6	2437 MHZ	10.17
	9	2452 MHZ	9.80
	10	2457 MHZ	9.27
	11	2462 MHZ	8.94

2.4 GHz 802.11g/n OFDM SAR Test Exclusion Requirements

When SAR measurement is required for 2.4 GHz 802.11g/n OFDM configurations, the measurement and test reduction procedures for OFDM are applied. SAR is not required for the following 2.4 GHz OFDM conditions.

- a) When KDB Publication 447498 D01 SAR test exclusion applies to the OFDM configuration.
- b) When the highest *reported* SAR for DSSS is adjusted by the ratio of OFDM to DSSS specified maximum output power and the adjusted SAR is ≤ 1.2 W/kg.

12. Simultaneous TX SAR Considerations

12.1. Introduction

The following procedures adopted from “FCC SAR Considerations for Cell Phones with Multiple Transmitters” are applicable to handsets with built-in unlicensed transmitters such as 802.11 a/b/g and Bluetooth devices which may simultaneously transmit with the licensed transmitter. For this device, the BT and Wi-Fi can transmit simultaneous with other transmitters.

12.2. Transmit Antenna Separation Distances

Picture 12.1 Antenna Locations

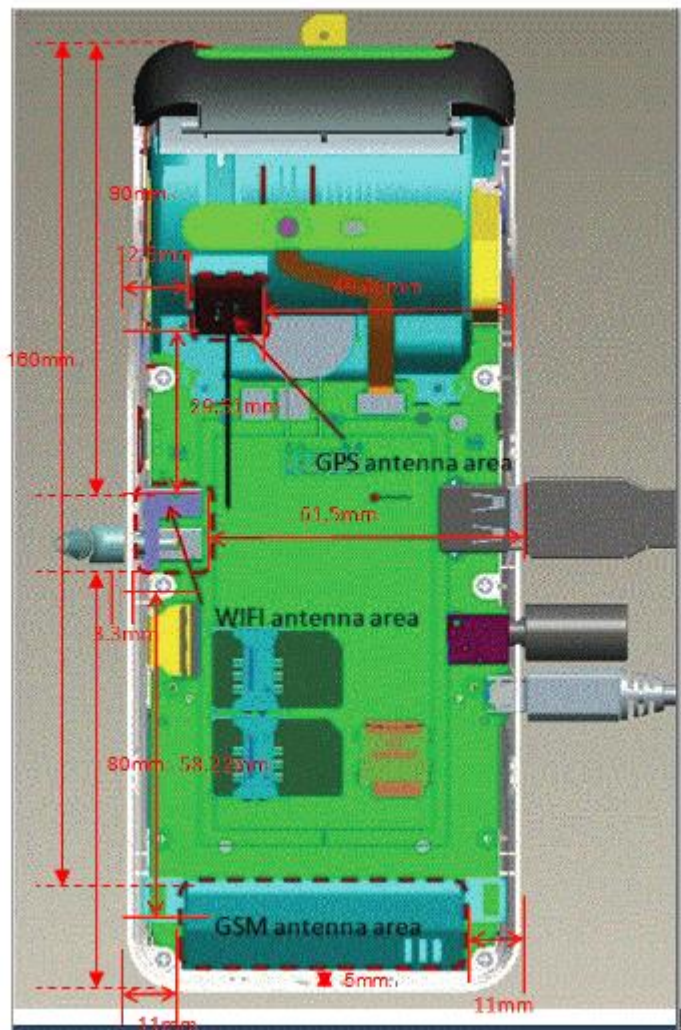

Note

GSM Antenna meaning is 2G/3G TX Antenna

The following SAR test exclusion Thresholds based on KDB 447498 D01 General RF Exposure Guidance v06 4.3.1

Exposure Position	Wireless Interface	WWAN				WLAN
		GSM850	GSM1900	WCDMA Band II	WCDMA Band V	802.11 b
Exposure Position	Maximum power	29	26	21	21	15
	Maximum rated power(mW)	794.33	398.11	125.89	125.89	31.62
Front view	Antenna to user (mm)	10	10	10	10	13
	SAR exclusion threshold	32.54	21.76	21.76	32.54	24.92
	SAR testing required?	Yes	Yes	Yes	Yes	Yes
Rear view	Antenna to user (mm)	5	5	5	5	10
	SAR exclusion threshold	16.27	10.88	10.88	16.27	19.17
	SAR testing required?	Yes	Yes	Yes	Yes	Yes
Rear view Title	Antenna to user (mm)	5	5	5	5	20
	SAR exclusion threshold	16.27	10.88	10.88	16.27	38.33
	SAR testing required?	Yes	Yes	Yes	Yes	No
Top	Antenna to user (mm)	160	160	160	160	90
	SAR exclusion threshold	787.33	1209.00	809.00	1209.00	496.00
	SAR testing required?	Yes	No	No	No	No
Left	Antenna to user (mm)	11	11	11	11	61.5
	SAR exclusion threshold	35.79	23.94	23.94	35.79	216
	SAR testing required?	Yes	Yes	Yes	Yes	No
Bottom	Antenna to user (mm)	5	5	5	5	80
	SAR exclusion threshold	16.27	10.88	10.88	16.27	396
	SAR testing required?	Yes	Yes	Yes	Yes	No
Right	Antenna to user (mm)	11	11	11	11	3.3
	SAR exclusion threshold	35.79	23.94	23.94	35.79	9.58
	SAR testing required?	Yes	Yes	Yes	Yes	Yes

Note:

1. Maximum power is the source-based time-average power and represents the maximum RF output power among production units
2. Per KDB 447498 D01v06, for larger devices, the test separation distance of adjacent edge configuration is determined by the closest separation between the antenna and the user.

3. Per KDB 447498 D01v06, standalone SAR test exclusion threshold is applied; If the distance of the antenna to the user is < 5mm, 5mm is used to determine SAR exclusion threshold
4. Per KDB 447498 D01v06, the 1-g and 10-g SAR test exclusion thresholds for 100 MHz to 6 GHz at *test separation distances* ≤ 50 mm are determined by:
- $$\left[\frac{\text{max. power of channel, including tune-up tolerance, mW}}{\text{min. test separation distance, mm}} \right] \cdot \sqrt{f(\text{GHz})} \leq 3.0$$
- for 1-g SAR and ≤ 7.5 for 10-g extremity SAR
- f(GHz) is the RF channel transmit frequency in GHz
- Power and distance are rounded to the nearest mW and mm before calculation
- The result is rounded to one decimal place for comparison
- For < 50 mm distance, we just calculate mW of the exclusion threshold value (3.0) to do compare.
- This formula is $[3.0] / \sqrt{f(\text{GHz})} \cdot [\text{min. test separation distance, mm}] = \text{exclusion threshold of mW}$.
5. Per KDB 447498 D01v06, at 100 MHz to 6 GHz and for *test separation distances* > 50 mm, the SAR test exclusion threshold is determined according to the following
- a) [Threshold at 50 mm in step 1) + (test separation distance - 50 mm) · (f(MHz)/150)] mW, at 100 MHz to 1500 MHz
- b) [Threshold at 50 mm in step 1) + (test separation distance - 50 mm) · 10] mW at > 1500 MHz and ≤ 6 GHz
6. When the minimum *test separation distance* is < 5 mm, a distance of 5 mm according to 5) in section 4.1 is applied to determine SAR test exclusion.

13. Evaluation of Simultaneous

Table 13.1: Summary of Transmitters

Band/Mode	Frequency (GHz)	SAR test exclusion threshold(mW)	RF output power (mW)
Bluetooth	2.41	10	3.981
2.4GHz WLAN 802.11 b/g/n	2.45	10	31.623

Table13.2 Simultaneous transmission SAR

Standalone SAR for 2G(W/Kg)				
Test Position		GSM 850	GSM 1900	Highest SAR
Body 0mm	Phantom Side	0.126	0.281	0.281
	Ground Side	0.153	0.493	0.493
	Ground Tilt Side	0.267	0.993	0.993
	Left Side	0.165	0.530	0.530
	Right Side	0.494	0.204	0.494
	Bottom Side	0.315	0.436	0.436
	Top Side	--	--	--
Body 5mm	Phantom Side	0.104	0.395	0.395
	Ground Side	0.122	0.608	0.608
	Ground Tilt Side	0.190	0.931	0.931
	Left Side	0.133	0.622	0.622
	Right Side	0.509	0.283	0.509
	Bottom Side	0.275	0.465	0.465
	Top Side	--	--	--

Standalone SAR for 3G(W/Kg)				
Test Position		WCDMA Band II	WCDMA Band V	Highest SAR
Body 0mm	Phantom Side	0.274	0.078	0.274
	Ground Side	0.571	0.103	0.571
	Ground Tilt Side	1.086	0.212	1.086
	Left Side	0.708	0.096	0.708

	Right Side	0.177	0.364	0.364
	Bottom Side	0.435	0.226	0.435
	Top Side	--	--	--
Body5mm	Phantom Side	0.294	0.022	0.294
	Ground Side	0.562	0.059	0.562
	Ground Tilt Side	0.594	0.050	0.594
	Left Side	0.577	0.059	0.577
	Right Side	0.287	0.236	0.287
	Bottom Side	0.041	0.160	0.160
	Top Side	--	--	--

Transmission SAR(W/Kg)						
Test Position		2G	3G	WIFI	BT	SUM
Body 0mm	Phantom Side	0.281	0.274	0.030	0.167	0.448
	Ground Side	0.493	0.571	0.024	0.167	0.738
	Ground Tilt Side	0.993	1.086	--	0.167	1.253
	Left Side	0.530	0.708	---	0.167	0.875
	Right Side	0.494	0.364	0.256	0.167	0.750
	Bottom Side	0.436	0.435	--	0.167	0.603
	Top Side	--	--	--	0.167	0.167
Body 5mm	Phantom Side	0.395	0.294	0.022	0.167	0.562
	Ground Side	0.608	0.562	0.024	0.167	0.775
	Ground Tilt Side	0.931	0.594	--	0.167	1.098
	Left Side	0.622	0.577	--	0.167	0.789
	Right Side	0.509	0.287	0.242	0.167	0.751
	Bottom Side	0.465	0.160	--	0.167	0.632
	Top Side	--	--	--	0.167	0.167

According to the conducted power measurement result, we can draw the conclusion that: stand-alone SAR for WiFi should be performed. Then, simultaneous transmission SAR for WiFi/BT is considered with measurement results of GSM/WCDMA and WiFi/BT. According to the above table, the sum of reported SAR values for GSM/WCDMA and WiFi < 1.6W/kg. So the simultaneous transmission SAR for 1g is not required for WiFi/BT transmitter.

According to the above table, the sum of reported SAR values for GSM/WCDMA and WiFi < 4.0 W/kg. So the simultaneous transmission SAR for 10g is not required for WiFi/BT transmitter.

14. SAR Test Result

14.1. SAR results for Fast SAR

Table 14.1: Duty Cycle

Duty Cycle	
GPRS for GSM900/1800	1:2
WCDMA Band II/Band V/and WiFi	1:1

Table 14.2: SAR Values (GSM 850 MHz Band–Body)

Frequency		Mode (number of timeslots)	Test Position	Figure No.	Measured average power(dBm)	Maximum allowed Power (dBm)	Scaling factor	Measured SAR(10g) (W/kg)	Reported SAR(10g) (W/kg)	Power Drift (dB)
MHz	Ch.									
836.6	190	GPRS (4)	Phantom	/	28.76	29	1.057	0.119	0.126	0.05
836.6	190	GPRS (4)	Ground	/	28.76	29	1.057	0.145	0.153	-0.07
836.6	190	GPRS (4)	Ground Tilt	/	28.76	29	1.057	0.253	0.267	0.14
836.6	190	GPRS (4)	Left	/	28.76	29	1.057	0.156	0.165	0.05
836.6	190	GPRS (4)	Right	/	28.76	29	1.057	0.409	0.432	-0.06
836.6	190	GPRS (4)	Bottom	/	28.76	29	1.057	0.298	0.315	0.05
824.2	128	GPRS (4)	Right	/	28.85	29	1.035	0.347	0.359	-0.07
848.8	251	GPRS (4)	Right	Fig.1	28.69	29	1.074	0.46	0.494	0.13

Note: The distance between the EUT and the phantom bottom is 0mm

Table 14.3: SAR Values (GSM 850 MHz Band–Body)

Frequency		Mode (number of timeslots)	Test Position	Figure No.	Measured average power(dBm)	Maximum allowed Power (dBm)	Scaling factor	Measured SAR(1g) (W/kg)	Reported SAR(1g) (W/kg)	Power Drift (dB)
MHz	Ch.									
836.6	190	GPRS (4)	Phantom	/	28.76	29	1.057	0.098	0.104	0.10
836.6	190	GPRS (4)	Ground	/	28.76	29	1.057	0.115	0.122	-0.06
836.6	190	GPRS (4)	Ground Tilt	/	28.76	29	1.057	0.180	0.190	-0.14
836.6	190	GPRS (4)	Left	/	28.76	29	1.057	0.126	0.133	0.13
836.6	190	GPRS (4)	Right	/	28.76	29	1.057	0.419	0.443	-0.09
836.6	190	GPRS (4)	Bottom	/	28.76	29	1.057	0.260	0.275	0.15
824.2	128	GPRS (4)	Right	/	28.85	29	1.035	0.366	0.379	0.10
848.8	251	GPRS (4)	Right	Fig.2	28.69	29	1.074	0.474	0.509	-0.18

Note: The distance between the EUT and the phantom bottom is 5mm

Table 14.4: SAR Values (GSM 1900 MHz Band–Body)

Frequency		Mode (number of timeslots)	Test Position	Figure No.	Measured average power(dBm)	Maximum allowed Power (dBm)	Scaling factor	Measured SAR(10g) (W/kg)	Reported SAR(10g) (W/kg)	Power Drift (dB)
MHz	Ch.									
1880	661	GPRS (4)	Phantom	/	25.41	26	1.146	0.245	0.281	-0.06

1880	661	GPRS (4)	Ground	/	25.41	26	1.146	0.430	0.493	-0.14
1880	661	GPRS (4)	Ground Tilt	/	25.41	26	1.146	0.739	0.847	0.13
1880	661	GPRS (4)	Left	/	25.41	26	1.146	0.463	0.530	-0.09
1880	661	GPRS (4)	Right	/	25.41	26	1.146	0.178	0.204	0.15
1880	661	GPRS (4)	Bottom	/	25.41	26	1.146	0.381	0.436	-0.14
1850.2	512	GPRS (4)	Ground Tilt	Fig.3	25.51	26	1.119	0.887	0.993	-0.15
1909.8	810	GPRS (4)	Ground Tilt	/	25.38	26	1.153	0.637	0.735	0.11

Note: The distance between the EUT and the phantom bottom is 0mm.

Table 14.5: SAR Values (GSM 1900 MHz Band-Body)

Frequency		Mode (number of timeslots)	Test Position	Figure No.	Measured average power(dBm)	Maximum allowed Power (dBm)	Scaling factor	Measured SAR(1g) (W/kg)	Reported SAR(1g) (W/kg)	Power Drift (dB)
MHz	Ch.									
1880	661	GPRS (4)	Phantom	/	25.41	26	1.146	0.345	0.395	-0.14
1880	661	GPRS (4)	Ground	/	25.41	26	1.146	0.531	0.608	0.14
1880	661	GPRS (4)	Ground Tilt	/	25.41	26	1.146	0.764	0.875	0.11
1880	661	GPRS (4)	Left	/	25.41	26	1.146	0.543	0.622	-0.09
1880	661	GPRS (4)	Right	/	25.41	26	1.146	0.247	0.283	0.15
1880	661	GPRS (4)	Bottom	/	25.41	26	1.146	0.406	0.465	-0.14
1850.2	512	GPRS (4)	Ground Tilt	Fig.4	25.51	26	1.119	0.832	0.931	0.15
1909.8	810	GPRS (4)	Ground Tilt	/	25.38	26	1.153	0.666	0.768	0.13
repeated										
1850.2	512	GPRS (4)	Ground Tilt	Fig.5	25.51	26	1.119	0.797	0.892	0.20

Note: The distance between the EUT and the phantom bottom is 5mm.

Table 14.6: SAR Values (WCDMA Band II-Body)

Frequency		Mode (number of timeslots)	Test Position	Figure No.	Measured average power(dBm)	Maximum allowed Power (dBm)	Scaling factor	Measured SAR(10g) (W/kg)	Reported SAR(10g) (W/kg)	Power Drift (dB)
MHz	Ch.									
1880	9800	12.2K RMC	Phantom	/	20.56	21	1.107	0.248	0.274	-0.07
1880	9800	12.2K RMC	Ground	/	20.56	21	1.107	0.516	0.571	0.12
1880	9800	12.2K RMC	Ground Tilt	/	20.56	21	1.107	0.843	0.933	0.08
1880	9800	12.2K RMC	Left	/	20.56	21	1.107	0.640	0.708	-0.15
1880	9800	12.2K RMC	Right	/	20.56	21	1.107	0.160	0.177	0.03
1880	9800	12.2K RMC	Bottom	/	20.56	21	1.107	0.393	0.435	0.03
1852.4	9662	12.2K RMC	Ground Tilt	Fig.6	20.49	21	1.125	0.966	1.086	-0.10

1907.6	9938	12.2K RMC	Ground Tilt	/	20.27	21	1.183	0.671	0.794	-0.17
SIM2										
1852.4	9662	12.2K RMC	Ground Tilt	/	20.49	21	1.125	0.709	0.798	0.12

Note: The distance between the EUT and the phantom bottom is 0mm.

Table 14.7: SAR Values (WCDMA Band II-Body)

Frequency		Mode (number of timeslots)	Test Position	Figure No.	Measured average power(dBm)	Maximum allowed Power (dBm)	Scaling factor	Measured SAR(1g) (W/kg)	Reported SAR(1g) (W/kg)	Power Drift (dB)
MHz	Ch.									
1880	9800	12.2K RMC	Phantom	/	20.56	21	1.107	0.266	0.294	0.12
1880	9800	12.2K RMC	Ground	/	20.56	21	1.107	0.508	0.562	-0.11
1880	9800	12.2K RMC	Ground Tilt	Fig.7	20.56	21	1.107	0.537	0.594	-0.16
1880	9800	12.2K RMC	Left	/	20.56	21	1.107	0.521	0.577	-0.07
1880	9800	12.2K RMC	Right	/	20.56	21	1.107	0.259	0.287	0.12
1880	9800	12.2K RMC	Bottom	/	20.56	21	1.107	0.037	0.041	0.08
1852.4	9662	12.2K RMC	Ground Tilt	/	20.49	21	1.125	0.52	0.585	-0.15
1907.6	9938	12.2K RMC	Ground Tilt	/	20.27	21	1.183	0.453	0.536	0.03

Note: The distance between the EUT and the phantom bottom is 5mm.

Table 14.8: SAR Values (WCDMA Band V –Body)

Frequency		Mode (number of timeslots)	Test Position	Figure No.	Measured average power(dBm)	Maximum allowed Power (dBm)	Scaling factor	Measured SAR(10g) (W/kg)	Reported SAR(10g) (W/kg)	Power Drift (dB)
MHz	Ch.									
836.6	4175	12.2K RMC	Phantom	/	20.54	21	1.112	0.07	0.078	0.08
836.6	4175	12.2K RMC	Ground	/	20.54	21	1.112	0.093	0.103	-0.15
836.6	4175	12.2K RMC	Ground Tilt	/	20.54	21	1.112	0.191	0.212	0.03
836.6	4175	12.2K RMC	Left	/	20.54	21	1.112	0.086	0.096	0.03
836.6	4175	12.2K RMC	Right	/	20.54	21	1.112	0.219	0.243	0.10
836.6	4175	12.2K RMC	Bottom	/	20.54	21	1.112	0.203	0.226	0.03
826.4	4132	12.2K RMC	Right	/	20.47	21	1.130	0.212	0.240	0.08
846.6	4232	12.2K RMC	Right	Fig.8	20.45	21	1.135	0.321	0.364	0.14

Note: The distance between the EUT and the phantom bottom is 0mm.

Table 14.9: SAR Values (WCDMA Band V –Body)

Frequency		Mode (number of timeslots)	Test Position	Figure No.	Measured average power(dBm)	Maximum allowed Power (dBm)	Scaling factor	Measured SAR(1g) (W/kg)	Reported SAR(1g) (W/kg)	Power Drift (dB)
MHz	Ch.									
836.6	4175	12.2K RMC	Phantom	/	20.54	21	1.112	0.020	0.022	0.14
836.6	4175	12.2K RMC	Ground	/	20.54	21	1.112	0.053	0.059	0.08
836.6	4175	12.2K RMC	Ground Tilt	/	20.54	21	1.112	0.045	0.050	-0.15
836.6	4175	12.2K RMC	Left	/	20.54	21	1.112	0.053	0.059	0.03
836.6	4175	12.2K RMC	Right	/	20.54	21	1.112	0.190	0.211	0.03
836.6	4175	12.2K RMC	Bottom	/	20.54	21	1.112	0.144	0.160	0.10
826.4	4132	12.2K RMC	Right	/	20.47	21	1.130	0.167	0.189	0.03
846.6	4232	12.2K RMC	Right	Fig.9	20.45	21	1.135	0.208	0.236	-0.18

Note: The distance between the EUT and the phantom bottom is 5mm.

Table 14.10:SAR Values (WiFi2450–Body)

Frequency		Mode (number of timeslots)	Test Position	Figure No.	Measured average power(dBm)	Maximum allowed Power (dBm)	Scaling factor	Measured SAR(10g) (W/kg)	Reported SAR(10g) (W/kg)	Power Drift (dB)
MHz	Ch.									
2412	1	802.11 b	Phantom	/	14.75	15	1.059	0.028	0.030	0.09
2412	1	802.11 b	Ground	/	14.75	15	1.059	0.023	0.024	0.16
2412	1	802.11 b	Right	Fig.10	14.75	15	1.059	0.242	0.256	-0.16
2437	6	802.11 b	Right	/	14.26	15	1.186	0.201	0.238	0.09
2462	11	802.11 b	Right	/	13.64	14	1.086	0.194	0.211	0.06

Note: SAR is not required for OFDM because the 802.11b adjusted SAR ≤ 3 W/kg.

The distance between the EUT and the phantom bottom is 0mm.

Table 14.11:SAR Values (WiFi2450–Body)

Frequency		Mode (number of timeslots)	Test Position	Figure No.	Measured average power(dBm)	Maximum allowed Power (dBm)	Scaling factor	Measured SAR(1g) (W/kg)	Reported SAR(1g) (W/kg)	Power Drift (dB)
MHz	Ch.									
2412	1	802.11 b	Phantom	/	14.75	15	1.059	0.0211	0.022	0.13
2412	1	802.11 b	Ground	/	14.75	15	1.059	0.0228	0.024	-0.09
2412	1	802.11 b	Right	Fig.11	14.75	15	1.059	0.228	0.242	-0.19
2437	6	802.11 b	Right	/	14.26	15	1.186	0.212	0.251	0.09
2462	11	802.11 b	Right	/	13.64	14	1.086	0.166	0.180	0.16

Note: SAR is not required for OFDM because the 802.11b adjusted SAR ≤ 1.2 W/kg.

The distance between the EUT and the phantom bottom is 5mm.

SAR results for Standard procedure

There is zoom scan measurement to be added for the highest measured SAR in each exposure configuration/band.

Table 14.12: SAR Values (GSM 850 MHz Band–Body)

Frequency		Mode (number of timeslots)	Test Position	Figure No.	Measured average power(dBm)	Maximum allowed Power (dBm)	Scaling factor	Measured SAR(10g) (W/kg)	Reported SAR(10g) (W/kg)	Power Drift (dB)
MHz	Ch.									
848.8	251	GPRS (4)	Right	Fig.1	28.69	29	1.074	0.46	0.494	0.13

Note: The distance between the EUT and the phantom bottom is 0mm

Table 14.13: SAR Values (GSM 850 MHz Band–Body)

Frequency		Mode (number of timeslots)	Test Position	Figure No.	Measured average power(dBm)	Maximum allowed Power (dBm)	Scaling factor	Measured SAR(1g) (W/kg)	Reported SAR(1g) (W/kg)	Power Drift (dB)
MHz	Ch.									
848.8	251	GPRS (4)	Right	Fig.2	28.69	29	1.074	0.474	0.509	-0.18

Note: The distance between the EUT and the phantom bottom is 5mm

Table 14.14: SAR Values (GSM 1900 MHz Band–Body)

Frequency		Mode (number of timeslots)	Test Position	Figure No.	Measured average power(dBm)	Maximum allowed Power (dBm)	Scaling factor	Measured SAR(10g) (W/kg)	Reported SAR(10g) (W/kg)	Power Drift (dB)
MHz	Ch.									
1850.2	512	GPRS (4)	Ground Tilt	Fig.3	25.51	26	1.119	0.887	0.993	-0.15

Note:The distance between the EUT and the phantom bottom is 0mm.

Table 14.15: SAR Values (GSM 1900 MHz Band–Body)

Frequency		Mode (number of timeslots)	Test Position	Figure No.	Measured average power(dBm)	Maximum allowed Power (dBm)	Scaling factor	Measured SAR(1g) (W/kg)	Reported SAR(1g) (W/kg)	Power Drift (dB)
MHz	Ch.									
1850.2	512	GPRS (4)	Ground Tilt	Fig.4	25.51	26	1.119	0.832	0.931	0.15
repeated										
1850.2	512	GPRS (4)	Ground Tilt	Fig.5	25.51	26	1.119	0.797	0.892	0.20

Note:The distance between the EUT and the phantom bottom is 5mm.

Table 14.16: SAR Values (WCDMA Band II–Body)

Frequency		Mode (number of timeslots)	Test Position	Figure No.	Measured average power(dBm)	Maximum allowed Power (dBm)	Scaling factor	Measured SAR(10g) (W/kg)	Reported SAR(10g) (W/kg)	Power Drift (dB)
MHz	Ch.									
1852.4	9662	12.2K RMC	Bottom	Fig.6	20.49	21	1.125	0.966	1.086	-0.10

Note: The distance between the EUT and the phantom bottom is 0mm.

Table 14.17: SAR Values (WCDMA Band II–Body)

Frequency		Mode (number of timeslots)	Test Position	Figure No.	Measured average power(dBm)	Maximum allowed Power (dBm)	Scaling factor	Measured SAR(1g) (W/kg)	Reported SAR(1g) (W/kg)	Power Drift (dB)
MHz	Ch.									
1880	9800	12.2K RMC	Ground Tilt	Fig.7	20.56	21	1.107	0.537	0.594	-0.16

Note: The distance between the EUT and the phantom bottom is 5mm.

Table 14.18: SAR Values (WCDMA Band V –Body)

Frequency		Mode (number of timeslots)	Test Position	Figure No.	Measured average power(dBm)	Maximum allowed Power (dBm)	Scaling factor	Measured SAR(10g) (W/kg)	Reported SAR(10g) (W/kg)	Power Drift (dB)
MHz	Ch.									
846.6	4232	12.2K RMC	Right	Fig.8	20.45	21	1.135	0.321	0.364	0.14

Note: The distance between the EUT and the phantom bottom is 0mm.

Table 14.19: SAR Values (WCDMA Band V –Body)

Frequency		Mode (number of timeslots)	Test Position	Figure No.	Measured average power(dBm)	Maximum allowed Power (dBm)	Scaling factor	Measured SAR(1g) (W/kg)	Reported SAR(1g) (W/kg)	Power Drift (dB)
MHz	Ch.									
846.6	4232	12.2K RMC	Right	Fig.9	20.45	21	1.135	0.208	0.236	-0.18

Note: The distance between the EUT and the phantom bottom is 5mm.

Table 14.20: SAR Values (WiFi2450–Body)

Frequency		Mode (number of timeslots)	Test Position	Figure No.	Measured average power(dBm)	Maximum allowed Power (dBm)	Scaling factor	Measured SAR(10g) (W/kg)	Reported SAR(10g) (W/kg)	Power Drift (dB)
MHz	Ch.									
2412	1	802.11 b	Right	Fig.10	14.75	15	1.059	0.242	0.256	-0.16

Note: SAR is not required for OFDM because the 802.11b adjusted SAR ≤ 3W/kg.

Note: The distance between the EUT and the phantom bottom is 0mm.

Table 14.21: SAR Values (WiFi2450–Body)

Frequency		Mode (number of timeslots)	Test Position	Figure No.	Measured average power(dBm)	Maximum allowed Power (dBm)	Scaling factor	Measured SAR(1g) (W/kg)	Reported SAR(1g) (W/kg)	Power Drift (dB)
MHz	Ch.									
2412	1	802.11 b	Right	Fig.11	14.75	15	1.059	0.228	0.242	-0.19

Note: SAR is not required for OFDM because the 802.11b adjusted SAR ≤ 1.2 W/kg.

The distance between the EUT and the phantom bottom is 5mm.

15. SAR Measurement Variability

SAR measurement variability must be assessed for each frequency band, which is determined by the SAR probe calibration point and tissue-equivalent medium used for the device measurements. When both head and body tissue-equivalent media are required for SAR measurements in a frequency band, the variability measurement procedures should be applied to the tissue medium with the highest measured SAR, using the highest measured SAR configuration for that tissue-equivalent medium.

The following procedures are applied to determine if repeated measurements are required.

- 1) Repeated measurement is not required when the original highest measured SAR is < 0.80 W/kg; steps 2) through 4) do not apply.
- 2) When the original highest measured SAR is ≥ 0.80 W/kg, repeat that measurement once.
- 3) Perform a second repeated measurement only if the ratio of largest to smallest SAR for the original and first repeated measurements is > 1.20 or when the original or repeated measurement is ≥ 1.45 W/kg (~ 10% from the 1-g SAR limit).
- 4) Perform a third repeated measurement only if the original, first or second repeated measurement is ≥ 1.5 W/kg and the ratio of largest to smallest SAR for the original, first and second repeated measurements is > 1.20 .

Table 15.1: SAR Measurement Variability for Body Value (1g)

Frequency		Test Position	Original SAR (W/kg)	First Repeated SAR (W/kg)	The Ratio
MHz	Ch.				
1850.2	512	Ground Tilt	0.832	0.797	1.053

Note: According to the KDB 865664 D01 repeated measurement is not required when the original highest measured SAR is < 0.8 W/kg.

16. Measurement Uncertainty

Error Description	Unc. value, ±%	Prob. Dist.	Div.	c _i 1g	c _i 10g	Std.Unc ±%,1g	Std.Unc ±%,10g	V _i V _{eff}
Measurement System								
Probe Calibration	6.0	N	1	1	1	6.0	6.0	∞
Axial Isotropy	0.5	R	$\sqrt{3}$	0.7	0.7	0.2	0.2	∞
Hemispherical Isotropy	2.6	R	$\sqrt{3}$	0.7	0.7	1.1	1.1	∞
Boundary Effects	0.8	R	$\sqrt{3}$	1	1	0.5	0.5	∞
Linearity	0.6	R	$\sqrt{3}$	1	1	0.3	0.3	∞
System Detection Limits	1.0	R	$\sqrt{3}$	1	1	0.6	0.6	∞
Readout Electronics	0.7	N	1	1	1	0.7	0.7	∞
Response Time	0	R	$\sqrt{3}$	1	1	0	0	∞
Integration Time	2.6	R	$\sqrt{3}$	1	1	1.5	1.5	∞
RF Ambient Noise	3.0	R	$\sqrt{3}$	1	1	1.7	1.7	∞
RF Ambient Reflections	3.0	R	$\sqrt{3}$	1	1	1.7	1.7	∞
Probe Positioner	1.5	R	$\sqrt{3}$	1	1	0.9	0.9	∞
Probe Positioning	2.9	R	$\sqrt{3}$	1	1	1.7	1.7	∞
Max. SAR Eval.	1.0	R	$\sqrt{3}$	1	1	0.6	0.6	∞
Test Sample Related								
Device Positioning	2.9	N	1	1	1	2.9	2.9	145
Device Holder	3.6	N	1	1	1	3.6	3.6	5
Dipole								
Power Drift	5.0	R	$\sqrt{3}$	1	1	2.9	2.9	∞
Dipole Positioning	2.0	N	1	1	1	2.0	2.0	∞
Dipole Input Power	5.0	N	1	1	1	5.0	5.0	∞
Phantom and Setup								
Phantom Uncertainty	4.0	R	$\sqrt{3}$	1	1	2.3	2.3	∞
Liquid Conductivity (target)	5.0	R	$\sqrt{3}$	0.64	0.43	1.8	1.2	∞
Liquid Conductivity (meas.)	2.5	N	1	0.64	0.43	1.6	1.1	∞
Liquid Permittivity (target)	5.0	R	$\sqrt{3}$	0.6	0.49	1.7	1.4	∞
Liquid Permittivity (meas.)	2.5	N	1	0.6	0.49	1.5	1.2	∞
Combined Std Uncertainty								
						±11.2%	±10.9%	387
Expanded Std Uncertainty								
						±22.4%	±21.8%	

17. Main Test Instrument

Table 17.1: List of Main Instruments

No.	Name	Type	Serial Number	Calibration Date	Valid Period
01	Network analyzer	N5242A	MY51221755	Jan 6, 2017	1 year
02	Power meter	NRVD	102257	May 10, 2017	1 year
03	Power sensor	NRV-Z5	100644		
			100241		
04	Signal Generator	E4438C	MY49072044	Jan 6, 2017	1 year
05	Amplifier	NTWPA-0086010F	12023024	No Calibration Requested	
06	Coupler	778D	MY4825551	May 10, 2017	1 year
07	BTS	E5515C	MY50266468	Jan 6, 2017	1 year
08	E-field Probe	EX3DV4	3754	Jan 13,2017	1 year
09	DAE	SPEAG DAE4	1244	Dec 12,2016	1 year
10	Dipole Validation Kit	SPEAG D835V2	4d112	Oct 22, 2015	2 year
		SPEAG D1900V2	5d134	Nov 4,2015	2 year
		SPEAG D2450V2	858	Oct 30,2015	2 year

ANNEX A. GRAPH RESULTS

GPRS 850MHz 4TS Right Mode high 0mm

Date/Time: 2017-7-10

Electronics: DAE4 Sn1244

Medium: Body 850MHz

Medium parameters used: $f = 849 \text{ MHz}$; $\sigma = 1.015 \text{ S/m}$; $\epsilon_r = 56.966$; $\rho = 1000 \text{ kg/m}^3$

Ambient Temperature:22°C Liquid Temperature:22°C

Communication System: GSM 850MHz GPRS 4TS (0); Frequency: 848.8 MHz; Duty Cycle: 1:2

Probe: EX3DV4 - SN3754ConvF(9.66, 9.66, 9.66); Calibrated: 1/13/2017

GPRS 850MHz 4TS Right Mode high/Area Scan (81x151x1):

Measurement grid: $dx=10 \text{ mm}$, $dy=10 \text{ mm}$

Maximum value of SAR (Measurement) = 0.732 W/kg

GPRS 850MHz 4TS Right Mode high/Zoom Scan (7x7x7)/Cube 0:

Measurement grid: $dx=5\text{mm}$, $dy=5\text{mm}$, $dz=5\text{mm}$

Reference Value = 19.47 V/m; Power Drift = -0.13 dB

Peak SAR (extrapolated) = 0.934 W/kg

SAR(1 g) = 0.664 W/kg; SAR(10 g) = 0.460 W/kg

Maximum value of SAR (measured) = 0.713 W/kg

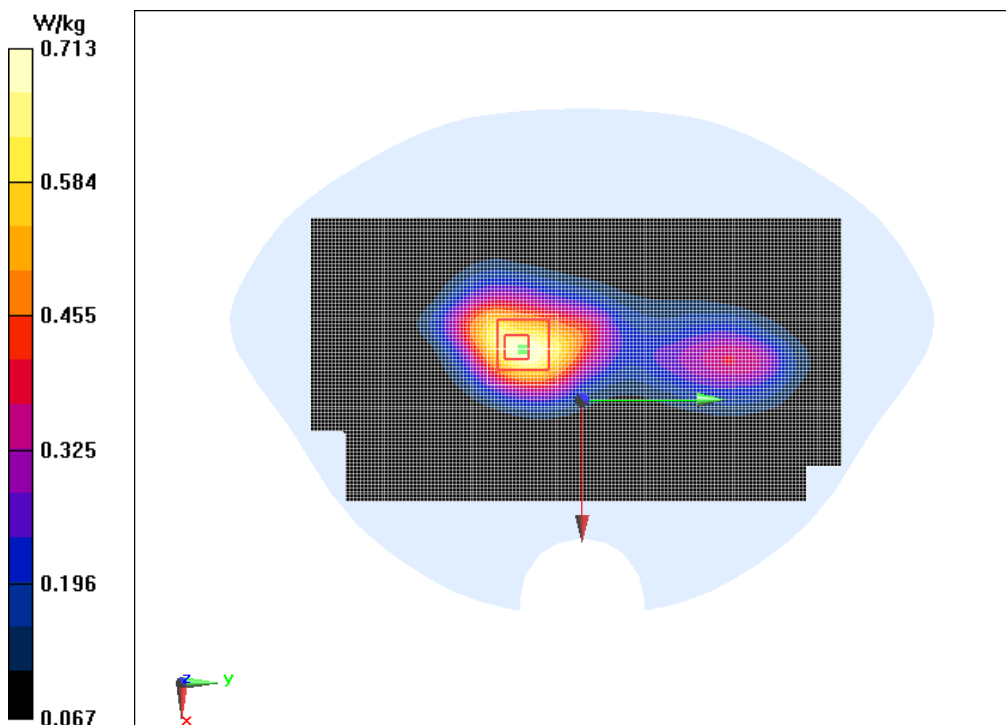

Fig.1 GPRS 850MHz 4TS Right Mode high

GPRS 850MHz 4TS Right Mode high 5mm

Date/Time: 2017-7-10

Electronics: DAE4 Sn1244

Medium: Body 850MHz

Medium parameters used: $f = 849 \text{ MHz}$; $\sigma = 1.015 \text{ S/m}$; $\epsilon_r = 56.966$; $\rho = 1000 \text{ kg/m}^3$

Ambient Temperature: 22°C Liquid Temperature: 22°C

Communication System: GSM 850MHz GPRS 4TS (0); Frequency: 848.8 MHz; Duty Cycle: 1:2

Probe: EX3DV4 - SN3754ConvF(9.66, 9.66, 9.66); Calibrated: 1/13/2017

GPRS 850MHz 4TS Right Mode high/Area Scan (81x151x1):

Measurement grid: $dx=10 \text{ mm}$, $dy=10 \text{ mm}$

Maximum value of SAR (Measurement) = 0.518 W/kg

GPRS 850MHz 4TS Right Mode high/Zoom Scan (7x7x7)/Cube 0:

Measurement grid: $dx=5\text{mm}$, $dy=5\text{mm}$, $dz=5\text{mm}$

Reference Value = 17.85 V/m; Power Drift = -0.18 dB

Peak SAR (extrapolated) = 0.630 W/kg

SAR(1 g) = 0.474 W/kg; SAR(10 g) = 0.342 W/kg

Maximum value of SAR (measured) = 0.503 W/kg

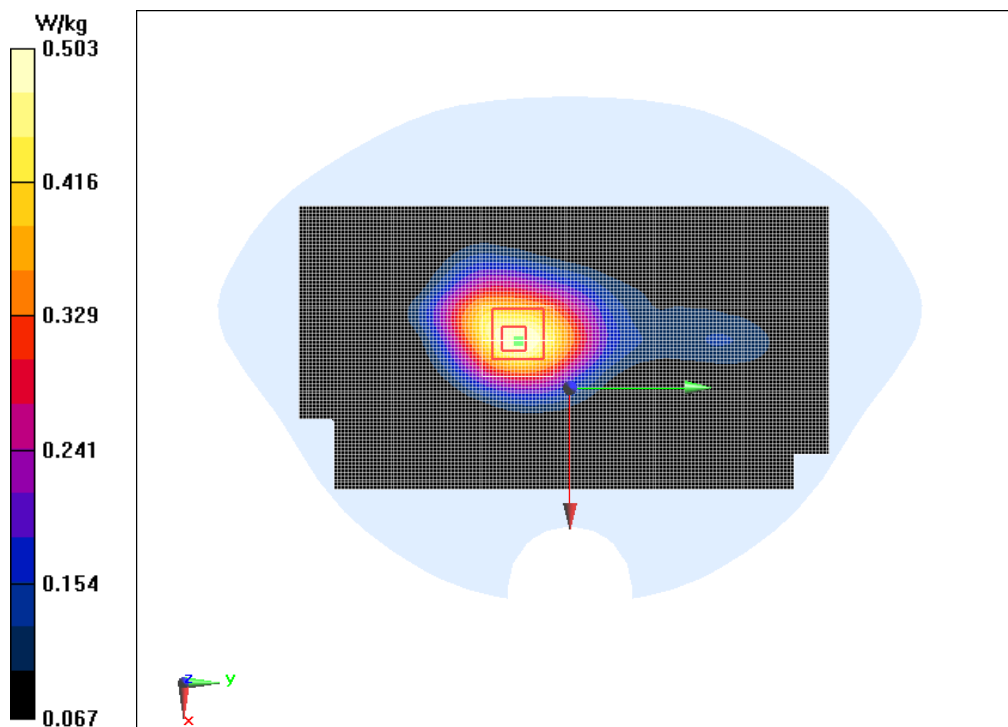

Fig.2 GPRS 850MHz 4TS Right Mode high

GPRS 1900MHz 4TS Ground Mode High 0mm Tilt

Date/Time: 2017-7-11

Electronics: DAE4 Sn1244

Medium: Body 1900MHz

Medium parameters used (interpolated): $f = 1850.2$ MHz; $\sigma = 1.475$ S/m; $\epsilon_r = 53.44$; $\rho = 1000$ kg/m³

Ambient Temperature:22°C Liquid Temperature:22°C

Communication System: GSM 1900MHz GPRS 4TS (0); Frequency: 1850.2 MHz; Duty Cycle: 1:2

Probe: EX3DV4 - SN3754ConvF(7.6, 7.6, 7.6); Calibrated: 1/13/2017

GPRS 1900MHz 4TS Ground Mode High 0mm Tilt /Area Scan (81x151x1):

Measurement grid: dx=10 mm, dy=10 mm

Maximum value of SAR (Measurement) = 1.90 W/kg

GPRS 1900MHz 4TS Ground Mode High 0mm Tilt /Zoom Scan (7x7x7)/Cube 0:

Measurement grid: dx=5mm, dy=5mm, dz=5mm

Reference Value = 12.76 V/m; Power Drift = -0.15 dB

Peak SAR (extrapolated) = 3.11 W/kg

SAR(1 g) = 1.68 W/kg; SAR(10 g) = 0.887 W/kg

Maximum value of SAR (measured) = 1.90 W/kg

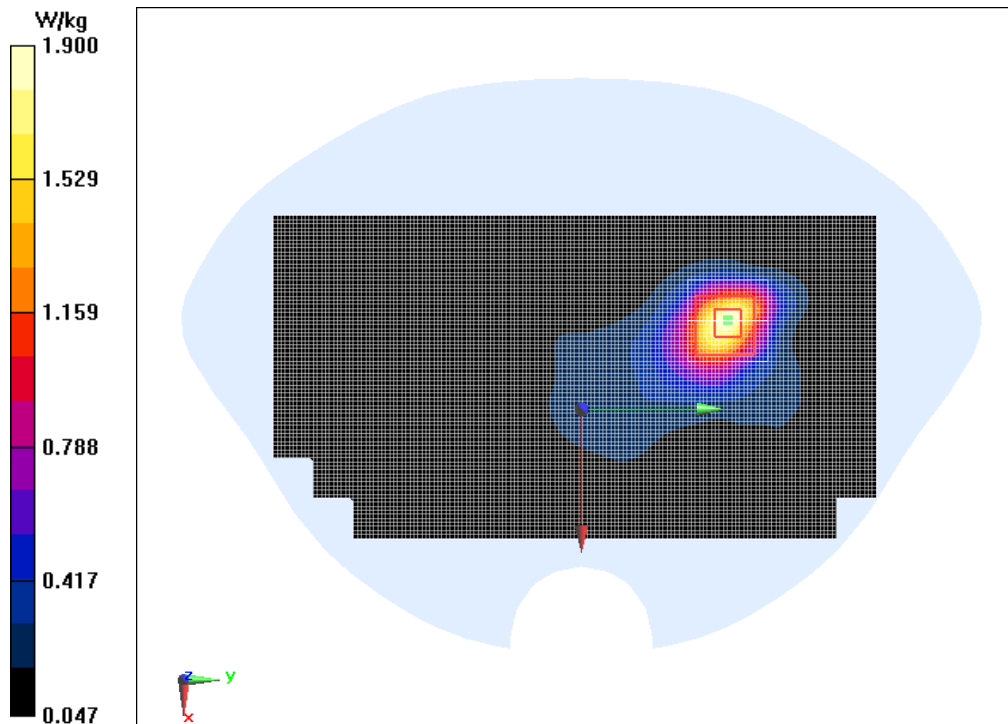

Fig.3 GPRS 1900MHz 4TS Ground Mode High 0mm Tilt

GPRS 1900MHz 4TS Ground Mode Low 5mm Tilt

Date/Time: 2017-7-11

Electronics: DAE4 Sn1244

Medium: Body 1900MHz

Medium parameters used (interpolated): $f = 1850.2$ MHz; $\sigma = 1.475$ S/m; $\epsilon_r = 53.44$; $\rho = 1000$ kg/m³

Ambient Temperature:22°C Liquid Temperature:22°C

Communication System: GSM 1900MHz GPRS 4TS (0); Frequency: 1850.2 MHz; Duty Cycle: 1:2

Probe: EX3DV4 - SN3754ConvF(7.6, 7.6, 7.6); Calibrated: 1/13/2017

GPRS 1900MHz 4TS Ground Mode Low 5mm Tilt/Area Scan (81x151x1):

Measurement grid: dx=10 mm, dy=10 mm

Maximum value of SAR (Measurement) = 0.954 W/kg

GPRS 1900MHz 4TS Ground Mode Low 5mm Tilt/Zoom Scan (7x7x7)/Cube 0:

Measurement grid: dx=5mm, dy=5mm, dz=5mm

Reference Value = 10.09 V/m; Power Drift = 0.15 dB

Peak SAR (extrapolated) = 1.46 W/kg

SAR(1 g) = 0.832 W/kg; SAR(10 g) = 0.466 W/kg

Maximum value of SAR (measured) = 0.922 W/kg

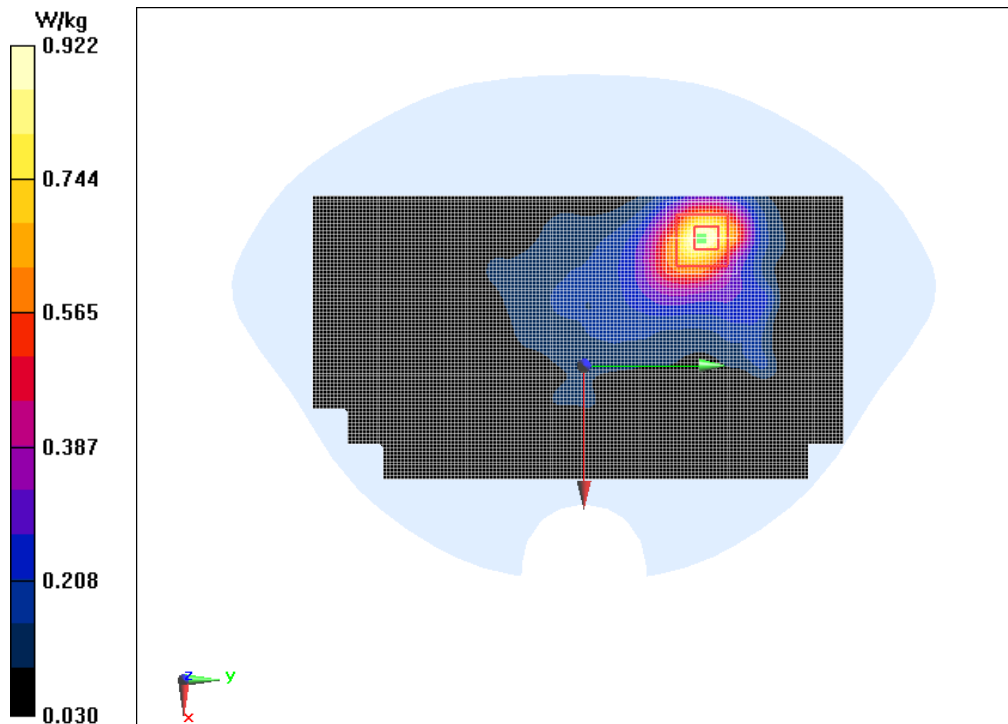

Fig.4 GPRS 1900MHz 4TS Ground Mode Low 5mm Tilt

GPRS 1900MHz 4TS Ground Mode Low 5mm Tilt Repeated

Date/Time: 2017-7-11

Electronics: DAE4 Sn1244

Medium: Body 1900MHz

Medium parameters used (interpolated): $f = 1850.2$ MHz; $\sigma = 1.475$ S/m; $\epsilon_r = 53.44$; $\rho = 1000$ kg/m³

Ambient Temperature:22°C Liquid Temperature:22°C

Communication System: GSM 1900MHz GPRS 4TS (0); Frequency: 1850.2 MHz; Duty Cycle: 1:2

Probe: EX3DV4 - SN3754ConvF(7.6, 7.6, 7.6); Calibrated: 1/13/2017

GPRS 1900MHz 4TS Ground Mode Low 5mm Tilt Repeated/Area Scan (81x151x1):

Measurement grid: dx=10 mm, dy=10 mm

Maximum value of SAR (Measurement) = 0.917 W/kg

GPRS1900MHz 4TS Ground Mode Low 5mm Tilt Repeated/Zoom Scan (7x7x7)/Cube 0:

Measurement grid: dx=5mm, dy=5mm, dz=5mm

Reference Value = 10.17 V/m; Power Drift = 0.20 dB

Peak SAR (extrapolated) = 1.35 W/kg

SAR(1 g) = 0.797 W/kg; SAR(10 g) = 0.453 W/kg

Maximum value of SAR (measured) = 0.865 W/kg

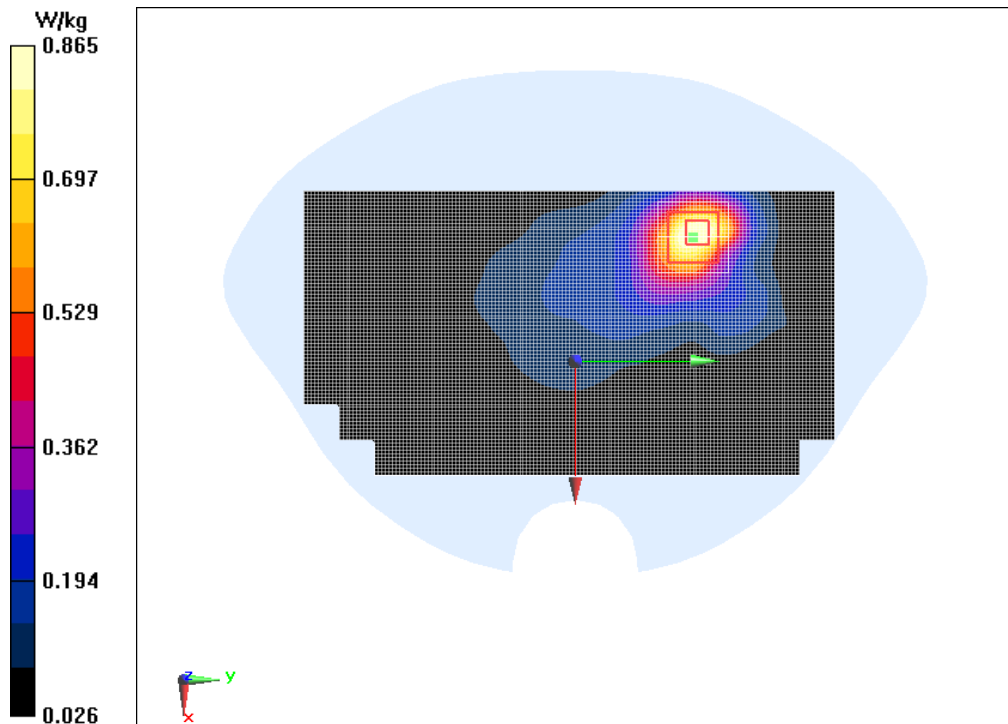

Fig.5 GPRS 1900MHz 4TS Ground Mode Low 5mm Tilt Repeated

WCDMA Band 2 Ground Mode Low Tilt 0mm

Date/Time: 2017-7-11

Electronics: DAE4 Sn1244

Medium: Body 1900MHz

Medium parameters used (interpolated): $f = 1852.4$ MHz; $\sigma = 1.477$ S/m; $\epsilon_r = 53.431$; $\rho = 1000$ kg/m³

Ambient Temperature:22°C Liquid Temperature:22°C

Communication System: WCDMA Professional Band II; Frequency: 1852.4 MHz; Duty Cycle: 1:1

Probe: EX3DV4 - SN3754ConvF(7.6, 7.6, 7.6); Calibrated: 1/13/2017

WCDMA Band 2 Ground Mode Low Tilt 0mm/Area Scan (81x151x1):

Measurement grid: dx=10 mm, dy=10 mm

Maximum value of SAR (interpolated) = 1.94 W/kg

WCDMA and 2 round Mode Low Tilt 0mm/Zoom Scan (7x7x7)/Cube 0: Measurement grid:

dx=5mm, dy=5mm, dz=5mm

Reference Value = 15.79 V/m; Power Drift = -0.10dB

Peak SAR (extrapolated) = 3.29 W/kg

SAR(1 g) = 1.82 W/kg; SAR(10 g) = 0.966 W/kg

Maximum value of SAR (measured) = 2.03 W/kg

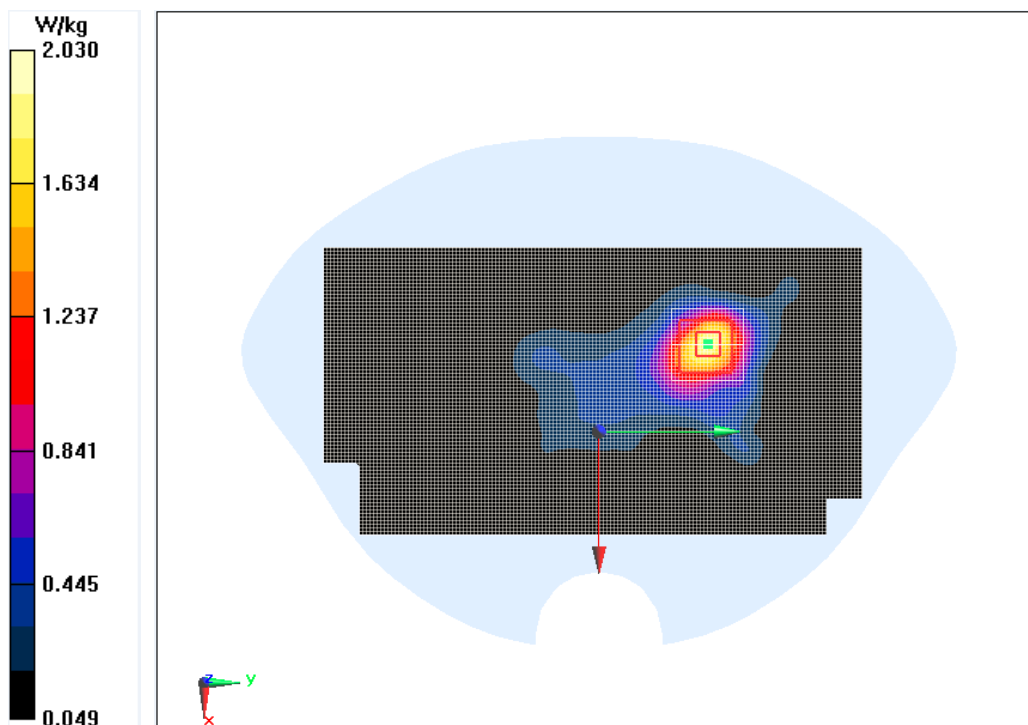

Fig.6 WCDMA Band 2 Ground Mode Low Tilt 0mm

WCDMA Band 2 Ground Mode Middle Tilt 5mm

Date/Time: 2017-7-11

Electronics: DAE4 Sn1244

Medium: Body 1900MHz

Medium parameters used: $f = 1880$ MHz; $\sigma = 1.504$ S/m; $\epsilon_r = 53.319$; $\rho = 1000$ kg/m³

Ambient Temperature: 22°C Liquid Temperature: 22°C

Communication System: WCDMA Professional Band II; Frequency: 1880 MHz; Duty Cycle: 1:1

Probe: EX3DV4 - SN3754ConvF(7.6, 7.6, 7.6); Calibrated: 1/13/2017

WCDMA Band 2 Ground Mode Middle Tilt 5mm/Area Scan (81x151x1):

Measurement grid: dx=10 mm, dy=10 mm

Maximum value of SAR (Measurement) = 0.632 W/kg

WCDMA Band 2 Ground Mode Middle Tilt 5mm/Zoom Scan (7x7x7)/Cube 0:

Measurement grid: dx=5mm, dy=5mm, dz=5mm

Reference Value = 10.64 V/m; Power Drift = -0.16 dB

Peak SAR (extrapolated) = 0.900 W/kg

SAR(1 g) = 0.537 W/kg; SAR(10 g) = 0.312 W/kg

Maximum value of SAR (measured) = 0.589 W/kg

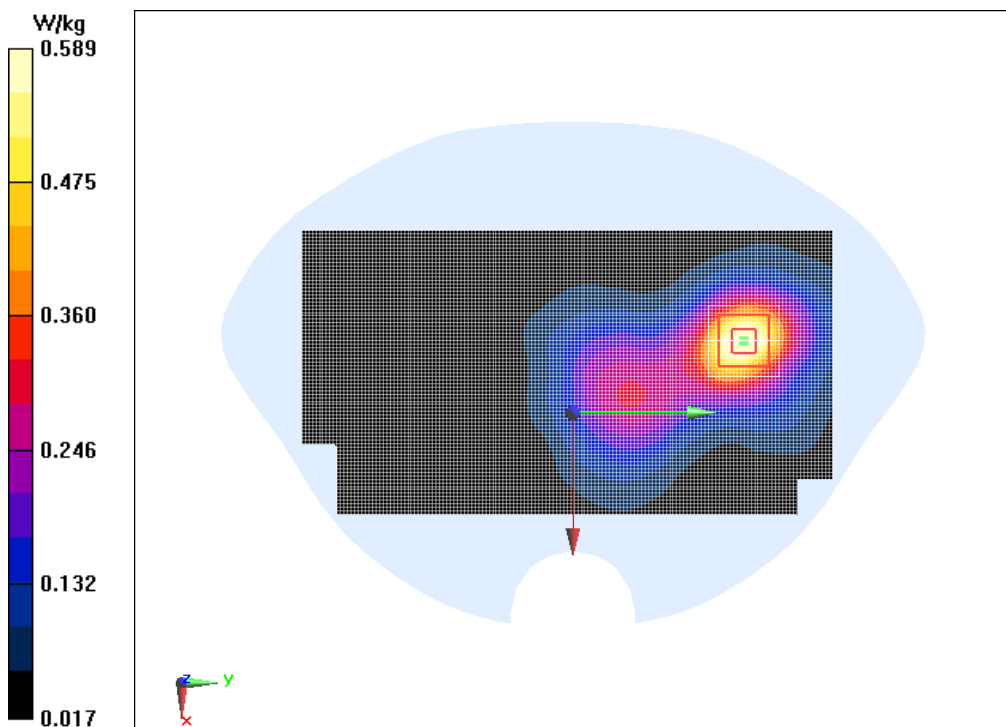

Fig.7 WCDMA Band 2 Ground Mode Middle Tilt 5mm

WCDMA Band5 Right Mode High 0mm

Date/Time: 2017-7-10

Electronics: DAE4 Sn1244

Medium: Body 850MHz

Medium parameters used: $f = 847 \text{ MHz}$; $\sigma = 1.012 \text{ S/m}$; $\epsilon_r = 56.994$; $\rho = 1000 \text{ kg/m}^3$

Ambient Temperature:22°C Liquid Temperature:22°C

Communication System: WCDMA Professional Band V; Frequency: 846.6 MHz; Duty Cycle: 1:1

Probe: EX3DV4 - SN3754ConvF(9.66, 9.66, 9.66); Calibrated: 1/13/2017

WCDMA Band5 Right Mode High/Area Scan (71x131x1):

Measurement grid: $dx=10 \text{ mm}$, $dy=10 \text{ mm}$

Maximum value of SAR (Measurement) = 0.506 W/kg

WCDMA Band5 Right Mode High/Zoom Scan (7x7x7)/Cube 0:

Measurement grid: $dx=5\text{mm}$, $dy=5\text{mm}$, $dz=5\text{mm}$

Reference Value = 13.01 V/m; Power Drift = 0.14 dB

Peak SAR (extrapolated) = 0.679 W/kg

SAR(1 g) = 0.471 W/kg; SAR(10 g) = 0.321 W/kg

Maximum value of SAR (measured) = 0.509 W/kg

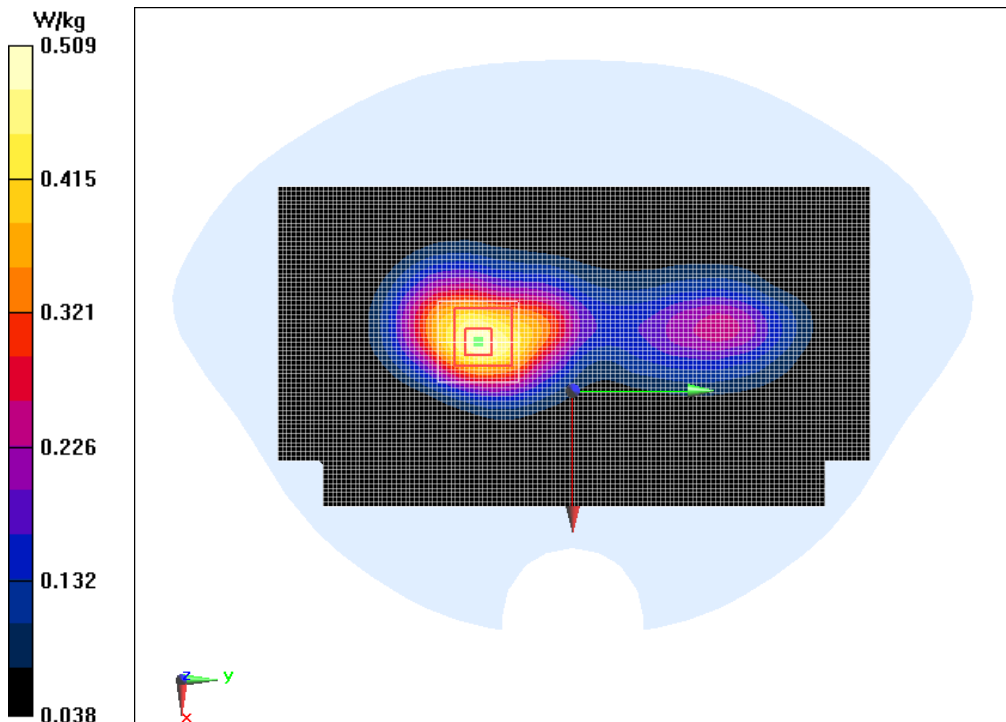

Fig.8 WCDMA Band5 Right Mode High 0mm

WCDMA Band5 Right Mode High 5mm

Date/Time: 2017-7-10

Electronics: DAE4 Sn1244

Medium: Body 850MHz

Medium parameters used: $f = 847$ MHz; $\sigma = 1.012$ S/m; $\epsilon_r = 56.994$; $\rho = 1000$ kg/m³

Ambient Temperature: 22°C Liquid Temperature: 22°C

Communication System: WCDMA Professional Band V; Frequency: 846.6 MHz; Duty Cycle: 1:1

Probe: EX3DV4 - SN3754ConvF(9.66, 9.66, 9.66); Calibrated: 1/13/2017

WCDMA Band5 Right Mode High/Area Scan (71x131x1):

Measurement grid: dx=10 mm, dy=10 mm

Maximum value of SAR (Measurement) = 0.226 W/kg

WCDMA Band5 Right Mode High/Zoom Scan (7x7x7)/Cube 0:

Measurement grid: dx=5mm, dy=5mm, dz=5mm

Reference Value = 12.06 V/m; Power Drift = -0.18 dB

Peak SAR (extrapolated) = 0.279 W/kg

SAR(1 g) = 0.208 W/kg; SAR(10 g) = 0.148 W/kg

Maximum value of SAR (measured) = 0.221 W/kg

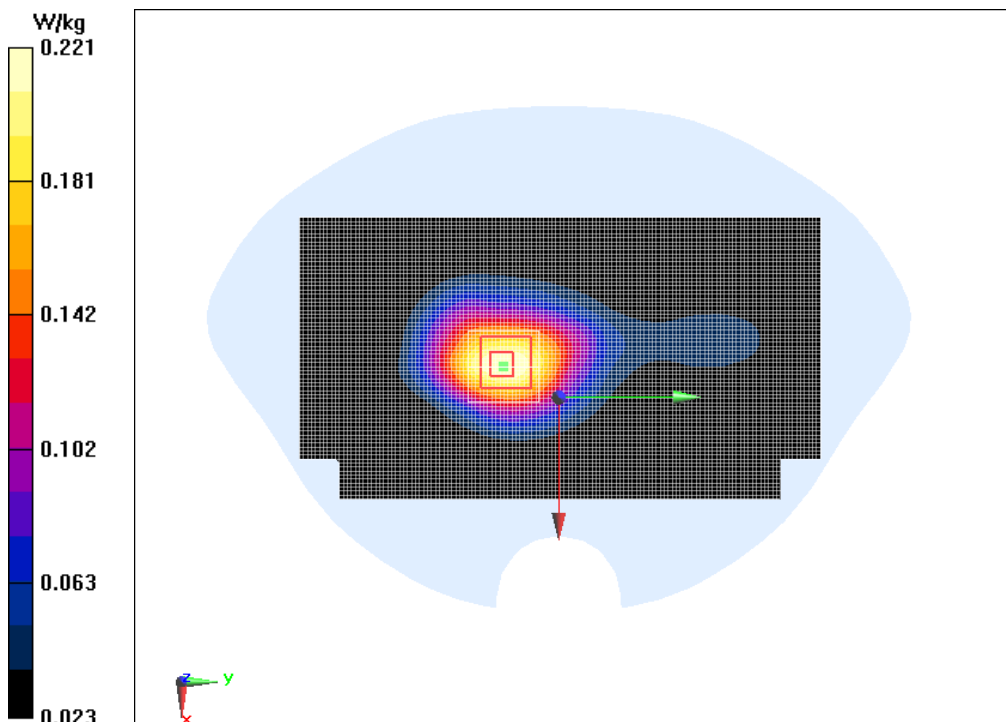

Fig.9 WCDMA Band5 Right Mode High 5mm

WiFi 802.11b Right Mode Low 0mm

Date/Time: 2017-7-12

Electronics: DAE4 Sn1244

Medium: Body 2450MHz

Medium parameters used: $f = 2412 \text{ MHz}$; $\sigma = 1.933 \text{ S/m}$; $\epsilon_r = 53.003$; $\rho = 1000 \text{ kg/m}^3$

Ambient Temperature: 22°C Liquid Temperature: 22°C

Communication System: Wifi 2450 2450MHz; Frequency: 2412 MHz; Duty Cycle: 1:1

Probe: EX3DV4 - SN3754ConvF(7.22, 7.22, 7.22); Calibrated: 1/13/2017

WiFi 802.11b Right Mode Low/Area Scan (71x131x1):

Measurement grid: $dx=10 \text{ mm}$, $dy=10 \text{ mm}$

Maximum value of SAR (Measurement) = 0.651 W/kg

WiFi 802.11b Right Mode Low/Zoom Scan (7x7x7)/Cube 0:

Measurement grid: $dx=5\text{mm}$, $dy=5\text{mm}$, $dz=5\text{mm}$

Reference Value = 8.872 V/m; Power Drift = -0.12 dB

Peak SAR (extrapolated) = 1.59 W/kg

SAR(1 g) = 0.620 W/kg; SAR(10 g) = 0.242 W/kg

Maximum value of SAR (measured) = 0.703 W/kg

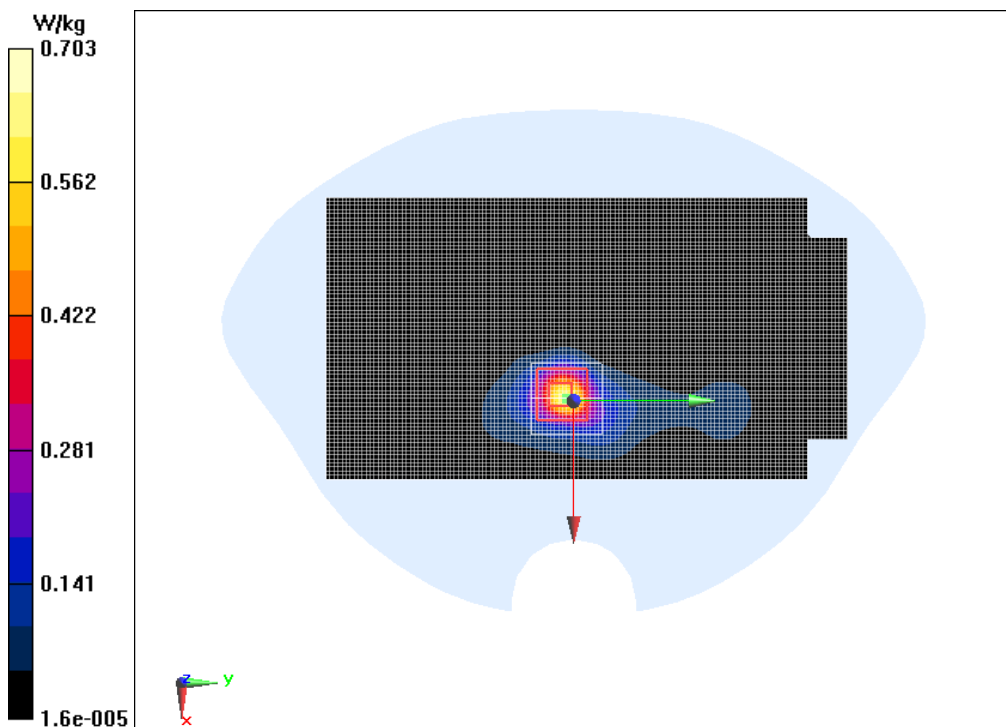

Fig.10 WiFi 802.11b Right Mode Low 0mm

WiFi 802.11b Right Mode Low 5mm

Date/Time: 2017-7-12

Electronics: DAE4 Sn1244

Medium: Body 2450MHz

Medium parameters used: $f = 2412 \text{ MHz}$; $\sigma = 1.933 \text{ S/m}$; $\epsilon_r = 53.003$; $\rho = 1000 \text{ kg/m}^3$

Ambient Temperature:22°C Liquid Temperature:22°C

Communication System: Wifi 2450 2450MHz; Frequency: 2412 MHz; Duty Cycle: 1:1

Probe: EX3DV4 - SN3754ConvF(7.22, 7.22, 7.22); Calibrated: 1/13/2017

WiFi 802.11b Right Mode Low 5mm/Area Scan (71x131x1):

Measurement grid: $dx=10 \text{ mm}$, $dy=10 \text{ mm}$

Maximum value of SAR (Measurement) = 0.253 W/kg

WiFi 802.11b Right Mode Low 5mm /Zoom Scan (7x7x7)/Cube 0:

Measurement grid: $dx=5\text{mm}$, $dy=5\text{mm}$, $dz=5\text{mm}$

Reference Value = 4.490 V/m; Power Drift = -0.19 dB

Peak SAR (extrapolated) = 0.508 W/kg

SAR(1 g) = 0.228 W/kg; SAR(10 g) = 0.100 W/kg

Maximum value of SAR (measured) = 0.260 W/kg

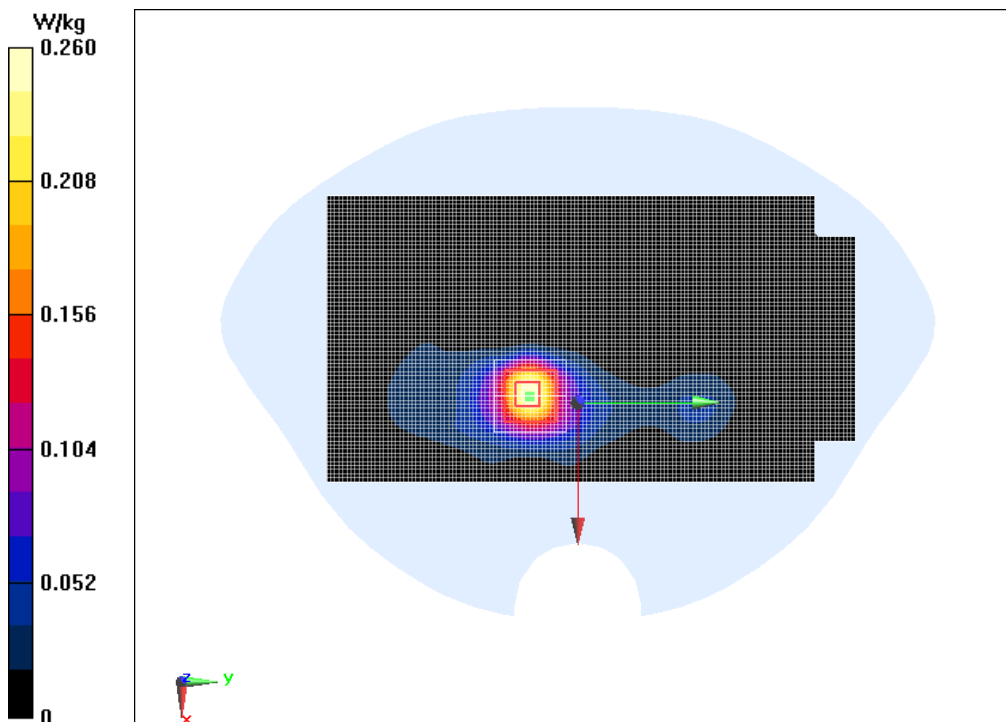

Fig.11 WiFi 802.11b Right Mode Low 5mm

ANNEX B. SYSTEM VALIDATION RESULTS

835 MHz Body

Date/Time: 2017/7/10

Electronics: DAE4 Sn1244

Medium: Body 835MHz

Medium parameters used: $f = 835 \text{ MHz}$; $\sigma = 1.001 \text{ S/m}$; $\epsilon_r = 57.108$; $\rho = 1000 \text{ kg/m}^3$

Ambient Temperature: $22.5 \text{ }^\circ\text{C}$ Liquid Temperature: $22.5 \text{ }^\circ\text{C}$

Communication System: CW 850MHz; Frequency: 835 MHz; Duty Cycle: 1:1

Probe: EX3DV4 - SN3754ConvF(9.66, 9.66, 9.66); Calibrated: 1/13/2017

System Validation/Area Scan (60x120x1):

Measurement grid: $dx=10 \text{ mm}$, $dy=10 \text{ mm}$

Maximum value of SAR (Measurement) = 2.78 W/kg

System Validation/Zoom Scan(7x7x7)/Cube 0:

Measurement grid: $dx=5\text{mm}$, $dy=5\text{mm}$, $dz=5\text{mm}$

Reference Value = 54.32 V/m; Power Drift = 0.05 dB

Peak SAR (extrapolated) = 3.54 W/kg

SAR(1 g) = 2.42 W/kg; SAR(10 g) = 1.59 W/kg

Maximum value of SAR (measured) = 2.80 W/kg

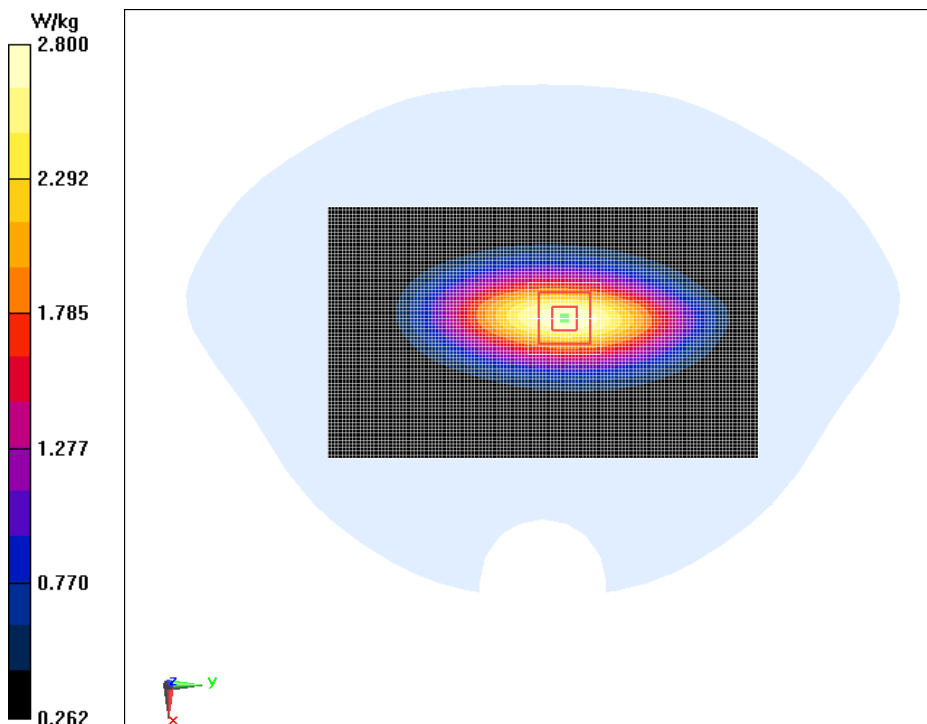

1900MHz Body

Date/Time: 2017/7/11

Electronics: DAE4 Sn1244

Medium: Body 1900MHz

Medium parameters used: $f = 1900$ MHz; $\sigma = 1.524$ S/m; $\epsilon_r = 53.237$; $\rho = 1000$ kg/m³

Ambient Temperature: 22.5 °C Liquid Temperature: 22.5 °C

Communication System: CW 1900MHz; Frequency: 1900 MHz; Duty Cycle: 1:1

Probe: EX3DV4 - SN3754ConvF(7.6, 7.6, 7.6); Calibrated: 1/13/2017

System Validation/Area Scan (60x90x1):

Measurement grid: dx=10 mm, dy=10 mm

Maximum value of SAR (Measurement) = 14.8 W/kg

System Validation/Zoom Scan(7x7x7)/Cube 0:

Measurement grid: dx=5mm, dy=5mm, dz=5mm

Reference Value = 94.26 V/m; Power Drift = 0.08 dB

Peak SAR (extrapolated) = 18.8 W/kg

SAR(1 g) = 10.3 W/kg; SAR(10 g) = 5.21 W/kg

Maximum value of SAR (measured) = 14.9 W/kg

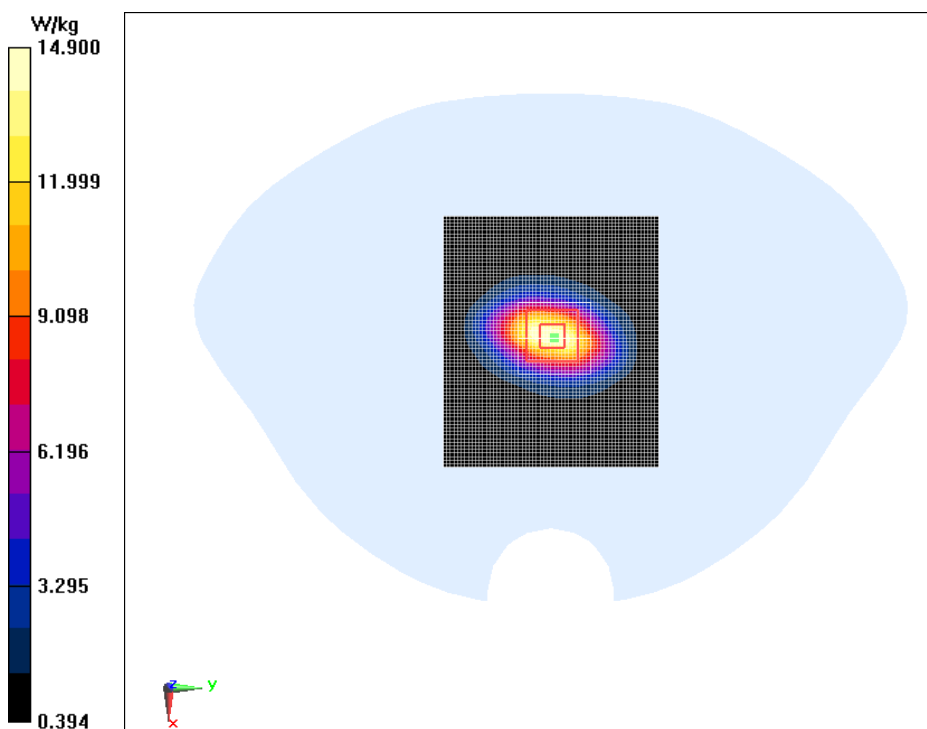

2450MHz Body

Date/Time: 2017/7/12

Electronics: DAE4 Sn1244

Medium: Body 2450 MHz

Medium parameters used: $f = 2450$ MHz; $\sigma = 1.978$ S/m; $\epsilon_r = 52.879$; $\rho = 1000$ kg/m³

Ambien Temperature: 22.5° C Liquid Temperature: 22.5° C

Communication System: CW; Frequency: 2450 MHz; Duty Cycle: 1:1

Probe: EX3DV4 - SN3754ConvF(7.22, 7.22, 7.22); Calibrated: 1/13/2017

System Validation/ Area Scan (100x100x1):

Measurement grid: dx=10mm, dy=10mm

Maximum value of SAR (measured) = 20.8 W/kg

System Validation/Zoom Scan (7x7x7)/Cube 0:

Measurement grid: dx=5mm, dy=5mm, dz=5mm

Reference Value = 104.7 V/m; Power Drift = -0.14 dB

Peak SAR (extrapolated) = 28.45 W/kg

SAR(1 g) = 12.9 W/kg; SAR(10 g) = 5.92 W/kg

Maximum value of SAR (measured) = 20.3 W/kg

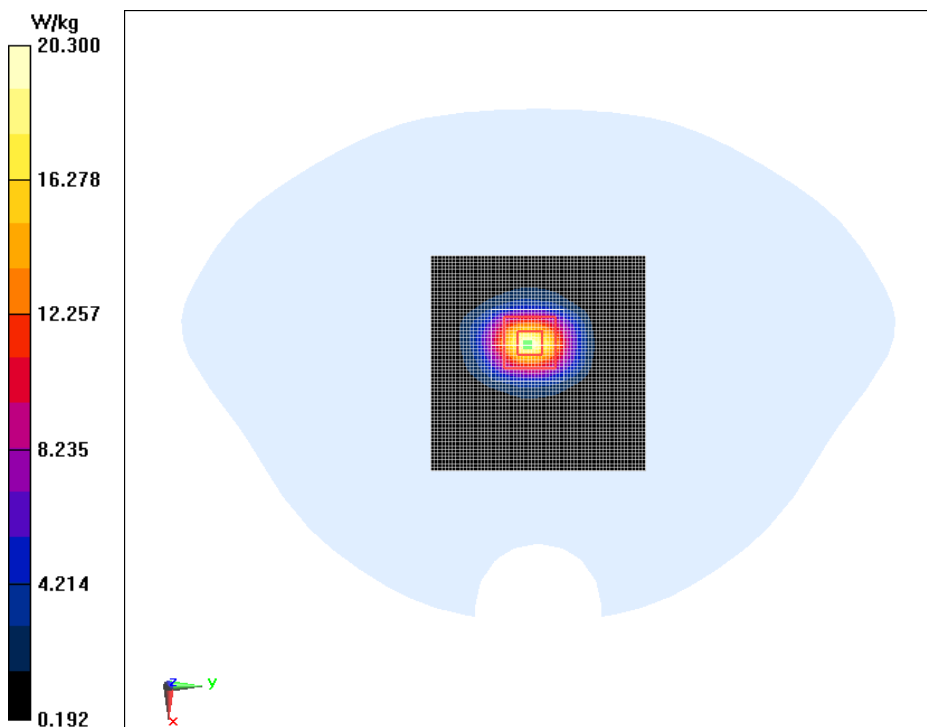

ANNEX C. SAR Measurement Setup

C.1. Measurement Set-up

The DASY5 system for performing compliance tests is illustrated above graphically. This system consists of the following items:

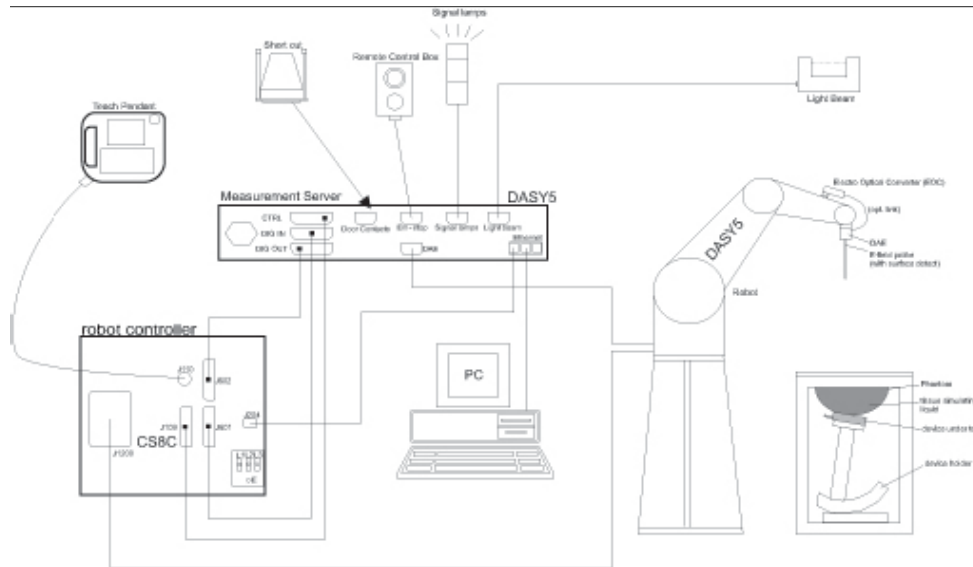

Picture C.1 SAR Lab Test Measurement Set-up

- A standard high precision 6-axis robot (Stäubli TX=RX family) with controller, teach pendant and software. An arm extension for accommodating the data acquisition electronics (DAE).
- An isotropic field probe optimized and calibrated for the targeted measurement.
- A data acquisition electronics (DAE) which performs the signal amplification, signal multiplexing, AD-conversion, offset measurements, mechanical surface detection, collision detection, etc. The unit is battery powered with standard or rechargeable batteries. The signal is optically transmitted to the EOC.
- The Electro-optical converter (EOC) performs the conversion from optical to electrical signals for the digital communication to the DAE. To use optical surface detection, a special version of the EOC is required. The EOC signal is transmitted to the measurement server.
- The function of the measurement server is to perform the time critical tasks such as signal filtering, control of the robot operation and fast movement interrupts.
- The Light Beam used is for probe alignment. This improves the (absolute) accuracy of the probe positioning.
- A computer running WinXP and the DASY5 software.
- Remote control and teach pendant as well as additional circuitry for robot safety such as
- warning lamps, etc.

- The phantom, the device holder and other accessories according to the targeted measurement.

C.2. DASY5 E-field Probe System

The SAR measurements were conducted with the dosimetric probe designed in the classical triangular configuration and optimized for dosimetric evaluation. The probe is constructed using the thick film technique; with printed resistive lines on ceramic substrates. The probe is equipped with an optical multifiber line ending at the front of the probe tip. It is connected to the EOC box on the robot arm and provides an automatic detection of the phantom surface. Half of the fibers are connected to a pulsed infrared transmitter, the other half to a synchronized receiver. As the probe approaches the surface, the reflection from the surface produces a coupling from the transmitting to the receiving fibers. This reflection increases first during the approach, reaches maximum and then decreases. If the probe is flatly touching the surface, the coupling is zero. The distance of the coupling maximum to the surface is independent of the surface reflectivity and largely independent of the surface to probe angle. The DASY5 software reads the reflection during a software approach and looks for the maximum using 2nd order curve fitting. The approach is stopped at reaching the maximum.

Probe Specifications:

Model: EX3DV4

Frequency

Range: 700MHz — 2.6GHz

Calibration: In head and body simulating tissue at
Frequencies from 835 up to 2450MHz

Linearity:
 $\pm 0.2 \text{ dB}(700\text{MHz} — 2.0\text{GHz})$

Dynamic Range: 10 mW/kg — 100W/kg

Probe Length: 330 mm

Probe Tip

Length: 20 mm

Body Diameter: 12 mm

Tip Diameter: 2.5 mm

Tip-Center: 1 mm

Application:SAR Dosimetry Testing

Compliance tests of mobile phones

Dosimetry in strong gradient fields



Picture C.2 Near-field Probe



Picture C.3 E-field Probe

C.3. E-field Probe Calibration

Each E-Probe/Probe Amplifier combination has unique calibration parameters. A TEM cell calibration procedure is conducted to determine the proper amplifier settings to enter in the probe parameters. The amplifier settings are determined for a given frequency by subjecting the probe to a known E-field density (1 mW/cm²) using an RF Signal generator, TEM cell, and RF Power Meter.

The free space E-field from amplified probe outputs is determined in a test chamber. This calibration can be performed in a TEM cell if the frequency is below 1 GHz and in a waveguide or other methodologies above 1 GHz for free space. For the free space calibration, the probe is placed in the volumetric center of the cavity and at the proper orientation with the field. The probe is then rotated 360 degrees until the three channels show the maximum reading. The power density readings equate to 1 mW/cm².

E-field temperature correlation calibration is performed in a flat phantom filled with the appropriate simulated brain tissue. The E-field in the medium correlates with the temperature rise in the dielectric medium. For temperature correlation calibration a RF transparent thermistor-based temperature probe is used in conjunction with the E-field probe.

$$SAR = C \frac{\Delta T}{\Delta t}$$

Where:

Δt = Exposure time (30 seconds),

C = Heat capacity of tissue (brain or muscle),

ΔT = Temperature increase due to RF exposure.

$$SAR = \frac{|E|^2 \cdot \sigma}{\rho}$$

Where:

σ = Simulated tissue conductivity,

ρ = Tissue density (kg/m³).

C.4. Other Test Equipment

C.4.1. Data Acquisition Electronics(DAE)

The data acquisition electronics consist of a highly sensitive electrometer-grade preamplifier with auto-zeroing, a channel and gain-switching multiplexer, a fast 16 bit AD-converter and a command decoder with a control logic unit. Transmission to the measurement server is accomplished through an optical downlink for data and status information, as well as an optical uplink for

commands and the clock.

The mechanical probe mounting device includes two different sensor systems for frontal and sideways probe contacts. They are used for mechanical surface detection and probe collision detection.

The input impedance of the DAE is 200 MOhm; the inputs are symmetrical and floating. Common mode rejection is above 80 dB.



PictureC.4: DAE

C.4.2. Robot

The SPEAG DASY system uses the high precision robots (DASY5: RX90L) type from Stäubli SA (France). For the 6-axis controller system, the robot controller version from Stäubli is used. The Stäubli robot series have many features that are important for our application:

- High precision (repeatability 0.02mm)
- High reliability (industrial design)
- Low maintenance costs (virtually maintenance free due to direct drive gears; no belt drives)
- Jerk-free straight movements (brushless synchron motors; no stepper motors)
- Low ELF interference (motor control fields shielded via the closed metallic construction shields)



Picture C.5 DASY 5

C.4.3. Measurement Server

The Measurement server is based on a PC/104 CPU board with CPU (DASY5: 400 MHz, Intel Celeron), chipdisk (DASY5: 128MB), RAM (DASY5: 128MB). The necessary circuits for communication with the DAE electronic box, as well as the 16 bit AD converter system for optical detection and digital I/O interface are contained on the DASY I/O board, which is directly connected to the PC/104 bus of the CPU board.

The measurement server performs all real-time data evaluation of field measurements and surface detection, controls robot movements and handles safety operation. The PC operating system cannot interfere with these time critical processes. All connections are supervised by a watchdog, and disconnection of any of the cables to the measurement server will automatically disarm the robot and disable all program-controlled robot movements. Furthermore, the measurement server is equipped with an expansion port which is reserved for future applications. Please note that this expansion port does not have a standardized pinout, and therefore only devices provided by SPEAG can be connected. Devices from any other supplier could seriously damage the measurement server.



Picture C.6 Server for DASY 5

C.4.4. Device Holder for Phantom

The SAR in the phantom is approximately inversely proportional to the square of the distance between the source and the liquid surface. For a source at 5mm distance, a positioning uncertainty of $\pm 0.5\text{mm}$ would produce a SAR uncertainty of $\pm 20\%$. Accurate device positioning is therefore crucial for accurate and repeatable measurements. The positions in which the devices must be measured are defined by the standards.

The DASY device holder is designed to cope with the different positions given in the standard. It has two scales for device rotation (with respect to the body axis) and device inclination (with respect to the line between the ear reference points). The rotation centers for both scales is the ear reference point (ERP). Thus the device needs no repositioning when changing the angles.

The DASY device holder is constructed of low-loss POM material having the following dielectric parameters: relative permittivity $\epsilon = 3$ and loss tangent $\delta = 0.02$. The amount of dielectric material has been reduced in the closest vicinity of the device, since measurements have suggested that the influence of the clamp on the test results could thus be lowered.

<Laptop Extension Kit>

The extension is lightweight and made of POM, acrylic glass and foam. It fits easily on the upper part of the Mounting Device in place of the phone positioner. The extension is fully compatible with

the Twin-SAM and ELI phantoms.



Picture C.7: Device Holder

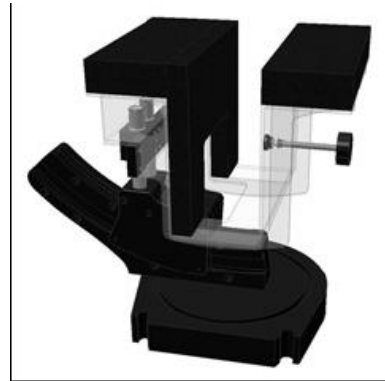

Picture C.8: Laptop Extension Kit

C.4.5. Phantom

The SAM Twin Phantom V4.0 is constructed of a fiberglass shell integrated in a table. The shape of the shell is based on data from an anatomical study designed to represent the 90th percentile of the population. The phantom enables the dissymmetric evaluation of SAR for both left and right handed handset usage, as well as body-worn usage using the flat phantom region. Reference markings on the Phantom allow the complete setup of all predefined phantom positions and measurement grids by manually teaching three points in the robot. The shell phantom has a 2mm shell thickness (except the ear region where shell thickness increases to 6 mm).

Shell Thickness: 2 ± 0.2 mm

Filling Volume: Approx. 25 liters

Dimensions: 810 x 1000 x 500 mm (H x L x W)

Available: Special



Picture C.9: SAM Twin Phantom

ANNEX D. Position of the wireless device in relation to the phantom

D.1. Generic device

For a device that can not be categorized as any of the other specific device types, it shall be considered to be a generic device;

The SAR evaluation shall be performed for all surfaces of the DUT that are accessible during intended use, as indicated in Figure 1. The separation distance in testing shall correspond to the intended use distance as specified in the user instructions provided by the manufacturer.

If the intended use is not specified, all surfaces of the DUT shall be tested directly against the flat phantom.

The surface of the generic device (or the surface of the carry accessory holding the DUT) pointing towards the flat phantom shall be parallel to the surface of the phantom.

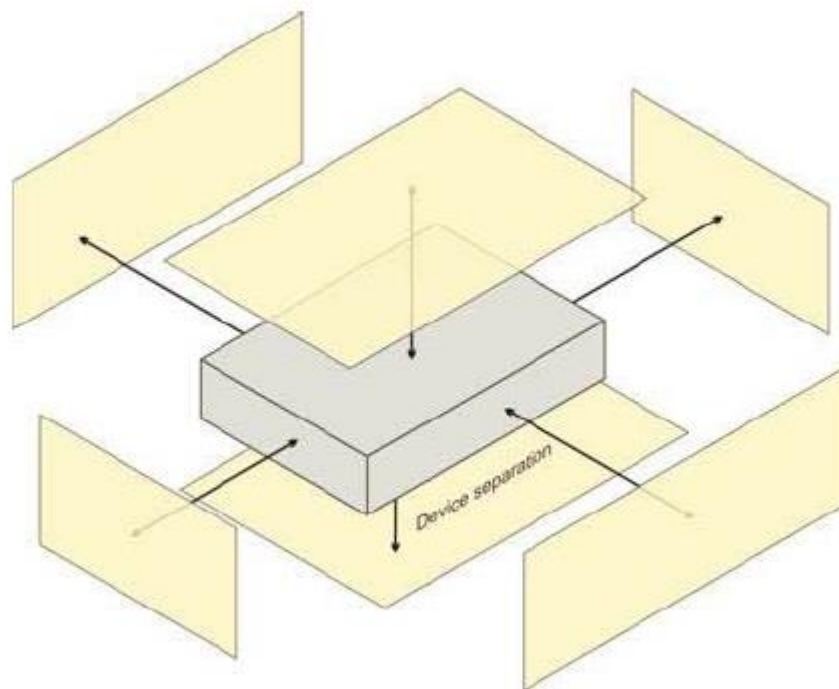

Picture D.1 Test positions for a generic device

D.2. DUT Setup Photos



Picture D.2 DSY5 system Set-up

Note:

The photos of test sample and test positions show in additional document.

ANNEX E. Equivalent Media Recipes

The liquid used for the frequency range of 800-3000 MHz consisted of water, sugar, salt, preventol, glycol monobutyl and Cellulose. The liquid has been previously proven to be suited for worst-case. The Table E.1 shows the detail solution. It's satisfying the latest tissue dielectric parameters requirements proposed by the IEEE 1528 and IEC 62209.

Table E.1: Composition of the Tissue Equivalent Matter

Frequency (MHz)	835 Head	835 Body	1900 Head	1900 Body	2450 Head	2450 Body
Ingredients (% by weight)						
Water	41.45	52.5	55.242	69.91	58.79	72.60
Sugar	56.0	45.0	\	\	\	\
Salt	1.45	1.4	0.306	0.13	0.06	0.18
Preventol	0.1	0.1	\	\	\	\
Cellulose	1.0	1.0	\	\	\	\
Glycol Monobutyl	\	\	44.452	29.96	41.15	27.22
Dielectric Parameters Target Value	$\epsilon=41.5$ $\sigma=0.90$	$\epsilon=55.2$ $\sigma=0.97$	$\epsilon=40.0$ $\sigma=1.40$	$\epsilon=53.3$ $\sigma=1.52$	$\epsilon=39.2$ $\sigma=1.80$	$\epsilon=52.7$ $\sigma=1.95$

ANNEX F. System Validation

The SAR system must be validated against its performance specifications before it is deployed.

When SAR probes, system components or software are changed, upgraded or recalibrated, these must be validated with the SAR system(s) that operates with such components.

Table F.1: System Validation Part 1

System No.	Probe SN.	Liquid name	Validation date	Frequency point	Permittivity ϵ	Conductivity σ (S/m)
01	3754	Body 835MHz	July 10, 2017	835MHz	57.108	1.001
02	3754	Body 1900MHz	July 11, 2017	1900MHz	53.237	1.524
03	3754	Body 2450MHz	July 12, 2017	2450MHz	52.879	1.978

Table F.2: System Validation Part 2

CW Validation	Sensitivity	PASS	PASS
	Probe linearity	PASS	PASS
	Probe Isotropy	PASS	PASS
Mod Validation	MOD.type	GMSK	GMSK
	MOD.type	OFDM	OFDM
	Duty factor	PASS	PASS
	PAR	PASS	PASS

ANNEX G. Probe and DAE Calibration Certificate

Schmid & Partner Engineering AG

Zeughausstrasse 43, 8004 Zurich, Switzerland
Phone +41 44 245 9700, Fax +41 44 245 9779
info@speag.com, http://www.speag.com

s p e a g

1244

IMPORTANT NOTICE

USAGE OF THE DAE 4

The DAE unit is a delicate, high precision instrument and requires careful treatment by the user. There are no serviceable parts inside the DAE. Special attention shall be given to the following points:

Battery Exchange: The battery cover of the DAE4 unit is closed using a screw, over tightening the screw may cause the threads inside the DAE to wear out.

Shipping of the DAE: Before shipping the DAE to SPEAG for calibration, remove the batteries and pack the DAE in an antistatic bag. This antistatic bag shall then be packed into a larger box or container which protects the DAE from impacts during transportation. The package shall be marked to indicate that a fragile instrument is inside.

E-Stop Failures: Touch detection may be malfunctioning due to broken magnets in the E-stop. Rough handling of the E-stop may lead to damage of these magnets. Touch and collision errors are often caused by dust and dirt accumulated in the E-stop. To prevent E-stop failure, the customer shall always mount the probe to the DAE carefully and keep the DAE unit in a non-dusty environment if not used for measurements.

Repair: Minor repairs are performed at no extra cost during the annual calibration. However, SPEAG reserves the right to charge for any repair especially if rough unprofessional handling caused the defect.

DASY Configuration Files: Since the exact values of the DAE input resistances, as measured during the calibration procedure of a DAE unit, are not used by the DASY software, a nominal value of 200 MOhm is given in the corresponding configuration file.

Important Note:

Warranty and calibration is void if the DAE unit is disassembled partly or fully by the Customer.

Important Note:

Never attempt to grease or oil the E-stop assembly. Cleaning and readjusting of the E-stop assembly is allowed by certified SPEAG personnel only and is part of the annual calibration procedure.

Important Note:

To prevent damage of the DAE probe connector pins, use great care when installing the probe to the DAE. Carefully connect the probe with the connector notch oriented in the mating position. Avoid any rotational movement of the probe body versus the DAE while turning the locking nut of the connector. The same care shall be used when disconnecting the probe from the DAE.

Schmid & Partner Engineering

TN_BR040315AD DAE4.doc

11.12.2009

**Calibration Laboratory of
Schmid & Partner
Engineering AG**
Zeughausstrasse 43, 8004 Zurich, Switzerland



S Schweizerischer Kalibrierdienst
C Service suisse d'étalonnage
S Servizio svizzero di taratura
S Swiss Calibration Service

Accredited by the Swiss Accreditation Service (SAS)
The Swiss Accreditation Service is one of the signatories to the EA
Multilateral Agreement for the recognition of calibration certificates

Accreditation No.: **SCS 0108**

Client **TMC - SH (Auden)**

Certificate No: **DAE4-1244_Dec16**

CALIBRATION CERTIFICATE

Object **DAE4 - SD 000 D04 BM - SN: 1244**

Calibration procedure(s) **QA CAL-06.v29
Calibration procedure for the data acquisition electronics (DAE)**



Calibration date: **December 12, 2016**

This calibration certificate documents the traceability to national standards, which realize the physical units of measurements (SI).
The measurements and the uncertainties with confidence probability are given on the following pages and are part of the certificate.

All calibrations have been conducted in the closed laboratory facility: environment temperature (22 ± 3)°C and humidity < 70%.

Calibration Equipment used (M&TE critical for calibration)

Primary Standards	ID #	Cal Date (Certificate No.)	Scheduled Calibration
Keithley Multimeter Type 2001	SN: 0810278	09-Sep-16 (No:19065)	Sep-17
Secondary Standards	ID #	Check Date (in house)	Scheduled Check
Auto DAE Calibration Unit	SE UWS 053 AA 1001	05-Jan-16 (in house check)	In house check: Jan-17
Calibrator Box V2.1	SE UMS 006 AA 1002	05-Jan-16 (in house check)	In house check: Jan-17

	Name	Function	Signature
Calibrated by:	Dominique Steffen	Technician	
Approved by:	Fin Bomholt	Deputy Technical Manager	

Issued: December 13, 2016

This calibration certificate shall not be reproduced except in full without written approval of the laboratory.

Calibration Laboratory of
Schmid & Partner
Engineering AG
Zeughausstrasse 43, 8004 Zurich, Switzerland



S Schweizerischer Kalibrierdienst
C Service suisse d'étalonnage
S Servizio svizzero di taratura
S Swiss Calibration Service

Accredited by the Swiss Accreditation Service (SAS)
The Swiss Accreditation Service is one of the signatories to the EA
Multilateral Agreement for the recognition of calibration certificates

Accreditation No.: **SCS 0108**

Glossary

DAE data acquisition electronics
Connector angle information used in DASY system to align probe sensor X to the robot coordinate system.

Methods Applied and Interpretation of Parameters

- **DC Voltage Measurement:** Calibration Factor assessed for use in DASY system by comparison with a calibrated instrument traceable to national standards. The figure given corresponds to the full scale range of the voltmeter in the respective range.
- **Connector angle:** The angle of the connector is assessed measuring the angle mechanically by a tool inserted. Uncertainty is not required.
- The following parameters as documented in the Appendix contain technical information as a result from the performance test and require no uncertainty.
 - **DC Voltage Measurement Linearity:** Verification of the Linearity at +10% and -10% of the nominal calibration voltage. Influence of offset voltage is included in this measurement.
 - **Common mode sensitivity:** Influence of a positive or negative common mode voltage on the differential measurement.
 - **Channel separation:** Influence of a voltage on the neighbor channels not subject to an input voltage.
 - **AD Converter Values with inputs shorted:** Values on the internal AD converter corresponding to zero input voltage
 - **Input Offset Measurement:** Output voltage and statistical results over a large number of zero voltage measurements.
 - **Input Offset Current:** Typical value for information; Maximum channel input offset current, not considering the input resistance.
 - **Input resistance:** Typical value for information; DAE input resistance at the connector, during internal auto-zeroing and during measurement.
 - **Low Battery Alarm Voltage:** Typical value for information. Below this voltage, a battery alarm signal is generated.
 - **Power consumption:** Typical value for information. Supply currents in various operating modes.

DC Voltage Measurement

A/D - Converter Resolution nominal

High Range: 1LSB = 6.1 μ V, full range = -100...+300 mV

Low Range: 1LSB = 61nV, full range = -1.....+3mV

DASY measurement parameters: Auto Zero Time: 3 sec; Measuring time: 3 sec

Calibration Factors	X	Y	Z
High Range	403.872 \pm 0.02% (k=2)	403.613 \pm 0.02% (k=2)	404.527 \pm 0.02% (k=2)
Low Range	3.95409 \pm 1.50% (k=2)	3.97148 \pm 1.50% (k=2)	3.98215 \pm 1.50% (k=2)

Connector Angle

Connector Angle to be used in DASY system	22.0 \pm 1 $^{\circ}$
---	-------------------------

Appendix (Additional assessments outside the scope of SCS0108)

1. DC Voltage Linearity

High Range	Reading (μV)	Difference (μV)	Error (%)
Channel X + Input	199995.09	-0.83	-0.00
Channel X + Input	20004.47	2.58	0.01
Channel X - Input	-19997.82	2.60	-0.01
Channel Y + Input	199993.65	-2.29	-0.00
Channel Y + Input	20001.27	-0.51	-0.00
Channel Y - Input	-19997.58	2.97	-0.01
Channel Z + Input	199992.15	-3.40	-0.00
Channel Z + Input	19999.95	-1.78	-0.01
Channel Z - Input	-20002.51	-1.92	0.01

Low Range	Reading (μV)	Difference (μV)	Error (%)
Channel X + Input	2002.00	0.39	0.02
Channel X + Input	202.04	0.13	0.07
Channel X - Input	-197.82	0.13	-0.06
Channel Y + Input	2000.90	-0.59	-0.03
Channel Y + Input	202.65	0.73	0.36
Channel Y - Input	-197.74	0.13	-0.06
Channel Z + Input	2001.79	0.42	0.02
Channel Z + Input	200.75	-1.05	-0.52
Channel Z - Input	-199.15	-1.06	0.53

2. Common mode sensitivity

DASY measurement parameters: Auto Zero Time: 3 sec; Measuring time: 3 sec

	Common mode Input Voltage (mV)	High Range Average Reading (μV)	Low Range Average Reading (μV)
Channel X	200	-3.59	-5.16
	-200	6.94	5.14
Channel Y	200	-3.41	-3.57
	-200	2.60	2.96
Channel Z	200	-8.21	-8.18
	-200	5.71	5.56

3. Channel separation

DASY measurement parameters: Auto Zero Time: 3 sec; Measuring time: 3 sec

	Input Voltage (mV)	Channel X (μV)	Channel Y (μV)	Channel Z (μV)
Channel X	200	-	1.06	-4.10
Channel Y	200	7.19	-	1.88
Channel Z	200	9.77	4.29	-

4. AD-Converter Values with inputs shorted

DASY measurement parameters: Auto Zero Time: 3 sec; Measuring time: 3 sec

	High Range (LSB)	Low Range (LSB)
Channel X	16885	16322
Channel Y	16457	16417
Channel Z	15874	17196

5. Input Offset Measurement

DASY measurement parameters: Auto Zero Time: 3 sec; Measuring time: 3 sec

Input 10MΩ

	Average (μV)	min. Offset (μV)	max. Offset (μV)	Std. Deviation (μV)
Channel X	-0.50	-1.93	1.16	0.62
Channel Y	0.32	-1.78	2.06	0.72
Channel Z	-2.19	-4.30	-0.47	0.66

6. Input Offset Current

Nominal Input circuitry offset current on all channels: <25fA

7. Input Resistance (Typical values for information)

	Zeroing (kOhm)	Measuring (MOhm)
Channel X	200	200
Channel Y	200	200
Channel Z	200	200

8. Low Battery Alarm Voltage (Typical values for information)

Typical values	Alarm Level (VDC)
Supply (+ Vcc)	+7.9
Supply (- Vcc)	-7.6

9. Power Consumption (Typical values for information)

Typical values	Switched off (mA)	Stand by (mA)	Transmitting (mA)
Supply (+ Vcc)	+0.01	+6	+14
Supply (- Vcc)	-0.01	-8	-9



Add: No.51 Xueyuan Road, Haidian District, Beijing, 100191, China
 Tel: +86-10-62304633-2218 Fax: +86-10-62304633-2209
 E-mail: cttl@chinattl.com [Http://www.chinattl.cn](http://www.chinattl.cn)

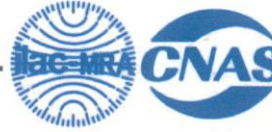

中国认可
 国际互认
 校准
 CALIBRATION
 CNAS L0570

Client **ECIT** Certificate No: **Z17-97010**

CALIBRATION CERTIFICATE



Object: EX3DV4 - SN:3754
 Calibration Procedure(s): FD-Z11-004-01
 Calibration Procedures for Dosimetric E-field Probes
 Calibration date: January 13, 2017

This calibration Certificate documents the traceability to national standards, which realize the physical units of measurements(SI). The measurements and the uncertainties with confidence probability are given on the following pages and are part of the certificate.

All calibrations have been conducted in the closed laboratory facility: environment temperature(22±3)°C and humidity<70%.

Calibration Equipment used (M&TE critical for calibration)

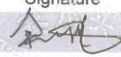
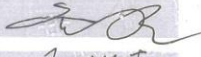
Primary Standards	ID #	Cal Date(Calibrated by, Certificate No.)	Scheduled Calibration
Power Meter NRP2	101919	27-Jun-16 (CTTL, No.J16X04777)	Jun-17
Power sensor NRP-Z91	101547	27-Jun-16 (CTTL, No.J16X04777)	Jun-17
Power sensor NRP-Z91	101548	27-Jun-16 (CTTL, No.J16X04777)	Jun-17
Reference10dBAttenuator	18N50W-10dB	13-Mar-16(CTTL,No.J16X01547)	Mar-18
Reference20dBAttenuator	18N50W-20dB	13-Mar-16(CTTL, No.J16X01548)	Mar-18
Reference Probe EX3DV4	SN 7433	26-Sep-16(SPEAG,No.EX3-7433_Sep16)	Sep-17
DAE4	SN 1331	21-Jan-16(SPEAG, No.DAE4-1331_Jan16)	Jan -17
Secondary Standards	ID #	Cal Date(Calibrated by, Certificate No.)	Scheduled Calibration
SignalGeneratorMG3700A	6201052605	27-Jun-16 (CTTL, No.J16X04776)	Jun-17
Network Analyzer E5071C	MY46110673	26-Jan-16 (CTTL, No.J16X00894)	Jan -17

	Name	Function	Signature
Calibrated by:	Yu Zongying	SAR Test Engineer	
Reviewed by:	Qi Dianyuan	SAR Project Leader	
Approved by:	Lu Bingsong	Deputy Director of the laboratory	

Issued: January 14, 2017

This calibration certificate shall not be reproduced except in full without written approval of the laboratory.



Add: No.51 Xueyuan Road, Haidian District, Beijing, 100191, China
Tel: +86-10-62304633-2218 Fax: +86-10-62304633-2209
E-mail: cttl@chinattl.com [Http://www.chinattl.cn](http://www.chinattl.cn)

Glossary:

TSL	tissue simulating liquid
NORM _{x,y,z}	sensitivity in free space
ConvF	sensitivity in TSL / NORM _{x,y,z}
DCP	diode compression point
CF	crest factor (1/duty_cycle) of the RF signal
A,B,C,D	modulation dependent linearization parameters
Polarization Φ	Φ rotation around probe axis
Polarization θ	θ rotation around an axis that is in the plane normal to probe axis (at measurement center), i $\theta=0$ is normal to probe axis

Connector Angle information used in DASY system to align probe sensor X to the robot coordinate system

Calibration is Performed According to the Following Standards:

- IEEE Std 1528-2013, "IEEE Recommended Practice for Determining the Peak Spatial-Averaged Specific Absorption Rate (SAR) in the Human Head from Wireless Communications Devices: Measurement Techniques", June 2013
- IEC 62209-1, "Procedure to measure the Specific Absorption Rate (SAR) for hand-held devices used in close proximity to the ear (frequency range of 300MHz to 3GHz)", February 2005
- IEC 62209-2, "Procedure to determine the Specific Absorption Rate (SAR) for wireless communication devices used in close proximity to the human body (frequency range of 30 MHz to 6 GHz)", March 2010
- KDB 865664, "SAR Measurement Requirements for 100 MHz to 6 GHz"

Methods Applied and Interpretation of Parameters:

- NORM_{x,y,z}**: Assessed for E-field polarization $\theta=0$ ($f \leq 900\text{MHz}$ in TEM-cell; $f > 1800\text{MHz}$: waveguide). NORM_{x,y,z} are only intermediate values, i.e., the uncertainties of NORM_{x,y,z} does not effect the E^2 -field uncertainty inside TSL (see below ConvF).
- NORM(f)_{x,y,z} = NORM_{x,y,z} * frequency_response** (see Frequency Response Chart). This linearization is implemented in DASY4 software versions later than 4.2. The uncertainty of the frequency response is included in the stated uncertainty of ConvF.
- DCP_{x,y,z}**: DCP are numerical linearization parameters assessed based on the data of power sweep (no uncertainty required). DCP does not depend on frequency nor media.
- PAR**: PAR is the Peak to Average Ratio that is not calibrated but determined based on the signal characteristics.
- A_{x,y,z}; B_{x,y,z}; C_{x,y,z}; VR_{x,y,z}; A,B,C** are numerical linearization parameters assessed based on the data of power sweep for specific modulation signal. The parameters do not depend on frequency nor media. VR is the maximum calibration range expressed in RMS voltage across the diode.
- ConvF and Boundary Effect Parameters**: Assessed in flat phantom using E-field (or Temperature Transfer Standard for $f \leq 800\text{MHz}$) and inside waveguide using analytical field distributions based on power measurements for $f > 800\text{MHz}$. The same setups are used for assessment of the parameters applied for boundary compensation (alpha, depth) of which typical uncertainty valued are given. These parameters are used in DASY4 software to improve probe accuracy close to the boundary. The sensitivity in TSL corresponds to NORM_{x,y,z} * ConvF whereby the uncertainty corresponds to that given for ConvF. A frequency dependent ConvF is used in DASY version 4.4 and higher which allows extending the validity from $\pm 50\text{MHz}$ to $\pm 100\text{MHz}$.
- Spherical isotropy (3D deviation from isotropy)**: in a field of low gradients realized using a flat phantom exposed by a patch antenna.
- Sensor Offset**: The sensor offset corresponds to the offset of virtual measurement center from the probe tip (on probe axis). No tolerance required.
- Connector Angle**: The angle is assessed using the information gained by determining the NORM_x (no uncertainty required).



Add: No.51 Xueyuan Road, Haidian District, Beijing, 100191, China
Tel: +86-10-62304633-2218 Fax: +86-10-62304633-2209
E-mail: ctl@chinattl.com [Http://www.chinattl.cn](http://www.chinattl.cn)

Probe EX3DV4

SN: 3754

Calibrated: January 13, 2017

Calibrated for DASY/EASY Systems

(Note: non-compatible with DASY2 system!)



In Collaboration with
TTL speag
 CALIBRATION LABORATORY
 Add: No.51 Xueyuan Road, Haidian District, Beijing, 100191, China
 Tel: +86-10-62304633-2218 Fax: +86-10-62304633-2209
 E-mail: ctl@chinattl.com [Http://www.chinattl.cn](http://www.chinattl.cn)

DASY/EASY – Parameters of Probe: EX3DV4 – SN: 3754

Basic Calibration Parameters

	Sensor X	Sensor Y	Sensor Z	Unc (k=2)
Norm($\mu\text{V}/(\text{V}/\text{m})^2$) ^A	0.48	0.41	0.59	±10.8%
DCP(mV) ^B	102.4	100.9	102.7	

Modulation Calibration Parameters

UID	Communication System Name		A dB	B dB $\sqrt{\mu\text{V}}$	C	D dB	VR mV	Unc ^E (k=2)
0	CW	X	0.0	0.0	1.0	0.00	198.9	±2.0%
		Y	0.0	0.0	1.0		175.6	
		Z	0.0	0.0	1.0		221.1	

The reported uncertainty of measurement is stated as the standard uncertainty of Measurement multiplied by the coverage factor k=2, which for a normal distribution corresponds to a coverage probability of approximately 95%.

^A The uncertainties of Norm X, Y, Z do not affect the E²-field uncertainty inside TSL (see Page 5 and Page 6).

^B Numerical linearization parameter: uncertainty not required.

^E Uncertainty is determined using the max. deviation from linear response applying rectangular distribution and is expressed for the square of the field value.