

TBS CROSSFIRE R/C System

Adaptive Long Range Remote Control System

Revision 2020-02-21



The TBS CROSSFIRE (XF) system is a R/C link system made for FPV enthusiasts. It features unheard of range without sacrificing basic functionality such as being immune to interference from onboard equipment, low latency control or two-way communications including telemetry functionality.

Key features

- Long range, adaptive and robust remote control system for your aircraft
- Immune to on-board noise
- Two-way communication link with real-time link vitals and telemetry
- Self-healing frequency hopping link
- Receiver beacon mode to recover your downed aircraft
- Super easy binding and configuration via built-in OLED display, OpenTX LUA or TBS TANGO remote
- Low latency control for perfect immersive feeling
- Free output mappable 8 output diversity with integrated backup battery or super tiny receiver (4g weight only) both with up to 12 channel PPM
- Ability to fly with multiple friends at the same time (10 or more)
- Dynamic self-selecting or selectable RF power from 10mW to 1W (local restrictions apply)
- Dedicated head-tracking input option for full FPV immersion
- Transmitter LED shows link health, OLED display for built in configuration
- Expansion port for future feature support



Table of content

[Attention](#)

[Drone Racing Environment](#)

[Crossfire LED Color Coding](#)

[Overview](#)

[Setup](#)

[Connecting CROSSFIRE Standard Transmitter to radio](#)

[Using JR-adapter](#)

[Using Hitec/Graupner/JR-cable](#)

[Using Futaba-cable](#)

[Using custom PPM cable](#)

[CRSF with other radios](#)

[Connecting CROSSFIRE Micro transmitter to radio](#)

[Push button functionality](#)

[Connecting CROSSFIRE Diversity receiver](#)

[Connecting CROSSFIRE Micro receiver](#)

[Connecting CROSSFIRE Nano receiver](#)

[Binding](#)

[Auto bind](#)

[Head-tracking](#)

[Set failsafe](#)

[BST Connectivity with TBS equipment](#)

[Controlling UNIFY PRO VTX with SmartAudio](#)

[Antenna](#)

[Operation](#)

[Status display](#)

[Up- and downlink status](#)

[Find mode](#)

[Direction finder](#)

[How does find mode work](#)

[Testing find mode](#)



[Preparations](#)

[Simulating flight](#)

[Simulating a Crash](#)

[Search and rescue](#)

[Link regained](#)

[Transmitter LED status indicator](#)

[Receiver LED status indicator](#)

[Real-time telemetry using app link](#)

[Configuration](#)

[Standard transmitter configuration](#)

[Micro transmitter configuration](#)

[Receiver](#)

[PWM or PPM servo output](#)

[Receiver SBUS output](#)

[Receiver RSSI or/and LQ output](#)

[Serial bridge](#)

[MAVLink](#)

[MAVLink APM](#)

[Disable telemetry](#)

[CRSF](#)

[DSMX](#)

[SmartAudio](#)

[Transmission power](#)

[Dynamic transmission power](#)

[Transmission frequency](#)

[Operating modes](#)

[RF Profiles](#)

[MyVTX](#)

[CRSF Connectivity with flight controller \(COLIBRI\)](#)

[Minimum requirements](#)

[Wiring layout](#)



[Setting up radio for CRSE](#)

[Setting up receiver for CRSF](#)

[Configuring BetaFlight for CRSF protocol](#)

[Discovering telemetry data sensors](#)

[Configuration of CORE PRO / CROSSFIRE RX with LUA Scripts or the TBS TANGO](#)

[Requirements](#)

[Setup](#)

[Telemetry](#)

[Firmware upgrade](#)

[Installing TBS Agent](#)

[Emergency update](#)

[FAQ](#)

[Good practices](#)

[FCC statement](#)

[FCC ID of TBS Crossfire Products](#)



Specifications

Type:	Long Range Two-Way Remote Control System
Band:	Europe: 868 MHz SRD Band America: 915 MHz ISM Band
RF power Radio Signal & Telemetry downlink:	Micro TX: Selectable 25mW and 100mW (250mW with FW 2.40 or later) Standard TX: Selectable 10mW to 500mW, additional 1W available with external power connected via XT30 socket Diversity, Micro and Nano RX: 40mW
Receiver sensitivity:	Up to -130dBm
Antenna:	TX: 1x omnidirectional dipole antenna RX: 2x omnidirectional dipole antennas, flexible antenna (Micro and Nano RX)
R/C Channels:	8 (Diversity)/ 4(6) (Micro/Nano RX) PWM (freely mappable) or up to 12-channel PPM stream outputs, standard 2.54mm servo connectors
Radio compatibility:	Any radio with PPM stream output (absolute max. ratings: -0.3V - 15V) JR Adapter for easy install on JR, FrSky and similar radios
Interface:	Micro TX: RGB LED light, push button, configuration via CRSF (TBS TANGO, OpenTX ect.) Standard TX: 1.3-inch OLED display and joystick for configuration, binding and link stats, real-time telemetry link to any computer, tablet or phone and Micro-USB for firmware upgrade
Recovery mode:	Diversity RX: Beacon-mode, receiver backup LiPo battery - operating time of approx. 2 days
Failsafe:	Pre-set servo positions or stops outputting servo pulse - selectable in configuration menu or via push button
Operating range:	Variable depending on output power and radio environment
Input power:	TX: +3.5 to 12.6V via RC or HT 3-pin input connector, External 2S to 3S LiPo via XT30 connector (standard RX only) RX: +4.5V to 8.4V All reverse-polarity protected
Power consumption:	TX: 1.1W, at 25mW TX: 3.2W, at Max Tx power output Diversity RX: 1.5W / Micro/Nano RX: 1W
Ports:	Diversity RX: 1x BST (the CROSSFIRE RX does not power the BST line), 8x Servo connectors - Micro RX: V1: 1x Servo, 1x BST / V2: 4x Servo, 1x BST - Nano RX: 2x Pin-headers for 1x BST and 4x Servo
Working temperature:	0 - 40°C
Size:	Standard TX: 150 x 80 x 20 mm, Micro TX: 73 x 56 x 35 mm Diversity RX: 30 x 50 x 12 mm, Micro RX: 40 x 14 x 9.5mm
Weight:	Micro TX: 38 grams Standard TX: 340 grams, Diversity RX: 25 grams, Micro RX: 3.2 grams
Kit contents:	1x TBS CROSSFIRE TX transceiver unit, 1x TBS CROSSFIRE RX transceiver unit, 1x JR-adapter module, 1x Futaba-cable, 1x JR-cable, 1x custom-cable, 1x XT30 cable



Attention

A general rule for RC aircrafts is that they must be controlled always under sight of view, check your RC regulation to keep up to date with regulations.

Drone Racing Environment

Crossfire Firmware V3.23 and above incorporates Racing Spec Firmware designed for race directors to effectively manage power output on CROSSFIRE for drone racing.

When using TBS CROSSFIRE control link, it is a requirement that all pilots use exactly the same power output. Use of CROSSFIRE has the same requirement as management of video transmission power output when it comes to racing.

Recommended power output is generally 100mW, however in some countries the maximum will be 25mW. Please check your countries regulations. The New LED Color System on the TBS CROSSFIRE allows Race Directors to see the power output at a glance.

Note: Use of different power outputs during racing can cause control lockouts for pilots.

Crossfire LED Color Coding

LED on the back of TBS Crossfire Module will illuminate in either blue or purple which will indicate the power output being used. If LED on the back of module is any colour other than blue or purple, this indicates pilot is not using Racing Spec Firmware or they are using higher power output than other competitors.

Turquoise LED = 25mW

Blue LED = 100mW

Green = Above 100mW

Color enables Race Directors to easily identify if there are any power output inconsistencies.

Note: Dynamic power must be turned OFF and telemetry should be ON or OFF depending on Race Director decision.



Overview

The following diagram indicates the essential inputs and features of the transmitter and receiver.

Standard transmitter module:



Diversity receiver unit:

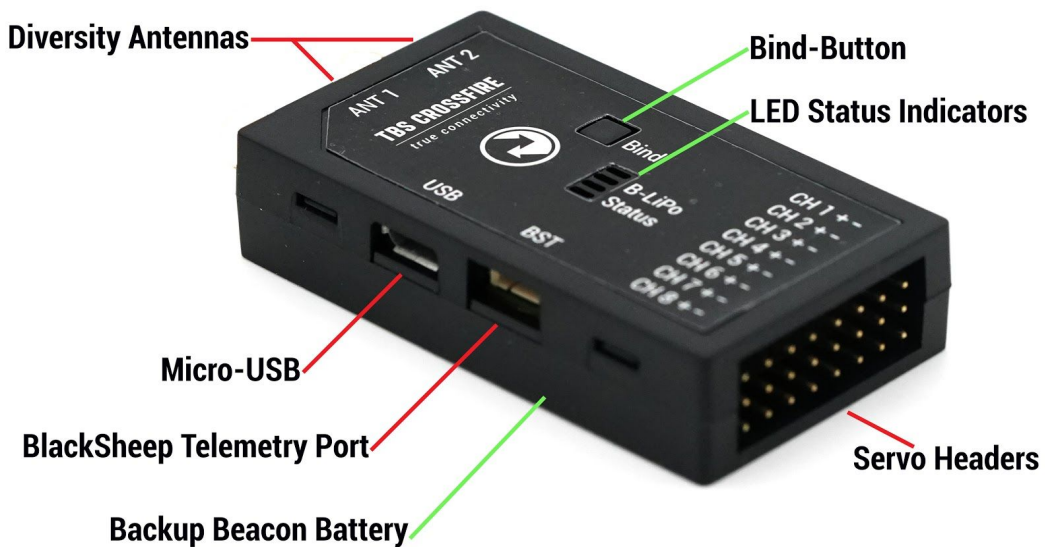

Micro transmitter module:



Micro receiver unit:

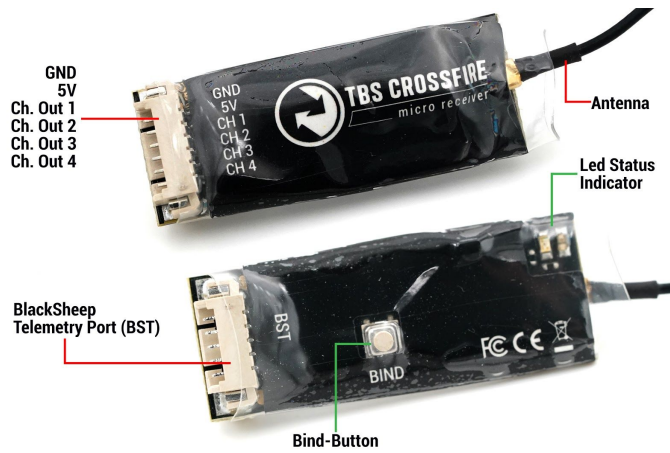

Nano receiver unit:

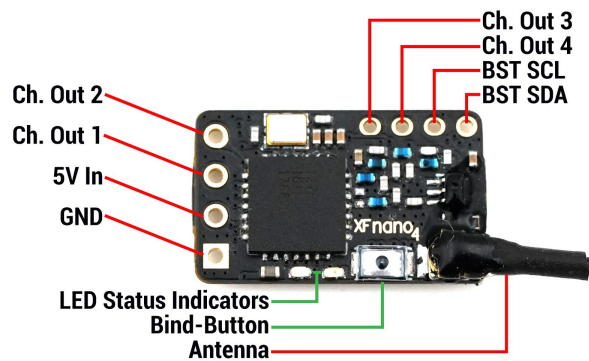

Setup

Getting set up and ready to fly is a quick and simple task. In most cases plug&play when using common R/C equipment.

Connecting CROSSFIRE Standard Transmitter to radio

Using JR-adapter

The kit comes with a JR-adapter which simply works as a connection bridge between the JR-pins on the radio and the TBS CROSSFIRE transmitter. The adapter simply fits into the slot on the back of the radio. The radio battery power to the TBS CROSSFIRE and no additional power is necessary for RF output up to 500mW.



Insert the JR-adapter into the slot on the back of the radio, remove the adhesive sheet from the TBS CROSSFIRE back and align the four studs with the matching holes on the transmitter. Connect the 3-pin to the left port (RC) and 6-pin cable (expansion) to the right port on the transmitter.





Power on the radio, configure a new model profile and enable the external RF module - see the radio manufacturers manual for further details on how to complete this step.

Using Hitec/Graupner/JR-cable

If you own a Hitec, Graupner or JR radio (does not work for Spektrum radios) without a JR-module slot, you can still use the trainer output connector to get the necessary power and PPM control signals to the TBS CROSSFIRE transmitter. Note that this will not provide CRSF-data, see the following section.

Connect the included cable to the radio trainer port and the other end to the left port (RC) on the transmitter.



Using Futaba-cable

For Futaba radios you can use the trainer port to feed the PPM signal to the TBS CROSSFIRE transmitter. Connect the included cable to the radio trainer port and the other end to the left port (RC) on the transmitter.



Using custom PPM cable

If you want to connect any other radio, or have a custom setup, you can use the 3-pin pigtail-cable and solder the wires according to the table below to suit your needs.



Radio pin (left in photo above)	TBS CROSSFIRE 3-pin cable
White - PPM	1 - PPM
Red - Power	2 - Power
Black - Ground	3 - Ground

CRSF with other radios

To add CRSF capability to any supported radio, you will need to use the expansion port cable called "[TBS CROSSFIRE IR-Adapter cable](#)" and customize it. The pin-out is shown in the following picture.





Connecting CROSSFIRE Micro transmitter to radio



The CROSSFIRE Micro TX has a standard JR-form factor and works with any radio that supports PPM-stream and/or TBS CRSF-format output. Transmitter power is selectable between 25mW and 100mW (250mW with FW 2.40 or later) and TX status is shown using a RGB LED-light behind the push button. Frequency band 868 MHz and 915 MHz are supported.





Push button functionality

If there is no link (LED pulsing orange 

- Short press: Enter bind-mode (LED blinking green ).

If the receiver needs to be updated it will start blinking blue (). Press the button again to confirm. The update will start and the LED will be solid blue () until the update is complete.

Once update is complete the LED will turn solid green () or orange ().

If there is a link (LED solid green ):

- Long press: Set failsafe

Configuration of the internal settings (output power, dynamic power, and operation mode) is done via any remote supporting full CRSF V2 (TBS TANGO, OpenTX etc., not Graupner, CRSF V1) remote, detailed later in the manual under Configuration.



The CROSSFIRE Micro TX module fits perfectly on the back of the TBS TANGO FPV remote. It clips easily in place and can use the telemetry compatible CRSF-format between the module and radio.



Connecting CROSSFIRE Diversity receiver



The compact receiver unit fits everything from small multirotors to very large airplanes. The receiver is capable up to 8.4V and needs at least 4.5V input voltage. This can be applied to any of the eight servo headers, e.g. a servo cable from a ESC with BEC, or a stand-alone BEC, with a suitable amperage rating - min. 1A recommended. Make sure that adequate power is available by letting the model run for a few minutes with servos connected, and check your BEC temperature.

If you want to connect additional TBS products to you setup, e.g. CORE PRO, CURRENT SENSOR, BLACKBOX and GPS, we are providing a 3-way BST splitter adapter to connect everything together.

The receiver servo header pin-polarity is standard and shown in the photo below. R/C signal for the flight controller, servos or other equipment is connected to the white cable. All the power pins are reverse-polarity protected.

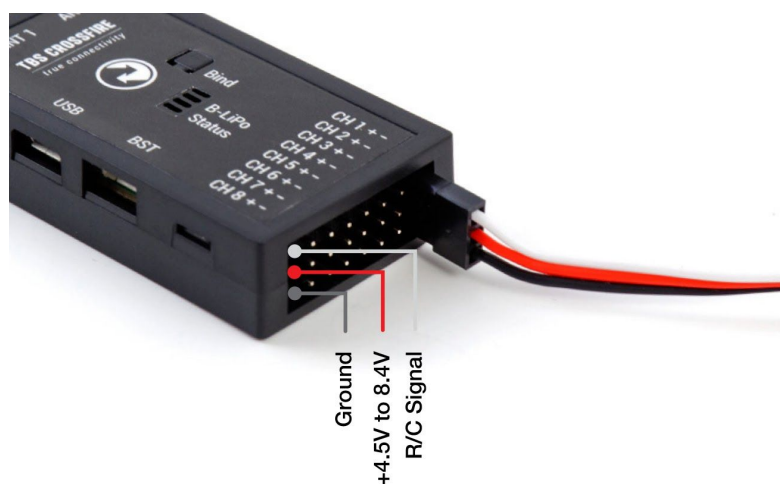

Connecting CROSSFIRE Micro receiver



V1:

The TBS CROSSFIRE micro receiver comes with two sockets. One is for BST capability (BlackSheep Telemetry), the other is for one (1) R/C output which can be configured to either PWM, PPM, SBUS, or CRSF. The receiver can run off anything between 4.5V and 8.4V and can either drive one servo, or connect to any PPM or SBUS capable flight control. Binding the receiver to the transmitter is described on the next page and is the same as the diversity receiver.



V1:

CleanFlight pilots with a STM32Fx processor board (e.g. Naze32 and similar) can select the “n.i. SBUS” (Not-Inverted SBUS) to directly connect to your FC without any inverters or special soldering hacks.

TBS CROSSFIRE Micro receiver V1:

- 1 Output channel
- Output mapping options: PPM, SBUS and CRSF (RC only, no telemetry)
- BST telemetry support (TBS GPS, TBS CORE PRO, TBS FPVision layer, TBS POWER CUBE)

TBS CROSSFIRE Micro receiver V2:

- 4 (6) Output channels
- Output mapping options: PWM, PPM, SBUS, MAVLink and CRSF (see output mapping options of output 1 or 4)
- Full MAVLink support
- Full CRSF support (RC and telemetry)
- BST telemetry support (TBS GPS, TBS CORE PRO, TBS FPVision layer, TBS POWER CUBE)
- Comes with 4 channel servo adapter



Connecting CROSSFIRE Nano receiver

The CROSSFIRE Nano RX has much of the same feature set as the TBS CROSSFIRE Micro RX but on a smaller form factor and without connectors. The small size allows you to save space and weight, while still retaining the key features that make the CROSSFIRE system flexible and reliable.

Note: Firmware 2.24 or newer required! Make sure to update the CROSSFIRE TX before trying to bind the receiver.

There are four channel outputs that can be used to connect a flight controller, servos or other R/C equipment. Wiring the receiver requires soldering as it does not come with any headers (to reduce overall size and setup flexibility). Break-out boards are available, both a simple servo board, and a duo CROSSFIRE Nano and UNIFY PRO Nano on the same board.



The pads along the right side for 5V, GND, CH1 and CH2 (in the following picture) are spaced 2.54mm apart, for normal headers. While the bottom row for CH3, CH4 and BST SCL and BST SDA are 2.00mm apart.

To connect a R/C flight controller or servos, you only need to supply 5V from another source (Nano does not provide voltage), GND and CH1 to CH4. For TBS gear that support BST, you need to connect GND, BST SCL and BST SDA, in addition to 5V power for the receiver. Binding the receiver is done the same way as other CROSSFIRE RX modules.



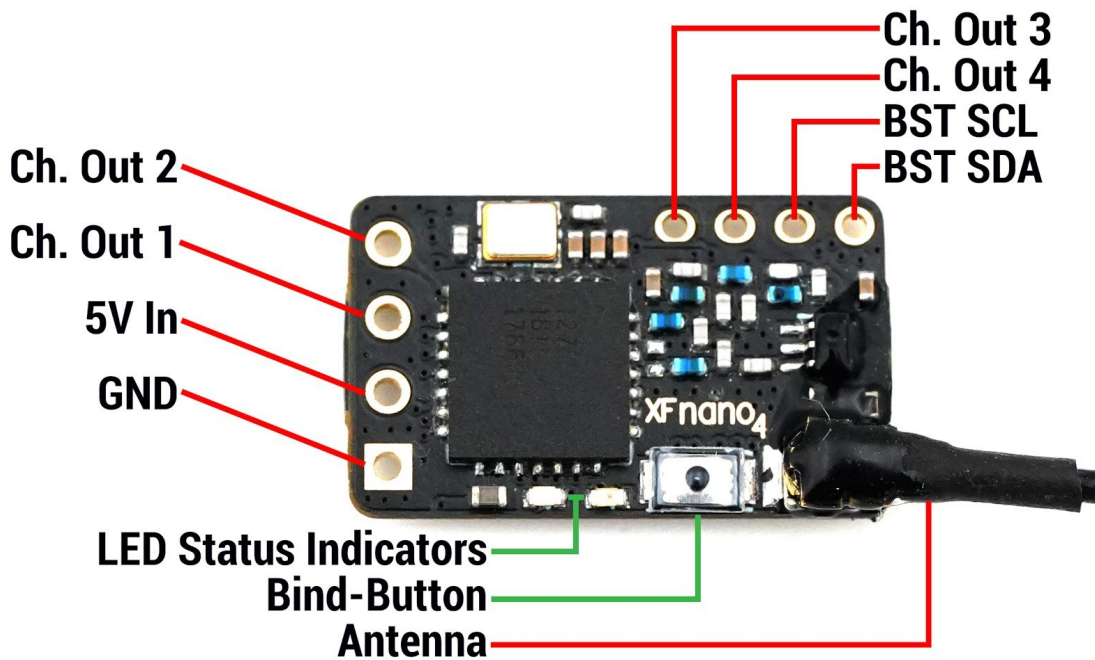

Note that the squared-pin has change in later revisions, but the pinout is still the same.

Binding

Binding the transmitter and receiver is super simple.

1. Just power up the TBS CROSSFIRE transmitter
2. On the standard transmitter, enter the configuration menu by pressing and holding the joystick for 3 seconds, select "General" and "Binding" - a message "Binding" will start blinking, waiting for the receiver. On the micro transmitter, a short press on the button will initiate binding mode. For the TBS Tango, you can use the "Devices" menu and navigate to "Crossfire TX/ Binding". For OpenTX, you need to do the same just in the LUA script.
3. Now, power up the receiver, press and release the "BIND" button on the receiver to initiate binding. On the receiver is a timeout of one minute for after power up to enter bind mode. If the status LED will start blinking slowly you the receiver has switched successfully to bind mode.



Within a few seconds the process will finish with a "Binding complete" message. The receiver has now stored the unique serial number of that particular transmitter. If the transmitter starts to flash blue this



means that you need to update your receiver. On the standard TX, radio you need to follow the instructions shown on the screen. For the Micro TX, a short press on the button will initiate the update.

Auto bind

Since FW 2.31, the CROSSFIRE can bind to a previously bound receiver without the need of pushing the “Bind” button on the receiver. Just the transmitter needs to initiate the binding process. This also applies if you need to update your RX.

What you need to use auto bind:

- The receiver have been bound to the transmitter before
- Both the transmitter and the receiver, need to be on FW 2.31 or newer

Head-tracking

The standard TBS CROSSFIRE transmitter supports standard head-tracking input via the right 3-pin HT port. Solder the included pigtail cable to suit your particular head-tracking setup. Only a two wire connection between TBS CROSSFIRE and the head-tracker is required. The PPM feed from the head-tracker needs to be connected to the PPM pin of the PPM pin and ground need to be connected to ground of the 3-pin PPM cable.

The status display will indicate if the signal has been recognized properly. Inside the menu under “Headtracker”, three functions for pan, tilt, and roll are freely mappable. Each function has a source and destination selection. The selected channel under source will replace the channel selected under destination. This gives you the ability to map your headtracker channels from any channel of the headtracker input to the RC link frame.



Set failsafe

Setting the R/C failsafe parameters is a very important part of the configuration, don't skip it! You never know when you will have problems with uplink and lose control of your aircraft.

It can go into a predefined position of the channels (position) or the receiver turns "dead" (cut) and outputs no more signals to the servos, FC, etc. The receiver configuration for failsafe can be found in the menu of the transmitter/Lua-script , under your particular "CROSSFIRE RX" menu and Failsafe - here you can set "Cut" or "Position".

- "Cut" is useful when the model has a controller installed which then executes its own failsafe routine
- "Position" is intended for all other models or when the controller expects a certain channel position

For "Position", failsafe parameters can be set following this procedure:

Micro TX:

1. Turn on and off the transmitter and receiver
2. Move the sticks and switches to the desired position
3. Press and hold the button on the CROSSFIRE transmitter for a few seconds
4. Turn off the transmitter and check that the set position is taken

Standard TX:

1. Turn on and off the transmitter and receiver
2. Move the sticks and switches to the desired position
3. Go to the CROSSFIRE menu and select "Bind" - it initiates the failsafe process this time
4. Wait until "Failsafe set" appears on the display
5. Turn off the transmitter and check that the set position is taken

Alternatively, the standard TX can save the current position via shortcut. To do so, take the position with the sticks and switches, push the joystick down briefly and then hold it up for a few seconds. The message "Failsafe set" appears on the display

BST Connectivity with TBS equipment

There is an issue when you want to run BST devices like the GPS or BLACKBOX direct without a CORE PRO. Most of the BST devices needs 5V which the CORE PRO provides. You can also power the BST line by using the TBS 3-way splitter with a servo header to connect a 5V regulator or BEC. The CROSSFIRE RX does not power the BST line when 5V is applied to the servo connectors.

The following explains the required power needs:

- TBS BLACKBOX - Can be powered by the BST 5V or by the Flight Controller over the ext. FC port



- TBS GPS - Can only be powered by the BST 5V
- TBS CURRENT SENSOR - Provides VBatt but needs BST 5V to run itself
- TBS CROSSFIRE RX - Can be powered over one of the eight servo connectors or by BST 5V
- TBS CORE PRO / FPVISION - This is only device is providing 5V on the BST line

Power type:	BST 5V	VBATT	ESC BEC 5V	FC 5V
TBS CROSSFIRE	✓ PWR IN		✓ PWR IN	
TBS BLACKBOX	✓ PWR IN			✓ PWR IN
TBS GPS	✓ PWR IN			
TBS CORE PRO / FPVISION	✓ PWR OUT	✓ PWR IN		
TBS CURRENT SENSOR	✓ PWR IN	✓ PWR OUT		
TBS BULLETPROOF ESC (Older version, obsolete)			✓ PWR OUT	



Controlling UNIFY PRO VTX with SmartAudio

After the Sept. 2017 firmware update, the CROSSFIRE RX Micro V2 (DIVERSITY RX not supported) can be directly connected to a TBS UNIFY PRO video transmitter and be controlled using our SmartAudio technology. SmartAudio provides UART and I2C control for your video transmitter. Parameters such as output power, bands, channels and frequency can be freely controlled. This enables remote channel control directly from your radio (TBS CROSSFIRE OLED display, TBS TANGO with TBS CROSSFIRE or OpenTX compatible remote), from the OSD (e.g. TBS CORE PRO) or, in a future release, a smart device/mobile (TBS CROSSFIRE TX with bluetooth or wifi module required).

The setup is easy and simply requires the CROSSFIRE RX SIGNAL-pin and GND to be connected to the UNIFY AUD and GND, respectively. You need to make a custom cable for this.

You also need to configure the CROSSFIRE RX channel mapping to output “SmartAudio” on output channel 4, see the “Configuration” chapter later on in this manual on how to access- and navigate the menu.

Antenna

The TBS CROSSFIRE components come with standard dipole antennas, these are perfect for normal flying. Metallic objects, such as cables or handles, should be kept away from the antenna while it is in use, from both the transmitter and the receiver.

The amount of clearance required is higher for lower frequencies than it is for higher frequencies. To achieve the best range possible, the 900 MHz antenna needs to be almost 60% higher compared to a normal 2.4GHz setup. In normal use try to hold the radio fairly high off the ground and with the antenna vertical, without straining yourself of course. This is also a good technique you can use to quickly improve the RF transmission if the link is about to fail or you briefly lost the signal. Standing on a hillside or on top of a slope also helps to improve the conditions and range.

An overview of all available antennas for the CROSSFIRE system can be found [here](#).



Operation

Status display

After power-on, the main screen shows the current state of the transmitter, i.e. link status, transmission power, R/C- and head-tracking input signal state.

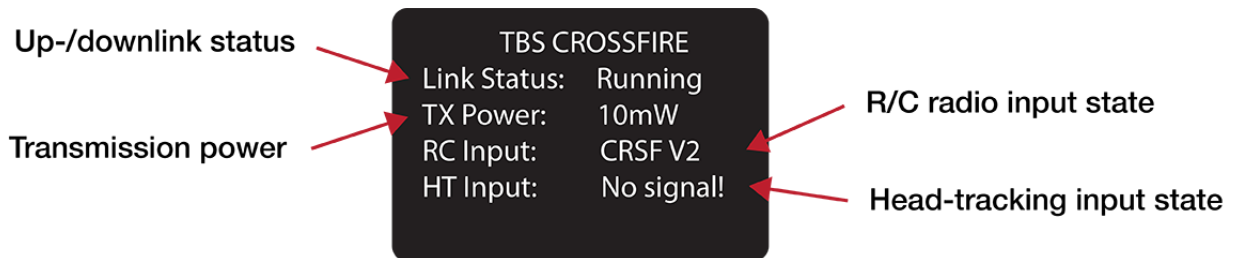

- **Link Status** - State of the wireless link [Connecting, Running]
- **TX Power** - Output transmission power [10mW, 25mW, 100mW, 500mW, 1W]
- **RC Input** - Radio R/C PPM signal input status [No signal, PPM, CRSF V1/V2]
- **HT Input** - Head-tracking PPM signal input status [No signal, Signal OK]

Up- and downlink status

Toggle the joystick to the right to show the status of the up- and downlink.

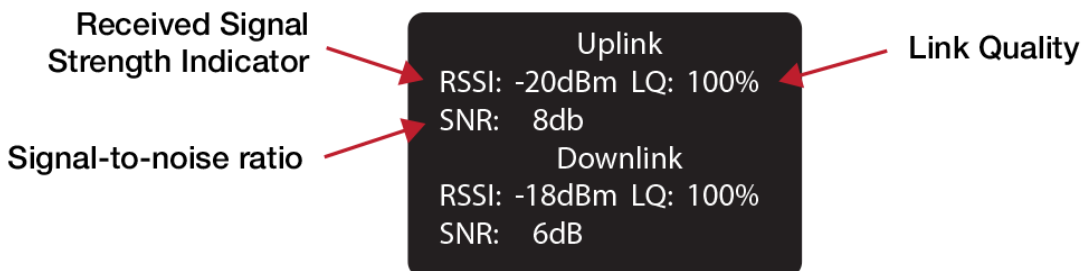

- **RSSI** - Received signal strength indicator, measurement of the power present in a received radio signal [typ. -1dBm (good) to -130dBm (bad), logarithmic scale]
- **LQ** - Link Quality, based on the percentage of signal data received at the end-point [0 to 300%]
- **SNR** - Signal-to-noise ratio, compares the level of a desired signal to the level of background noise

The RSSI determines your available link budget on a logarithmic scale, with each additional -6dBm representing twice the range of your current distance. E.g. you are at 5km range with a RSSI of -84dBm. At a range of 10km you are expected to see a -90dBm RSSI. The receiver is capable of receiving signals up to -130dBm. The SNR plots your current RSSI against the noise floor, giving you a rough indication of the remaining range in real-time. The CROSSFIRE can receive signals down to about -12dB SNR, way below the noise floor.



CROSSFIRE runs different [RF Profiles](#) at time. For a better understanding which RF profile is active we assume 50Hz update rate as 100%. This will give you up to 300% LQ for operation mode normal and up to 100% LQ for force telemetry. Any LQ above 80% is fine. LQ at 50% you can still comfortably fly a gimbal-quad in ATTI or GPS mode since there is still a certain amount of valid data reaching the flight controller.

Note: Since firmware V2.30 the OpenTX telemetry sensor and the LQ on the the receiver channel map are scaled from 0-100%. While the CROSSFIRE is in 150 Hz mode, the LQ will stay at 100%. When the system switches to the 50 Hz Long-range-mode, the LQ sensor can start to drop.

Find mode

The Find-mode provides you with a way to locate a downed aircraft. A GPS signal is currently required to use this mode (other detection modes are being developed). Install our TBS GPS module or any other gps, connected to a flight controller (APM, INav, BetaFlight - CRFSF or MavLink connection required) to the BST-port on side of the receiver.

In normal use the GPS coordinates are continuously updated and the latest data is displayed on the "Find Mode" screen. If the model loses power you can review the last known coordinates to locate your model.

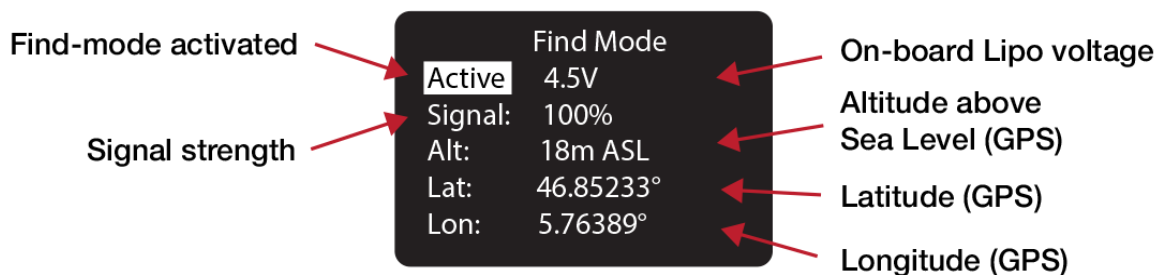

- **Inactive (Press Enter) / Active** - Enable/disable the Find-mode, shows on-board LiPo voltage
Do NOT enable during flight!
- **Signal** - Receiver signal strength, makes it possible to triangulate the location [0 to 100%]
- **Alt** - Altitude above Sea Level, GPS required [0 to 5000m]
- **Lat** - Latitude, GPS required
- **Lon** - Longitude, GPS required

The receiver has an on-board LiPo battery to operate in beacon-mode. This allows the transmitter to send the last known GPS coordinates to the display on the transmitter, after certain trigger events have happened. See the operation flow diagram attached on the following page.



Direction finder

Using the transmitter antenna together with a parabolic reflector, you can estimate the heading of the



receiver by looking at the signal strength indicator. Print out the DIY reflector template included on the last pages of this manual with no scaling on thick paper, place a of aluminium foil on top of the main reflector sheet and cut out the shapes with an exacto knife. Place the reflector in the middle of the antenna.

How does find mode work

Please see the flowchart to see when the receiver decide to shut down or enter find mode. In short the receiver shuts down if transmitter and receiver are close to each other or the receiver never got a signal from the TX, In any other case it enters the find mode if there is a power down event. If the main battery still powering the system after a crash the receiver will not enter the find mode and keeps running in the selected operation mode.

Once the receiver entered the find mode also a power saving mode will be activated. This power saving mode will decrease the beacon signal interval over time. It stays for 10 beacon signals on the same interval level and remain on the slowest once reached. The interval levels are 1s, 5s, 10s, 15s, 30s and 60s. This means it can take up to 60s for your transmitter to pick up a beacon signal. This is required to make the receiver run as long as possible. Once the transmitter receives a beacon signal and send an acknowledge the receiver will switch back to the fastest interval until the link is lost again.

Once a connection is established the receiver will share the GPS information with the transmitter if a GPS source is connected or RSSI values to find the receiver with signal strength and the DYI reflector.

Testing find mode

It is highly recommended to go through a crash scenario first so that you are fully aware of all the neat things we have packed into the Find Mode or Beacon Mode of the TBS Crossfire system.



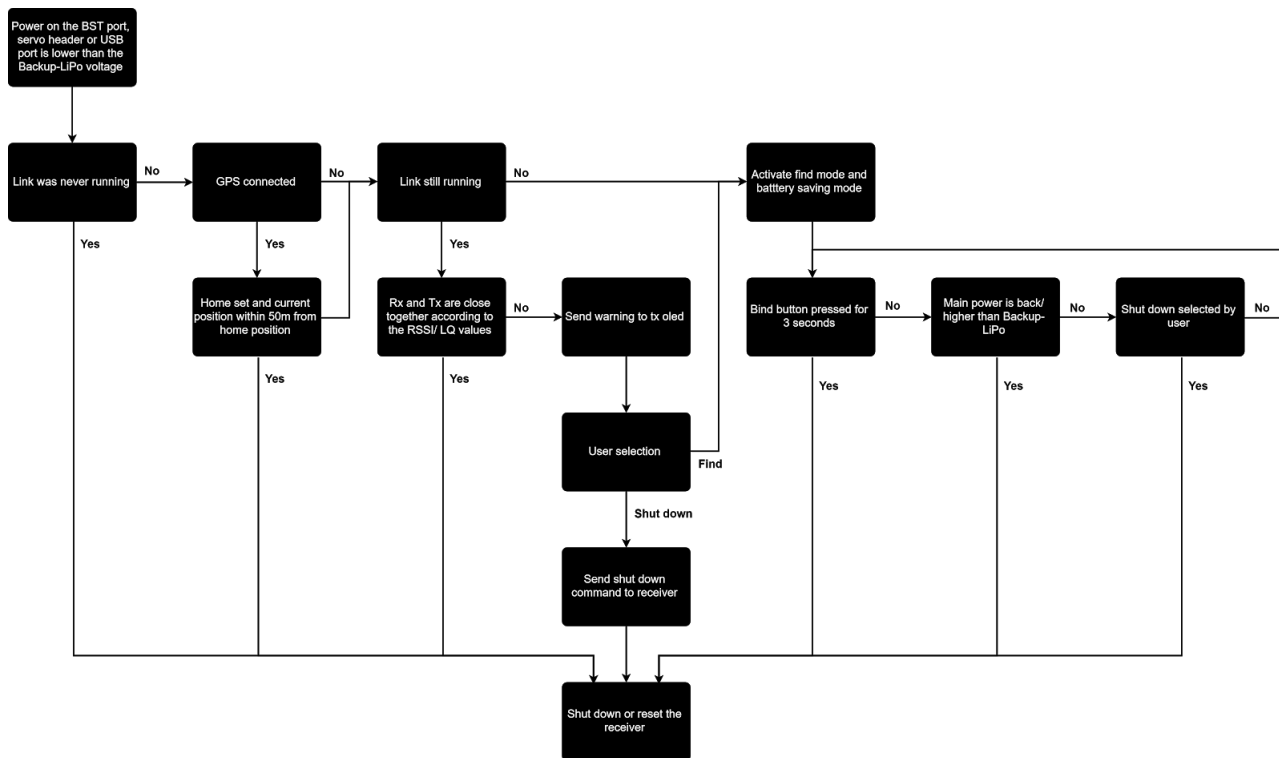

Preparations

The find mode needs to be armed before it will take any action.

- Receiver only:
 - Power up receiver and transmitter and make sure they are connected to each other.
- Receiver with GPS:
 - Make all steps above and ensure the GPS is having a solid sat lock.
- Receiver with GPS and TBS CORE PRO:
 - Make all steps above and simulate a take off. This can be done throttle above 3A or walking your receiver until you see the take off message on the OSD.

Simulating flight

The find mode is armed now and you need to simulate a flight. Just separate transmitter and receiver by more than 50 meters.



Simulating a Crash

A crash can happen in different ways. Let's simulate it only :) Here are some scenarios.

- Turn off your transmitter (failsafe) and move your plane to another spot (scenario: flying behind a mountain, with subsequent crash)
- Power down the battery (scenario: battery eject on crash)
- Just let it sit there (scenario: landing in a tree)

Search and rescue

The copter/plane is lost - now we'll start the S&R mission. It's important to get the link back to either get the latest GPS coordinates or have the ability to point into the direction based on the signal strength.

- In some cases the link is not even lost. Skip below and move to "Link regained" chapter
- Read the coordinates from your OLED and go to the place of the latest coordinates. If you don't have a GPS try to go as close as possible to the last known position.
- Get yourself to an exposed position as close to the target as you remember from the crash or based on OLED coordinates
- Toggle between find mode (greater range, less telemetry) and full link (less range, full telemetry). If you have lost main power your quad will respond in find mode. For all other scenarios, you should be able to regain control. When you see "find mode activated" on your LCD, give it more than a minute before you deactivate it again (beacon timing, see description above). If you use the DIY reflector point and hold in different directions until you get your link back.

Link regained







Once you got your link back to your copter/plane you can now try to find it. It's recommended to keep the mode you got your signal back no matter if it's actually find mode or selected operation mode.

- GPS source attached to receiver
 - The receiver will share the latest coordinates with the transmitter and display them on the OLED.
 - For Droidplanner app select Bluetooth (Crossfire App link mode needs to be set to MAVLink emulator) to locate your copter/plane
 - Write down the coordinates use any GPS to find the location
- No GPS source attached
 - Make your transmitter antenna a directional one. This can be done by the DIY reflector or you can use your body to lower the signal strength from one direction (works for emergencies)
 - Turn yourself slowly in a circle and try to figure out the direction the signal strength is the strongest. Walk this direction and repeat this until you found the copter/plane. For this practice some exercise is recommended.









Transmitter LED status indicator

The RGB LED on the transmitter gives you at any moment an indication of your link status. Going from green to yellow. Once you are in yellow your RSSI values are either very low or you are already in the low-framerate link mode.

Transmitter LED sequence	Description
Pulsing 	Ready, trying to connect to receiver or no down link established
Green 	Solid uplink, 150 Hz or 50 Hz link mode active
Yellow 	Unreliable uplink
Blue 	Update of the receiver is running
Fast green flashing 	(Standard TX) Transmitter bootloader active
Fast red flashing 	Warning, a message is shown on the OLED display/ LUA Script
Purple 	Find-mode engaged (standard TX only)

Receiver LED status indicator

There are four (Diversity RX) or two (Nano and Micro RX) LEDs on the receiver giving you an indication of link- and backup-battery (Diversity RX only) status.

Receiver LED indicators	Description
Solid green 	Link is up and running OK
Solid red 	No packages received from the transmitter and receiver is in failsafe mode
Fast red blinking 	Receiver needs a update, confirmation on the tx is required
Slow green blinking 	Receiver is in binding mode
Fast green blinking 	Receiver bootloader active or firmware upgrade
Green is flashing 	Diversity RX is in Find-mode (up to 1 min. delay between flashing)

If the receiver is in Find-mode it can be cancelled by pressing the “Bind”-button. So if you are back home and the receiver still thinks it got lost, you can turn it off like by pressing the button once. Or check the OLED screen to deactivate the Find-mode from the transmitter (Standard TX).

The on-board LiPo battery in the receiver is automatically charged every time the receiver is used. The third LED indicators on the receiver’s front face displays the current state of the battery.

LiPo LED indicator	Status
--------------------	--------



Red 	Backup battery is charging (Diversity RX only)
---	--

The backup battery is used if the model gets lost. The receiver can stay alive even if the entire plane or copter does not have power anymore.



Real-time telemetry using app link

The transmitter has a wireless close range telemetry module built-in for easy telemetry distribution to a PC, MAC, tablet or phone. TBS CROSSFIRE supports different modes for different use cases.

Note: This section is only applies if you are using the Standard TX. The Micro TX is not equipped with Bluetooth module.

- OFF
 - Close range telemetry module is completely disabled and won't show up if you search for devices.
- MAVLink Emulator (MAV Emu)
 - This mode is recommended if you have any kind of GPS source attached over BST (TBS GPS, DJI NAZA over TBS BLACKBOX, MAVLink FC over TBS BLACKBOX, ET Vector). If this mode is selected an FC is emulated inside the TBS CROSSFIRE transmitter. This gives you the ability to track your copter/plane in real-time with any MAVLink capable app on your phone (e.g. [Droidplanner app](#)) or GCS on your PC or MAC (e.g. [QGroundControl](#))
- TBS
 - Telemetry data is sent in JSON format if this mode is active. This option has been removed in later firmware versions.
- Serial Bridge
 - This mode is used for serial bridge between your connected device and the receiver. Please refer to the [Serial bridge](#) section for further information.
- MAVLink
 - This mode is used to pass MAVLink messages back and forth. Use this mode if you have a MAVLink FC connected to the diversity receiver. Please refer to the [MAVLink](#) section for further information.

Device pairing

Once the CROSSFIRE is up and running, go to the PC, MAC, tablet or phone's pairing screen and look for a new device called "Crossfire ####" in the list. Tap the CROSSFIRE entry and accept the pairing request. It is now ready to be used with Droidplanner.



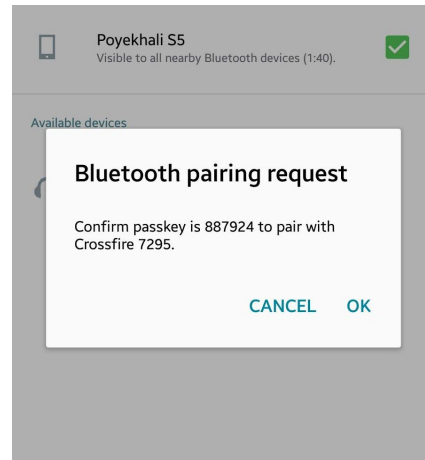
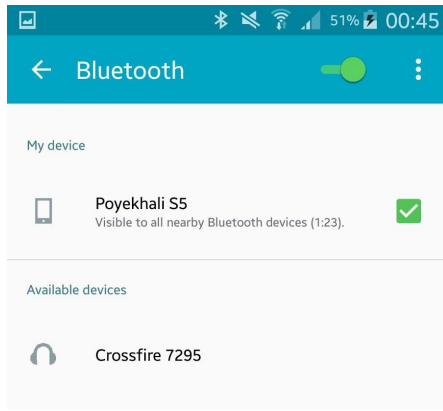

Real-time telemetry updates will now stream from the CROSSFIRE transmitter to your handheld device. For instance a live map overlay makes this a great way to track race performance or to locate a down aircraft.

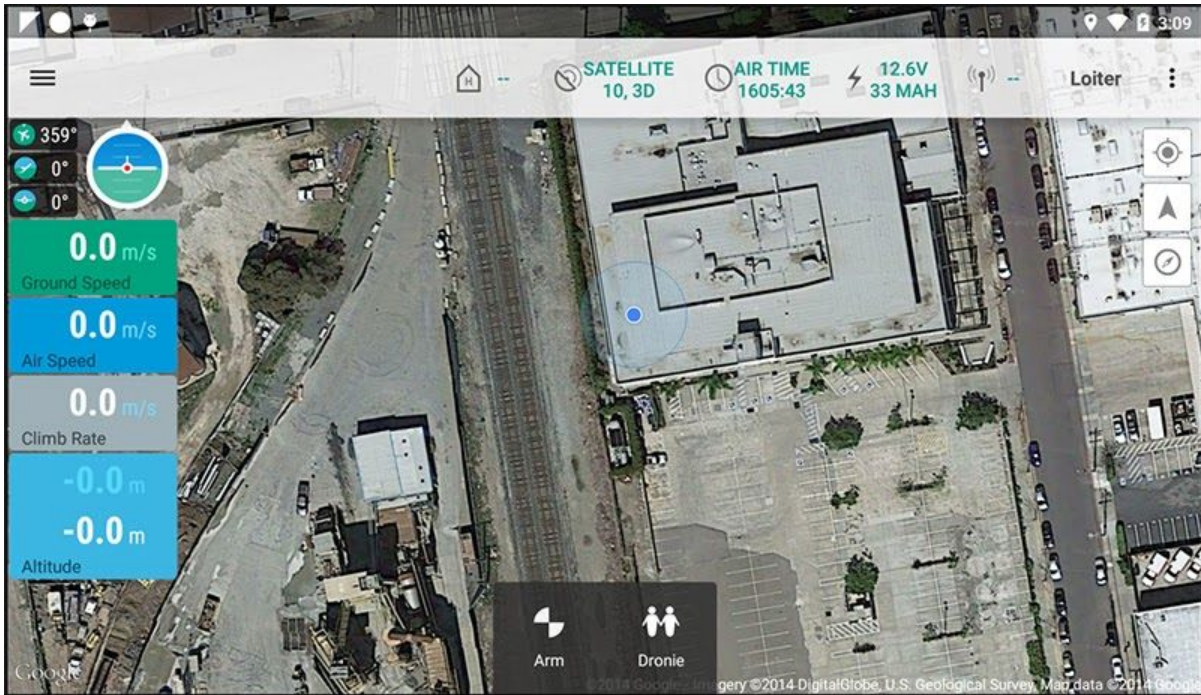

Configuration

Changing any setting related to the TBS CROSSFIRE R/C link is done using a handy OLED display and five-way joystick on the back of the standard transmitter (Standard TX), or via the TBS TANGO display for the micro transmitter or by OpenTX LUA scripts. All configuration for the receiver, including servo signal type and binding, can be initiated from the display only.

Standard transmitter configuration

Use the joystick on the transmitter to enter and navigating the menu system:

- Configuration menu - long press the joystick, 3 seconds
- Enter change - short press the joystick or left navigation
- Select item - short press or right navigation
- Menu navigation - Up, down, left, right, or joystick press

Micro transmitter configuration

To configure the internal settings on the micro transmitter, a TBS TANGO remote or an OpenTX radio with LUA scripts is required. The changes are stored internally on the transmitter module, so if you do not own such a remote, you can borrow one for a minute to make the necessary changes and then pop it out.

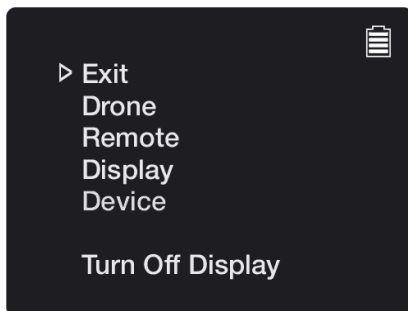

Enter the configuration menu by
Holding the jog-scroller for 3
seconds (TBS TANGO)

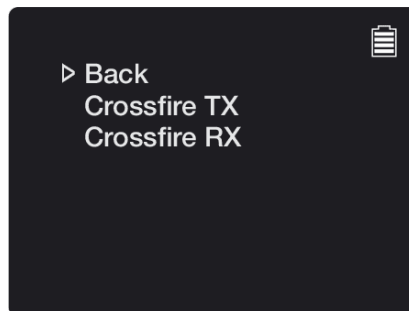

Select Device and the detected
CROSSFIRE modules will be listed

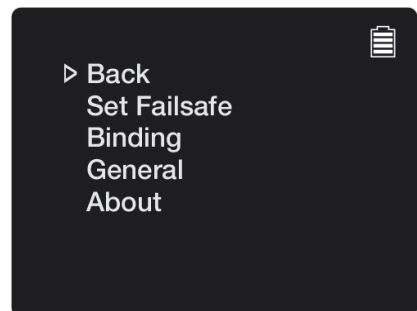

Pick the "Crossfire TX" module to
find a listing of all the available
modes and changeable settings

This method is also available on the standard transmitter module. You can also do this steps by LUA scripts. For more informations see the following sections in this manual.



Receiver

PWM or PPM servo output

The default setting is to output traditional PWM signals on all channels on the receiver. To output CRSF, e.g. for multirotors, you can enable this in the configuration menu. Each channel can be configured independently to output traditional PWM, RSSI, LQ or RSSI/LQ combined. Each channel can be configured as shown below. To change output mapping:

1. Power on both the transmitter and receiver
2. Enter the configuration menu, select "Diversity RX" or "Micro RX V2" or "Nano RX" and then "Output Map" - Note: This option is only available when the transmitter has detected the receiver
3. Pick a channel from 1 to 8, and toggle between "Ch.1 to 12" (PWM), "PPM", "RSSI", "LQ", etc.

Receiver pin	Output type Diversity RX (standard)	Default value
1	PWM Ch1 bis 12, PPM, RSSI, LQ, RSSI/LQ	PWM Ch. 1
2	PWM Ch1 bis 12, PPM, RSSI, LQ, RSSI/LQ	PWM Ch. 2
3	PWM Ch1 to 12, RSSI, LQ, RSSI/LQ, SBUS, n.i.SBUS, Serial TX, MAVLink TX, CRSF TX, SmartAudio	PWM Ch. 3
4	PWM Ch1 bis 12, RSSI, LQ, RSSI/LQ, Serial RX, MAVLink RX, CRSF RX	PWM Ch. 4
5	PWM Ch1 bis 12, RSSI, LQ, RSSI/LQ	PWM Ch. 5
6	PWM Ch1 bis 12, RSSI, LQ, RSSI/LQ, Serial RTS	PWM Ch. 6
7	PWM Ch1 bis 12, RSSI, LQ, RSSI/LQ, Serial RX, MAVLink RX, CRSF RX	PWM Ch. 7
8	PWM Ch1 to 12, RSSI, LQ, RSSI/LQ, SBUS, n.i.SBUS, Serial TX, MAVLink TX, CRSF TX, DSMX, SmartAudio	PWM Ch. 8

Receiver pin	Output type Diversity RX (Nano)	Default value
1	PWM Ch1 bis 12, PPM, RSSI, LQ, RSSI/LQ, CRSF TX	PWM Ch. 1
2	PWM Ch1 bis 12, PPM, RSSI, LQ, RSSI/LQ, CRSF RX	PWM Ch. 2
3	PWM Ch1 to 12, RSSI, LQ, RSSI/LQ, SBUS, n.i.SBUS, Serial TX, MAVLink TX, CRSF TX, DSMX, SmartAudio	PWM Ch. 3
4	PWM Ch1 bis 12, RSSI, LQ, RSSI/LQ, Serial RX, MAVLink RX, CRSF RX	PWM Ch. 4
5	PWM Ch1 bis 12, RSSI, LQ, RSSI/LQ, Serial RTS	PWM Ch. 5



6	PWM Ch1 bis 12, RSSI, LQ, RSSI/LQ, Serial RTS	PWM Ch. 6
7	PWM Ch1 bis 12, RSSI, LQ, RSSI/LQ, Serial RX, MAVLink RX, CRSF RX	PWM Ch. 7
8	PWM Ch1 to 12, RSSI, LQ, RSSI/LQ, SBUS, n.i.SBUS, Serial TX, MAVLink TX, CRSF TX, DSMX, SmartAudio	PWM Ch. 8

Receiver pin	Output type Micro V2/ Nano rx	Default value
1	PWM Ch1 bis 12, PPM, RSSI, LQ, RSSI/LQ, SBUS, n.i. SBUS, CRSF TX, MAVLink TX, SmartAudio, DSMX	CRSF TX
2	PWM Ch1 bis 12, PPM, RSSI, LQ, RSSI/LQ, CRSF RX, MAVLink RX	CRSF RX
3	PWM Ch1 bis 12, PPM, RSSI, LQ, RSSI/LQ, CRSF RX, MAVLink RX	PWM Ch. 3
4	PWM Ch1 bis 12, PPM, RSSI, LQ, RSSI/LQ, SBUS, n.i. SBUS, CRSF TX, MAVLink TX, SmartAudio, DSMX	Smart Audio
5 (BST)	PWM Ch1 bis 12, RSSI, LQ, RSSI/LQ, BST SDA	BST SDA
6 (BST)	PWM Ch1 bis 12, RSSI, LQ, RSSI/LQ, BST SCL	BST SCL

Receiver SBUS output

The CROSSFIRE 8ch diversity receiver as well as the CROSSFIRE Micro and Nano RX support SBUS and n.i.SBUS (non-inverted) respectively. The diversity receiver exposes this functionality on output port 8, selectable via the output port mapping menu. The Micro RX V1 only has one output port, and it is either PWM, PPM, SBUS, n.i.SBUS or CRSF capable. The micro receiver v2 got 4 (6) outputs where you can choose more than one output.

Receiver RSSI or/and LQ output

To get digital (PWM) RSSI, LQ (Link Quality) or RSSI/LQ output for use on OSD and similar equipment, pick a free channel and set the output to signal type you need. You can also output one of those signals by injecting it into the PPM stream for processing on an OSD or FC. Use the “Channel Map” menu for this. Beside of RSSI the receiver can also output link quality (LQ) or a combined value (RSSI/LQ). The RSSI/LQ value will always show the worse value of both. This is mostly useful if the used OSD only has one input for link statistics. You can set up your warning levels in your osd as following:



Sensor	Prewarning	Critical
RSSI	30%	20%
LQ	70%	60%
RSSI/ LQ	30%	20%

Since fw 2.32 LQ will stay at 100% while the CROSSFIRE transmits in 150Hz mode. When it switches to 50Hz mode you will see that it drops slightly.

If you want to get a audio warning for your OpenTX radio you can use [this short manual](#).

Serial bridge

The bridge feature gives you the ability to pass any kind of serial uart data from any device connected to the receiver to any device connected to the transmitter. If you selected "Bridge TX" on a capable pin the following pin will be set to "Bridge Rx" and the following to "Bridge RTS" (if not used by any other Serial protocol). Please connect your device according to this information. The baudrate is set to 57600 8N1 and the voltage level is 3.3V only. The RTS pin will change to logical high when the internal FIFO is almost full and low if the FIFO is almost empty. There is no hardware flow control for the uplink as the wireless close range telemetry module does not support it. The app-link mode on the TX will automatically change to bridge on the first few bytes sent down from the receiver if the mode is not set to "OFF".

MAVLink

MAVLink V1 is a very lightweight, header-only message marshalling library for air vehicles. Most of the common flight controller support MAVLink message format. For specific message documentation please refer here: [MAVLink Messages](#)

If you select "MAVLink TX" on one of the available outputs the corresponding output will be set to "MAVLink RX". There is no hardware flow control required as we support software flow control (RADIO_STATUS message) on both ends. You can connect it to any telemetry port of a MAVLink compatible FC. The MAVLink baudrate is set to 57600 baud. The MAVLink TX pin (output 8) needs to be connected to the FC telemetry RX pin and the MAVLink RX pin (output 7) need to be connected to the FC telemetry TX pin. The app-link mode on the TX will automatically change to MAVLink on the first frame sent down from the receiver if the mode is not set to "OFF".



Also, if you enable MAVLink for the capable output there will be an option to send RC signals over the MAVLink connection. You can find this setting under “RX Diversity” menu called “MAVLink PPM”. If this setting is enabled there is no PPM, SBUS connection required anymore between TBS CROSSFIRE and the FC. Note this MAVLink message (RC_CHANNELS_OVERRIDE) will only send channel 1 to 8 to the FC even if TBS CROSSFIRE is set to 12 channels.

The TBS CROSSFIRE receivers has a build in MAVLink engine which forwards messages like GPS, attitude, current sensor, flight mode, time, air speed and more to the BST bus. In case you use the TBS CORE PRO all required messages will be forwarded. The engine also adapt the MAVLink bandwidth to make it perfectly fit the RF link bandwidth. This gives you the best performance for both OSD on the TBS CORE PRO side and on the telemetry over TBS CROSSFIRE in terms of latency and update rate.

If you run the system with a TBS CORE PRO you can decide if you want to run the digital TBS current sensors or use the current sensor information from the FC for the OSD display. In case of using the current sensor from the FC you need to make a custom wire to power the TBS CORE PRO. This cable requires only two leads out of the default BST cable. +VBATT goes to the flight battery plus and GND goes to the flight battery minus. Make sure the other leads do not touch anything or short against each other.



MAVLink APM

For APM (ArduPilot) the telemetry port also need to be configured on the FC side. Otherwise you only will get telemetry if you connect by Tower app or similar first.

Please use mission planner for configuration. Settings can be found under "CONFIG/TUNING"-tab → "Full Parameter Tree" → "SR1-SR2". SR1 stands for telemetry port 1 and SR2 for telemetry port 2. Configure the telemetry port you are using according to the sample below.

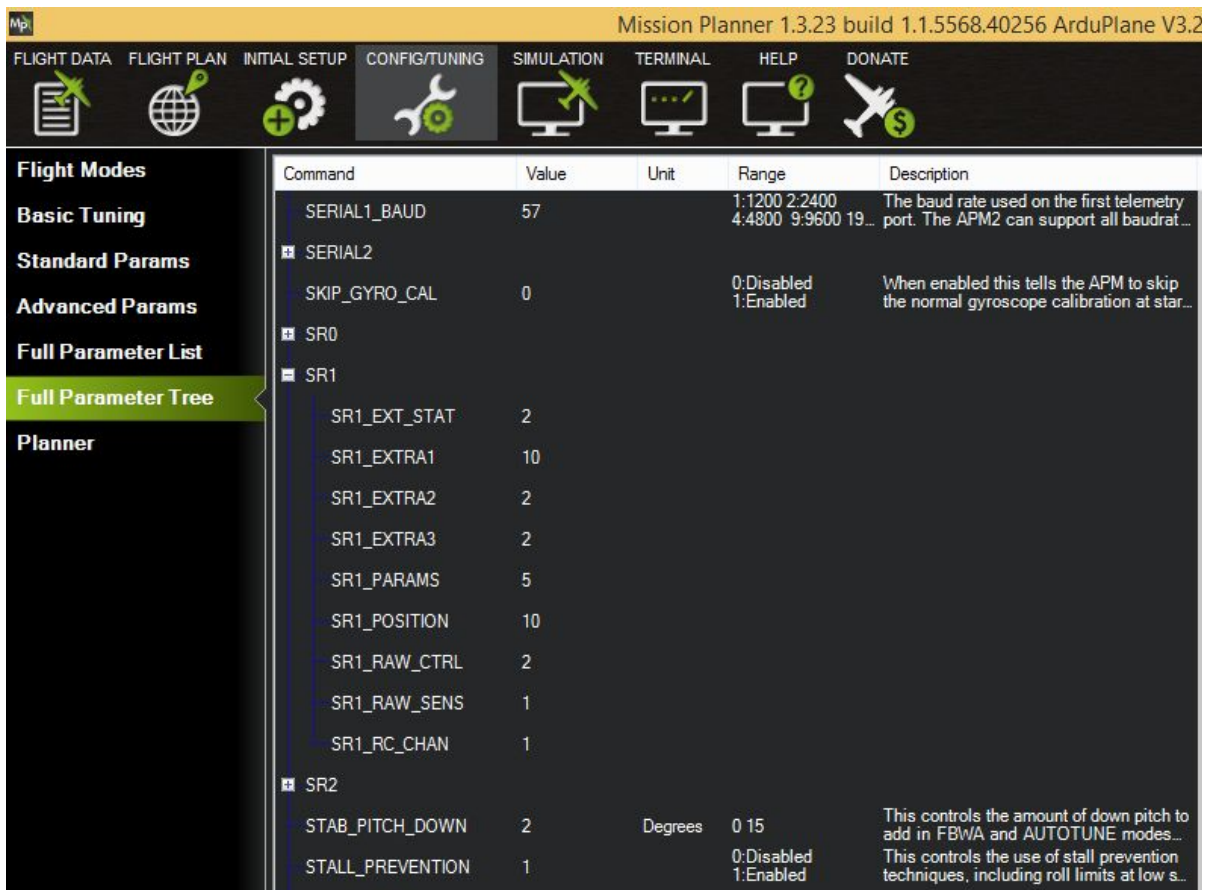

The screenshot shows the Mission Planner interface with the 'CONFIG/TUNING' tab selected. The 'Full Parameter Tree' is expanded, showing parameters for SR1 and SR2. The parameters are listed in a table below.

Command	Value	Unit	Range	Description
SERIAL1_BAUD	57		1:1200 2:2400 4:4800 9:9600 19...	The baud rate used on the first telemetry port. The APM2 can support all baudrat...
SERIAL2				
SKIP_GYRO_CAL	0		0:Disabled 1:Enabled	When enabled this tells the APM to skip the normal gyroscope calibration at star...
SR0				
SR1				
SR1_EXT_STAT	2			
SR1_EXTRA1	10			
SR1_EXTRA2	2			
SR1_EXTRA3	2			
SR1_PARAMS	5			
SR1_POSITION	10			
SR1_RAW_CTRL	2			
SR1_RAW_SENS	1			
SR1_RC_CHAN	1			
SR2				
STAB_PITCH_DOWN	2	Degrees	0 15	This controls the amount of down pitch to add in FBWA and AUTOTUNE modes...
STALL_PREVENTION	1		0:Disabled 1:Enabled	This controls the use of stall prevention techniques, including roll limits at low s...

Disable telemetry

Telemetry can be disabled under RX Settings. If the telemetry is turned off the transmitter will not get any feedback. This will affect the dynamic power and the status information on the transmitter side. Dynamic power will be automatically switched off and remain on the max. power setting. Links statistics will not be updated anymore and the RF mode will be set to 50Hz.

Note: None of this will affect the the link. It just changes the link from a bidirectional one to a unidirectional one. Refer this paper for further information: [FPV Racing Whitepaper](#)

CRSF

Our CRSF protocol provides bidirectional end-to-end communication, fault detection and very-low latency.



DSMX

DSMX is designed to use the Crossfire as a backup system for Spektrum receivers.

SmartAudio

With SmartAudio you can control your Unify VTX straight through the CROSSFIRE Menu/ LUA Script. You can setup your channel, band, power level or a custom frequency. All versions of SmartAudio are supported.



Transmission power

The transmitter's RF output power is highly configurable and can be selected dynamically via the menu. It defaults to 100mW and will provide 15 km of safe range in rural conditions.

It is recommended to use dynamic power option. This will allow you to fly at very low power and the system will increase the power automatically (faster than you can hit the power switch yourself) if you are about to lose the link.

Some output power restrictions apply depending on the available power source:

Power source	Available output power
USB power input (+5V)	10mW (10dBm)
RC/HT radio power input (+3.5 to +12.6V)	10mW (10dBm), 25mW (14dBm), 100mW (20dBm), 250mW* 500mW (27dBm) 1W (30dBm)**
External LiPo power input (+3.5V to +12.6V) (XT30-JST, shown in photo below)	10mW (10dBm), 25mW (14dBm), 100mW (20dBm), 500mW (27dBm), 1W (30dBm)



* 250mW is the maximum output power of the micro tx. It is also only available on the micro modul.

**Please check if your Radio is capable to provide enough power for the 1W option. Otherwise you might break the electronics inside of your radio. The TBS TANGO can handle these power levels.

To change RF power:

1. Enter the configuration menu/ LUA script select "General"/ "Crossfire TX" and "Max Power"
2. Pick the RF output power you require and exit the menu to confirm
3. The change is instant if the required input power is available and can be done at any moment

Every 6 dBm increase in output power results in a doubling of the theoretical possible distance that is achievable.

If you set a power level that is outside the connected power source, it will still be remembered for later but the output power will be limited to according to the table above.

You may hear a subtle buzzing or humming sound on some radios or nearby speakers on higher power levels. This is completely normal and non-harmful. In the case of the Taranis it is an issue of the remote



itself and can be fixed by following [this guide by boltrc.com](https://boltrc.com).



Dynamic transmission power

The system can automatically choose the power level most suitable for the situation at hand. For instance, if you fly close to the transmitter you normally only require minimal TX power and the system will therefore switch to lowest possible TX power level required to maintain a good up-link.

The maximum TX power level the system is allowed to use, can be defined by changing "Max Power" in the configuration menu.

To enable dynamic power:

1. Enter the configuration menu, select "General" and "Dyn. Power"
2. Toggle "Off" to "On" by pressing Down, exit the menu to apply the change
3. The current dynamic TX power level is displayed in the main display (standard TX) or as sensor in OpenTX

Transmission frequency

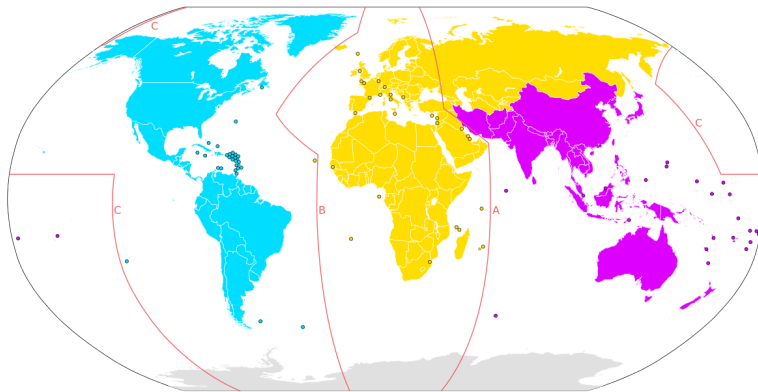

CC Wikipedia

The TBS CROSSFIRE supports two different frequency bands, depending on your local regulation..

Below is a general overview of the primary frequency segmentation.

General area	Frequency
ITU Region 1 - Europe/Africa/Middle East (yellow)	868 MHz SRD band
ITU Region 2 - America/Greenland (blue)	915 MHz ISM band
ITU Region 3 - Asia/Oceania (purple)	915 MHz ISM band



Operating modes

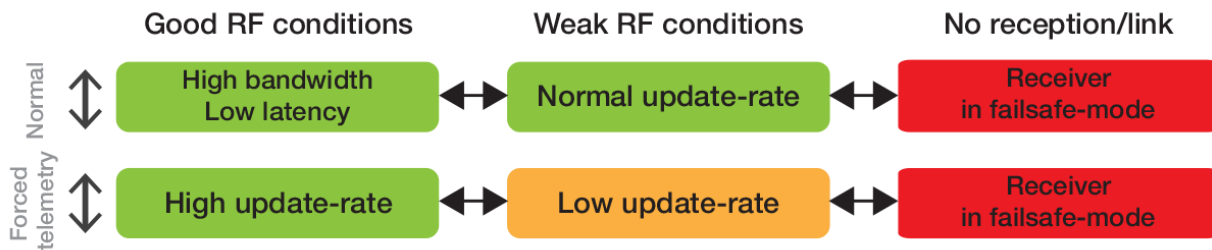

The link has two operation modes which are based on three RF profiles. Every mode has its pros and cons. TBS CROSSFIRE always switches between two RF profiles, depending on the current link health while you are flying. The two profiles used is according to your decision to use "Normal" or "Force telemetry" modes. Which two RF profiles are in use for each mode is showed in the diagram above. We recommend to use the default "Normal" mode as it fits the most of the use cases.



RF Profiles

- **High bandwidth / Low latency profile**

This mode is tuned for ultra-high update-rate and super low latency. Stick inputs translates to almost instantaneous reaction (150Hz). It is capable of exchanging large amounts of serial data in both directions besides the regular RC signals. The range of this mode is lower but comparable to other LRS systems on the market. Provides full MAVLink or serial bridge, if used.

- **Normal update-rate profile**

This profile is made for long range flight with a normal update rate on your stick inputs (50Hz). It has also telemetry support in both directions, but only for the most important information i.e. GPS, current sensor, attitude, and simple commands. The range improves about two-fold. You can also force the Crossfire to use this profile so it does not switch in to the 150Hz mode.

- **Low update-rate profile**

This mode is made for ultra long range. It has a very low update rate (4Hz). Only 4 new servo positions per second is sent over the link but it will give you 4 times more range compared to the "Normal update-rate" profile. Telemetry has even less bandwidth. It is recommended to only use this RF profile (Forced telemetry mode) when in assisted flight modes (GPS, position hold, waypoint navigation).

To change link mode:

1. Enter the configuration menu, select "General"
2. Toggle between "Normal" and "Forced Telemetry"
3. Exit the menu to instantaneously enable the new link mode

Force RF 50Hz:

1. Enter the receiver menu, select "General"
2. Toggle between "On" and "Off"
3. Exit the menu to instantaneously enable the new link mode



MyVTX

With the new MyVTX menu you can set all your vtx's to the same channel, band and output power.

To use the MyVTX settings, update your TBS Crossfire to FW 3.21. Connect your vtx to the crossfire receiver by CRSF or Smart Audio (details in the previous chapters). Now you get a new menu in the TBS CROSSFIRE TX Menu:

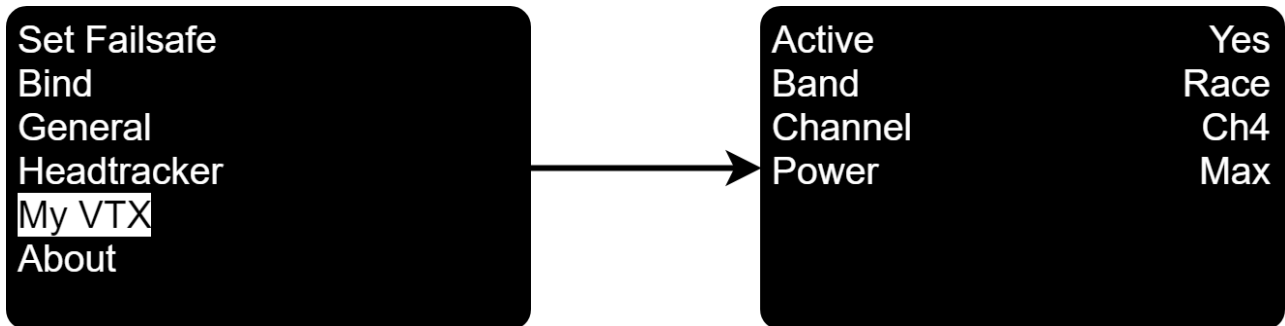

Settings	Description
Active	activate/ deactivate the global vtx settings
Band	Band settings, Race/ Low/ A/ B/ E/ Airwave/ User Frequency
Channel/ Frequency	1 - 8/ 5620 - 5920
Power	Vtx power level, 25/ 100/ 400/ max mW

Note: This setting will override all your vtx settings like Pitmode, power level etc, till you disable them. Then the VTx will revert back to the last used settings.



CRSF Connectivity with flight controller (COLIBRI)

Getting either of our CROSSFIRE receivers connected to the flight controller (BetaFlight/COLIBRI) through our CRSF serial protocol enables you to have the most accurate and low-latency remote control possible on the market. By integrating the CRSF protocol end-to-end (currently supported on TBS TANGO, Taranis/OpenTX, BetaFlight FC, KISS FC and INav) allows you to make the full use of the new bidirectional protocol.

In addition to a wide range of telemetry data about the uplink, downlink and the model itself via our BST protocol, the CRSF protocol also supports remote changes of the flight controller settings (BetaFlight, KISS).

The CROSSFIRE receiver (firmware 1.59 and later) comes our latest digital CRSF V2 (**CRosSFire**) protocol. It has the following advantages:

- R/C data transferred at high speed serial format
- Up to 150Hz , 3x faster than SBUS
- Lower latency
- CRC protection (error detection)
- Bidirectional communication, telemetry capable
- Changing settings remotely (via OSD or LUA scripts)

Minimum requirements

To get started, the system requires the following prerequisites:

- Flight controller (COLIBRI FC) with one free UART port (no inverter)
- Betaflight V3.1, INAV 1.7, KISS or higher, CleanFlight to follow soon
- Taranis etc. radio with OpenTX V2.2 or later, TBS TANGO
- TBS CROSSFIRE with BETA V1.62 or later



Wiring layout

Since the CRSF protocol is serial, it has to be connected to a free serial/UART port on the flight controller. On the COLIBRI RACE you can choose UART 1 or 3. If you use the POWERCUBE with FPV Vision, you can use also use UART2. The pin-out and wiring layout shown in the following table and on the included diagram.

CROSSFIRE MICRO V1 RX	CROSSFIRE MICRO V2 RX/ Nano RX	CROSSFIRE DIVERSITY RX		Clean-/BetaFlight Serial port (COLIBRI or other)
Ch./Pin 1 TX	Ch./Pin 1 TX, 5V, GND	Ch./Pin 8 TX, 5V, GND	⇒	UART1 or 3 RX, 5V, GND
Not available	Ch./Pin 2 RX only	Ch./Pin 7 RX only	⇐	UART1 or 3 TX

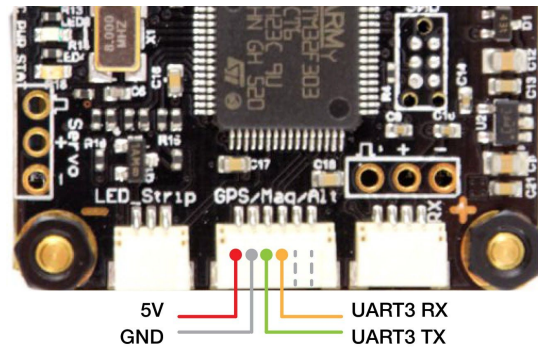
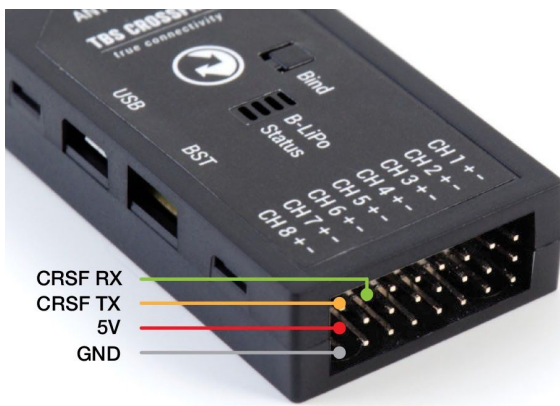

In addition to the CRSF serial connection, you might want to connect BST (BlackSheep Telemetry) between the CROSSFIRE RX and COLIBRI to provide more telemetry and make changes remotely on the CORE PRO (if connected) or FPV Vision (if part of the POWERCUBE).

CROSSFIRE RX	BST ⇒	CORE PRO	BST ⇒	POWERCUBE standard	INT.	COLIBRI FC
CROSSFIRE RX	BST ⇒		BST ⇒	POWERCUBE FPVision	INT.	COLIBRI FC



Setting up radio for CRSF

With the CROSSFIRE transmitter in place on the radio, you have to change, or make sure, that the internal radio is OFF and the external radio protocol (between the radio and transmitter module) is set to CRSF.

```
MODEL SETUP 2/13
Internal RF
Mode OFF
External RF
Mode CRSF
Channel Range CH1-16
Trainer port
Mode Master/Jack
```

On the CROSSFIRE transmitter OLED display, you should now see "RC Input: CRSF V2", meaning you have CRSF enabled and running.

```
TBS CROSSFIRE
Link Status: Running
TX Power: 25mW
RC Input: CRSF V2
HT Input: No signal!
```

Setting up receiver for CRSF

With the CROSSFIRE receiver powered and connected, go into the settings menu, turn "Telemetry" to "On", then open the "Output mapping" screen. On the CROSSFIRE MICRO V1, only CRSF TX will be available.

```
General
Set Failsafe
Binding
RX Micro V2 [OR] Diversity
Headtracker
About

Output Map.
Channel Map.
Mode 8Ch
Telemetry ON
Failsafe Mode FS. Pos
Factory Reset
```

For the CROSSFIRE DIVERSITY RX, change "Output 8" to "CRSF TX" and "Output 7" to "CRSF RX". While on the CROSSFIRE MICRO V2 RX, change "Output 1" to "CRSF TX" and "Output 2" to "CRSF RX".

This will output CRSF on the respective ports on the receiver pin header. 5V compatible.

```
Diversity:
Output 1 Src.Ch. 1
Output 2 Src.Ch. 2
...
...
Output 7 CRSF RX
Output 8 CRSF TX

Micro V2/Nano:
Output 1 CRSF TX
Output 2 CRSF RX
Output 3 Src.Ch. 6
Output 4 Src.Ch. 7
```



Configuring BetaFlight for CRSF protocol

Last thing is to set up BetaFlight. Open the configurator and connect USB to the the flight controller. Hit “Ports” and disable UART2 and enable UART3. Click “Save and reboot”.

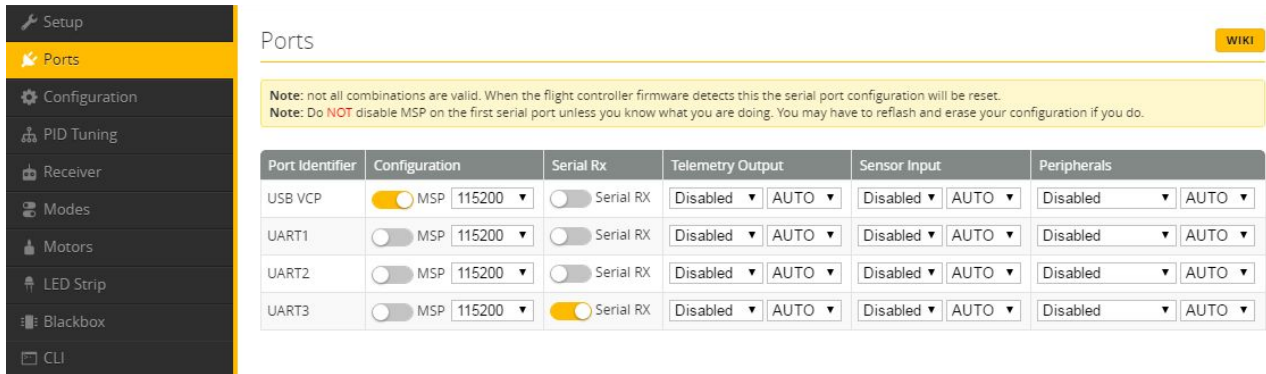

The screenshot shows the BetaFlight configuration interface with the "Ports" tab selected. A sidebar on the left contains menu items: Setup, Ports, Configuration, PID Tuning, Receiver, Modes, Motors, LED Strip, Blackbox, and CLI. The main area is titled "Ports" and includes a "WIKI" button. A yellow note states: "Note: not all combinations are valid. When the flight controller firmware detects this the serial port configuration will be reset. Note: Do NOT disable MSP on the first serial port unless you know what you are doing. You may have to refresh and erase your configuration if you do." Below the note is a table with columns: Port Identifier, Configuration, Serial Rx, Telemetry Output, Sensor Input, and Peripherals.

Port Identifier	Configuration	Serial Rx	Telemetry Output	Sensor Input	Peripherals
USB VCP	<input checked="" type="checkbox"/> MSP 115200	<input type="checkbox"/> Serial RX	Disabled AUTO	Disabled AUTO	Disabled AUTO
UART1	<input type="checkbox"/> MSP 115200	<input type="checkbox"/> Serial RX	Disabled AUTO	Disabled AUTO	Disabled AUTO
UART2	<input type="checkbox"/> MSP 115200	<input type="checkbox"/> Serial RX	Disabled AUTO	Disabled AUTO	Disabled AUTO
UART3	<input type="checkbox"/> MSP 115200	<input checked="" type="checkbox"/> Serial RX	Disabled AUTO	Disabled AUTO	Disabled AUTO

Next, open the “Configurations” and in the “Receiver” section pick “Serial based receiver” and “CRSF”.

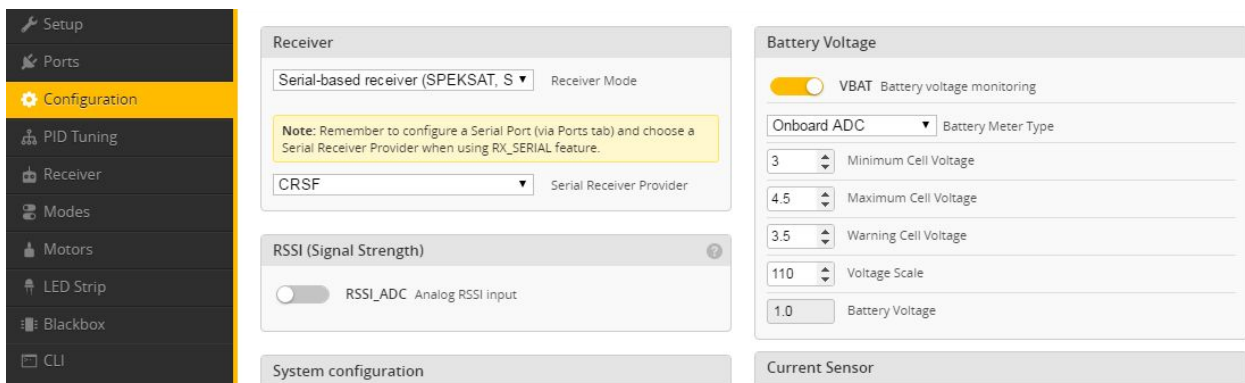

The screenshot shows the BetaFlight configuration interface with the "Configuration" tab selected. The sidebar is the same as in the previous image. The main area is divided into several sections: "Receiver", "Battery Voltage", "RSSI (Signal Strength)", and "System configuration".

Receiver section: Shows "Serial-based receiver (SPEKSAT, S)" selected for "Receiver Mode" and "CRSF" selected for "Serial Receiver Provider". A yellow note says: "Note: Remember to configure a Serial Port (via Ports tab) and choose a Serial Receiver Provider when using RX_SERIAL feature."

Battery Voltage section: Shows "VBAT Battery voltage monitoring" enabled. Other settings include: "Onboard ADC" for "Battery Meter Type", "3" for "Minimum Cell Voltage", "4.5" for "Maximum Cell Voltage", "3.5" for "Warning Cell Voltage", "110" for "Voltage Scale", and "1.0" for "Battery Voltage".

To allow flight controller telemetry to be sent back, make sure “Telemetry” is enabled in the “Other features” section.

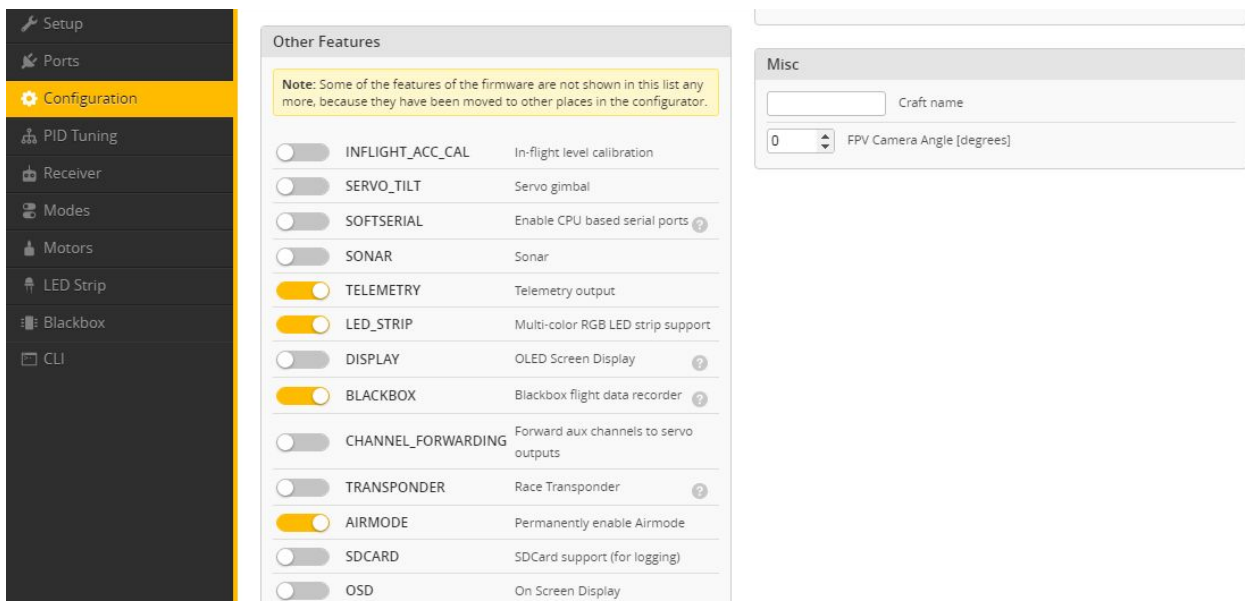

The screenshot shows the BetaFlight configuration interface with the "Configuration" tab selected. The sidebar is the same as in the previous images. The main area is divided into "Other Features" and "Misc" sections.

Other Features section: A yellow note states: "Note: Some of the features of the firmware are not shown in this list any more, because they have been moved to other places in the configurator." The following features are listed with their status:

- INFLIGHT_ACC_CAL: In-flight level calibration
- SERVO_TILT: Servo gimbal
- SOFTSERIAL: Enable CPU based serial ports
- SONAR: Sonar
- TELEMETRY: Telemetry output
- LED_STRIP: Multi-color RGB LED strip support
- DISPLAY: OLED Screen Display
- BLACKBOX: Blackbox flight data recorder
- CHANNEL_FORWARDING: Forward aux channels to servo outputs
- TRANSPONDER: Race Transponder
- AIRMODE: Permanently enable Airmode
- SDCARD: SD Card support (for logging)
- OSD: On Screen Display

Misc section: Shows "Craft name" as an empty text field and "FPV Camera Angle [degrees]" set to "0".



Discovering telemetry data sensors

To get the new telemetry data running and showing on the radio, you have to update and discover the new remote sensors available.

On taranis, select the model and go to the "Telemetry" page. Delete all the old sensors, if any, and hit "Discover new sensors".

```
TELEMETRY 12/13
RSSI
Low alarm      45
Critical alarm  42
Sensors        Value      ID
Discover new sensors
Add a new sensor...
Delete all sensors
```

Momentarily, the new (four character) sensors will populate the list, f.ex. CROSSFIRE downlink/uplink stats, altitude, GPS position, battery voltage, current draw, current consumption, FC pitch, FC roll, FC yaw, and more. The available sensors depend on the auxiliary sensors you may have connected, e.g. TBS GPS, TBS Current sensor/TBS POWERCUBE and/or CRSF flight controller.

```
TELEMETRY 12/13
Sensors        Value      ID
1: 1RSS      *      22dB      0
2: 2RSS      *      22dB      1
3: RQ1y      *      100%      2
4: RSNR      *      75dB      3
5: RFMD      *      2          4
6: TPWR      *      10mW      5
7: TRSS      *      21dB      6
8: TQ1y      *      100%      7
9: TSNR      *      82dB      8
10: RxBt     *      13.7U     9
11: Curr     *      0.1A     10
12: Capa     *      116mAh    11
13: GPS      *      0°00'N 0°00'E 12
14: Alt      *      0m        13
15: Sats     *      0         14
16: Ptch     *      0.07rad   15
17: Roll     *      0.04rad   16
18: Yaw      *      1.43rad   17
19: FM       *      AIR       18
Discover new sensors
Add a new sensor...
Delete all sensors
Ignore instances
```

No Sensors found

If you are having problems with discovering more than just a few or any sensor you need to uncheck the "Ignore Instances" option below the sensor list and rediscover the Sensors.



You can now assign the telemetry data points as you want to the main radio screens and set up any alarms that might come in handy.

DISPLAY		13/13
Top bar		
Voltage source	RxBt	
Altitude	Alt	
Screen 1	NUMS	
1RSS	RQ1y	RSNR
2RSS	TQ1y	TSNR
TRSS	RFMD	TPWR

Having the radio stats on one screen and flight critical information on another provides a fine way of keeping on top of operations.

TBS		13.7U	
1RSS	33	RQ1y	100
2RSS	33	TQ1y	100
TRSS	27	RFMD	2
		RSNR	59
		TSNR	68
		TPWR	10

TBS		13.7U	
RxBt	13.8	Curr	3.1
Sats	4	Alt	18
		CaPa	114
		°00'0.0"N	
		°00'0.0"E	



Configuration of CORE PRO / CROSSFIRE RX with LUA Scripts or the TBS TANGO

The CROSSFIRE allows bidirectional communication, that means the radio display interface (currently only OpenTX radios supported) can be used to remotely configure any TBS device (currently CROSSFIRE, CORE PRO) over the BST connection.

Requirements

The following requirements must be fulfilled to be able to use this feature:

- Any OpenTX radio (any Taranis, Horus) with OpenTX 2.2.x or higher
 - Nightly builds provided in the “News” section at <http://www.open-tx.org/>
- TBS CROSSFIRE LUA script package on root of SD card
 - Currently provided at <https://downloads.open-tx.org/2.2/sdcard/>
- TBS CROSSFIRE TX/RX V1.62 or higher
- TBS CORE PRO/FPVision V1.70 or higher
- TBS CORE PRO with SmartAudio (purchased after 07/2015) - for UNIFY PRO control

Setup

Connect the devices as normal via BST cables and the fc by CRSF and make sure the CROSSFIRE radio link is up and running.

On the radio, press and hold the “Menu” button to bring up the “Radio setup”. Press “Page” to go to page 2 “SD Card”.

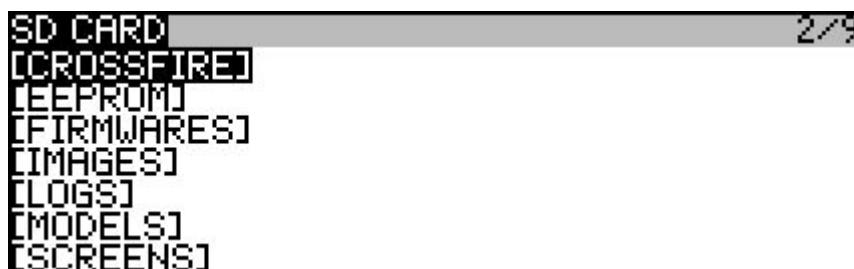

Move to the “CROSSFIRE” directory and open it. Press and hold “Enter” on the “crossfire.lua” file, select “Execute” to open the script. The device.lua file is not meant to be executed.

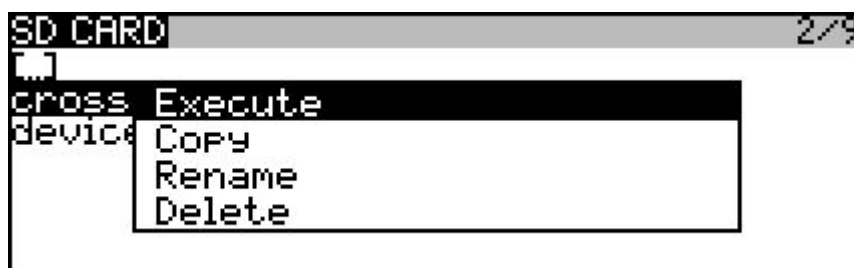

All the supported TBS devices that is connected via BST to the CROSSFIRE RX will show up immediately, e.g. "TBS CROSSFIRE TX", "TBS CROSSFIRE Diversity RX" or "TBS CORE PRO". Pick either to change the settings.

```
CROSSFIRE SETUP
TBS CROSSFIRE TX
TBS CROSSFIRE Diversity RX
TBS CORE PNP PRO
```

TBS CROSSFIRE TX settings:

```
TBS CROSSFIRE TX
Set. Failsafe
Binding
General
Region                Open
Max Power              10mW
Dyn. Power             On
Frequency              868 MHz
Op. Mode               Normal
Bluetooth              Off
Headtracker
Pan Source             Off
Pan Dest.              Off
Tilt Source            Off
Tilt Dest.             Off
Roll Source            Off
Roll Dest.             Off
About
Firmware:              U1.63
Hardware:              U1.02
Bootloader:            U1.06
Serial No:             016-000040
```

TBS CORE PRO / FPVision settings:

```
TBS CORE PNP PRO
-Video Transmitter
-Band                  A
-Channel               1
-User Frequency        5865MHz
-Power Level           25mW
-PitMode               Disable
-Exit PitMode
-Callsign
-Show Call Sign        Minutely
-Callsign              TBS
```

TBS CROSSFIRE RX:

Note: The outputs 7 and 8 are only available if the receiver is a diversity rx.



The VTX settings does only appear when the corresponding output has been configured to SmartAudio and the SA wire of a UNIFY PRO is connected to it.

```
TBS CROSSFIRE Diversity RX
Output Map
Output 1      CH1
Output 2      CH2
Output 3      CH3
Output 4      CH4
Output 5      CH5
Output 6      CH6
Output 7      CRSF RX
Output 8      CRSF TX
Channel Map
Dst.Ch. 1     CH1
Dst.Ch. 2     CH2
Dst.Ch. 3     CH3
Dst.Ch. 4     CH4
Dst.Ch. 5     CH5
Dst.Ch. 6     CH6
Dst.Ch. 7     CH7
Dst.Ch. 8     CH8
Dst.Ch. 9     CH9
Dst.Ch.10    CH10
Dst.Ch.11    CH11
Dst.Ch.12    CH12
General
Mode          12 Ch.
Telemetry     On
Failsafe Mode FS. Pos.
RC by MAVLink On
SBUS Rate     50Hz
```

The changes will be committed once you leave the settings page.



Telemetry

The following table provides an overview of the telemetry points available for the TBS compatible equipment. Note that Pixhawk APM and EagleTree telemetry is not included here.

Datapoint	Description	Data source
1RSS	Uplink - received signal strength antenna 1 (RSSI)	TBS CROSSFIRE RX
2RSS	Uplink - received signal strength antenna 2 (RSSI)	TBS CROSSFIRE RX
RQly	Uplink - link quality (valid packets)	TBS CROSSFIRE RX
RSNR	Uplink - signal-to-noise ratio	TBS CROSSFIRE RX
RFMD	Uplink - update rate, 0 = 4Hz, 1 = 50Hz, 2 = 150Hz	TBS CROSSFIRE RX
TPWR	Uplink - transmitting power	TBS CROSSFIRE TX
TRSS	Downlink - signal strength antenna (radio controller)	TBS CROSSFIRE TX
TQly	Downlink - link quality (valid packets)	TBS CROSSFIRE TX
TSNR	Downlink - signal-to-noise ratio	TBS CROSSFIRE TX
GPS	GPS Coordinates	TBS GPS/Compass/ BF
Alt	GPS Altitudes	TBS GPS/Compass/ BF
Sats	GPS Satellites acquired	TBS GPS/Compass / BF
!!!!!!	Magnetic orientation	TBS GPS/Compass/ BF
RxBt	Battery voltage	TBS CORE PRO / FPVision/ BF
Curr	Current draw	TBS CORE PRO / FPVision/ BF
Capa	Current consumption	TBS CORE PRO / FPVision/ BF
Ptch	FC Pitch angle	BetaFlight FC with CRSF
Roll	FC Roll angle	BetaFlight FC with CRSF
Yaw	FC Yaw angle	BetaFlight FC with CRSF
FM	Flight mode	BetaFlight FC with CRSF



Firmware upgrade

Updates to the CROSSFIREis applied using our TBS Agent software. This takes care of all the downloading of the latest firmware, verification- and upgrade process.

Installing TBS Agent

Download the installer from <http://www.team-blacksheep.com/corepro/agent> (Windows7/8/10+, 64-bit required) - no drivers needed to use the application, but an Internet connection is required to download the latest firmware versions.

Plug in a micro-USB cable on the transmitter or receiver, power is provided via USB. The software will automatically detect the device and offer you the option to upgrade the firmware if a newer version is available. If you like beta versions, press F1 and enable the checkbox.

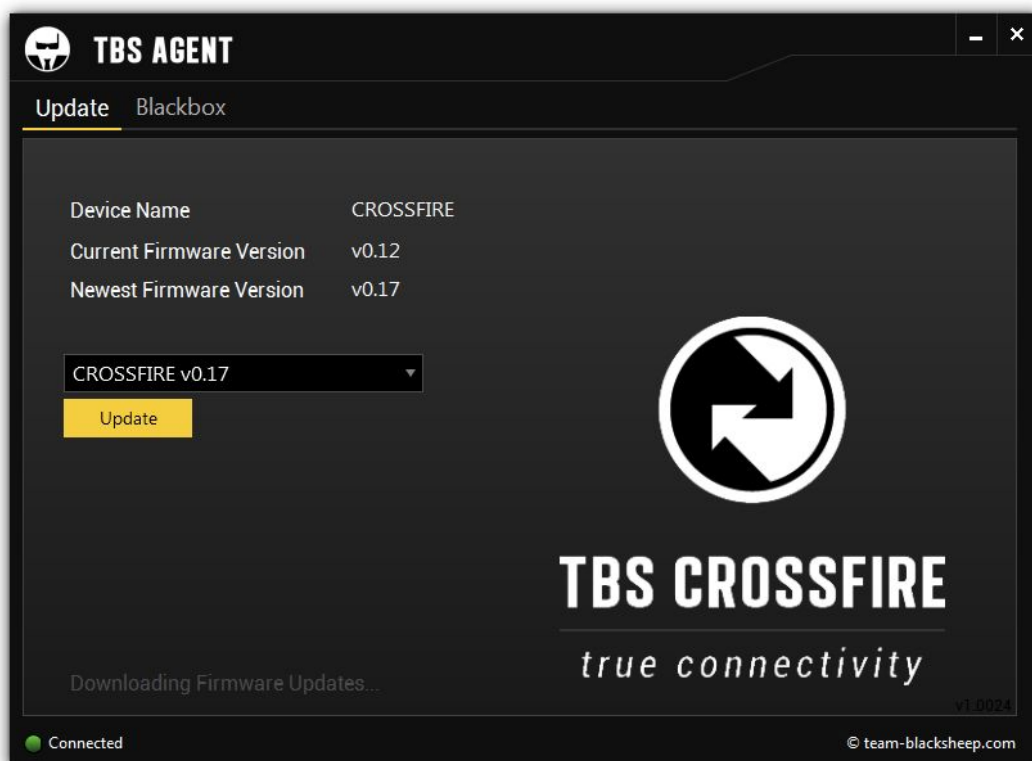

When the status indicator is green and says “Connected”, you can upgrade or downgrade the firmware.

To upgrade the firmware, select the latest version from the drop-down menu and click Update. You can also upgrade the Crossfire receiver via the CORE PRO if it is connected on BST. Rapid blinking indicates that the process is working and being updated. The process will take about 1 minute. Check all settings after the process is finished.

Emergency update

Every device has the option to still upload the firmware if something went wrong during the normal update



procedure. For the devices with USB it is very simple. You just press and hold the bind button for the diversity receiver or the joystick enter button for the transmitter while you plug in the USB cable. The device will show up inside the TBS Agent and you have the ability to reload the firmware.

For the micro receiver it is a little bit more complicated. As the device itself does not have a USB connector the firmware needs to be loaded by BST for emergency update. This requires a TBS CORE PRO or a diversity receiver. Connect the micro receiver to one of those devices by BST. Press and hold the bind button of the micro receiver while powering up the TBS CORE PRO or the diversity receiver by USB. In case of the diversity receiver you need to keep pressing the bind button while powering up the micro receiver with an own power supply.

The LED of the micro receiver should blink fast which indicates the receiver is in bootloader mode.

Open your TBS Agent and load the latest version. Once the device connected directly to the USB is updated, the TBS Agent will update the micro receiver too.

For further information you can check [this manual](#).



FAQ

Some common and some special outlier questions for the CROSSFIRE system.

- Droidplanner can't connect to wireless close range telemetry module
 - Use DroidPlanner 2 only for MAVLink emulator not the Tower app
 - Go under settings and make sure connection type is set to Bluetooth
 - Go under Settings -> Advanced -> Connection Preferences and press Forget default device
- TBS CROSSFIRE Seems not to work with Futaba T18SG
 - It required you use an external battery to power the TBS Crossfire
 - Go to Trainer port settings and select ACT, Student and 8 Ch. or 12 Ch.
- Does the transmitter forget the receiver when I bind a new receiver
 - No. The receiver stores the serial number of the transmitter. Everything is based on this.
So you can bind as many receivers as you want.
- What happens if I have more than one receiver running at time
 - We recommend to run only one receiver at time but if you like to, you can run more than one receiver at time. As the system is not designed for this use case some features need to be disabled to make it work properly. Make sure both receivers run in the same operation mode, 8 or 12 channel mode and both have telemetry disabled.



Good practices

We have compiled a list of all of practices which have been tried and tested in countless environments and situations by the TBS crew and other experienced FPV pilots.

Follow these simple rules, even if rumors on the internet suggest otherwise, and you will have success in FPV.

- Start with the bare essentials and add equipment one step at a time, after each new equipment was added to proper range- and stress tests.
- Do not fly with a video system that is capable of outperforming your R/C system in terms of range.
- Do not fly with a R/C frequency higher than the video frequency (e.g. 2.4GHz R/C, 900MHz video).
- Monitor the vitals of your plane (R/C link and battery). Flying with a digital R/C link without RSSI is dangerous.
- Do not use 2.4GHz R/C unless you fly well within its range limits, in noise-free environments and always within LOS. Since this is most likely never the case, it is recommended to not use 2.4GHz R/C systems for longer range FPV.
- Do not fly at the limits of video, if you see noise in your picture, turn around and buy a higher-gain receiver antenna before going out further.
- Shielded wires or twisted cables only, anything else picks up RF noise and can cause problems.
- When using powerful R/C transmitters, make sure your groundstation equipment is properly shielded.
- Adding Return-To-Home (RTH) to an unreliable system does not increase the chances of getting your plane back. Work on making your system reliable without RTH first, then add RTH as an additional safety measure if you must.
- Avoid powering the VTx directly from battery, step-up or step-down the voltage and provide a constant level of power to your VTx. Make sure your VTx runs until your battery dies.
- Do not power your camera directly unless it works along the complete voltage range of your battery. Step-up or step-down the voltage and provide a constant level of power to your camera. Make sure your camera runs until your battery dies.
- A single battery system is safer than using two dedicated batteries for R/C and FPV. Two batteries in parallel even further mitigate sources of failure.
- For maximum video range and “law compatibility”, use 2.4GHz video with high-gain antennas.
- When flying with R/C buddies that fly on 2.4GHz, or when flying in cities, it is perfectly possible to use 2.4GHz video provided you stick to the channels that do not lie in their band (CH5 to CH8 for Lawmate systems, available from TBS).
- Do not use diversity video receivers as a replacement for pointing your antennas, diversity should be used to mitigate polarization issues.



-
- Improving the antenna gain on the receiver end is better than increasing the output power (except in RF-noisy areas). More tx power causes more issues with RF on your plane.
 - Try to achieve as much separation of the VTx and R/C receiver as possible to lower the RF noise floor and EMI interference.
 - Do not buy the cheapest equipment unless it is proven to work reliably (e.g. parts falling off, multitudes of bug fix firmware updates, community hacks and mods are a good indicator of poor quality and something you do NOT want to buy for a safe system). Do due diligence and some research before sending your aircraft skyward.



FCC statement

This device complies with part 15 of the FCC Rules. Operation is subject to the following two conditions: (1) This device may not cause harmful interference, and (2) this device must accept any interference received, including interference that may cause undesired operation.

Changes or modifications not expressly approved by the party responsible for compliance could void the user's authority to operate the equipment.

NOTE: This equipment has been tested and found to comply with the limits for a Class B digital device, pursuant to part 15 of the FCC Rules. These limits are designed to provide reasonable protection against harmful interference in a residential installation.

This equipment generates, uses and can radiate radio frequency energy and, if not installed and used in accordance with the instructions, may cause harmful interference to radio communications. However, there is no guarantee that interference will not occur in a particular installation.

If this equipment does cause harmful interference to radio or television reception, which can be determined by turning the equipment off and on, the user is encouraged to try to correct the interference by one or more of the following measures:

- Reorient or relocate the receiving antenna.
- Increase the separation between the equipment and receiver.
- Connect the equipment into an outlet on a circuit different from that to which the receiver is connected.
- Consult the dealer or an experienced radio/TV technician for help.

FCC ID of TBS Crossfire Products

Crossfire TX - FCC ID: QOS-TX2W

Crossfire Micro TX - FCC ID: QOS-TXMICRO

Crossfire Micro RX - FCC ID: QOS-RXMICRO

Crossfire Nano RX - FCC ID: QOS-RXNANO

Crossfire Nano Diversity RX - FCC ID: QOS-RXNANODIV

Manual written and designed by ivc.no in cooperation with TBS.

