

FCC 47 CFR PART 15 SUBPART C

Product Type : Bluetooth module
Applicant : BlueGiga Technologies Inc.
Address : Sinikalliontie 5A, Espoo, FI-02630, Finland
Trade Name : bluegiga
Model Number : WT41-E
Test Specification : FCC 47 CFR PART 15 SUBPART C: Oct., 2012
ANSI C63.4:2009
Receive Date : Nov. 25, 2013
Test Period : Nov. 26, 2013
Issue Date : Apr. 30, 2014

Issue by

A Test Lab Techno Corp.
No. 140-1, Changan Street, Bade City,
Taoyuan County 334, Taiwan R.O.C.
Tel : +886-3-2710188 / Fax : +886-3-2710190



Taiwan Accreditation Eoundation accreditation number: 1330

Note: This report shall not be reproduced except in full, without the written approval of A Test Lab Techno Corp. This document may be altered or revised by A Test Lab Techno Corp. personnel only, and shall be noted in the revision section of the document. The client should not use it to claim product endorsement by TAF, or any government agencies. The test results in the report only apply to the tested sample.

Revision History

Rev.	Issue Date	Revisions	Revised By
00	Dec. 20, 2013	Initial Issue	
01	Apr. 30, 2014	Revised test results.	Joyce Liao

Verification of Compliance

Issued Date: 04/30/2014

Product Type : Bluetooth module
Applicant : BlueGiga Technologies Inc.
Address : Sinikalliontie 5A, Espoo, FI-02630, Finland
Trade Name : bluegiga
Model Number : WT41-E
FCC ID : QOQWT41E
EUT Rated Voltage : DC 3.3V
Test Voltage : DC 12V
Applicable Standard : FCC 47 CFR PART 15 SUBPART C: Oct., 2012
ANSI C63.4:2009

Application Purpose : Class II Permissive Change

Test Result : Complied

Performing Lab. : A Test Lab Techno Corp.
No. 140-1, Changan Street, Bade City,
Taoyuan County 334, Taiwan R.O.C.
Tel : +886-3-2710188 / Fax : +886-3-2710190
Taiwan Accreditation Foundation accreditation number: 1330
<http://www.atl-lab.com.tw/e-index.htm>



The above equipment was tested by A Test Lab Techno Corp. The test data, data evaluation, test procedures, and equipment configurations shown in this report were made in accordance with the procedures given in ANSI C63.4: 2009 and the energy emitted by the sample tested as described in this report is in compliance with the requirements of FCC Rules Part 15.207, 15.209, 15.247 .

The test results of this report relate only to the tested sample identified in this report.

Approved By : Fly Lu Reviewed By : Eric Ou Yang
(Manager) (Fly Lu) (Testing Engineer) (Eric Ou Yang)

TABLE OF CONTENTS

1	General Information.....	5
	1.1. Summary of Test Result.....	5
	1.2. Measurement Uncertainty.....	5
2	EUT Description.....	6
3	Test Methodology.....	7
	3.1. Mode of Operation.....	7
	3.2. EUT Exercise Software.....	7
	3.3. Configuration of Test System Details.....	8
	3.4. Test Site Environment.....	8
4	Radiated Interference Measurement.....	9
	4.1. Limit.....	9
	4.2. Test Instruments.....	9
	4.3. Setup.....	10
	4.4. Test Procedure.....	11
	4.5. Test Result.....	12
5	Band Edges Measurement.....	15
	5.1. Limit.....	15
	5.2. Test Setup.....	15
	5.3. Test Instruments.....	15
	5.4. Test Procedure.....	16
	5.5. Test Result.....	17
6	Antenna Measurement.....	21
	6.1. Limit.....	21
	6.2. Antenna Connector Construction.....	21

1 General Information

1.1. Summary of Test Result

Standard	Item	Result	Remark
15.247			
15.207	AC Power Conducted Emission	N/A	C2PC, not applicable.
Standard	Item	Result	Remark
15.247			
15.247(b)(1)	Max. Output Power	N/A	C2PC, not applicable.
15.247(c)	Transmitter Radiated Emissions	PASS	-----
15.247(a)(1)	20dB RF Bandwidth	N/A	C2PC, not applicable.
15.247(a)(1)(iii)	Carrier Frequency Separation	N/A	C2PC, not applicable.
15.247(a)(1)(iii)	Number of Hopping	N/A	C2PC, not applicable.
15.247(a)(1)(iii)	Time of Occupancy (Dwell Time)	N/A	C2PC, not applicable.
15.247(c)	Out of Band Conducted Spurious Emission	N/A	C2PC, not applicable.
15.247(c)	Band Edge Measurement	PASS	-----
15.247(c)	Occupied Bandwidth Measurement	N/A	C2PC, not applicable.
15.203	Antenna Requirement	PASS	-----

The test results of this report relate only to the tested sample(s) identified in this report. Manufacturer or whom it may concern should recognize the pass or fail of the test result.

1.2. Measurement Uncertainty

Test Item	Frequency Range		Uncertainty (dB)
Radiated Emission	30MHz ~ 1000MHz	Horizontal	± 3.98
		Vertical	± 3.62
	1000MHz ~ 18000MHz	Horizontal	± 3.11
		Vertical	± 3.07
	18000MHz ~ 40000MHz	Horizontal	± 3.66
		Vertical	± 3.54

2 EUT Description

Product	Bluetooth module
Trade Name	bluegiga
Model Number	WT41-E
Applicant	BlueGiga Technologies Inc. Sinikalliontie 5A, Espoo, FI-02630, Finland
Manufacturer	BlueGiga Technologies Inc. Sinikalliontie 5A, Espoo, FI-02630, Finland
FCC ID	QOQWT41E
Frequency Range	2402 ~ 2480 MHz
Modulation Type	GFSK for 1Mbps
Antenna Type	External Antenna
Antenna Gain	12 dBi

3 Test Methodology

3.1. Mode of Operation

Decision of Test ATL has verified the construction and function in typical operation. All the test modes were carried out with the EUT in normal operation, which was shown in this test report and defined as:

Test Mode
Mode 1: IDLE Mode
Mode 2: Normal Operation Mode
Mode 3: GFSK Link Mode

By preliminary testing and verifying three axis (X, Y and Z) position of EUT transmitted status, it was found that "X axis" position was the worst, then the final test was executed the worst condition and test data were recorded in this report.

Description of Test Modes

Preliminary tests were performed in different modulation to find the worst case. The modulation has shown the worst-case in section 6.5. Investigation has been done on all the possible configurations for searching the worst cases.

Tested System Details

The types for all equipments, plus descriptions of all cables used in the tested system (including inserted cards) are:

	Product	Manufacturer	Model Number	Serial Number	Power Cord
1.	Bluetooth Tester	R & S	CBT	100350	NA

3.2. EUT Exercise Software

1	Setup the EUT and Bluetooth Tester (CBT) as shown on 3.3.
2	Turn on the power of all equipment.
3	EUT run test program.
4	Open Bluetooth function link to CBT.

3.3. Configuration of Test System Details

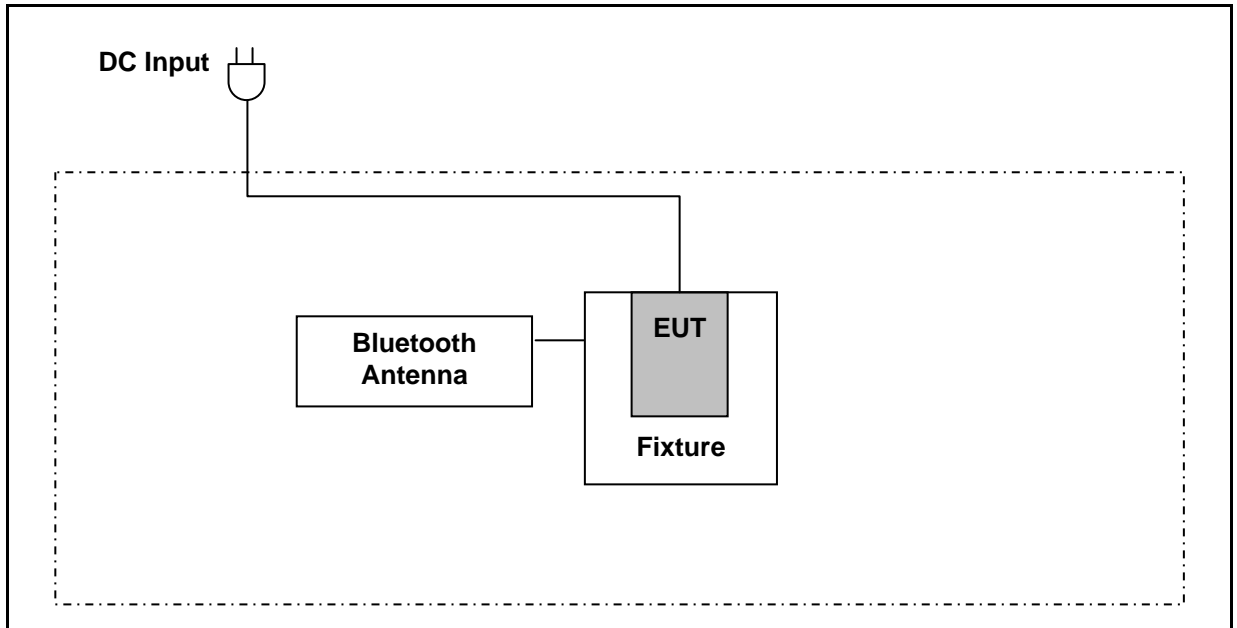

3.4. Test Site Environment

Items	Required (IEC 68-1)	Actual
Temperature (°C)	15-35	26
Humidity (%RH)	25-75	60
Barometric pressure (mbar)	860-1060	950

4 Radiated Interference Measurement

4.1. Limit

According to §15.209(a), except as provided elsewhere in this subpart, the emissions from an intentional radiator shall not exceed the field strength levels specified in the following table:

Frequency (MHz)	Field Strength ($\mu\text{V}/\text{m}$ at meter)	Measurement Distance (meters)
0.009 – 0.490	2400 / F (kHz)	300
0.490 – 1.705	24000 / F (kHz)	30
1.705 – 30.0	30	30
30 - 88	100**	3
88-216	150**	3
216-960	200**	3
Above 960	500	3

** Except as provided in paragraph (g), fundamental emissions from intentional radiators operating under this Section shall not be located in the frequency bands 54-72 MHz, 76-88 MHz, 174-216 MHz or 470-806 MHz. However, operation within these frequency bands is permitted under other sections of this Part, e.g., Sections 15.231 and 15.241.

4.2. Test Instruments

3 Meter Chamber					
Equipment	Manufacturer	Model Number	Serial Number	Cal. Date	Remark
RF Pre-selector	Agilent	N9039A	MY46520256	01/21/2013	(1)
Spectrum Analyzer	Agilent	E4446A	MY46180578	01/21/2013	(1)
Pre Amplifier	Agilent	8449B	3008A02237	02/21/2013	(1)
Pre Amplifier	Agilent	8447D	2944A10961	02/21/2013	(1)
Broadband Antenna (30MHz~1GHz)	SCHWARZBECK MESS-ELEKTRONIK	VULB9163	9163-270	07/01/2013	(1)
Horn Antenna (1~18GHz)	SCHWARZBECK MESS-ELEKTRONIK	BBHA9120D	9120D-550	06/10/2013	(1)
Horn Antenna (18~40GHz)	SCHWARZBECK MESS-ELEKTRONIK	BBHA9170	9170-320	06/13/2013	(1)
Loop Antenna	COM-POWER CORPORATION	AL-130	121014	08/14/2012	(2)
Test Site	ATL	TE01	888001	08/28/2013	(1)

Remark: (1) Calibration period 1 year. (2) Calibration period 2 years. (3) Calibration period 3 years.

NOTE: N.C.R. = No Calibration Request.

4.3. Setup

Below 1GHz

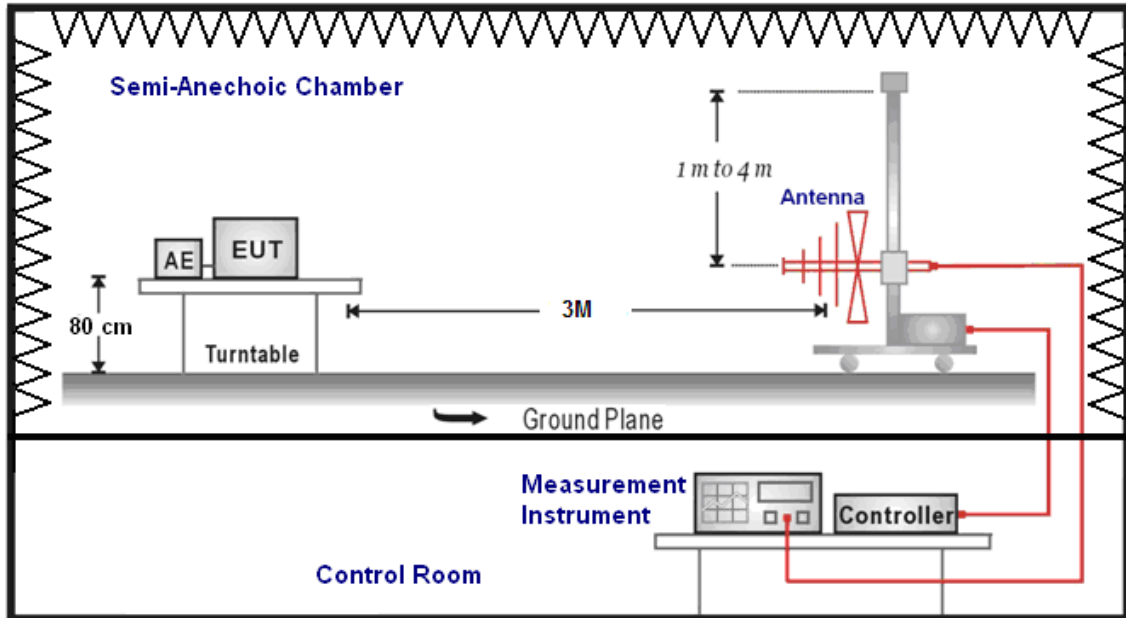

Above 1GHz

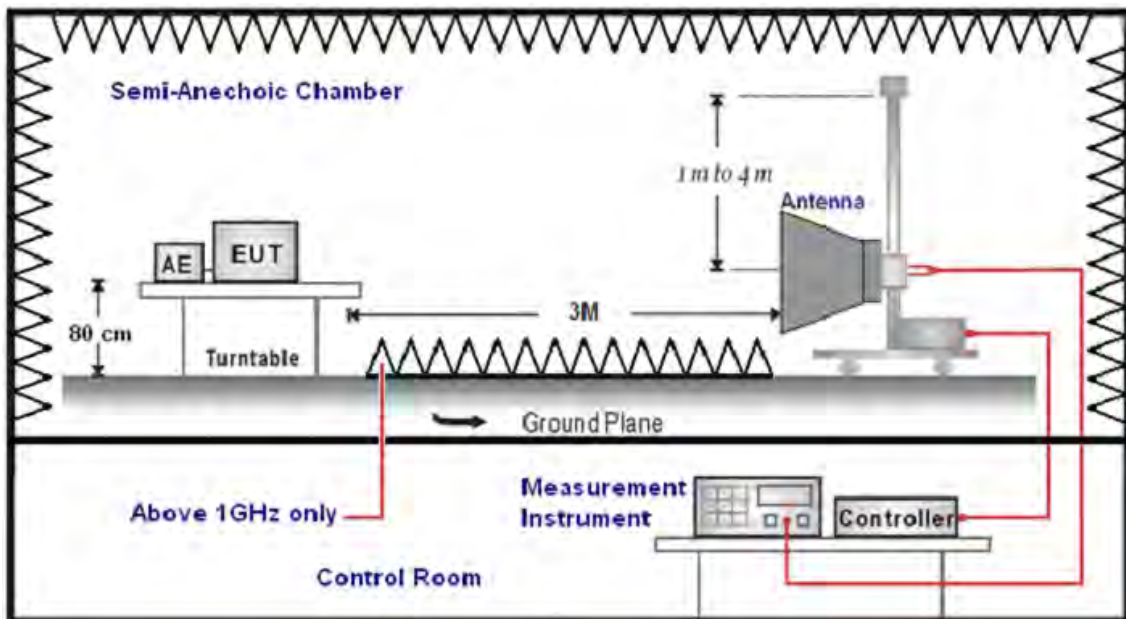

4.4. Test Procedure

Final radiation measurements were made on a three-meter, Semi Anechoic Chamber. The EUT system was placed on a nonconductive turntable which is 0.8 meters height, top surface 1.0 x 1.5 meter. The spectrum was examined from 250 MHz to 2.5 GHz in order to cover the whole spectrum below 10th harmonic which could generate from the EUT. During the test, EUT was set to transmit continuously & Measurements spectrum range from 9 kHz to 26.5 GHz is investigated.

For measurements below 1 GHz the resolution bandwidth is set to 100 kHz for peak detection measurements or 120 kHz for quasi-peak detection measurements. Peak detection is used unless otherwise noted as quasi-peak.

For measurements above 1 GHz the resolution bandwidth is set to 1 MHz, and then the video bandwidth is set to 1 MHz for peak measurements and 10 Hz for average measurements.

A nonconductive material surrounded the EUT to supporting the EUT for standing on three orthogonal planes. At each condition, the EUT was rotated 360 degrees, and the antenna was raised and lowered from one to four meters to find the maximum emission levels. Measurements were taken using both horizontal and vertical antenna polarization.

SCHWARZBECK MESS-ELEKTRONIK Biconilog Antenna (model VULB9163) at 3 Meter and the SCHWARZBECK Double Ridged Guide Antenna (model BBHA9120D&9170) was used in frequencies 1 – 26.5 GHz at a distance of 1 meter. All test results were extrapolated to equivalent signal at 3 meters utilizing an inverse linear distance extrapolation Factor (20dB/decade).

For testing above 1GHz, the emission level of the EUT in peak mode was 20dB lower than average limit (that means the emission level in peak mode also complies with the limit in average mode), then testing will be stopped and peak values of EUT will be reported, otherwise, the emissions will be measured in average mode again and reported.

Appropriate preamplifiers were used for improving sensitivity and precautions were taken to avoid overloading or desensitizing the spectrum analyzer. No post – detector video filters were used in the test.

The spectrum analyzer's 6 dB bandwidth was set to 1 MHz, and the analyzer was operated in the peak detection mode, for frequencies both below and up 1 GHz. The average levels were obtained by subtracting the duty cycle correction factor from the peak readings.

The following procedures were used to convert the emission levels measured in decibels referenced to 1 microvolt (dBuV) into field intensity in micro volts per meter (uV/m).

The actual field intensity in decibels referenced to 1 microvolt in to field intensity in micro volts per meter (dBuV/m).

The actual field intensity in decibels referenced to 1 microvolt per meter (dBuV/m) is determined by algebraically adding the measured reading in dBuV, the antenna factor (dB), and cable loss (dB) and Subtracting the gain of preamplifier (dB) is auto calculate in spectrum analyzer.

$$(1) \text{ Amplitude (dBuV/m) = FI (dBuV) +AF (dBuV) +CL (dBuV)-Gain (dB)}$$

FI= Reading of the field intensity.

AF= Antenna factor.

CL= Cable loss.

P.S Amplitude is auto calculate in spectrum analyzer.

$$(2) \text{ Actual Amplitude (dBuV/m) = Amplitude (dBuV)-Dis(dB)}$$

The FCC specified emission limits were calculated according the EUT operating frequency and by following linear interpolation equations:

(a) For fundamental frequency : Transmitter Output < +30dBm

(b) For spurious frequency : Spurious emission limits = fundamental emission limit /10

Data of measurement within this frequency range without mark in the table above means the reading of emissions are attenuated more than 20dB below the permissible limits or the field strength is too small to be measured.

4.5. Test Result

Below 1GHz

Standard:	FCC Part 15C	Test Distance:	3m
Test item:	Radiated Emission	Power:	AC 120V/60Hz
Model Number:	WT41-E	Temp.(°C)/Hum.(%RH):	26(°C)/60%RH
Mode:	Mode 2	Date:	11/26/2013
		Test By:	Eric Ou Yang

Frequency (MHz)	Reading (dBuV)	Correct Factor (dB/m)	Result (dBuV/m)	Limit (dBuV/m)	Margin (dB)	Remark	Ant.Polar. H / V
35.5000	45.68	-13.25	32.43	40.00	-7.57	QP	H
111.5000	51.23	-14.61	36.62	43.50	-6.88	QP	H
272.0000	43.81	-11.48	32.33	46.00	-13.67	QP	H
350.0000	43.34	-8.80	34.54	46.00	-11.46	QP	H
450.0000	43.22	-7.91	35.31	46.00	-10.69	QP	H
750.0000	36.32	-2.46	33.86	46.00	-12.14	QP	H
33.5000	43.66	-13.59	30.07	40.00	-9.93	QP	V
48.0000	47.27	-11.94	35.33	40.00	-4.67	QP	V
61.0000	48.83	-13.24	35.59	40.00	-4.41	QP	V
90.0000	51.02	-16.03	34.99	43.50	-8.51	QP	V
450.0000	38.93	-7.91	31.02	46.00	-14.98	QP	V
750.0000	33.77	-2.46	31.31	46.00	-14.69	QP	V

Note: No emission found between lowest internal used/generated frequencies to 30MHz (9 kHz~30MHz).

Above 1GHz

Standard:	FCC Part 15C	Test Distance:	3m
Test item:	Radiated Emission	Power:	AC 120V/60Hz
Model Number:	WT41-E	Temp.(°C)/Hum.(%RH):	26(°C)/60%RH
Mode:	Mode 3	Date:	11/26/2013
Frequency:	2402 MHz	Test By:	Eric Ou Yang

Frequency (MHz)	Reading (dBuV)	Correct Factor (dB/m)	Result (dBuV/m)	Limit (dBuV/m)	Margin (dB)	Remark	Ant.Polar. H / V
2918.000	36.40	5.70	42.10	74.00	-31.90	peak	H
4570.000	33.72	11.06	44.78	74.00	-29.22	peak	H
6495.000	33.52	17.39	50.91	74.00	-23.09	peak	H
3051.000	36.50	6.02	42.52	74.00	-31.48	peak	V
4804.000	37.44	11.66	49.10	74.00	-24.90	peak	V
6474.000	33.16	17.34	50.50	74.00	-23.50	peak	V

Standard:	FCC Part 15C	Test Distance:	3m
Test item:	Radiated Emission	Power:	AC 120V/60Hz
Model Number:	WT41-E	Temp.(°C)/Hum.(%RH):	26(°C)/60%RH
Mode:	Mode 3	Date:	11/26/2013
Frequency:	2441 MHz	Test By:	Eric Ou Yang

Frequency (MHz)	Reading (dBuV)	Correct Factor (dB/m)	Result (dBuV/m)	Limit (dBuV/m)	Margin (dB)	Remark	Ant.Polar. H / V
3037.000	37.51	5.99	43.50	74.00	-30.50	peak	H
4577.000	35.28	11.07	46.35	74.00	-27.65	peak	H
6439.000	32.63	17.22	49.85	74.00	-24.15	peak	H
2995.000	37.38	5.90	43.28	74.00	-30.72	peak	V
4626.000	33.68	11.20	44.88	74.00	-29.12	peak	V
6481.000	33.49	17.35	50.84	74.00	-23.16	peak	V

Standard:	FCC Part 15C	Test Distance:	3m
Test item:	Radiated Emission	Power:	AC 120V/60Hz
Model Number:	WT41-E	Temp.(°C)/Hum.(%RH):	26(°C)/60%RH
Mode:	Mode 3	Date:	11/26/2013
Frequency:	2480 MHz	Test By:	Eric Ou Yang

Frequency (MHz)	Reading (dBuV)	Correct Factor (dB/m)	Result (dBuV/m)	Limit (dBuV/m)	Margin (dB)	Remark	Ant.Polar. H / V
2967.000	36.49	5.82	42.31	74.00	-31.69	peak	H
4577.000	35.69	11.07	46.76	74.00	-27.24	peak	H
6439.000	33.71	17.22	50.93	74.00	-23.07	peak	H
2967.000	36.01	5.82	41.83	74.00	-32.17	peak	V
4619.000	35.29	11.19	46.48	74.00	-27.52	peak	V
6425.000	33.13	17.18	50.31	74.00	-23.69	peak	V

5 Band Edges Measurement

5.1. Limit

In any 100 kHz bandwidth outside the frequency band in which the spread spectrum or digitally modulated intentional radiator is operating, the radio frequency power that is produced by the intentional radiator shall be at least 20 dB below that in the 100 kHz bandwidth within the band that contains the highest level of the desired power

5.2. Test Setup

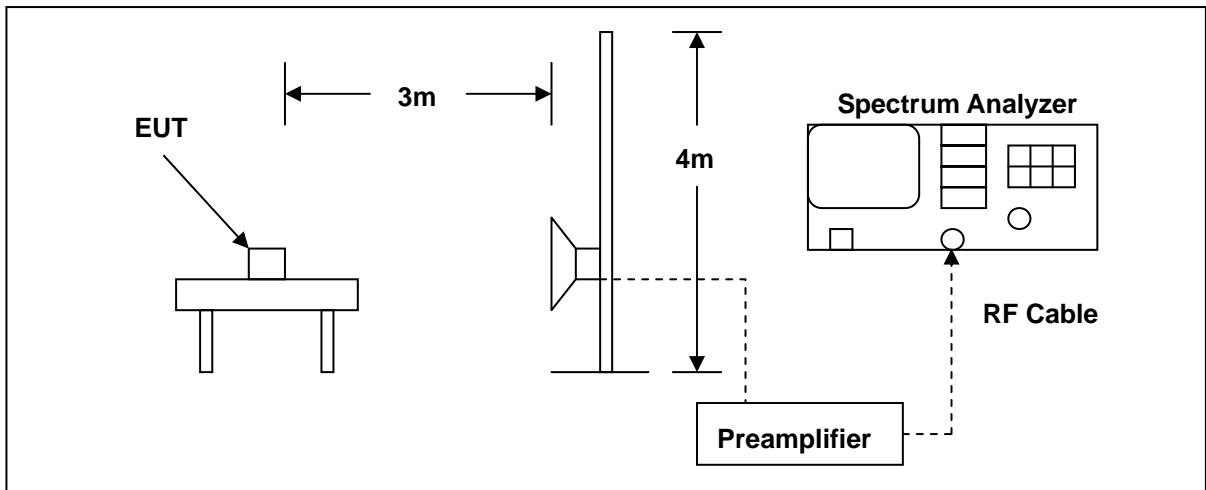

5.3. Test Instruments

Equipment	Manufacturer	Model Number	Serial Number	Cal. Date	Remark
Spectrum Analyzer	Agilent	E4408B	MY45107753	07/11/2013	(1)
Pre Amplifier	Agilent	8449B	3008A02237	02/21/2013	(1)
Horn Antenna	SCHWARZBECK MESS-ELEKTRONIK	9120D	9120D-550	06/10/2013	(1)
Test Site	ATL	TE01	888001	08/28/2013	(1)

Remark: (1) Calibration period 1 year. (2) Calibration period 2 years.

NOTE: N.C.R. = No Calibration Request.

5.4. Test Procedure

Testing must be done according to this procedure, FCC Public Notice DA 00-705 - Filing and Measurement Guidelines for Frequency Hopping Spread Spectrum Systems. This is the only method recognized by the FCC. The emissions on the harmonics frequencies, the limits, and the margin of compliance are presented. These tests were made when the transmitter was in full radiated power. The additional test was performed to show compliance with the requirement at the band-edge frequency 2483.5 MHz and up to 2500 MHz and at 2390.0 MHz.

The transmitter was configured with the worst case antenna and setup to transmit at the highest channel. Then the field strength was measured at 2483.5 MHz.

The transmitter was then configured with the worst case antenna and setup to transmit at the lowest channel. Then the field strength was measured at 2390.0 MHz. These tests were performed at 4 different bit rates.

For measurements the resolution bandwidth is set to 1 MHz, and then the video bandwidth is set to 1 MHz for peak measurements and 10 Hz for average measurements.

5.5. Test Result

Standard:	FCC Part 15C	Test Distance:	3m
Test item:	Radiated Emission	Power:	AC 120V/60Hz
Model Number:	WT41-E	Temp.(°C)/Hum.(%RH):	26(°C)/60%RH
Mode:	Mode 3	Date:	11/26/2013
Frequency:	2402 MHz	Test By:	Eric Ou Yang
Ant.Polar.:	Horizontal		

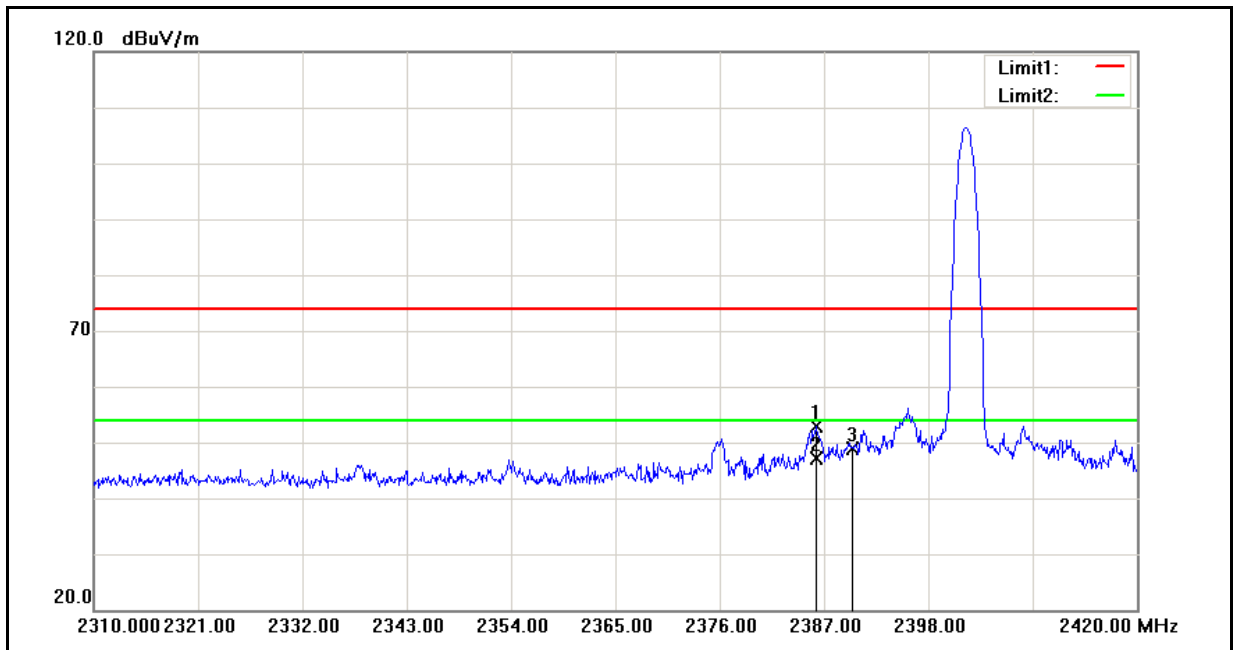

No.	Frequency (MHz)	Reading (dBuV)	Correct Factor (dB/m)	Result (dBuV/m)	Limit (dBuV/m)	Margin (dB)	Remark
1	2386.230	49.06	3.85	52.91	74.00	-21.09	peak
2	2386.230	43.32	3.85	47.17	54.00	-6.83	AVG
3	2390.000	45.11	3.88	48.99	74.00	-25.01	peak

Standard:	FCC Part 15C	Test Distance:	3m
Test item:	Radiated Emission	Power:	AC 120V/60Hz
Model Number:	WT41-E	Temp.(°C)/Hum.(%RH):	26(°C)/60%RH
Mode:	Mode 3	Date:	11/26/2013
Frequency:	2402 MHz	Test By:	Eric Ou Yang
Ant.Polar.:	Vertical		

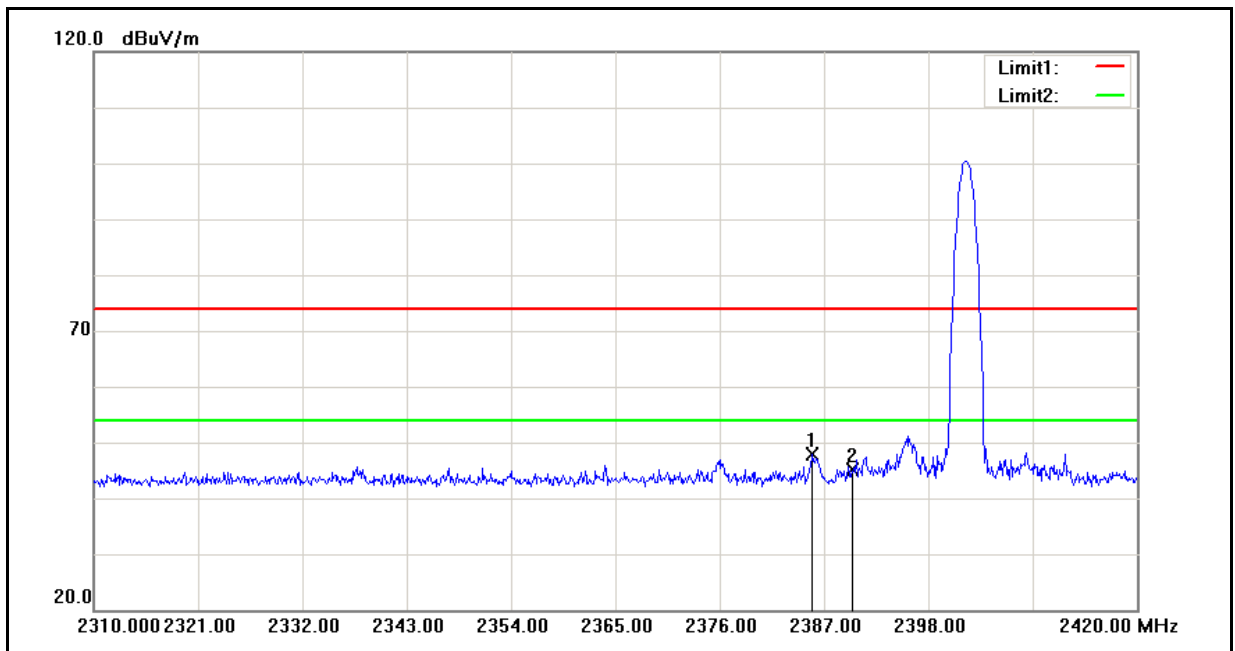

No.	Frequency (MHz)	Reading (dBuV)	Correct Factor (dB/m)	Result (dBuV/m)	Limit (dBuV/m)	Margin (dB)	Remark
1	2385.790	44.09	3.85	47.94	74.00	-26.06	peak
2	2390.000	41.21	3.88	45.09	74.00	-28.91	peak

Standard:	FCC Part 15C	Test Distance:	3m
Test item:	Radiated Emission	Power:	AC 120V/60Hz
Model Number:	WT41-E	Temp.(°C)/Hum.(%RH):	26(°C)/60%RH
Mode:	Mode 3	Date:	11/26/2013
Frequency:	2480 MHz	Test By:	Eric Ou Yang
Ant.Polar.:	Horizontal		

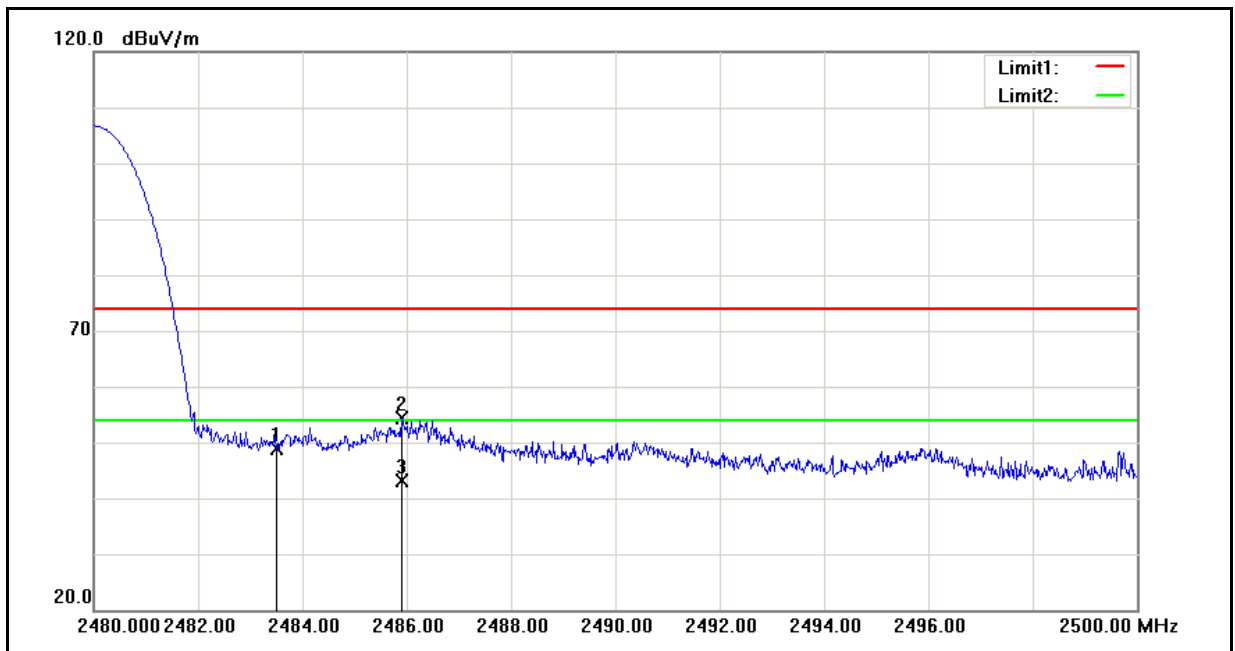

No.	Frequency (MHz)	Reading (dBuV)	Correct Factor (dB/m)	Result (dBuV/m)	Limit (dBuV/m)	Margin (dB)	Remark
1	2483.500	44.36	4.50	48.86	74.00	-25.14	peak
2	2485.900	49.82	4.52	54.34	74.00	-19.66	peak
3	2485.900	38.57	4.52	43.09	54.00	-10.91	AVG

Standard:	FCC Part 15C	Test Distance:	3m
Test item:	Radiated Emission	Power:	AC 120V/60Hz
Model Number:	WT41-E	Temp.(°C)/Hum.(%RH):	26(°C)/60%RH
Mode:	Mode 3	Date:	11/26/2013
Frequency:	2480 MHz	Test By:	Eric Ou Yang
Ant.Polar.:	Vertical		

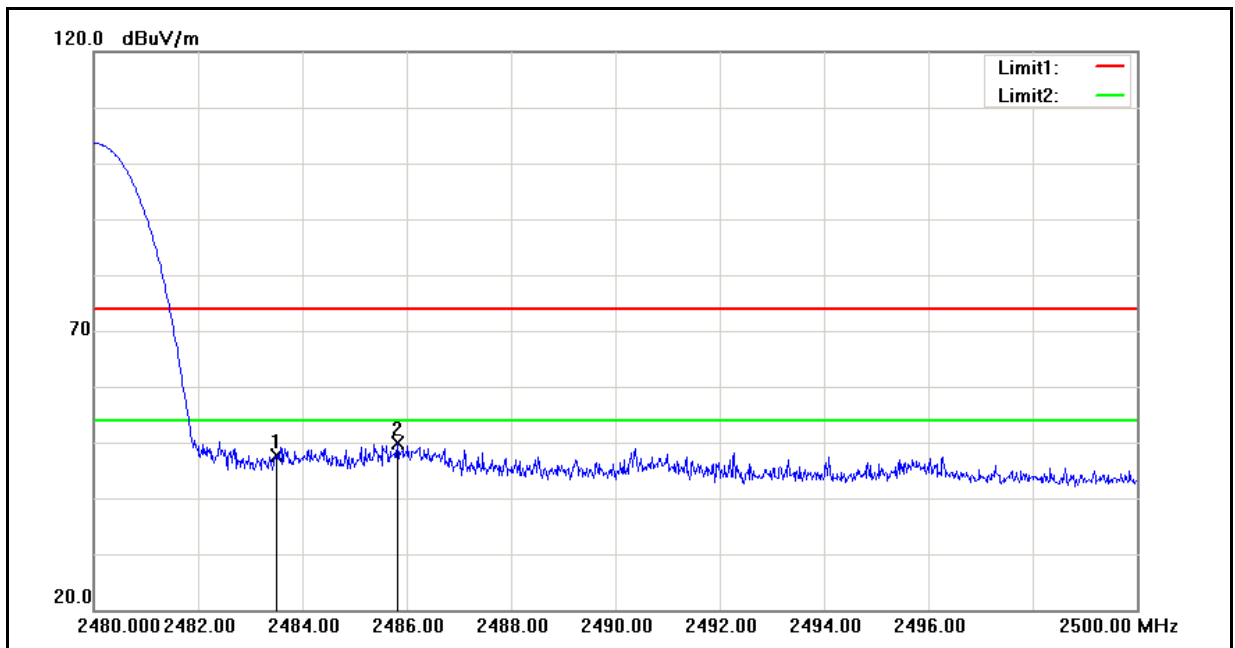

No.	Frequency (MHz)	Reading (dBuV)	Correct Factor (dB/m)	Result (dBuV/m)	Limit (dBuV/m)	Margin (dB)	Remark
1	2483.500	43.16	4.50	47.66	74.00	-26.34	peak
2	2485.820	45.31	4.52	49.83	74.00	-24.17	peak

6 Antenna Measurement

6.1. Limit

For intentional device, according to 15.203, an intentional radiator shall be designed to ensure that no antenna other than that furnished by the responsible party shall be used with the device.

And According to 15.247 (b), if transmitting antennas of directional gain greater than 6 dBi are used, the power shall be reduced by the amount in dB that the directional gain of the antenna exceeds 6dBi.

6.2. Antenna Connector Construction

The antenna used in this product is External Antenna. And the maximum Gain of this antenna is 12 dBi.