

Report on the Radio Testing
For
Silicon Laboratories Finland Oy
on
MGM210L / BGM210L
Report no. TRA-043305-45-03B
7 March 2019

RF915 6.0



Report Number: TRA-043305-45-03B
Issue: B

REPORT ON THE RADIO TESTING OF A
Silicon Laboratories Finland Oy
MGM210L / BGM210L
WITH RESPECT TO SPECIFICATION
FCC 47CFR 15.247

TEST DATE: 2019-01-15 to 2019-03-04

Written by:

A Longley
Radio Test Engineer

Approved by:

J Charters
Department Manager - Radio

Date: 7 March 2019

Disclaimers:

[1] THIS DOCUMENT MAY BE REPRODUCED ONLY IN ITS ENTIRETY AND WITHOUT CHANGE
[2] THE RESULTS CONTAINED IN THIS DOCUMENT RELATE ONLY TO THE ITEM(S) TESTED

1 Revision Record

<i>Issue Number</i>	<i>Issue Date</i>	<i>Revision History</i>
A	7 March 2019	Original

2 Summary

TEST REPORT NUMBER: TRA-043305-45-03B

WORKS ORDER NUMBER: TRA-043305-03

PURPOSE OF TEST: USA: Testing of radio frequency equipment per the relevant authorization procedure of chapter 47 of CFR (code of federal regulations) Part 2, subpart J.

TEST SPECIFICATION(S): 47CFR15.247

EQUIPMENT UNDER TEST (EUT): MGM210L / BGM210L

FCC IDENTIFIER: QOQMGM210L

EUT SERIAL NUMBER: not available

MANUFACTURER/AGENT: Silicon Laboratories Finland Oy

ADDRESS: Alberga Business Park
Bertel Jungin aukio 3
02600 ESPO
Finland

CLIENT CONTACT: Pasi Rahikkala
☎ 0407047953
✉ pasi.rahikkala@silabs.com

ORDER NUMBER: 6000335364

TEST DATE: 2019-01-15 to 2019-03-04

TESTED BY: A Longley
Element

2.1 Test Summary

Test Method and Description		Requirement Clause	Applicable to this equipment	Result / Note
		47CFR15		
Radiated spurious emissions (restricted bands of operation and cabinet radiation)		15.205	<input checked="" type="checkbox"/>	Pass
AC power line conducted emissions		15.207	<input checked="" type="checkbox"/>	Pass
Occupied bandwidth		15.247(a)(2)	<input checked="" type="checkbox"/>	Pass
Conducted carrier power	Peak	15.247(b)(3)	<input checked="" type="checkbox"/>	Pass
	Max.		<input type="checkbox"/>	
Conducted / radiated RF power out-of-band		15.247(d)	<input checked="" type="checkbox"/>	Pass
Power spectral density, conducted		15.247(e)	<input checked="" type="checkbox"/>	Pass
Calculation of duty correction		15.35(c)	<input type="checkbox"/>	N/A

Notes:

The results contained in this report relate only to the items tested, in the condition at time of test, and were obtained in the period between the date of initial receipt of samples and the date of issue of the report.

The apparatus was set up and exercised using the configurations, modes of operation and arrangements defined in this report only. Any modifications made are identified in Section 8 of this report.

Particular operating modes, apparatus monitoring methods and performance criteria required by the standards tested to have been performed except where identified in Section 5.2 of this test report (Deviations from Test Standards).

3 Contents

1	Revision Record.....	3
2	Summary.....	4
2.1	Test Summary.....	5
3	Contents.....	6
4	Introduction.....	8
5	Test Specifications.....	9
5.1	Normative References.....	9
5.2	Deviations from Test Standards.....	9
6	Glossary of Terms.....	10
7	Equipment Under Test.....	11
7.1	EUT Identification.....	11
7.2	System Equipment.....	11
7.3	EUT Mode of Operation.....	11
7.3.1	Transmission.....	11
7.4	EUT Radio Parameters.....	12
7.4.1	General.....	12
7.4.2	Antennas.....	12
7.4.3	Product specific declarations.....	13
7.5	EUT Description.....	13
8	Modifications.....	14
9	EUT Test Setup.....	15
9.1	Block Diagram.....	15
9.2	General Set-up Photograph.....	16
10	General Technical Parameters.....	17
10.1	Normal Conditions.....	17
10.2	Varying Test Conditions.....	17
11	Radiated emissions.....	18
11.1	Definitions.....	18
11.2	Test Parameters.....	18
11.3	Test Limit.....	18
11.4	Test Method.....	19
11.5	Test Set-up Photograph.....	20
11.6	Test Equipment.....	21
11.7	Test Results.....	22
12	AC power-line conducted emissions.....	70
12.1	Definition.....	70
12.2	Test Parameters.....	70
12.3	Test Limit.....	70
12.4	Test Method.....	70
12.5	Test Set-up Photograph.....	71
12.6	Test Equipment.....	71
12.7	Test Results.....	72
13	Occupied Bandwidth.....	73
13.1	Definition.....	73
13.2	Test Parameters.....	73
13.3	Test Limit.....	73
13.4	Test Method.....	74
13.5	Test Equipment.....	74
13.6	Test Results.....	75
14	Maximum peak conducted output power.....	91
14.1	Definition.....	91
14.2	Test Parameters.....	91
14.3	Test Limit.....	91
14.4	Test Method.....	92
14.5	Test Equipment.....	92
14.6	Test Results.....	93
15	Out-of-band and conducted spurious emissions.....	95
15.1	Definition.....	95
15.2	Test Parameters.....	95
15.3	Test Limit.....	95
15.4	Test Method.....	96
15.5	Test Equipment.....	96
15.6	Test Results.....	97

16	Power spectral density	121
16.1	Definition	121
16.2	Test Parameters.....	121
16.3	Test Limit	121
16.4	Test Method	122
16.5	Test Equipment.....	122
16.6	Test Results	123
17	Measurement Uncertainty.....	139
18	RF Exposure	140

4 Introduction

This report TRA-043305-45-03B presents the results of the Radio testing on a Silicon Laboratories Finland Oy, MGM210L / BGM210L to specification 47CFR15 Radio Frequency Devices.

The testing was carried out for Silicon Laboratories Finland Oy by Element, at the address detailed below.

- | | |
|---|--|
| <input checked="" type="checkbox"/> Element Hull
Unit E
South Orbital Trading Park
Hedon Road
Hull
HU9 1NJ
UK | <input type="checkbox"/> Element Skelmersdale
Unit 1
Pendle Place
Skemersdale
West Lancashire
WN8 9PN
UK |
|---|--|

This report details the configuration of the equipment, the test methods used and any relevant modifications where appropriate.

All test and measurement equipment under the control of the laboratory and requiring calibration is subject to an established programme and procedures to control and maintain measurement standards. The quality management system meets the principles of ISO 9001, and has quality control procedures for monitoring the validity of tests undertaken. Records and sufficient detail are retained to establish an audit trail of calibration records relating to its test results for a defined period. Under control of the established calibration programme, key quantities or values of the test & measurement instrumentation are within specification and comply with the relevant traceable internationally recognised and appropriate standard specifications, which are UKAS calibrated as such where these properties have a significant effect on results. Participation in inter-laboratory comparisons and proficiency testing ensures satisfactory correlation of results conform to Elements own procedures, as well as statistical techniques for analysis of test data providing the appropriate confidence in measurements.

Throughout this report EUT denotes equipment under test.

FCC Site Listing:

Element is accredited for the above sites under the US-EU MRA, Designation number UK0009.

The test site requirements of ANSI C63.4-2014 are met up to 1GHz.

The test site SVSWR requirements of CISPR 16-1-4:2010 are met over the frequency range 1 GHz to 18 GHz.

5 Test Specifications

5.1 Normative References

- FCC 47 CFR Ch. I – Part 15 – Radio Frequency Devices.
- ANSI C63.10-2013 – American National Standard of Procedures for Compliance Testing of Unlicensed Wireless Devices.
- ANSI C63.4-2014 – American National Standard for Methods of Measurement of Radio-Noise Emissions from Low-Voltage Electrical and Electronic Equipment in the Range of 9 kHz to 40 GHz.

5.2 Deviations from Test Standards

There were no deviations from the test standard.

6 Glossary of Terms

§	denotes a section reference from the standard, not this document
AC	Alternating Current
ANSI	American National Standards Institute
BW	bandwidth
C	Celsius
CFR	Code of Federal Regulations
CW	Continuous Wave
dB	decibel
dBm	dB relative to 1 milliwatt
DC	Direct Current
DSSS	Direct Sequence Spread Spectrum
EIRP	Equivalent Isotropically Radiated Power
ERP	Effective Radiated Power
EUT	Equipment Under Test
FCC	Federal Communications Commission
FHSS	Frequency Hopping Spread Spectrum
Hz	hertz
IC	Industry Canada
ITU	International Telecommunication Union
LBT	Listen Before Talk
m	metre
max	maximum
MIMO	Multiple Input and Multiple Output
min	minimum
MRA	Mutual Recognition Agreement
N/A	Not Applicable
PCB	Printed Circuit Board
PDF	Portable Document Format
Pt-mpt	Point-to-multipoint
Pt-pt	Point-to-point
RF	Radio Frequency
RH	Relative Humidity
RMS	Root Mean Square
Rx	receiver
s	second
SVSWR	Site Voltage Standing Wave Ratio
Tx	transmitter
UKAS	United Kingdom Accreditation Service
V	volt
W	watt
Ω	ohm

7 Equipment Under Test

7.1 EUT Identification

- Name: MGM210L / BGM210L
- Serial Number: not available
- Model Number: MGM210L and BGM210L
- Software Revision: 2.11.x
- Build Level / Revision Number: 1.0

The MGM210L model supports both Zigbee and Bluetooth communications.

The BGM210L model supports Bluetooth only (the Zigbee functions are disabled in software, the hardware is identical for both models).

7.2 System Equipment

Equipment listed below forms part of the overall test setup and is required for equipment functionality and/or monitoring during testing. The compliance levels achieved in this report relate only to the EUT and not items given in the following list.

Interface Module (PCB4001 Rev A03)
Laptop

7.3 EUT Mode of Operation

7.3.1 Transmission

The mode of operation for transmitter tests was a transmitting modulated carrier on the frequencies indicated.

The Bluetooth supports Adaptive modes, depending on the circumstances it can be either DTS or DSS. It has a variable power operation, when there are less than 15 channels in use the Bluetooth will go into DTS mode with transmit power limited to 10 dBm (power setting 100) and when there are more than 15 channels in use the Bluetooth will go into DSS mode with 13 dBm of transmit power (power setting 126).

7.4 EUT Radio Parameters

7.4.1 General

Frequency of operation:	2402 MHz to 2480 MHz
Modulation type(s):	GFSK
Occupied channel bandwidth(s):	1.1 MHz (1M, 125k, 500k) 2.2 MHz (2M)
Channel spacing:	2 MHz
ITU emission designator(s):	2M15F1D--
Declared output power(s):	12 dBm EIRP
Warning against use of alternative antennas in user manual (yes/no):	N/A
Nominal Supply Voltage:	3.3 Vdc
Location of notice for license exempt use:	Label / user manual / both.
Method of prevention of use on non-US / non-Canadian frequencies:	Unknown
Duty cycle:	85% (1M) 56% (2M) 97% (125k & 500k)

7.4.2 Antennas

Type:	Integral
Frequency range:	2402 MHz to 2480 MHz
Gain:	0.5 dBi
Polarisation:	Linear
Connector type:	N/A
Mounting:	PCB track antenna

7.4.3 Product specific declarations

Multiple antenna configuration(s), e.g. MIMO:	None
Fixed pt-pt operations (yes/no):	No
Installation manual advice on pt-pt operational restrictions (yes/no):	No
Fixed pt-mpt operations (yes/no):	No

7.5 EUT Description

The EUT is a plug in Zigbee and Bluetooth module for use with a variety of host systems. This report covers the Bluetooth functions only, for Zigbee functions see test report TRA-043305-45-00B.

8 Modifications

No modifications were performed during this assessment.

9 EUT Test Setup

9.1 Block Diagram

The following diagram shows basic EUT interconnections:

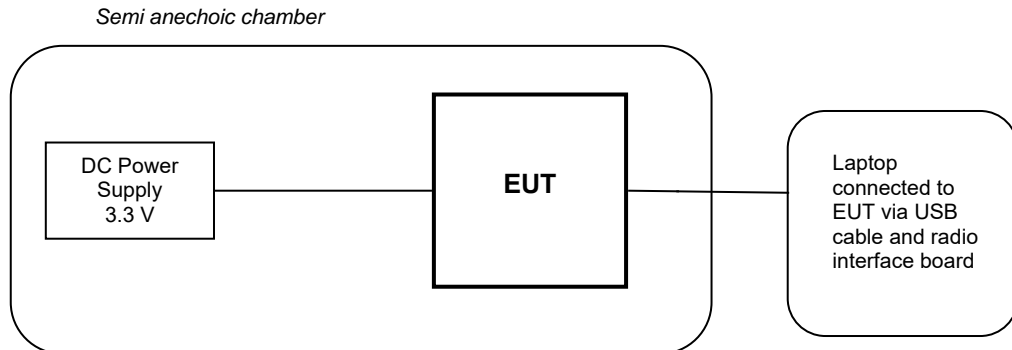

9.2 General Set-up Photograph

The following photograph shows basic EUT set-up:

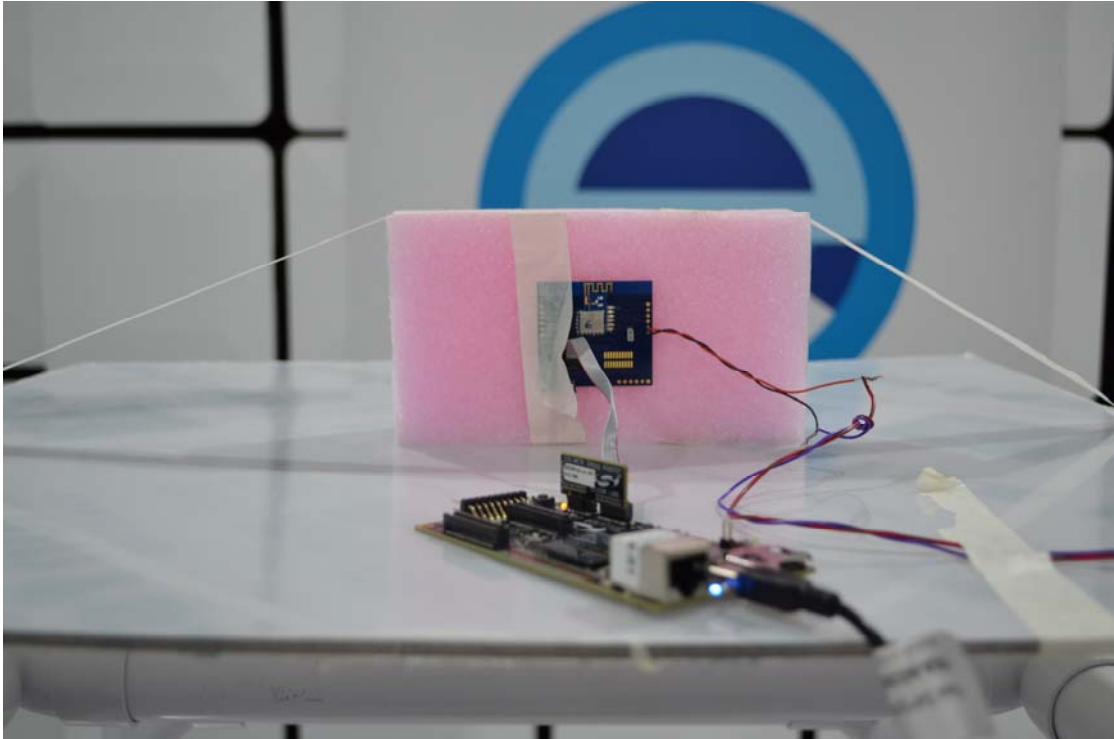

10 General Technical Parameters

10.1 Normal Conditions

The E U T was tested under the normal environmental conditions of the test laboratory, except where otherwise stated. The normal power source applied was 3.3 V dc.

10.2 Varying Test Conditions

There are no specific frequency stability requirements for the type of device. The results contained in this report demonstrate that the occupied bandwidth is contained within the authorised band and the manufacturer has declared sufficient frequency stability (refer to section 7.4).

Variation of supply voltage is required to ensure stability of the declared output power. During carrier power testing the following variations were made:

	Category	Nominal	Variation
<input type="checkbox"/>	Mains	110 V ac +/-2 %	85 % and 115 %
<input type="checkbox"/>	Battery	New battery	N/A
<input checked="" type="checkbox"/>	DC power	3.3 V dc	N/A

11 Radiated emissions

11.1 Definitions

Spurious emissions

Emissions on a frequency or frequencies, which are outside the necessary bandwidth and the level of which may be reduced without affecting the corresponding transmission of information. Spurious emissions include harmonic emissions, parasitic emissions, intermodulation products and frequency conversion products, but exclude out-of-band emissions.

Restricted bands

A frequency band in which intentional radiators are permitted to radiate only spurious emissions but not fundamental signals.

11.2 Test Parameters

Test Location:	Element Hull
Test Chamber:	Wireless Lab 3
Test Standard and Clause:	ANSI C63.10-2013, Clause 6.5 and 6.6
EUT Frequencies Measured:	2402 MHz / 2440 MHz / 2480 MHz
EUT Channel Bandwidths:	1 MHz
Deviations From Standard:	None
Measurement BW:	30 MHz to 1 GHz: 120 kHz Above 1 GHz: 1 MHz
Measurement Detector:	Up to 1 GHz: quasi-peak Above 1 GHz: RMS average and Peak

Environmental Conditions (Normal Environment)

Temperature: 20 °C	+15 °C to +35 °C (as declared)
Humidity: 45 % RH	20 % RH to 75 % RH (as declared)
Supply: 3.3 V dc	

11.3 Test Limit

Unwanted emissions that fall within the restricted frequency bands shall comply with the limits specified:

General Field Strength Limits for License-Exempt Transmitters at Frequencies above 30 MHz

Frequency (MHz)	Field Strength ($\mu\text{V/m}$ at 3 m)
30 to 88	100
88 to 216	150
216 to 960	200
Above 960	500

11.4 Test Method

With the EUT setup as per section 9 of this report and connected as per Figure i, the emissions from the EUT were measured on a spectrum analyzer / EMI receiver.

Radiated electromagnetic emissions from the EUT are checked first by preview scans. Preview scans for all spectrum and modulation characteristics are checked, using a peak detector and where applicable worst-case determined for function, operation, orientation, etc. for both vertical and horizontal polarisations. Pre-scan plots are shown with a peak detector and 100 kHz RBW.

If the EUT connects to auxiliary equipment and is table or floor standing, the configurations prescribed in ANSI C63.10 are followed. Alternatively, a layout closest to normal use (as declared by the provider) is employed, (see EUT setup photographs for more detail).

Emissions between 30 MHz and 1 GHz are measured using calibrated broadband antennas. Emissions above 1 GHz are characterized using standard gain horn antennas. Pre-amplifiers and filters are used where required. Care is taken to ensure that test receiver resolution bandwidth, video bandwidth and detector type(s) meet the regulatory requirements.

For both horizontal and vertical polarizations, the EUT is then rotated through 360 degrees in azimuth until the highest emission is detected. At the previously determined azimuth the test antenna is raised and lowered from 1 to 4 m in height until a maximum emission level is detected, this maximum value is recorded.

Power values measured on the test receiver / analyzer are converted to field strength, FS, in dB μ V/m at the regulatory distance, using:

$$FS = PR + CL + AF - PA + DC - CF$$

Where,

PR is the power recorded on the receiver / spectrum analyzer in dB μ V;

CL is the cable loss in dB;

AF is the test antenna factor in dB/m;

PA is the pre-amplifier gain in dB (where used);

DC is the duty correction factor in dB (where used, e.g. harmonics of pulsed fundamental);

CF is the distance factor in dB (where measurement distance different to limit distance);

This field strength value is then compared with the regulatory limit.

Figure i Test Setup

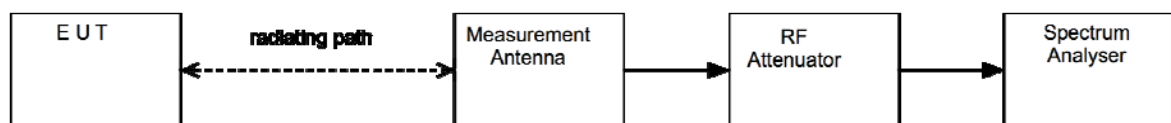

11.5 Test Set-up Photograph

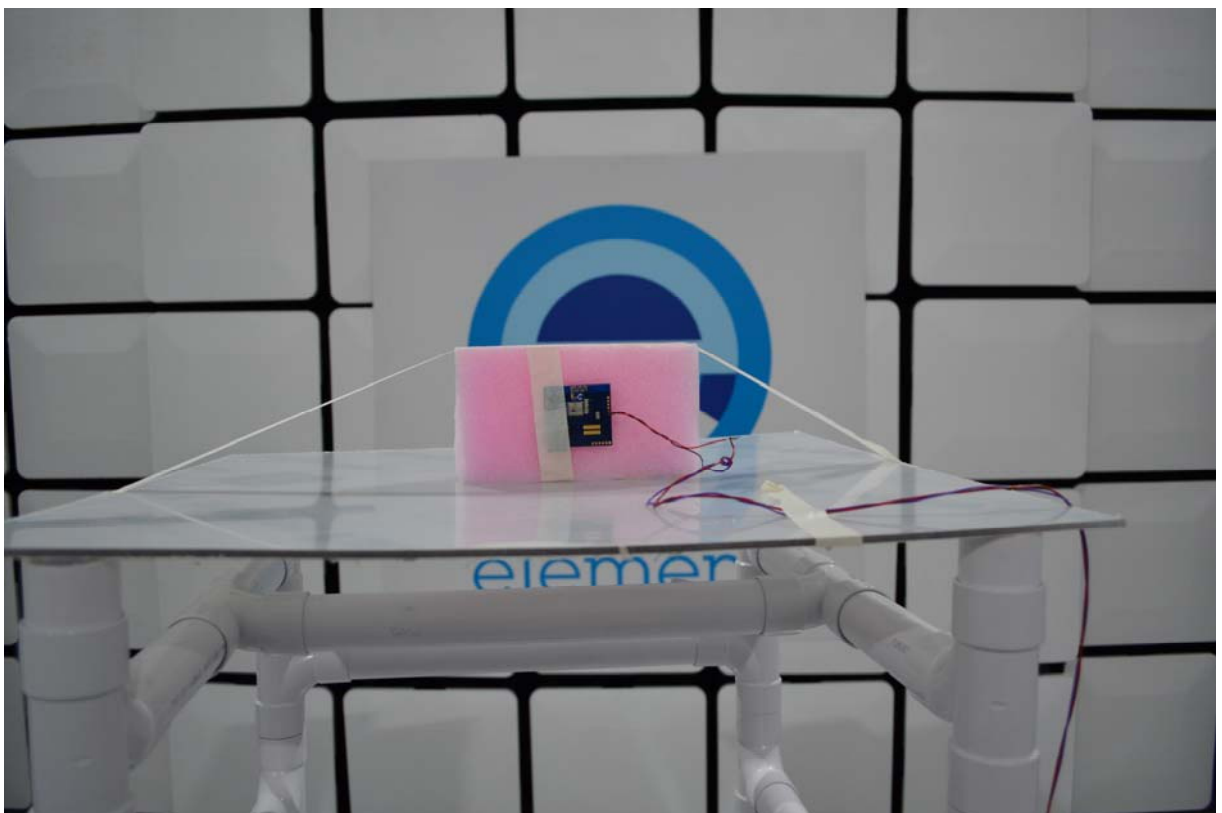

11.6 Test Equipment

Equipment Type	Manufacturer	Equipment Description	Element No	Due For Calibration
Ferrite Lined Chamber	Rainford	Chamber	REF2259	2020-08-03
EMI Test Receiver	R&S	ESW26	REF2235	2019-07-23
Bilog Antenna	Chase	CBL6111B	REF2218	2019-11-06
Horn Antenna	A Info Inc	LB-10180-NF	REF2241	2020-07-13
Horn Antenna	A Info Inc	LB-90-25-C2-SF	REF2243	2020-07-16
Horn Antenna	A Info Inc	LB-62-25-C-SF	REF2244	2020-07-16
Horn Antenna	A Info Inc	LB-180400-25-C-KF	REF2246	2020-07-25

11.7 Test Results

Power Setting: 126; Frequency: 2402 MHz; 1 Mbps								
Detector	Freq. (MHz)	Meas'd Emission (dBμV)	Factor (dB)	Duty Cycle Corr'n (dB)	Distance Extrap'n Factor (dB)	Field Strength (dBμV/m)	Field Strength (μV/m)	Limit (μV/m)
Average	2363.5	47.9	-3.5	0	0	44.4	166.0	500
Peak	2363.5	55.0	-3.5	0	0	51.5	375.8	5000
Average	4804.0	37.7	2.6	0	0	40.3	103.5	500
Peak	4804.4	47.6	2.6	0	0	50.2	323.6	5000
Average	12008.8	37.9	2.0	0	0	39.9	98.9	500
Peak	12008.6	51.5	2.0	0	0	53.5	473.2	5000

30 MHz to 1 GHz

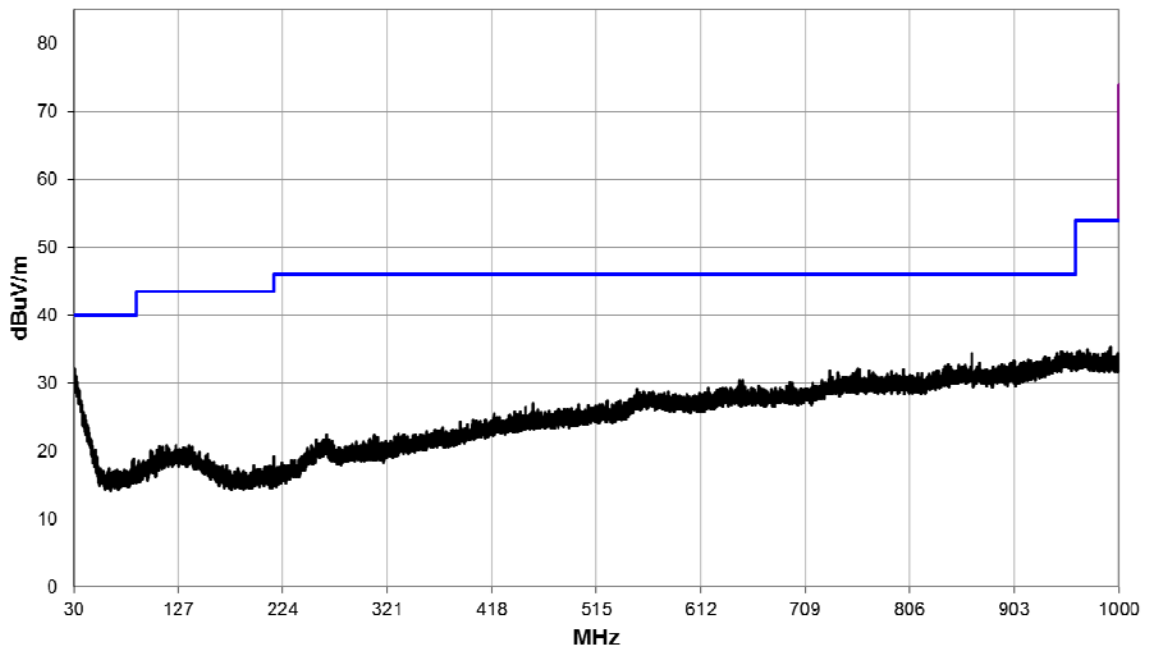

1 GHz to 4 GHz

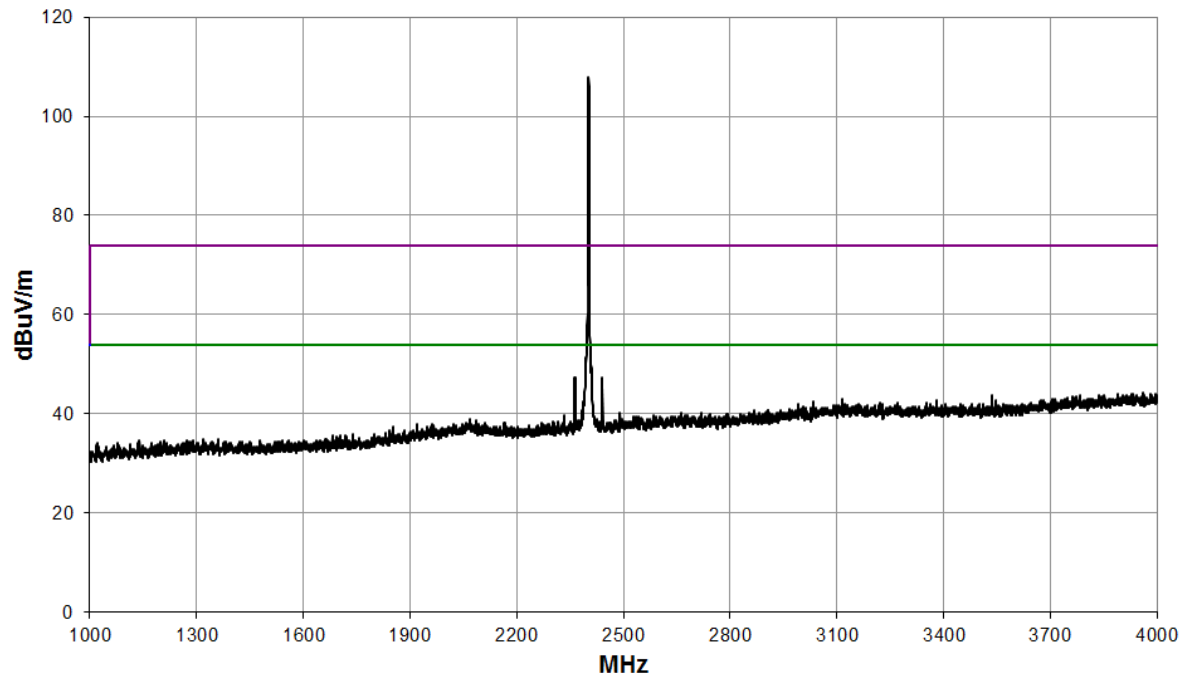

4 GHz to 8.2 GHz

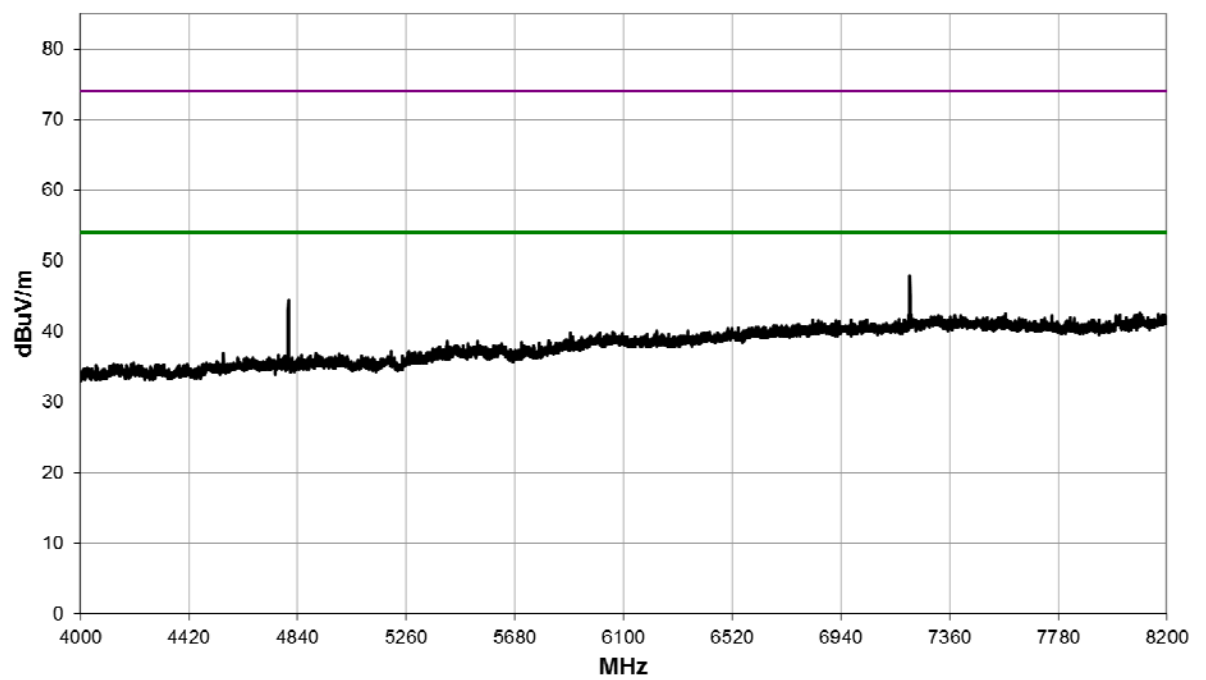

8.2 GHz to 12.4 GHz

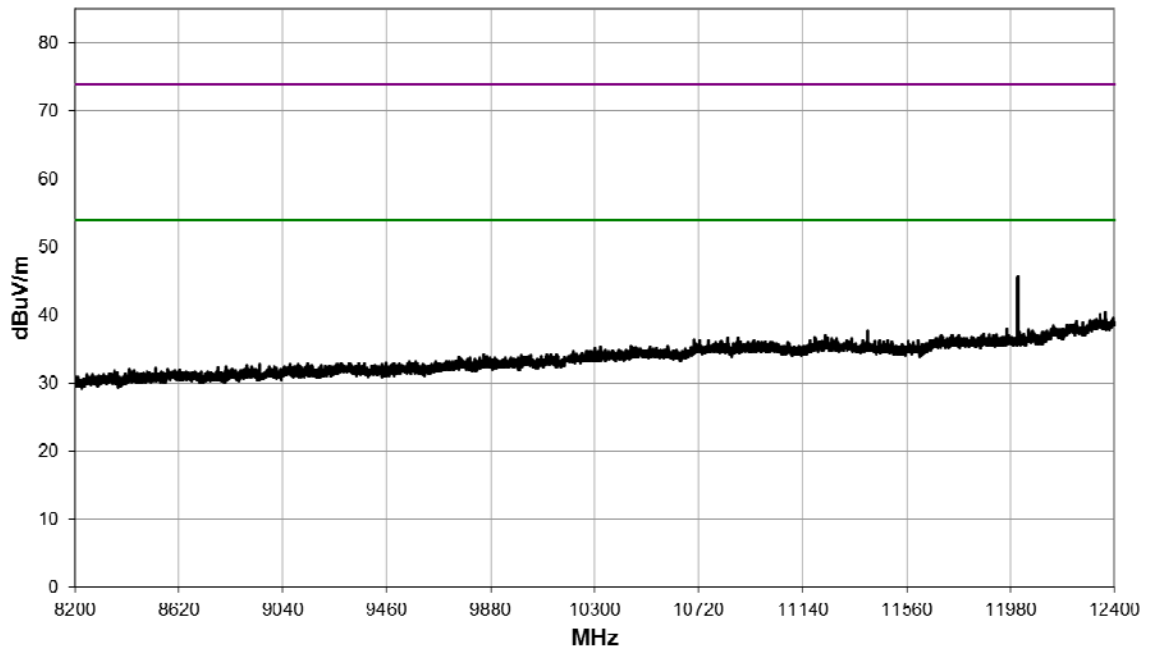

12.4 GHz 18 GHz

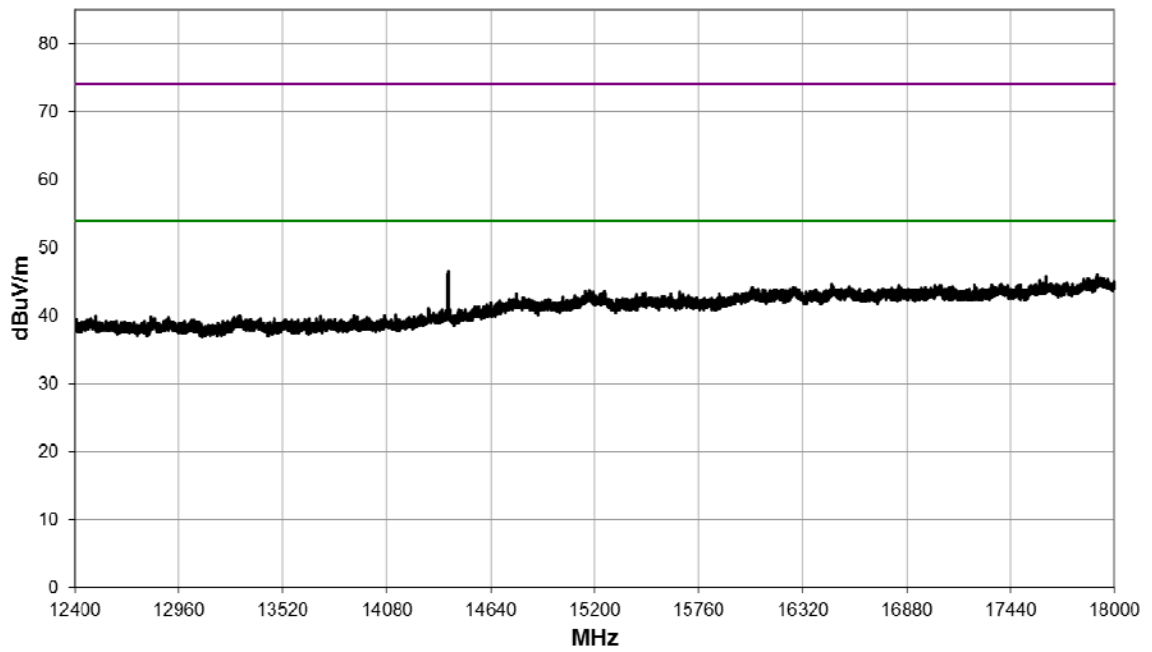

18 GHz to 26.5 GHz

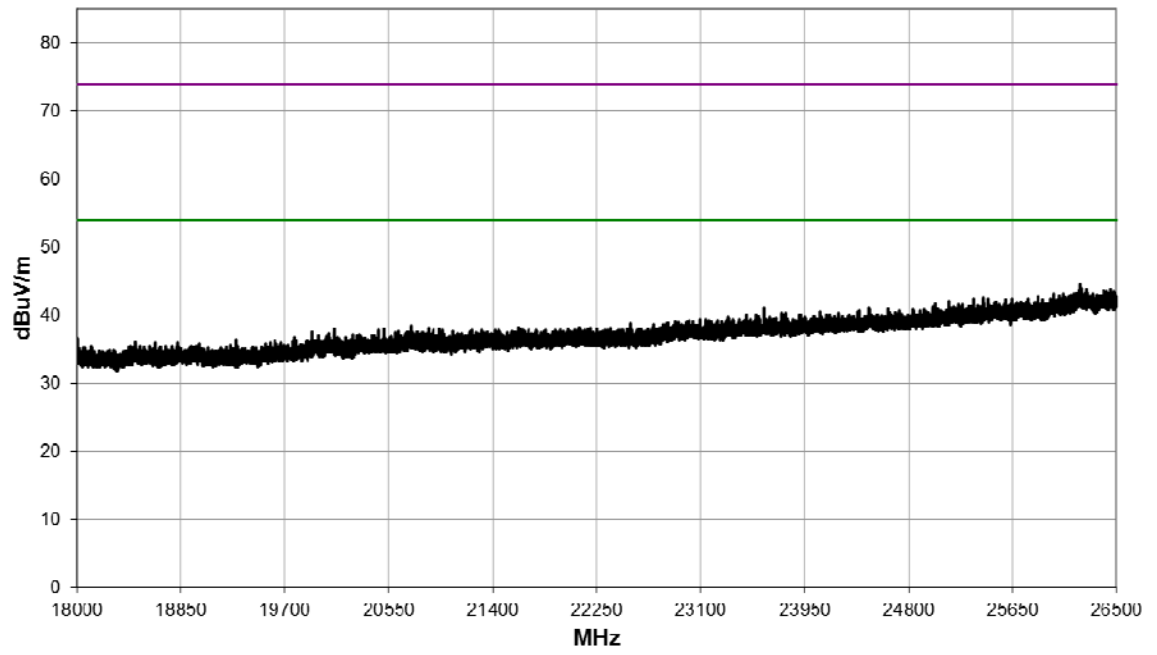

Power Setting: 126; Frequency: 2440 MHz; 1 Mbps								
Detector	Freq. (MHz)	Meas'd Emission (dBμV)	Factor (dB)	Duty Cycle Corr'n (dB)	Distance Extrap'n Factor (dB)	Field Strength (dBμV/m)	Field Strength (μV/m)	Limit (μV/m)
Average	4879.9	34.6	2.7	0	0	37.3	73.3	500
Peak	4879.2	46.2	2.7	0	0	48.9	278.6	5000
Average	7320.4	35.4	8.7	0	0	44.1	160.3	500
Peak	7319.2	48.4	8.7	0	0	57.1	716.1	5000
Average	12200.8	40.2	2.9	0	0	43.1	142.9	500
Peak	12201.0	54.2	2.9	0	0	57.1	716.1	5000

30 MHz to 1 GHz

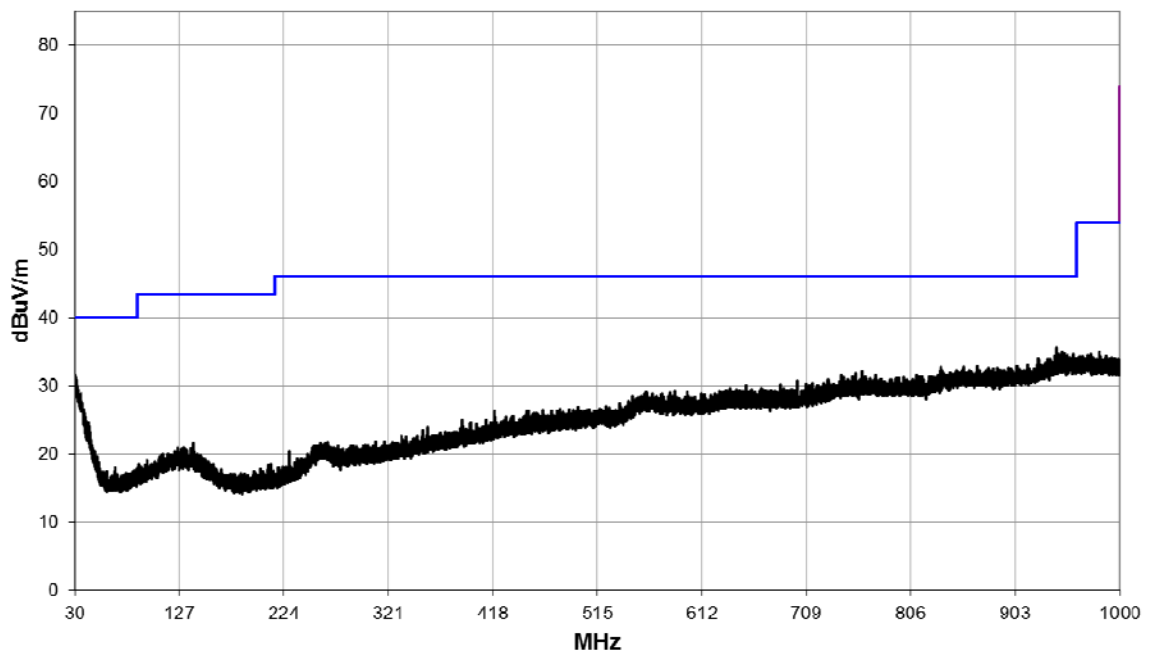

1 GHz to 4 GHz

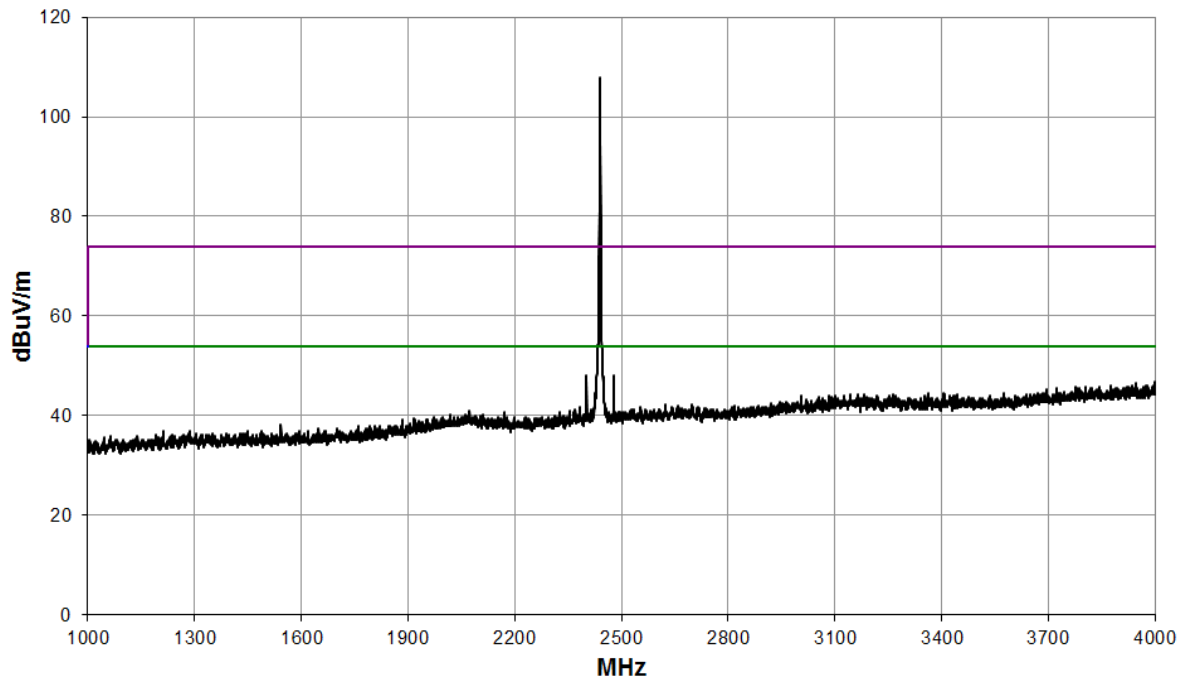

4 GHz to 8.2 GHz

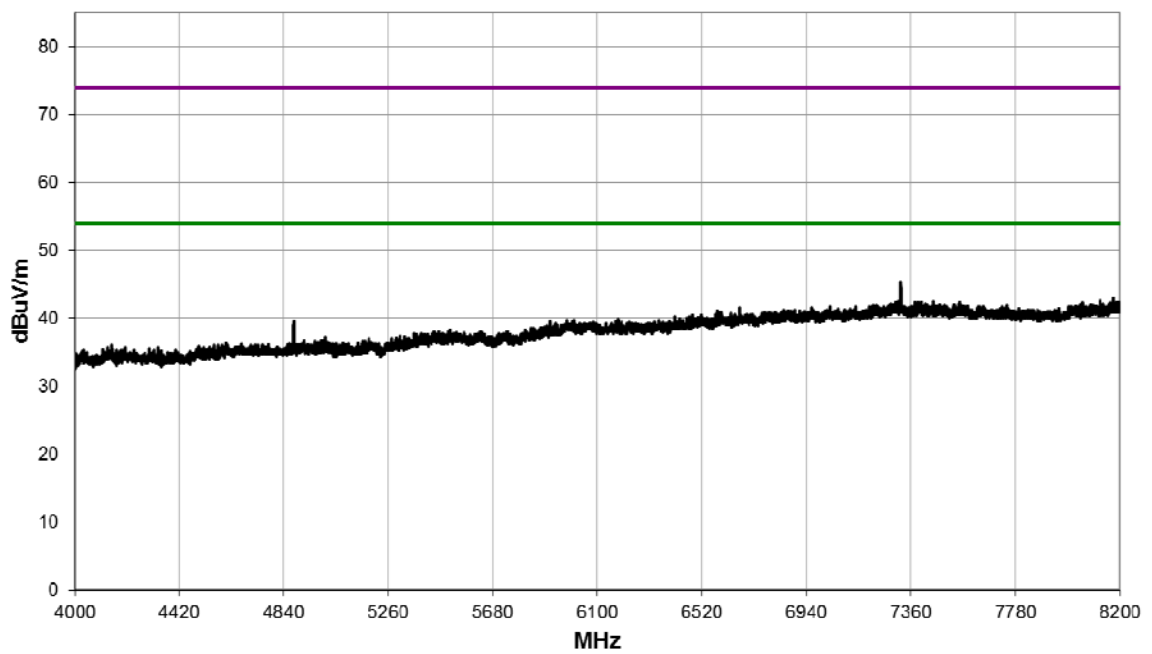

8.2 GHz to 12.4 GHz

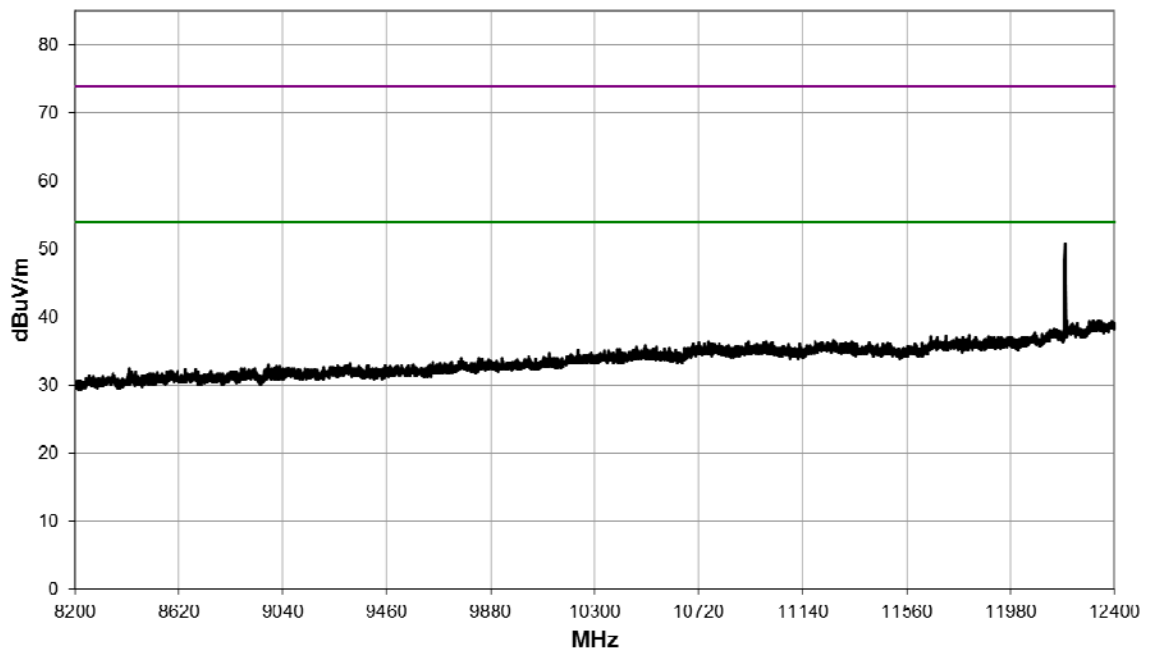

12.4 GHz 18 GHz

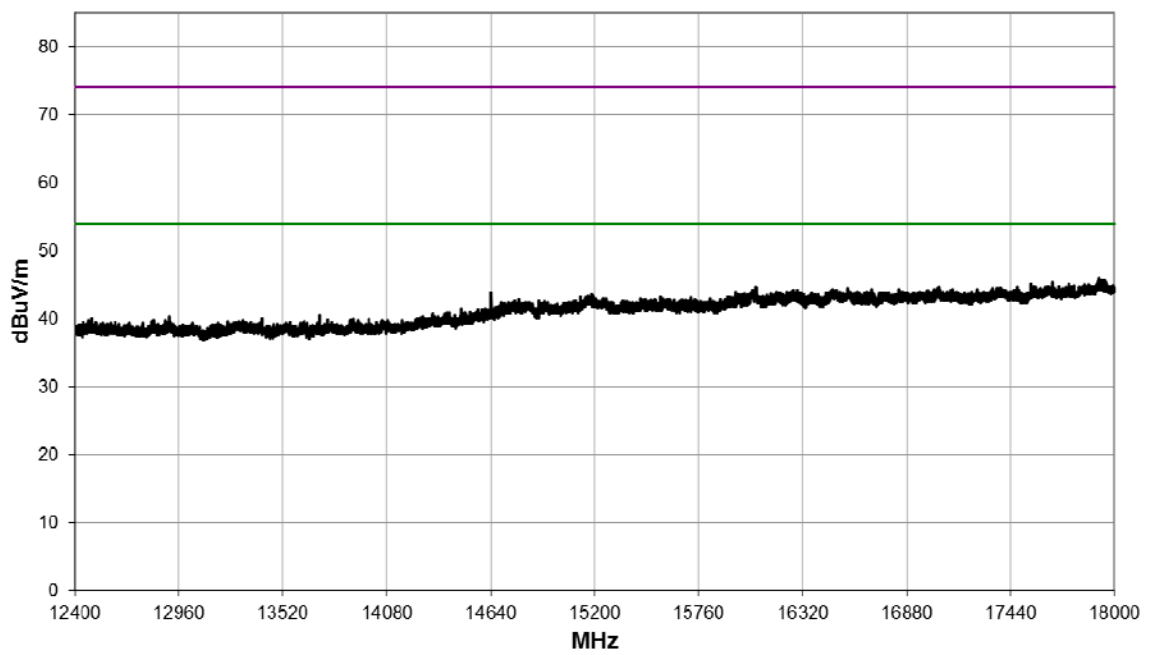

18 GHz to 26.5 GHz

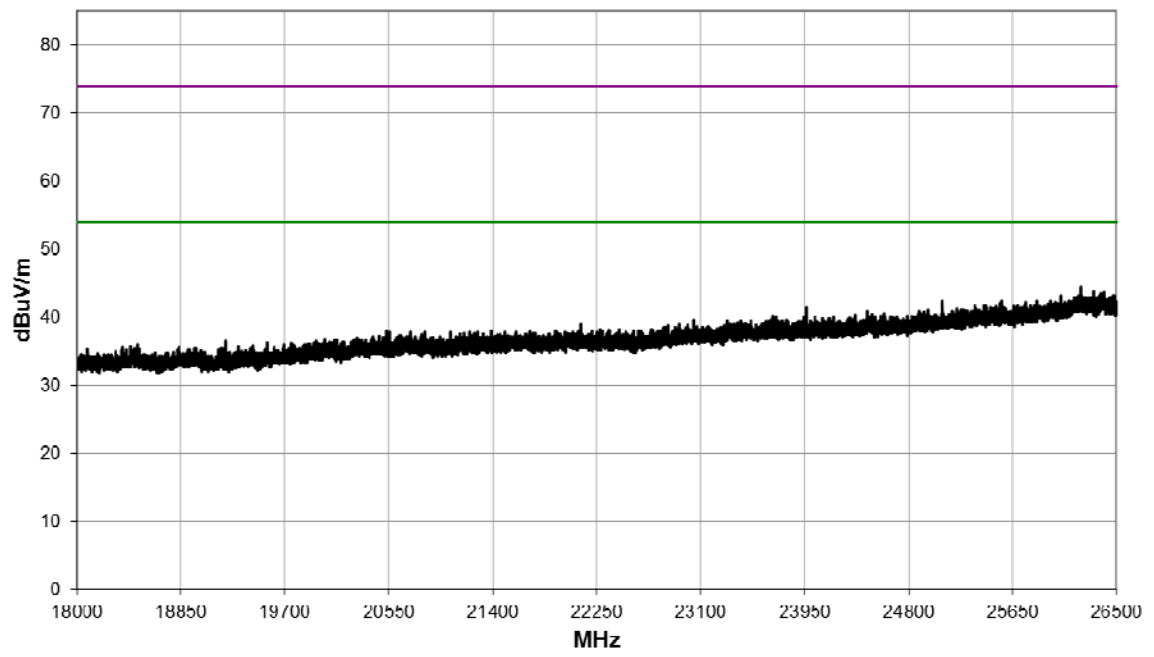

Power Setting: 126; Frequency: 2480 MHz; 1 Mbps								
Detector	Freq. (MHz)	Meas'd Emission (dBμV)	Factor (dB)	Duty Cycle Corr'n (dB)	Distance Extrap'n Factor (dB)	Field Strength (dBμV/m)	Field Strength (μV/m)	Limit (μV/m)
Average	4959.9	35.0	2.7	0	0	37.7	76.7	500
Peak	4960.5	47.0	2.7	0	0	49.7	305.5	5000
Average	7440.4	35.3	8.5	0	0	43.8	154.9	500
Peak	7440.5	48.1	8.5	0	0	56.6	676.1	5000
Average	12398.8	41.2	4.2	0	0	45.4	186.2	500
Peak	12398.6	55.1	4.2	0	0	59.3	922.6	5000

30 MHz to 1 GHz

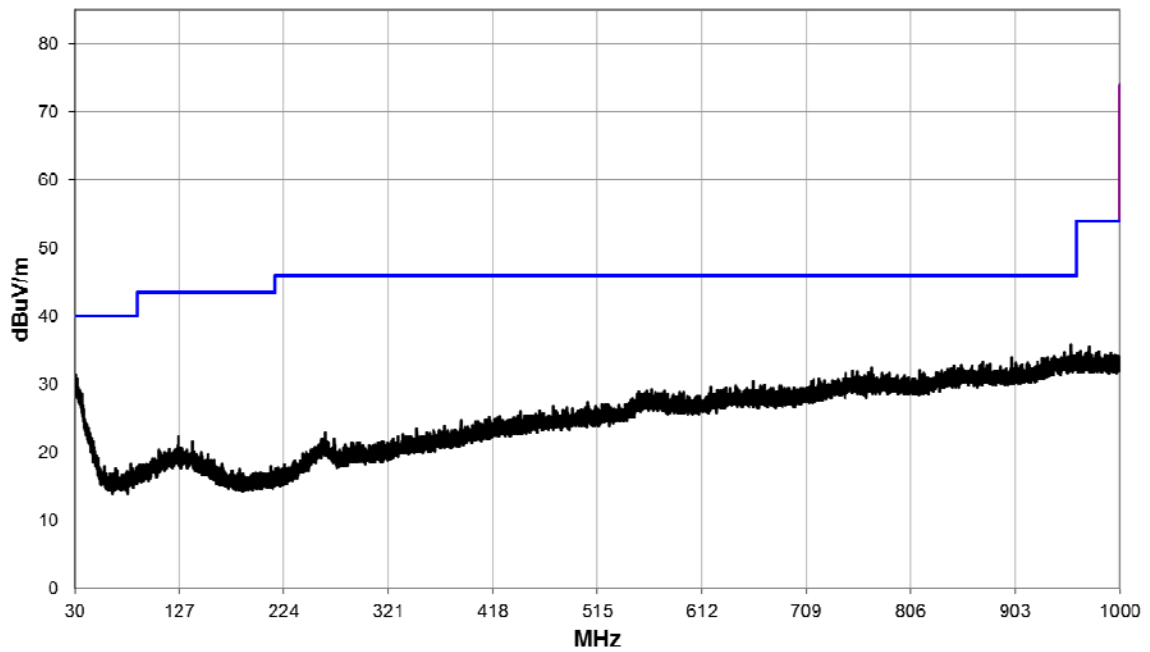

1 GHz to 4 GHz

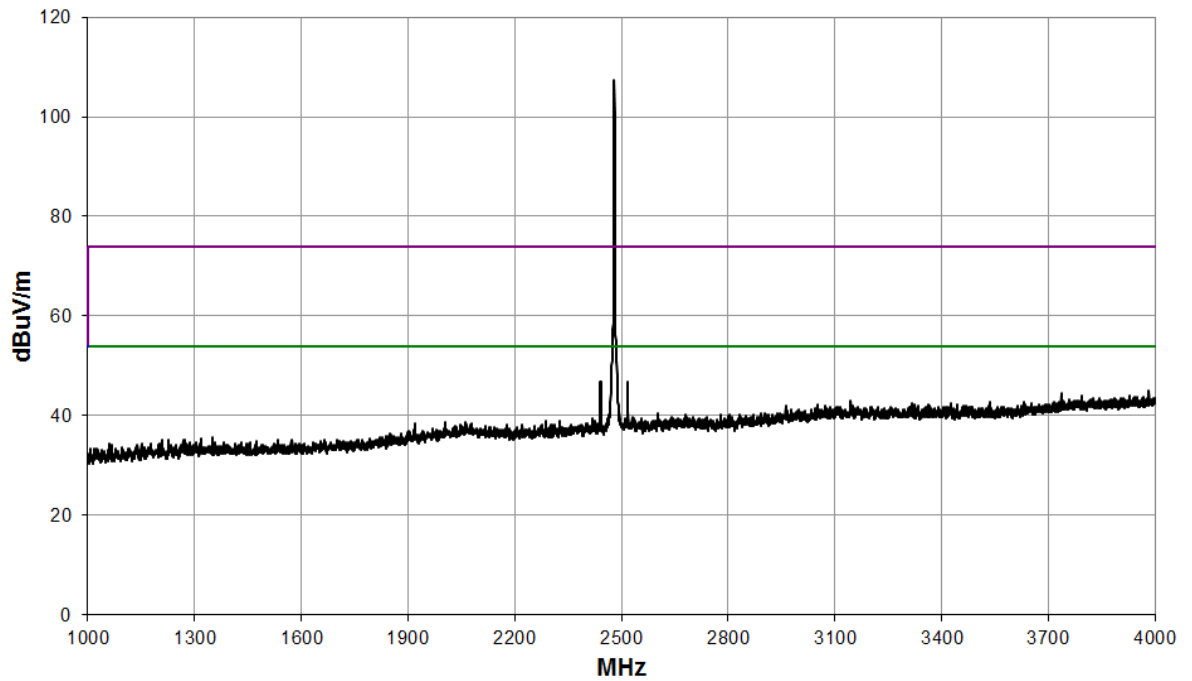

4 GHz to 8.2 GHz

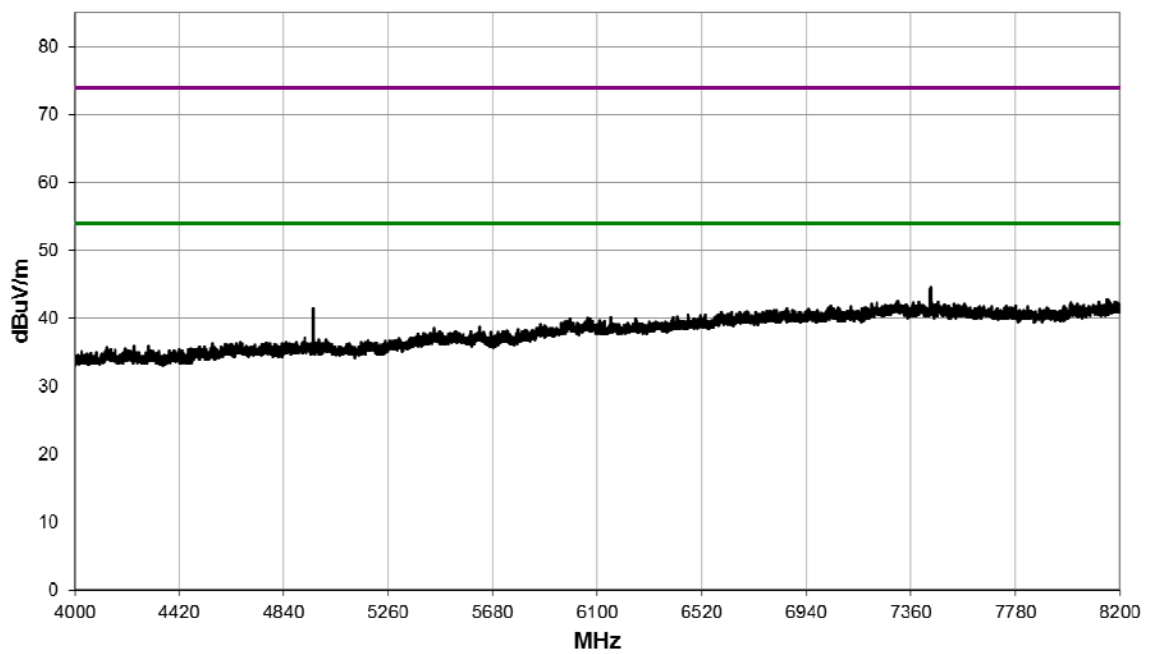

8.2 GHz to 12.4 GHz

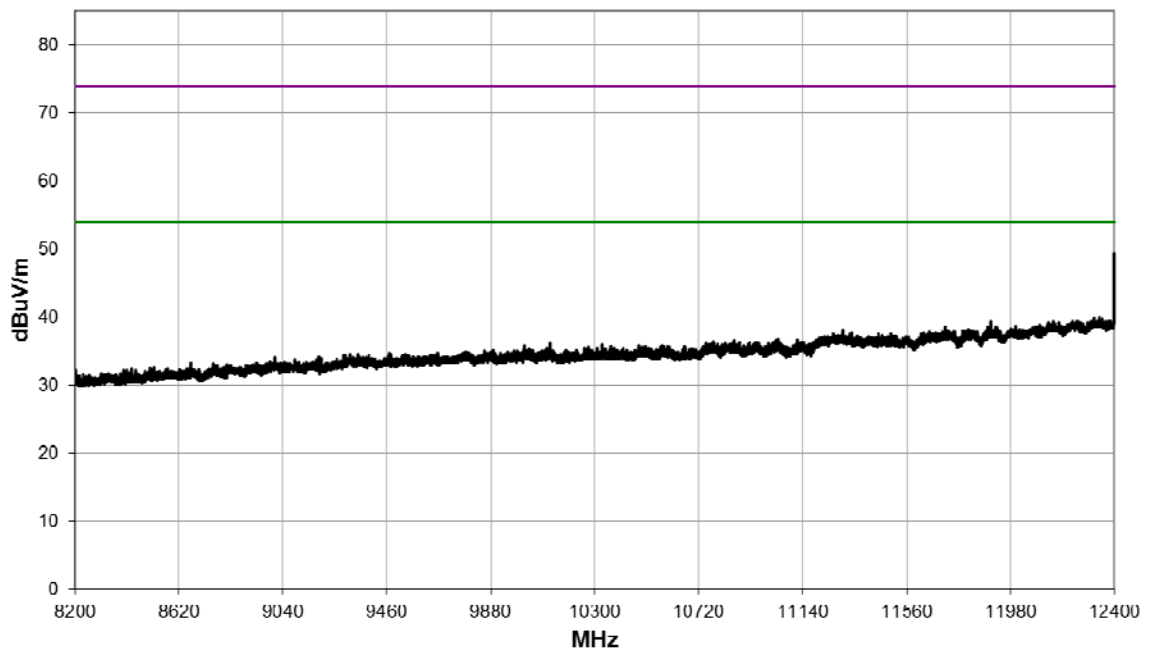

12.4 GHz 18 GHz

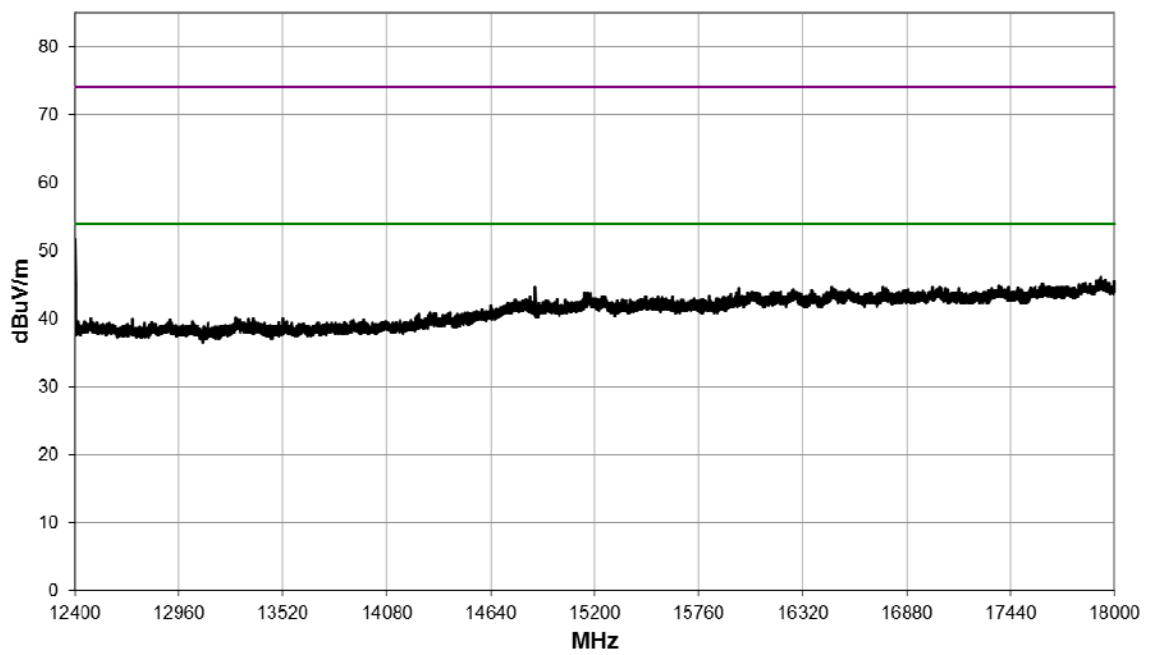

18 GHz to 26.5 GHz

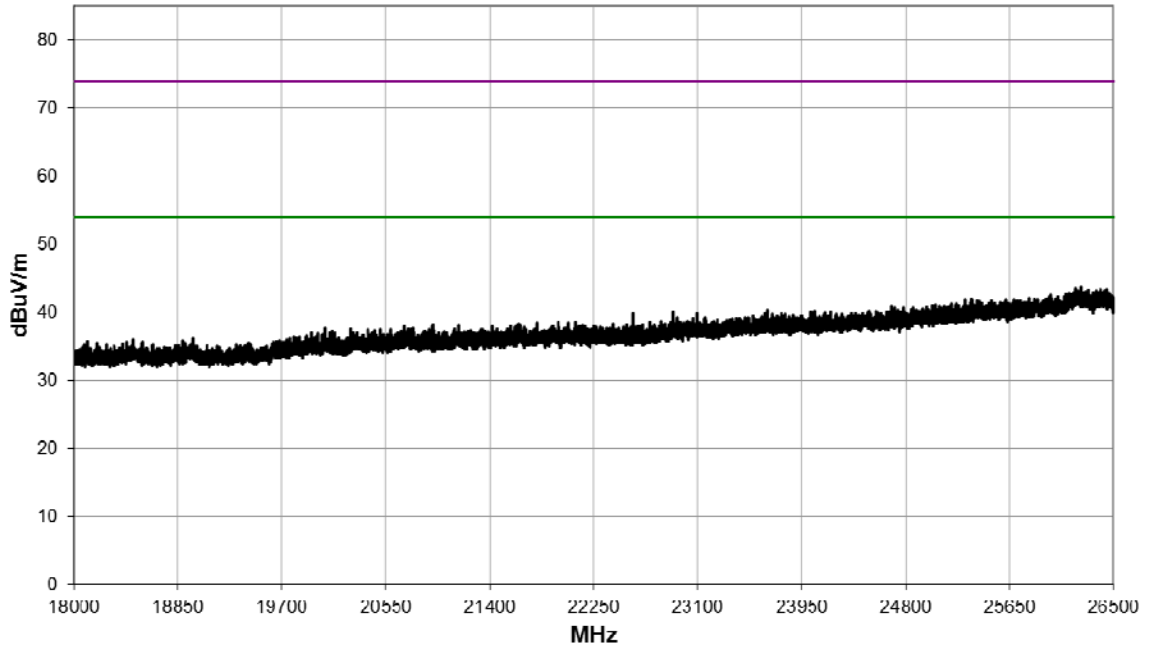

Band Edge



RBW 1 MHz Marker 4 [T2]
 * VBW 3 MHz 40.87 dBuV/m
 * Att 10 dB * SWT 10 s 2.483500000 GHz
 Ref 120 dBuV/m

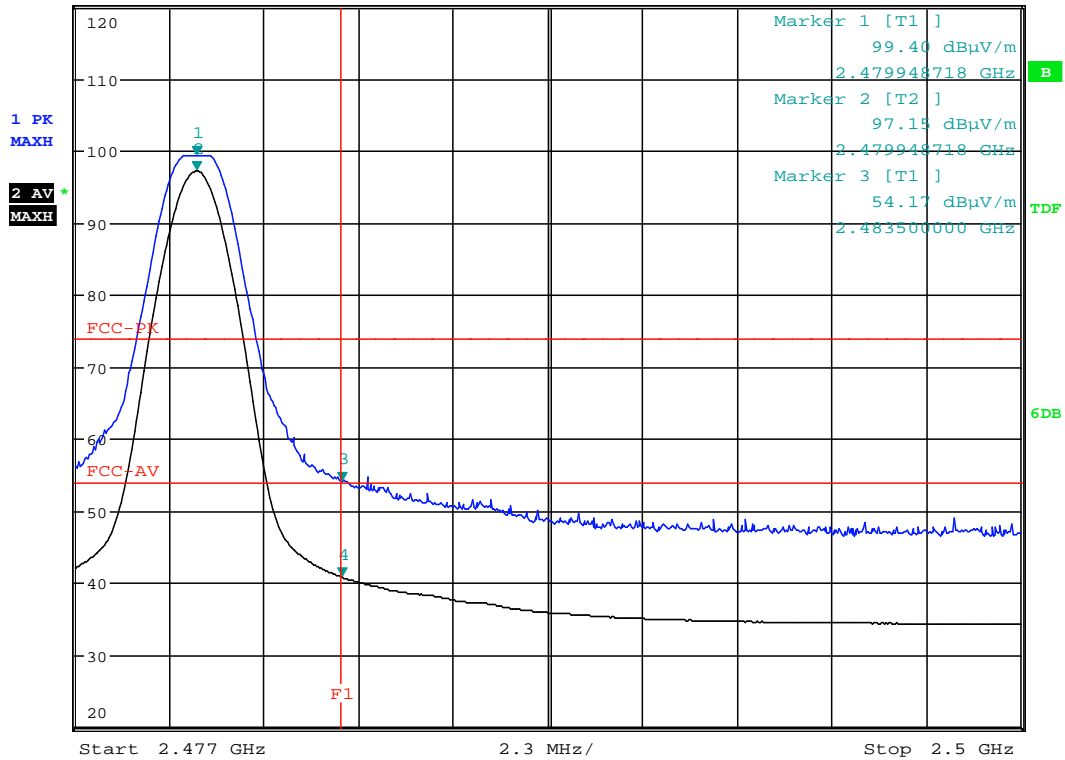

Date: 4.MAR.2019 18:17:00

Power Setting: 126; Frequency: 2402 MHz; 2 Mbps								
Detector	Freq. (MHz)	Meas'd Emission (dBμV)	Factor (dB)	Duty Cycle Corr'n (dB)	Distance Extrap'n Factor (dB)	Field Strength (dBμV/m)	Field Strength (μV/m)	Limit (μV/m)
Average	2363.6	37.4	-3.5	0	0	33.9	49.5	500
Peak	2363.0	51.0	-3.5	0	0	47.5	237.1	5000
Average	4803.0	32.1	2.6	0	0	34.7	54.3	500
Peak	4803.0	47.1	2.6	0	0	49.7	305.5	5000
Average	12007.8	35.4	2.7	0	0	38.1	80.4	500
Peak	12007.5	51.8	2.7	0	0	54.5	530.9	5000

30 MHz to 1 GHz

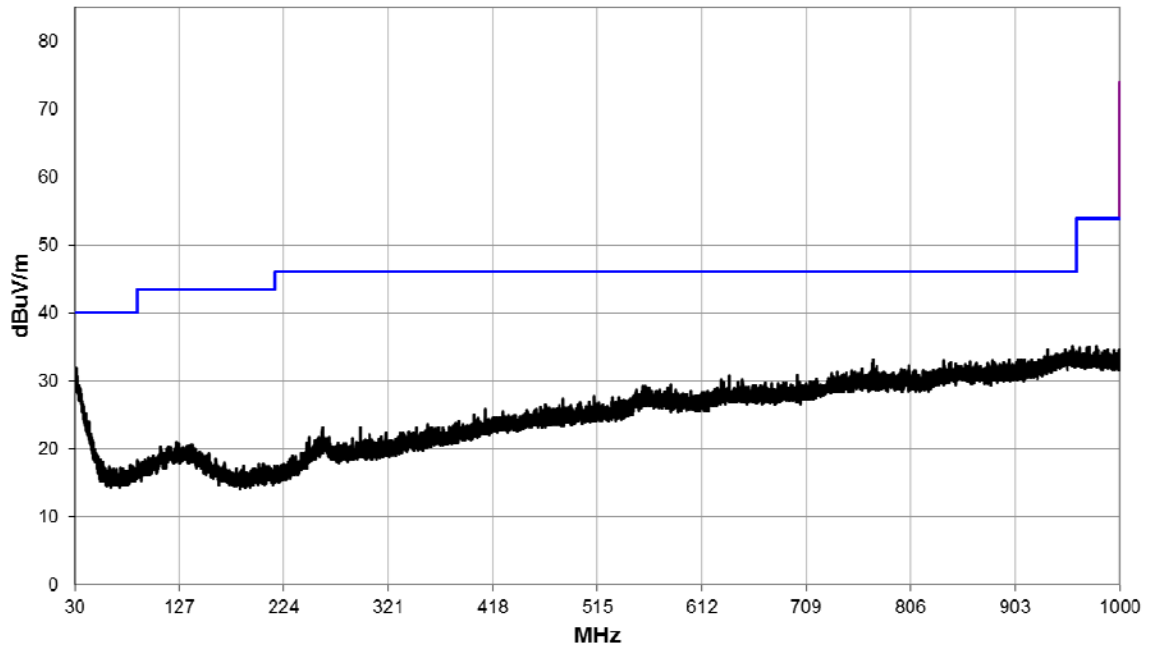

1 GHz to 4 GHz

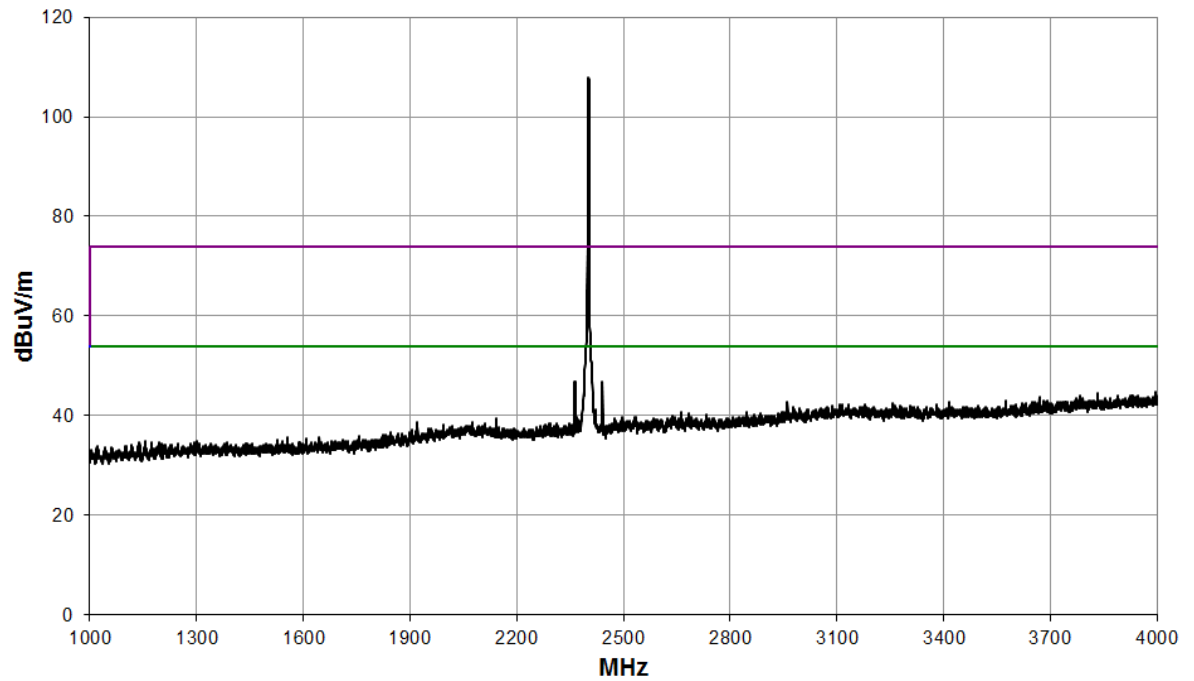

4 GHz to 8.2 GHz

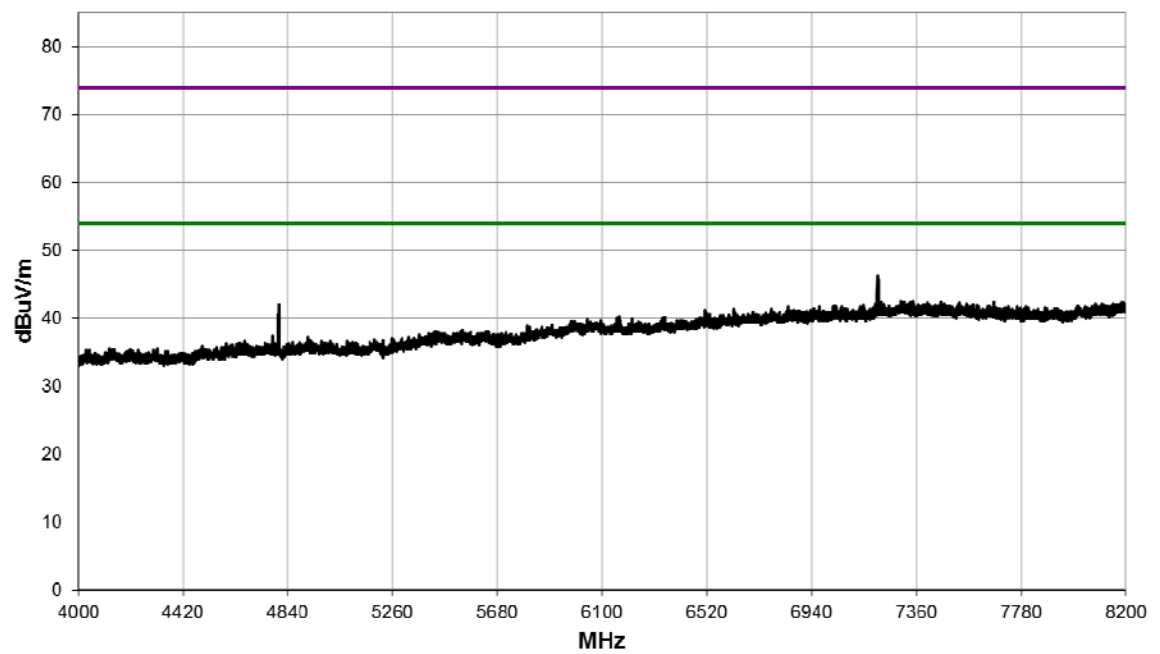

8.2 GHz to 12.4 GHz

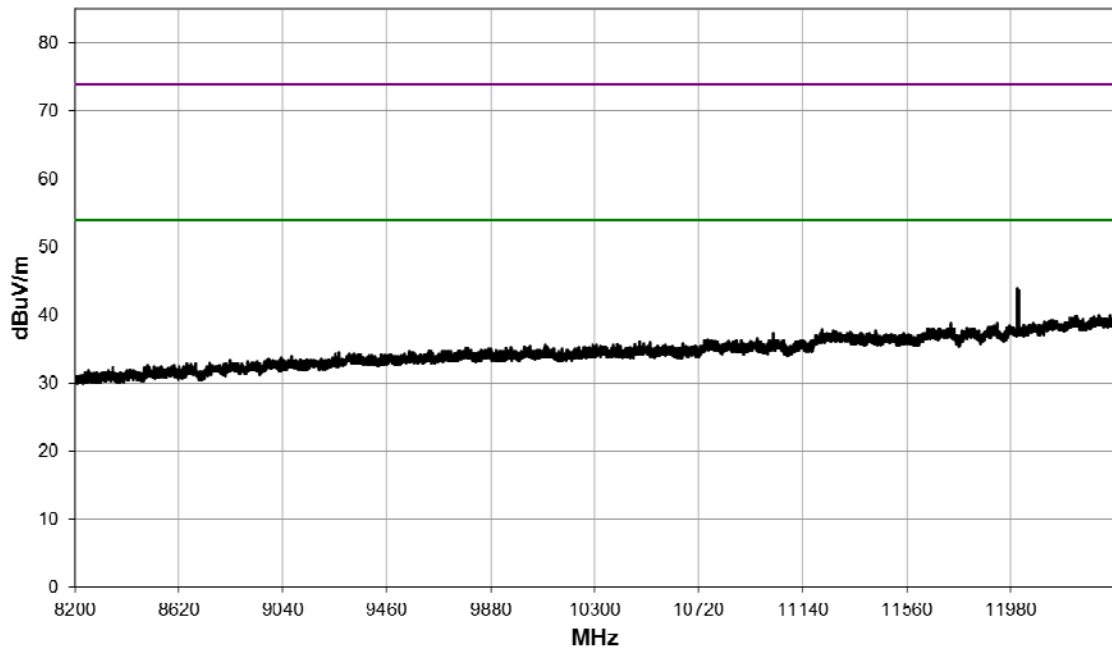

12.4 GHz 18 GHz

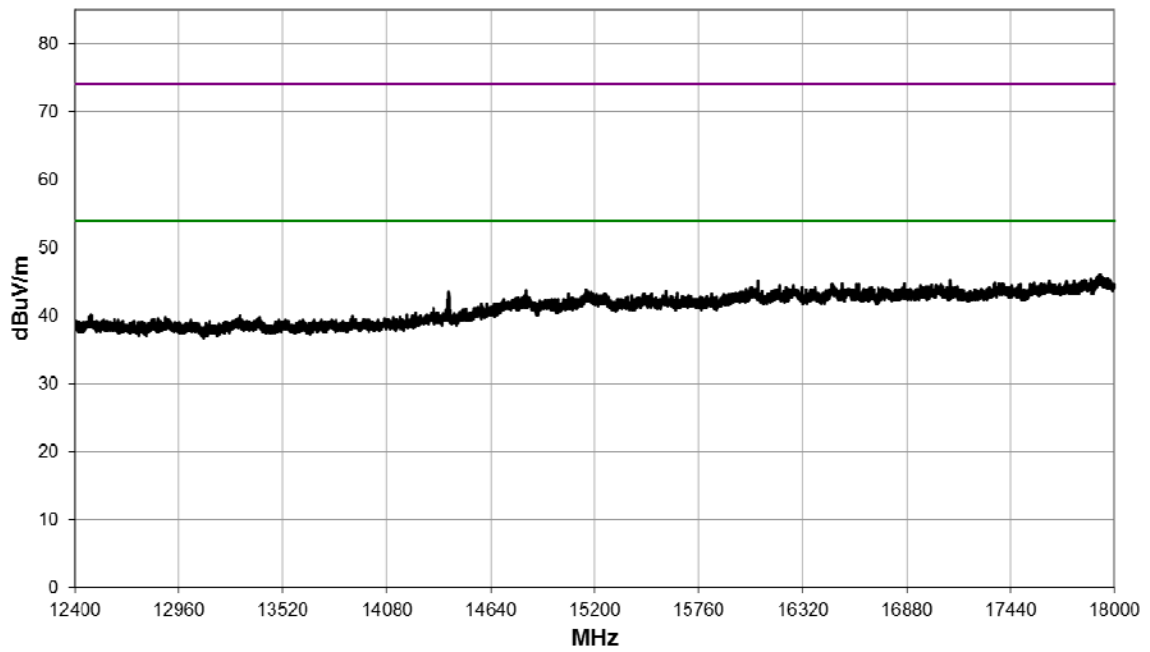

18 GHz to 26.5 GHz

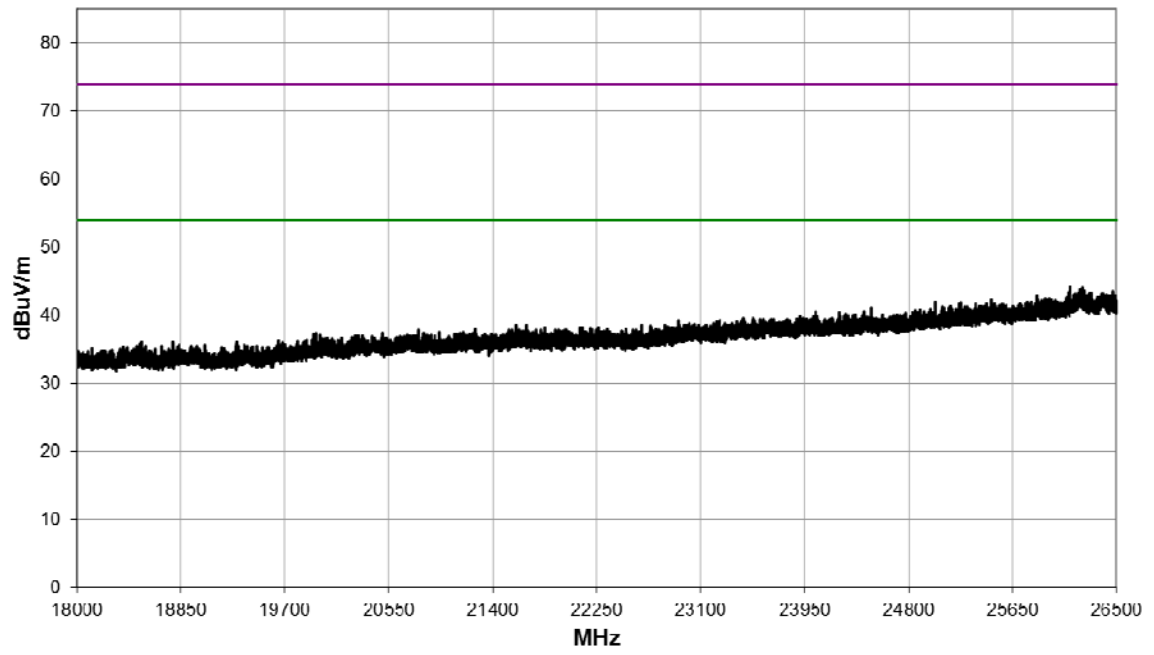

Power Setting: 126; Frequency: 2440 MHz; 2 Mbps								
Detector	Freq. (MHz)	Meas'd Emission (dBμV)	Factor (dB)	Duty Cycle Corr'n (dB)	Distance Extrap'n Factor (dB)	Field Strength (dBμV/m)	Field Strength (μV/m)	Limit (μV/m)
Average	7318.8	32.4	8.7	0	0	41.1	113.5	500
Peak	7321.3	47.6	8.7	0	0	56.3	653.1	5000
Average	12197.8	37.3	3.2	0	0	40.5	105.9	500
Peak	12197.6	54.6	3.2	0	0	57.8	776.2	5000

30 MHz to 1 GHz

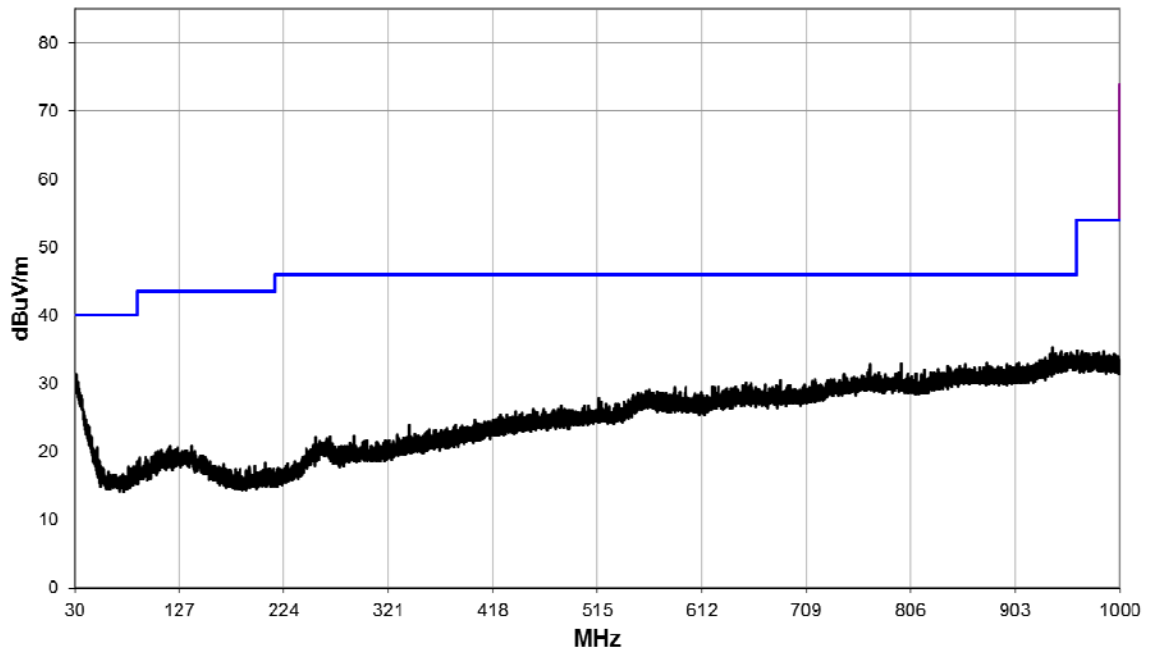

1 GHz to 4 GHz

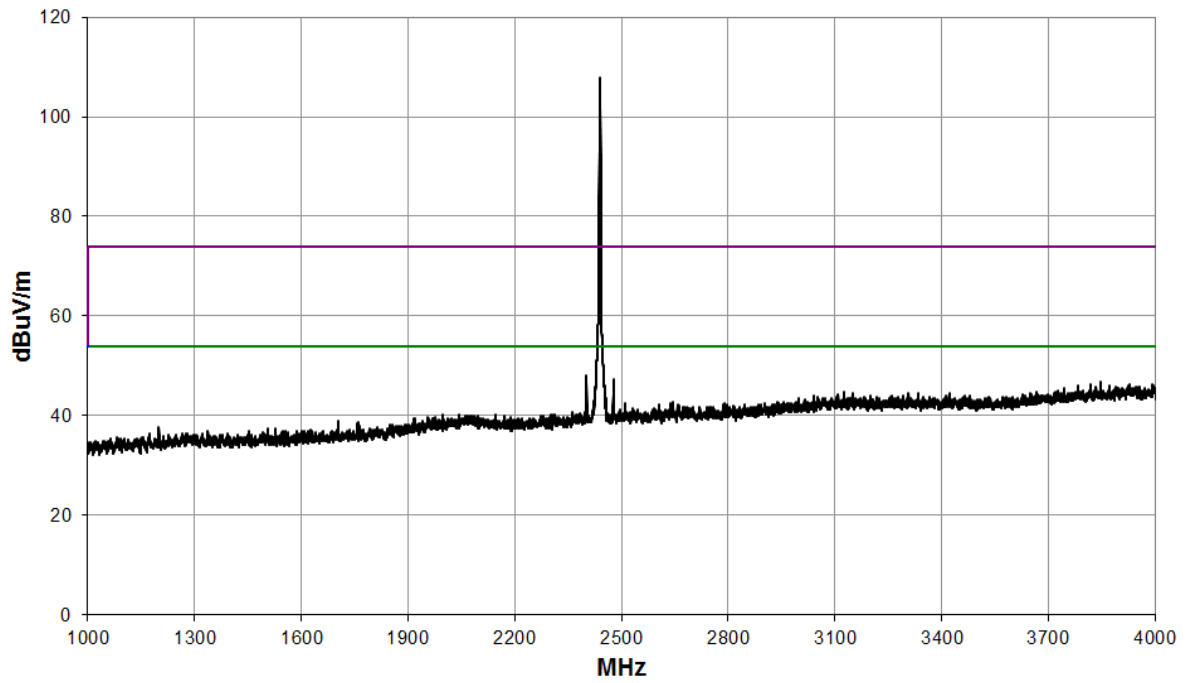

4 GHz to 8.2 GHz

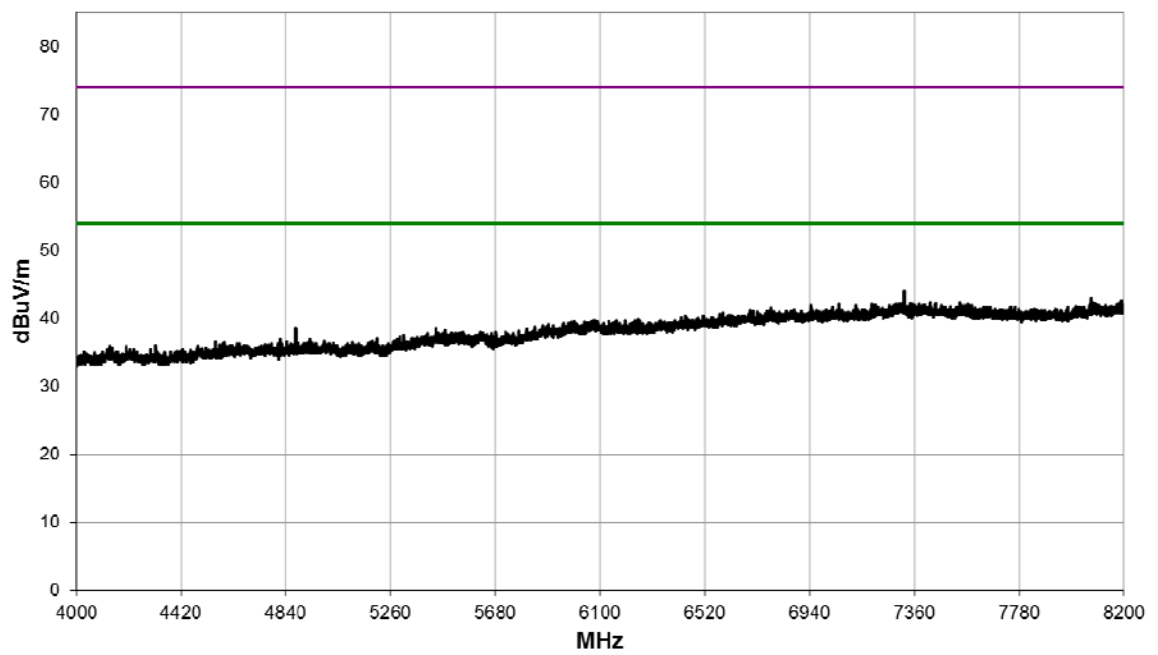

8.2 GHz to 12.4 GHz

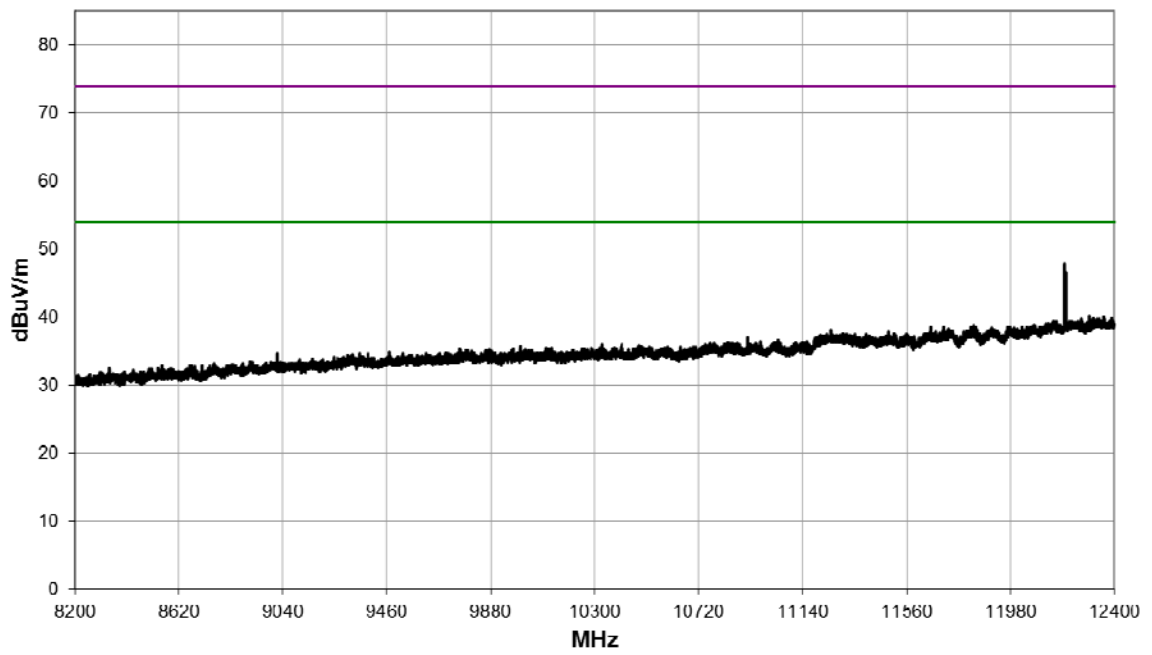

12.4 GHz 18 GHz

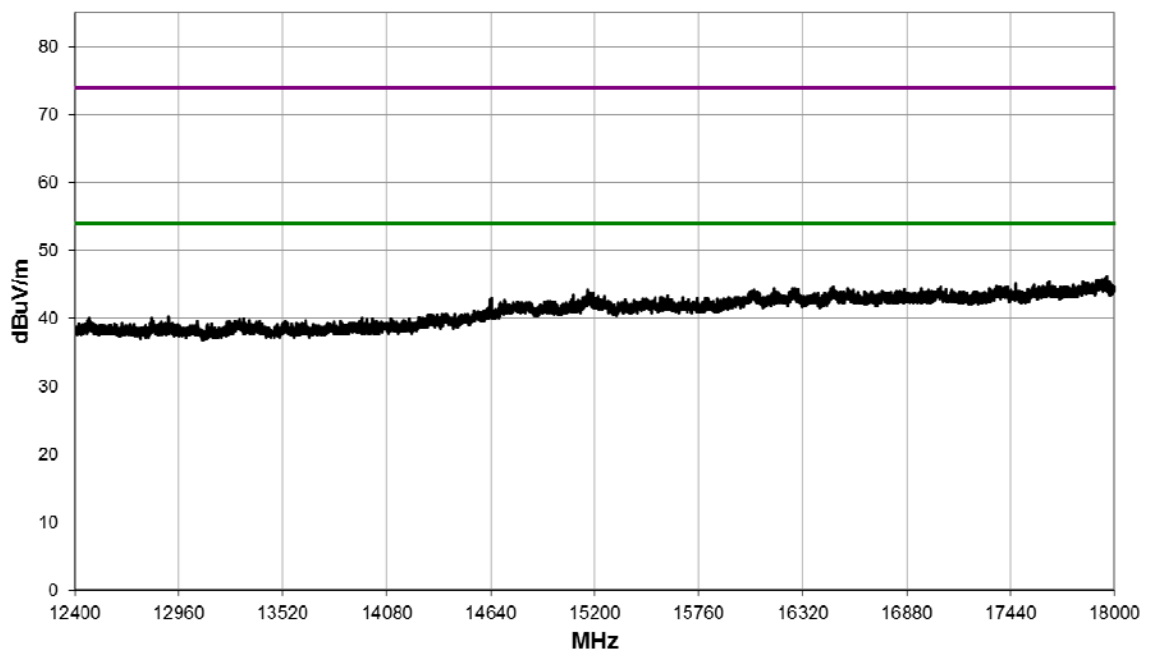

18 GHz to 26.5 GHz

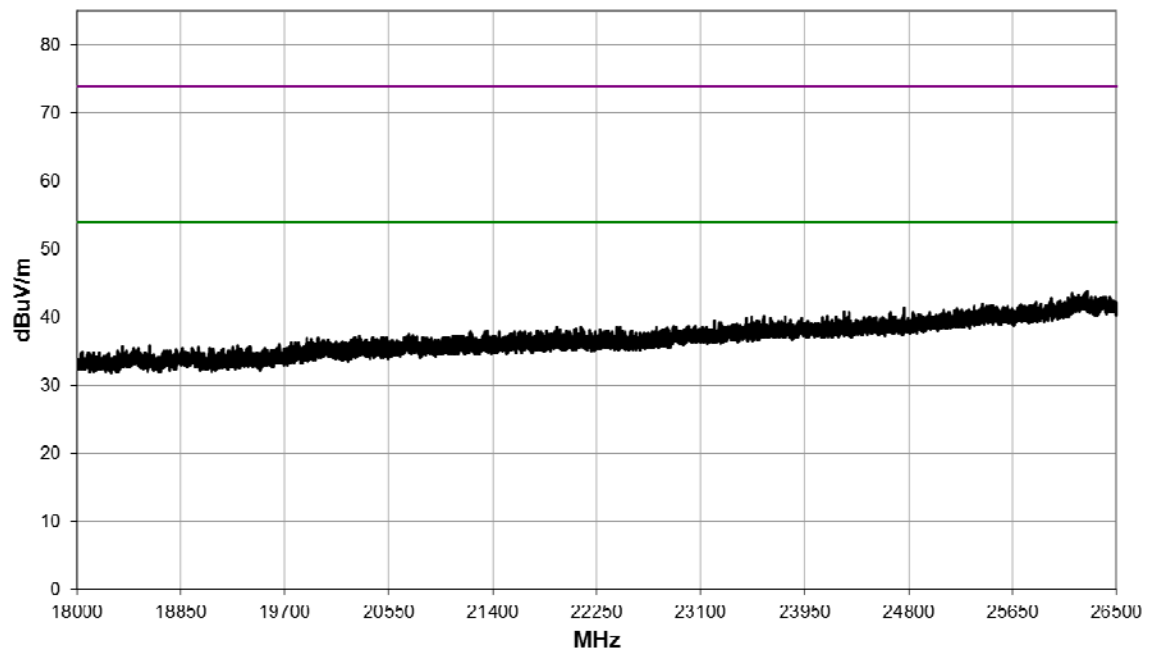

Power Setting: 126; Frequency: 2480 MHz; 2 Mbps								
Detector	Freq. (MHz)	Meas'd Emission (dBμV)	Factor (dB)	Duty Cycle Corr'n (dB)	Distance Extrap'n Factor (dB)	Field Strength (dBμV/m)	Field Strength (μV/m)	Limit (μV/m)
Average	4959.0	31.5	2.7	0	0	34.2	51.3	500
Peak	4960.8	46.6	2.7	0	0	49.3	291.7	5000
Average	7441.0	32.8	8.5	0	0	41.3	116.1	500
Peak	7438.6	48.1	8.5	0	0	56.6	676.1	5000
Average	12397.7	37.6	4.2	0	0	41.8	123.0	500
Peak	12397.5	54.9	4.2	0	0	59.1	901.6	5000

30 MHz to 1 GHz

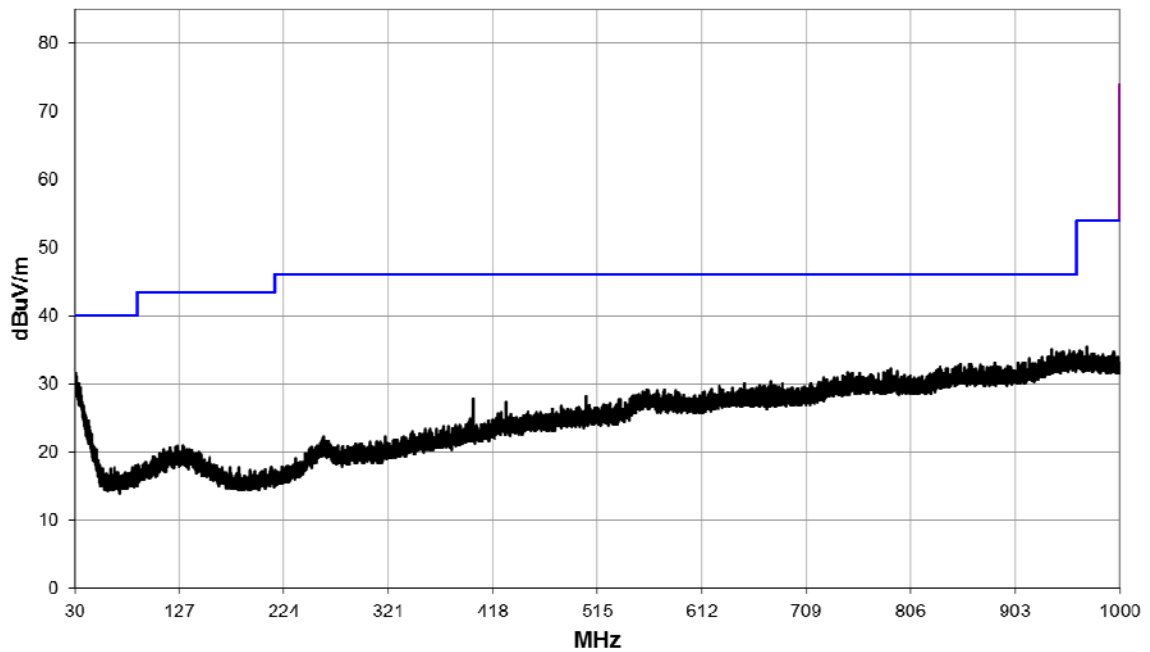

1 GHz to 4 GHz

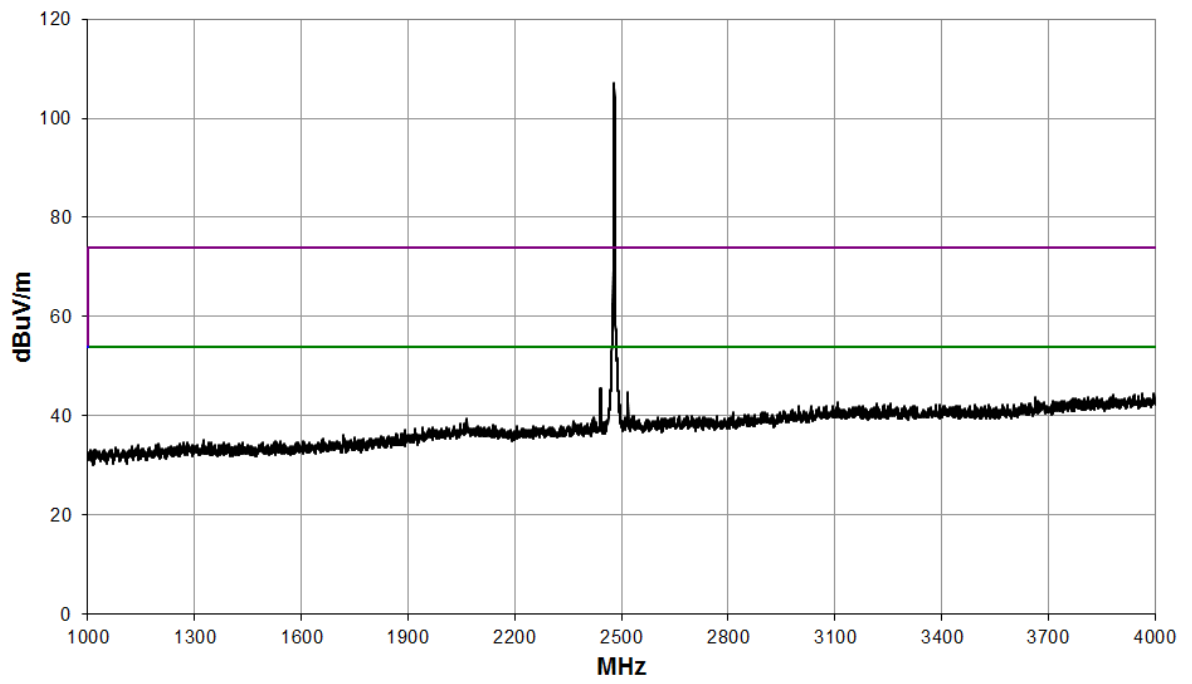

4 GHz to 8.2 GHz

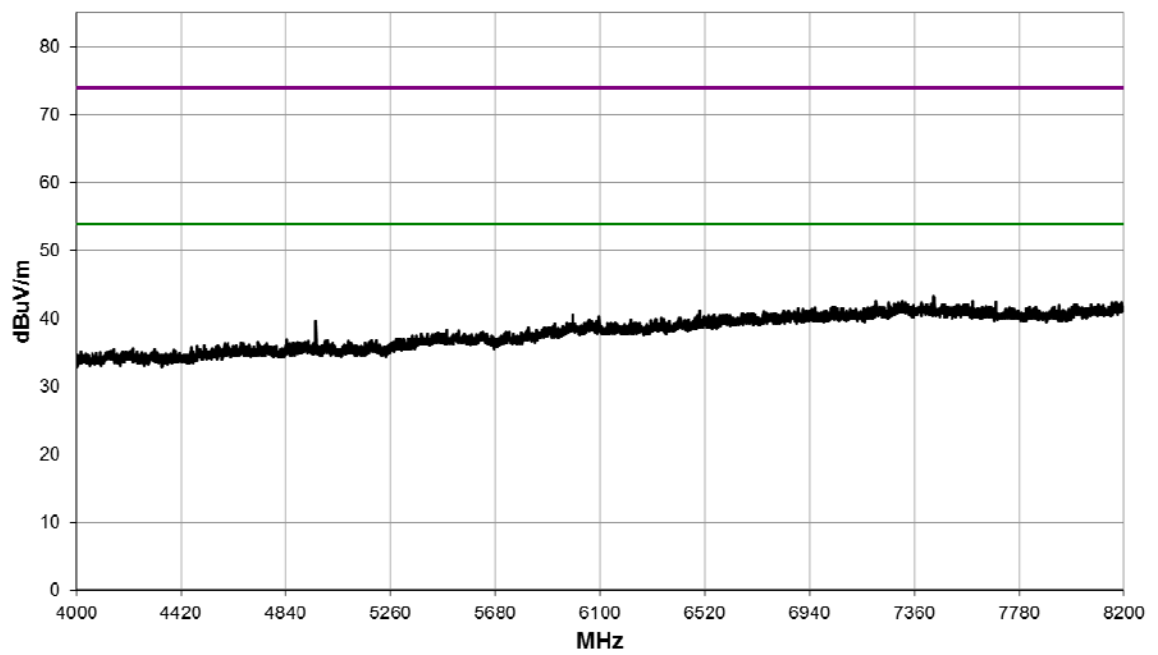

8.2 GHz to 12.4 GHz

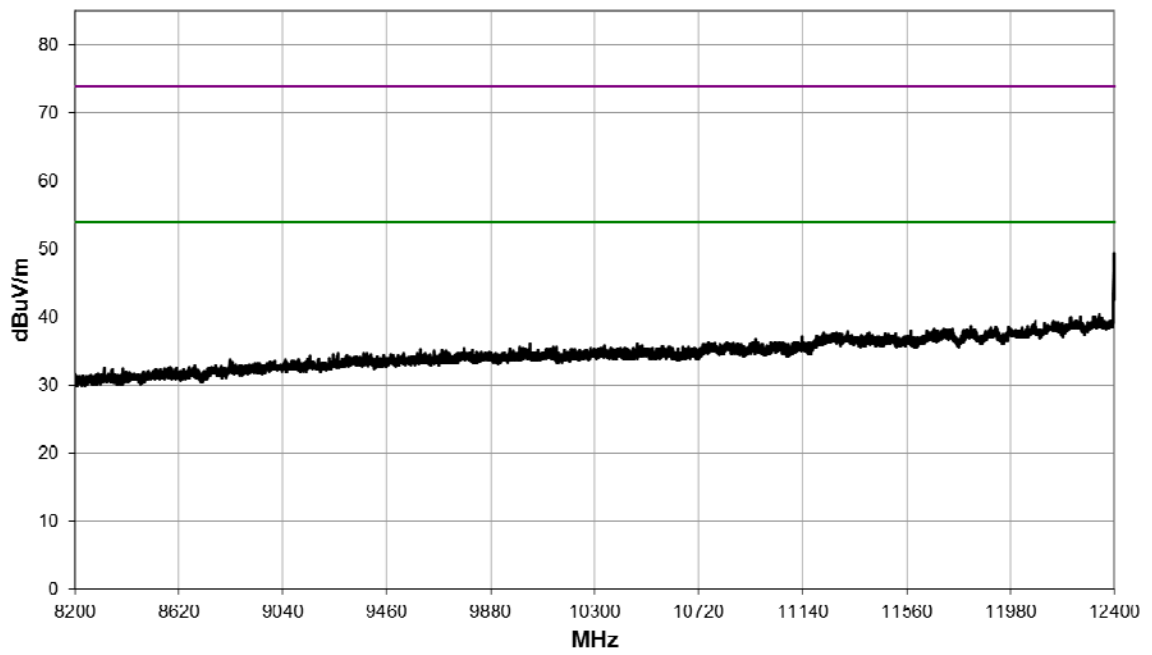

12.4 GHz 18 GHz

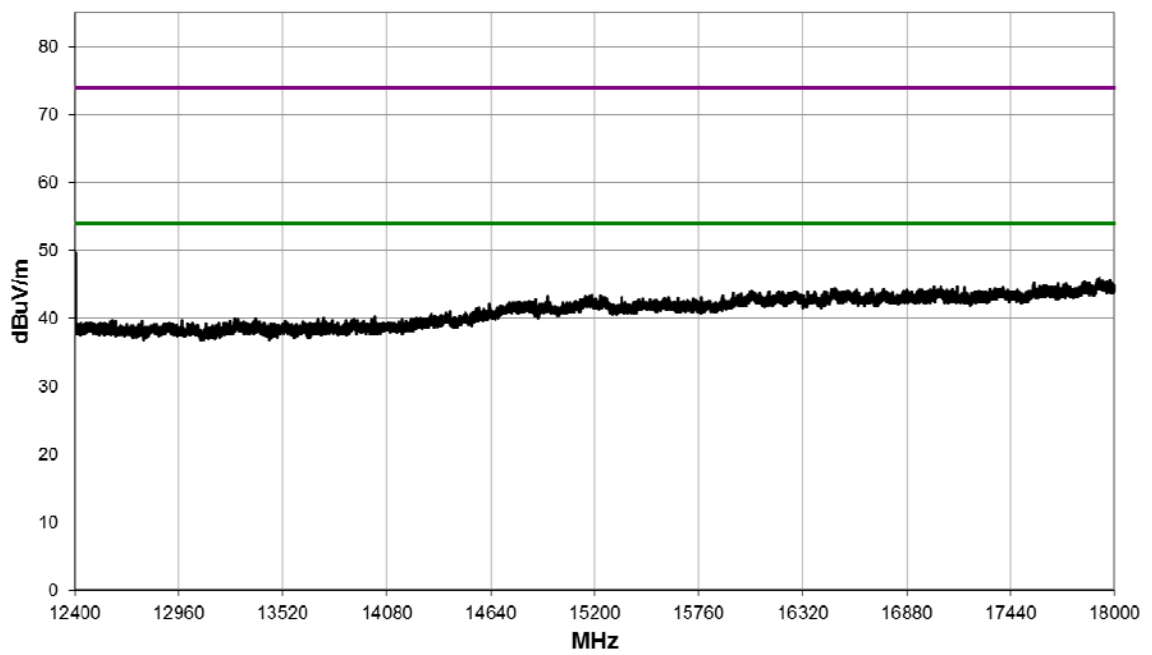

18 GHz to 26.5 GHz

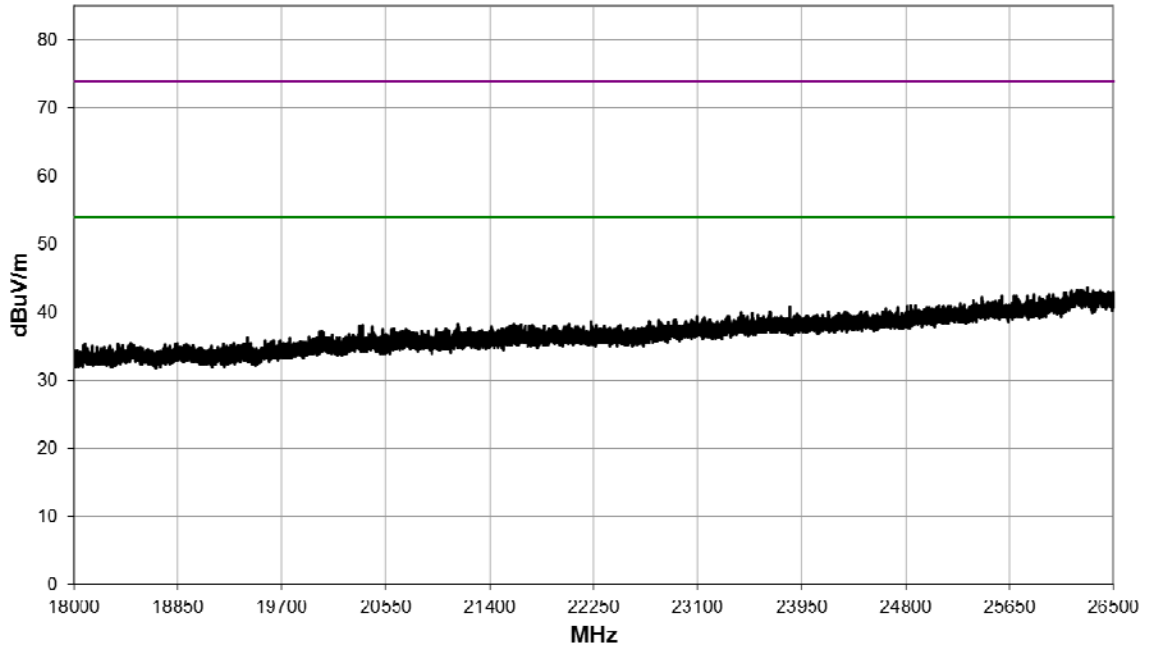

Band Edge

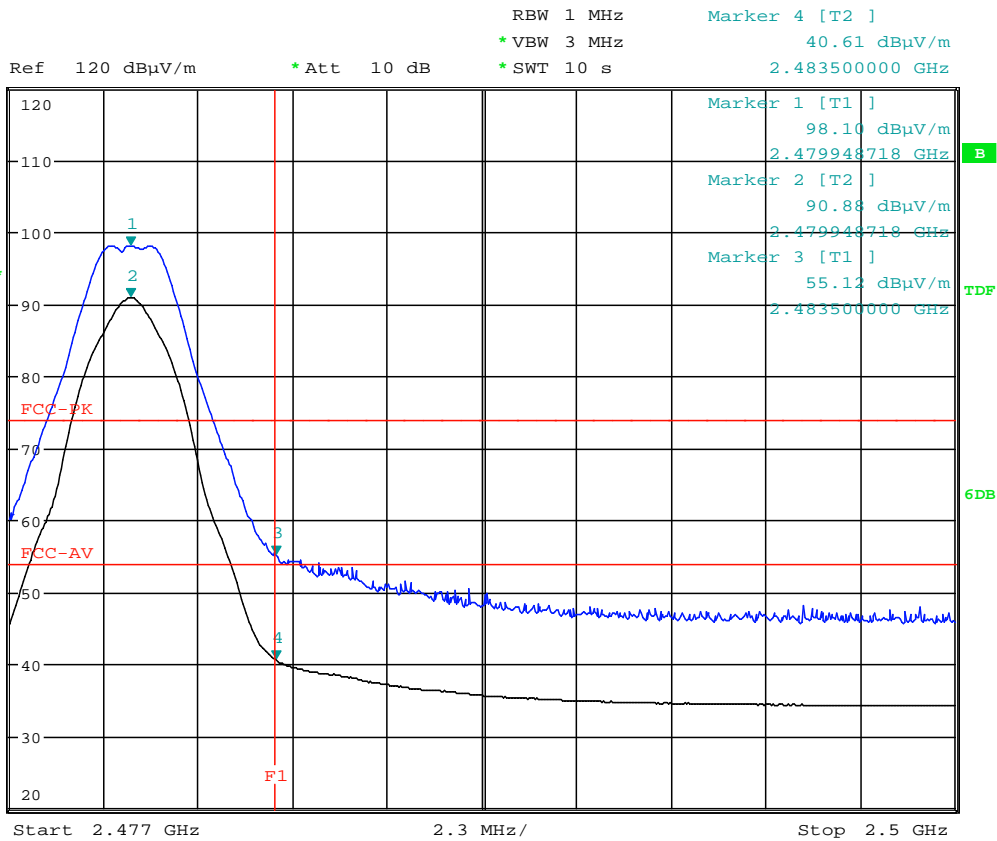

Date: 4.MAR.2019 18:29:29

Power Setting: 126; Frequency: 2402 MHz; 125k coded								
Detector	Freq. (MHz)	Meas'd Emission (dBμV)	Factor (dB)	Duty Cycle Corr'n (dB)	Distance Extrap'n Factor (dB)	Field Strength (dBμV/m)	Field Strength (μV/m)	Limit (μV/m)
Average	2363.6	44.7	-3.5	0	0	41.2	114.8	500
Peak	2363.4	51.3	-3.5	0	0	47.8	245.5	5000
Average	4803.9	36.8	2.6	0	0	39.4	93.3	500
Peak	4803.2	47.5	2.6	0	0	50.1	319.9	5000
Average	7206.5	37.7	8.4	0	0	46.1	201.8	500
Peak	7205.3	49.8	8.4	0	0	58.2	812.8	5000
Average	12008.6	39.5	2.7	0	0	42.2	128.8	500
Peak	12008.6	52.6	2.7	0	0	55.3	582.1	5000

30 MHz to 1 GHz

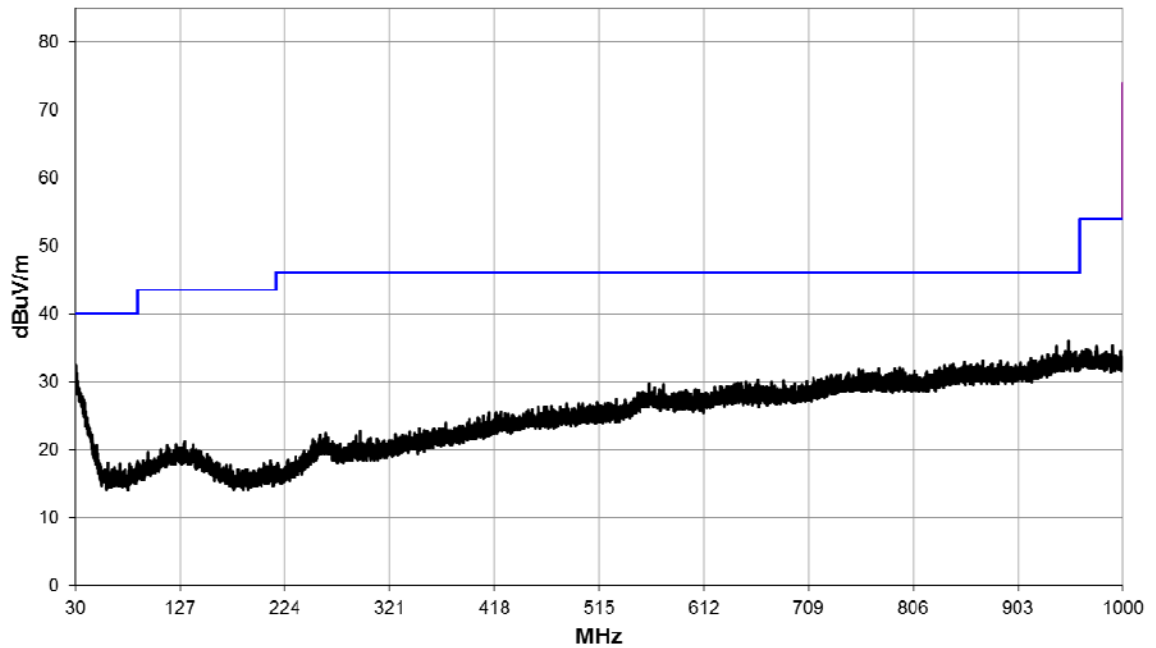

1 GHz to 4 GHz

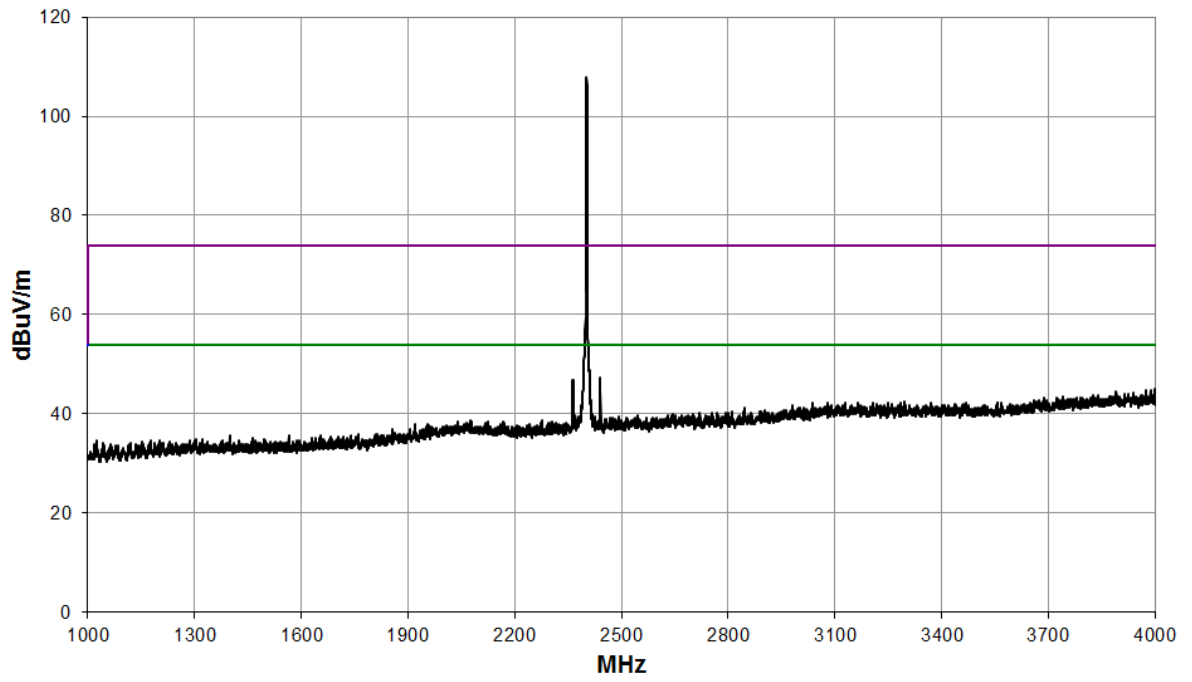

4 GHz to 8.2 GHz

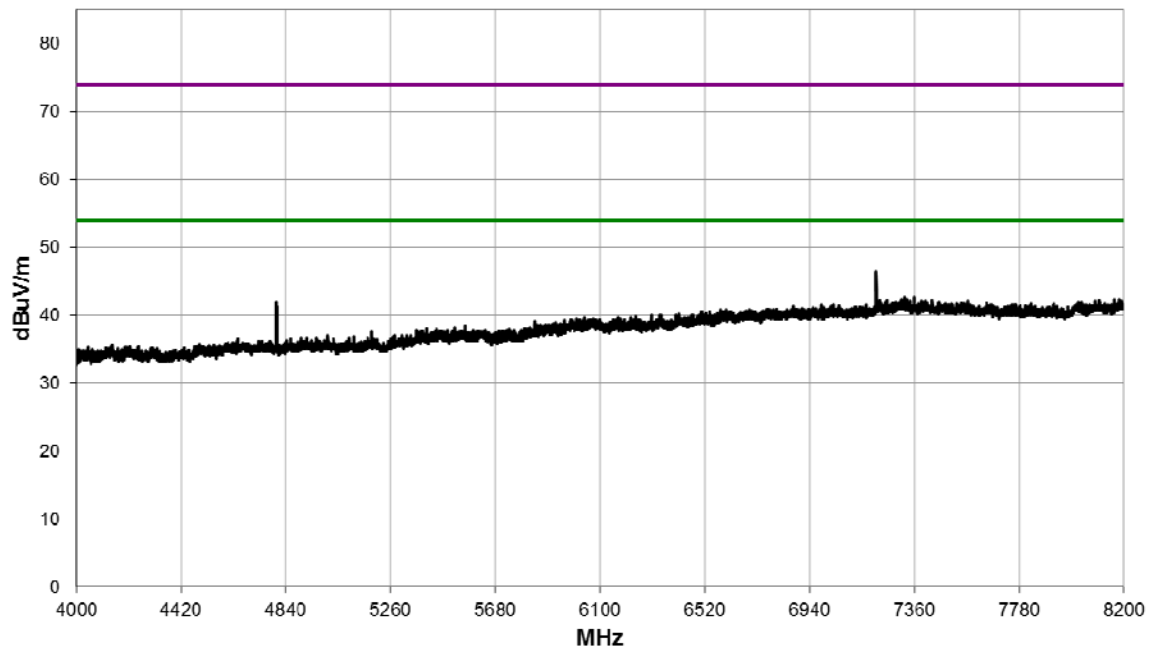

8.2 GHz to 12.4 GHz

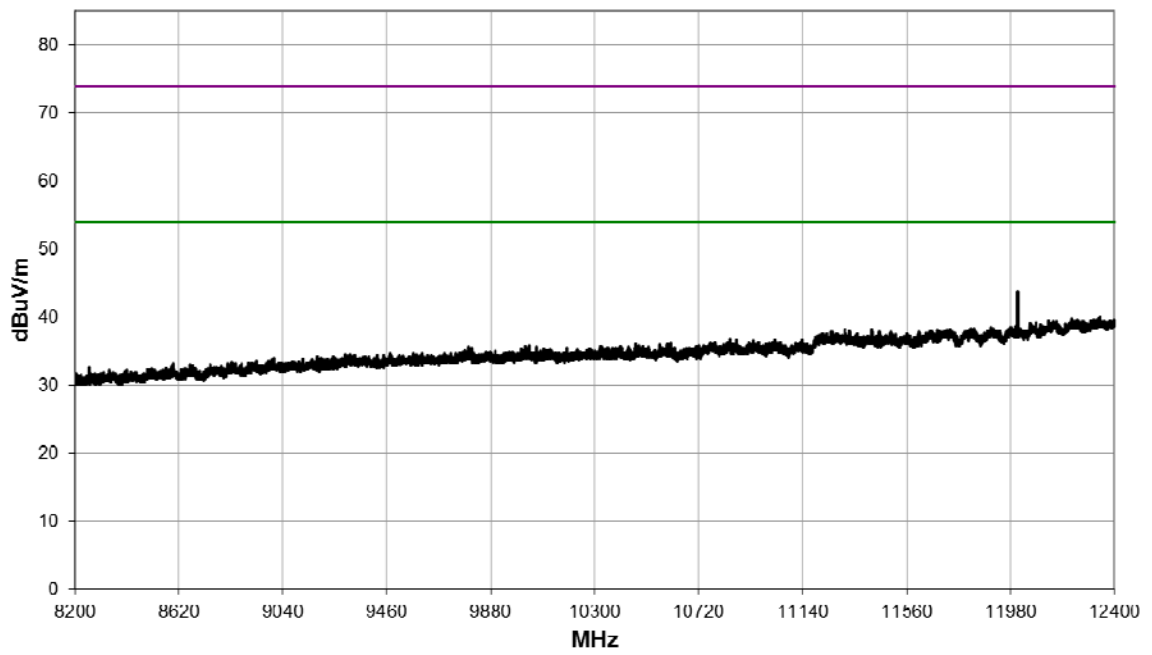

12.4 GHz 18 GHz

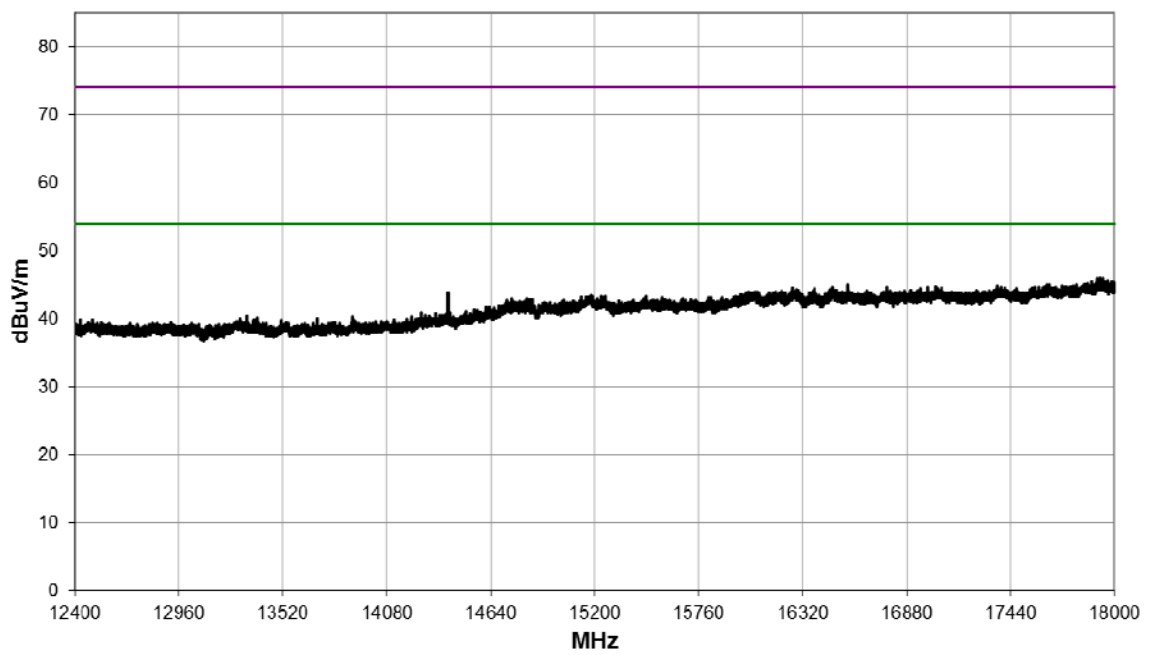

18 GHz to 26.5 GHz

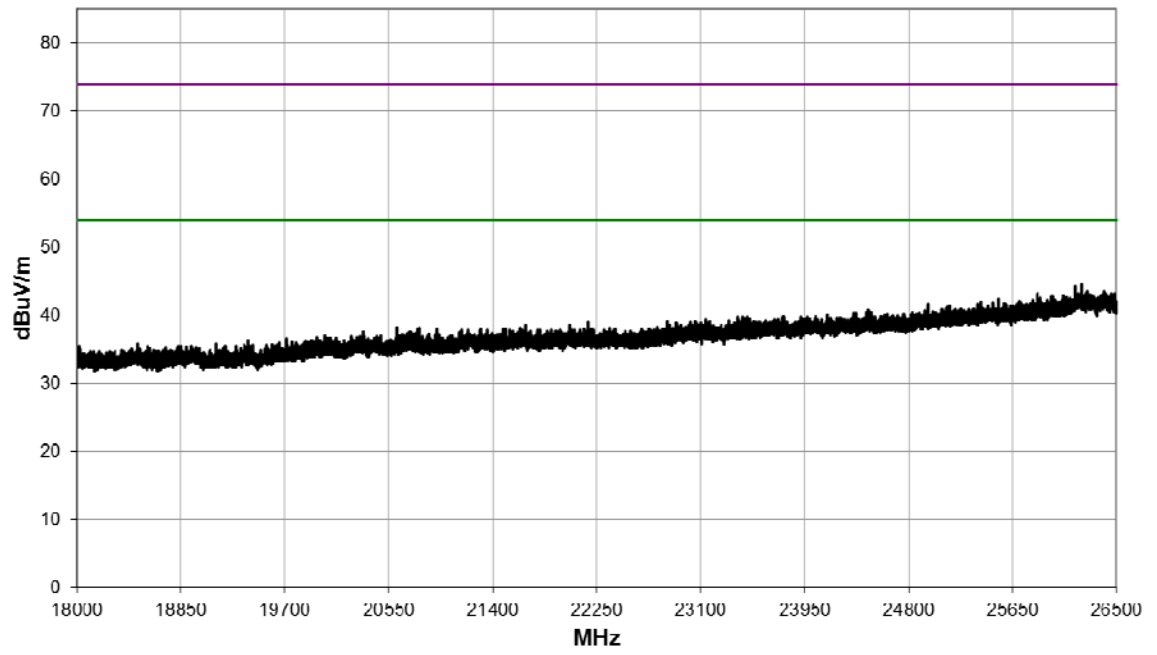

Power Setting: 126; Frequency: 2440 MHz; 125k coded								
Detector	Freq. (MHz)	Meas'd Emission (dBμV)	Factor (dB)	Duty Cycle Corr'n (dB)	Distance Extrap'n Factor (dB)	Field Strength (dBμV/m)	Field Strength (μV/m)	Limit (μV/m)
Average	4880.1	33.4	2.7	0	0	36.1	63.8	500
Peak	4879.5	45.8	2.7	0	0	48.5	266.1	5000
Average	7320.6	35.7	8.7	0	0	44.4	166.0	500
Peak	7319.2	48.1	8.7	0	0	56.8	691.8	5000
Average	12201.0	41.3	3.4	0	0	44.7	171.8	500
Peak	12201.2	54.8	3.4	0	0	58.2	812.8	5000

30 MHz to 1 GHz

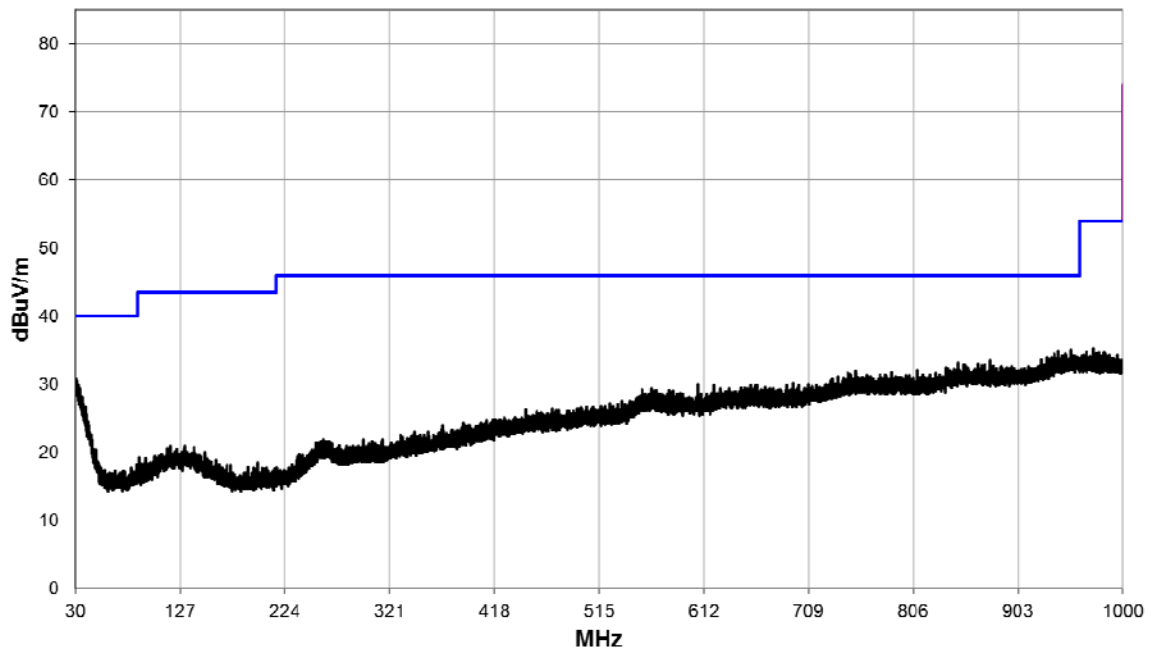

1 GHz to 4 GHz

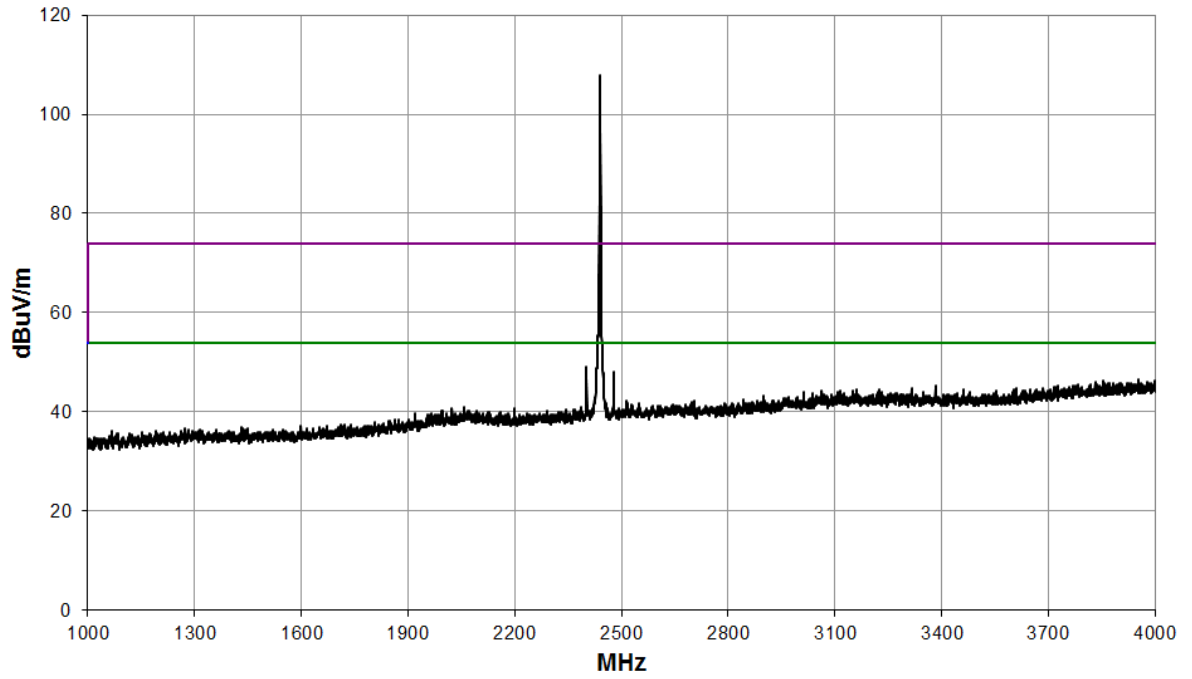

4 GHz to 8.2 GHz

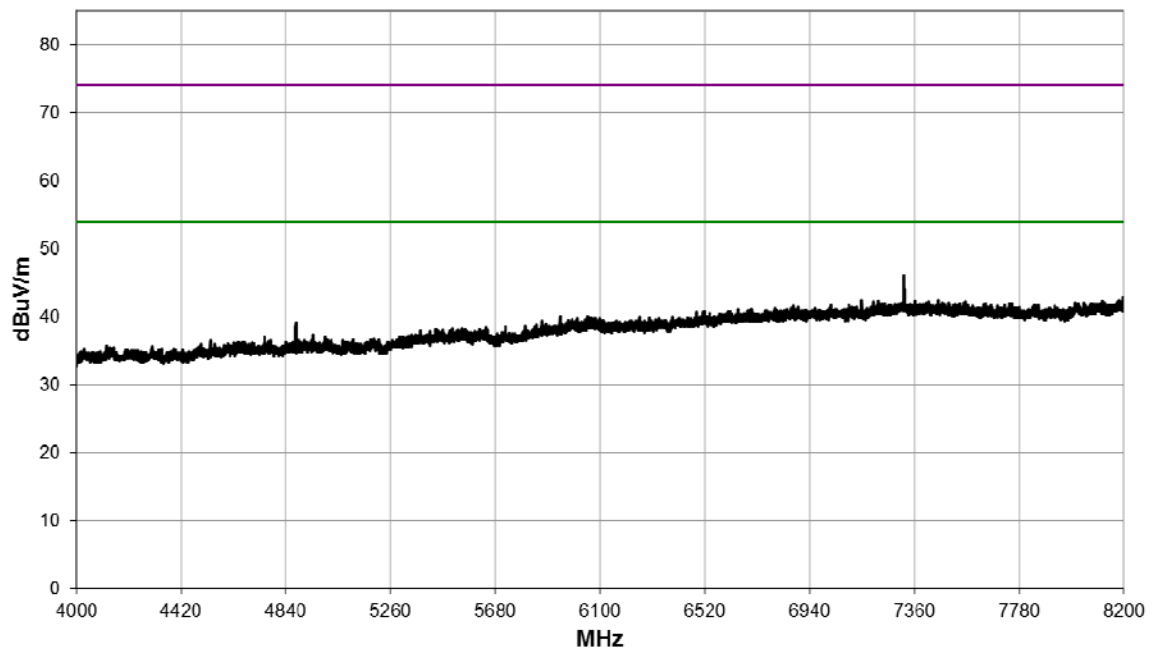

8.2 GHz to 12.4 GHz

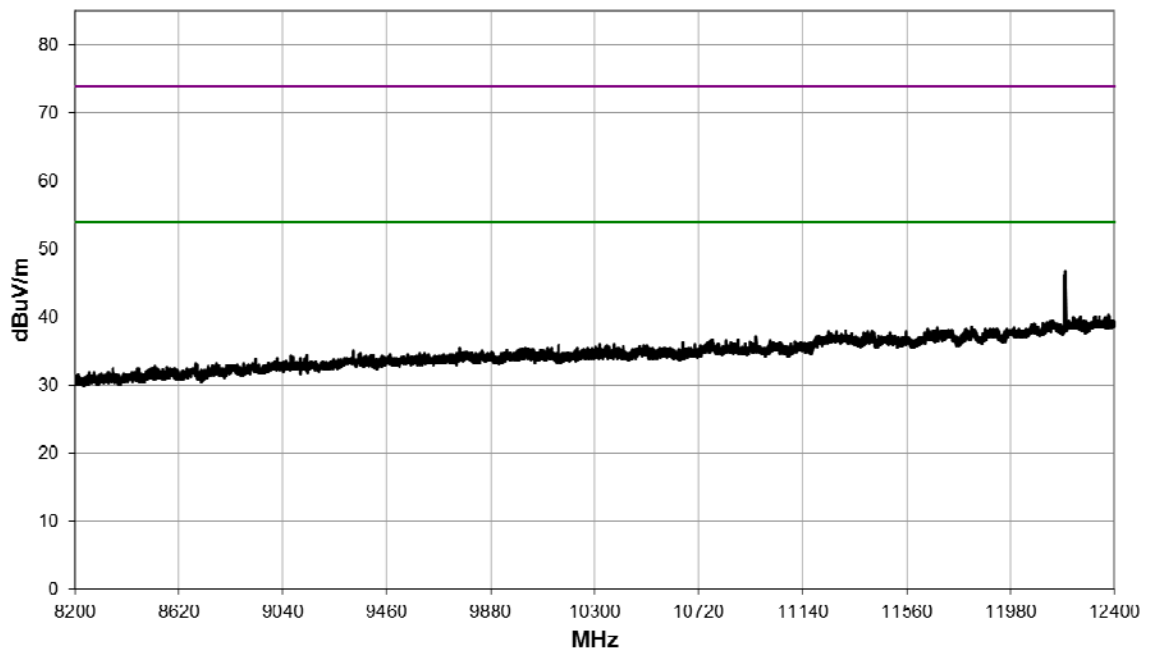

12.4 GHz 18 GHz

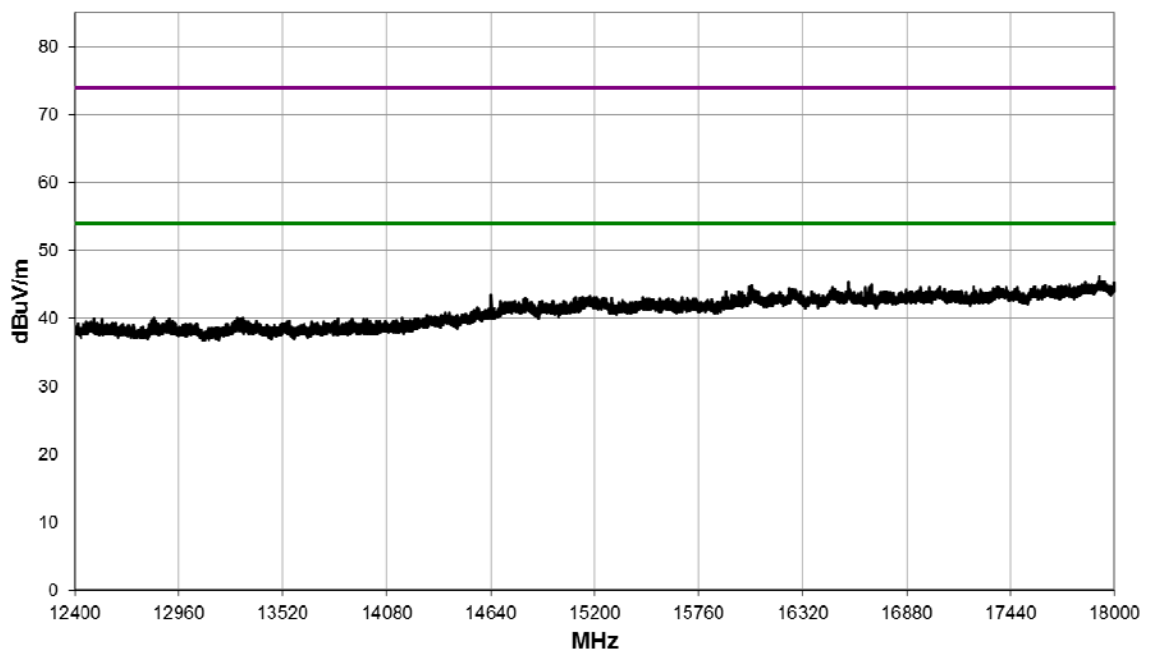

18 GHz to 26.5 GHz

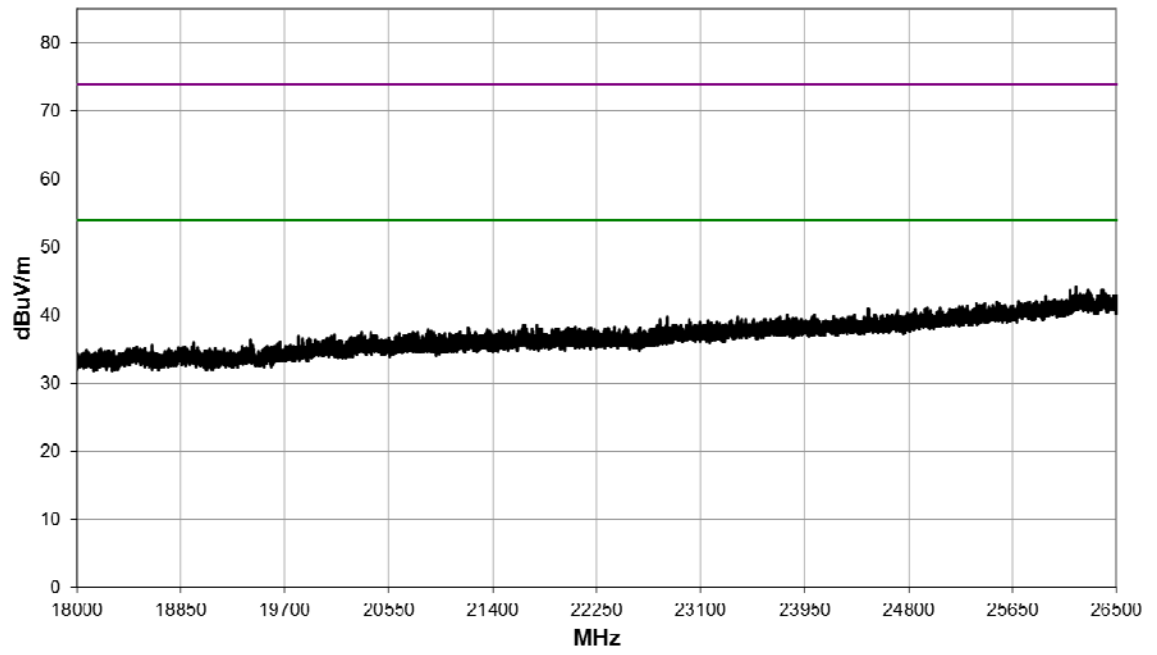

Power Setting: 126; Frequency: 2480 MHz; 125k coded								
Detector	Freq. (MHz)	Meas'd Emission (dBμV)	Factor (dB)	Duty Cycle Corr'n (dB)	Distance Extrap'n Factor (dB)	Field Strength (dBμV/m)	Field Strength (μV/m)	Limit (μV/m)
Average	4959.9	34.0	2.7	0	0	36.7	68.4	500
Peak	4959.1	46.1	2.7	0	0	48.8	275.4	5000
Average	7440.5	36.5	8.5	0	0	45.0	177.8	500
Peak	7440.7	48.9	8.5	0	0	57.4	741.3	5000
Average	12398.7	41.9	4.2	0	0	46.1	201.8	500
Peak	12398.6	55.1	4.2	0	0	59.3	922.6	5000

30 MHz to 1 GHz

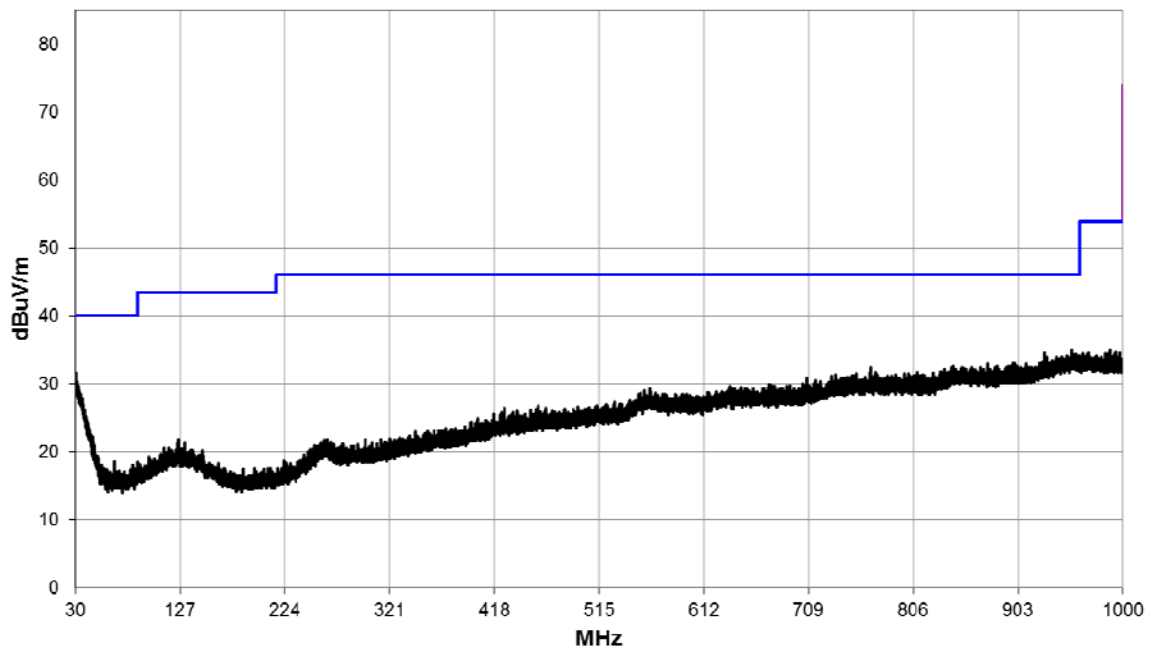

1 GHz to 4 GHz

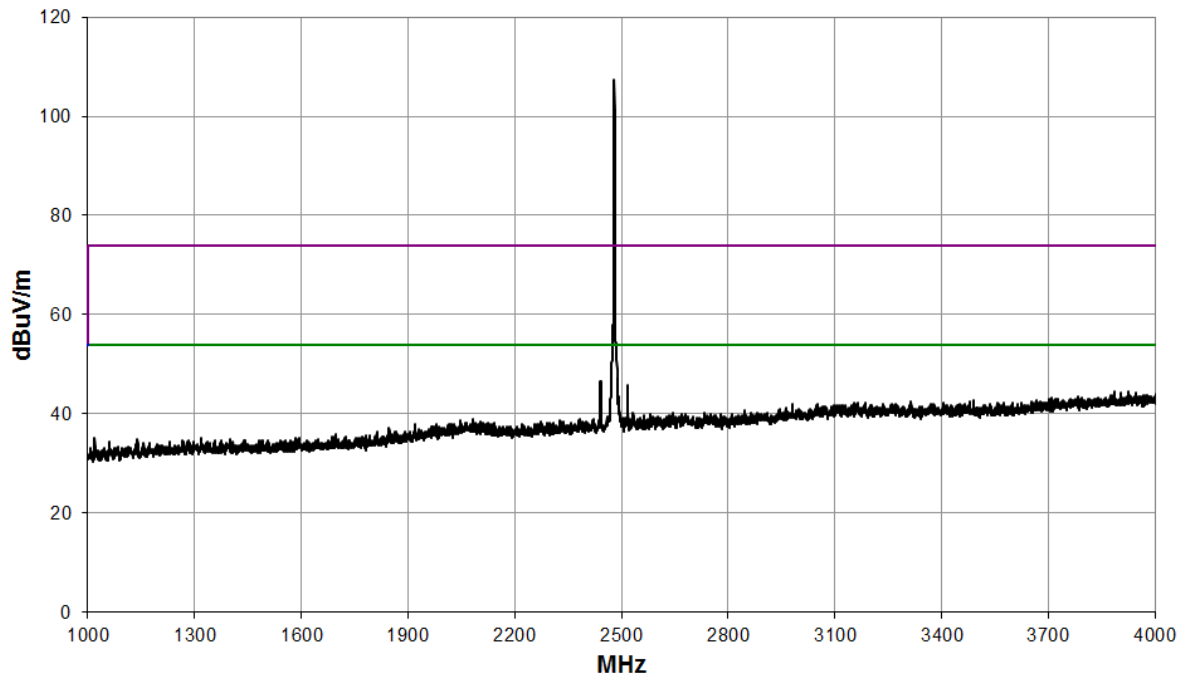

4 GHz to 8.2 GHz

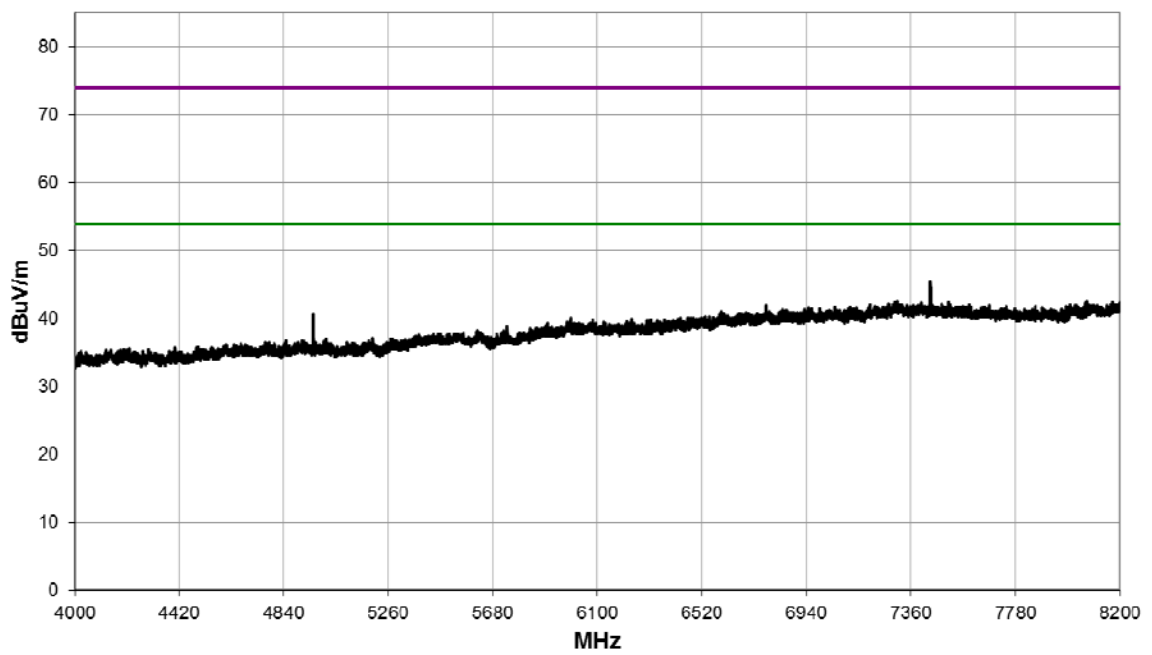

8.2 GHz to 12.4 GHz

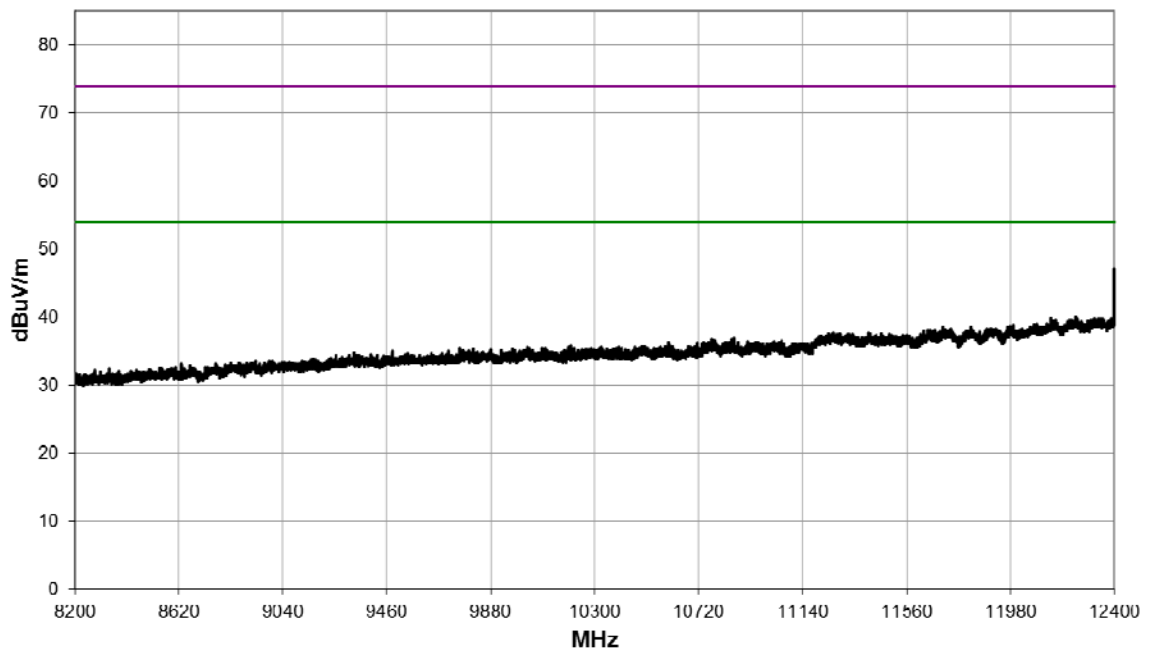

12.4 GHz 18 GHz

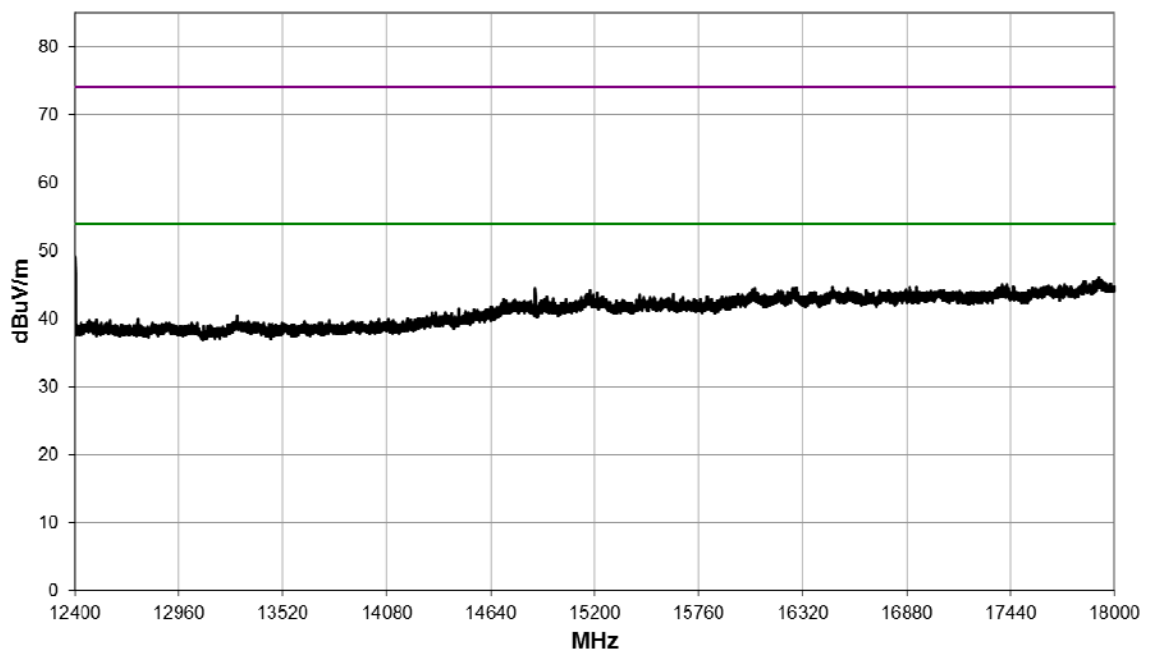

18 GHz to 26.5 GHz

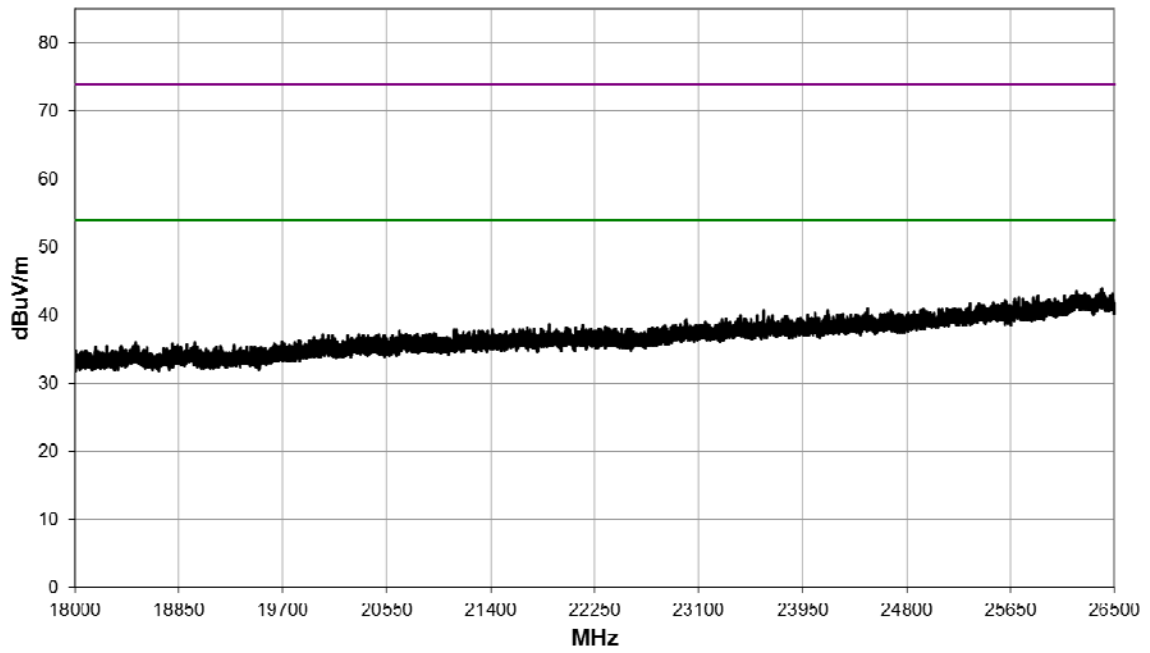

Band Edge

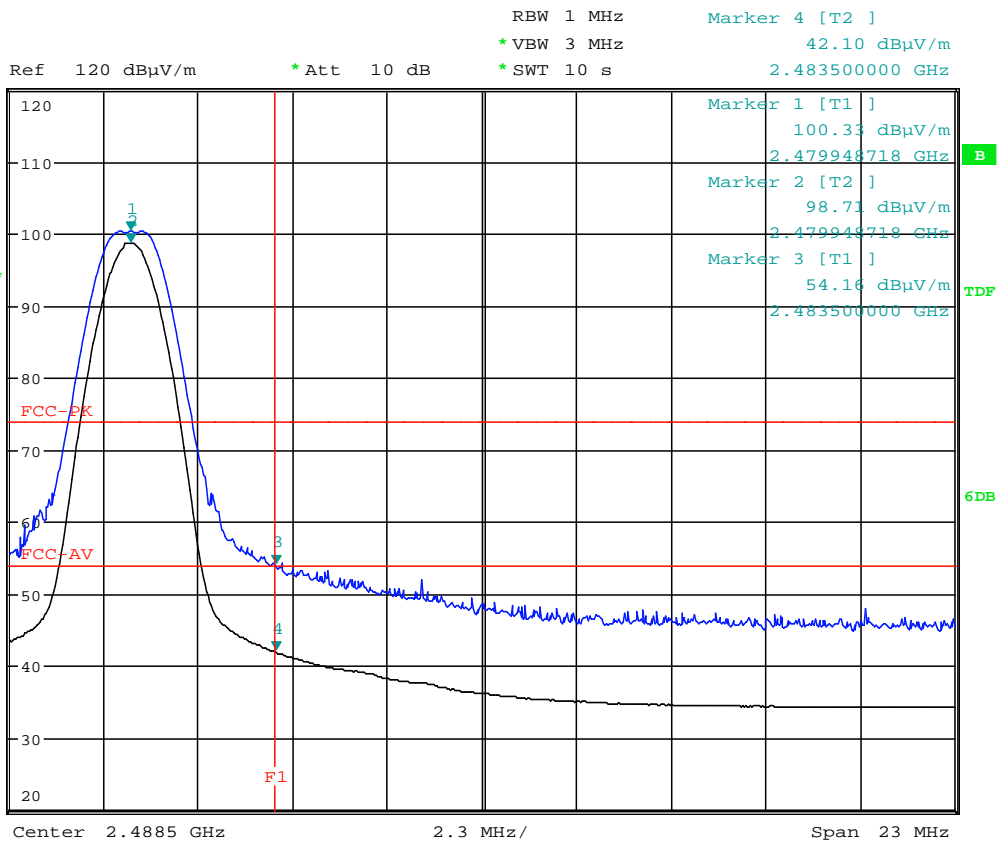

Date: 4.MAR.2019 18:43:49

Power Setting: 126; Frequency: 2402 MHz; 500k coded								
Detector	Freq. (MHz)	Meas'd Emission (dBμV)	Factor (dB)	Duty Cycle Corr'n (dB)	Distance Extrap'n Factor (dB)	Field Strength (dBμV/m)	Field Strength (μV/m)	Limit (μV/m)
Average	2363.6	43.3	-3.5	0	0	39.8	97.7	500
Peak	2363.5	50.9	-3.5	0	0	47.4	234.4	5000
Average	4803.9	37.4	2.6	0	0	40.0	100.0	500
Peak	4803.4	48.0	2.6	0	0	50.6	338.8	5000
Average	12008.7	38.9	2.7	0	0	41.6	120.2	500
Peak	12009.9	52.0	2.7	0	0	54.7	543.3	5000

30 MHz to 1 GHz

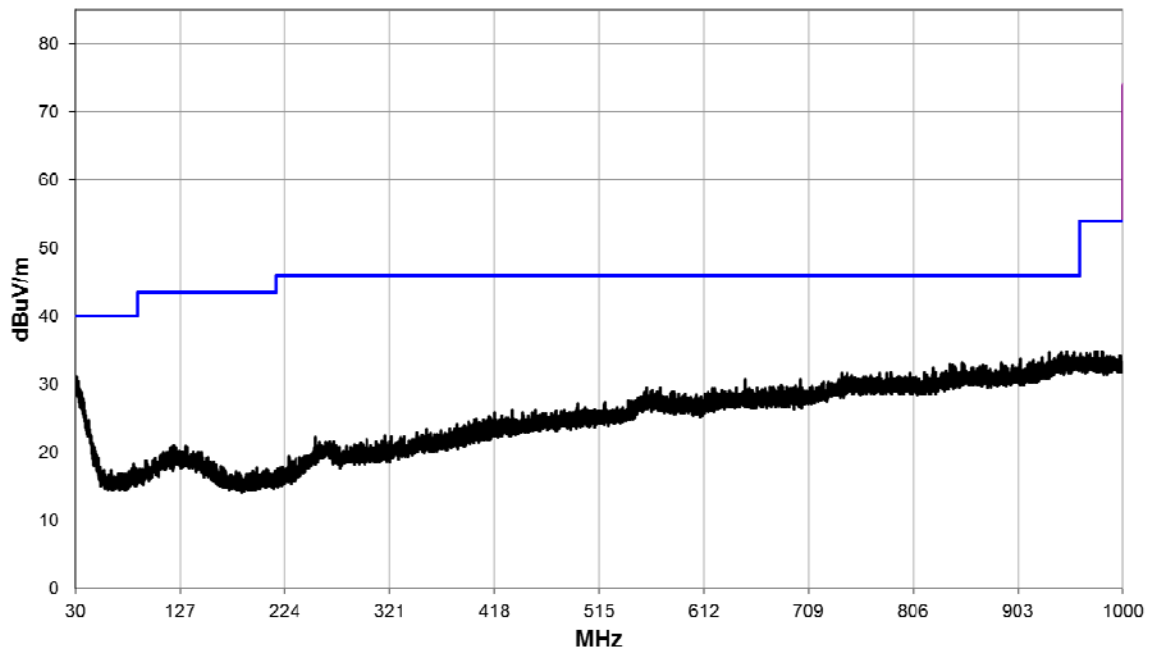

1 GHz to 4 GHz

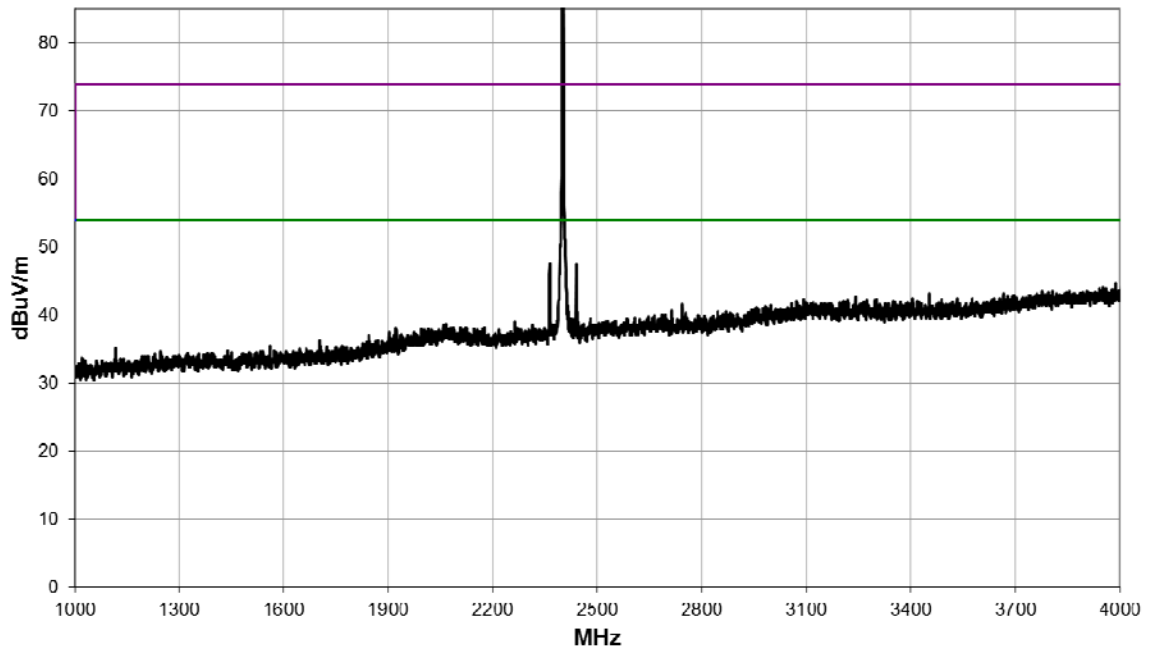

4 GHz to 8.2 GHz

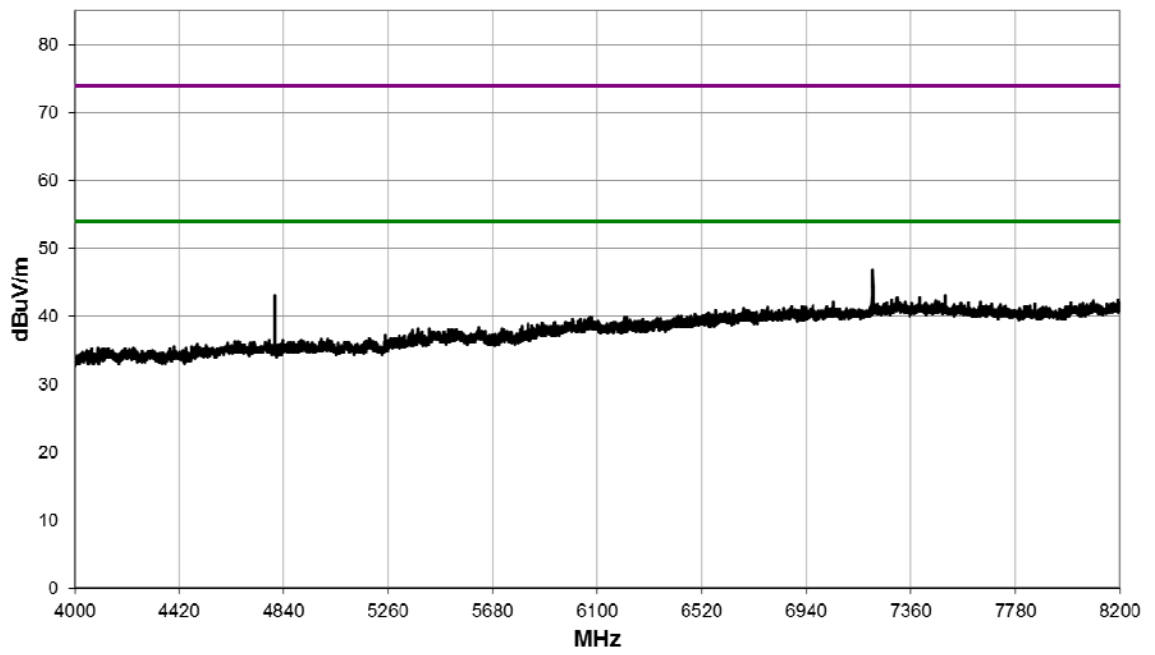

8.2 GHz to 12.4 GHz

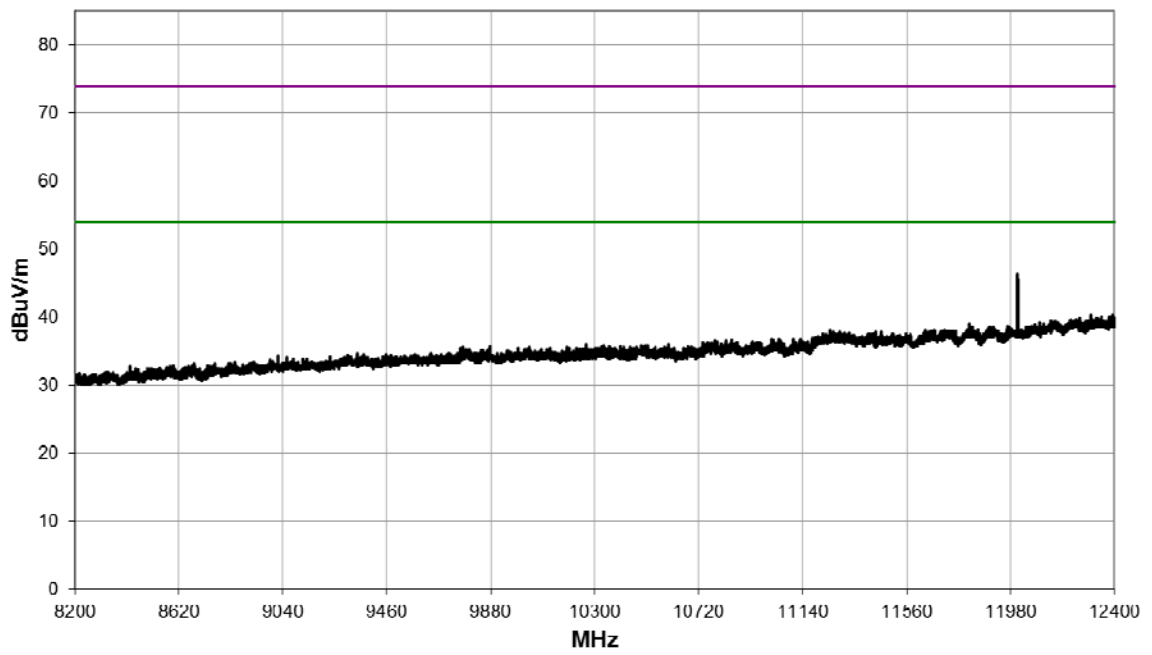

12.4 GHz 18 GHz

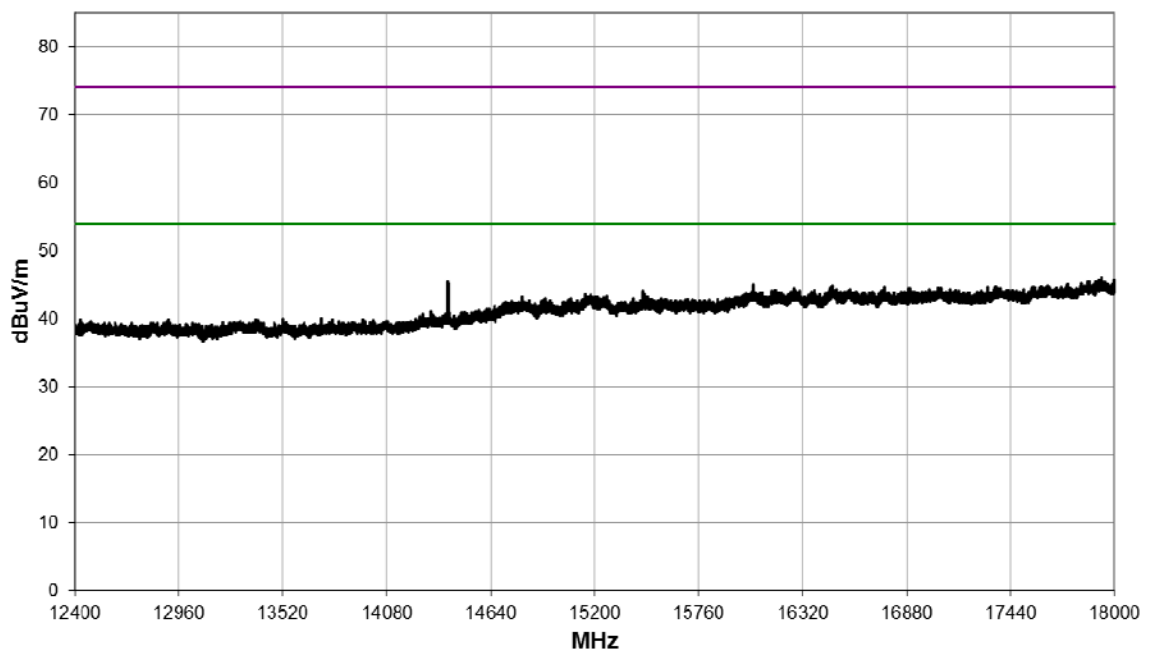

18 GHz to 26.5 GHz

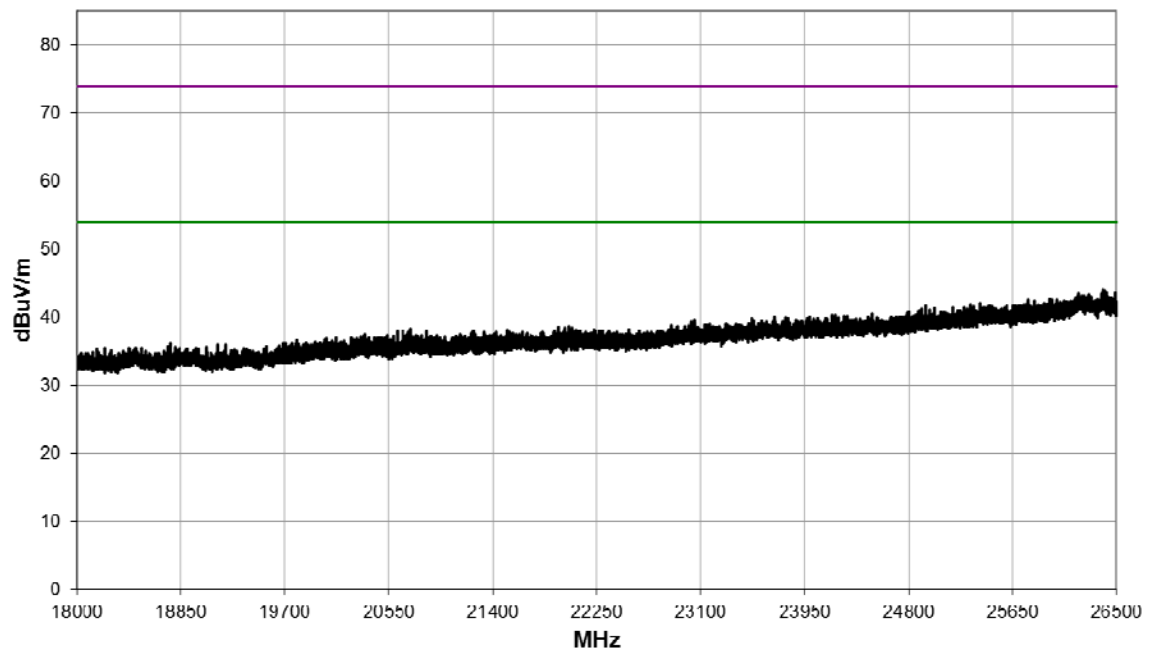

Power Setting: 121; Channel: 11; Frequency: 2405 MHz								
Detector	Freq. (MHz)	Meas'd Emission (dBμV)	Factor (dB)	Duty Cycle Corr'n (dB)	Distance Extrap'n Factor (dB)	Field Strength (dBμV/m)	Field Strength (μV/m)	Limit (μV/m)
Average	4880.0	32.8	2.7	0	0	35.5	59.6	500
Peak	4879.5	45.4	2.7	0	0	48.1	254.1	5000
Average	7320.5	34.0	8.7	0	0	42.7	136.5	500
Peak	7320.7	47.0	8.7	0	0	55.7	609.5	5000
Average	12198.8	41.2	3.2	0	0	44.4	166.0	500
Peak	12198.7	54.6	3.2	0	0	57.8	776.3	5000

30 MHz to 1 GHz

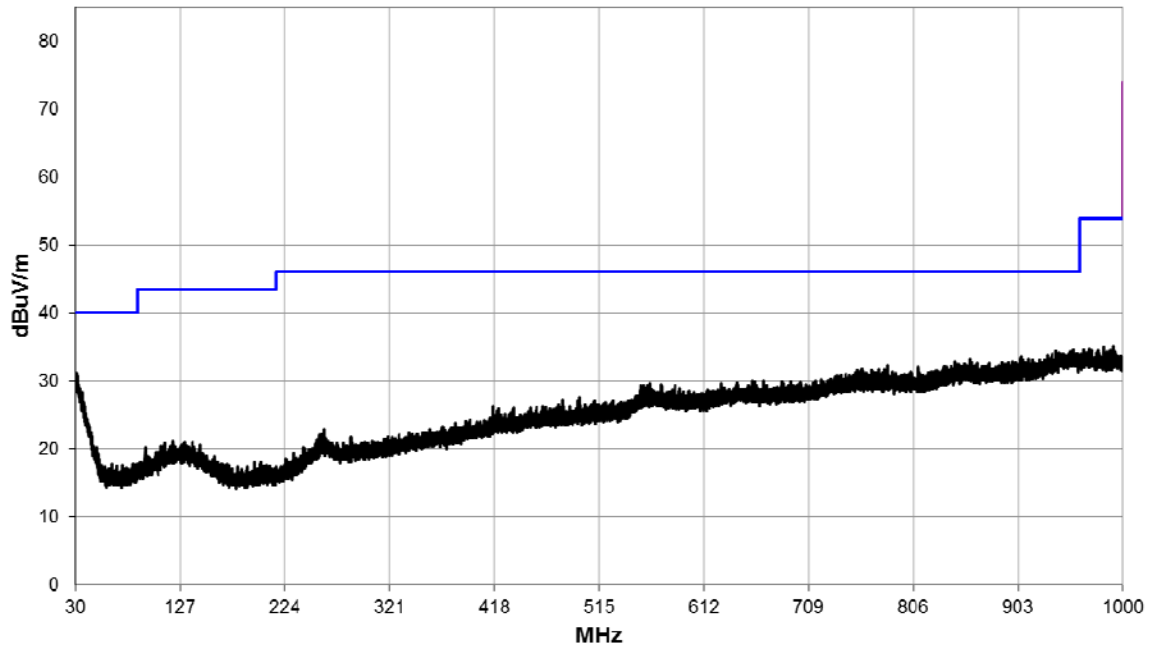

1 GHz to 4 GHz

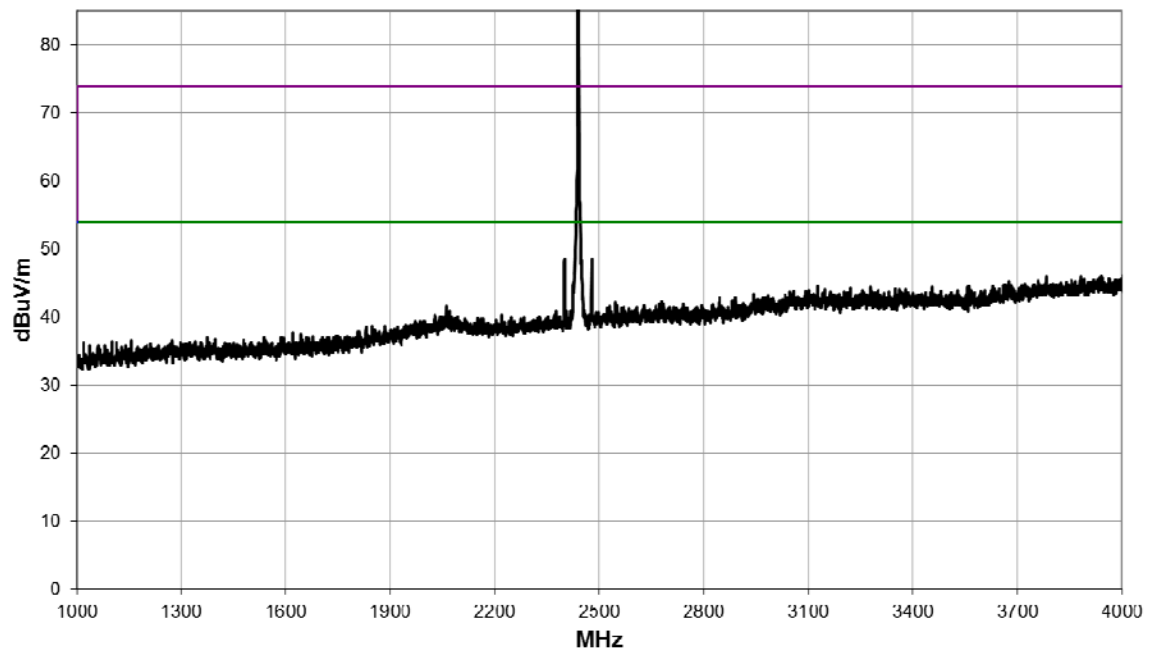

4 GHz to 8.2 GHz

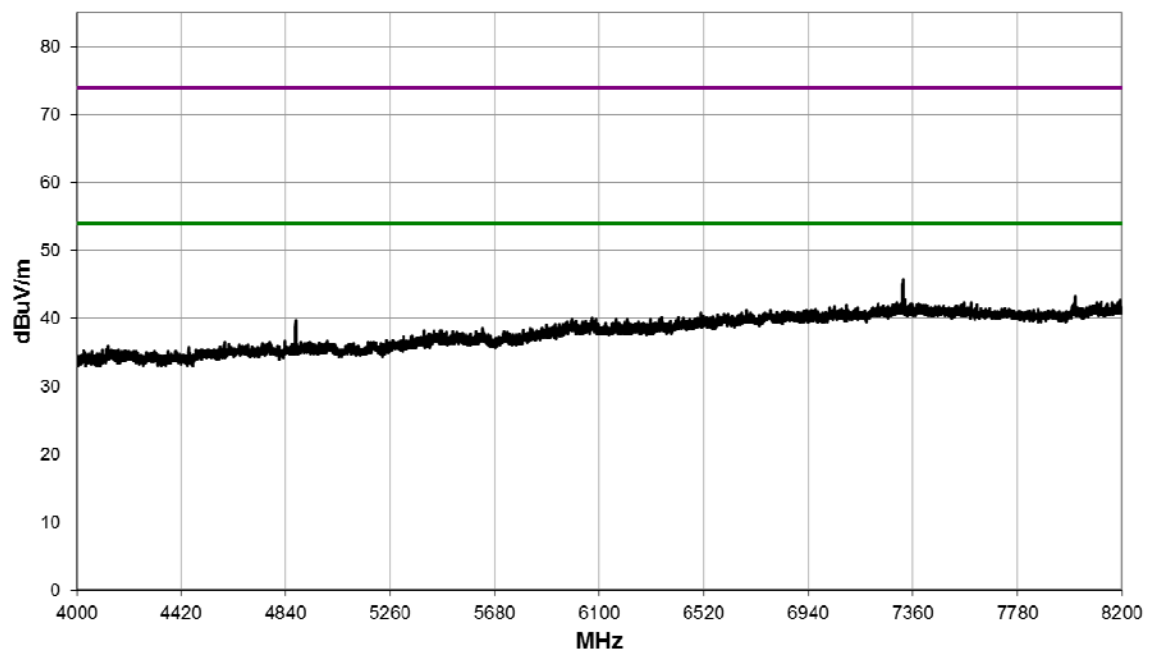

8.2 GHz to 12.4 GHz

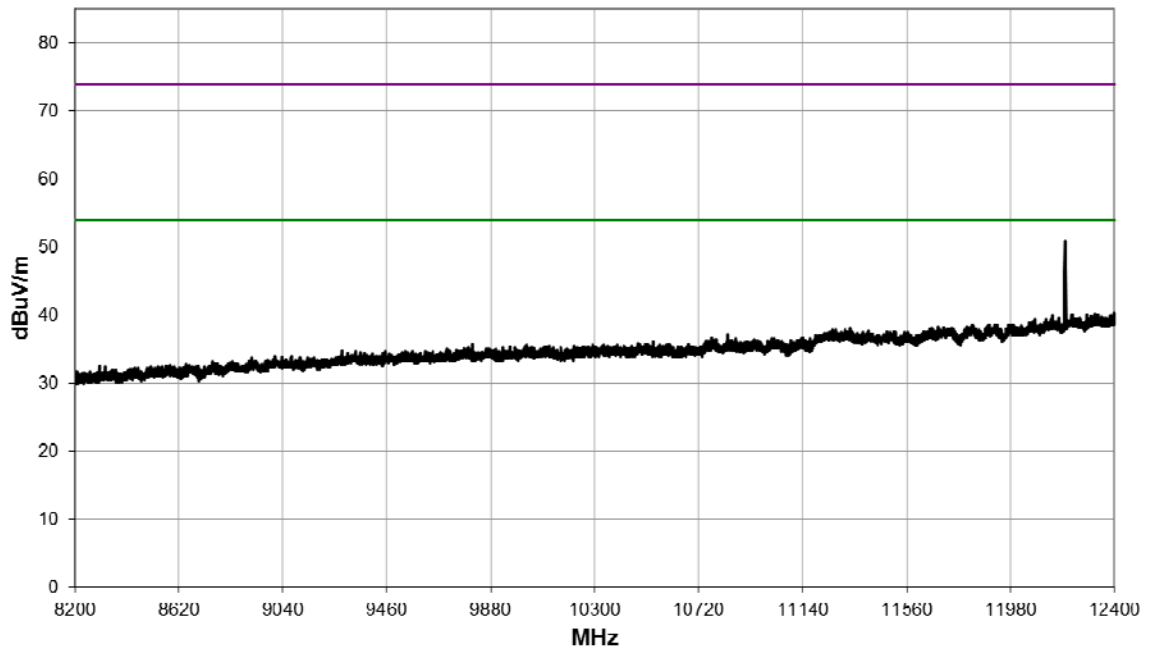

12.4 GHz 18 GHz

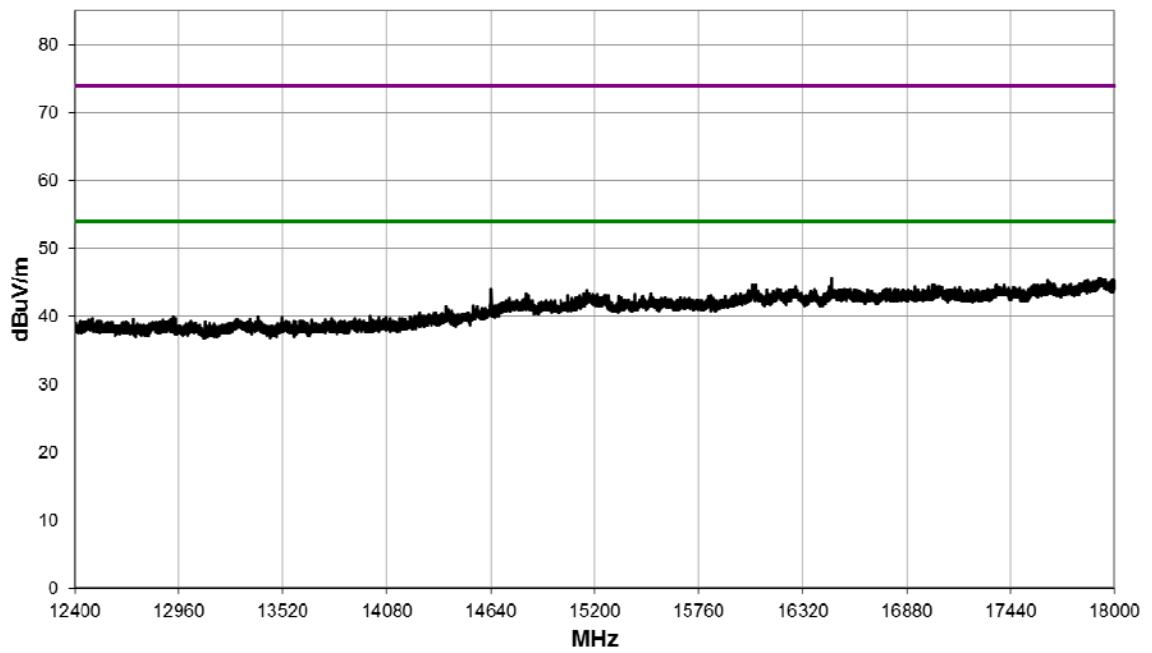

18 GHz to 26.5 GHz

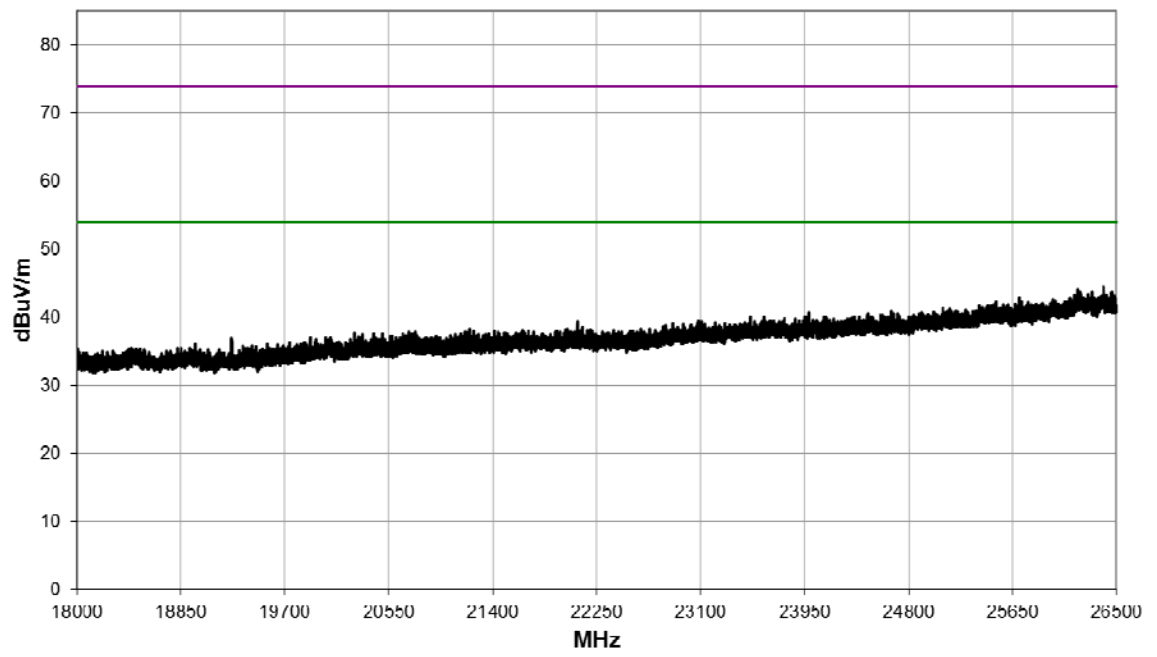

Power Setting: 121; Channel: 11; Frequency: 2405 MHz								
Detector	Freq. (MHz)	Meas'd Emission (dBμV)	Factor (dB)	Duty Cycle Corr'n (dB)	Distance Extrap'n Factor (dB)	Field Strength (dBμV/m)	Field Strength (μV/m)	Limit (μV/m)
Average	4959.9	35.3	2.7	0	0	38.0	79.4	500
Peak	4960.5	46.4	2.7	0	0	49.1	285.1	5000
Average	7440.5	36.6	8.5	0	0	45.1	179.9	500
Peak	7440.6	48.9	8.5	0	0	57.4	741.3	5000
Average	12398.8	41.9	4.2	0	0	46.1	201.8	500
Peak	12398.5	55.3	4.2	0	0	59.5	944.1	5000

30 MHz to 1 GHz

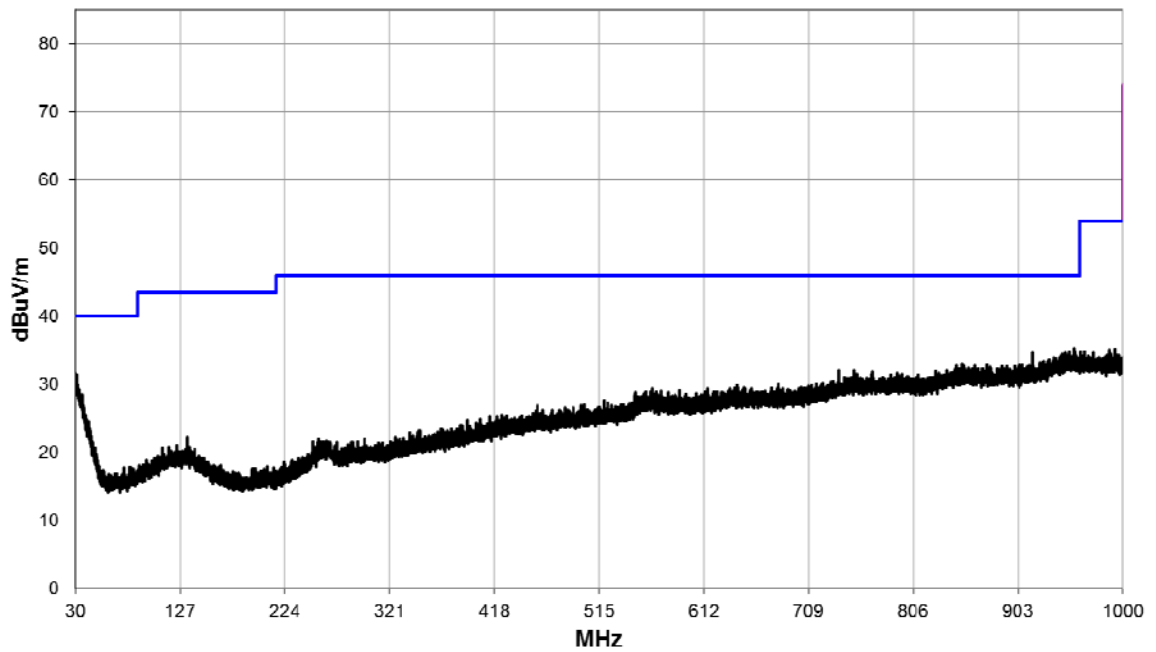

1 GHz to 4 GHz

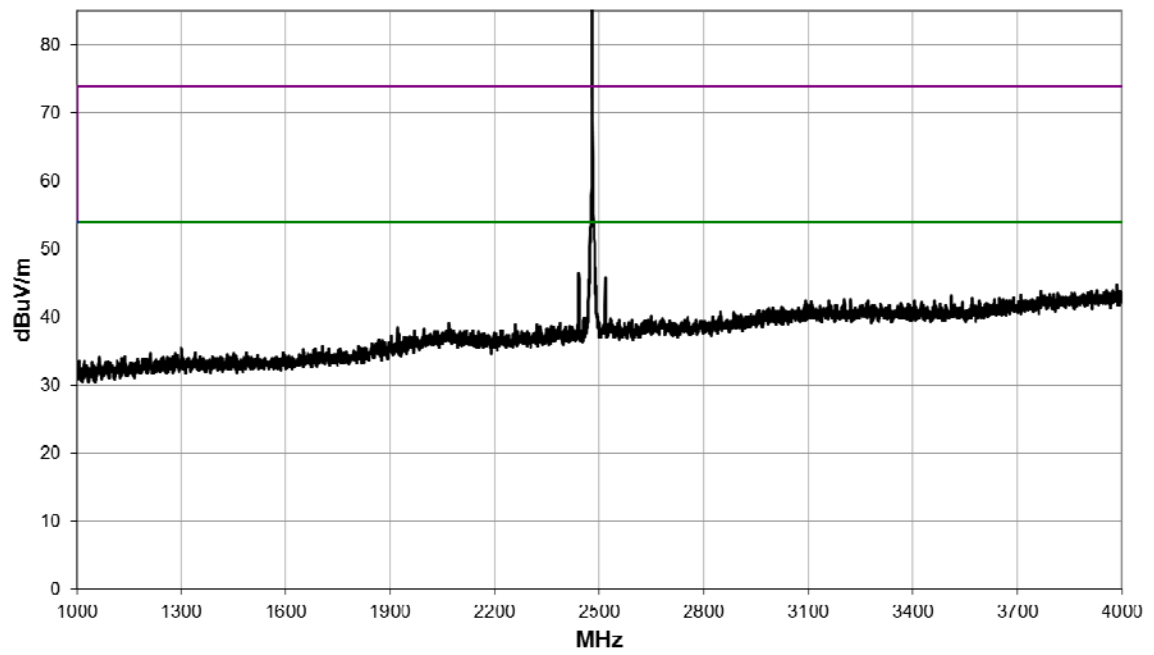

4 GHz to 8.2 GHz

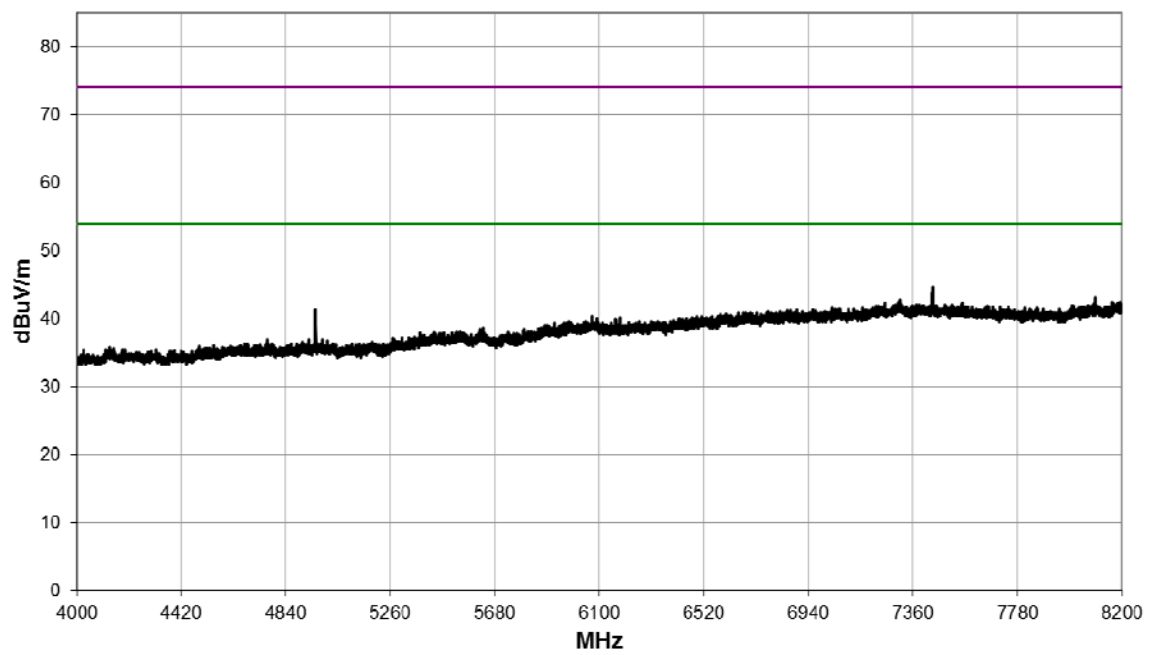

8.2 GHz to 12.4 GHz

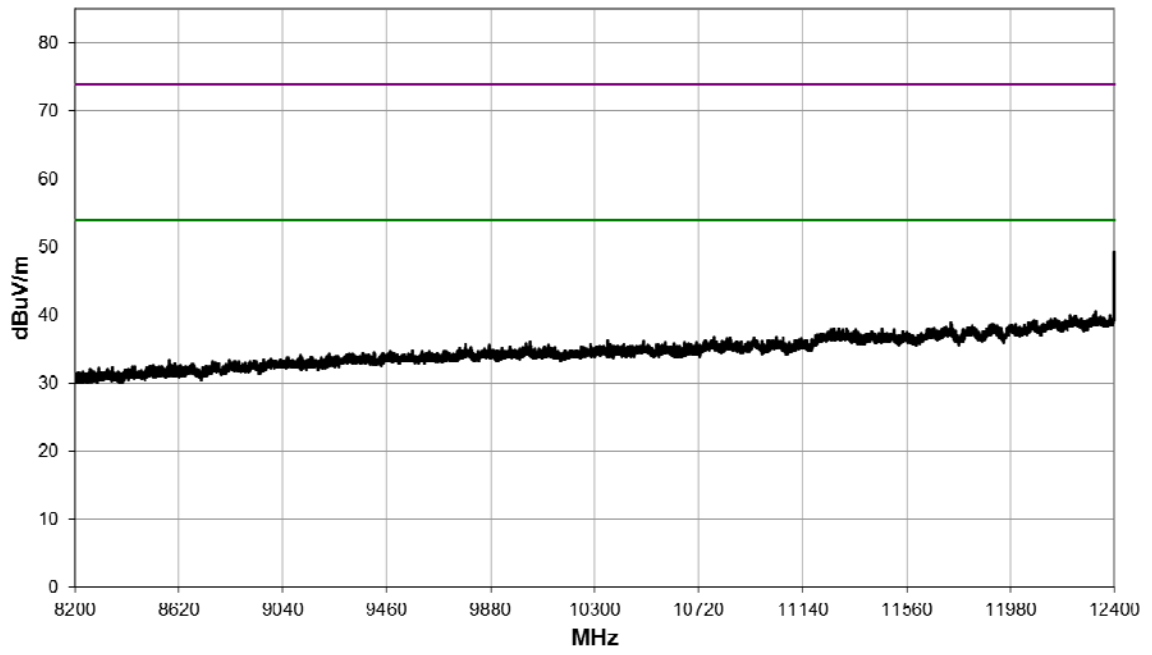

12.4 GHz 18 GHz

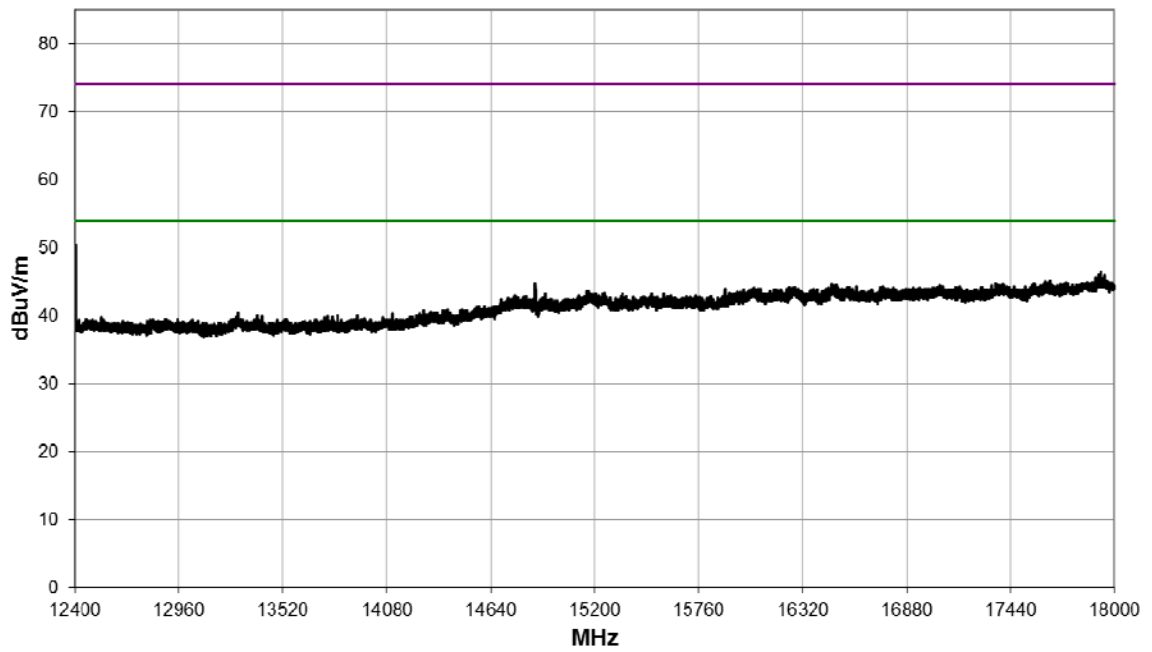

18 GHz to 26.5 GHz

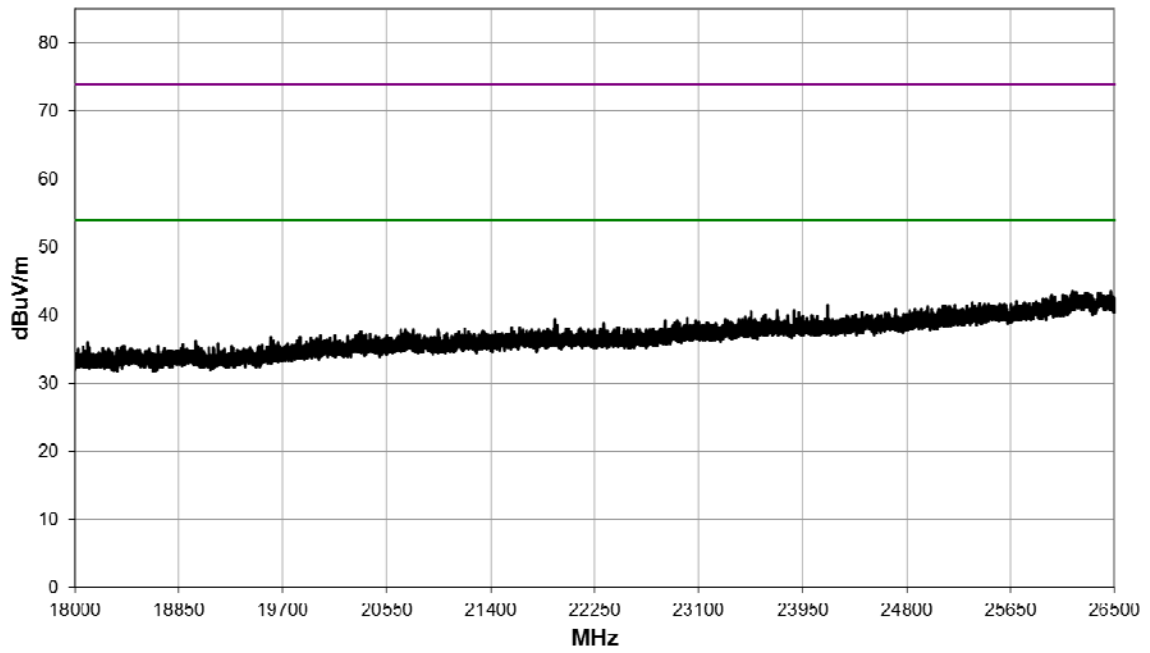

Band Edge

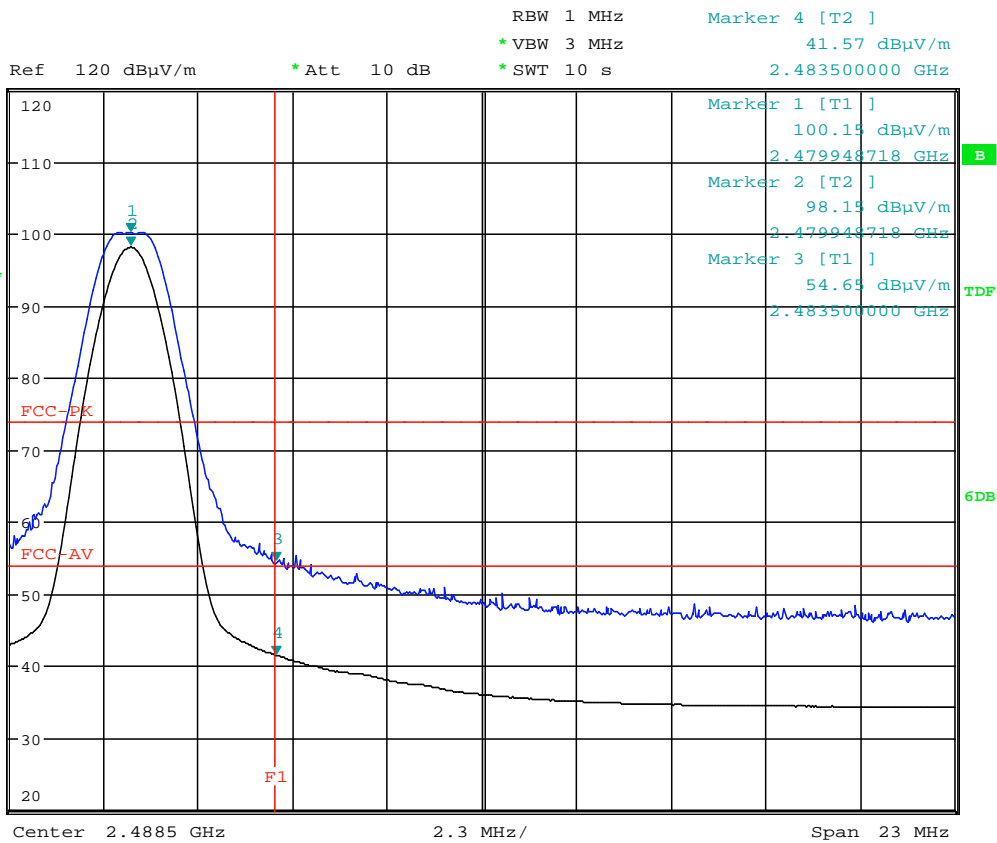

Date: 4.MAR.2019 19:00:45

12 AC power-line conducted emissions

12.1 Definition

Line-to-ground radio-noise voltage that is conducted from all of the EUT current-carrying power input terminals that are directly (or indirectly via separate transformers or power supplies) connected to a public power network.

12.2 Test Parameters

Test Location:	Element Hull
Test Chamber:	Screen Room 2
Test Standard and Clause:	ANSI C63.10-2013, Clause 6.2
EUT Frequency Measured:	2442 MHz
Deviations From Standard:	None
Measurement Detectors:	Quasi-Peak and Average

Environmental Conditions (Normal Environment)

Temperature: 21 °C	+15 °C to +35 °C (as declared)
Humidity: 27 % RH	20 % RH to 75 % RH (as declared)

12.3 Test Limit

A radio apparatus that is designed to be connected to the public utility (AC) power line shall ensure that the radio frequency voltage, which is conducted back onto the AC power line on any frequency or frequencies within the band 150 kHz to 30 MHz, shall not exceed the limits in Table 3.

Table 3 – AC Power Line Conducted Emission Limits

Frequency (MHz)	Conducted limit (dB μ V)	
	Quasi-Peak	Average**
0.15 to 0.5	66 to 56*	56 to 46*
0.5 to 5	56	46
5 to 30	60	50

*The level decreases linearly with the logarithm of the frequency.

**A linear average detector is required.

12.4 Test Method

With the EUT setup in a screened room, and connected as per Figure ii, the power line emissions were measured on a spectrum analyzer / EMI receiver.

AC power line conducted emissions from the EUT are checked first by preview scans with peak and average detectors covering both live and neutral lines. A spectrum analyzer is used to determine if any periodic emissions are present.

Formal measurements using the correct detector(s) and bandwidth are made on frequencies identified from the preview scans. Final measurements were performed with EUT set at its maximum duty in transmit and receive modes.

Figure ii Test Setup

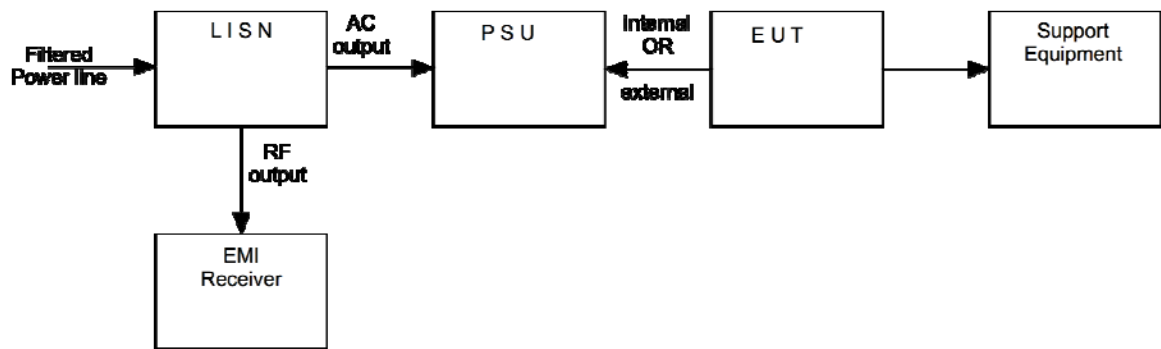

12.5 Test Set-up Photograph



12.6 Test Equipment

<i>Equipment Description</i>	<i>Manufacturer</i>	<i>Equipment Type</i>	<i>Element No</i>	<i>Due For Calibration</i>
ESCI7	R&S	Measuring Receiver	RFG715	2019-11-16
ESH3-Z5	R&S	LISN	RFG732	2019-05-22
ESH3-Z2	R&S	Pulse Limiter	RFG674	2019-04-06

12.7 Test Results

AC power-line conducted emissions, Transmit mode						
Results measured using the average detector						
Reference Number	Frequency (MHz)	Conductor	Result (dBuV)	Specification Limit (dBuV)	Margin (dB)	Result Summary
1	0.150	L1	-2.2	56.0	58.2	PASS
2	0.296	N	12.4	50.4	38.0	PASS
3	0.393	N	-0.4	48.0	48.4	PASS
4	1.466	L1	-3.5	46.0	49.5	PASS
5	8.167	L1	-3.1	50.0	53.1	PASS
6	27.619	L1	-2.5	50.0	52.5	PASS

Results measured using the quasi-peak detector						
Reference Number	Frequency (MHz)	Conductor	Result (dBuV)	Specification Limit (dBuV)	Margin (dB)	Result Summary
1	0.150	L1	0.9	66.0	65.1	PASS
2	0.296	N	14.0	60.4	46.4	PASS
3	0.393	N	14.6	58.0	43.4	PASS
4	1.466	L1	1.2	56.0	54.8	PASS
5	8.167	L1	1.8	60.0	58.2	PASS
6	27.619	L1	2.4	60.0	57.6	PASS

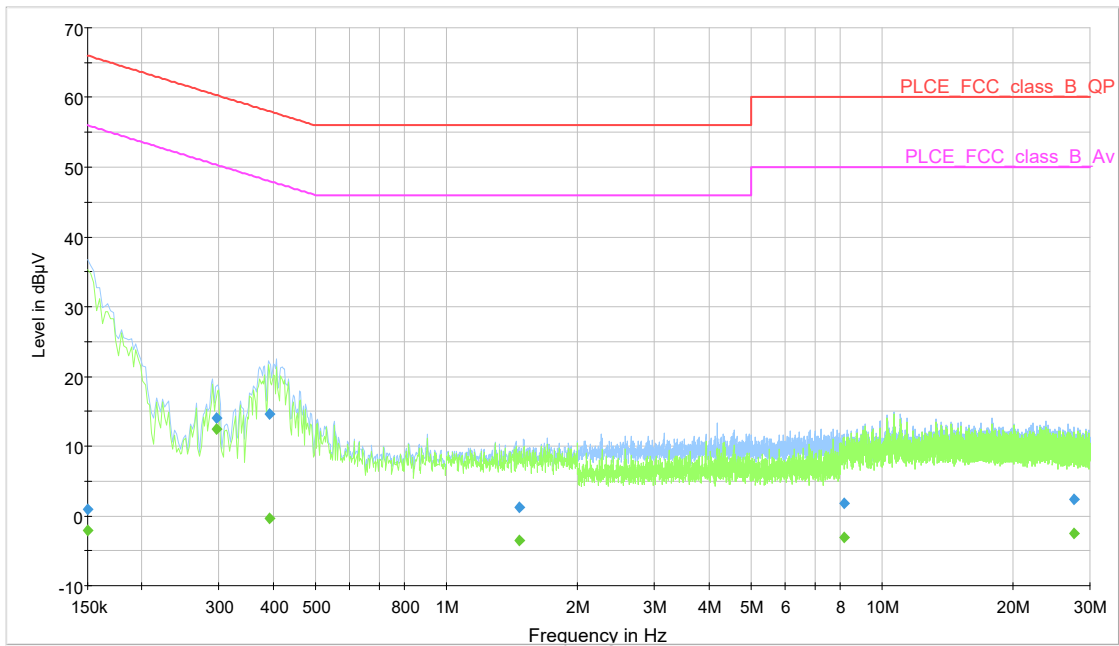

13 Occupied Bandwidth

13.1 Definition

The emission bandwidth (x dB) is defined as the frequency range between two points, one above and one below the carrier frequency, at which the spectral density of the emission is attenuated x dB below the maximum in-band spectral density of the modulated signal.

13.2 Test Parameters

Test Location:	Element Hull
Test Chamber:	Wireless Laboratory 1
Test Standard and Clause:	FCC: ANSI C63.10-2013, Clause 11.8
EUT Frequencies Measured:	2402 MHz / 2442 MHz / 2480 MHz
EUT Channel Bandwidths:	1 MHz (or 2 MHz for 2M mode)
EUT Test Modulations:	1M, 2M, 125k Coded and 500k Coded
Deviations From Standard:	None
Measurement BW: (FCC requirement: 100 kHz)	100 kHz
Spectrum Analyzer Video BW: (requirement at least 3x RBW)	300 kHz
Measurement Span: (requirement 2 to 5 times OBW)	2 MHz (3MHz for 2M)
Measurement Detector:	Peak

Environmental Conditions (Normal Environment)

Temperature: 23 °C	+15 °C to +35 °C (as declared)
Humidity: 32 % RH	20 % RH to 75 % RH (as declared)
Supply: 3.3 V dc	

13.3 Test Limit

The minimum -6 dB bandwidth shall be at least 500 kHz.

13.4 Test Method

With the EUT setup as per section 9 of this report and connected as per Figure iii, the bandwidth of the EUT was measured on a spectrum analyser.

The measurements were performed with EUT set at its maximum duty. All modulation schemes, data rates and power settings were used to observe the worst-case configuration in each bandwidth.

Figure iii Test Setup

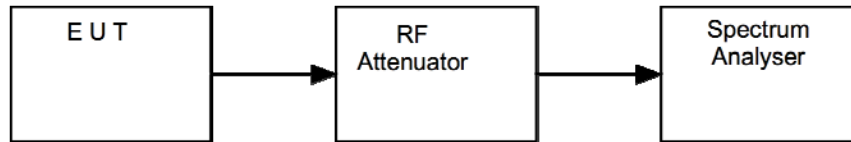

13.5 Test Equipment

Equipment Type	Manufacturer	Equipment Description	Element No	Due For Calibration
FSU46	R&S	Spectrum Analyser	U281	2019-11-20

13.6 Test Results

FCC 15.247. Modulation: BTLE; Data rate: 1M; Power setting: 126				
Channel Frequency (MHz)	F_L (MHz)	F_H (MHz)	6dB Bandwidth (kHz)	Result
2402	2401.628205	2402.272436	644.230769230	PASS
2442	2441.625000	2442.266026	641.025641026	PASS
2480	2479.625000	2480.266026	641.025641026	PASS

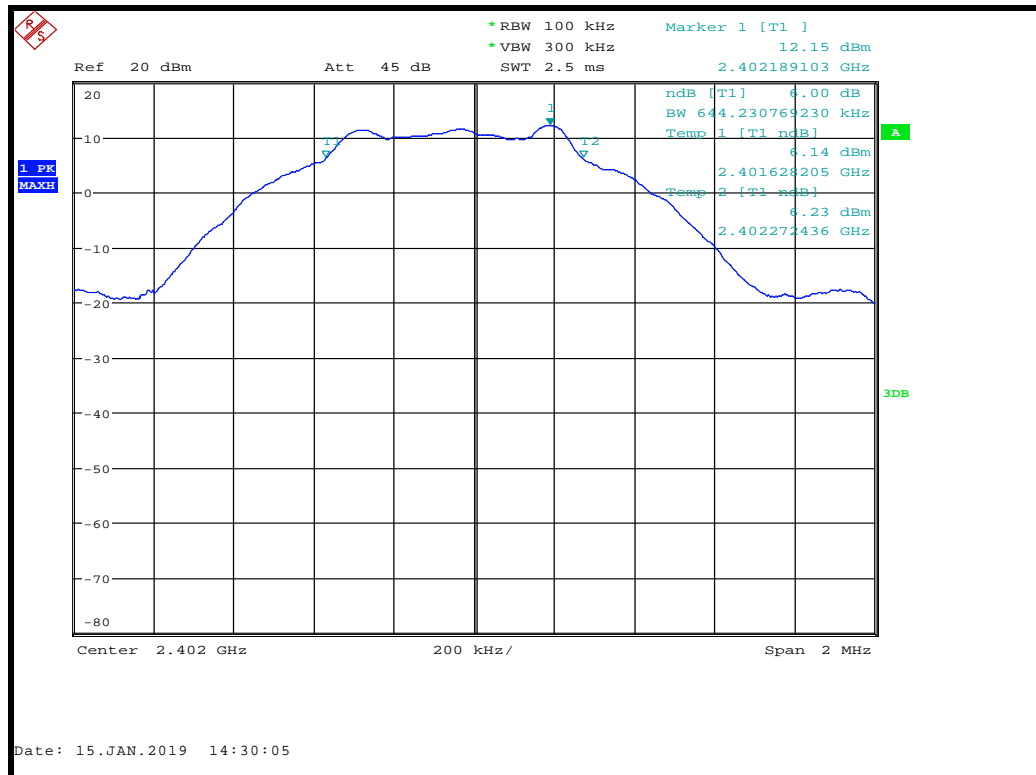

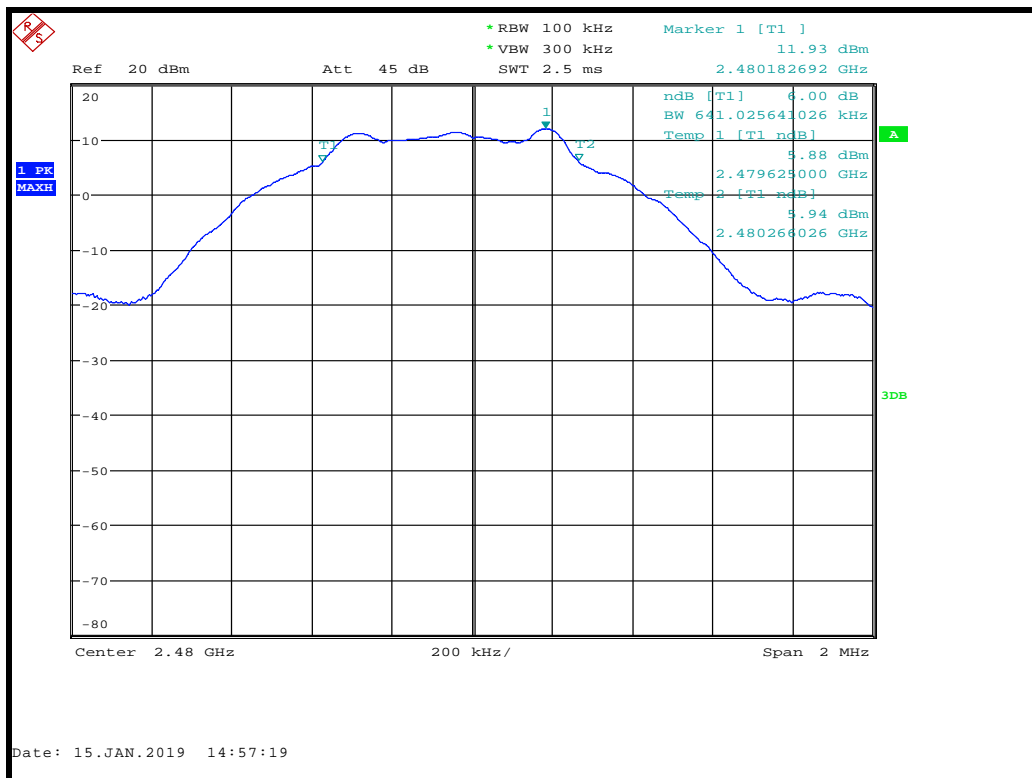
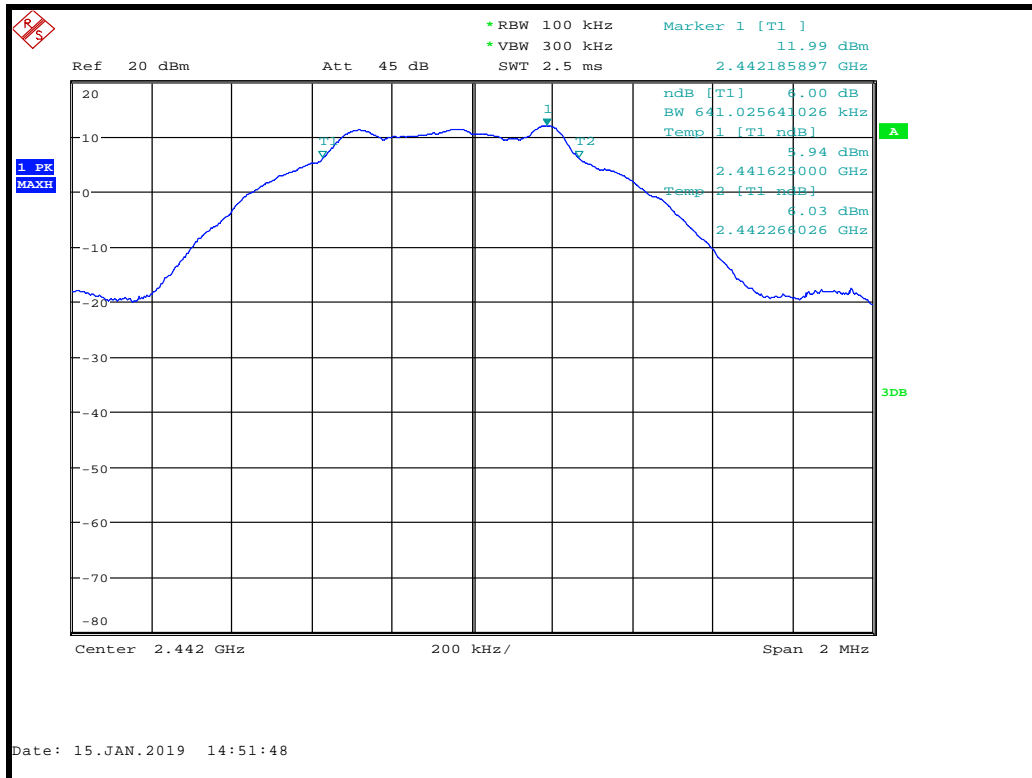

FCC 15.247. Modulation: BTLE; Data rate: 2M; Power setting: 126				
Channel Frequency (MHz)	F_L (MHz)	F_H (MHz)	6dB Bandwidth (kHz)	Result
2402	2401.399038	2402.509615	1110.576923	PASS
2442	2441.399038	2442.509615	1110.576923	PASS
2480	2479.399038	2480.509615	1110.576923	PASS

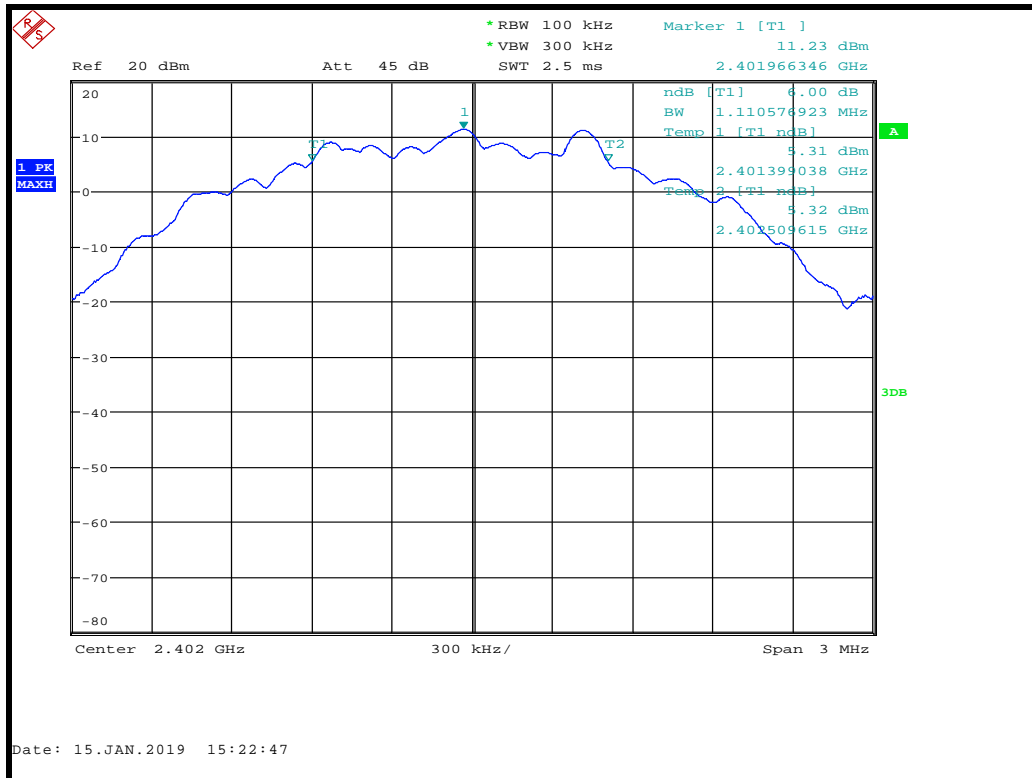

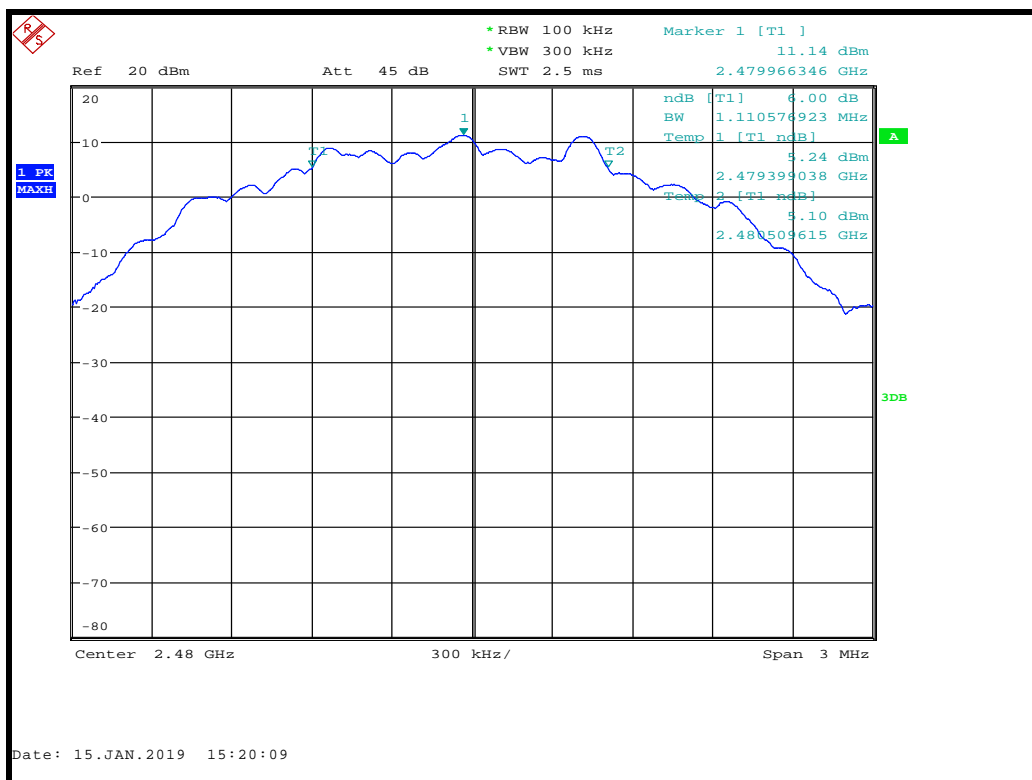
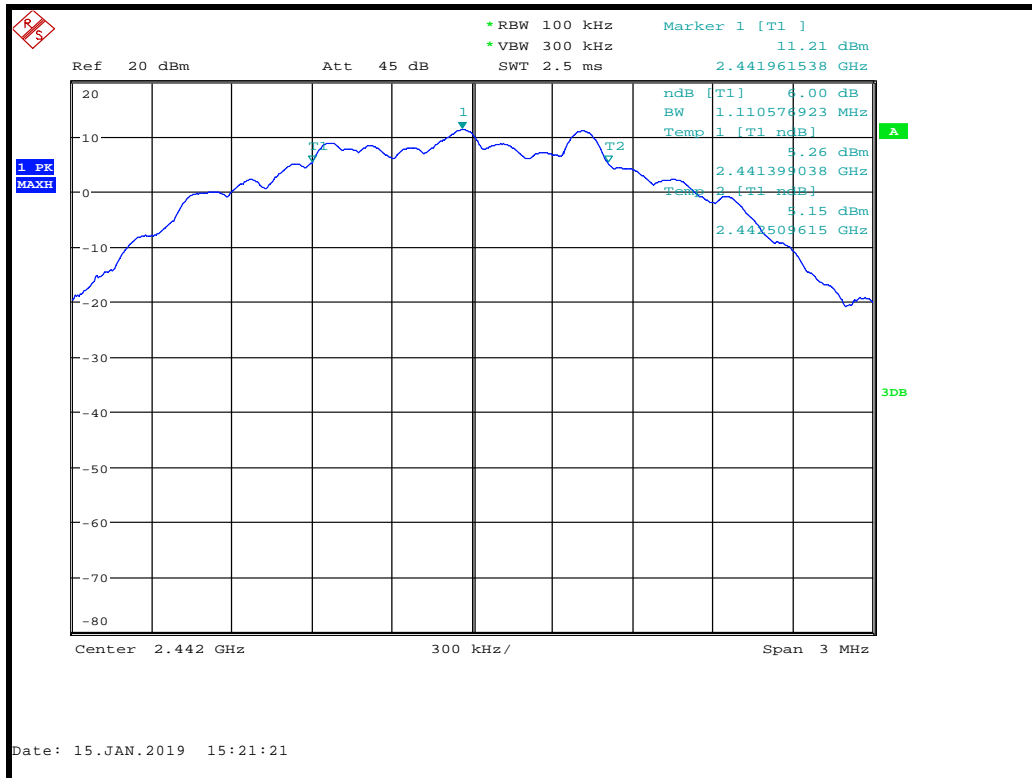

FCC 15.247. Modulation: BTLE; Data rate: 125k; Power setting: 126				
Channel Frequency (MHz)	F_L (MHz)	F_H (MHz)	6dB Bandwidth (kHz)	Result
2402	2401.610577	2402.288462	677.884615385	PASS
2442	2441.610577	2442.283654	673.076923077	PASS
2480	2479.605769	2480.283654	677.884615385	PASS

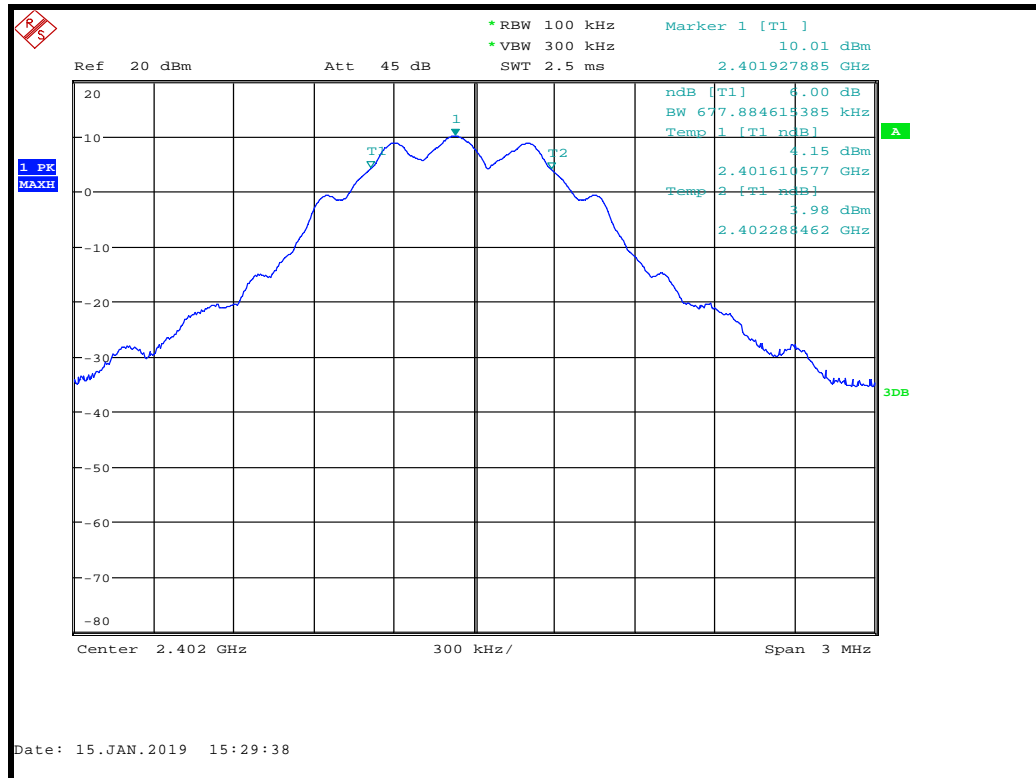

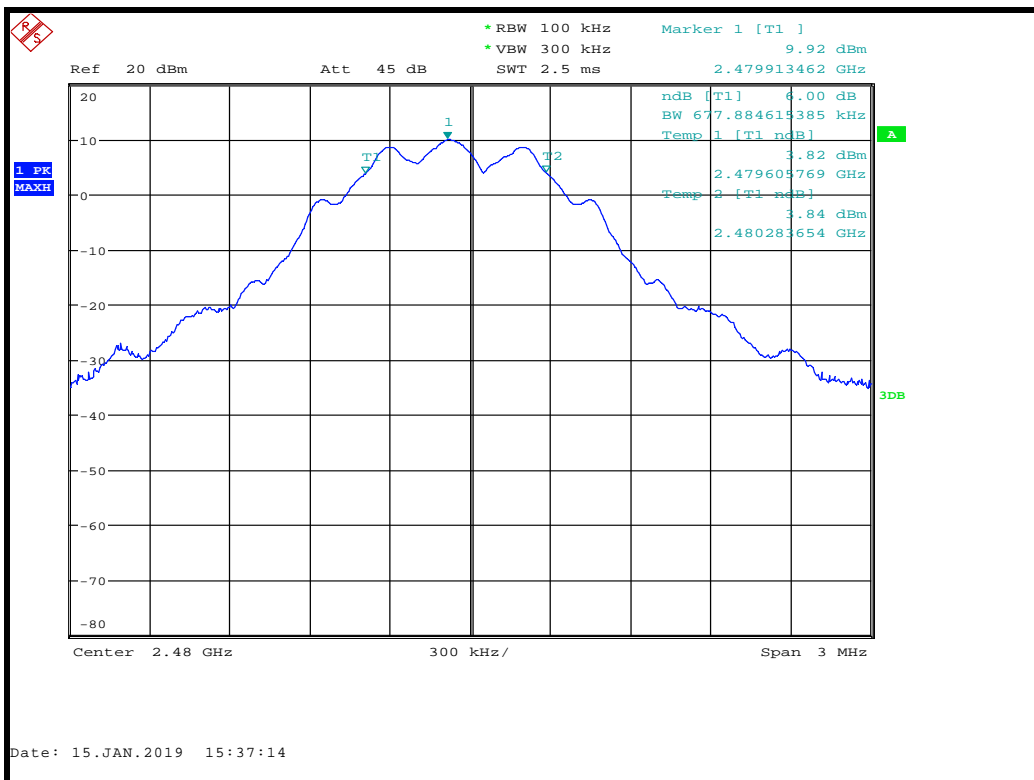
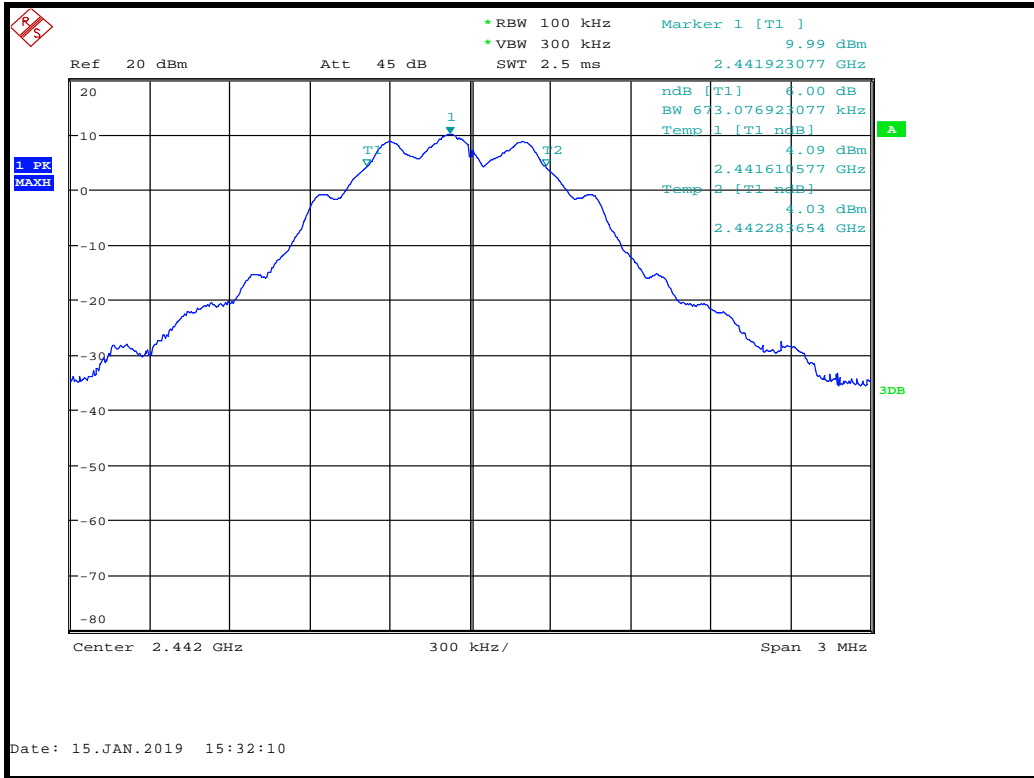

FCC 15.247. Modulation: BTLE; Data rate: 500k; Power setting: 126				
Channel Frequency (MHz)	F_L (MHz)	F_H (MHz)	6dB Bandwidth (kHz)	Result
2402	2401.576923	2402.302885	725.961538462	PASS
2442	2441.576923	2442.302885	725.961538462	PASS
2480	2479.576923	2480.298077	721.153846154	PASS

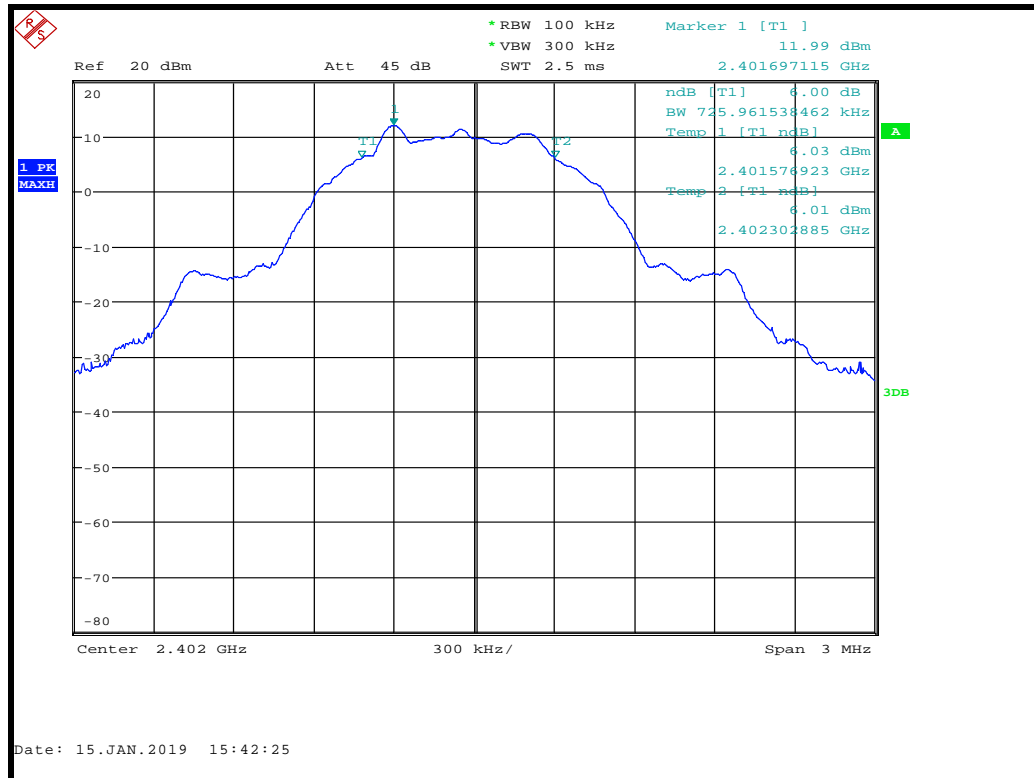

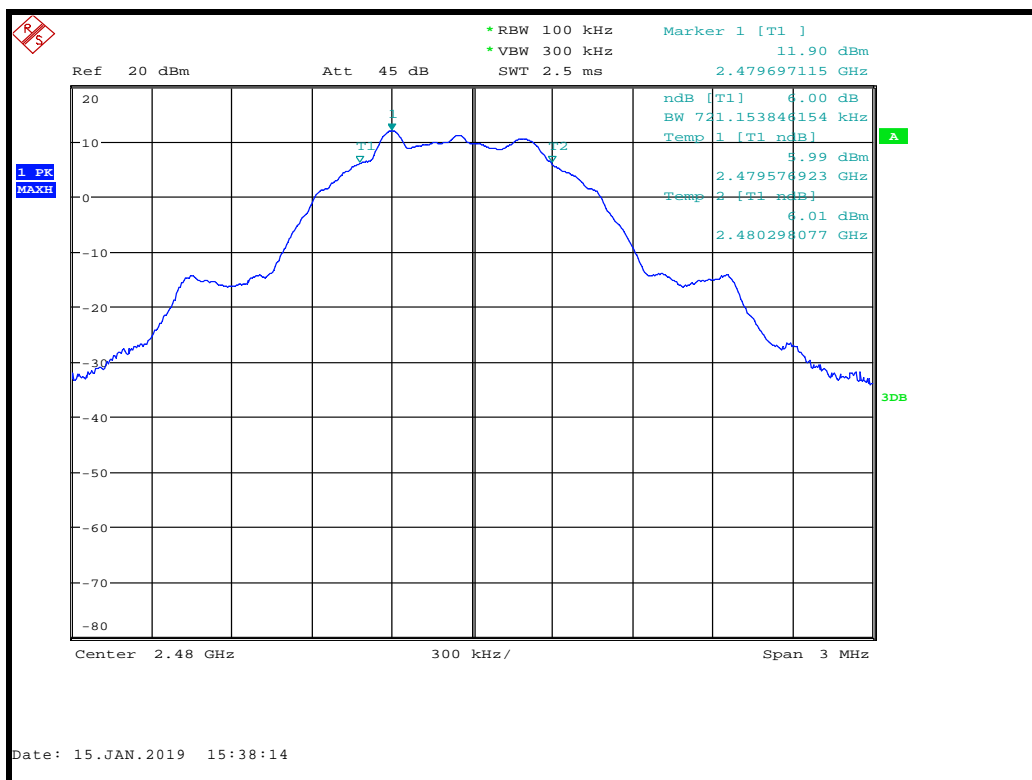
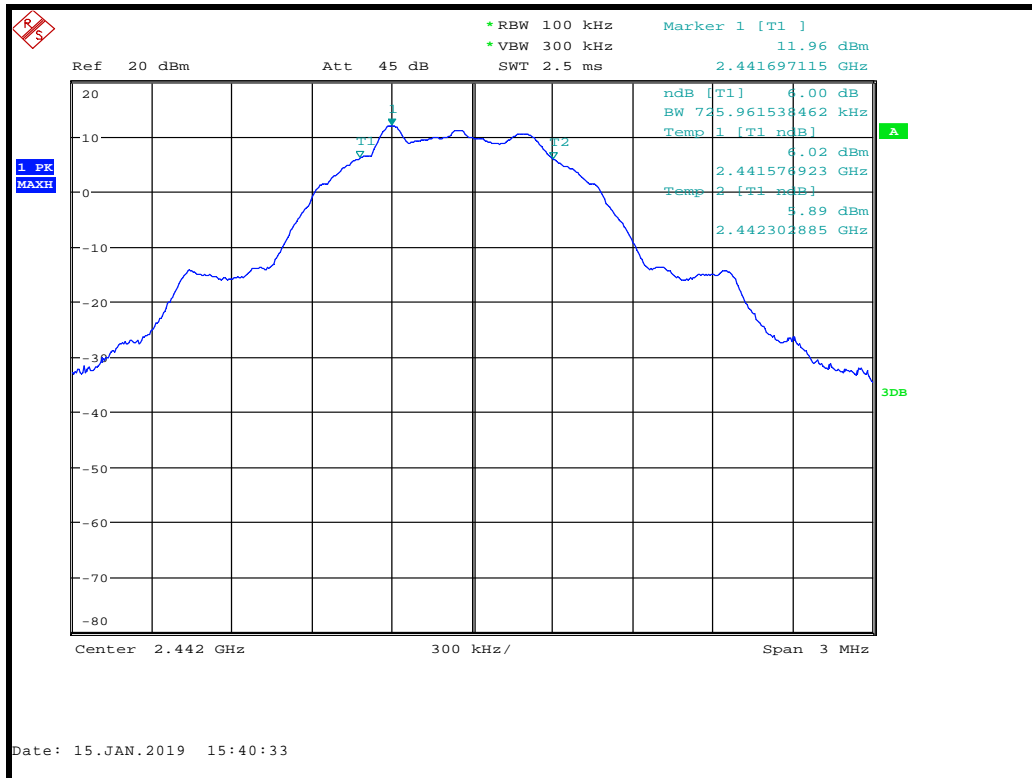

FCC 15.247. Modulation: BTLE; Data rate: 1M; Power setting: 100				
Channel Frequency (MHz)	F_L (MHz)	F_H (MHz)	6dB Bandwidth (kHz)	Result
2402	2401.631410	2402.275641	644.230769231	PASS
2442	2441.631410	2442.269231	637.820512821	PASS
2480	2479.628205	2480.269231	641.025641026	PASS

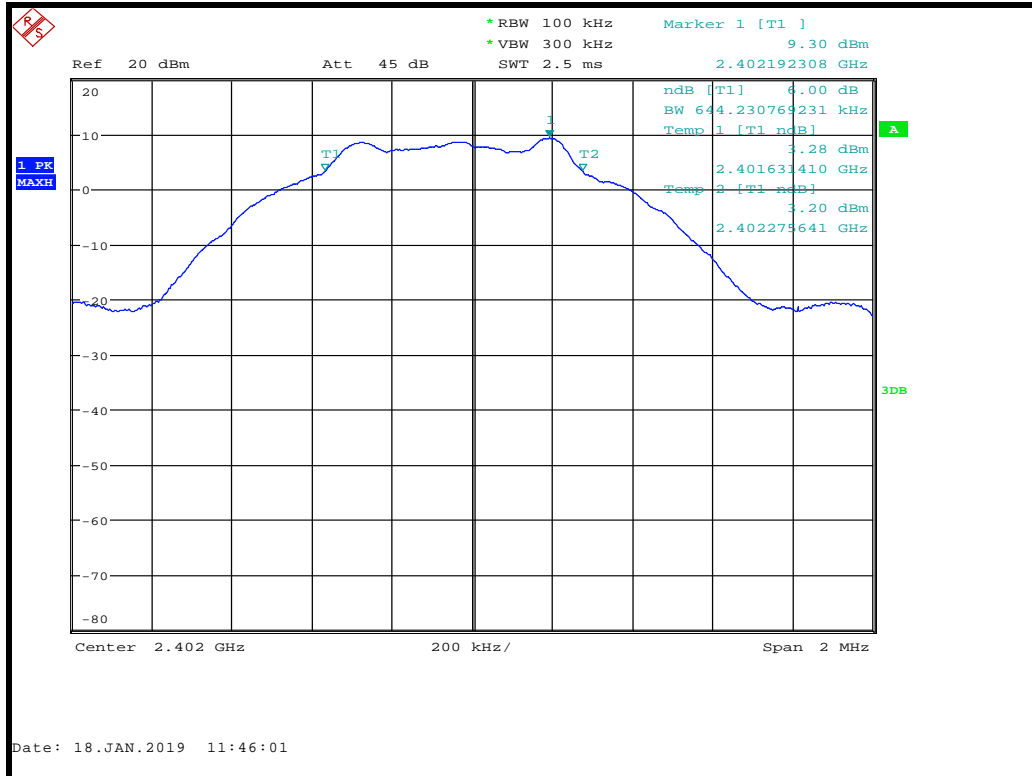

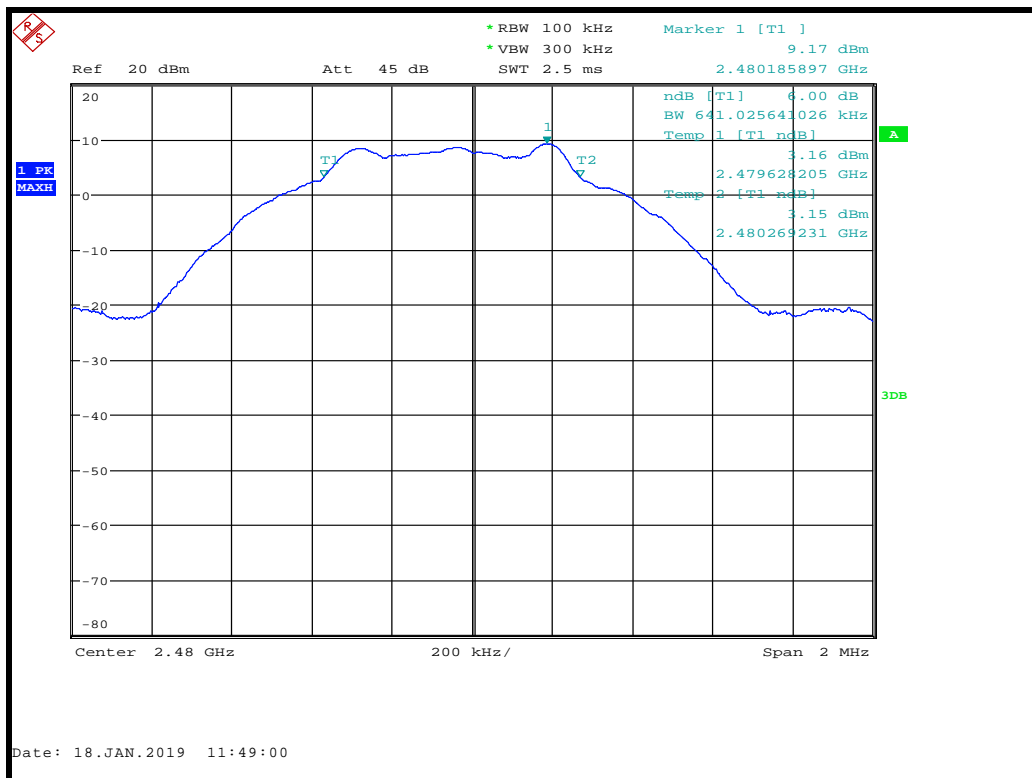
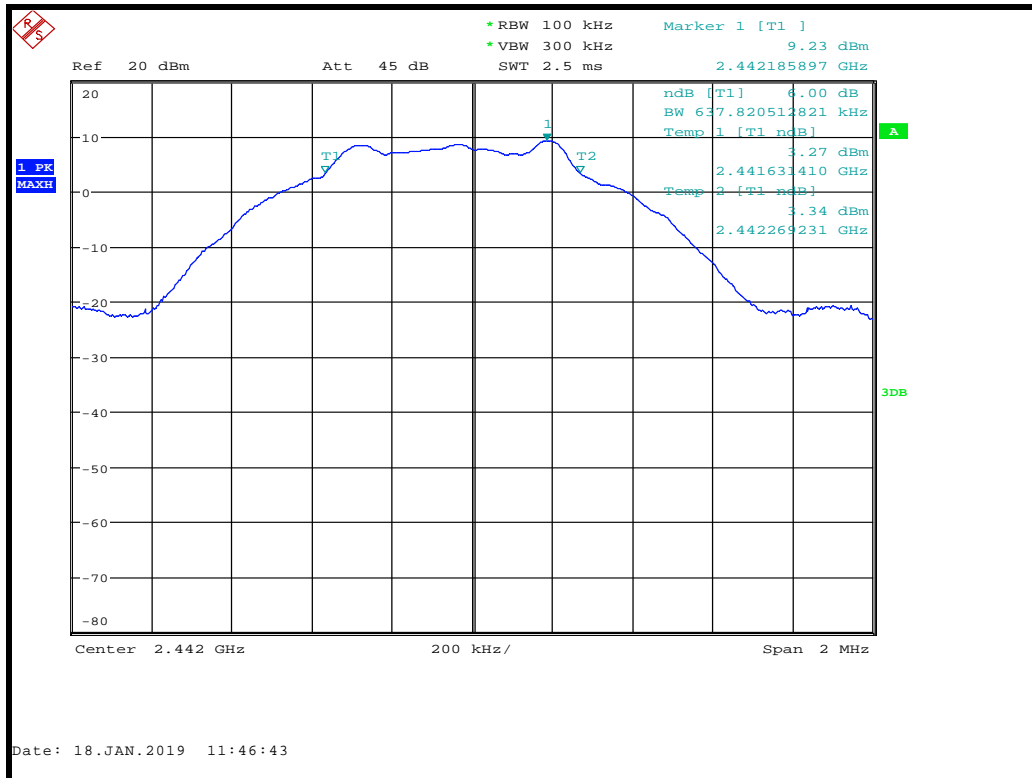

FCC 15.247. Modulation: BTLE; Data rate: 2M; Power setting: 100				
Channel Frequency (MHz)	F_L (MHz)	F_H (MHz)	6dB Bandwidth (kHz)	Result
2402	2401.399038	2402.509615	1110.576923	PASS
2442	2441.399038	2442.509615	1110.576923	PASS
2480	2479.399038	2480.509615	1110.576923	PASS

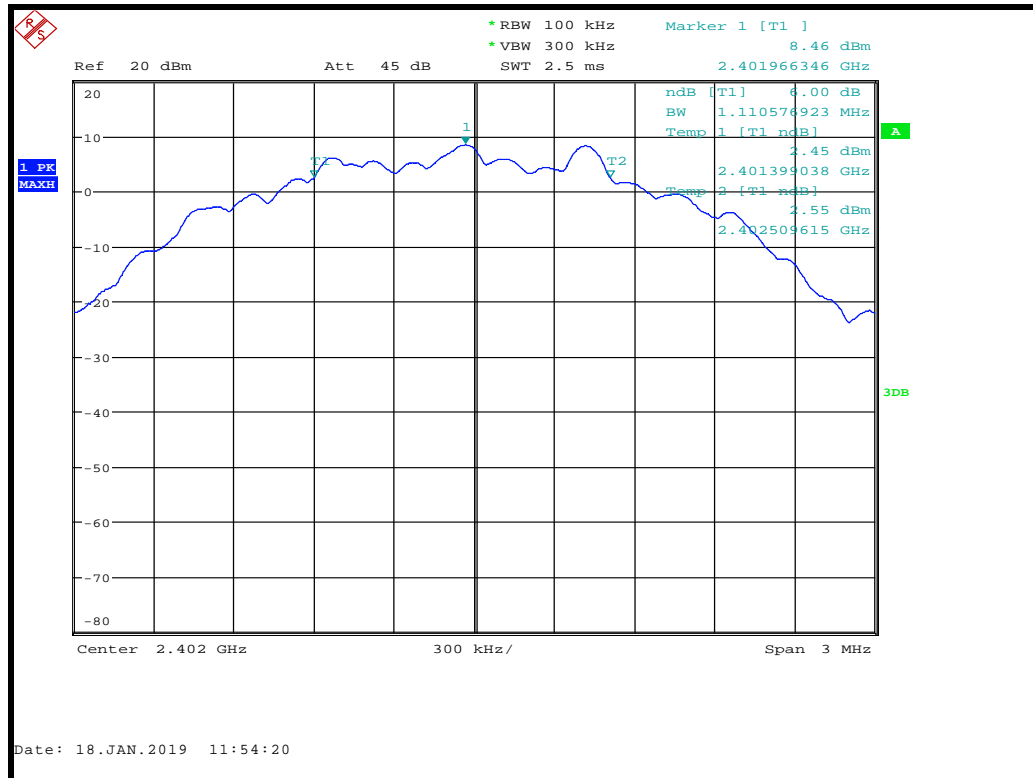

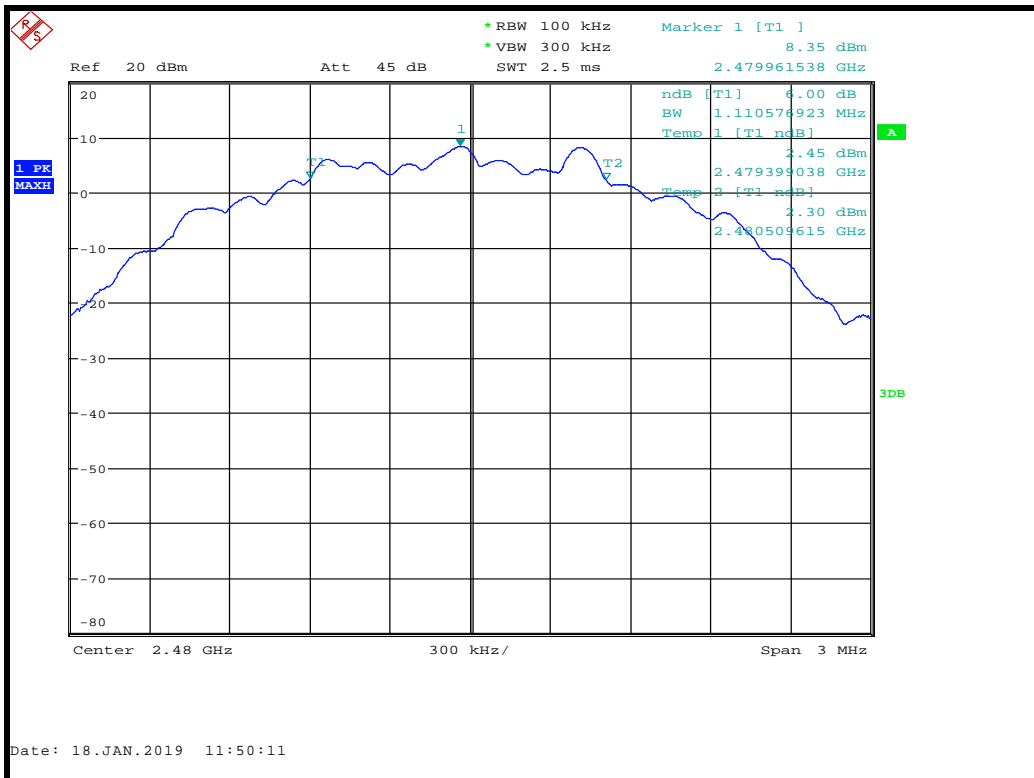
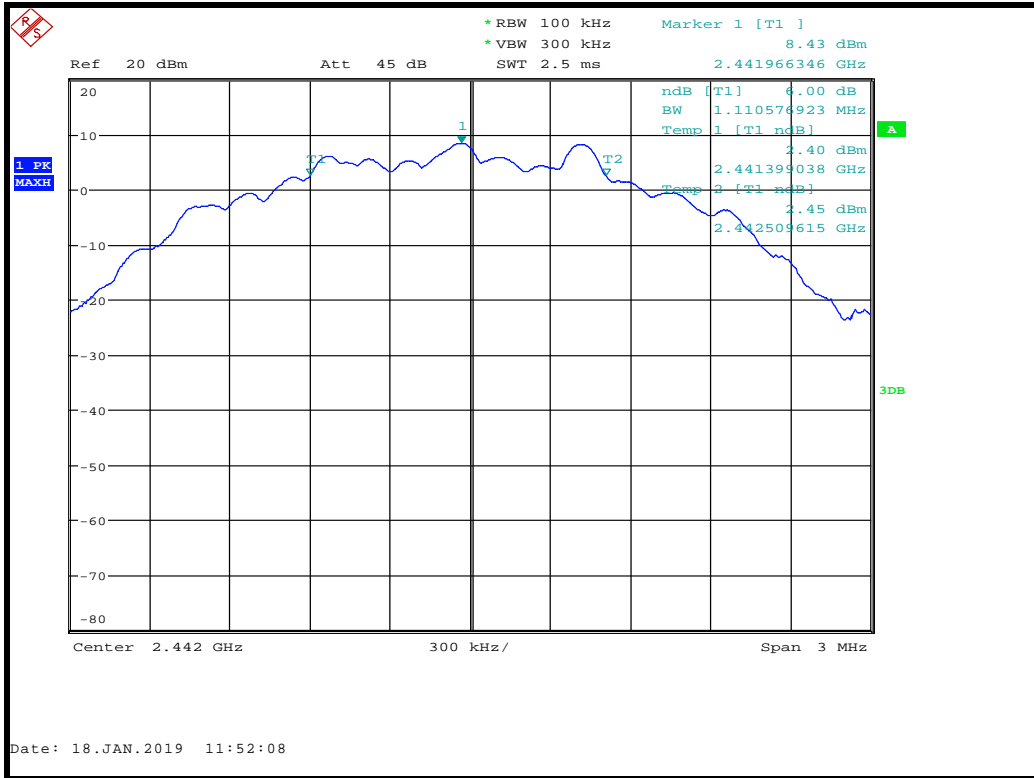

FCC 15.247. Modulation: BTLE; Data rate: 125k; Power setting: 100				
Channel Frequency (MHz)	F_L (MHz)	F_H (MHz)	6dB Bandwidth (kHz)	Result
2402	2401.610577	2402.288462	677.884615385	PASS
2442	2441.610577	2442.283654	673.076923077	PASS
2480	2479.610577	2480.283654	673.076923077	PASS

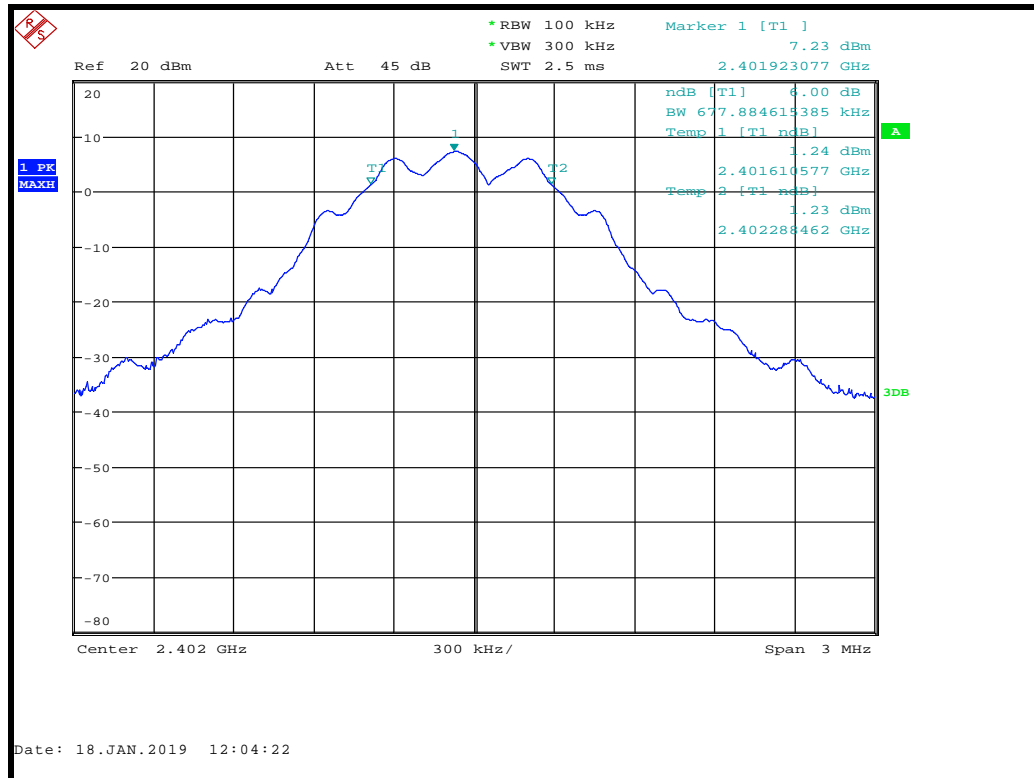

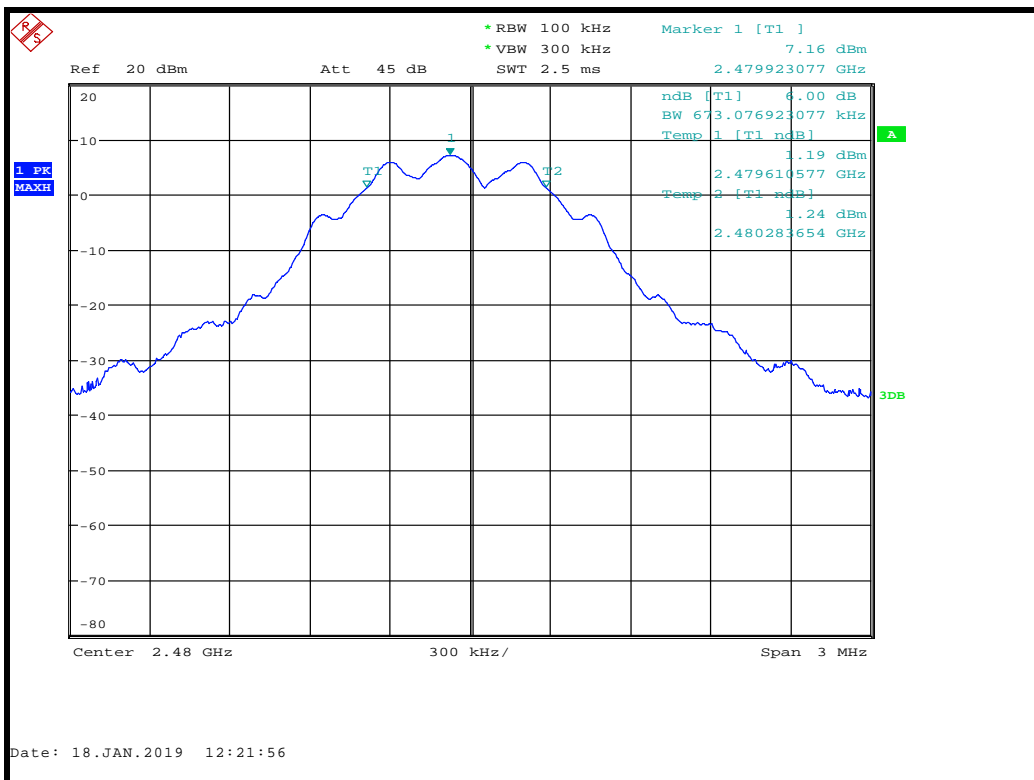
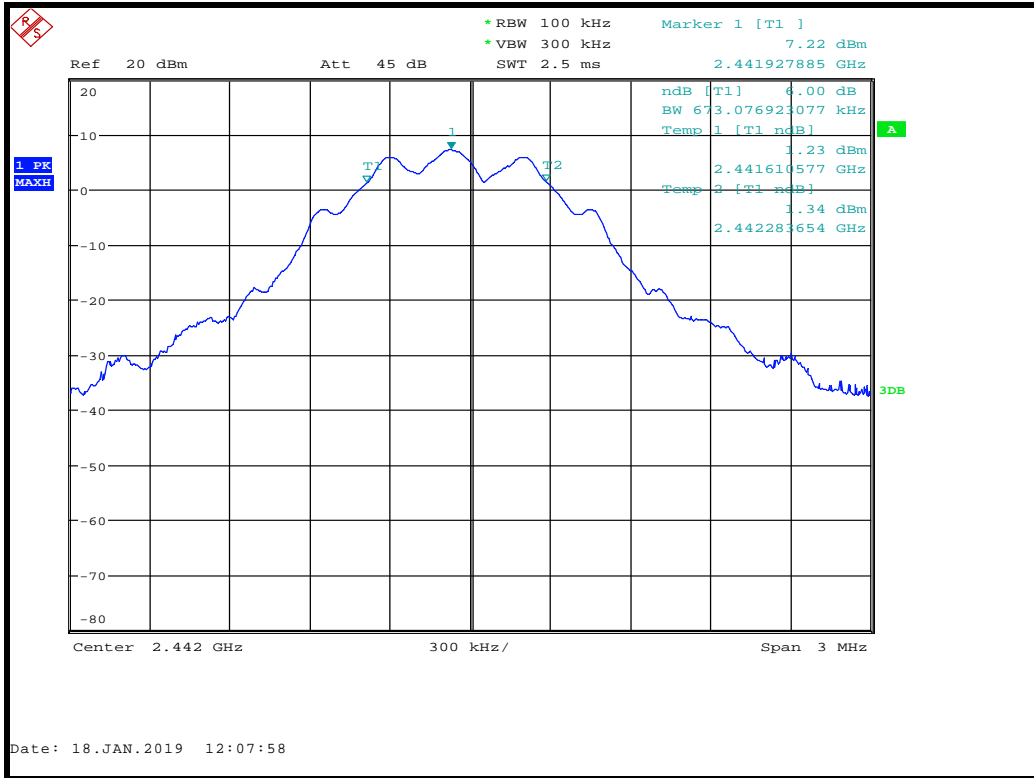

FCC 15.247. Modulation: BTLE; Data rate: 500k; Power setting: 100				
Channel Frequency (MHz)	F_L (MHz)	F_H (MHz)	6dB Bandwidth (kHz)	Result
2402	2401.576923	2402.307692	730.769230770	PASS
2442	2441.576923	2442.302885	725.961538462	PASS
2480	2479.576923	2480.302885	725.961538462	PASS

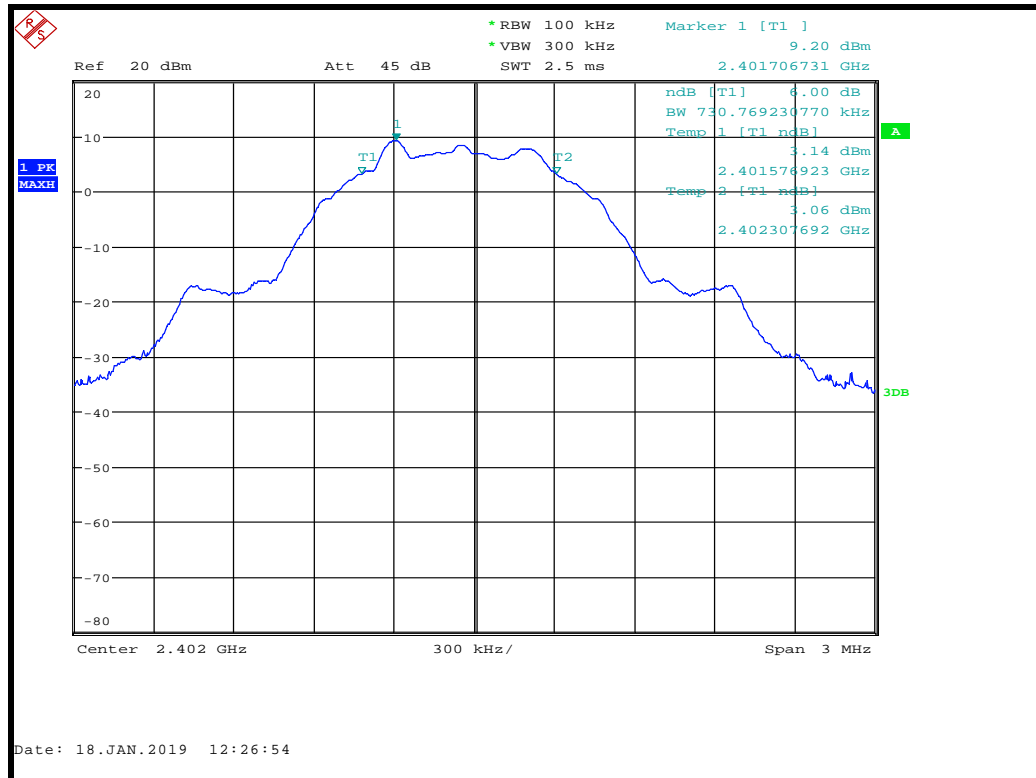

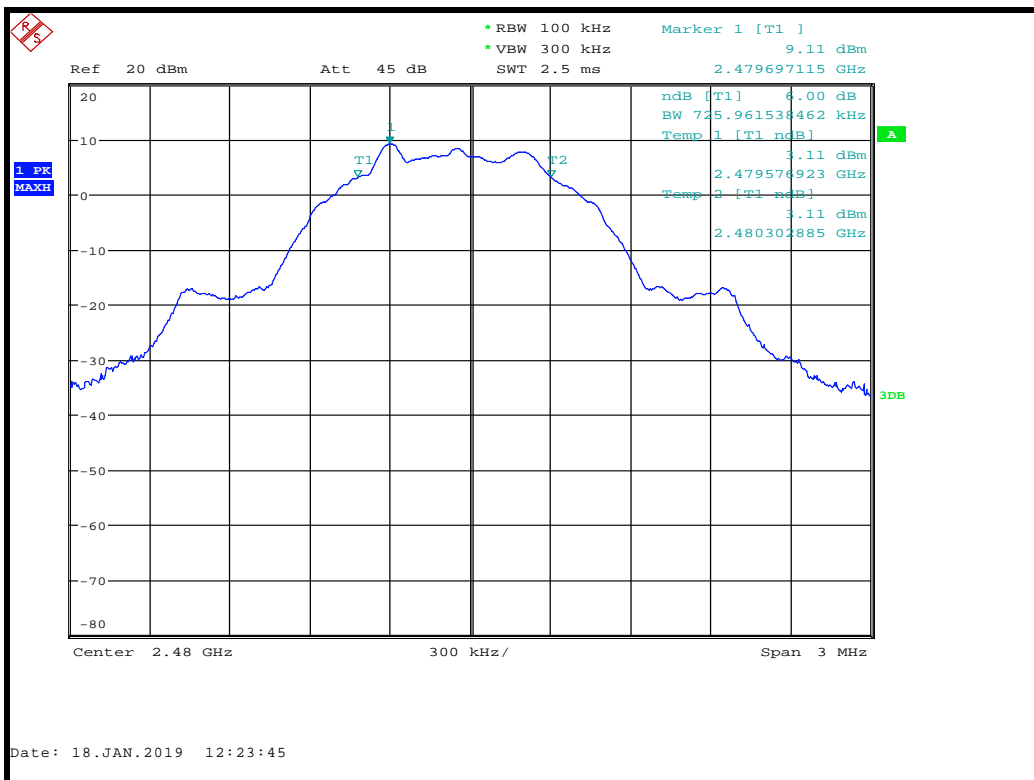
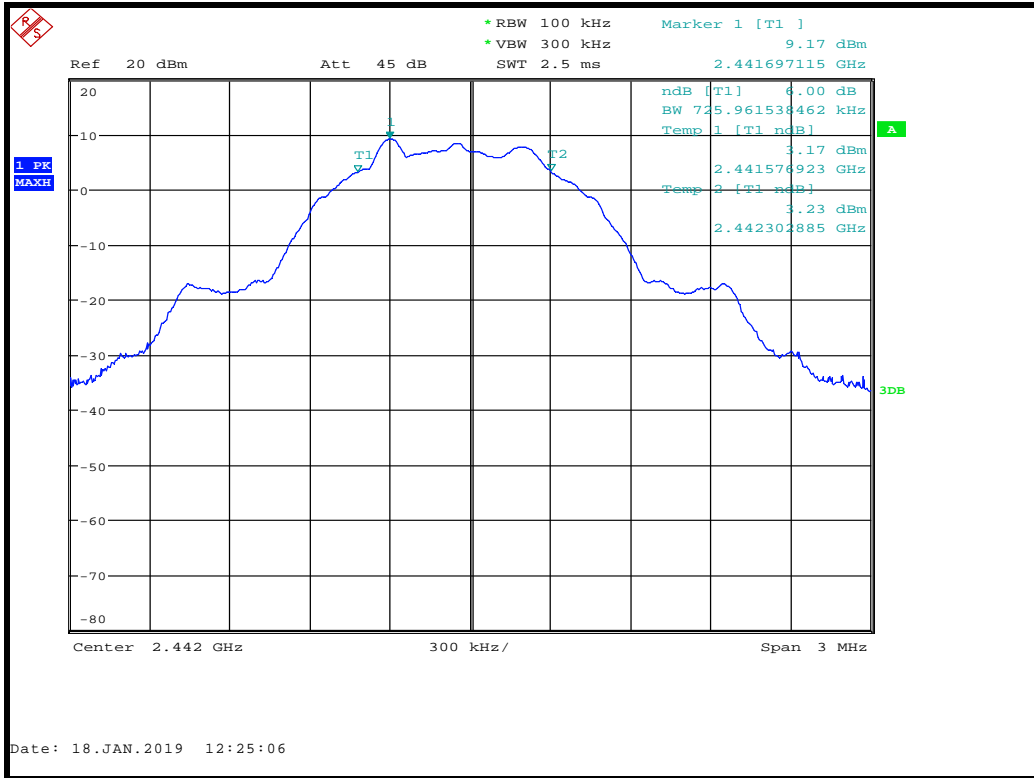

14 Maximum peak conducted output power

14.1 Definition

The maximum peak conducted output power is defined as the maximum power level measured with a peak detector using a filter with width and shape of which is sufficient to accept the signal bandwidth.

The maximum conducted output power is defined as the total transmit power delivered to all antennas and antenna elements averaged across all symbols in the signaling alphabet when the transmitter is operating at its maximum power control level.

14.2 Test Parameters

Test Location:	Element Hull
Test Chamber:	Wireless Laboratory 1
Test Standard and Clause:	ANSI C63.10-2013, Clause 11.9.1
EUT Frequencies Measured:	2402 MHz / 2442 MHz / 2480 MHz
EUT Channel Bandwidths:	1 MHz (or 2 MHz for 2M mode)
Deviations From Standard:	None
Measurement BW:	3 MHz
Spectrum Analyzer Video BW: (requirement at least 3x RBW)	10 MHz
Measurement Detector:	Peak
Voltage Extreme Environment Test Range:	3.3 Vdc

Environmental Conditions (Normal Environment)

Temperature: 23 °C	+15 °C to +35 °C (as declared)
Humidity: 32 % RH	20 % RH to 75 % RH (as declared)

14.3 Test Limit

For systems employing digital modulation techniques operating in the bands 902 to 928 MHz, 2400 to 2483.5 MHz and 5725 to 5850 MHz, the maximum peak conducted output power shall not exceed 1 W.

14.4 Test Method

With the EUT setup as per section 9 of this report and connected as per Figure iv, the resolution bandwidth of the spectrum analyser was increased above the EUT occupied bandwidth and the peak emission data noted.

The measurements were performed with EUT set at its maximum duty. All modulation schemes, data rates and power settings were used to observe the worst-case configuration in each bandwidth.

Figure iv Test Setup

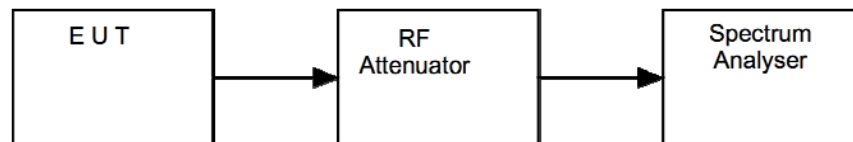

14.5 Test Equipment

Equipment Type	Manufacturer	Equipment Description	Element No	Due For Calibration
FSU46	R&S	Spectrum Analyser	U281	2019-11-20

14.6 Test Results

FCC 15.247. Modulation: BTLE; Data rate: 1M; Power setting: 126				
Channel Frequency (MHz)	Analyzer Level (dBm)	Cable loss (dB)	Power (mW)	Result
2402	12.7	0.6	21.4	PASS
2442	12.7	0.6	21.4	PASS
2480	12.6	0.6	20.9	PASS

FCC 15.247. Modulation: BTLE; Data rate: 2M; Power setting: 126				
Channel Frequency (MHz)	Analyzer Level (dBm)	Cable loss (dB)	Power (mW)	Result
2402	12.7	0.6	21.4	PASS
2442	12.7	0.6	21.4	PASS
2480	12.6	0.6	20.9	PASS

FCC 15.247. Modulation: BTLE; Data rate: 125k; Power setting: 126				
Channel Frequency (MHz)	Analyzer Level (dBm)	Cable loss (dB)	Power (mW)	Result
2402	12.6	0.6	20.9	PASS
2442	12.6	0.6	20.9	PASS
2480	12.5	0.6	20.4	PASS

FCC 15.247. Modulation: BTLE; Data rate: 500k; Power setting: 126				
Channel Frequency (MHz)	Analyzer Level (dBm)	Cable loss (dB)	Power (mW)	Result
2402	12.6	0.6	20.9	PASS
2442	12.6	0.6	20.9	PASS
2480	12.5	0.6	20.4	PASS

FCC 15.247. Modulation: BTLE; Data rate: 1M; Power setting: 100				
Channel Frequency (MHz)	Analyzer Level (dBm)	Cable loss (dB)	Power (mW)	Result
2402	9.9	0.6	11.2	PASS
2442	9.9	0.6	11.2	PASS
2480	9.7	0.6	10.7	PASS

FCC 15.247. Modulation: BTLE; Data rate: 2M; Power setting: 100				
Channel Frequency (MHz)	Analyzer Level (dBm)	Cable loss (dB)	Power (mW)	Result
2402	9.9	0.6	11.2	PASS
2442	9.9	0.6	11.2	PASS
2480	9.8	0.6	11.0	PASS

FCC 15.247. Modulation: BTLE; Data rate: 125k; Power setting: 100				
Channel Frequency (MHz)	Analyzer Level (dBm)	Cable loss (dB)	Power (mW)	Result
2402	9.9	0.6	11.2	PASS
2442	9.8	0.6	11.0	PASS
2480	9.8	0.6	11.0	PASS

FCC 15.247. Modulation: BTLE; Data rate: 500k; Power setting: 100				
Channel Frequency (MHz)	Analyzer Level (dBm)	Cable loss (dB)	Power (mW)	Result
2402	9.9	0.6	11.2	PASS
2442	9.8	0.6	11.0	PASS
2480	9.8	0.6	11.0	PASS

15 Out-of-band and conducted spurious emissions

15.1 Definition

Out-of-band emission.

Emission on a frequency or frequencies immediately outside the necessary bandwidth that results from the modulation process but excluding spurious emissions.

Spurious emission.

Emission on a frequency or frequencies that are outside the necessary bandwidth and the level of which may be reduced without affecting the corresponding transmission of information. Spurious emissions include harmonic emissions, parasitic emissions, intermodulation products, and frequency conversion products, but exclude out-of-band emissions.

15.2 Test Parameters

Test Location:	Element Hull
Test Chamber:	Wireless Lab 1
Test Standard and Clause:	ANSI C63.10-2013, Clause 11.11
EUT Frequencies Measured:	2402 MHz, 2442 MHz & 2480 MHz
Deviations From Standard:	None
Measurement BW:	100 kHz
Spectrum Analyzer Video BW:	300 kHz
Measurement Detector:	Peak
Measurement Range:	9 kHz to 25 GHz

Environmental Conditions (Normal Environment)

Temperature: 19 °C	+15 °C to +35 °C (as declared)
Humidity: 30 % RH	20 % RH to 75 % RH (as declared)
Supply: 3.3 Vdc	As declared

15.3 Test Limit

In any 100 kHz bandwidth outside the frequency band in which the spread spectrum or digitally modulated device is operating, the RF power that is produced shall be at least 20 dB below that in the 100 kHz bandwidth within the band that contains the highest level of the desired power, based on either an RF conducted or a radiated measurement, provided that the transmitter demonstrates compliance with the peak conducted power limits.

If the transmitter complies with the conducted power limits based on the use of root-mean-square averaging over a time interval, the attenuation required shall be 30 dB instead of 20 dB.

Attenuation below the general field strength limits specified in FCC 47CFR15.209 (a) is not required.

15.4 Test Method

With the EUT connected as per Figure v, the emissions from the EUT were measured on a spectrum analyser.

The measurements were performed with EUT set at its maximum duty. All modulation schemes, data rates and power settings were used to observe the worst case configuration in each bandwidth.

Figure v Test Setup

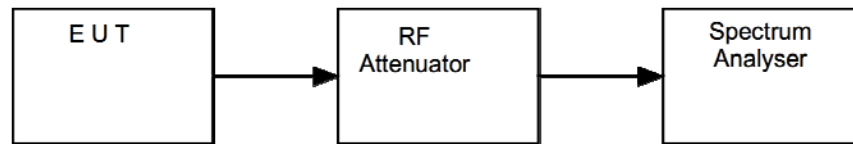

15.5 Test Equipment

<i>Equipment Description</i>	<i>Manufacturer</i>	<i>Equipment Type</i>	<i>Element No</i>	<i>Due For Calibration</i>
Spectrum Analyser	R&S	FSU46	U281	2019-11-20

15.6 Test Results

Data Rate: 125 kbps; Power Setting: 126

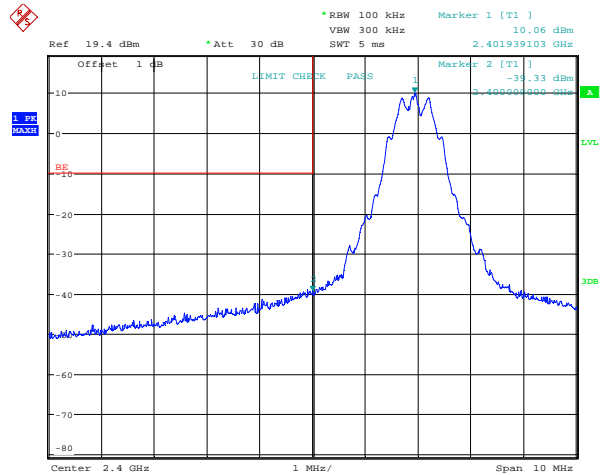
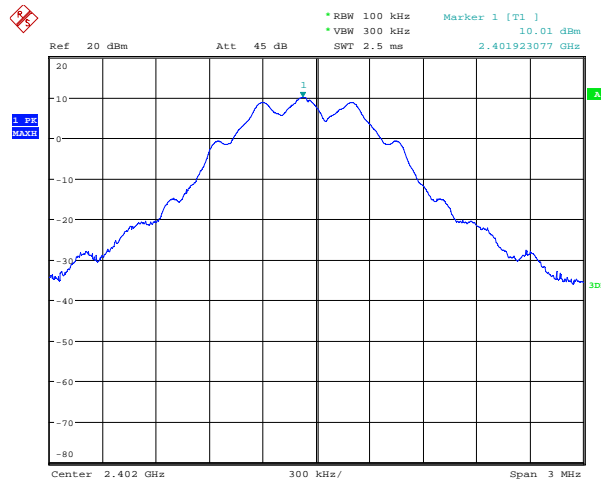

Reference Level

Lower Bandedge

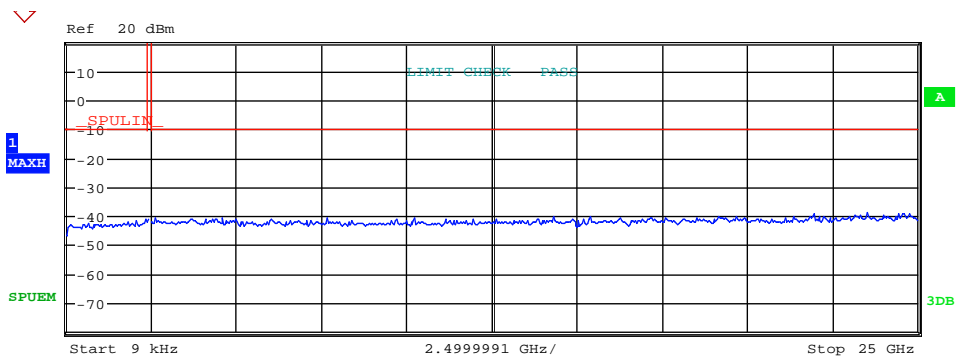

Start [Hz]	Stop [Hz]	RBW [Hz]	Freq [Hz]	PwrAbs [dBm]	ΔLimit [dB]
9.000 k	150.000 k	1.00 k	9.000000 k	-48.76	-38.76
150.000 k	30.000 M	10.00 k	155.970000 k	-46.94	-36.94
30.000 M	1.000 G	100.00 k	626.647000 M	-42.45	-32.45
1.000 G	2.400 G	100.00 k	2.341480 G	-41.10	-31.10
2.483 G	10.000 G	100.00 k	4.584362 G	-40.85	-30.85
10.000 G	15.000 G	100.00 k	14.288000 G	-40.34	-30.34
15.000 G	20.000 G	100.00 k	15.391000 G	-40.18	-30.18
20.000 G	25.000 G	100.00 k	23.527500 G	-39.08	-29.08

Out of Band Emissions – 2402 MHz

Data Rate: 125 kbps; Power Setting: 126

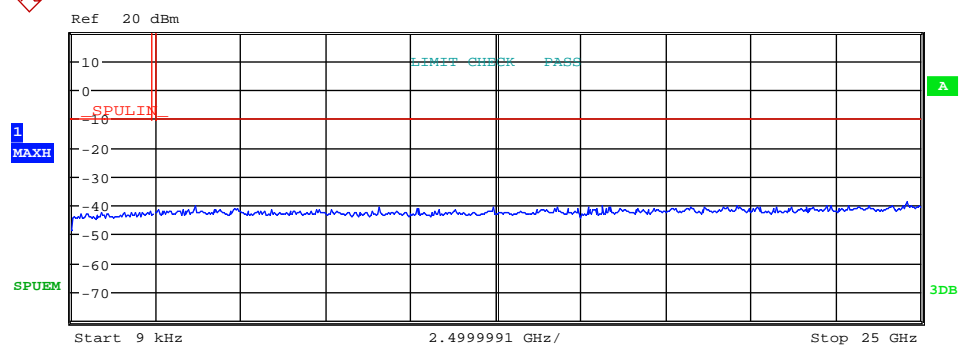

Start [Hz]	Stop [Hz]	RBW [Hz]	Freq [Hz]	PwrAbs [dBm]	ΔLimit [dB]
9.000 k	150.000 k	1.00 k	9.000000 k	-49.07	-39.07
150.000 k	30.000 M	10.00 k	194.775000 k	-48.81	-38.81
30.000 M	1.000 G	100.00 k	865.558000 M	-42.78	-32.78
1.000 G	2.400 G	100.00 k	2.317540 G	-42.33	-32.33
2.483 G	10.000 G	100.00 k	3.638786 G	-40.19	-30.19
10.000 G	15.000 G	100.00 k	12.412000 G	-41.00	-31.00
15.000 G	20.000 G	100.00 k	19.604500 G	-40.45	-30.45
20.000 G	25.000 G	100.00 k	24.595500 G	-39.02	-29.02

Out of Band Emissions – 2442 MHz

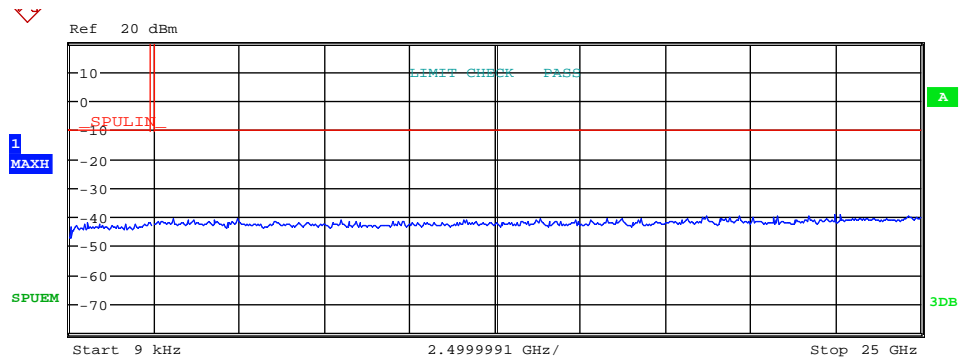

Start [Hz]	Stop [Hz]	RBW [Hz]	Freq [Hz]	PwrAbs [dBm]	ΔLimit [dB]
9.000 k	150.000 k	1.00 k	9.000000 k	-49.33	-39.33
150.000 k	30.000 M	10.00 k	158.955000 k	-47.15	-37.15
30.000 M	1.000 G	100.00 k	515.970000 M	-42.06	-32.06
1.000 G	2.400 G	100.00 k	2.364300 G	-42.05	-32.05
2.483 G	10.000 G	100.00 k	4.939141 G	-40.85	-30.85
10.000 G	15.000 G	100.00 k	13.807000 G	-40.75	-30.75
15.000 G	20.000 G	100.00 k	18.718500 G	-39.82	-29.82
20.000 G	25.000 G	100.00 k	22.654500 G	-39.32	-29.32

Out of Band Emissions – 2480 MHz

Data Rate: 125 kbps; Power Setting: 126

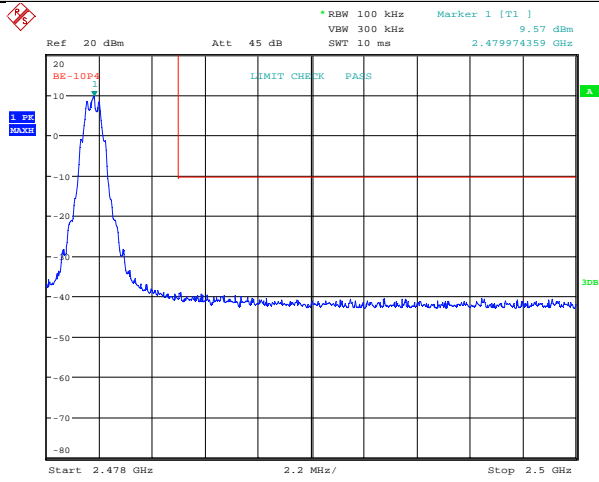

Date: 7_MAR.2019 10:54:17

Upper Bandedge

Data Rate: 500 kbps; Power Setting: 126

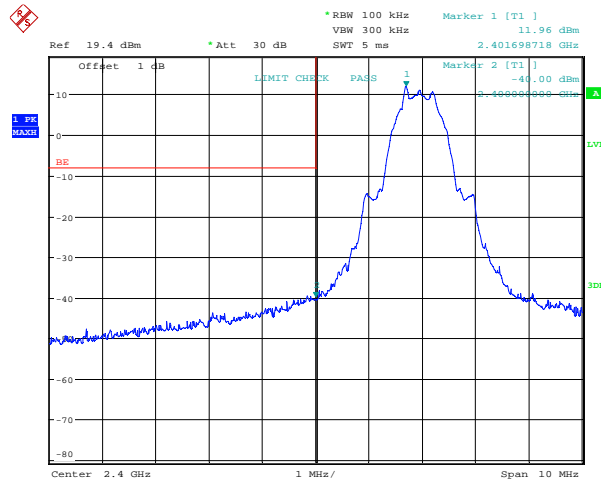
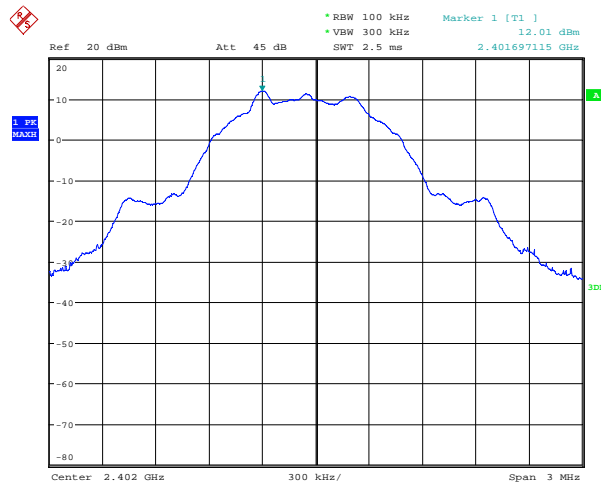

Reference Level

Lower Bandedge

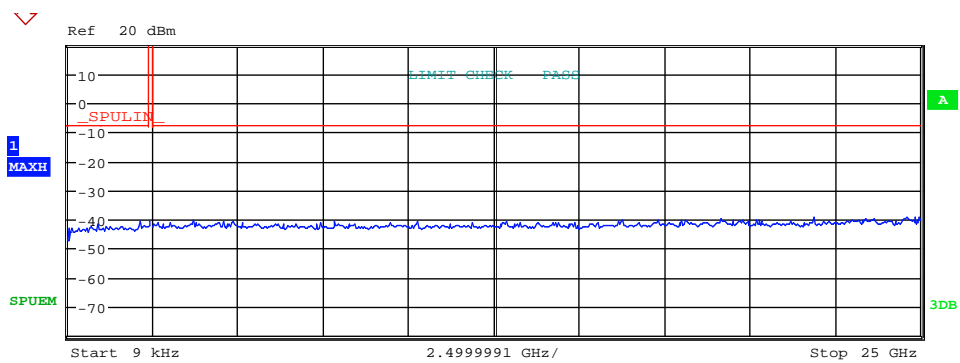

Start [Hz]	Stop [Hz]	RBW [Hz]	Freq [Hz]	PwrAbs [dBm]	ΔLimit [dB]
9.000 k	150.000 k	1.00 k	10.581731 k	-49.61	-41.61
150.000 k	30.000 M	10.00 k	158.955000 k	-47.36	-39.36
30.000 M	1.000 G	100.00 k	886.704000 M	-41.71	-33.71
1.000 G	2.400 G	100.00 k	2.399860 G	-40.88	-32.88
2.483 G	10.000 G	100.00 k	3.667349 G	-40.27	-32.27
10.000 G	15.000 G	100.00 k	12.855500 G	-40.88	-32.88
15.000 G	20.000 G	100.00 k	19.142000 G	-40.01	-32.01
20.000 G	25.000 G	100.00 k	21.881000 G	-39.26	-31.26

Out of Band Emissions – 2402 MHz

Data Rate: 500 kbps; Power Setting: 126

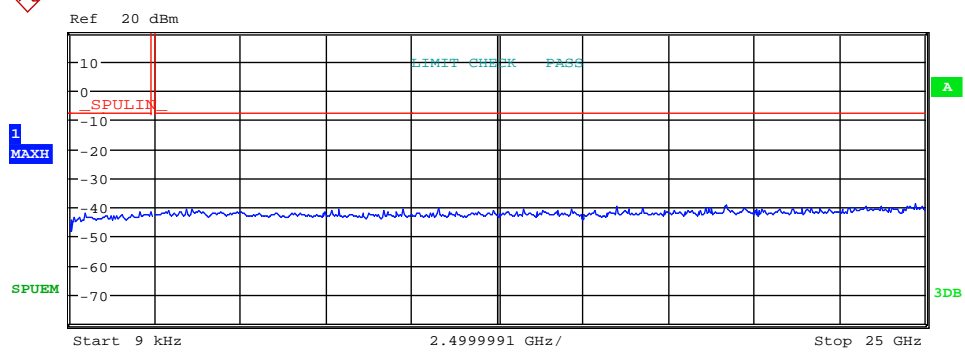

Start [Hz]	Stop [Hz]	RBW [Hz]	Freq [Hz]	PwrAbs [dBm]	ΔLimit [dB]
9.000 k	150.000 k	1.00 k	10.581731 k	-48.17	-40.17
150.000 k	30.000 M	10.00 k	194.775000 k	-48.08	-40.08
30.000 M	1.000 G	100.00 k	456.218000 M	-42.28	-34.28
1.000 G	2.400 G	100.00 k	2.372140 G	-41.60	-33.60
2.483 G	10.000 G	100.00 k	3.550843 G	-40.74	-32.74
10.000 G	15.000 G	100.00 k	10.770500 G	-40.51	-32.51
15.000 G	20.000 G	100.00 k	19.187000 G	-39.60	-31.60
20.000 G	25.000 G	100.00 k	24.721500 G	-39.12	-31.12

Out of Band Emissions – 2442 MHz

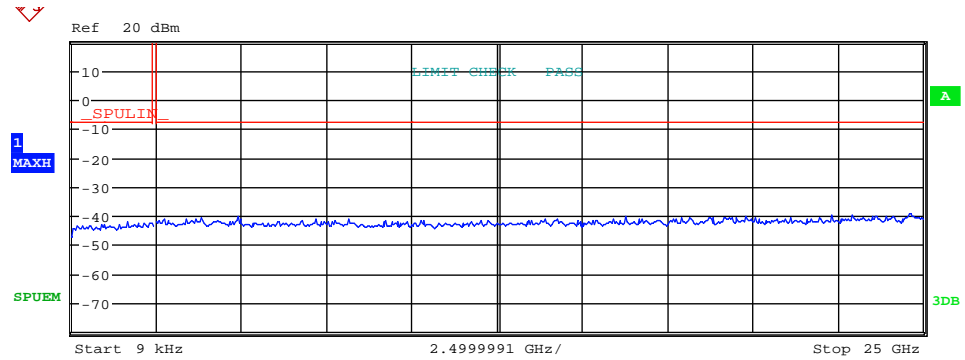

Start [Hz]	Stop [Hz]	RBW [Hz]	Freq [Hz]	PwrAbs [dBm]	ΔLimit [dB]
9.000 k	150.000 k	1.00 k	10.807692 k	-49.50	-41.50
150.000 k	30.000 M	10.00 k	191.790000 k	-47.58	-39.58
30.000 M	1.000 G	100.00 k	945.874000 M	-43.14	-35.14
1.000 G	2.400 G	100.00 k	1.638400 G	-42.34	-34.34
2.483 G	10.000 G	100.00 k	4.872995 G	-40.49	-32.49
10.000 G	15.000 G	100.00 k	14.255000 G	-41.37	-33.37
15.000 G	20.000 G	100.00 k	19.792000 G	-40.16	-32.16
20.000 G	25.000 G	100.00 k	24.598500 G	-39.43	-31.43

Out of Band Emissions – 2480 MHz

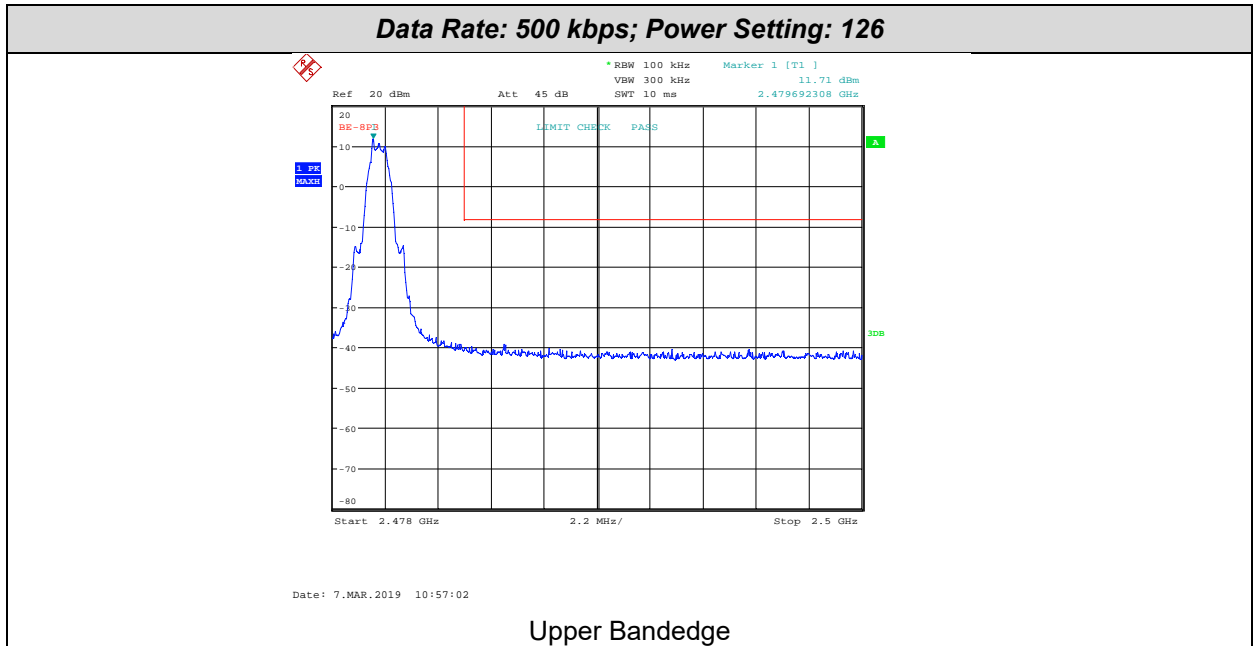

Data Rate: 1 Mbps; Power Setting: 126

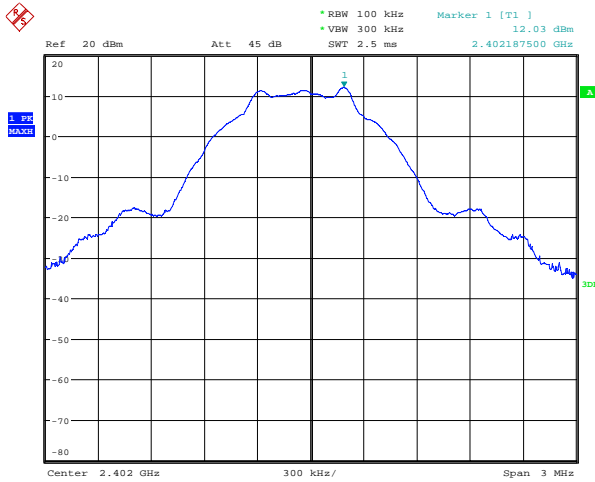

Reference Level

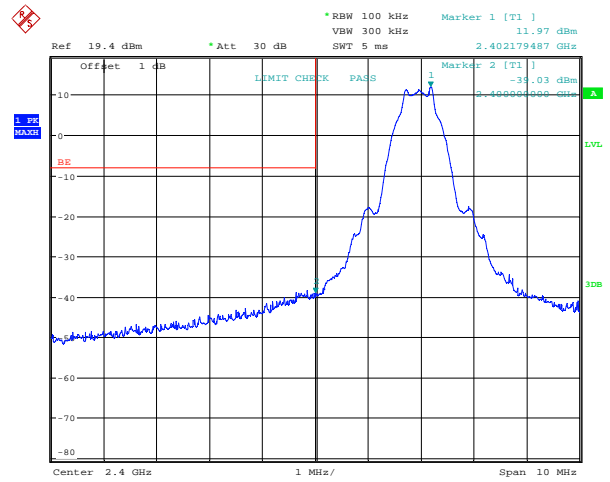

Lower Bandedge

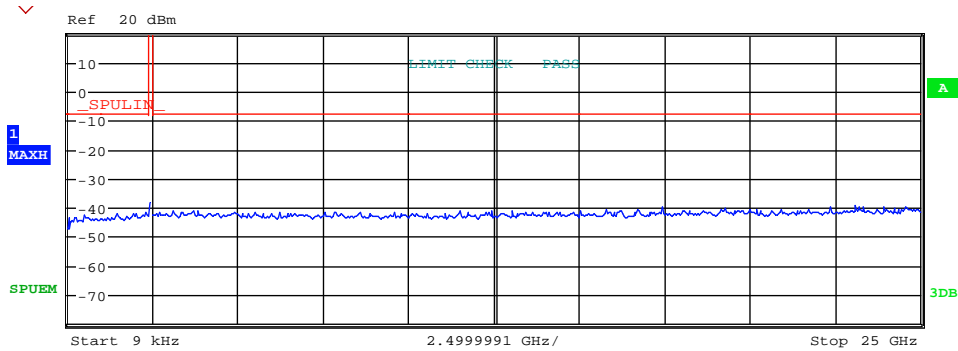

Start [Hz]	Stop [Hz]	RBW [Hz]	Freq [Hz]	PwrAbs [dBm]	Δ Limit [dB]
9.000 k	150.000 k	1.00 k	10.581731 k	-50.18	-42.18
150.000 k	30.000 M	10.00 k	158.955000 k	-47.15	-39.15
30.000 M	1.000 G	100.00 k	467.179000 M	-42.88	-34.88
1.000 G	2.400 G	100.00 k	2.399860 G	-40.44	-32.44
2.483 G	10.000 G	100.00 k	3.792123 G	-41.16	-33.16
10.000 G	15.000 G	100.00 k	11.493000 G	-41.36	-33.36
15.000 G	20.000 G	100.00 k	17.435500 G	-39.92	-31.92
20.000 G	25.000 G	100.00 k	23.086500 G	-39.42	-31.42

Out of Band Emissions – 2402 MHz

Data Rate: 1 Mbps; Power Setting: 126

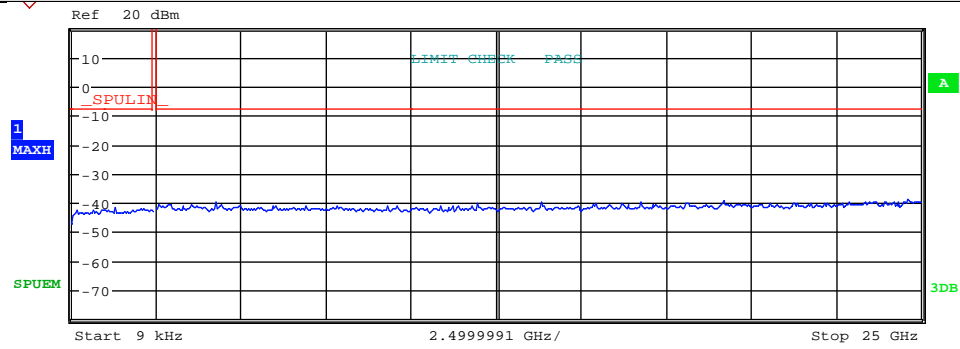

Start [Hz]	Stop [Hz]	RBW [Hz]	Freq [Hz]	PwrAbs [dBm]	ΔLimit [dB]
9.000 k	150.000 k	1.00 k	11.259615 k	-49.23	-41.23
150.000 k	30.000 M	10.00 k	150.000000 k	-47.15	-39.15
30.000 M	1.000 G	100.00 k	955.865000 M	-42.56	-34.56
1.000 G	2.400 G	100.00 k	1.293440 G	-41.90	-33.90
2.483 G	10.000 G	100.00 k	4.240106 G	-39.87	-31.87
10.000 G	15.000 G	100.00 k	13.812000 G	-40.05	-32.05
15.000 G	20.000 G	100.00 k	19.178500 G	-39.56	-31.56
20.000 G	25.000 G	100.00 k	24.609000 G	-39.09	-31.09

Out of Band Emissions – 2442 MHz

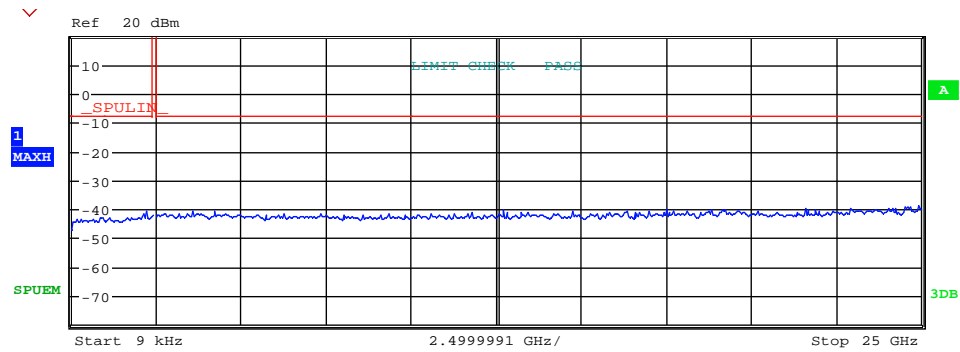

Start [Hz]	Stop [Hz]	RBW [Hz]	Freq [Hz]	PwrAbs [dBm]	ΔLimit [dB]
9.000 k	150.000 k	1.00 k	66.168269 k	-49.50	-41.50
150.000 k	30.000 M	10.00 k	164.925000 k	-47.58	-39.58
30.000 M	1.000 G	100.00 k	917.938000 M	-43.15	-35.15
1.000 G	2.400 G	100.00 k	2.206100 G	-40.73	-32.73
2.483 G	10.000 G	100.00 k	3.553850 G	-40.61	-32.61
10.000 G	15.000 G	100.00 k	12.710000 G	-40.54	-32.54
15.000 G	20.000 G	100.00 k	17.496500 G	-40.37	-32.37
20.000 G	25.000 G	100.00 k	24.933000 G	-38.94	-30.94

Out of Band Emissions – 2480 MHz

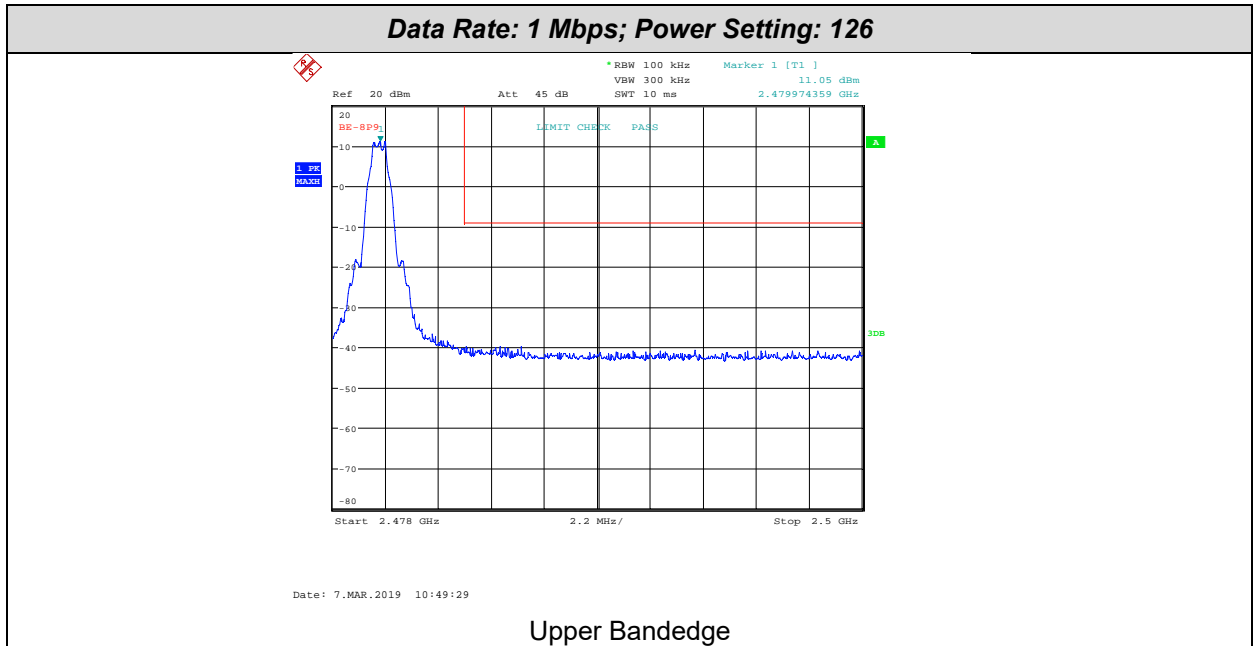

Data Rate: 2 Mbps; Power Setting: 126

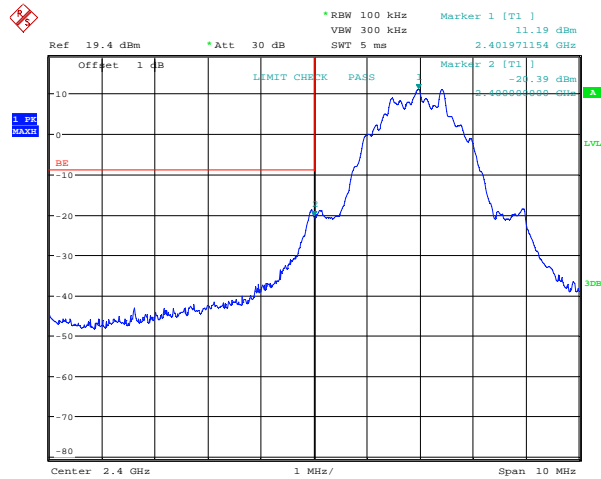
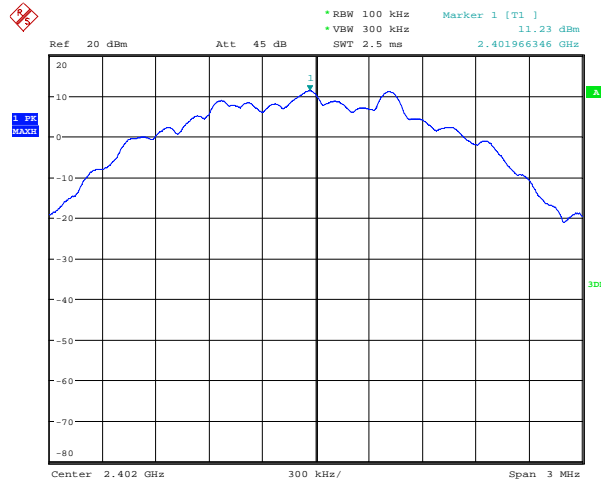

Reference Level

Lower Bandedge

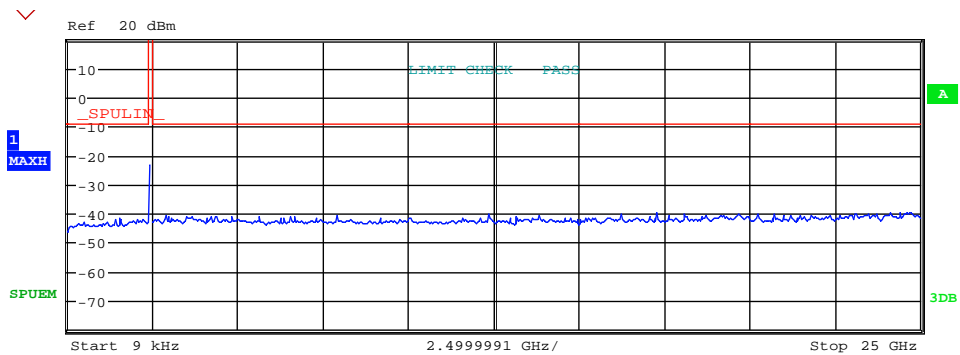

Start [Hz]	Stop [Hz]	RBW [Hz]	Freq [Hz]	PwrAbs [dBm]	ΔLimit [dB]
9.000 k	150.000 k	1.00 k	9.225962 k	-48.17	-39.37
150.000 k	30.000 M	10.00 k	194.775000 k	-46.31	-37.51
30.000 M	1.000 G	100.00 k	474.260000 M	-43.04	-34.24
1.000 G	2.400 G	100.00 k	2.399860 G	-27.26	-18.46
2.483 G	10.000 G	100.00 k	7.889367 G	-40.87	-32.07
10.000 G	15.000 G	100.00 k	12.328500 G	-40.31	-31.51
15.000 G	20.000 G	100.00 k	17.285000 G	-40.01	-31.21
20.000 G	25.000 G	100.00 k	24.666000 G	-39.86	-31.06

Out of Band Emissions – 2402 MHz

Data Rate: 2 Mbps; Power Setting: 126

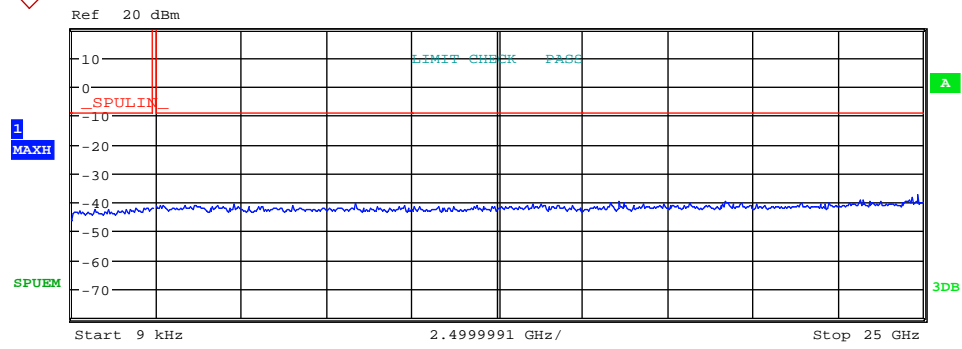

Start [Hz]	Stop [Hz]	RBW [Hz]	Freq [Hz]	PwrAbs [dBm]	ΔLimit [dB]
9.000 k	150.000 k	1.00 k	9.000000 k	-49.39	-40.59
150.000 k	30.000 M	10.00 k	155.970000 k	-46.50	-37.70
30.000 M	1.000 G	100.00 k	672.528000 M	-42.70	-33.90
1.000 G	2.400 G	100.00 k	2.395380 G	-42.02	-33.22
2.483 G	10.000 G	100.00 k	8.350880 G	-40.29	-31.49
10.000 G	15.000 G	100.00 k	13.531500 G	-40.88	-32.08
15.000 G	20.000 G	100.00 k	19.192000 G	-39.93	-31.13
20.000 G	25.000 G	100.00 k	24.853000 G	-37.58	-28.78

Out of Band Emissions – 2442 MHz

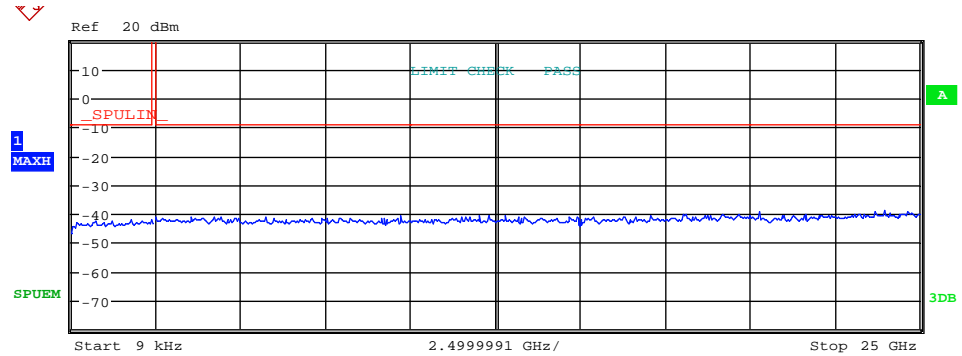

Start [Hz]	Stop [Hz]	RBW [Hz]	Freq [Hz]	PwrAbs [dBm]	ΔLimit [dB]
9.000 k	150.000 k	1.00 k	9.000000 k	-46.74	-37.94
150.000 k	30.000 M	10.00 k	185.820000 k	-48.32	-39.52
30.000 M	1.000 G	100.00 k	715.693000 M	-42.76	-33.96
1.000 G	2.400 G	100.00 k	1.743960 G	-42.07	-33.27
2.483 G	10.000 G	100.00 k	9.679797 G	-41.00	-32.20
10.000 G	15.000 G	100.00 k	12.314000 G	-40.65	-31.85
15.000 G	20.000 G	100.00 k	18.122000 G	-40.20	-31.40
20.000 G	25.000 G	100.00 k	23.950500 G	-39.14	-30.34

Out of Band Emissions – 2480 MHz

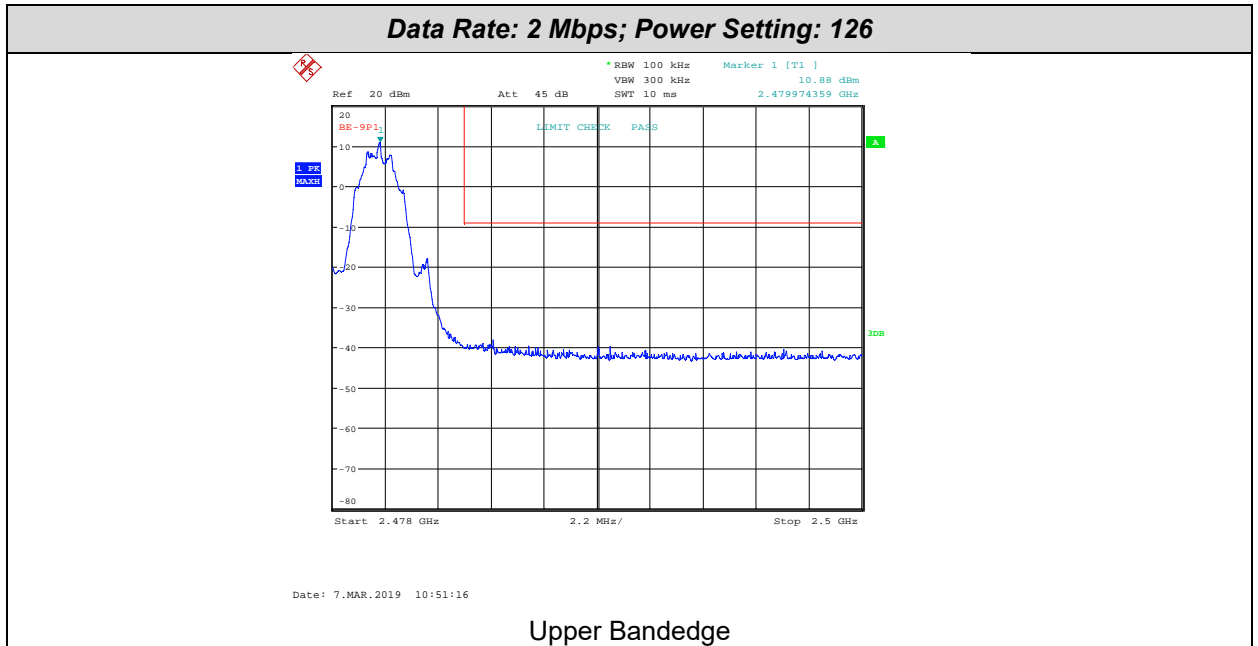

Data Rate: 125 kbps; Power Setting: 100

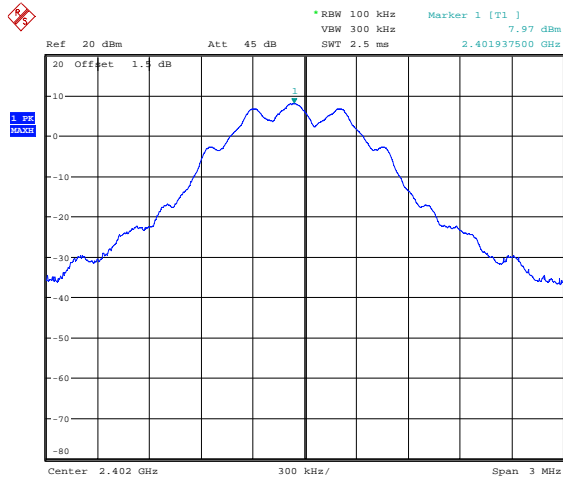

Reference Level

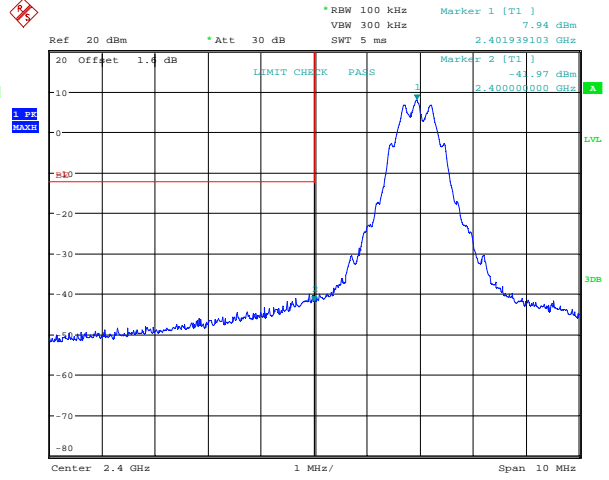

Lower Bandedge

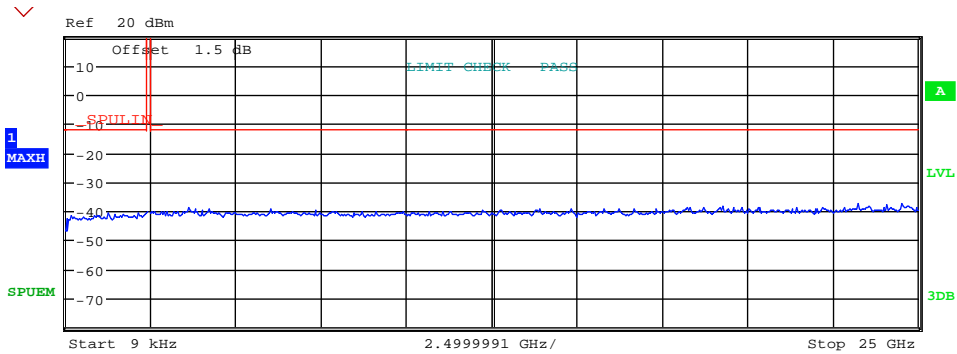

Out of Band Emissions – 2402 MHz

Start [Hz]	Stop [Hz]	RBW [Hz]	Freq [Hz]	PwrAbs [dBm]	ΔLimit [dB]
9.000 k	150.000 k	1.00 k	9.225962 k	-47.83	-35.80
150.000 k	30.000 M	10.00 k	191.790000 k	-46.82	-34.79
30.000 M	1.000 G	100.00 k	987.681000 M	-41.58	-29.55
1.000 G	2.400 G	100.00 k	2.399580 G	-40.46	-28.43
2.483 G	10.000 G	100.00 k	3.614733 G	-39.11	-27.08
10.000 G	15.000 G	100.00 k	13.895000 G	-39.44	-27.41
15.000 G	20.000 G	100.00 k	19.289500 G	-38.56	-26.53
20.000 G	25.000 G	100.00 k	24.504500 G	-37.50	-25.47

Data Rate: 125 kbps; Power Setting: 100

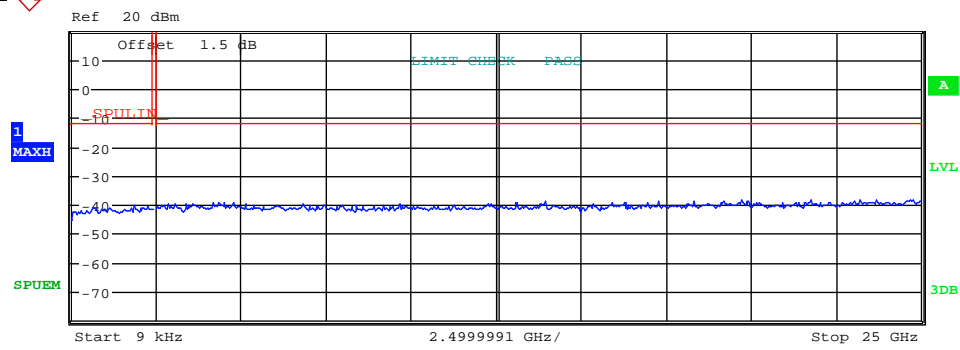

Start [Hz]	Stop [Hz]	RBW [Hz]	Freq [Hz]	PwrAbs [dBm]	ΔLimit [dB]
9.000 k	150.000 k	1.00 k	12.163462 k	-48.00	-35.97
150.000 k	30.000 M	10.00 k	179.850000 k	-45.65	-33.62
30.000 M	1.000 G	100.00 k	643.525000 M	-41.33	-29.30
1.000 G	2.400 G	100.00 k	1.852460 G	-40.19	-28.16
2.483 G	10.000 G	100.00 k	4.783549 G	-39.27	-27.24
10.000 G	15.000 G	100.00 k	13.924000 G	-38.85	-26.82
15.000 G	20.000 G	100.00 k	19.719000 G	-38.59	-26.56
20.000 G	25.000 G	100.00 k	21.755500 G	-38.27	-26.24

Out of Band Emissions – 2442 MHz

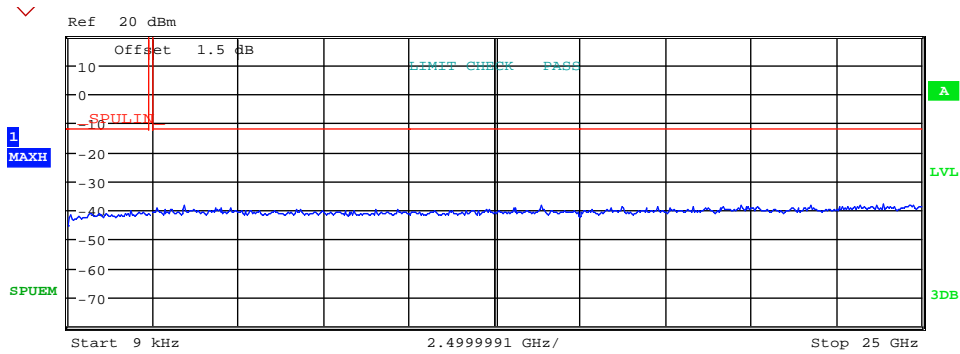

Start [Hz]	Stop [Hz]	RBW [Hz]	Freq [Hz]	PwrAbs [dBm]	ΔLimit [dB]
9.000 k	150.000 k	1.00 k	12.163462 k	-48.00	-35.97
150.000 k	30.000 M	10.00 k	179.850000 k	-45.65	-33.62
30.000 M	1.000 G	100.00 k	643.525000 M	-41.33	-29.30
1.000 G	2.400 G	100.00 k	1.852460 G	-40.19	-28.16
2.483 G	10.000 G	100.00 k	3.386232 G	-38.67	-26.64
10.000 G	15.000 G	100.00 k	13.865500 G	-38.50	-26.47
15.000 G	20.000 G	100.00 k	19.719000 G	-38.59	-26.56
20.000 G	25.000 G	100.00 k	23.879000 G	-38.13	-26.10

Out of Band Emissions – 2480 MHz

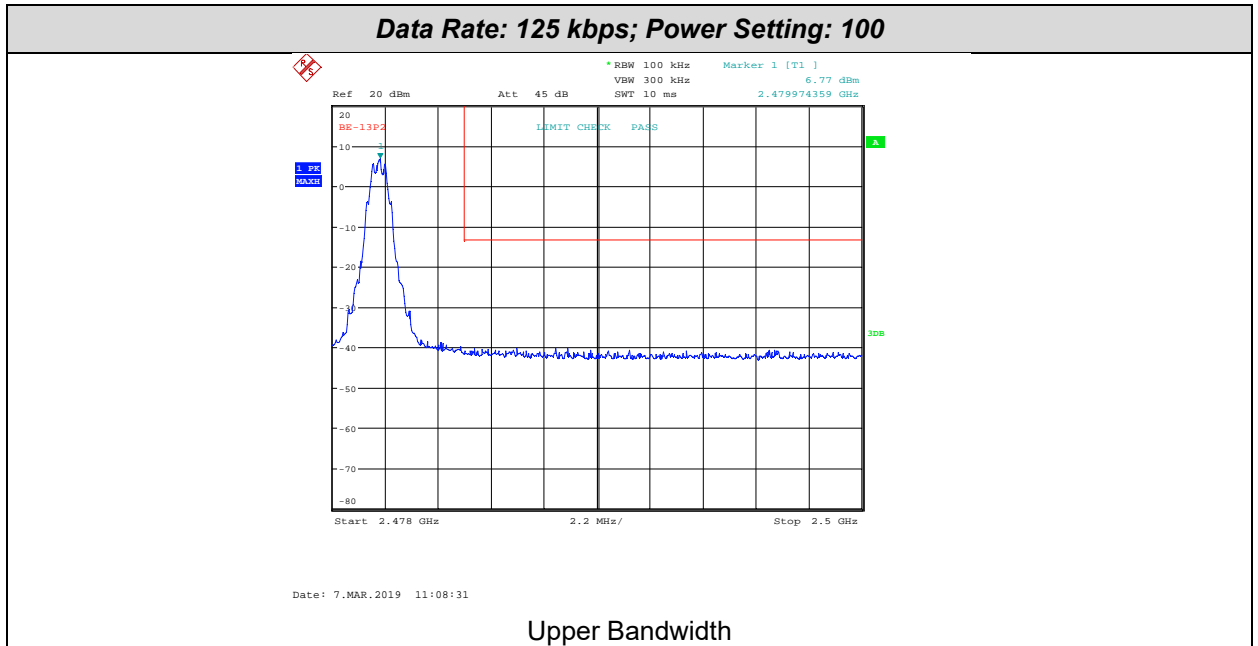

Data Rate: 500 kbps; Power Setting: 100

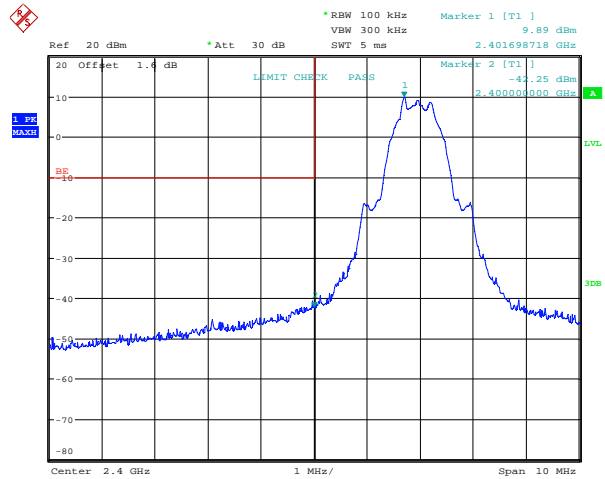
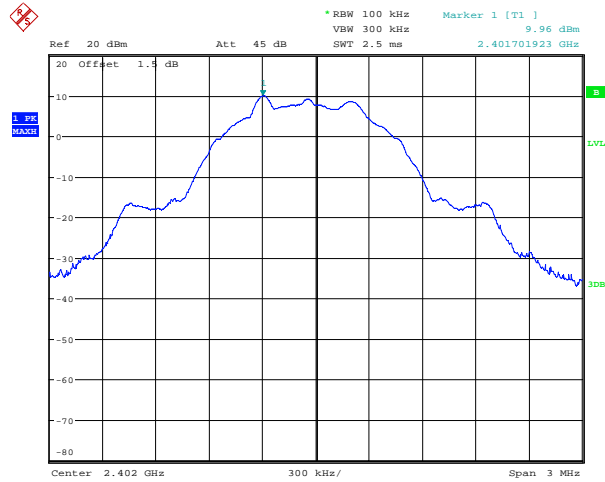

Reference Level

Lower Bandedge

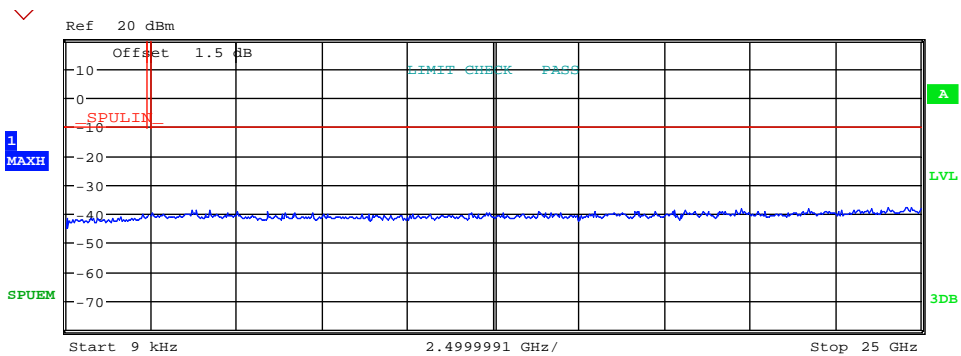

Start [Hz]	Stop [Hz]	RBW [Hz]	Freq [Hz]	PwrAbs [dBm]	ΔLimit [dB]
9.000 k	150.000 k	1.00 k	9.225962 k	-47.31	-37.27
150.000 k	30.000 M	10.00 k	194.775000 k	-45.00	-34.96
30.000 M	1.000 G	100.00 k	916.095000 M	-41.59	-31.55
1.000 G	2.400 G	100.00 k	2.236200 G	-40.35	-30.31
2.483 G	10.000 G	100.00 k	3.787613 G	-39.06	-29.02
10.000 G	15.000 G	100.00 k	13.832500 G	-39.38	-29.34
15.000 G	20.000 G	100.00 k	19.765500 G	-38.66	-28.62
20.000 G	25.000 G	100.00 k	24.054500 G	-37.92	-27.88

Out of Band Emissions – 2402 MHz

Data Rate: 500 kbps; Power Setting: 100

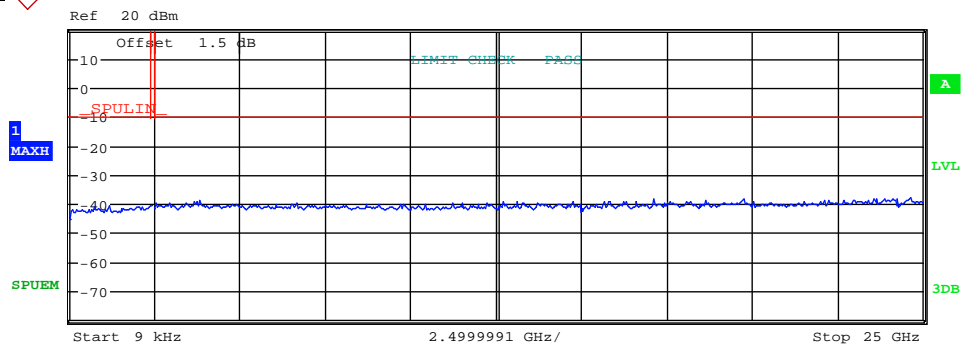

Start [Hz]	Stop [Hz]	RBW [Hz]	Freq [Hz]	PwrAbs [dBm]	ΔLimit [dB]
9.000 k	150.000 k	1.00 k	21.201923 k	-49.05	-39.01
150.000 k	30.000 M	10.00 k	182.835000 k	-45.44	-35.40
30.000 M	1.000 G	100.00 k	703.762000 M	-41.38	-31.34
1.000 G	2.400 G	100.00 k	2.383340 G	-40.88	-30.84
2.483 G	10.000 G	100.00 k	3.792874 G	-39.13	-29.09
10.000 G	15.000 G	100.00 k	14.724000 G	-39.20	-29.16
15.000 G	20.000 G	100.00 k	17.091500 G	-38.29	-28.25
20.000 G	25.000 G	100.00 k	24.634000 G	-38.09	-28.05

Out of Band Emissions – 2442 MHz

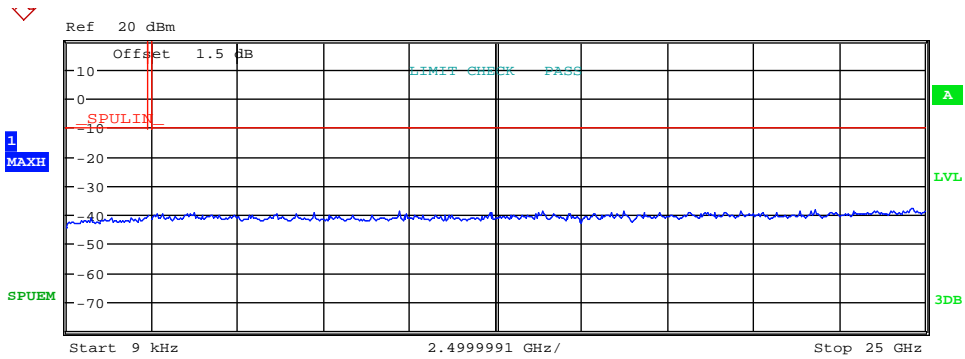

Start [Hz]	Stop [Hz]	RBW [Hz]	Freq [Hz]	PwrAbs [dBm]	ΔLimit [dB]
9.000 k	150.000 k	1.00 k	9.225962 k	-47.26	-37.22
150.000 k	30.000 M	10.00 k	152.985000 k	-44.62	-34.58
30.000 M	1.000 G	100.00 k	703.956000 M	-41.19	-31.15
1.000 G	2.400 G	100.00 k	2.388240 G	-40.56	-30.52
2.483 G	10.000 G	100.00 k	9.695582 G	-38.83	-28.79
10.000 G	15.000 G	100.00 k	13.845500 G	-38.96	-28.92
15.000 G	20.000 G	100.00 k	16.213000 G	-38.89	-28.85
20.000 G	25.000 G	100.00 k	24.647500 G	-37.80	-27.76

Out of Band Emissions – 2480 MHz

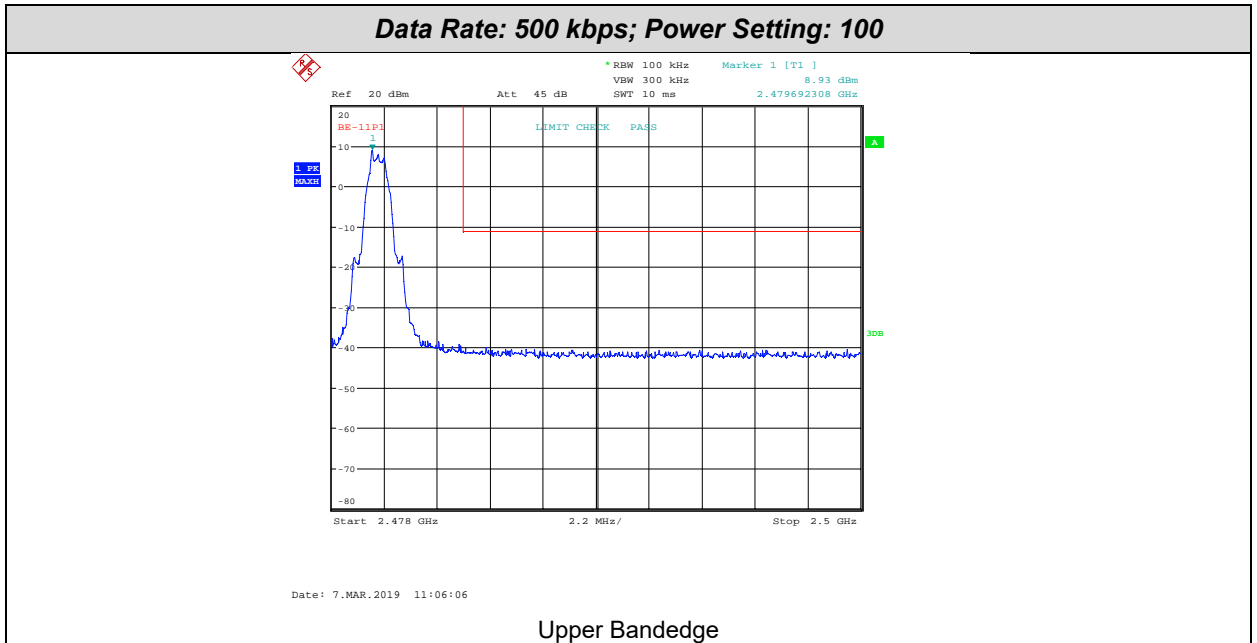

Data Rate: 1 Mbps; Power Setting: 100

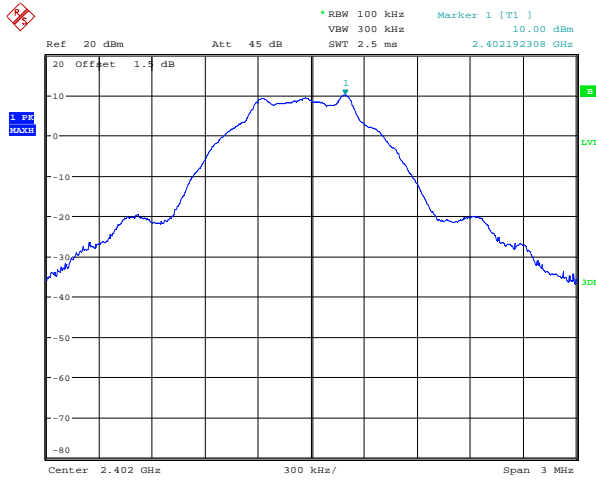

Reference Level

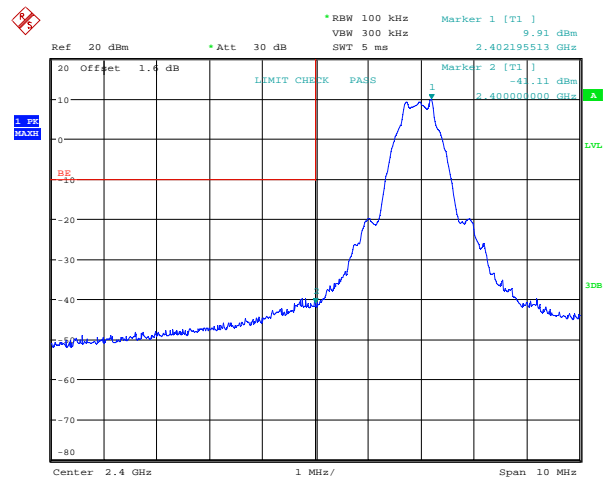

Lower Bandedge

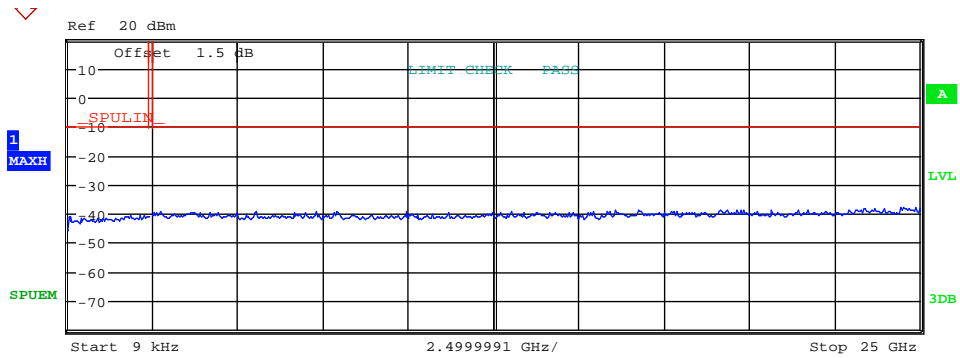

Start [Hz]	Stop [Hz]	RBW [Hz]	Freq [Hz]	PwrAbs [dBm]	Δ Limit [dB]
9.000 k	150.000 k	1.00 k	10.129808 k	-46.96	-36.96
150.000 k	30.000 M	10.00 k	197.760000 k	-45.86	-35.86
30.000 M	1.000 G	100.00 k	33.201000 M	-41.11	-31.11
1.000 G	2.400 G	100.00 k	2.254680 G	-40.80	-30.80
2.483 G	10.000 G	100.00 k	7.872079 G	-39.22	-29.22
10.000 G	15.000 G	100.00 k	13.019500 G	-39.24	-29.24
15.000 G	20.000 G	100.00 k	19.150000 G	-38.75	-28.75
20.000 G	25.000 G	100.00 k	24.522000 G	-37.96	-27.96

Out of Band Emissions – 2402 MHz

Data Rate: 1 Mbps; Power Setting: 100

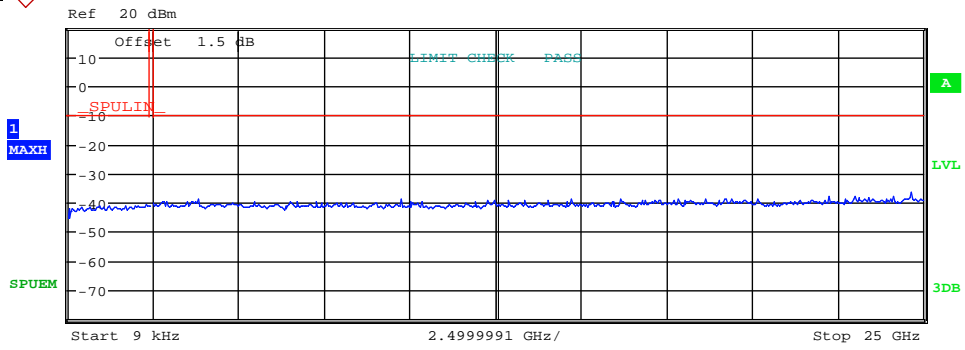

Start [Hz]	Stop [Hz]	RBW [Hz]	Freq [Hz]	PwrAbs [dBm]	ΔLimit [dB]
9.000 k	150.000 k	1.00 k	9.677885 k	-47.83	-37.83
150.000 k	30.000 M	10.00 k	182.835000 k	-45.65	-35.65
30.000 M	1.000 G	100.00 k	929.675000 M	-41.45	-31.45
1.000 G	2.400 G	100.00 k	2.303120 G	-40.68	-30.68
2.483 G	10.000 G	100.00 k	3.796633 G	-38.86	-28.86
10.000 G	15.000 G	100.00 k	14.703000 G	-39.14	-29.14
15.000 G	20.000 G	100.00 k	19.184000 G	-38.75	-28.75
20.000 G	25.000 G	100.00 k	24.637000 G	-36.39	-26.39

Out of Band Emissions – 2442 MHz

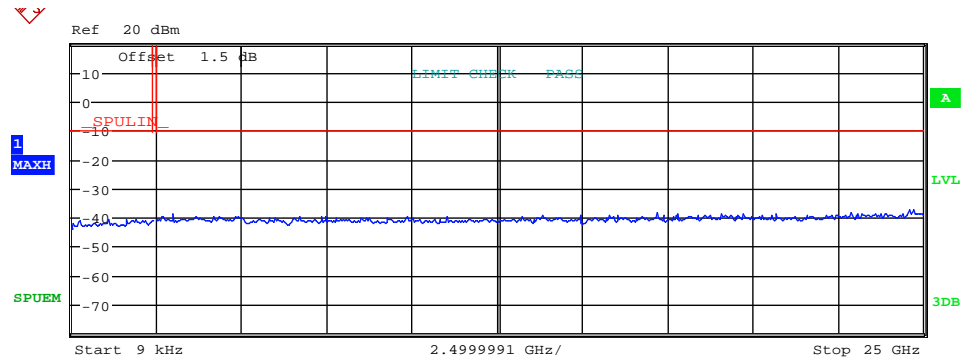

Start [Hz]	Stop [Hz]	RBW [Hz]	Freq [Hz]	PwrAbs [dBm]	ΔLimit [dB]
9.000 k	150.000 k	1.00 k	13.293269 k	-48.86	-38.86
150.000 k	30.000 M	10.00 k	176.865000 k	-44.05	-34.05
30.000 M	1.000 G	100.00 k	225.261000 M	-41.50	-31.50
1.000 G	2.400 G	100.00 k	1.883400 G	-40.89	-30.89
2.483 G	10.000 G	100.00 k	2.951778 G	-38.81	-28.81
10.000 G	15.000 G	100.00 k	13.818000 G	-39.39	-29.39
15.000 G	20.000 G	100.00 k	17.200500 G	-38.53	-28.53
20.000 G	25.000 G	100.00 k	24.728500 G	-37.48	-27.48

Out of Band Emissions – 2480 MHz

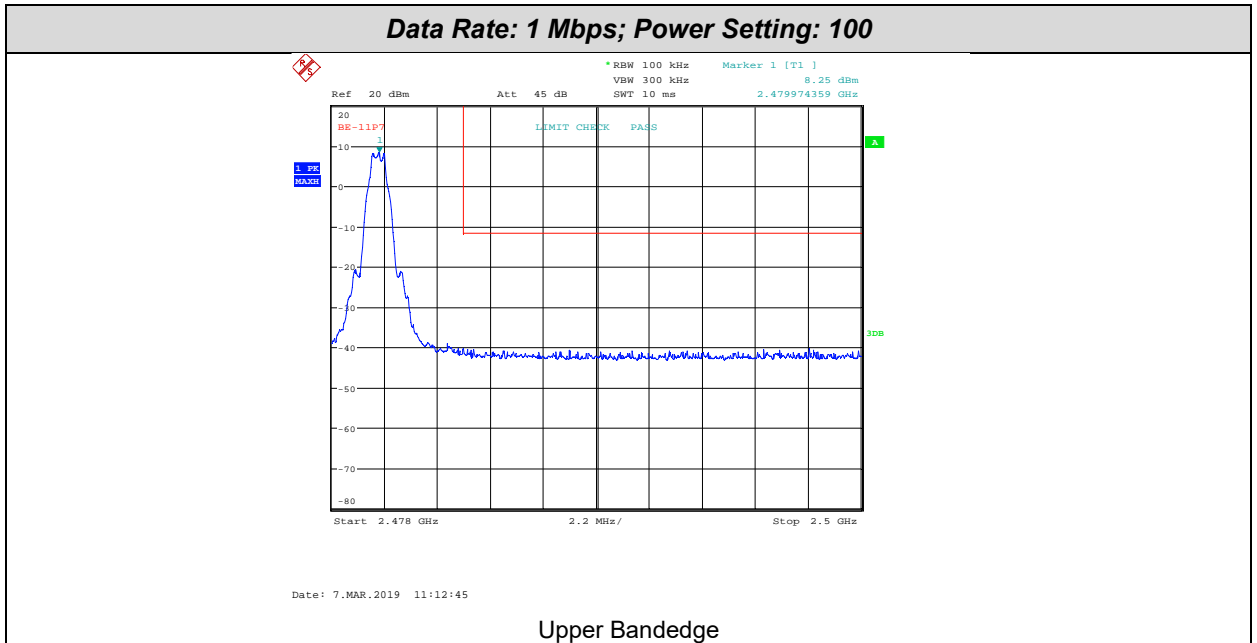

Data Rate: 2 Mbps; Power Setting: 100

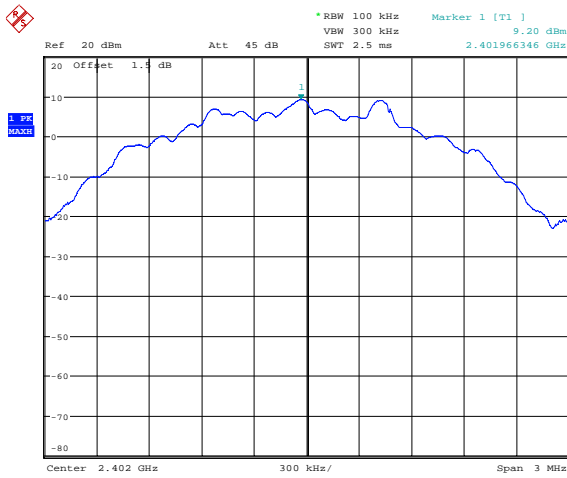

Reference Level

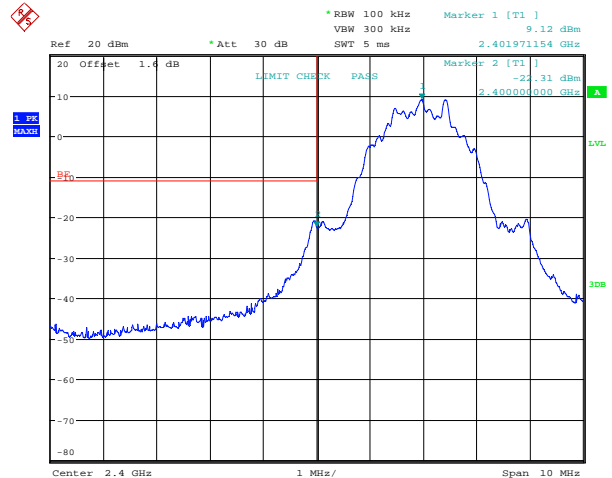

Lower Bandedge

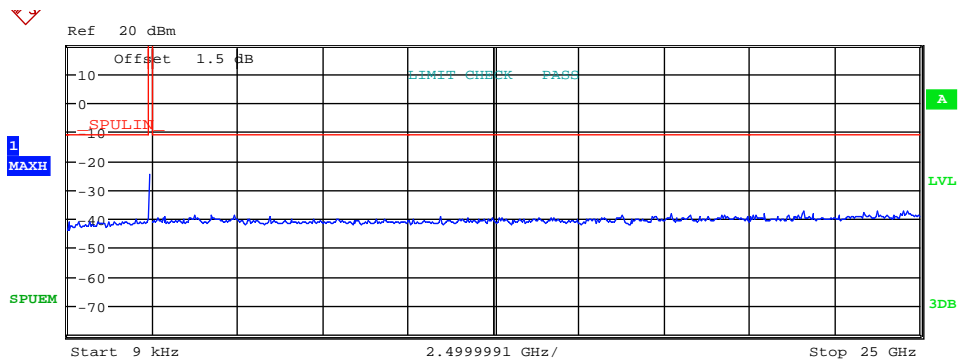

Start [Hz]	Stop [Hz]	RBW [Hz]	Freq [Hz]	PwrAbs [dBm]	ΔLimit [dB]
9.000 k	150.000 k	1.00 k	10.807692 k	-47.83	-37.03
150.000 k	30.000 M	10.00 k	150.000000 k	-44.26	-33.46
30.000 M	1.000 G	100.00 k	894.949000 M	-41.06	-30.26
1.000 G	2.400 G	100.00 k	2.399860 G	-29.45	-18.65
2.483 G	10.000 G	100.00 k	4.191249 G	-38.92	-28.12
10.000 G	15.000 G	100.00 k	10.931000 G	-39.42	-28.62
15.000 G	20.000 G	100.00 k	17.695500 G	-38.60	-27.80
20.000 G	25.000 G	100.00 k	23.756000 G	-37.32	-26.52

Out of Band Emissions – 2402 MHz

Data Rate: 2 Mbps; Power Setting: 100

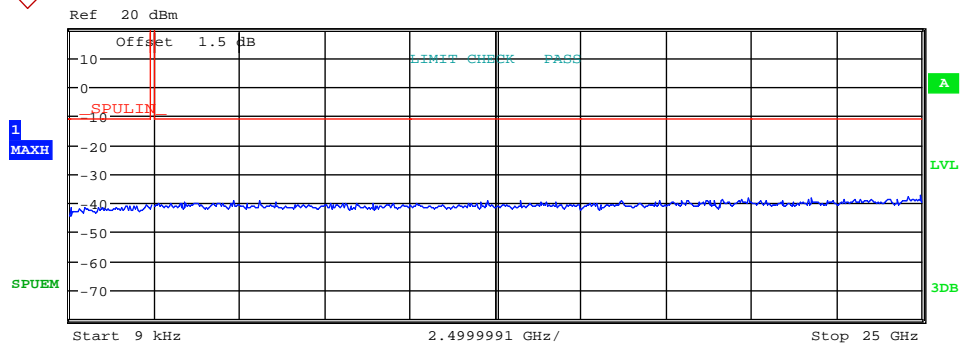

Start [Hz]	Stop [Hz]	RBW [Hz]	Freq [Hz]	PwrAbs [dBm]	ΔLimit [dB]
9.000 k	150.000 k	1.00 k	11.033654 k	-48.33	-37.53
150.000 k	30.000 M	10.00 k	152.985000 k	-44.44	-33.64
30.000 M	1.000 G	100.00 k	52.989000 M	-41.53	-30.73
1.000 G	2.400 G	100.00 k	2.234240 G	-40.84	-30.04
2.483 G	10.000 G	100.00 k	4.804595 G	-39.43	-28.63
10.000 G	15.000 G	100.00 k	12.245000 G	-39.30	-28.50
15.000 G	20.000 G	100.00 k	19.925500 G	-38.36	-27.56
20.000 G	25.000 G	100.00 k	24.940500 G	-37.40	-26.60

Out of Band Emissions – 2442 MHz

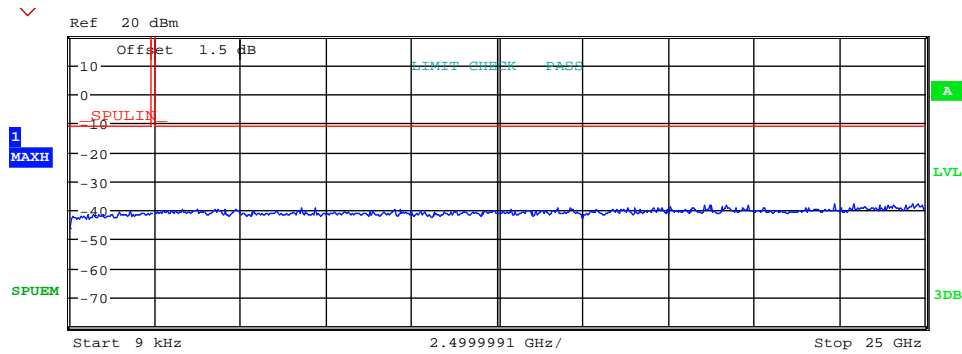

Start [Hz]	Stop [Hz]	RBW [Hz]	Freq [Hz]	PwrAbs [dBm]	ΔLimit [dB]
9.000 k	150.000 k	1.00 k	17.812500 k	-48.86	-38.06
150.000 k	30.000 M	10.00 k	167.910000 k	-46.30	-35.50
30.000 M	1.000 G	100.00 k	696.972000 M	-41.67	-30.87
1.000 G	2.400 G	100.00 k	1.750400 G	-40.40	-29.60
2.483 G	10.000 G	100.00 k	7.186574 G	-39.26	-28.46
10.000 G	15.000 G	100.00 k	14.280000 G	-39.53	-28.73
15.000 G	20.000 G	100.00 k	18.739000 G	-38.53	-27.73
20.000 G	25.000 G	100.00 k	24.802000 G	-37.85	-27.05

Out of Band Emissions – 2480 MHz

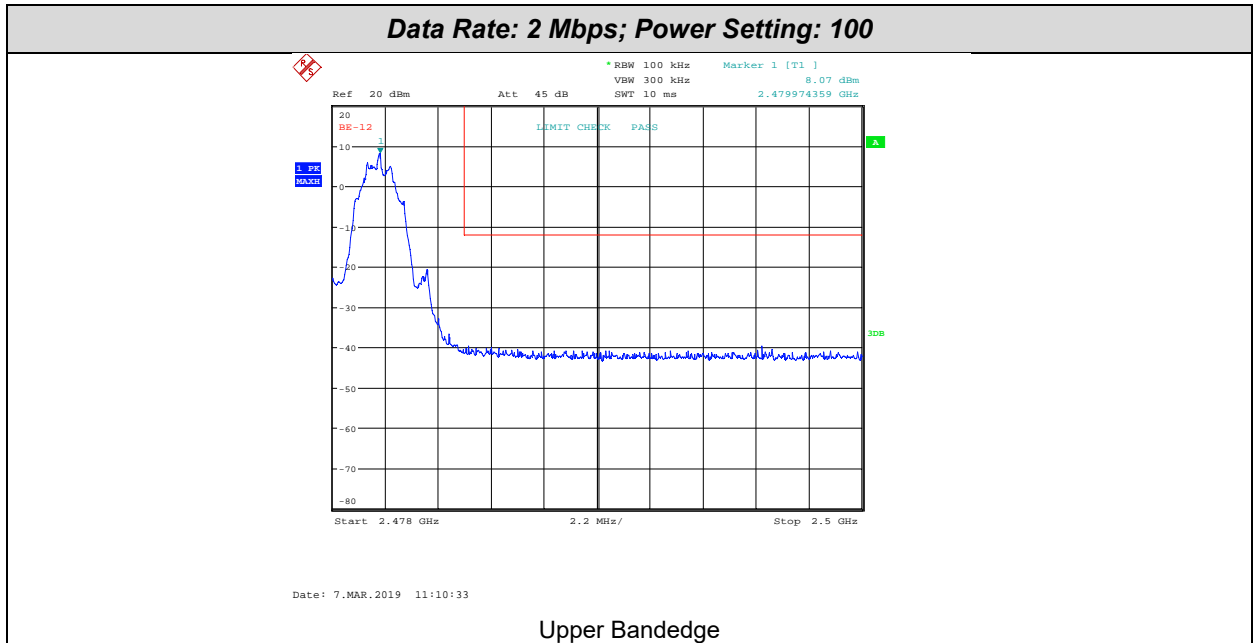

16 Power spectral density

16.1 Definition

The power per unit bandwidth.

16.2 Test Parameters

Test Location:	Element Hull
Test Chamber:	Wireless Laboratory 1
Test Standard and Clause:	ANSI C63.10-2013, Clause 11.10
EUT Frequencies Measured:	2402 MHz / 2442 MHz / 2480 MHz
EUT Channel Bandwidths:	1 MHz (or 2 MHz for 2M mode)
Deviations From Standard:	None
Measurement BW:	3 kHz
Spectrum Analyzer Video BW: (requirement at least 3x RBW)	10 kHz
Measurement Span: (requirement 1.5 times Channel BW)	1 MHz (1M), 1.7 MHz (2M), 1.1 MHz (125k and 500k)
Measurement Detector:	Peak

Environmental Conditions (Normal Environment)

Temperature: 23 °C	+15 °C to +35 °C (as declared)
Humidity: 32 % RH	20 % RH to 75 % RH (as declared)
Supply: 3.3 V dc	

16.3 Test Limit

The transmitter power spectral density conducted from the transmitter to the antenna shall not be greater than 8 dBm in any 3 kHz band during any time interval of continuous transmission.

16.4 Test Method

With the EUT setup as per section 9 of this report and connected as per Figure vi, the peak emission of the EUT was measured on a spectrum analyser, with path losses taken into account.

The measurements were performed with EUT set at its maximum duty. All modulation schemes, data rates and power settings were used to observe the worst case configuration in each bandwidth.

Figure vi Test Setup

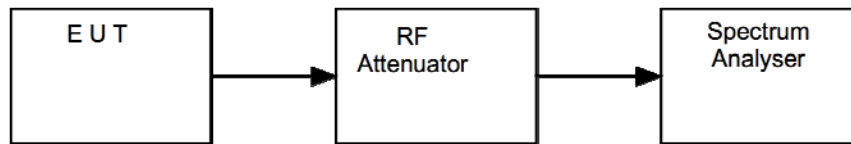

16.5 Test Equipment

Equipment Type	Manufacturer	Equipment Description	Element No	Due For Calibration
FSU46	R&S	Spectrum Analyser	U281	2019-11-20

16.6 Test Results

FCC 15.247. Modulation: BTLE; Data rate: 1M; Power setting: 126				
Channel Frequency (MHz)	Analyzer Level (dBm)	Cable loss (dB)	Power (dBm)	Result
2402	-3.4	0.6	-2.8	PASS
2442	-3.5	0.6	-2.9	PASS
2480	-3.5	0.6	-2.9	PASS

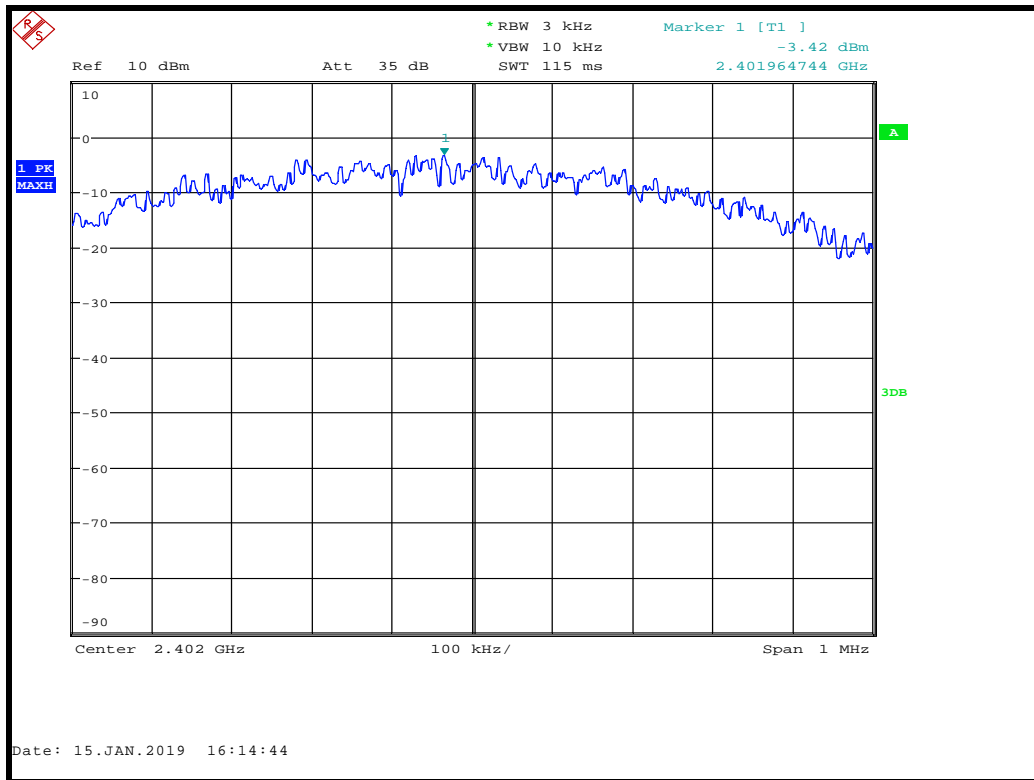

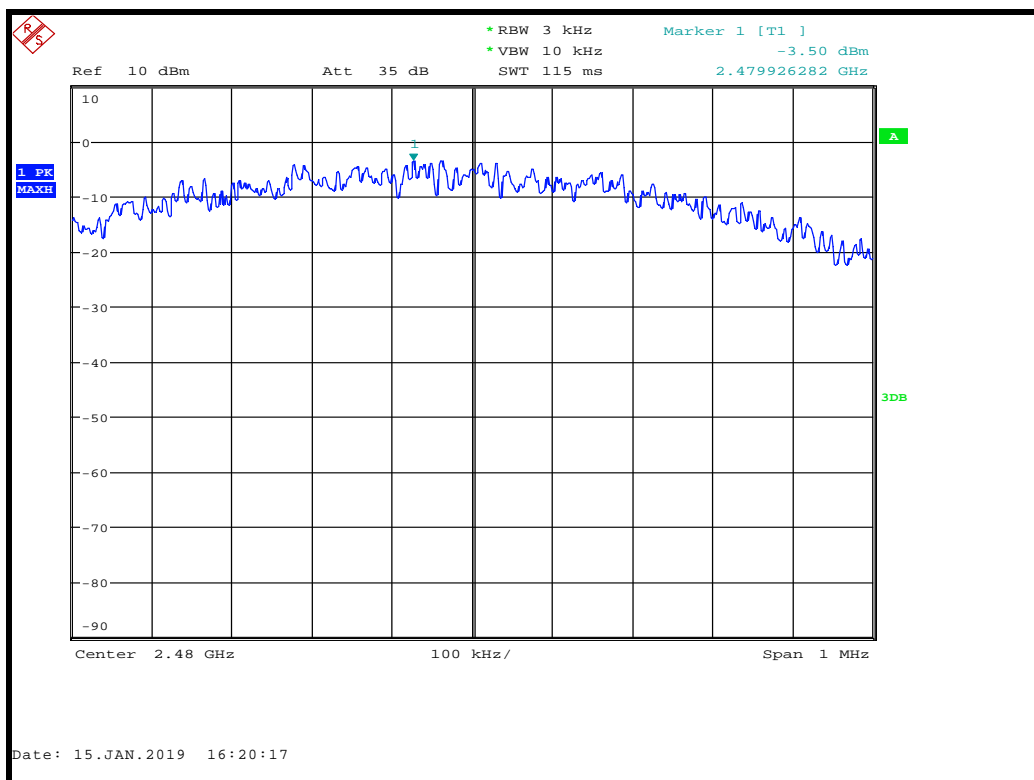
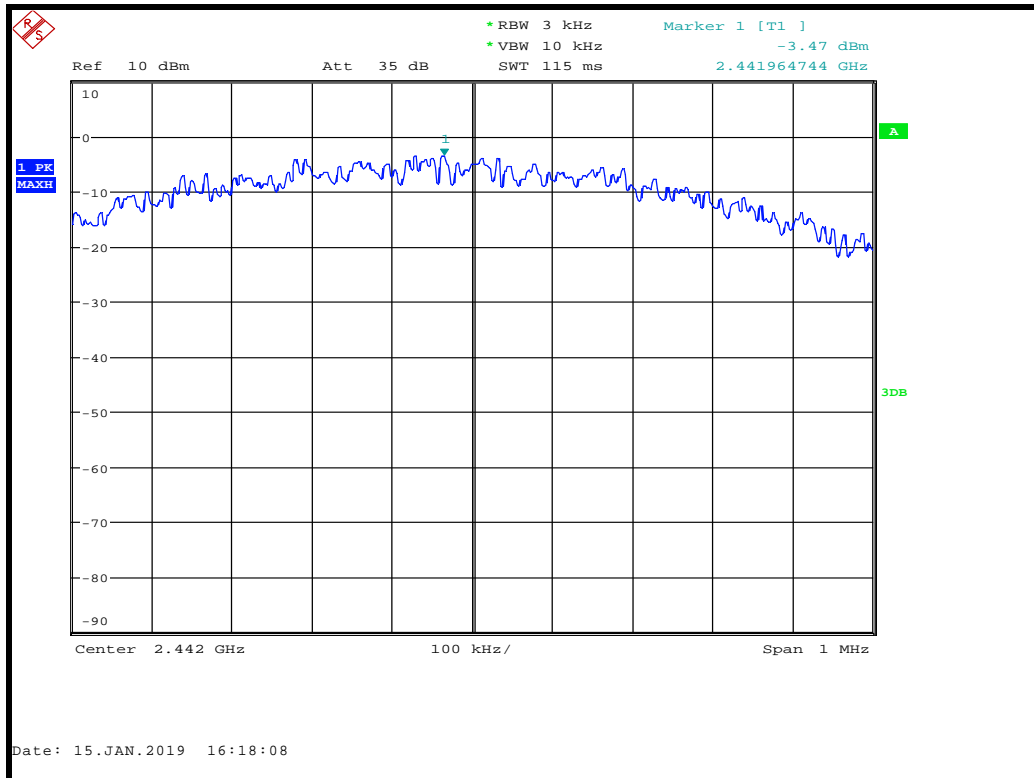

FCC 15.247. Modulation: BTLE; Data rate: 2M; Power setting: 126				
Channel Frequency (MHz)	Analyzer Level (dBm)	Cable loss (dB)	Power (dBm)	Result
2402	-5.7	0.6	-5.1	PASS
2442	-5.7	0.6	-5.1	PASS
2480	-5.7	0.6	-5.1	PASS

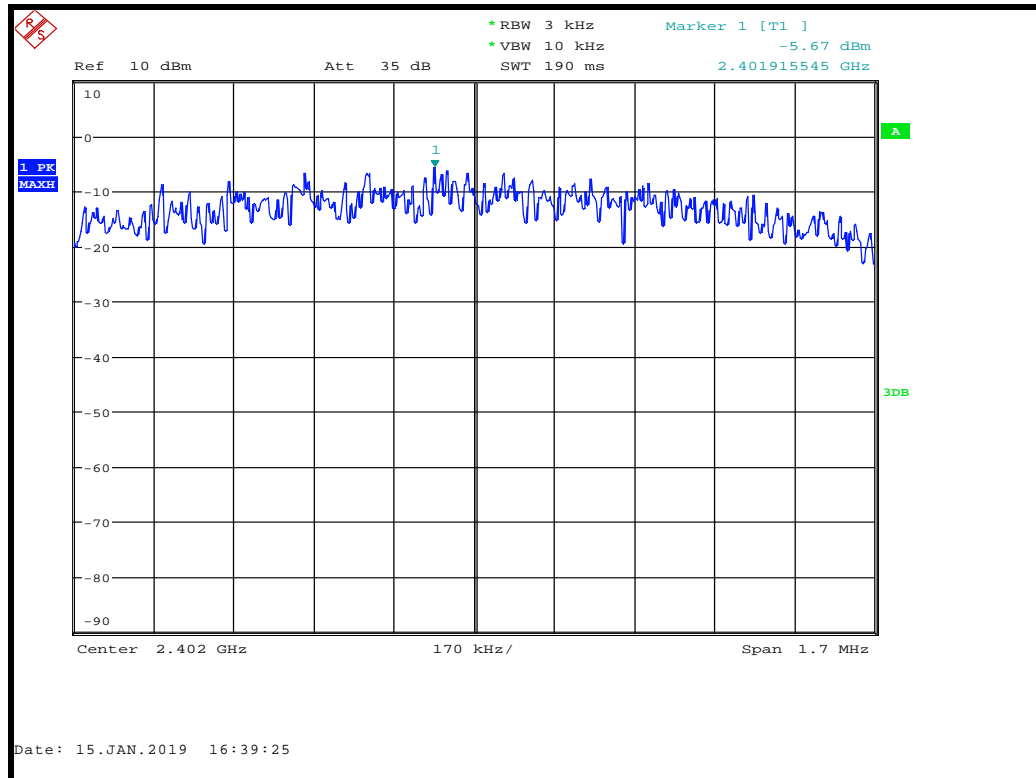

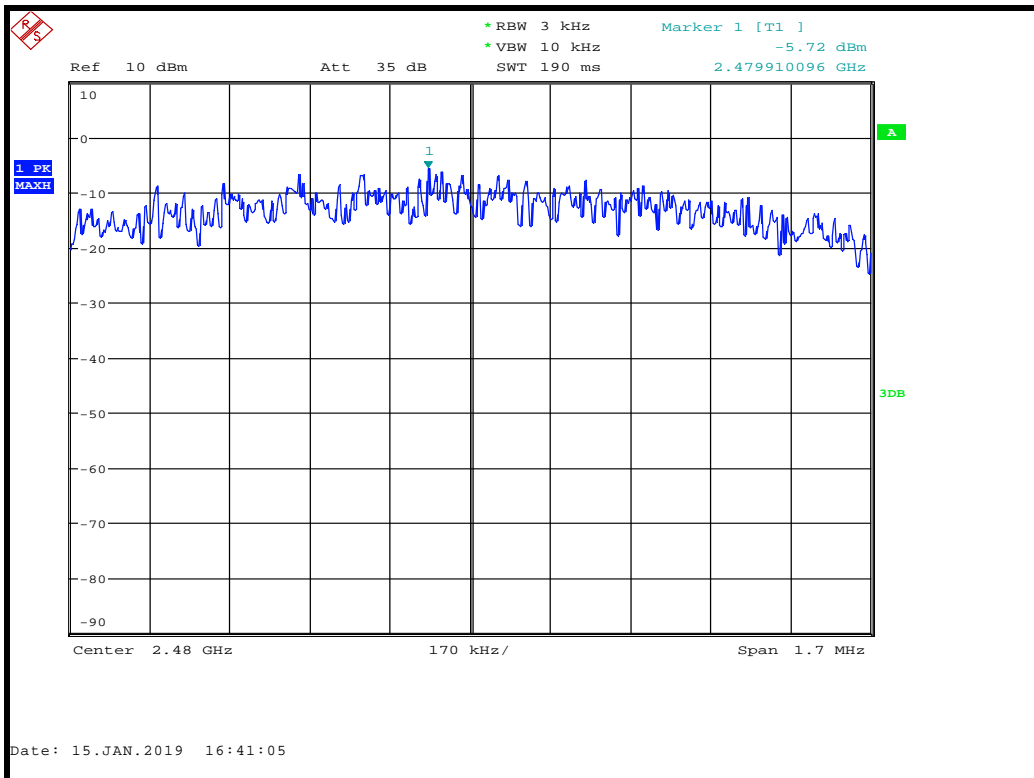
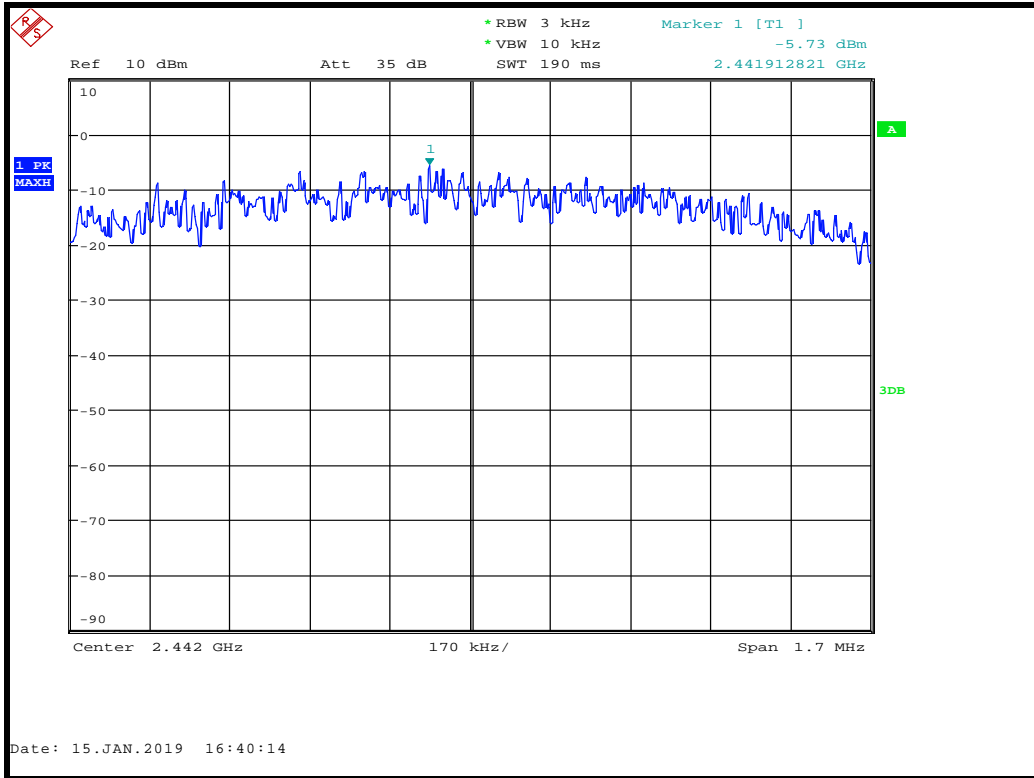

FCC 15.247. Modulation: BTLE; Data rate: 125k; Power setting: 126				
Channel Frequency (MHz)	Analyzer Level (dBm)	Cable loss (dB)	Power (dBm)	Result
2402	6.5	0.6	7.1	PASS
2442	6.4	0.6	7.0	PASS
2480	6.4	0.6	7.0	PASS

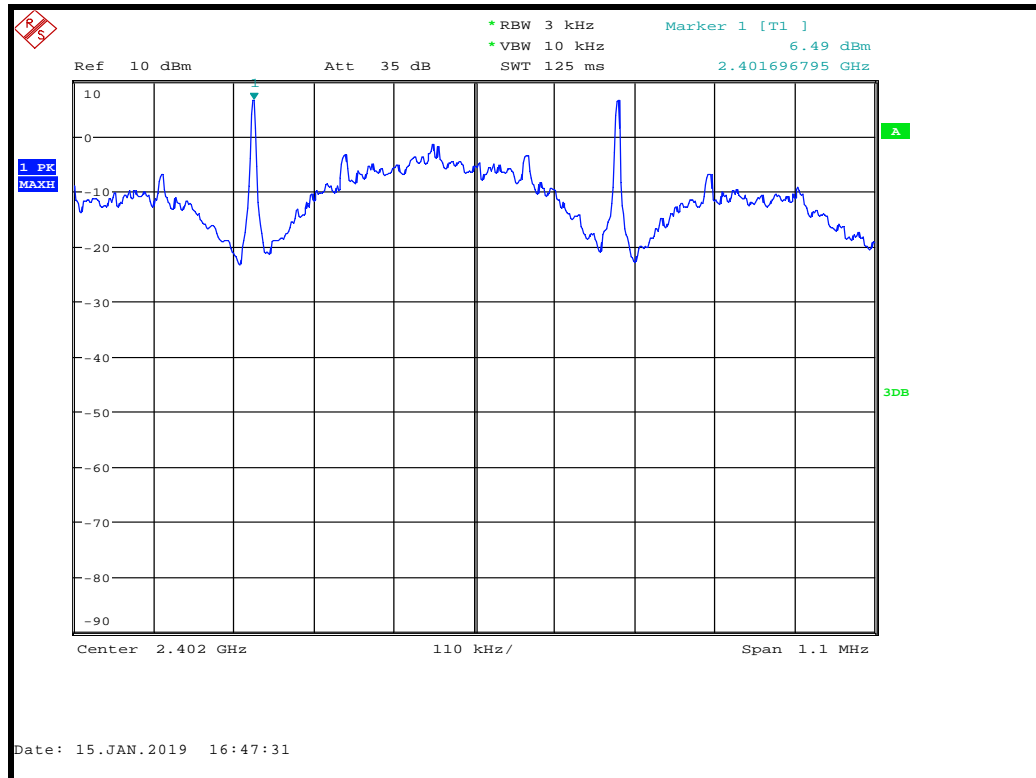

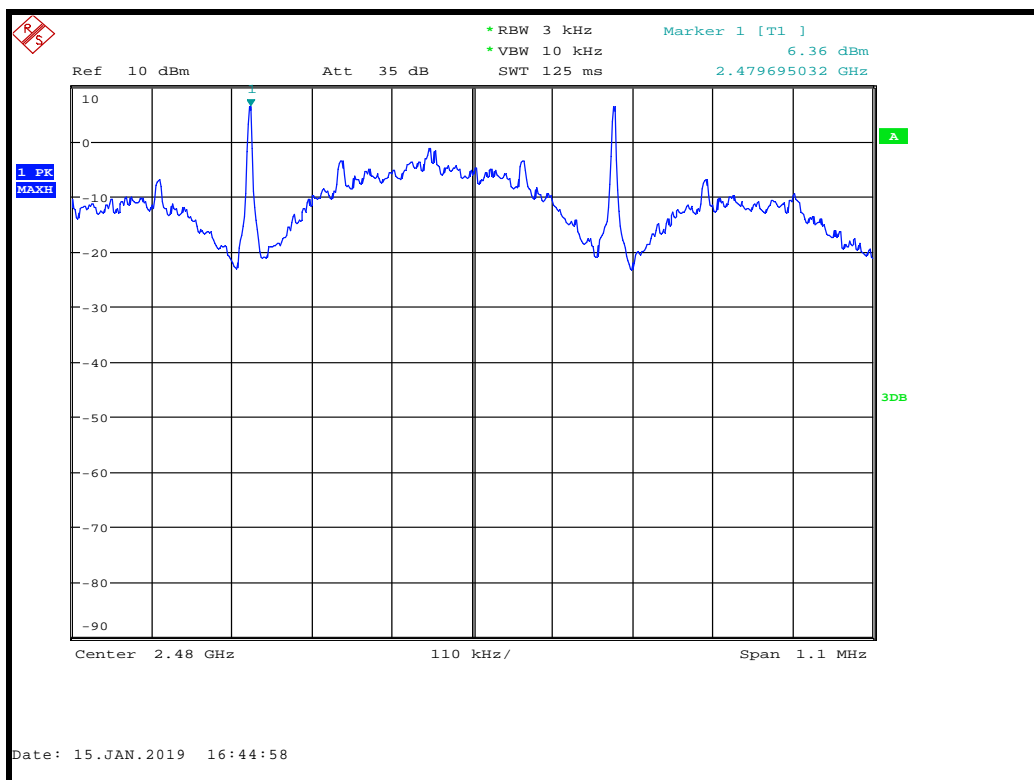
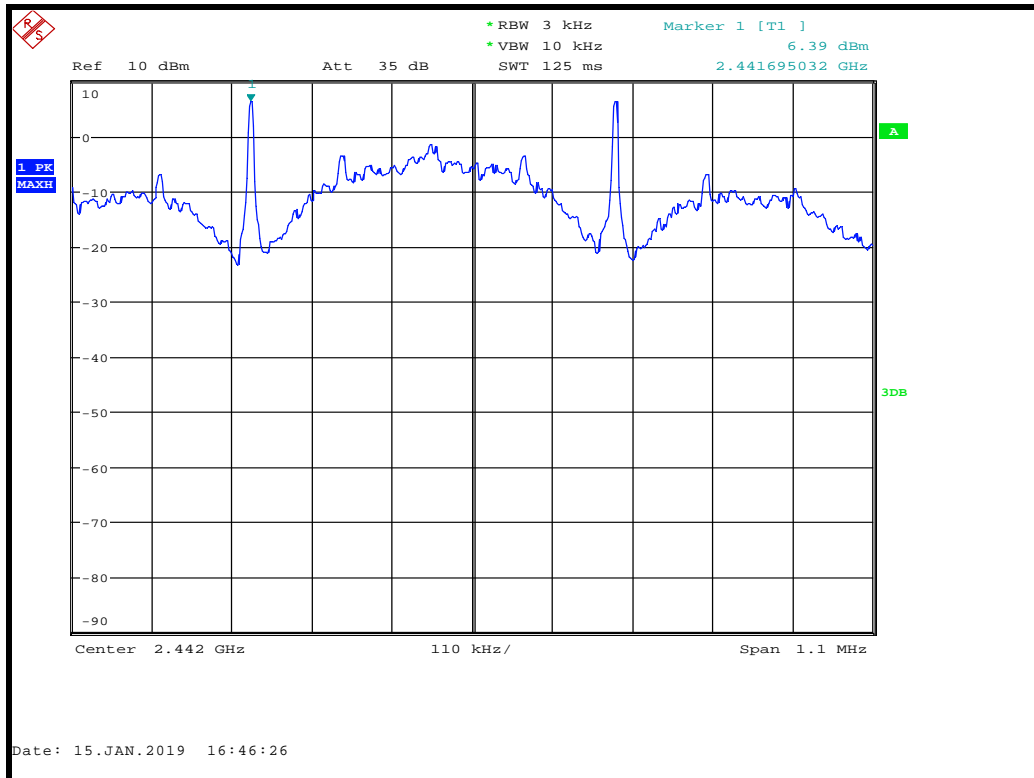

FCC 15.247. Modulation: BTLE; Data rate: 500k; Power setting: 126				
Channel Frequency (MHz)	Analyzer Level (dBm)	Cable loss (dB)	Power (dBm)	Result
2402	6.4	0.6	7.0	PASS
2442	6.3	0.6	6.9	PASS
2480	6.2	0.6	6.8	PASS

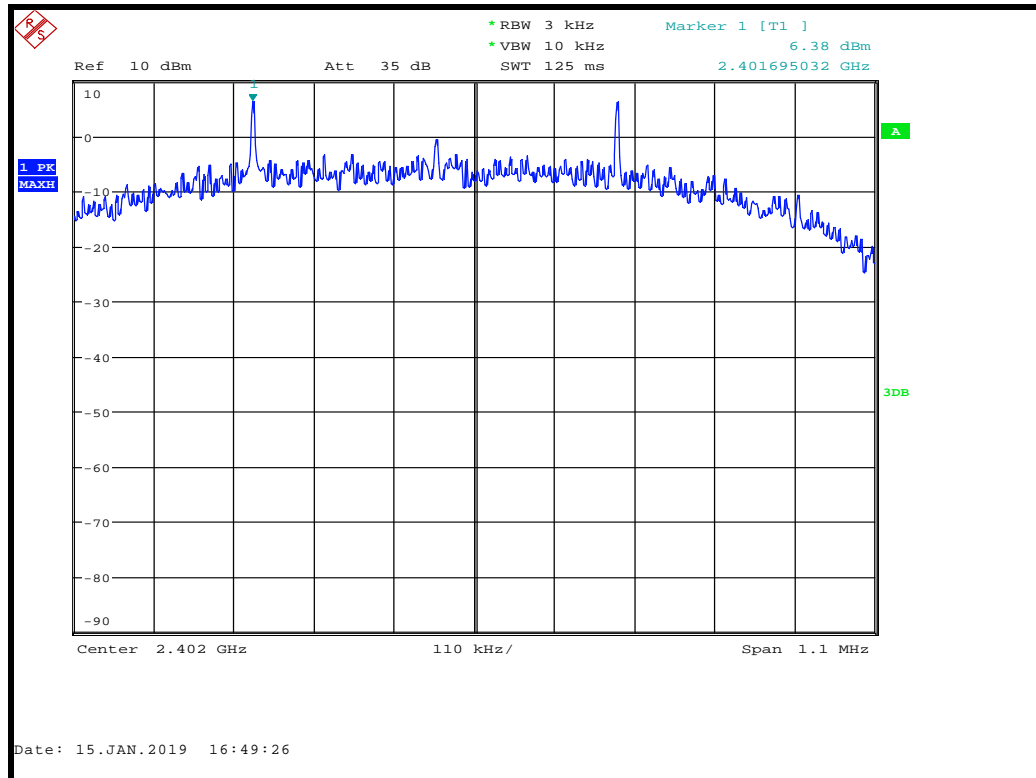

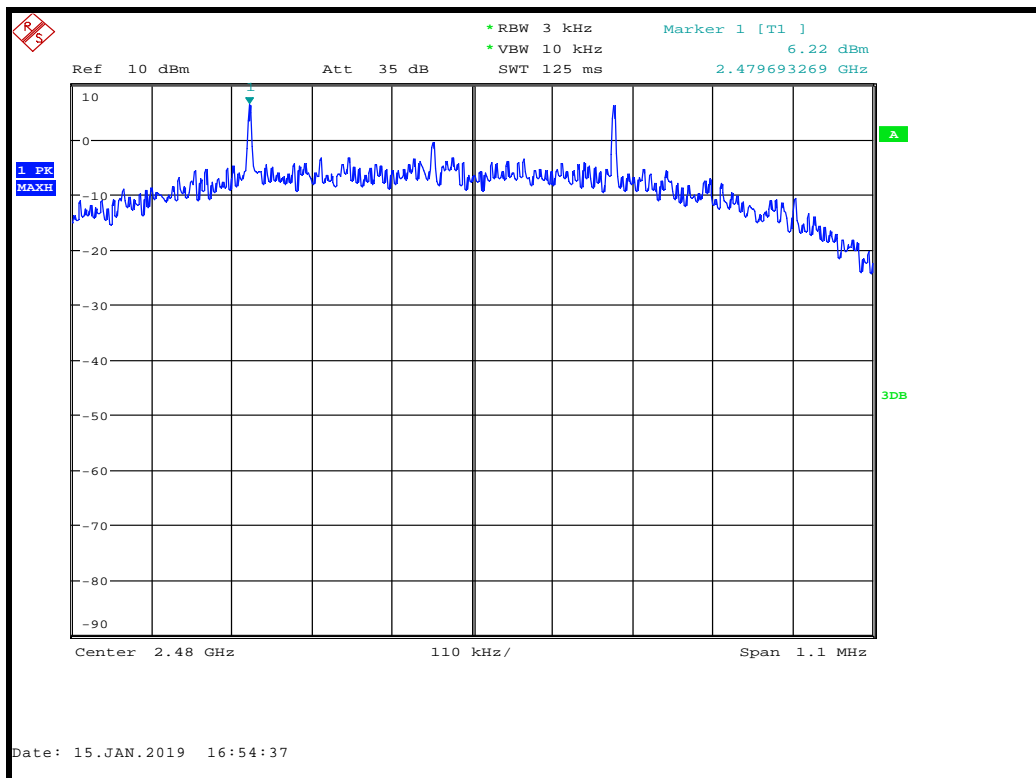
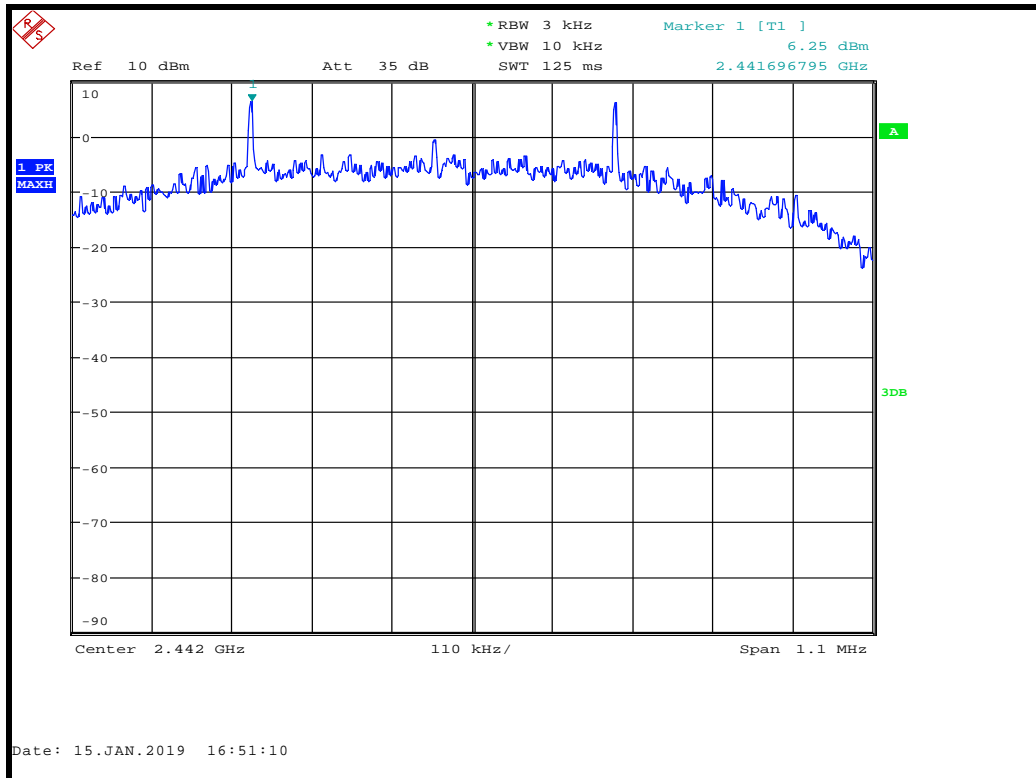

FCC 15.247. Modulation: BTLE; Data rate: 1M; Power setting: 100				
Channel Frequency (MHz)	Analyzer Level (dBm)	Cable loss (dB)	Power (dBm)	Result
2402	-6.3	0.6	-5.7	PASS
2442	-6.3	0.6	-5.7	PASS
2480	-6.3	0.6	-5.7	PASS

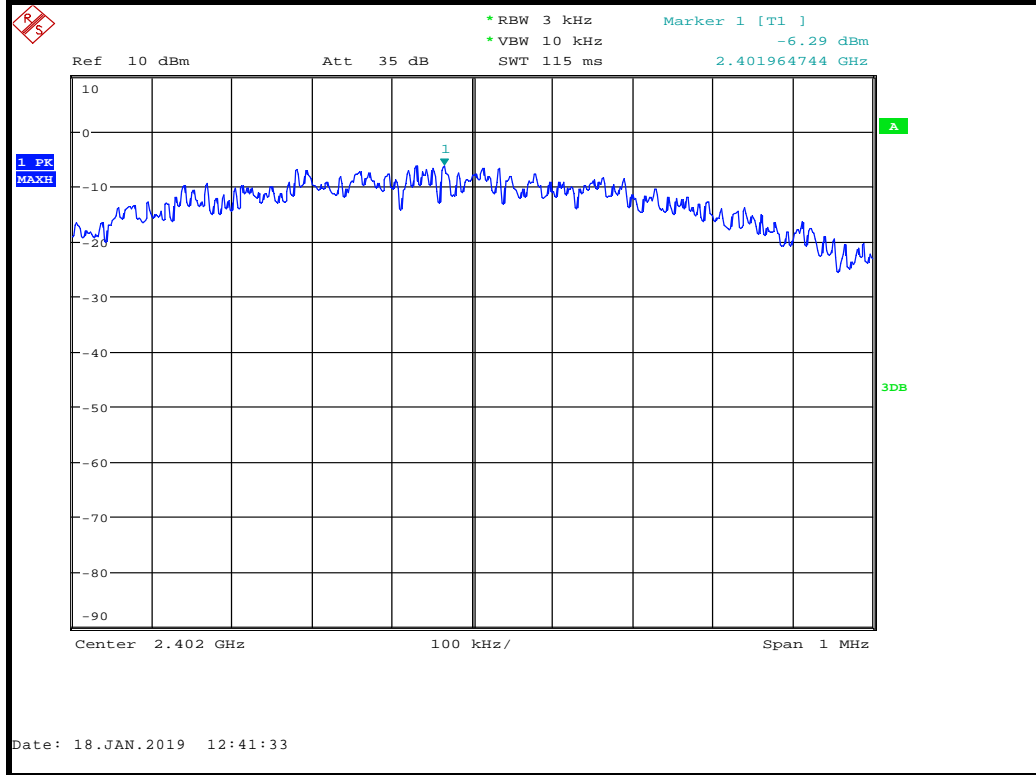

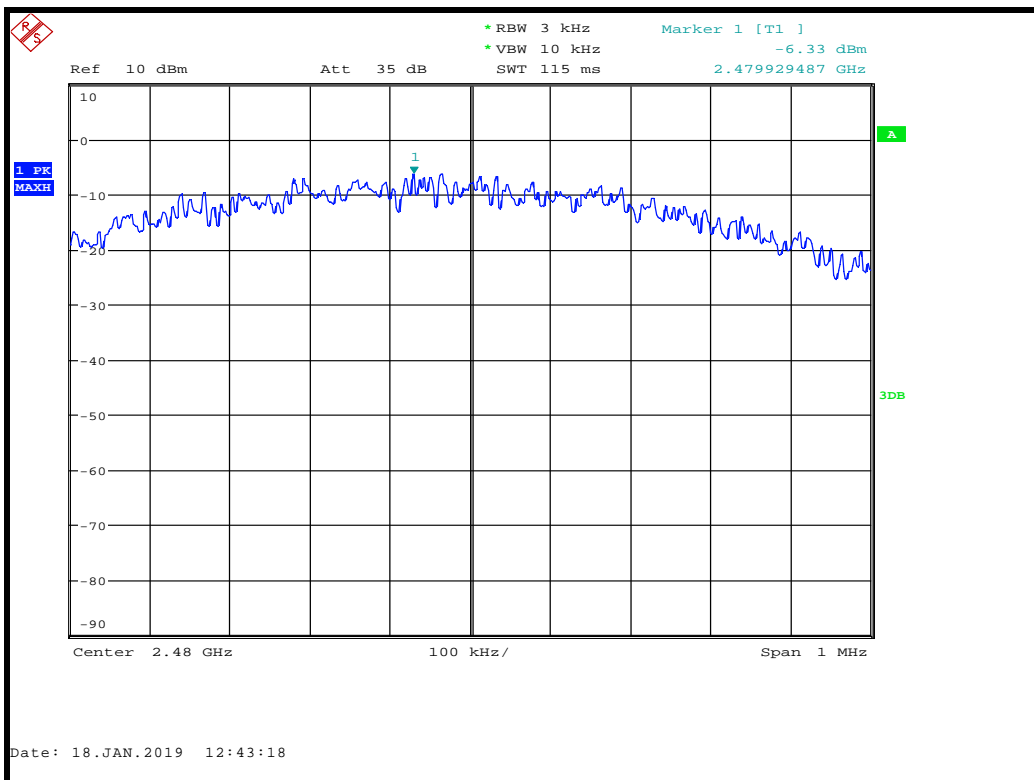
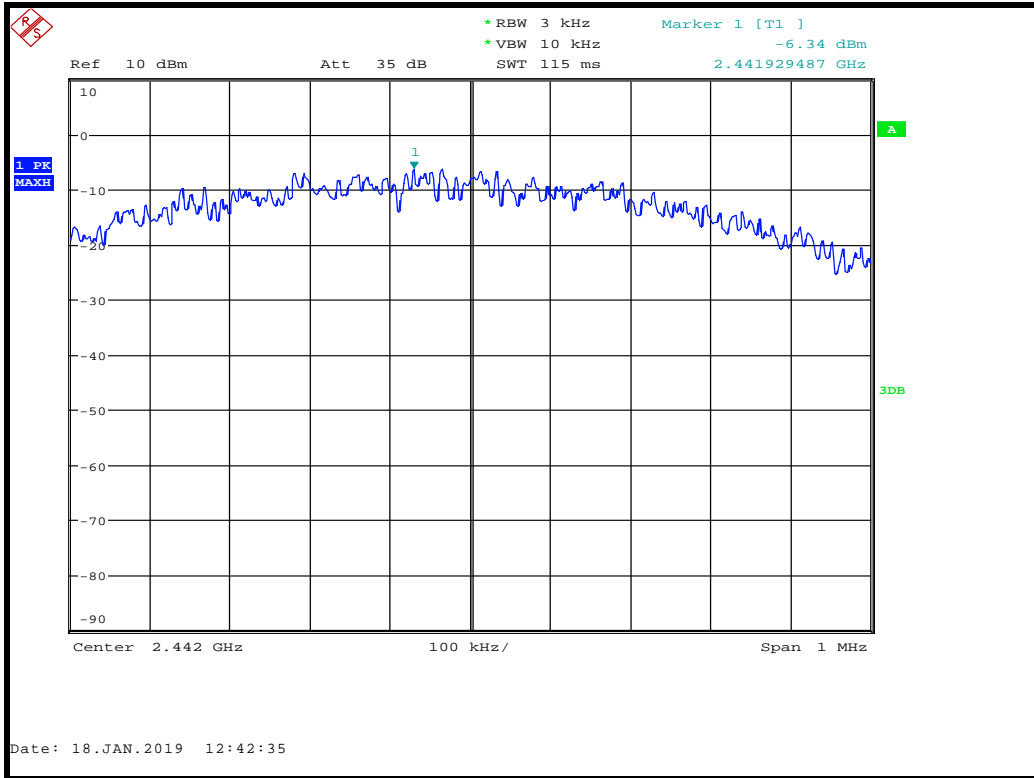

FCC 15.247. Modulation: BTLE; Data rate: 2M; Power setting: 100				
Channel Frequency (MHz)	Analyzer Level (dBm)	Cable loss (dB)	Power (dBm)	Result
2402	-8.5	0.6	-7.9	PASS
2442	-8.6	0.6	-8.0	PASS
2480	-8.5	0.6	-7.9	PASS

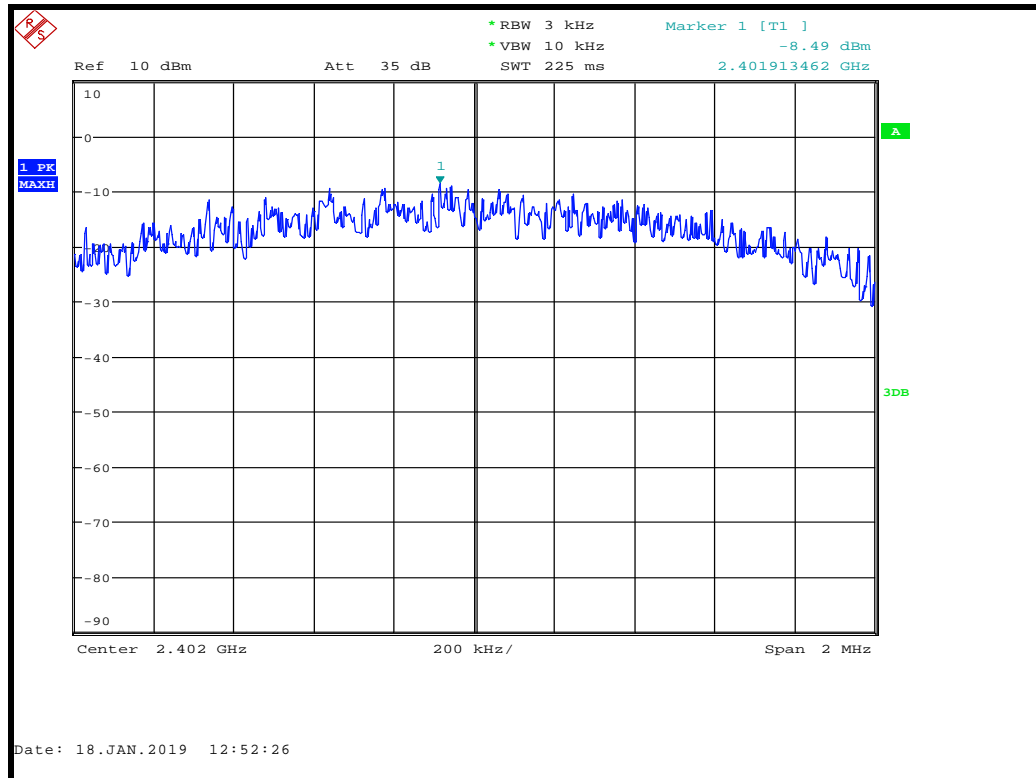

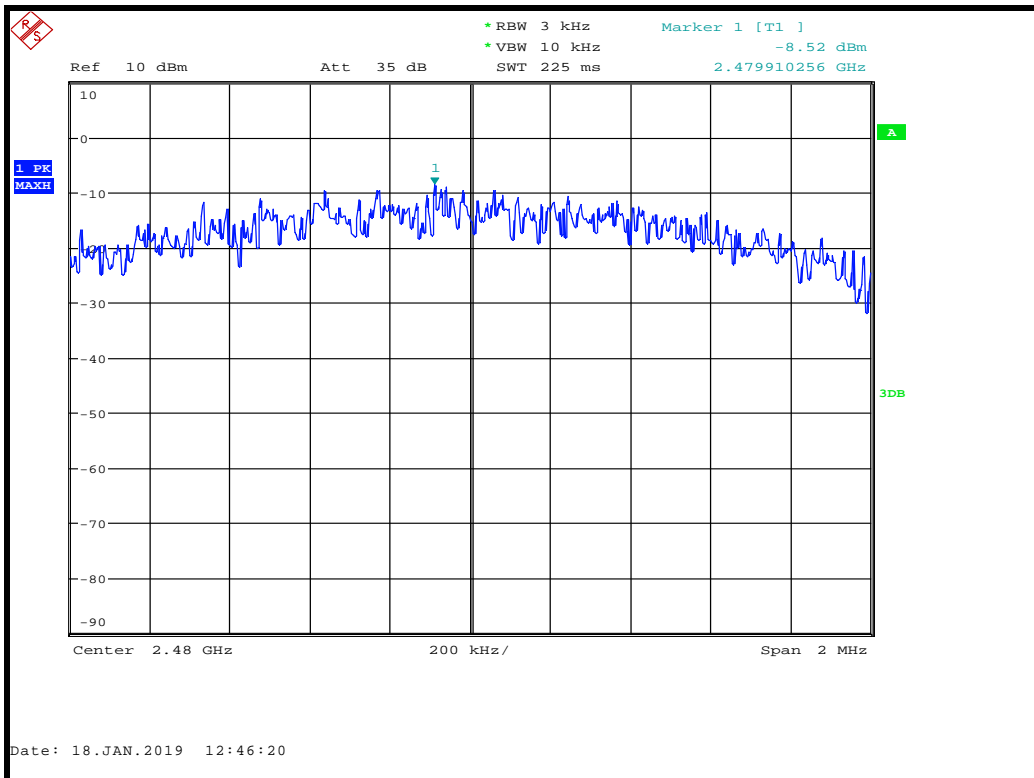
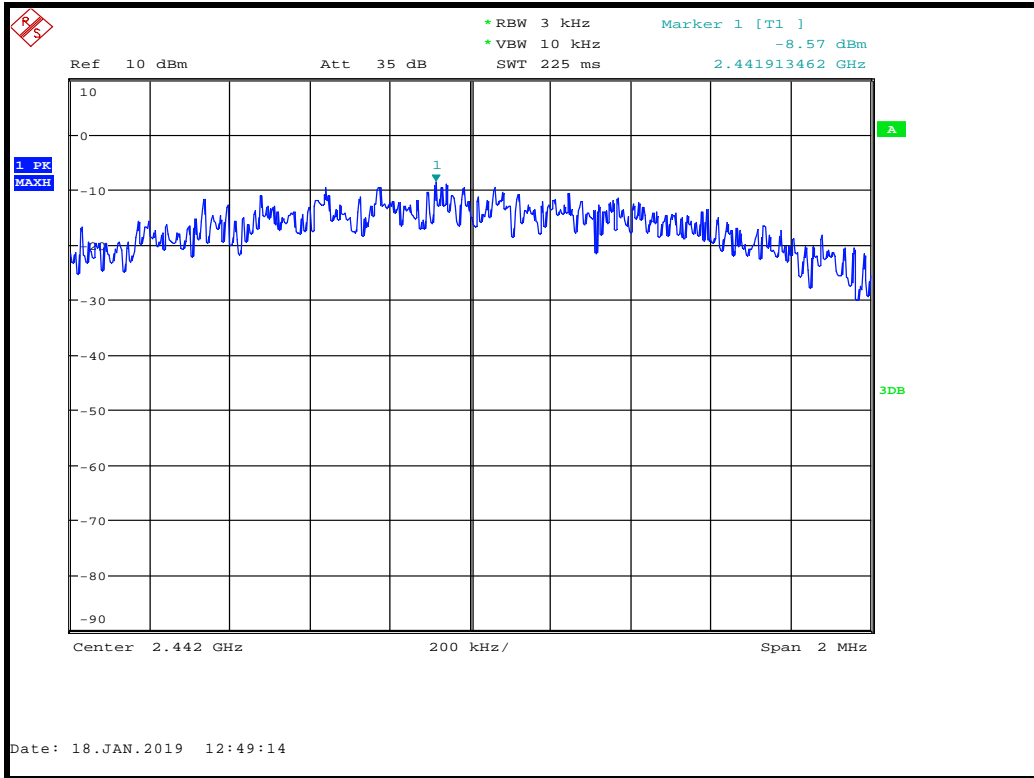

FCC 15.247. Modulation: BTLE; Data rate: 125k; Power setting: 100				
Channel Frequency (MHz)	Analyzer Level (dBm)	Cable loss (dB)	Power (dBm)	Result
2402	3.7	0.6	4.3	PASS
2442	3.6	0.6	4.2	PASS
2480	3.6	0.6	4.2	PASS

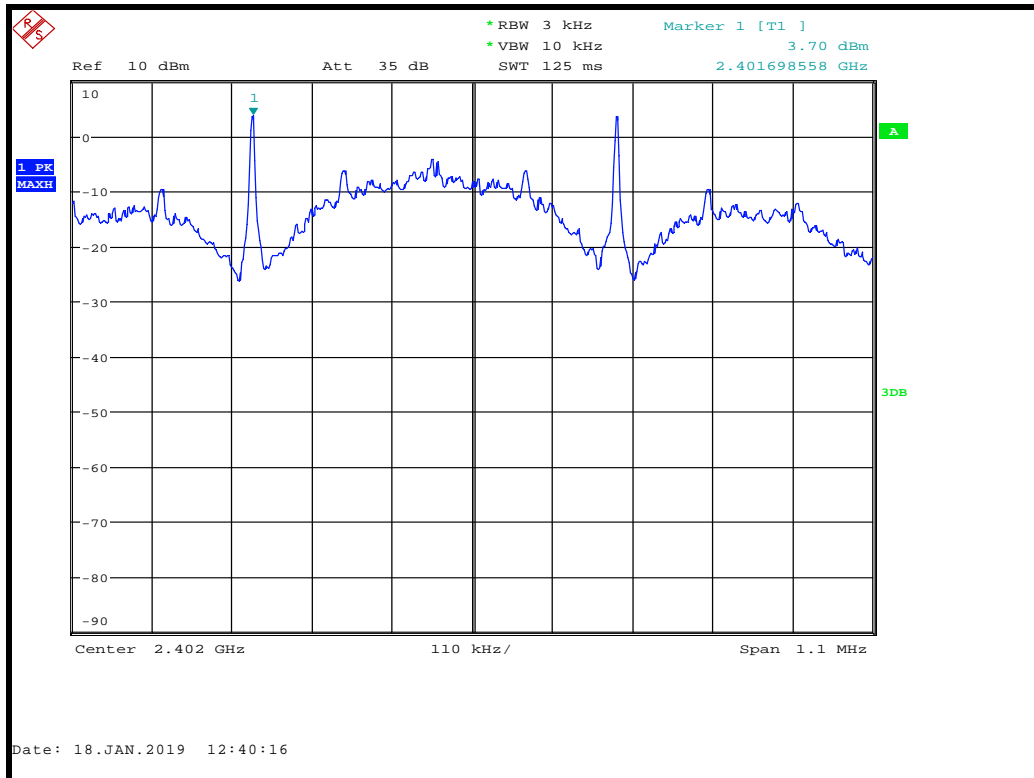

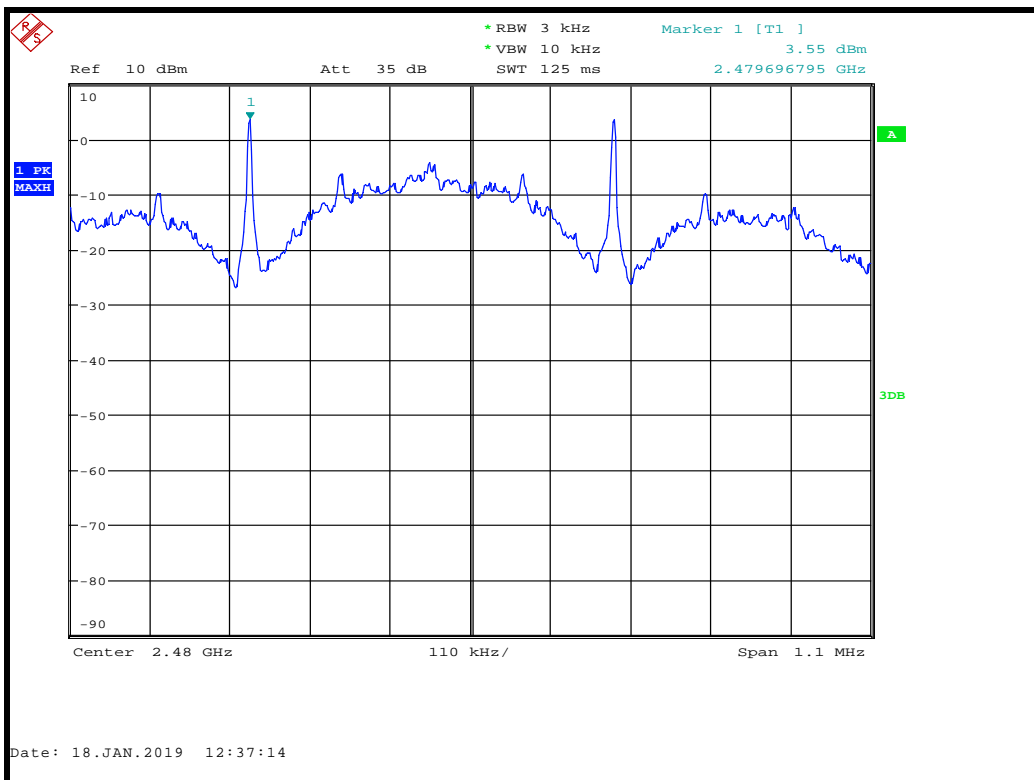
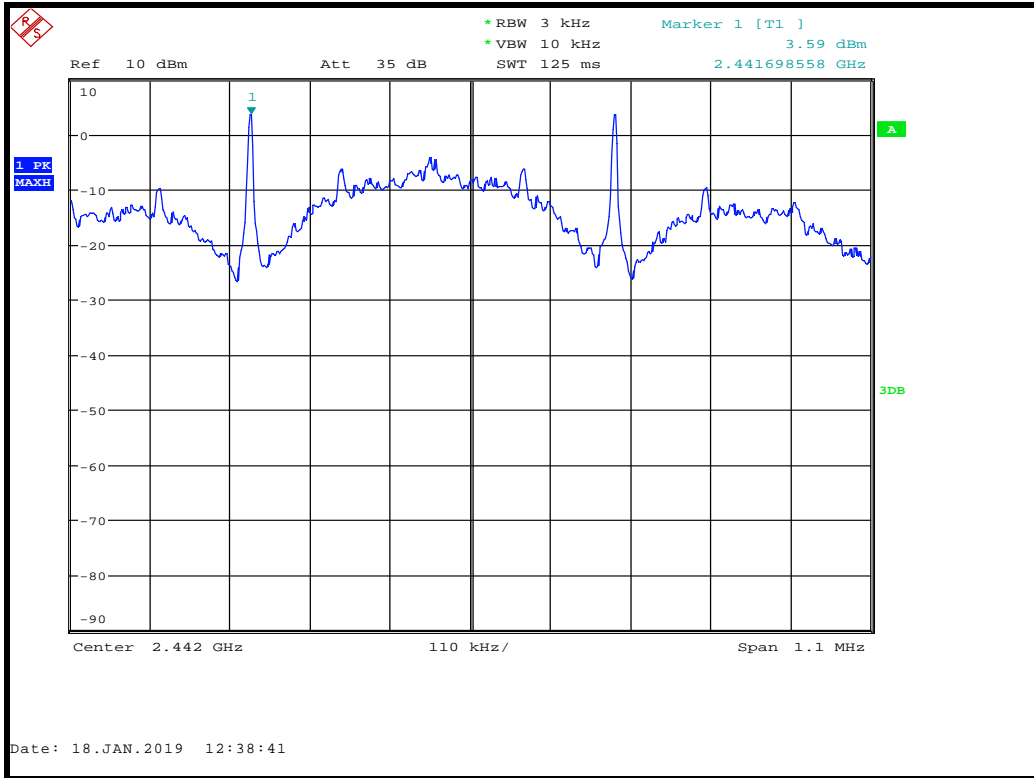

FCC 15.247. Modulation: BTLE; Data rate: 500k; Power setting: 100				
Channel Frequency (MHz)	Analyzer Level (dBm)	Cable loss (dB)	Power (dBm)	Result
2402	3.6	0.6	4.2	PASS
2442	3.5	0.6	4.1	PASS
2480	3.4	0.6	4.0	PASS

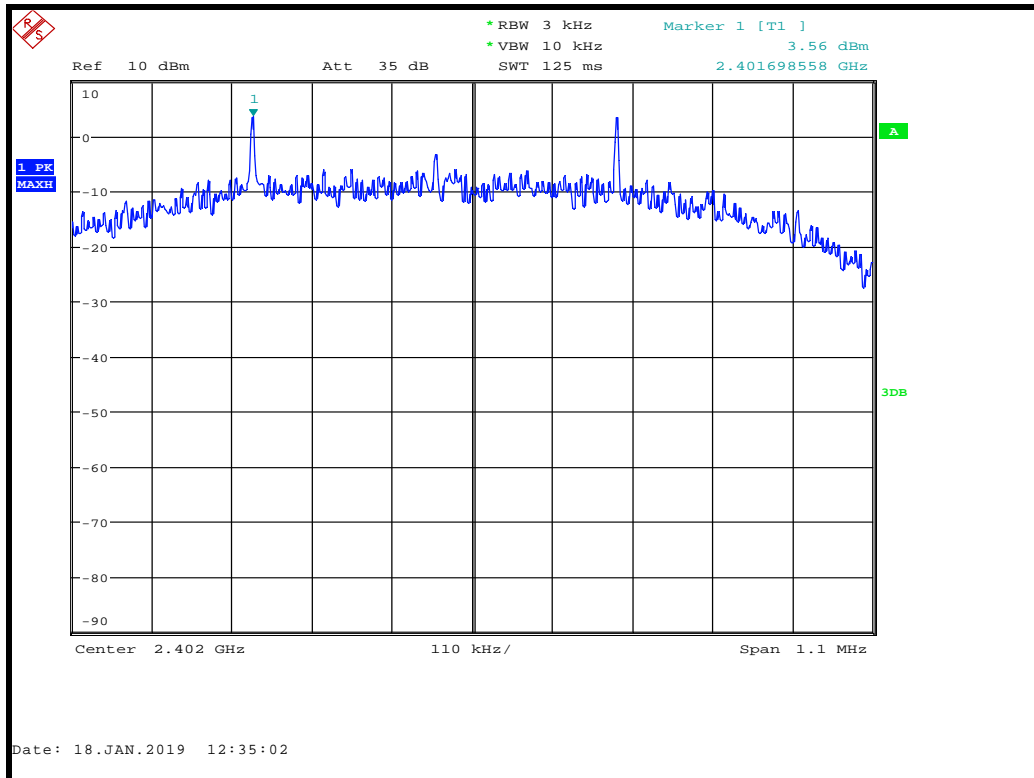

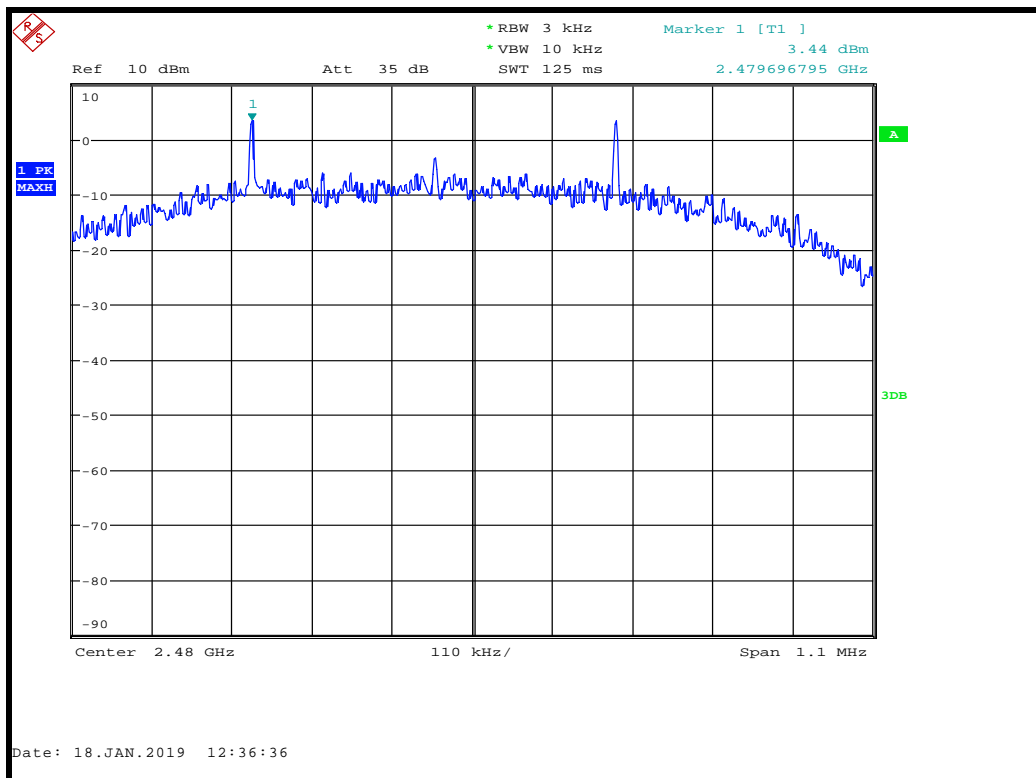
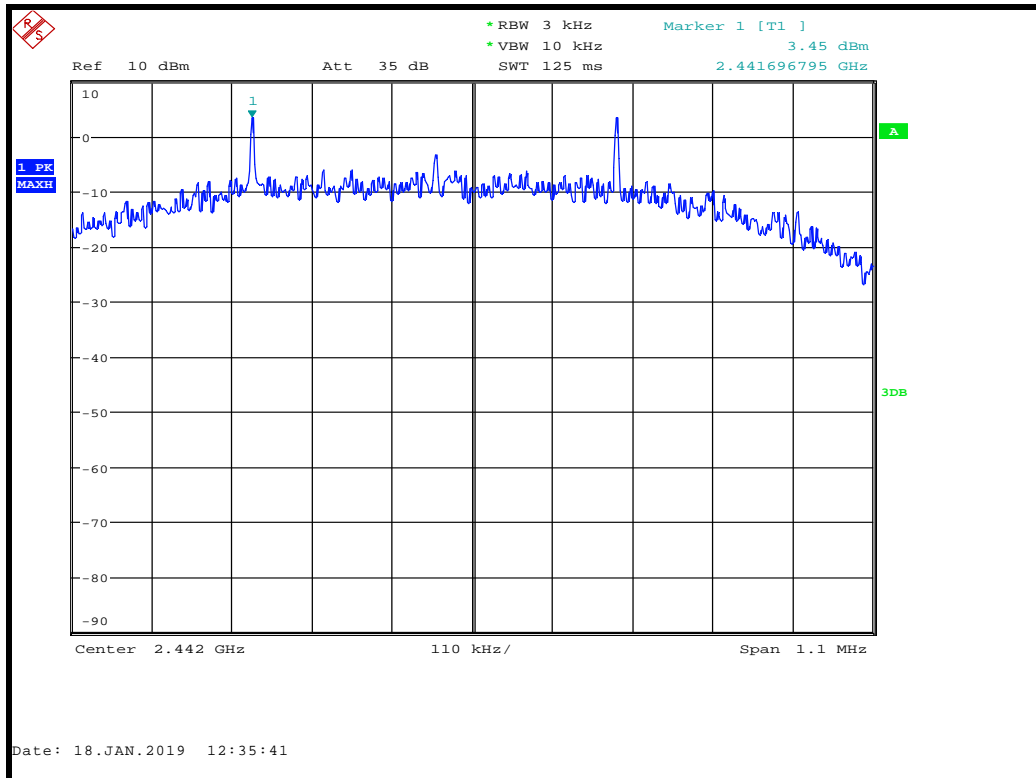

17 Measurement Uncertainty

Calculated Measurement Uncertainties

All statements of uncertainty are expanded standard uncertainty using a coverage factor of 1.96 to give a 95 % confidence:

[1] Radiated spurious emissions

Uncertainty in test result (30 MHz to 1 GHz) = **4.75 dB**

Uncertainty in test result (1 GHz to 18 GHz) = **4.46 dB**

[2] AC power line conducted emissions

Uncertainty in test result = **3.2 dB**

[3] Occupied bandwidth

Uncertainty in test result = **15.58 %**

[4] Conducted carrier power

Uncertainty in test result (Power Meter) = **0.93 dB**

[5] Conducted RF power out-of-band

Uncertainty in test result – up to 8.1 GHz = **3.31 dB**

Uncertainty in test result – 8.1 GHz to 15.3 GHz = **4.43 dB**

[6] Radiated RF power out-of-band

Uncertainty in test result (30 MHz to 1 GHz) = **4.75 dB**

Uncertainty in test result (1 GHz to 18 GHz) = **4.46 dB**

[7] Power spectral density

Uncertainty in test result (Spectrum Analyser) = **3.11 dB**

[8] ERP / EIRP

Uncertainty in test result (Laboratory) = **4.71 dB**

Uncertainty in test result (Pershore OATS) = **4.26 dB**

18 RF Exposure

KDB 447498

Section 4.3 General SAR test reduction and exclusion guidance

For Standalone SAR exclusion consideration, when SAR Exclusion Threshold requirement in KDB 447498 is satisfied, standalone SAR evaluation for general population exposure conditions by measurement or numerical simulation is not required.

In the frequency range below 100 MHz to 6 GHz and test separation distance of 50 mm, the SAR Test Exclusion Threshold for operation in the 2400 – 2483.5 MHz band will be determined as follows

SAR Exclusion Threshold (SARET)

SAR Exclusion Threshold = Step 1 + Step 2

Step 1

$$NT = [(MP/TSD^A) * \sqrt{f_{GHz}}]$$

NT = Numeric Threshold (3.0 for 1-g SAR and 7.5 for 10-g SAR)
 MP = Max Power of channel (mW) (inc tune up)
 TSD^A = Min Test separation Distance or 50mm (whichever is lower)

We can transpose this formula to allow us to find the maximum power of a channel allowed and compare this to the measured maximum power.

$$= [(NT \times TSD^A) / \sqrt{f_{GHz}}]$$

For Distances Greater than 50 mm Step 2 applies

Step 2

$$(TSD^B - 50mm) * 10\}$$

Where:

TSD^B = Min Test separation Distance (mm)

Re-arranging for Min. Test separation Distance (mm):

$$TSD = (Max Power of channel / 3.0) * \sqrt{f_{GHz}}$$

In order to find the closest test separation distance at which the EUT meets the requirements:

Channel Frequency (MHz)	Conducted Power (mW)	Calculated TSD (mm)	SAR Evaluation
2402	21	10.85	Not Required
2442	21	10.94	Not Required
2480	21	11.02	Not Required

The largest calculated minimum separation distance is 11.02 mm, for the purposes of these calculations this must be rounded up to the next largest whole mm, or 12 mm.

Operating Frequency 2.402 GHz

$$\begin{aligned} \text{NT} &= [(21 / 12) * \sqrt{2.402}] \\ \text{NT} &= [1.75 * 1.55] \\ \text{NT} &= 2.7 \end{aligned}$$

Operating Frequency 2.442 GHz

$$\begin{aligned} \text{NT} &= [(21 / 12) * \sqrt{2.442}] \\ \text{NT} &= [1.75 * 1.56] \\ \text{NT} &= 2.7 \end{aligned}$$

Operating Frequency 2.480 GHz

$$\begin{aligned} \text{NT} &= [(21 / 12) * \sqrt{2.48}] \\ \text{NT} &= [1.75 * 1.57] \\ \text{NT} &= 2.8 \end{aligned}$$

Channel Frequency (MHz)	Measured Numeric Threshold	Required Numeric Threshold	SAR Evaluation
2402	2.7	3.0	Not Required
2442	2.7	3.0	Not Required
2480	2.8	3.0	Not Required

The Numeric Threshold calculated from the measured results based on a test separation distance of 12 mm was less than the required Numeric Threshold. The EUT meets the SAR Exclusion criteria based on a 12 mm minimum separation distance and therefore standalone SAR evaluation for general population exposure conditions by measurement or numerical simulation is not required.