

FCC Test Report

(Bluetooth Low Energy_DTS)

Report No.: RFCDBM-WTW-P22030865-3

FCC ID: QOQ-GM240P

Test Model: MGM240P32A, MGM240P32N

Series Model: BGM240P32A, BGM240P32N (refer to item 3.1 for more details)

Received Date: Mar. 22, 2022

Test Date: Apr. 19 ~ Jul. 08, 2022

Issued Date: Aug. 15, 2022

Applicant: Silicon Laboratories Finland Oy

Address: Alberga Business Park - Bldg D/Floor 5, Bertel Jungin aukio 3, 02600
ESPOO, FINLAND

Issued By: Bureau Veritas Consumer Products Services (H.K.) Ltd., Taoyuan Branch
Lin Kou Laboratories

Lab Address: No. 47-2, 14th Ling, Chia Pau Vil., Lin Kou Dist., New Taipei City, Taiwan

Test Location: No.19, Hwa Ya 2nd Rd., Wen Hwa Vil., Kwei Shan Dist., Taoyuan City
33383, Taiwan

**FCC Registration /
Designation Number:** 788550 / TW0003



This report is governed by, and incorporates by reference, the Conditions of Testing as posted at the date of issuance of this report at <http://www.bureauveritas.com/home/about-us/our-business/cps/about-us/terms-conditions/>, and is intended for your exclusive use. Any copying or replication of this report to or for any other person or entity, or use of our name or trademark, is permitted only with our prior written permission. This report sets forth our findings solely with respect to the test samples identified herein. The results set forth in this report are not indicative or representative of the quality or characteristics of the lot from which a test sample was taken or any similar or identical product unless specifically and expressly noted. Our report includes all of the tests requested by you and the results thereof based upon the information that you provided to us. Measurement uncertainty is only provided upon request for accredited tests. Statements of conformity are based on simple acceptance criteria without taking measurement uncertainty into account, unless otherwise requested in writing. You have 60 days from date of issuance of this report to notify us of any material error or omission caused by our negligence or if you require measurement uncertainty; provided, however, that such notice shall be in writing and shall specifically address the issue you wish to raise. A failure to raise such issue within the prescribed time shall constitute your unqualified acceptance of the completeness of this report, the tests conducted and the correctness of the report contents.

Table of Contents

| | |
|---|-----------|
| Release Control Record | 4 |
| 1 Certificate of Conformity | 5 |
| 2 Summary of Test Results | 6 |
| 2.1 Measurement Uncertainty | 7 |
| 2.2 Modification Record | 7 |
| 3 General Information | 8 |
| 3.1 General Description of EUT | 8 |
| 3.2 Description of Test Modes | 11 |
| 3.2.1 Test Mode Applicability and Tested Channel Detail | 12 |
| 3.3 Duty Cycle of Test Signal | 15 |
| 3.4 Description of Support Units | 16 |
| 3.4.1 Configuration of System under Test | 16 |
| 3.5 General Description of Applied Standards and References | 17 |
| 4 Test Types and Results | 18 |
| 4.1 Radiated Emission and Bandedge Measurement | 18 |
| 4.1.1 Limits of Radiated Emission and Bandedge Measurement | 18 |
| 4.1.2 Test Instruments | 19 |
| 4.1.3 Test Procedures | 20 |
| 4.1.4 Deviation from Test Standard | 20 |
| 4.1.5 Test Set Up | 21 |
| 4.1.6 EUT Operating Conditions | 22 |
| 4.1.7 Test Results | 23 |
| 4.2 Conducted Emission Measurement | 61 |
| 4.2.1 Limits of Conducted Emission Measurement | 61 |
| 4.2.2 Test Instruments | 61 |
| 4.2.3 Test Procedures | 61 |
| 4.2.4 Deviation from Test Standard | 62 |
| 4.2.5 Test Setup | 62 |
| 4.2.6 EUT Operating Conditions | 62 |
| 4.2.7 Test Results | 63 |
| 4.3 6 dB Bandwidth Measurement | 67 |
| 4.3.1 Limits of 6 dB Bandwidth Measurement | 67 |
| 4.3.2 Test Setup | 67 |
| 4.3.3 Test Instruments | 67 |
| 4.3.4 Test Procedure | 67 |
| 4.3.5 Deviation from Test Standard | 67 |
| 4.3.6 EUT Operating Conditions | 67 |
| 4.3.7 Test Results | 68 |
| 4.4 Occupied Bandwidth Measurement | 74 |
| 4.4.1 Test Setup | 74 |
| 4.4.2 Test Instruments | 74 |
| 4.4.3 Test Procedure | 74 |
| 4.4.4 Deviation from Test Standard | 74 |
| 4.4.5 EUT Operating Conditions | 74 |
| 4.4.6 Test Results | 75 |
| 4.5 Conducted Output Power Measurement | 81 |
| 4.5.1 Limits of Conducted Output Power Measurement | 81 |
| 4.5.2 Test Setup | 81 |
| 4.5.3 Test Instruments | 81 |
| 4.5.4 Test Procedures | 81 |
| 4.5.5 Deviation from Test Standard | 81 |
| 4.5.6 EUT Operating Conditions | 81 |
| 4.5.7 Test Results | 82 |

| | | |
|---|---|------------|
| 4.6 | Power Spectral Density Measurement | 84 |
| 4.6.1 | Limits of Power Spectral Density Measurement..... | 84 |
| 4.6.2 | Test Setup..... | 84 |
| 4.6.3 | Test Instruments | 84 |
| 4.6.4 | Test Procedure | 84 |
| 4.6.5 | Deviation from Test Standard | 84 |
| 4.6.6 | EUT Operating Condition | 84 |
| 4.6.7 | Test Results | 85 |
| 4.7 | Conducted Out of Band Emission Measurement | 91 |
| 4.7.1 | Limits of Conducted Out of Band Emission Measurement..... | 91 |
| 4.7.2 | Test Setup..... | 91 |
| 4.7.3 | Test Instruments | 91 |
| 4.7.4 | Test Procedure | 91 |
| 4.7.5 | Deviation from Test Standard | 91 |
| 4.7.6 | EUT Operating Condition | 91 |
| 4.7.7 | Test Results | 92 |
| Annex A- Band Edge Measurement | | 102 |
| 5 Pictures of Test Arrangements..... | | 112 |
| Appendix – Information of the Testing Laboratories | | 113 |



Release Control Record

| Issue No. | Description | Date Issued |
|------------------------|------------------|------------------|
| RFCDBM-WTW-P22030865-3 | Original Release | Aug. 15, 2022 |

1 Certificate of Conformity

Product: Bluetooth Low Energy and 802.15.4 wireless radio module

Brand: Silicon Labs

Test Model: MGM240P32A, MGM240P32N

Series Model: BGM240P32A, BGM240P32N (refer to item 3.1 for more details)

Sample Status: Engineering samples fully representing the production modules

Applicant: Silicon Laboratories Finland Oy

Test Date: Apr. 19 ~ Jul. 08, 2022

Standards: 47 CFR FCC Part 15, Subpart C (Section 15.247)
ANSI C63.10:2013

The above equipment has been tested by **Bureau Veritas Consumer Products Services (H.K.) Ltd., Taoyuan Branch**, and found compliance with the requirement of the above standards. The test record, data evaluation & Equipment Under Test (EUT) configurations represented herein are true and accurate accounts of the measurements of the sample's RF characteristics under the conditions specified in this report.

Prepared by : Gina Liu, **Date:** Aug. 15, 2022
Gina Liu / Specialist

Approved by : Jeremy Lin, **Date:** Aug. 15, 2022
Jeremy Lin / Project Engineer

2 Summary of Test Results

| 47 CFR FCC Part 15, Subpart C (Section 15.247) | | | |
|--|--------------------------------|--------|--|
| FCC Clause | Test Item | Result | Remarks |
| 15.207 | AC Power Conducted Emission | Pass | Meet the requirement of limit. Minimum passing margin is -12.05 dB at 0.18903 MHz. |
| 15.205 & 209 | Radiated Emissions | Pass | Meet the requirement of limit. Minimum passing margin is -0.50 dB at 2483.50 MHz. |
| 15.247(d) | Band Edge Measurement | Pass | Meet the requirement of limit. |
| 15.247(d) | Antenna Port Emission | Pass | Meet the requirement of limit. |
| 15.247(a)(2) | 6 dB Bandwidth | Pass | Meet the requirement of limit. |
| --- | Occupied Bandwidth Measurement | Pass | Reference only |
| 15.247(b) | Conducted Power | Pass | Meet the requirement of limit. |
| 15.247(e) | Power Spectral Density | Pass | Meet the requirement of limit. |
| 15.203 | Antenna Requirement | Pass | MGM240P32A: these modules use an integral antenna, therefore comply with the requirement of 15.203 (see section 1.4 for details) / MGM240P32N: this module comes with a RF pin only, no own RF connector, and no external antenna is sold with it. |

Note:

- For 2.4G band compliance with rule 15.247(d) of the band-edge items, the test plots were recorded in Annex A. Test Procedures refer to report 4.1.3.
- Determining compliance based on the results of the compliance measurement, not taking into account measurement instrumentation uncertainty.

2.1 Measurement Uncertainty

Where relevant, the following measurement uncertainty levels have been estimated for tests performed on the EUT as specified in CISPR 16-4-2:

| Measurement | Frequency | Expanded Uncertainty (k=2) (\pm) |
|------------------------------------|--------------------|--------------------------------------|
| Conducted Emissions at mains ports | 150 kHz ~ 30 MHz | 2.79 dB |
| Radiated Emissions up to 1 GHz | 9 kHz ~ 30 MHz | 3.00 dB |
| | 30 MHz ~ 200 MHz | 2.91 dB |
| | 200 MHz ~ 1000 MHz | 2.92 dB |
| Radiated Emissions above 1 GHz | 1 GHz ~ 18 GHz | 1.76 dB |
| | 18 GHz ~ 40 GHz | 1.77 dB |

2.2 Modification Record

There were no modifications required for compliance.

3 General Information

3.1 General Description of EUT

| | |
|------------------------------|--|
| Product | Bluetooth Low Energy and 802.15.4 wireless radio module |
| Brand | Silicon Labs |
| Test Model | MGM240P32A, MGM240P32N |
| Series Model | BGM240P32A, BGM240P32N |
| Model Difference | Refer to Note as below |
| Status of EUT | Engineering samples fully representing the production modules |
| Power Supply Rating | 5.0 Vdc from host equipment 1.8 ~ 3.8 Vdc from DC power supply |
| Modulation Type | GFSK |
| Modulation Technology | DTS |
| Transfer Rate | 1MBaud with 1Mbps transfer rate 1MBaud with Coded 125kbps transfer rate 1MBaud with Coded 500kbps 2MBaud with 2Mbps transfer rate |
| Operating Frequency | 2402 ~ 2480 MHz |
| Number of Channel | 1MBaud: 40 2MBaud: 37 |
| Output Power | MGM240P32A: 1MBaud: 96.383 mW 1MBaud: 20.464 mW (125kbps) 2MBaud: 96.605 mW MGM240P32N: 1MBaud: 94.842 mW 1MBaud: 20.559 mW (125kbps) 2MBaud: 94.406 mW |
| Antenna Type | Refer to Note as below |
| Antenna Connector | MGM240P32A: N/A (have integral antenna) / MGM240P32N: N/A (has RF pin) |
| Accessory Device | NA |
| Data Cable Supplied | NA |

Note:

- All models are listed as below. Model MGM240P32A and MGM240P32N are the representative for final test.

| Product Spec. | Model | |
|---------------|--|--|
| | | MGM240P32A |
| | (covers BGM240P32A) | (covers BGM240P32N) |
| | High-Power/ | High-Power/ |
| | Bluetooth Low Energy and 802.15.4 | Bluetooth Low Energy and 802.15.4 |
| | (802.15.4 being disabled for BGM240P32A) | (802.15.4 being disabled for BGM240P32N) |

| | | |
|---|---|--------|
| Max nominal RF TX power, as declared by manufacturer | 20dBm | 20dBm |
| Antenna type | integral antenna | RF pin |
| Hardware | <p>MGM240P32A (and BGM240P32A) --> hardware variants with integral antenna and 20dBm max power, to be tested as DTS for 802.15.4 and FHSS for Bluetooth Low Energy</p> <p>MGM240P32N (and BGM240P32N) --> hardware variants with RF pin and 20dBm max power, to be tested as DTS for 802.15.4 and FHSS for Bluetooth Low Energy</p> <p>These three hardware variants should be RF tested separately, because PAs are configured differently and also antenna matching components are different between them, meaning for example that conducted RF measurements cannot be assumed to deliver the exact same results across the three samples.</p> <p>MGM modules are the ones under testing as they support both 802.15.4 and Bluetooth Low Energy, whereas the BGM modules are the series models because they are exactly the same except for the 802.15.4 being disabled.</p> | |

2. The antenna information is listed as below.

| No. | Type | Connector | Gain (dBi) | Remark |
|-----|-------------------------------------|-----------|------------|-----------------------------------|
| 1 | Integral antenna | NA | 1.82 | For model: MGM240P32A, BGM240P32A |
| 2 | External reference dipole antenna** | RP-SMA | 2.80 | For model: MGM240P32N, BGM240P32N |

* The above Antenna information is declared by manufacturer and for more detailed features description, please refer to the manufacturer's specifications, the laboratory shall not be held responsible.

** The dipole antenna is not sold with the EUT, but is used during testing as a reference antenna for radiated measurements of the parts with the RF pin.

- The above EUT information is declared by manufacturer and for more detailed features description, please refers to the manufacturer's specifications or User's Manual.
- The EUT has DTS and Hopping functions. The EUT has been pre-tested at 125 kbps, 500 kbps and 1 Mbps data rates under the Bluetooth LE 1 M Baud rate PHY specification. The worst case was found 125 kbps data rate, therefore chosen for the final test. (Final test mode refer section 3.2.1)
- BT LE (DTS/FHSS) and 802.15.4 modes technology cannot transmit at same time.

6. Power setting is as below:

<1MBaud PHY with 125kbps>

| Test Mode: MGM240P32A | | Test Mode: MGM240P32N | |
|-----------------------|---------------|-----------------------|---------------|
| Channel | Power Setting | Channel | Power Setting |
| 0 | 123 | 0 | 123 |
| 1 | 123 | 1 | 123 |
| 19 | 123 | 19 | 123 |
| 38 | 123 | 38 | 123 |
| 39 | 123 | 39 | 123 |

<1MBaud PHY with 1Mbps>

| Test Mode: MGM240P32A | | Test Mode: MGM240P32N | |
|-----------------------|---------------|-----------------------|---------------|
| Channel | Power Setting | Channel | Power Setting |
| 0 | 197 | 0 | 197 |
| 1 | 197 | 1 | 197 |
| 19 | 197 | 19 | 197 |
| 38 | 197 | 38 | 197 |
| 39 | 174 | 39 | 174 |

<2MBaud PHY>

| Test Mode: MGM240P32A | | Test Mode: MGM240P32N | |
|-----------------------|---------------|-----------------------|---------------|
| Channel | Power Setting | Channel | Power Setting |
| 1 | 197 | 1 | 197 |
| 19 | 197 | 19 | 197 |
| 38 | 197 | 38 | 197 |

3.2 Description of Test Modes

1MBaud

40 channels are provided to this EUT:

| Channel | Freq. (MHz) | Channel | Freq. (MHz) | Channel | Freq. (MHz) | Channel | Freq. (MHz) |
|----------|-------------|-----------|-------------|---------|-------------|-----------|-------------|
| 0 | 2402 | 10 | 2422 | 20 | 2442 | 30 | 2462 |
| 1 | 2404 | 11 | 2424 | 21 | 2444 | 31 | 2464 |
| 2 | 2406 | 12 | 2426 | 22 | 2446 | 32 | 2466 |
| 3 | 2408 | 13 | 2428 | 23 | 2448 | 33 | 2468 |
| 4 | 2410 | 14 | 2430 | 24 | 2450 | 34 | 2470 |
| 5 | 2412 | 15 | 2432 | 25 | 2452 | 35 | 2472 |
| 6 | 2414 | 16 | 2434 | 26 | 2454 | 36 | 2474 |
| 7 | 2416 | 17 | 2436 | 27 | 2456 | 37 | 2476 |
| 8 | 2418 | 18 | 2438 | 28 | 2458 | 38 | 2478 |
| 9 | 2420 | 19 | 2440 | 29 | 2460 | 39 | 2480 |

Note: The channels which were indicated in bold type of the above channel list were selected as representative test channel. Therefore only the data of the test channels were recorded in this report.

2MBaud

37 channels are provided to this EUT:

| Channel | Freq. (MHz) | Channel | Freq. (MHz) | Channel | Freq. (MHz) | Channel | Freq. (MHz) |
|----------|-------------|-----------|-------------|---------|-------------|-----------|-------------|
| 1 | 2404 | 11 | 2424 | 21 | 2444 | 31 | 2464 |
| 2 | 2406 | - | - | 22 | 2446 | 32 | 2466 |
| 3 | 2408 | 13 | 2428 | 23 | 2448 | 33 | 2468 |
| 4 | 2410 | 14 | 2430 | 24 | 2450 | 34 | 2470 |
| 5 | 2412 | 15 | 2432 | 25 | 2452 | 35 | 2472 |
| 6 | 2414 | 16 | 2434 | 26 | 2454 | 36 | 2474 |
| 7 | 2416 | 17 | 2436 | 27 | 2456 | 37 | 2476 |
| 8 | 2418 | 18 | 2438 | 28 | 2458 | 38 | 2478 |
| 9 | 2420 | 19 | 2440 | 29 | 2460 | | |
| 10 | 2422 | 20 | 2442 | 30 | 2462 | | |

Note: The channels which were indicated in bold type of the above channel list were selected as representative test channel. Therefore only the data of the test channels were recorded in this report.

3.2.1 Test Mode Applicability and Tested Channel Detail

<1MBaud PHY>

| EUT Configure Mode | Applicable To | | | | Description |
|--------------------|---------------|-------|-----|------|-------------------------------|
| | RE \geq 1G | RE<1G | PLC | APCM | |
| A | √ | √ | - | √ | MGM240P32A / integral antenna |
| B | √ | √ | - | √ | MGM240P32N / Dipole antenna |

Where **RE \geq 1G**: Radiated Emission above 1 GHz **RE<1G**: Radiated Emission below 1 GHz
PLC: Power Line Conducted Emission **APCM**: Antenna Port Conducted Measurement

Note: The EUT had been pre-tested on the positioned of each 3 axis. The worst case was found when positioned on **X-plane** for mode A and **Z-plane** for mode B.

Note: For power line conducted emission test items, the worst maximum power was selected. The worst case is 2MBaud PHY, so the final report chose this for testing.

Note: For radiated emission (below 1 GHz) test items, the worst maximum power was selected.

Note: “-” means no effect.

Radiated Emission Test (Above 1 GHz):

Pre-Scan has been conducted to determine the worst-case mode from all possible combinations between available modulations, data rates and antenna ports (if EUT with antenna diversity architecture).

Following channel(s) was (were) selected for the final test as listed below.

| EUT Configure Mode | Available Channel | Tested Channel | Modulation Type | Data Rate |
|--------------------|-------------------|------------------|-----------------|-----------|
| A, B | 0 to 39 | 0, 1, 19, 38, 39 | GFSK | 1 Mbps |
| A, B | 0 to 39 | 0, 1, 19, 38, 39 | GFSK | 125 kbps |

Radiated Emission Test (Below 1 GHz):

Pre-Scan has been conducted to determine the worst-case mode from all possible combinations between available modulations, data rates and antenna ports (if EUT with antenna diversity architecture).

Following channel(s) was (were) selected for the final test as listed below.

| EUT Configure Mode | Available Channel | Tested Channel | Modulation Type | Data Rate |
|--------------------|-------------------|----------------|-----------------|-----------|
| A, B | 1 to 38 | 0 | GFSK | 1 Mbps |
| A | 1 to 38 | 19 | GFSK | 125 kbps |
| B | | 1 | | |

Antenna Port Conducted Measurement:

This item includes all test value of each mode, but only includes spectrum plot of worst value of each mode.

Pre-Scan has been conducted to determine the worst-case mode from all possible combinations between available modulations, data rates and antenna ports (if EUT with antenna diversity architecture).

Following channel(s) was (were) selected for the final test as listed below.

| EUT Configure Mode | Available Channel | Tested Channel | Modulation Type | Data Rate |
|--------------------|-------------------|------------------|-----------------|-----------|
| A, B | 1 to 38 | 0, 1, 19, 38, 39 | GFSK | 1 Mbps |
| A, B | 1 to 38 | 0, 1, 19, 38, 39 | GFSK | 125 kbps |

<2MBaud PHY>

| EUT Configure Mode | Applicable To | | | | Description |
|--------------------|---------------|-------|-----|------|-------------------------------|
| | RE≥1G | RE<1G | PLC | APCM | |
| A | √ | √ | √ | √ | MGM240P32A / integral antenna |
| B | √ | √ | √ | √ | MGM240P32N / Dipole antenna |

Where **RE≥1G**: Radiated Emission above 1 GHz **RE<1G**: Radiated Emission below 1 GHz
PLC: Power Line Conducted Emission **APCM**: Antenna Port Conducted Measurement

Note: The EUT had been pre-tested on the positioned of each 3 axis. The worst case was found when positioned on **X-plane** for mode A and **Z-plane** for mode B.

Note: For radiated emission (below 1 GHz) test items, the worst maximum power was selected.

Note: “-” means no effect.

Radiated Emission Test (Above 1 GHz):

Pre-Scan has been conducted to determine the worst-case mode from all possible combinations between available modulations, data rates and antenna ports (if EUT with antenna diversity architecture).

Following channel(s) was (were) selected for the final test as listed below.

| EUT Configure Mode | Available Channel | Tested Channel | Modulation Type | Data Rate (Mbps) |
|--------------------|-------------------|----------------|-----------------|------------------|
| A, B | 1 to 38 | 1, 19, 38 | GFSK | 2 |

Radiated Emission Test (Below 1 GHz):

Pre-Scan has been conducted to determine the worst-case mode from all possible combinations between available modulations, data rates and antenna ports (if EUT with antenna diversity architecture).

Following channel(s) was (were) selected for the final test as listed below.

| EUT Configure Mode | Available Channel | Tested Channel | Modulation Type | Data Rate (Mbps) |
|--------------------|-------------------|----------------|-----------------|------------------|
| A, B | 1 to 38 | 1 | GFSK | 2 |

Power Line Conducted Emission Test:

Pre-Scan has been conducted to determine the worst-case mode from all possible combinations between available modulations, data rates and antenna ports (if EUT with antenna diversity architecture).

Following channel(s) was (were) selected for the final test as listed below.

| EUT Configure Mode | Available Channel | Tested Channel | Modulation Type | Data Rate (Mbps) |
|--------------------|-------------------|----------------|-----------------|------------------|
| A, B | 1 to 38 | 1 | GFSK | 2 |

Antenna Port Conducted Measurement:

- This item includes all test value of each mode, but only includes spectrum plot of worst value of each mode.
- Pre-Scan has been conducted to determine the worst-case mode from all possible combinations between available modulations, data rates and antenna ports (if EUT with antenna diversity architecture).
- Following channel(s) was (were) selected for the final test as listed below.

| EUT Configure Mode | Available Channel | Tested Channel | Modulation Type | Data Rate (Mbps) |
|--------------------|-------------------|----------------|-----------------|------------------|
| A, B | 1 to 38 | 1, 19, 38 | GFSK | 2 |

Test Condition:

| Applicable To | Environmental Conditions | Input Power | Tested by |
|---------------|--------------------------|-------------------------|----------------------|
| RE \geq 1G | 23 deg. C, 68 % RH | 120 Vac, 60 Hz (System) | Rex Wang, Adair Peng |
| RE<1G | 23 deg. C, 68 % RH | 120 Vac, 60 Hz (System) | Adair Peng |
| PLC | 25 deg. C, 75% RH | 120 Vac, 60 Hz (System) | Rex Wang |
| APCM | 25 deg. C, 60% RH | 120 Vac, 60 Hz (System) | Chun Wu / Alan Wu |

3.3 Duty Cycle of Test Signal

Duty cycle of test signal is < 98 %, duty factor shall be considered.

<1MBaud PHY with 125kbps>

Duty cycle = 17.05/17.525 = 0.973, Duty factor = $10 \cdot \log(1/0.973) = 0.12$

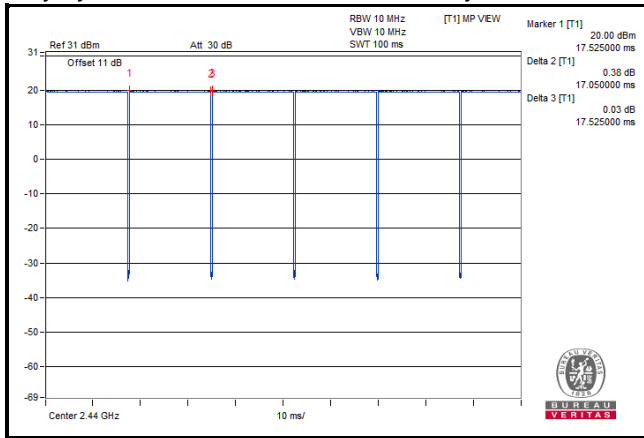

<1MBaud PHY with 1Mbps>

Duty cycle = 394/626 = 0.629, Duty factor = $10 \cdot \log(1/0.629) = 2.01$

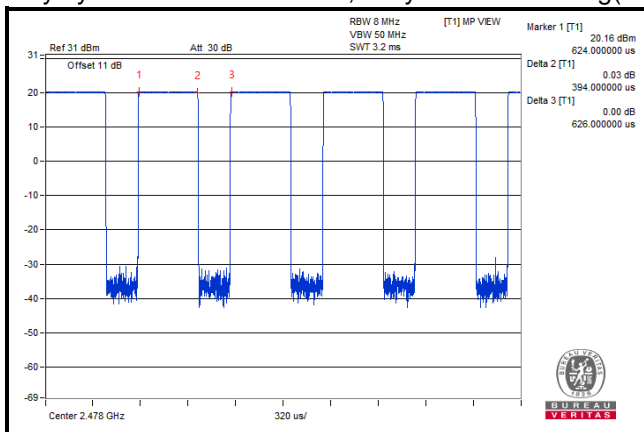

<2MBaud PHY>

Duty cycle = 0.992/1.25 = 0.794, Duty factor = $10 \cdot \log(1/0.794) = 1.00$

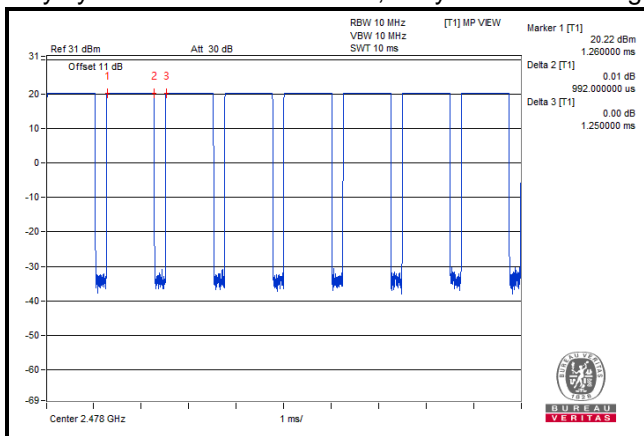

3.4 Description of Support Units

The EUT has been tested as an independent unit together with other necessary accessories or support units. The following support units or accessories were used to form a representative test configuration during the tests.

| ID | Product | Brand | Model No. | Serial No. | FCC ID | Remarks |
|----|---|--------------|-----------|------------|------------------|--------------------|
| A. | Host Board optimized for certification testing of the EUT | Silicon Labs | NA | NA | NA | Provided by client |
| B. | Notebook | DELL | E5430 | BPJVKV1 | FCC DoC Approved | - |

Note:

1. All power cords of the above support units are non-shielded (1.8m).
2. Item B acted as communication partners to transfer data.

| ID | Cable Descriptions | Qty. | Length (m) | Shielding (Yes/No) | Cores (Qty.) | Remarks |
|----|--------------------|------|------------|--------------------|--------------|--------------------|
| 1. | USB Cable | 1 | 1.5 | Y | 0 | Provided by client |

3.4.1 Configuration of System under Test

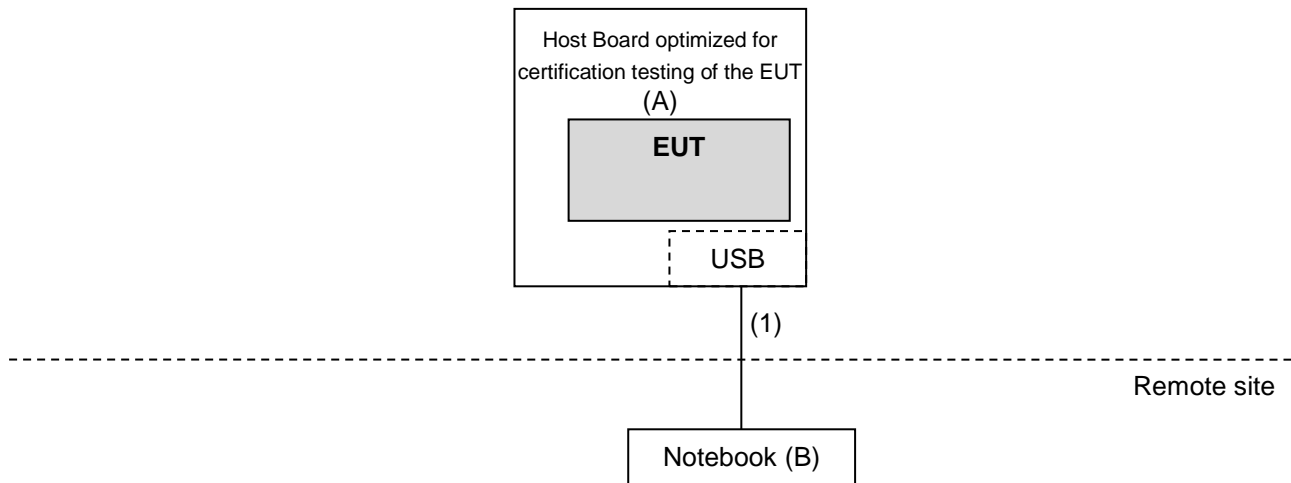

3.5 General Description of Applied Standards and References

The EUT is a RF Product. According to the specifications of the manufacturer, it must comply with the requirements of the following standards and references:

Test Standard:

FCC Part 15, Subpart C (15.247)

ANSI C63.10-2013

All test items have been performed and recorded as per the above standards.

References Test Guidance:

KDB 558074 D01 15.247 Meas Guidance v05r02

All test items have been performed as a reference to the above KDB test guidance.

4 Test Types and Results

4.1 Radiated Emission and Bandedge Measurement

4.1.1 Limits of Radiated Emission and Bandedge Measurement

Radiated emissions which fall in the restricted bands must comply with the radiated emission limits specified as below table. Other emissions shall be at least 20 dB below the highest level of the desired power:

| Frequencies (MHz) | Field Strength (microvolts/meter) | Measurement Distance (meters) |
|-------------------|-----------------------------------|-------------------------------|
| 0.009 ~ 0.490 | 2400/F (kHz) | 300 |
| 0.490 ~ 1.705 | 24000/F (kHz) | 30 |
| 1.705 ~ 30.0 | 30 | 30 |
| 30 ~ 88 | 100 | 3 |
| 88 ~ 216 | 150 | 3 |
| 216 ~ 960 | 200 | 3 |
| Above 960 | 500 | 3 |

Note:

1. The lower limit shall apply at the transition frequencies.
2. Emission level (dBuV/m) = 20 log Emission level (uV/m).
3. For frequencies above 1000 MHz, the field strength limits are based on average detector, however, the peak field strength of any emission shall not exceed the maximum permitted average limits, specified above by more than 20 dB under any condition of modulation.

4.1.2 Test Instruments

| Description & Manufacturer | Model No. | Serial No. | Cal. Date | Cal. Due |
|---|--|---------------------------------|---------------|---------------|
| Test Receiver KEYSIGHT | N9038A | MY55420137 | Apr. 27, 2022 | Apr. 26, 2023 |
| Spectrum Analyzer ROHDE & SCHWARZ | FSP40 | 100040 | Sep. 15, 2021 | Sep. 14, 2022 |
| BILOG Antenna SCHWARZBECK | VULB9168 | 9168-160 | Oct. 28, 2021 | Oct. 27, 2022 |
| HORN Antenna SCHWARZBECK | BBHA 9120 D | 9120D-1169 | Nov. 14, 2021 | Nov. 13, 2022 |
| HORN Antenna SCHWARZBECK | BBHA 9170 | BBHA9170241 | Oct. 26, 2021 | Oct. 25, 2022 |
| Preamplifier Agilent (Below 1GHz) | 8447D | 2944A10638 | Jun. 05, 2021 | Jun. 04, 2022 |
| | | | May 14, 2022 | May 13, 2023 |
| Preamplifier Agilent (Above 1GHz) | 8449B | 3008A02367 | Feb. 16, 2022 | Feb. 15, 2023 |
| RF signal cable HUBER+SUHNER&EMCI | SUCOFLEX 104 & EMC104-SM- SM8000 | CABLE-CH9-02 (248780+171006) | Jan. 15, 2022 | Jan. 14, 2023 |
| RF signal cable HUBER+SUHNER | SUCOFLEX 104 | CABLE-CH9-(250795/4) | Jan. 15, 2022 | Jan. 14, 2023 |
| RF signal cable Woken | 8D-FB | Cable-CH9-01 | Jun. 05, 2021 | Jun. 04, 2022 |
| | | | May 14, 2022 | May 13, 2023 |
| Software BV ADT | ADT_Radiated_ V7.6.15.9.5 | NA | NA | NA |
| Antenna Tower &Turn BV ADT | AT100 | AT93021705 | NA | NA |
| Turn Table BV ADT | TT100 | TT93021705 | NA | NA |
| Turn Table Controller BV ADT | SC100 | SC93021705 | NA | NA |
| Boresight Antenna Fixture | FBA-01 | FBA-SIP01 | NA | NA |
| Wideband Power Sensor KEYSIGHT | N1923A | MY58020002 | Jan. 17, 2022 | Jan. 16, 2023 |
| Peak Power Analyzer KEYSIGHT | 8990B | MY51000485 | Jan. 18, 2022 | Jan. 17, 2023 |
| Spectrum Analyzer ROHDE & SCHWARZ | FSV40 | 100979 | Mar. 25, 2022 | Mar. 24, 2023 |

- Note: 1. The calibration interval of the above test instruments is 12 months and the calibrations are traceable to NML/ROC and NIST/USA.
2. The test was performed in HwaYa Chamber 9.

4.1.3 Test Procedures

For Radiated Emission below 30 MHz

- a. The EUT was placed on the top of a rotating table 0.8 meters above the ground at a 3 meter chamber room. The table was rotated 360 degrees to determine the position of the highest radiation.
- b. The EUT was set 3 meters away from the interference-receiving antenna, which was mounted on the top of a variable-height antenna tower.
- c. Parallel, perpendicular, and ground-parallel orientations of the antenna are set to make the measurement.
- d. For each suspected emission, the EUT was arranged to its worst case and the rotatable table was turned from 0 degrees to 360 degrees to find the maximum reading.
- e. The test-receiver system was set to Quasi-Peak Detect Function and Specified Bandwidth with Maximum Hold Mode.

Note:

1. The resolution bandwidth and video bandwidth of test receiver/spectrum analyzer is 9 kHz at frequency below 30 MHz.

For Radiated Emission above 30 MHz

- a. The EUT was placed on the top of a rotating table 0.8 meters (for 30 MHz ~ 1 GHz) / 1.5 meters (for above 1 GHz) above the ground at 3 meter chamber room for test. The table was rotated 360 degrees to determine the position of the highest radiation.
- b. The EUT was set 3 meters away from the interference-receiving antenna, which was mounted on the top of a variable-height antenna tower.
- c. The height of antenna is varied from one meter to four meters above the ground to determine the maximum value of the field strength. Both horizontal and vertical polarizations of the antenna are set to make the measurement.
- d. For each suspected emission, the EUT was arranged to its worst case and then the antenna was tuned to heights from 1 meter to 4 meters and the rotatable table was turned from 0 degrees to 360 degrees to find the maximum reading.
- e. The test-receiver system was set to quasi-peak detect function and specified bandwidth with maximum hold mode when the test frequency is below 1 GHz.
- f. The test-receiver system was set to peak and average detected function and specified bandwidth with maximum hold mode when the test frequency is above 1 GHz. If the peak reading value also meets average limit, measurement with the average detector is unnecessary.

Note:

1. The resolution bandwidth and video bandwidth of test receiver/spectrum analyzer is 120 kHz for Quasi-peak detection (QP) at frequency below 1 GHz.
2. The resolution bandwidth of test receiver/spectrum analyzer is 1 MHz and the video bandwidth is 3 MHz for Peak detection (PK) at frequency above 1 GHz.
3. The resolution bandwidth of test receiver/spectrum analyzer is 1 MHz and the video bandwidth is $\geq 1/T$ (Duty cycle < 98 %) or 10 Hz (Duty cycle ≥ 98 %) for Average detection (AV) at frequency above 1 GHz. (RBW = 1 MHz, VBW = 3 MHz)
4. All modes of operation were investigated and the worst-case emissions are reported.

4.1.4 Deviation from Test Standard

No deviation.

4.1.5 Test Set Up

<Radiated Emission below 30 MHz>

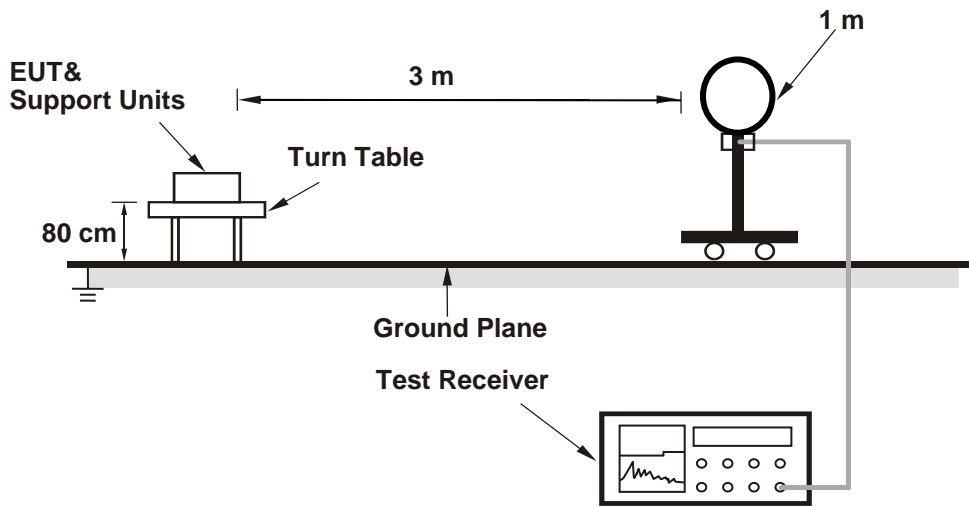

<Radiated Emission 30 MHz to 1 GHz>

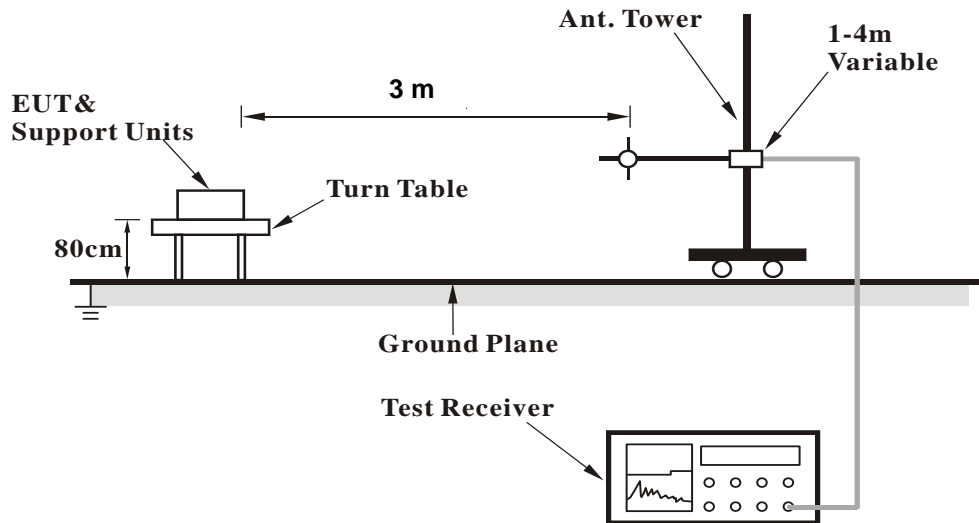

<Radiated Emission above 1 GHz>

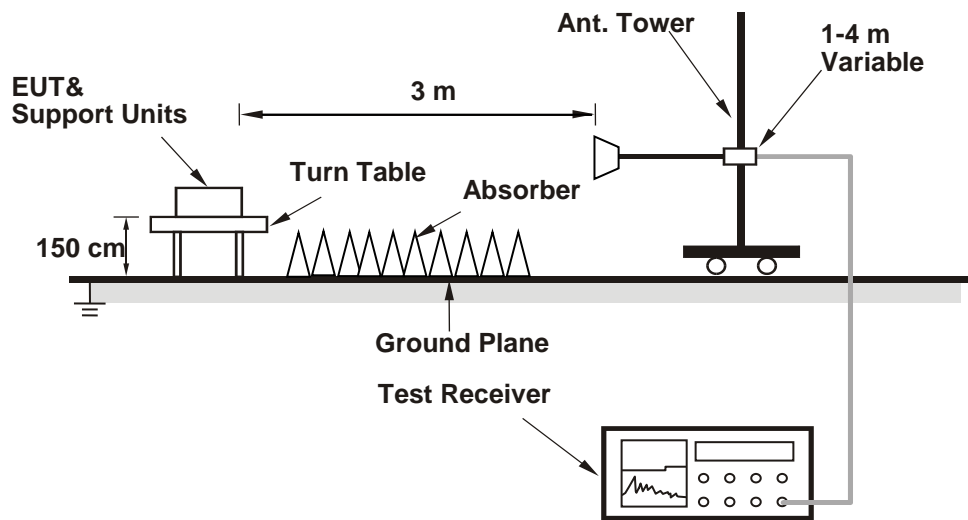

For the actual test configuration, please refer to the attached file (Test Setup Photo).

4.1.6 EUT Operating Conditions

- a. Placed the EUT on the testing table.
- b. Set the EUT under transmission condition continuously at specific channel frequency.

4.1.7 Test Results

Above 1 GHz Data:

Mode A

| | | | |
|------------------------|----------------|--|--|
| RF Mode | TX BT-LE 1M | Channel | CH 0 : 2402 MHz |
| Frequency Range | 1 GHz ~ 25 GHz | Detector Function & Bandwidth | (PK) RB = 1 MHz, VB = 3 MHz (AV) RB = 1 MHz, VB = 3 MHz |
| Input Power | 120 Vac, 60 Hz | Environmental Conditions | 22°C, 68% RH |
| Tested By | Rex Wang | Test Date | 2022/7/8 |

Antenna Polarity & Test Distance : Horizontal at 3 m

| No | Frequency (MHz) | Emission Level (dBuV/m) | Limit (dBuV/m) | Margin (dB) | Antenna Height (m) | Table Angle (Degree) | Raw Value (dBuV) | Correction Factor (dB/m) |
|----|-----------------|-------------------------|----------------|-------------|--------------------|----------------------|------------------|--------------------------|
| 1 | 2390.00 | 61.25 PK | 74.00 | -12.75 | 2.09 H | 170 | 62.70 | -1.45 |
| 2 | 2390.00 | 51.43 AV | 54.00 | -2.57 | 2.09 H | 170 | 52.88 | -1.45 |
| 3 | *2402.00 | 115.24 PK | | | 2.09 H | 170 | 82.40 | 32.84 |
| 4 | *2402.00 | 113.94 AV | | | 2.09 H | 170 | 81.10 | 32.84 |
| 5 | 4804.00 | 48.19 PK | 74.00 | -25.81 | 1.90 H | 1 | 42.50 | 5.69 |
| 6 | 4804.00 | 38.99 AV | 54.00 | -15.01 | 1.90 H | 1 | 33.30 | 5.69 |

Antenna Polarity & Test Distance : Vertical at 3 m

| No | Frequency (MHz) | Emission Level (dBuV/m) | Limit (dBuV/m) | Margin (dB) | Antenna Height (m) | Table Angle (Degree) | Raw Value (dBuV) | Correction Factor (dB/m) |
|----|-----------------|-------------------------|----------------|-------------|--------------------|----------------------|------------------|--------------------------|
| 1 | 2390.00 | 60.95 PK | 74.00 | -13.05 | 1.55 V | 300 | 62.40 | -1.45 |
| 2 | 2390.00 | 51.14 AV | 54.00 | -2.86 | 1.55 V | 300 | 52.59 | -1.45 |
| 3 | *2402.00 | 113.44 PK | | | 1.55 V | 300 | 80.60 | 32.84 |
| 4 | *2402.00 | 112.34 AV | | | 1.55 V | 300 | 79.50 | 32.84 |
| 5 | 4804.00 | 47.49 PK | 74.00 | -26.51 | 1.78 V | 262 | 41.80 | 5.69 |
| 6 | 4804.00 | 38.39 AV | 54.00 | -15.61 | 1.78 V | 262 | 32.70 | 5.69 |

Remarks:

1. Emission Level(dBuV/m) = Raw Value(dBuV) + Correction Factor(dB/m)
2. Correction Factor(dB/m) = Antenna Factor(dB/m) + Cable Factor(dB) – Pre-Amplifier Factor(dB)
3. Margin value = Emission Level – Limit value
4. The other emission levels were very low against the limit.
5. " * " : Fundamental frequency, the limit was restricted at the RF Output Power.

| | | | |
|------------------------|----------------|--|--|
| RF Mode | TX BT-LE 1M | Channel | CH 1 : 2404 MHz |
| Frequency Range | 1 GHz ~ 25 GHz | Detector Function & Bandwidth | (PK) RB = 1 MHz, VB = 3 MHz (AV) RB = 1 MHz, VB = 3 MHz |
| Input Power | 120 Vac, 60 Hz | Environmental Conditions | 22°C, 68% RH |
| Tested By | Rex Wang | Test Date | 2022/7/8 |

Antenna Polarity & Test Distance : Horizontal at 3 m

| No | Frequency (MHz) | Emission Level (dBuV/m) | Limit (dBuV/m) | Margin (dB) | Antenna Height (m) | Table Angle (Degree) | Raw Value (dBuV) | Correction Factor (dB/m) |
|----|-----------------|-------------------------|----------------|-------------|--------------------|----------------------|------------------|--------------------------|
| 1 | 2390.00 | 60.50 PK | 74.00 | -13.50 | 2.06 H | 170 | 61.95 | -1.45 |
| 2 | 2390.00 | 51.15 AV | 54.00 | -2.85 | 2.06 H | 170 | 52.60 | -1.45 |
| 3 | *2404.00 | 115.56 PK | | | 2.06 H | 170 | 82.72 | 32.84 |
| 4 | *2404.00 | 114.54 AV | | | 2.06 H | 170 | 81.70 | 32.84 |
| 5 | 4808.00 | 48.38 PK | 74.00 | -25.62 | 1.88 H | 3 | 42.70 | 5.68 |
| 6 | 4808.00 | 38.88 AV | 54.00 | -15.12 | 1.88 H | 3 | 33.20 | 5.68 |

Antenna Polarity & Test Distance : Vertical at 3 m

| No | Frequency (MHz) | Emission Level (dBuV/m) | Limit (dBuV/m) | Margin (dB) | Antenna Height (m) | Table Angle (Degree) | Raw Value (dBuV) | Correction Factor (dB/m) |
|----|-----------------|-------------------------|----------------|-------------|--------------------|----------------------|------------------|--------------------------|
| 1 | 2390.00 | 60.35 PK | 74.00 | -13.65 | 2.41 V | 303 | 61.80 | -1.45 |
| 2 | 2390.00 | 50.75 AV | 54.00 | -3.25 | 2.41 V | 303 | 52.20 | -1.45 |
| 3 | *2404.00 | 112.64 PK | | | 2.41 V | 303 | 79.80 | 32.84 |
| 4 | *2404.00 | 111.54 AV | | | 2.41 V | 303 | 78.70 | 32.84 |
| 5 | 4808.00 | 47.18 PK | 74.00 | -26.82 | 1.65 V | 259 | 41.50 | 5.68 |
| 6 | 4808.00 | 38.58 AV | 54.00 | -15.42 | 1.65 V | 259 | 32.90 | 5.68 |

Remarks:

1. Emission Level(dBuV/m) = Raw Value(dBuV) + Correction Factor(dB/m)
2. Correction Factor(dB/m) = Antenna Factor(dB/m) + Cable Factor(dB) – Pre-Amplifier Factor(dB)
3. Margin value = Emission Level – Limit value
4. The other emission levels were very low against the limit.
5. " * ": Fundamental frequency, the limit was restricted at the RF Output Power.

| | | | |
|------------------------|----------------|--|--|
| RF Mode | TX BT-LE 1M | Channel | CH 19 : 2440 MHz |
| Frequency Range | 1 GHz ~ 25 GHz | Detector Function & Bandwidth | (PK) RB = 1 MHz, VB = 3 MHz (AV) RB = 1 MHz, VB = 3 MHz |
| Input Power | 120 Vac, 60 Hz | Environmental Conditions | 22°C, 68% RH |
| Tested By | Rex Wang | Test Date | 2022/7/8 |

Antenna Polarity & Test Distance : Horizontal at 3 m

| No | Frequency (MHz) | Emission Level (dBuV/m) | Limit (dBuV/m) | Margin (dB) | Antenna Height (m) | Table Angle (Degree) | Raw Value (dBuV) | Correction Factor (dB/m) |
|----|-----------------|-------------------------|----------------|-------------|--------------------|----------------------|------------------|--------------------------|
| 1 | *2440.00 | 114.41 PK | | | 2.05 H | 169 | 81.60 | 32.81 |
| 2 | *2440.00 | 113.21 AV | | | 2.05 H | 169 | 80.40 | 32.81 |
| 3 | 4880.00 | 48.61 PK | 74.00 | -25.39 | 1.92 H | 2 | 43.10 | 5.51 |
| 4 | 4880.00 | 38.81 AV | 54.00 | -15.19 | 1.92 H | 2 | 33.30 | 5.51 |

Antenna Polarity & Test Distance : Vertical at 3 m

| No | Frequency (MHz) | Emission Level (dBuV/m) | Limit (dBuV/m) | Margin (dB) | Antenna Height (m) | Table Angle (Degree) | Raw Value (dBuV) | Correction Factor (dB/m) |
|----|-----------------|-------------------------|----------------|-------------|--------------------|----------------------|------------------|--------------------------|
| 1 | *2440.00 | 113.11 PK | | | 1.92 V | 304 | 80.30 | 32.81 |
| 2 | *2440.00 | 111.61 AV | | | 1.92 V | 304 | 78.80 | 32.81 |
| 3 | 4880.00 | 47.31 PK | 74.00 | -26.69 | 1.69 V | 257 | 41.80 | 5.51 |
| 4 | 4880.00 | 37.71 AV | 54.00 | -16.29 | 1.69 V | 257 | 32.20 | 5.51 |

Remarks:

1. Emission Level(dBuV/m) = Raw Value(dBuV) + Correction Factor(dB/m)
2. Correction Factor(dB/m) = Antenna Factor(dB/m) + Cable Factor(dB) – Pre-Amplifier Factor(dB)
3. Margin value = Emission Level – Limit value
4. The other emission levels were very low against the limit.
5. " * ": Fundamental frequency, the limit was restricted at the RF Output Power.

| | | | |
|------------------------|----------------|--|--|
| RF Mode | TX BT-LE 1M | Channel | CH 38 : 2478 MHz |
| Frequency Range | 1 GHz ~ 25 GHz | Detector Function & Bandwidth | (PK) RB = 1 MHz, VB = 3 MHz (AV) RB = 1 MHz, VB = 3 MHz |
| Input Power | 120 Vac, 60 Hz | Environmental Conditions | 22°C, 68% RH |
| Tested By | Rex Wang | Test Date | 2022/7/8 |

Antenna Polarity & Test Distance : Horizontal at 3 m

| No | Frequency (MHz) | Emission Level (dBuV/m) | Limit (dBuV/m) | Margin (dB) | Antenna Height (m) | Table Angle (Degree) | Raw Value (dBuV) | Correction Factor (dB/m) |
|----|-----------------|-------------------------|----------------|-------------|--------------------|----------------------|------------------|--------------------------|
| 1 | *2478.00 | 113.43 PK | | | 2.17 H | 167 | 80.60 | 32.83 |
| 2 | *2478.00 | 112.37 AV | | | 2.17 H | 167 | 79.54 | 32.83 |
| 3 | 2483.50 | 60.94 PK | 74.00 | -13.06 | 2.17 H | 167 | 62.50 | -1.56 |
| 4 | 2483.50 | 52.14 AV | 54.00 | -1.86 | 2.17 H | 167 | 53.70 | -1.56 |
| 5 | 4956.00 | 48.91 PK | 74.00 | -25.09 | 1.90 H | 2 | 43.30 | 5.61 |
| 6 | 4956.00 | 39.11 AV | 54.00 | -14.89 | 1.90 H | 2 | 33.50 | 5.61 |

Antenna Polarity & Test Distance : Vertical at 3 m

| No | Frequency (MHz) | Emission Level (dBuV/m) | Limit (dBuV/m) | Margin (dB) | Antenna Height (m) | Table Angle (Degree) | Raw Value (dBuV) | Correction Factor (dB/m) |
|----|-----------------|-------------------------|----------------|-------------|--------------------|----------------------|------------------|--------------------------|
| 1 | *2478.00 | 113.33 PK | | | 1.89 V | 307 | 80.50 | 32.83 |
| 2 | *2478.00 | 111.53 AV | | | 1.89 V | 307 | 78.70 | 32.83 |
| 3 | 2483.50 | 61.74 PK | 74.00 | -12.26 | 1.89 V | 307 | 63.30 | -1.56 |
| 4 | 2483.50 | 51.54 AV | 54.00 | -2.46 | 1.89 V | 307 | 53.10 | -1.56 |
| 5 | 4956.00 | 48.21 PK | 74.00 | -25.79 | 1.66 V | 254 | 42.60 | 5.61 |
| 6 | 4956.00 | 38.51 AV | 54.00 | -15.49 | 1.66 V | 254 | 32.90 | 5.61 |

Remarks:

1. Emission Level(dBuV/m) = Raw Value(dBuV) + Correction Factor(dB/m)
2. Correction Factor(dB/m) = Antenna Factor(dB/m) + Cable Factor(dB) – Pre-Amplifier Factor(dB)
3. Margin value = Emission Level – Limit value
4. The other emission levels were very low against the limit.
5. " * ": Fundamental frequency, the limit was restricted at the RF Output Power.

| | | | |
|------------------------|----------------|--|--|
| RF Mode | TX BT-LE 1M | Channel | CH 39 : 2480 MHz |
| Frequency Range | 1 GHz ~ 25 GHz | Detector Function & Bandwidth | (PK) RB = 1 MHz, VB = 3 MHz (AV) RB = 1 MHz, VB = 3 MHz |
| Input Power | 120 Vac, 60 Hz | Environmental Conditions | 22°C, 68% RH |
| Tested By | Rex Wang | Test Date | 2022/7/4 |

Antenna Polarity & Test Distance : Horizontal at 3 m

| No | Frequency (MHz) | Emission Level (dBuV/m) | Limit (dBuV/m) | Margin (dB) | Antenna Height (m) | Table Angle (Degree) | Raw Value (dBuV) | Correction Factor (dB/m) |
|----|-----------------|-------------------------|----------------|-------------|--------------------|----------------------|------------------|--------------------------|
| 1 | *2480.00 | 111.87 PK | | | 1.64 H | 166 | 79.04 | 32.83 |
| 2 | *2480.00 | 110.79 AV | | | 1.64 H | 166 | 77.96 | 32.83 |
| 3 | 2483.50 | 65.60 PK | 74.00 | -8.40 | 1.64 H | 166 | 67.16 | -1.56 |
| 4 | 2483.50 | 53.47 AV | 54.00 | -0.53 | 1.64 H | 166 | 55.03 | -1.56 |
| 5 | 4960.00 | 49.26 PK | 74.00 | -24.74 | 2.51 H | 27 | 43.62 | 5.64 |
| 6 | 4960.00 | 38.34 AV | 54.00 | -15.66 | 2.51 H | 27 | 32.70 | 5.64 |

Antenna Polarity & Test Distance : Vertical at 3 m

| No | Frequency (MHz) | Emission Level (dBuV/m) | Limit (dBuV/m) | Margin (dB) | Antenna Height (m) | Table Angle (Degree) | Raw Value (dBuV) | Correction Factor (dB/m) |
|----|-----------------|-------------------------|----------------|-------------|--------------------|----------------------|------------------|--------------------------|
| 1 | *2480.00 | 110.08 PK | | | 1.86 V | 309 | 77.25 | 32.83 |
| 2 | *2480.00 | 108.93 AV | | | 1.86 V | 309 | 76.10 | 32.83 |
| 3 | 2483.50 | 60.94 PK | 74.00 | -13.06 | 1.86 V | 309 | 62.50 | -1.56 |
| 4 | 2483.50 | 52.04 AV | 54.00 | -1.96 | 1.86 V | 309 | 53.60 | -1.56 |
| 5 | 4960.00 | 48.34 PK | 74.00 | -25.66 | 1.68 V | 254 | 42.70 | 5.64 |
| 6 | 4960.00 | 37.44 AV | 54.00 | -16.56 | 1.68 V | 254 | 31.80 | 5.64 |

Remarks:

1. Emission Level(dBuV/m) = Raw Value(dBuV) + Correction Factor(dB/m)
2. Correction Factor(dB/m) = Antenna Factor(dB/m) + Cable Factor(dB) – Pre-Amplifier Factor(dB)
3. Margin value = Emission Level – Limit value
4. The other emission levels were very low against the limit.
5. " * ": Fundamental frequency, the limit was restricted at the RF Output Power.

| | | | |
|------------------------|-----------------------|--|--|
| RF Mode | TX BT-LE 1M with 125K | Channel | CH 0 : 2402 MHz |
| Frequency Range | 1 GHz ~ 25 GHz | Detector Function & Bandwidth | (PK) RB = 1 MHz, VB = 3 MHz (AV) RB = 1 MHz, VB = 3 MHz |
| Input Power | 120 Vac, 60 Hz | Environmental Conditions | 22°C, 68% RH |
| Tested By | Rex Wang | Test Date | 2022/7/8 |

Antenna Polarity & Test Distance : Horizontal at 3 m

| No | Frequency (MHz) | Emission Level (dBuV/m) | Limit (dBuV/m) | Margin (dB) | Antenna Height (m) | Table Angle (Degree) | Raw Value (dBuV) | Correction Factor (dB/m) |
|----|-----------------|-------------------------|----------------|-------------|--------------------|----------------------|------------------|--------------------------|
| 1 | 2390.00 | 61.90 PK | 74.00 | -12.10 | 1.41 H | 182 | 63.40 | -1.50 |
| 2 | 2390.00 | 51.00 AV | 54.00 | -3.00 | 1.41 H | 182 | 52.50 | -1.50 |
| 3 | *2402.00 | 108.10 PK | | | 1.41 H | 182 | 75.30 | 32.80 |
| 4 | *2402.00 | 107.10 AV | | | 1.41 H | 182 | 74.30 | 32.80 |
| 5 | 4804.00 | 49.40 PK | 74.00 | -24.60 | 2.58 H | 20 | 43.60 | 5.80 |
| 6 | 4804.00 | 38.20 AV | 54.00 | -15.80 | 2.58 H | 20 | 32.40 | 5.80 |

Antenna Polarity & Test Distance : Vertical at 3 m

| No | Frequency (MHz) | Emission Level (dBuV/m) | Limit (dBuV/m) | Margin (dB) | Antenna Height (m) | Table Angle (Degree) | Raw Value (dBuV) | Correction Factor (dB/m) |
|----|-----------------|-------------------------|----------------|-------------|--------------------|----------------------|------------------|--------------------------|
| 1 | 2390.00 | 61.00 PK | 74.00 | -13.00 | 1.00 V | 324 | 62.50 | -1.50 |
| 2 | 2390.00 | 50.80 AV | 54.00 | -3.20 | 1.00 V | 324 | 52.30 | -1.50 |
| 3 | *2402.00 | 104.40 PK | | | 1.00 V | 324 | 71.60 | 32.80 |
| 4 | *2402.00 | 103.20 AV | | | 1.00 V | 324 | 70.40 | 32.80 |
| 5 | 4804.00 | 49.20 PK | 74.00 | -24.80 | 1.66 V | 250 | 43.40 | 5.80 |
| 6 | 4804.00 | 37.80 AV | 54.00 | -16.20 | 1.66 V | 250 | 32.00 | 5.80 |

Remarks:

1. Emission Level(dBuV/m) = Raw Value(dBuV) + Correction Factor(dB/m)
2. Correction Factor(dB/m) = Antenna Factor(dB/m) + Cable Factor(dB) – Pre-Amplifier Factor(dB)
3. Margin value = Emission Level – Limit value
4. The other emission levels were very low against the limit.
5. " * ": Fundamental frequency, the limit was restricted at the RF Output Power.

| | | | |
|------------------------|-----------------------|--|--|
| RF Mode | TX BT-LE 1M with 125K | Channel | CH 1 : 2404 MHz |
| Frequency Range | 1 GHz ~ 25 GHz | Detector Function & Bandwidth | (PK) RB = 1 MHz, VB = 3 MHz (AV) RB = 1 MHz, VB = 3 MHz |
| Input Power | 120 Vac, 60 Hz | Environmental Conditions | 22°C, 68% RH |
| Tested By | Rex Wang | Test Date | 2022/7/8 |

Antenna Polarity & Test Distance : Horizontal at 3 m

| No | Frequency (MHz) | Emission Level (dBuV/m) | Limit (dBuV/m) | Margin (dB) | Antenna Height (m) | Table Angle (Degree) | Raw Value (dBuV) | Correction Factor (dB/m) |
|----|-----------------|-------------------------|----------------|-------------|--------------------|----------------------|------------------|--------------------------|
| 1 | 2390.00 | 62.10 PK | 74.00 | -11.90 | 1.40 H | 183 | 63.60 | -1.50 |
| 2 | 2390.00 | 51.10 AV | 54.00 | -2.90 | 1.40 H | 183 | 52.60 | -1.50 |
| 3 | *2404.00 | 108.00 PK | | | 1.40 H | 183 | 75.20 | 32.80 |
| 4 | *2404.00 | 106.80 AV | | | 1.40 H | 183 | 74.00 | 32.80 |
| 5 | 4808.00 | 49.20 PK | 74.00 | -24.80 | 2.50 H | 26 | 43.40 | 5.80 |
| 6 | 4808.00 | 38.40 AV | 54.00 | -15.60 | 2.50 H | 26 | 32.60 | 5.80 |

Antenna Polarity & Test Distance : Vertical at 3 m

| No | Frequency (MHz) | Emission Level (dBuV/m) | Limit (dBuV/m) | Margin (dB) | Antenna Height (m) | Table Angle (Degree) | Raw Value (dBuV) | Correction Factor (dB/m) |
|----|-----------------|-------------------------|----------------|-------------|--------------------|----------------------|------------------|--------------------------|
| 1 | 2390.00 | 61.80 PK | 74.00 | -12.20 | 1.31 V | 329 | 63.30 | -1.50 |
| 2 | 2390.00 | 50.90 AV | 54.00 | -3.10 | 1.31 V | 329 | 52.40 | -1.50 |
| 3 | *2404.00 | 104.20 PK | | | 1.31 V | 329 | 71.40 | 32.80 |
| 4 | *2404.00 | 103.10 AV | | | 1.31 V | 329 | 70.30 | 32.80 |
| 5 | 4808.00 | 49.00 PK | 74.00 | -25.00 | 1.70 V | 262 | 43.20 | 5.80 |
| 6 | 4808.00 | 38.20 AV | 54.00 | -15.80 | 1.70 V | 262 | 32.40 | 5.80 |

Remarks:

1. Emission Level(dBuV/m) = Raw Value(dBuV) + Correction Factor(dB/m)
2. Correction Factor(dB/m) = Antenna Factor(dB/m) + Cable Factor(dB) – Pre-Amplifier Factor(dB)
3. Margin value = Emission Level – Limit value
4. The other emission levels were very low against the limit.
5. " * ": Fundamental frequency, the limit was restricted at the RF Output Power.

| | | | |
|------------------------|-----------------------|--|--|
| RF Mode | TX BT-LE 1M with 125K | Channel | CH 19 : 2440 MHz |
| Frequency Range | 1 GHz ~ 25 GHz | Detector Function & Bandwidth | (PK) RB = 1 MHz, VB = 3 MHz (AV) RB = 1 MHz, VB = 3 MHz |
| Input Power | 120 Vac, 60 Hz | Environmental Conditions | 22°C, 68% RH |
| Tested By | Rex Wang | Test Date | 2022/7/8 |

Antenna Polarity & Test Distance : Horizontal at 3 m

| No | Frequency (MHz) | Emission Level (dBuV/m) | Limit (dBuV/m) | Margin (dB) | Antenna Height (m) | Table Angle (Degree) | Raw Value (dBuV) | Correction Factor (dB/m) |
|----|-----------------|-------------------------|----------------|-------------|--------------------|----------------------|------------------|--------------------------|
| 1 | *2440.00 | 108.00 PK | | | 1.42 H | 185 | 75.20 | 32.80 |
| 2 | *2440.00 | 106.60 AV | | | 1.42 H | 185 | 73.80 | 32.80 |
| 3 | 4880.00 | 48.80 PK | 74.00 | -25.20 | 2.56 H | 26 | 43.30 | 5.50 |
| 4 | 4880.00 | 38.00 AV | 54.00 | -16.00 | 2.56 H | 26 | 32.50 | 5.50 |

Antenna Polarity & Test Distance : Vertical at 3 m

| No | Frequency (MHz) | Emission Level (dBuV/m) | Limit (dBuV/m) | Margin (dB) | Antenna Height (m) | Table Angle (Degree) | Raw Value (dBuV) | Correction Factor (dB/m) |
|----|-----------------|-------------------------|----------------|-------------|--------------------|----------------------|------------------|--------------------------|
| 1 | *2440.00 | 104.10 PK | | | 1.26 V | 324 | 71.30 | 32.80 |
| 2 | *2440.00 | 103.00 AV | | | 1.26 V | 324 | 70.20 | 32.80 |
| 3 | 4880.00 | 47.30 PK | 74.00 | -26.70 | 1.71 V | 258 | 41.80 | 5.50 |
| 4 | 4880.00 | 37.10 AV | 54.00 | -16.90 | 1.71 V | 258 | 31.60 | 5.50 |

Remarks:

1. Emission Level(dBuV/m) = Raw Value(dBuV) + Correction Factor(dB/m)
2. Correction Factor(dB/m) = Antenna Factor(dB/m) + Cable Factor(dB) – Pre-Amplifier Factor(dB)
3. Margin value = Emission Level – Limit value
4. The other emission levels were very low against the limit.
5. " * ": Fundamental frequency, the limit was restricted at the RF Output Power.

| | | | |
|------------------------|-----------------------|--|--|
| RF Mode | TX BT-LE 1M with 125K | Channel | CH 38 : 2478 MHz |
| Frequency Range | 1 GHz ~ 25 GHz | Detector Function & Bandwidth | (PK) RB = 1 MHz, VB = 3 MHz (AV) RB = 1 MHz, VB = 3 MHz |
| Input Power | 120 Vac, 60 Hz | Environmental Conditions | 22°C, 68% RH |
| Tested By | Rex Wang | Test Date | 2022/7/8 |

Antenna Polarity & Test Distance : Horizontal at 3 m

| No | Frequency (MHz) | Emission Level (dBuV/m) | Limit (dBuV/m) | Margin (dB) | Antenna Height (m) | Table Angle (Degree) | Raw Value (dBuV) | Correction Factor (dB/m) |
|----|-----------------|-------------------------|----------------|-------------|--------------------|----------------------|------------------|--------------------------|
| 1 | *2478.00 | 106.80 PK | | | 1.56 H | 180 | 73.90 | 32.90 |
| 2 | *2478.00 | 105.30 AV | | | 1.56 H | 180 | 72.40 | 32.90 |
| 3 | 2483.50 | 61.80 PK | 74.00 | -12.20 | 1.56 H | 180 | 63.30 | -1.50 |
| 4 | 2483.50 | 50.80 AV | 54.00 | -3.20 | 1.56 H | 180 | 52.30 | -1.50 |
| 5 | 4956.00 | 49.10 PK | 74.00 | -24.90 | 2.51 H | 23 | 43.50 | 5.60 |
| 6 | 4956.00 | 38.00 AV | 54.00 | -16.00 | 2.51 H | 23 | 32.40 | 5.60 |

Antenna Polarity & Test Distance : Vertical at 3 m

| No | Frequency (MHz) | Emission Level (dBuV/m) | Limit (dBuV/m) | Margin (dB) | Antenna Height (m) | Table Angle (Degree) | Raw Value (dBuV) | Correction Factor (dB/m) |
|----|-----------------|-------------------------|----------------|-------------|--------------------|----------------------|------------------|--------------------------|
| 1 | *2478.00 | 104.00 PK | | | 1.27 V | 325 | 71.10 | 32.90 |
| 2 | *2478.00 | 103.10 AV | | | 1.27 V | 325 | 70.20 | 32.90 |
| 3 | 2483.50 | 61.30 PK | 74.00 | -12.70 | 1.27 V | 325 | 62.80 | -1.50 |
| 4 | 2483.50 | 50.20 AV | 54.00 | -3.80 | 1.27 V | 325 | 51.70 | -1.50 |
| 5 | 4956.00 | 48.40 PK | 74.00 | -25.60 | 1.68 V | 254 | 42.80 | 5.60 |
| 6 | 4956.00 | 37.90 AV | 54.00 | -16.10 | 1.68 V | 254 | 32.30 | 5.60 |

Remarks:

1. Emission Level(dBuV/m) = Raw Value(dBuV) + Correction Factor(dB/m)
2. Correction Factor(dB/m) = Antenna Factor(dB/m) + Cable Factor(dB) – Pre-Amplifier Factor(dB)
3. Margin value = Emission Level – Limit value
4. The other emission levels were very low against the limit.
5. " * ": Fundamental frequency, the limit was restricted at the RF Output Power.

| | | | |
|------------------------|-----------------------|--|--|
| RF Mode | TX BT-LE 1M with 125K | Channel | CH 39 : 2480 MHz |
| Frequency Range | 1 GHz ~ 25 GHz | Detector Function & Bandwidth | (PK) RB = 1 MHz, VB = 3 MHz (AV) RB = 1 MHz, VB = 3 MHz |
| Input Power | 120 Vac, 60 Hz | Environmental Conditions | 22°C, 68% RH |
| Tested By | Rex Wang | Test Date | 2022/7/8 |

Antenna Polarity & Test Distance : Horizontal at 3 m

| No | Frequency (MHz) | Emission Level (dBuV/m) | Limit (dBuV/m) | Margin (dB) | Antenna Height (m) | Table Angle (Degree) | Raw Value (dBuV) | Correction Factor (dB/m) |
|----|-----------------|-------------------------|----------------|-------------|--------------------|----------------------|------------------|--------------------------|
| 1 | *2480.00 | 108.00 PK | | | 2.47 H | 192 | 75.10 | 32.90 |
| 2 | *2480.00 | 106.80 AV | | | 2.47 H | 192 | 73.90 | 32.90 |
| 3 | 2483.50 | 61.90 PK | 74.00 | -12.10 | 2.47 H | 192 | 63.40 | -1.50 |
| 4 | 2483.50 | 50.90 AV | 54.00 | -3.10 | 2.47 H | 192 | 52.40 | -1.50 |
| 5 | 4960.00 | 49.50 PK | 74.00 | -24.50 | 2.41 H | 25 | 43.80 | 5.70 |
| 6 | 4960.00 | 38.50 AV | 54.00 | -15.50 | 2.41 H | 25 | 32.80 | 5.70 |

Antenna Polarity & Test Distance : Vertical at 3 m

| No | Frequency (MHz) | Emission Level (dBuV/m) | Limit (dBuV/m) | Margin (dB) | Antenna Height (m) | Table Angle (Degree) | Raw Value (dBuV) | Correction Factor (dB/m) |
|----|-----------------|-------------------------|----------------|-------------|--------------------|----------------------|------------------|--------------------------|
| 1 | *2480.00 | 104.60 PK | | | 1.27 V | 325 | 71.70 | 32.90 |
| 2 | *2480.00 | 103.30 AV | | | 1.27 V | 325 | 70.40 | 32.90 |
| 3 | 2483.50 | 61.80 PK | 74.00 | -12.20 | 1.27 V | 325 | 63.30 | -1.50 |
| 4 | 2483.50 | 50.00 AV | 54.00 | -4.00 | 1.27 V | 325 | 51.50 | -1.50 |
| 5 | 4960.00 | 49.40 PK | 74.00 | -24.60 | 1.75 V | 255 | 43.70 | 5.70 |
| 6 | 4960.00 | 38.10 AV | 54.00 | -15.90 | 1.75 V | 255 | 32.40 | 5.70 |

Remarks:

1. Emission Level(dBuV/m) = Raw Value(dBuV) + Correction Factor(dB/m)
2. Correction Factor(dB/m) = Antenna Factor(dB/m) + Cable Factor(dB) – Pre-Amplifier Factor(dB)
3. Margin value = Emission Level – Limit value
4. The other emission levels were very low against the limit.
5. " * ": Fundamental frequency, the limit was restricted at the RF Output Power.

| | | | |
|------------------------|----------------|--|--|
| RF Mode | TX BT-LE 2M | Channel | CH 1 : 2404 MHz |
| Frequency Range | 1 GHz ~ 25 GHz | Detector Function & Bandwidth | (PK) RB = 1 MHz, VB = 3 MHz (AV) RB = 1 MHz, VB = 3 MHz |
| Input Power | 120 Vac, 60 Hz | Environmental Conditions | 22°C, 68% RH |
| Tested By | Rex Wang | Test Date | 2022/7/8 |

Antenna Polarity & Test Distance : Horizontal at 3 m

| No | Frequency (MHz) | Emission Level (dBuV/m) | Limit (dBuV/m) | Margin (dB) | Antenna Height (m) | Table Angle (Degree) | Raw Value (dBuV) | Correction Factor (dB/m) |
|----|-----------------|-------------------------|----------------|-------------|--------------------|----------------------|------------------|--------------------------|
| 1 | 2390.00 | 61.00 PK | 74.00 | -13.00 | 1.44 H | 202 | 62.50 | -1.50 |
| 2 | 2390.00 | 49.40 AV | 54.00 | -4.60 | 1.44 H | 202 | 50.90 | -1.50 |
| 3 | *2404.00 | 114.90 PK | | | 1.44 H | 202 | 82.10 | 32.80 |
| 4 | *2404.00 | 111.30 AV | | | 1.44 H | 202 | 78.50 | 32.80 |
| 5 | 4808.00 | 49.40 PK | 74.00 | -24.60 | 2.52 H | 22 | 43.60 | 5.80 |
| 6 | 4808.00 | 38.50 AV | 54.00 | -15.50 | 2.52 H | 22 | 32.70 | 5.80 |

Antenna Polarity & Test Distance : Vertical at 3 m

| No | Frequency (MHz) | Emission Level (dBuV/m) | Limit (dBuV/m) | Margin (dB) | Antenna Height (m) | Table Angle (Degree) | Raw Value (dBuV) | Correction Factor (dB/m) |
|----|-----------------|-------------------------|----------------|-------------|--------------------|----------------------|------------------|--------------------------|
| 1 | 2390.00 | 60.60 PK | 74.00 | -13.40 | 1.32 V | 327 | 62.10 | -1.50 |
| 2 | 2390.00 | 49.30 AV | 54.00 | -4.70 | 1.32 V | 327 | 50.80 | -1.50 |
| 3 | *2404.00 | 111.70 PK | | | 1.32 V | 327 | 78.90 | 32.80 |
| 4 | *2404.00 | 108.10 AV | | | 1.32 V | 327 | 75.30 | 32.80 |
| 5 | 4808.00 | 47.60 PK | 74.00 | -26.40 | 1.68 V | 247 | 41.80 | 5.80 |
| 6 | 4808.00 | 37.70 AV | 54.00 | -16.30 | 1.68 V | 247 | 31.90 | 5.80 |

Remarks:

1. Emission Level(dBuV/m) = Raw Value(dBuV) + Correction Factor(dB/m)
2. Correction Factor(dB/m) = Antenna Factor(dB/m) + Cable Factor(dB) – Pre-Amplifier Factor(dB)
3. Margin value = Emission Level – Limit value
4. The other emission levels were very low against the limit.
5. " * ": Fundamental frequency, the limit was restricted at the RF Output Power.

| | | | |
|------------------------|----------------|--|--|
| RF Mode | TX BT-LE 2M | Channel | CH 19 : 2440 MHz |
| Frequency Range | 1 GHz ~ 25 GHz | Detector Function & Bandwidth | (PK) RB = 1 MHz, VB = 3 MHz (AV) RB = 1 MHz, VB = 3 MHz |
| Input Power | 120 Vac, 60 Hz | Environmental Conditions | 22°C, 68% RH |
| Tested By | Rex Wang | Test Date | 2022/7/8 |

Antenna Polarity & Test Distance : Horizontal at 3 m

| No | Frequency (MHz) | Emission Level (dBuV/m) | Limit (dBuV/m) | Margin (dB) | Antenna Height (m) | Table Angle (Degree) | Raw Value (dBuV) | Correction Factor (dB/m) |
|----|-----------------|-------------------------|----------------|-------------|--------------------|----------------------|------------------|--------------------------|
| 1 | *2440.00 | 115.10 PK | | | 1.65 H | 188 | 82.30 | 32.80 |
| 2 | *2440.00 | 111.20 AV | | | 1.65 H | 188 | 78.40 | 32.80 |
| 3 | 4880.00 | 48.90 PK | 74.00 | -25.10 | 2.55 H | 24 | 43.40 | 5.50 |
| 4 | 4880.00 | 38.00 AV | 54.00 | -16.00 | 2.55 H | 24 | 32.50 | 5.50 |

Antenna Polarity & Test Distance : Vertical at 3 m

| No | Frequency (MHz) | Emission Level (dBuV/m) | Limit (dBuV/m) | Margin (dB) | Antenna Height (m) | Table Angle (Degree) | Raw Value (dBuV) | Correction Factor (dB/m) |
|----|-----------------|-------------------------|----------------|-------------|--------------------|----------------------|------------------|--------------------------|
| 1 | *2440.00 | 112.20 PK | | | 1.32 V | 324 | 79.40 | 32.80 |
| 2 | *2440.00 | 108.40 AV | | | 1.32 V | 324 | 75.60 | 32.80 |
| 3 | 4880.00 | 47.70 PK | 74.00 | -26.30 | 1.70 V | 254 | 42.20 | 5.50 |
| 4 | 4880.00 | 37.30 AV | 54.00 | -16.70 | 1.70 V | 254 | 31.80 | 5.50 |

Remarks:

1. Emission Level(dBuV/m) = Raw Value(dBuV) + Correction Factor(dB/m)
2. Correction Factor(dB/m) = Antenna Factor(dB/m) + Cable Factor(dB) – Pre-Amplifier Factor(dB)
3. Margin value = Emission Level – Limit value
4. The other emission levels were very low against the limit.
5. " * ": Fundamental frequency, the limit was restricted at the RF Output Power.

| | | | |
|------------------------|----------------|--|--|
| RF Mode | TX BT-LE 2M | Channel | CH 38 : 2478 MHz |
| Frequency Range | 1 GHz ~ 25 GHz | Detector Function & Bandwidth | (PK) RB = 1 MHz, VB = 3 MHz (AV) RB = 1 MHz, VB = 3 MHz |
| Input Power | 120 Vac, 60 Hz | Environmental Conditions | 22°C, 68% RH |
| Tested By | Rex Wang | Test Date | 2022/7/8 |

Antenna Polarity & Test Distance : Horizontal at 3 m

| No | Frequency (MHz) | Emission Level (dBuV/m) | Limit (dBuV/m) | Margin (dB) | Antenna Height (m) | Table Angle (Degree) | Raw Value (dBuV) | Correction Factor (dB/m) |
|----|-----------------|-------------------------|----------------|-------------|--------------------|----------------------|------------------|--------------------------|
| 1 | *2478.00 | 114.30 PK | | | 1.40 H | 202 | 81.40 | 32.90 |
| 2 | *2478.00 | 110.60 AV | | | 1.40 H | 202 | 77.70 | 32.90 |
| 3 | 2483.50 | 61.90 PK | 74.00 | -12.10 | 1.40 H | 202 | 63.40 | -1.50 |
| 4 | 2483.50 | 52.00 AV | 54.00 | -2.00 | 1.40 H | 202 | 53.50 | -1.50 |
| 5 | 4956.00 | 49.20 PK | 74.00 | -24.80 | 2.55 H | 27 | 43.60 | 5.60 |
| 6 | 4956.00 | 38.80 AV | 54.00 | -15.20 | 2.55 H | 27 | 33.20 | 5.60 |

Antenna Polarity & Test Distance : Vertical at 3 m

| No | Frequency (MHz) | Emission Level (dBuV/m) | Limit (dBuV/m) | Margin (dB) | Antenna Height (m) | Table Angle (Degree) | Raw Value (dBuV) | Correction Factor (dB/m) |
|----|-----------------|-------------------------|----------------|-------------|--------------------|----------------------|------------------|--------------------------|
| 1 | *2478.00 | 112.20 PK | | | 1.30 V | 325 | 79.30 | 32.90 |
| 2 | *2478.00 | 108.50 AV | | | 1.30 V | 325 | 75.60 | 32.90 |
| 3 | 2483.50 | 61.30 PK | 74.00 | -12.70 | 1.30 V | 325 | 62.80 | -1.50 |
| 4 | 2483.50 | 51.80 AV | 54.00 | -2.20 | 1.30 V | 325 | 53.30 | -1.50 |
| 5 | 4956.00 | 48.90 PK | 74.00 | -25.10 | 1.74 V | 282 | 43.30 | 5.60 |
| 6 | 4956.00 | 38.00 AV | 54.00 | -16.00 | 1.74 V | 282 | 32.40 | 5.60 |

Remarks:

1. Emission Level(dBuV/m) = Raw Value(dBuV) + Correction Factor(dB/m)
2. Correction Factor(dB/m) = Antenna Factor(dB/m) + Cable Factor(dB) – Pre-Amplifier Factor(dB)
3. Margin value = Emission Level – Limit value
4. The other emission levels were very low against the limit.
5. " * ": Fundamental frequency, the limit was restricted at the RF Output Power.

9 kHz ~ 1 GHz Worst-Case Data:

| | | | |
|------------------------|----------------|--|------------------|
| RF Mode | TX BT-LE 1M | Channel | CH 0 : 2402 MHz |
| Frequency Range | 30 MHz ~ 1 GHz | Detector Function & Bandwidth | (QP) RB = 120kHz |
| Input Power | 120 Vac, 60 Hz | Environmental Conditions | 23°C, 68% RH |
| Tested By | Adair Peng | Test Date | 2022/5/24 |

Antenna Polarity & Test Distance : Horizontal at 3 m

| No | Frequency (MHz) | Emission Level (dBuV/m) | Limit (dBuV/m) | Margin (dB) | Antenna Height (m) | Table Angle (Degree) | Raw Value (dBuV) | Correction Factor (dB/m) |
|----|-----------------|-------------------------|----------------|-------------|--------------------|----------------------|------------------|--------------------------|
| 1 | 79.47 | 30.80 QP | 40.00 | -9.20 | 1.50 H | 160 | 44.17 | -13.37 |
| 2 | 152.22 | 28.36 QP | 43.50 | -15.14 | 1.50 H | 66 | 37.17 | -8.81 |
| 3 | 225.94 | 26.62 QP | 46.00 | -19.38 | 1.00 H | 93 | 37.83 | -11.21 |
| 4 | 340.40 | 30.76 QP | 46.00 | -15.24 | 1.00 H | 260 | 36.84 | -6.08 |
| 5 | 444.19 | 29.53 QP | 46.00 | -16.47 | 1.00 H | 178 | 33.17 | -3.64 |
| 6 | 609.09 | 29.68 QP | 46.00 | -16.32 | 2.00 H | 254 | 29.85 | -0.17 |

Remarks:

1. Emission Level(dBuV/m) = Raw Value(dBuV) + Correction Factor(dB/m)
2. Correction Factor(dB/m) = Antenna Factor(dB/m) + Cable Factor(dB) – Pre-Amplifier Factor(dB)
3. Margin value = Emission Level – Limit value
4. The other emission levels were very low against the limit of frequency range 30 MHz ~ 1 GHz.
5. The emission levels were very low against the limit of frequency range 9 kHz ~ 30 MHz: the amplitude of spurious emissions attenuated more than 20 dB below the permissible value to be report.

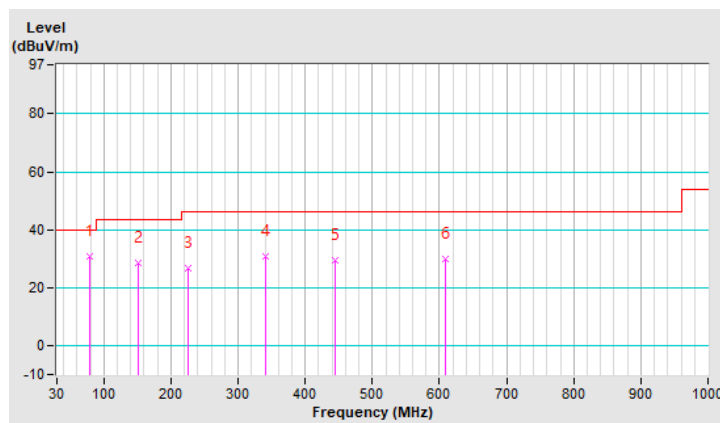

| | | | |
|------------------------|----------------|--|------------------|
| RF Mode | TX BT-LE 1M | Channel | CH 0 : 2402 MHz |
| Frequency Range | 30 MHz ~ 1 GHz | Detector Function & Bandwidth | (QP) RB = 120kHz |
| Input Power | 120 Vac, 60 Hz | Environmental Conditions | 23°C, 68% RH |
| Tested By | Adair Peng | Test Date | 2022/5/24 |

| Antenna Polarity & Test Distance : Vertical at 3 m | | | | | | | | |
|--|-----------------|-------------------------|----------------|-------------|--------------------|----------------------|------------------|--------------------------|
| No | Frequency (MHz) | Emission Level (dBuV/m) | Limit (dBuV/m) | Margin (dB) | Antenna Height (m) | Table Angle (Degree) | Raw Value (dBuV) | Correction Factor (dB/m) |
| 1 | 31.94 | 35.85 QP | 40.00 | -4.15 | 1.49 V | 14 | 46.48 | -10.63 |
| 2 | 49.40 | 36.72 QP | 40.00 | -3.28 | 1.00 V | 195 | 45.71 | -8.99 |
| 3 | 135.73 | 31.59 QP | 43.50 | -11.91 | 1.49 V | 14 | 41.22 | -9.63 |
| 4 | 341.37 | 28.57 QP | 46.00 | -17.43 | 2.00 V | 295 | 34.67 | -6.10 |
| 5 | 444.19 | 32.58 QP | 46.00 | -13.42 | 1.49 V | 231 | 36.22 | -3.64 |
| 6 | 503.36 | 30.86 QP | 46.00 | -15.14 | 1.00 V | 163 | 33.34 | -2.48 |

Remarks:

1. Emission Level(dBuV/m) = Raw Value(dBuV) + Correction Factor(dB/m)
2. Correction Factor(dB/m) = Antenna Factor(dB/m) + Cable Factor(dB) – Pre-Amplifier Factor(dB)
3. Margin value = Emission Level – Limit value
4. The other emission levels were very low against the limit of frequency range 30 MHz ~ 1 GHz.
5. The emission levels were very low against the limit of frequency range 9 kHz ~ 30 MHz: the amplitude of spurious emissions attenuated more than 20 dB below the permissible value to be report.

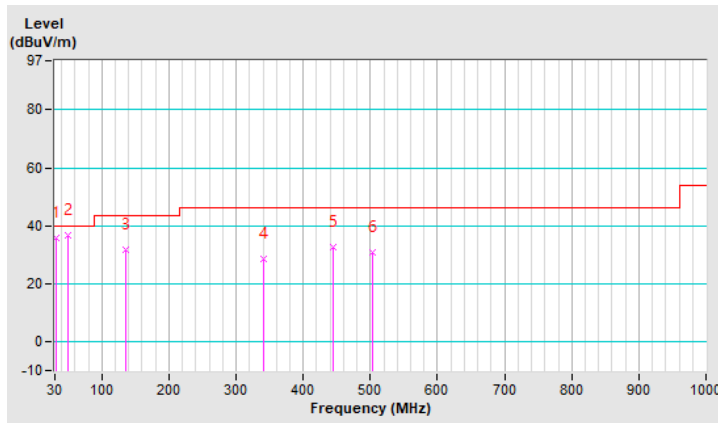

| | | | |
|------------------------|-----------------------|--|------------------|
| RF Mode | TX BT-LE 1M with 125K | Channel | CH 19 : 2440 MHz |
| Frequency Range | 30 MHz ~ 1 GHz | Detector Function & Bandwidth | (QP) RB = 120kHz |
| Input Power | 120 Vac, 60 Hz | Environmental Conditions | 23°C, 68% RH |
| Tested By | Adair Peng | Test Date | 2022/5/24 |

| Antenna Polarity & Test Distance : Horizontal at 3 m | | | | | | | | |
|--|-----------------|-------------------------|----------------|-------------|--------------------|----------------------|------------------|--------------------------|
| No | Frequency (MHz) | Emission Level (dBuV/m) | Limit (dBuV/m) | Margin (dB) | Antenna Height (m) | Table Angle (Degree) | Raw Value (dBuV) | Correction Factor (dB/m) |
| 1 | 78.50 | 32.43 QP | 40.00 | -7.57 | 1.50 H | 180 | 45.59 | -13.16 |
| 2 | 90.14 | 32.25 QP | 43.50 | -11.25 | 1.50 H | 15 | 47.05 | -14.80 |
| 3 | 243.40 | 28.41 QP | 46.00 | -17.59 | 1.00 H | 112 | 37.68 | -9.27 |
| 4 | 361.74 | 31.32 QP | 46.00 | -14.68 | 1.00 H | 47 | 37.13 | -5.81 |
| 5 | 444.19 | 28.86 QP | 46.00 | -17.14 | 1.00 H | 178 | 32.50 | -3.64 |
| 6 | 628.49 | 30.18 QP | 46.00 | -15.82 | 2.00 H | 238 | 30.08 | 0.10 |

Remarks:

1. Emission Level(dBuV/m) = Raw Value(dBuV) + Correction Factor(dB/m)
2. Correction Factor(dB/m) = Antenna Factor(dB/m) + Cable Factor(dB) – Pre-Amplifier Factor(dB)
3. Margin value = Emission Level – Limit value
4. The other emission levels were very low against the limit of frequency range 30 MHz ~ 1 GHz.
5. The emission levels were very low against the limit of frequency range 9 kHz ~ 30 MHz: the amplitude of spurious emissions attenuated more than 20 dB below the permissible value to be report.

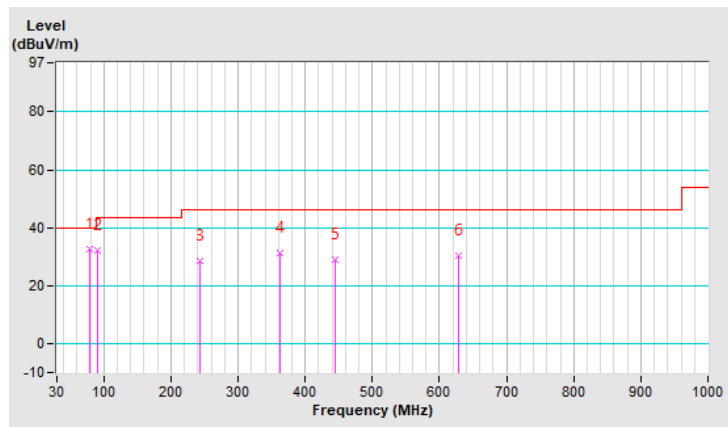

| | | | |
|------------------------|-----------------------|--|------------------|
| RF Mode | TX BT-LE 1M with 125K | Channel | CH 19 : 2440 MHz |
| Frequency Range | 30 MHz ~ 1 GHz | Detector Function & Bandwidth | (QP) RB = 120kHz |
| Input Power | 120 Vac, 60 Hz | Environmental Conditions | 23°C, 68% RH |
| Tested By | Adair Peng | Test Date | 2022/5/24 |

| Antenna Polarity & Test Distance : Vertical at 3 m | | | | | | | | |
|--|-----------------|-------------------------|----------------|-------------|--------------------|----------------------|------------------|--------------------------|
| No | Frequency (MHz) | Emission Level (dBuV/m) | Limit (dBuV/m) | Margin (dB) | Antenna Height (m) | Table Angle (Degree) | Raw Value (dBuV) | Correction Factor (dB/m) |
| 1 | 33.88 | 35.19 QP | 40.00 | -4.81 | 1.50 V | 80 | 45.71 | -10.52 |
| 2 | 53.28 | 36.01 QP | 40.00 | -3.99 | 1.00 V | 199 | 45.12 | -9.11 |
| 3 | 152.22 | 29.19 QP | 43.50 | -14.31 | 2.00 V | 40 | 38.00 | -8.81 |
| 4 | 292.87 | 32.11 QP | 46.00 | -13.89 | 1.00 V | 57 | 39.25 | -7.14 |
| 5 | 428.67 | 27.42 QP | 46.00 | -18.58 | 1.50 V | 174 | 31.40 | -3.98 |
| 6 | 522.76 | 30.11 QP | 46.00 | -15.89 | 1.00 V | 355 | 32.13 | -2.02 |

Remarks:

1. Emission Level(dBuV/m) = Raw Value(dBuV) + Correction Factor(dB/m)
2. Correction Factor(dB/m) = Antenna Factor(dB/m) + Cable Factor(dB) – Pre-Amplifier Factor(dB)
3. Margin value = Emission Level – Limit value
4. The other emission levels were very low against the limit of frequency range 30 MHz ~ 1 GHz.
5. The emission levels were very low against the limit of frequency range 9 kHz ~ 30 MHz: the amplitude of spurious emissions attenuated more than 20 dB below the permissible value to be report.

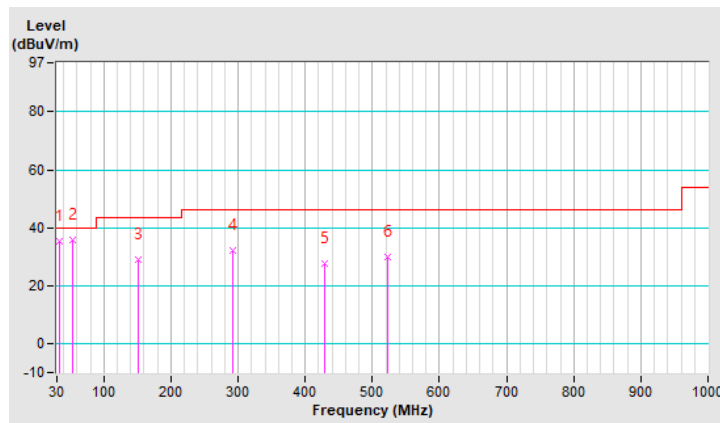

| | | | |
|------------------------|----------------|--|------------------|
| RF Mode | TX BT-LE 2M | Channel | CH 1 : 2404 MHz |
| Frequency Range | 30 MHz ~ 1 GHz | Detector Function & Bandwidth | (QP) RB = 120kHz |
| Input Power | 120 Vac, 60 Hz | Environmental Conditions | 23°C, 68% RH |
| Tested By | Adair Peng | Test Date | 2022/5/24 |

| Antenna Polarity & Test Distance : Horizontal at 3 m | | | | | | | | |
|--|-----------------|-------------------------|----------------|-------------|--------------------|----------------------|------------------|--------------------------|
| No | Frequency (MHz) | Emission Level (dBuV/m) | Limit (dBuV/m) | Margin (dB) | Antenna Height (m) | Table Angle (Degree) | Raw Value (dBuV) | Correction Factor (dB/m) |
| 1 | 52.31 | 35.51 QP | 40.00 | -4.49 | 1.50 H | 166 | 44.50 | -8.99 |
| 2 | 81.41 | 30.58 QP | 40.00 | -9.42 | 1.00 H | 19 | 44.47 | -13.89 |
| 3 | 196.84 | 32.27 QP | 43.50 | -11.23 | 2.00 H | 37 | 43.86 | -11.59 |
| 4 | 338.46 | 31.31 QP | 46.00 | -14.69 | 2.00 H | 265 | 37.37 | -6.06 |
| 5 | 384.05 | 29.31 QP | 46.00 | -16.69 | 1.00 H | 62 | 34.55 | -5.24 |
| 6 | 445.16 | 30.02 QP | 46.00 | -15.98 | 1.00 H | 192 | 33.66 | -3.64 |

Remarks:

1. Emission Level(dBuV/m) = Raw Value(dBuV) + Correction Factor(dB/m)
2. Correction Factor(dB/m) = Antenna Factor(dB/m) + Cable Factor(dB) – Pre-Amplifier Factor(dB)
3. Margin value = Emission Level – Limit value
4. The other emission levels were very low against the limit of frequency range 30 MHz ~ 1 GHz.
5. The emission levels were very low against the limit of frequency range 9 kHz ~ 30 MHz: the amplitude of spurious emissions attenuated more than 20 dB below the permissible value to be report.

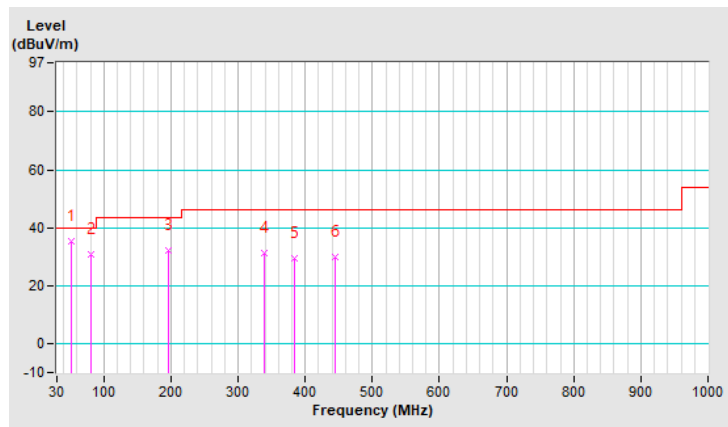

| | | | |
|------------------------|----------------|--|------------------|
| RF Mode | TX BT-LE 2M | Channel | CH 1 : 2404 MHz |
| Frequency Range | 30 MHz ~ 1 GHz | Detector Function & Bandwidth | (QP) RB = 120kHz |
| Input Power | 120 Vac, 60 Hz | Environmental Conditions | 23°C, 68% RH |
| Tested By | Adair Peng | Test Date | 2022/5/24 |

| Antenna Polarity & Test Distance : Vertical at 3 m | | | | | | | | |
|--|-----------------|-------------------------|----------------|-------------|--------------------|----------------------|------------------|--------------------------|
| No | Frequency (MHz) | Emission Level (dBuV/m) | Limit (dBuV/m) | Margin (dB) | Antenna Height (m) | Table Angle (Degree) | Raw Value (dBuV) | Correction Factor (dB/m) |
| 1 | 30.97 | 32.39 QP | 40.00 | -7.61 | 1.50 V | 160 | 42.97 | -10.58 |
| 2 | 54.25 | 33.75 QP | 40.00 | -6.25 | 1.00 V | 246 | 42.97 | -9.22 |
| 3 | 90.14 | 32.15 QP | 43.50 | -11.35 | 2.00 V | 204 | 46.95 | -14.80 |
| 4 | 152.22 | 28.46 QP | 43.50 | -15.04 | 1.00 V | 187 | 37.27 | -8.81 |
| 5 | 451.95 | 27.69 QP | 46.00 | -18.31 | 1.50 V | 181 | 31.12 | -3.43 |
| 6 | 581.93 | 30.67 QP | 46.00 | -15.33 | 1.00 V | 212 | 31.41 | -0.74 |

Remarks:

1. Emission Level(dBuV/m) = Raw Value(dBuV) + Correction Factor(dB/m)
2. Correction Factor(dB/m) = Antenna Factor(dB/m) + Cable Factor(dB) – Pre-Amplifier Factor(dB)
3. Margin value = Emission Level – Limit value
4. The other emission levels were very low against the limit of frequency range 30 MHz ~ 1 GHz.
5. The emission levels were very low against the limit of frequency range 9 kHz ~ 30 MHz: the amplitude of spurious emissions attenuated more than 20 dB below the permissible value to be report.

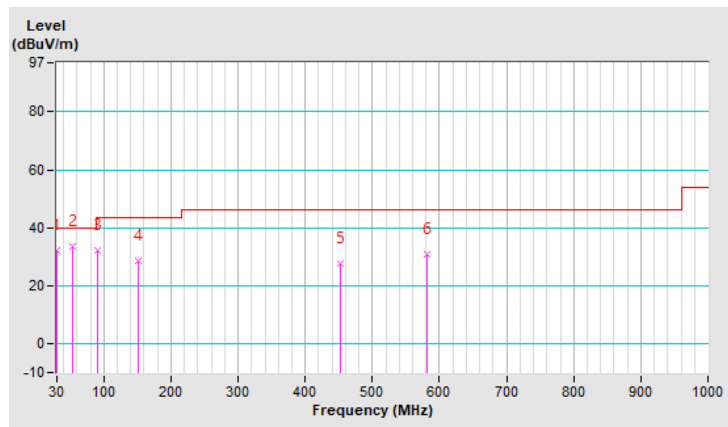

Mode B

| | | | |
|------------------------|----------------|--|--|
| RF Mode | TX BT-LE 1M | Channel | CH 0 : 2402 MHz |
| Frequency Range | 1 GHz ~ 25 GHz | Detector Function & Bandwidth | (PK) RB = 1 MHz, VB = 3 MHz (AV) RB = 1 MHz, VB = 3 MHz |
| Input Power | 120 Vac, 60 Hz | Environmental Conditions | 22°C, 68% RH |
| Tested By | Rex Wang | Test Date | 2022/7/8 |

Antenna Polarity & Test Distance : Horizontal at 3 m

| No | Frequency (MHz) | Emission Level (dBuV/m) | Limit (dBuV/m) | Margin (dB) | Antenna Height (m) | Table Angle (Degree) | Raw Value (dBuV) | Correction Factor (dB/m) |
|----|-----------------|-------------------------|----------------|-------------|--------------------|----------------------|------------------|--------------------------|
| 1 | 2390.00 | 60.65 PK | 74.00 | -13.35 | 1.80 H | 55 | 62.10 | -1.45 |
| 2 | 2390.00 | 50.35 AV | 54.00 | -3.65 | 1.80 H | 55 | 51.80 | -1.45 |
| 3 | *2402.00 | 114.14 PK | | | 1.80 H | 55 | 81.30 | 32.84 |
| 4 | *2402.00 | 112.00 AV | | | 1.80 H | 55 | 79.16 | 32.84 |
| 5 | 4804.00 | 49.99 PK | 74.00 | -24.01 | 3.52 H | 55 | 44.30 | 5.69 |
| 6 | 4804.00 | 41.54 AV | 54.00 | -12.46 | 3.52 H | 55 | 35.85 | 5.69 |

Antenna Polarity & Test Distance : Vertical at 3 m

| No | Frequency (MHz) | Emission Level (dBuV/m) | Limit (dBuV/m) | Margin (dB) | Antenna Height (m) | Table Angle (Degree) | Raw Value (dBuV) | Correction Factor (dB/m) |
|----|-----------------|-------------------------|----------------|-------------|--------------------|----------------------|------------------|--------------------------|
| 1 | 2390.00 | 60.55 PK | 74.00 | -13.45 | 3.73 V | 1 | 62.00 | -1.45 |
| 2 | 2390.00 | 50.15 AV | 54.00 | -3.85 | 3.73 V | 1 | 51.60 | -1.45 |
| 3 | *2402.00 | 113.44 PK | | | 3.73 V | 1 | 80.60 | 32.84 |
| 4 | *2402.00 | 111.64 AV | | | 3.73 V | 1 | 78.80 | 32.84 |
| 5 | 4804.00 | 49.59 PK | 74.00 | -24.41 | 2.40 V | 108 | 43.90 | 5.69 |
| 6 | 4804.00 | 40.69 AV | 54.00 | -13.31 | 2.40 V | 108 | 35.00 | 5.69 |

Remarks:

1. Emission Level(dBuV/m) = Raw Value(dBuV) + Correction Factor(dB/m)
2. Correction Factor(dB/m) = Antenna Factor(dB/m) + Cable Factor(dB) – Pre-Amplifier Factor(dB)
3. Margin value = Emission Level – Limit value
4. The other emission levels were very low against the limit.
5. " * " : Fundamental frequency, the limit was restricted at the RF Output Power.

| | | | |
|------------------------|----------------|--|--|
| RF Mode | TX BT-LE 1M | Channel | CH 1 : 2404 MHz |
| Frequency Range | 1 GHz ~ 25 GHz | Detector Function & Bandwidth | (PK) RB = 1 MHz, VB = 3 MHz (AV) RB = 1 MHz, VB = 3 MHz |
| Input Power | 120 Vac, 60 Hz | Environmental Conditions | 22°C, 68% RH |
| Tested By | Rex Wang | Test Date | 2022/7/8 |

Antenna Polarity & Test Distance : Horizontal at 3 m

| No | Frequency (MHz) | Emission Level (dBuV/m) | Limit (dBuV/m) | Margin (dB) | Antenna Height (m) | Table Angle (Degree) | Raw Value (dBuV) | Correction Factor (dB/m) |
|----|-----------------|-------------------------|----------------|-------------|--------------------|----------------------|------------------|--------------------------|
| 1 | 2390.00 | 60.85 PK | 74.00 | -13.15 | 1.44 H | 56 | 62.30 | -1.45 |
| 2 | 2390.00 | 50.55 AV | 54.00 | -3.45 | 1.44 H | 56 | 52.00 | -1.45 |
| 3 | *2404.00 | 114.14 PK | | | 1.44 H | 56 | 81.30 | 32.84 |
| 4 | *2404.00 | 112.14 AV | | | 1.44 H | 56 | 79.30 | 32.84 |
| 5 | 4808.00 | 50.18 PK | 74.00 | -23.82 | 3.47 H | 62 | 44.50 | 5.68 |
| 6 | 4808.00 | 41.35 AV | 54.00 | -12.65 | 3.47 H | 62 | 35.67 | 5.68 |

Antenna Polarity & Test Distance : Vertical at 3 m

| No | Frequency (MHz) | Emission Level (dBuV/m) | Limit (dBuV/m) | Margin (dB) | Antenna Height (m) | Table Angle (Degree) | Raw Value (dBuV) | Correction Factor (dB/m) |
|----|-----------------|-------------------------|----------------|-------------|--------------------|----------------------|------------------|--------------------------|
| 1 | 2390.00 | 60.45 PK | 74.00 | -13.55 | 3.78 V | 1 | 61.90 | -1.45 |
| 2 | 2390.00 | 50.05 AV | 54.00 | -3.95 | 3.78 V | 1 | 51.50 | -1.45 |
| 3 | *2404.00 | 113.14 PK | | | 3.78 V | 1 | 80.30 | 32.84 |
| 4 | *2404.00 | 112.24 AV | | | 3.78 V | 1 | 79.40 | 32.84 |
| 5 | 4808.00 | 49.38 PK | 74.00 | -24.62 | 2.40 V | 103 | 43.70 | 5.68 |
| 6 | 4808.00 | 40.28 AV | 54.00 | -13.72 | 2.40 V | 103 | 34.60 | 5.68 |

Remarks:

1. Emission Level(dBuV/m) = Raw Value(dBuV) + Correction Factor(dB/m)
2. Correction Factor(dB/m) = Antenna Factor(dB/m) + Cable Factor(dB) – Pre-Amplifier Factor(dB)
3. Margin value = Emission Level – Limit value
4. The other emission levels were very low against the limit.
5. " * ": Fundamental frequency, the limit was restricted at the RF Output Power.

| | | | |
|------------------------|----------------|--|--|
| RF Mode | TX BT-LE 1M | Channel | CH 19 : 2440 MHz |
| Frequency Range | 1 GHz ~ 25 GHz | Detector Function & Bandwidth | (PK) RB = 1 MHz, VB = 3 MHz (AV) RB = 1 MHz, VB = 3 MHz |
| Input Power | 120 Vac, 60 Hz | Environmental Conditions | 22°C, 68% RH |
| Tested By | Rex Wang | Test Date | 2022/7/8 |

Antenna Polarity & Test Distance : Horizontal at 3 m

| No | Frequency (MHz) | Emission Level (dBuV/m) | Limit (dBuV/m) | Margin (dB) | Antenna Height (m) | Table Angle (Degree) | Raw Value (dBuV) | Correction Factor (dB/m) |
|----|-----------------|-------------------------|----------------|-------------|--------------------|----------------------|------------------|--------------------------|
| 1 | *2440.00 | 113.91 PK | | | 1.19 H | 56 | 81.10 | 32.81 |
| 2 | *2440.00 | 111.81 AV | | | 1.19 H | 56 | 79.00 | 32.81 |
| 3 | 4880.00 | 50.11 PK | 74.00 | -23.89 | 3.54 H | 62 | 44.60 | 5.51 |
| 4 | 4880.00 | 41.35 AV | 54.00 | -12.65 | 3.54 H | 62 | 35.84 | 5.51 |

Antenna Polarity & Test Distance : Vertical at 3 m

| No | Frequency (MHz) | Emission Level (dBuV/m) | Limit (dBuV/m) | Margin (dB) | Antenna Height (m) | Table Angle (Degree) | Raw Value (dBuV) | Correction Factor (dB/m) |
|----|-----------------|-------------------------|----------------|-------------|--------------------|----------------------|------------------|--------------------------|
| 1 | *2440.00 | 112.51 PK | | | 3.55 V | 1 | 79.70 | 32.81 |
| 2 | *2440.00 | 110.71 AV | | | 3.55 V | 1 | 77.90 | 32.81 |
| 3 | 4880.00 | 48.91 PK | 74.00 | -25.09 | 2.46 V | 105 | 43.40 | 5.51 |
| 4 | 4880.00 | 39.91 AV | 54.00 | -14.09 | 2.46 V | 105 | 34.40 | 5.51 |

Remarks:

1. Emission Level(dBuV/m) = Raw Value(dBuV) + Correction Factor(dB/m)
2. Correction Factor(dB/m) = Antenna Factor(dB/m) + Cable Factor(dB) – Pre-Amplifier Factor(dB)
3. Margin value = Emission Level – Limit value
4. The other emission levels were very low against the limit.
5. " * ": Fundamental frequency, the limit was restricted at the RF Output Power.

| | | | |
|------------------------|----------------|--|--|
| RF Mode | TX BT-LE 1M | Channel | CH 38 : 2478 MHz |
| Frequency Range | 1 GHz ~ 25 GHz | Detector Function & Bandwidth | (PK) RB = 1 MHz, VB = 3 MHz (AV) RB = 1 MHz, VB = 3 MHz |
| Input Power | 120 Vac, 60 Hz | Environmental Conditions | 22°C, 68% RH |
| Tested By | Rex Wang | Test Date | 2022/7/8 |

Antenna Polarity & Test Distance : Horizontal at 3 m

| No | Frequency (MHz) | Emission Level (dBuV/m) | Limit (dBuV/m) | Margin (dB) | Antenna Height (m) | Table Angle (Degree) | Raw Value (dBuV) | Correction Factor (dB/m) |
|----|-----------------|-------------------------|----------------|-------------|--------------------|----------------------|------------------|--------------------------|
| 1 | *2478.00 | 114.93 PK | | | 1.36 H | 54 | 82.10 | 32.83 |
| 2 | *2478.00 | 113.53 AV | | | 1.36 H | 54 | 80.70 | 32.83 |
| 3 | 2483.50 | 63.74 PK | 74.00 | -10.26 | 1.36 H | 54 | 65.30 | -1.56 |
| 4 | 2483.50 | 50.69 AV | 54.00 | -3.31 | 1.36 H | 54 | 52.25 | -1.56 |
| 5 | 4956.00 | 50.21 PK | 74.00 | -23.79 | 3.51 H | 57 | 44.60 | 5.61 |
| 6 | 4956.00 | 41.11 AV | 54.00 | -12.89 | 3.51 H | 57 | 35.50 | 5.61 |

Antenna Polarity & Test Distance : Vertical at 3 m

| No | Frequency (MHz) | Emission Level (dBuV/m) | Limit (dBuV/m) | Margin (dB) | Antenna Height (m) | Table Angle (Degree) | Raw Value (dBuV) | Correction Factor (dB/m) |
|----|-----------------|-------------------------|----------------|-------------|--------------------|----------------------|------------------|--------------------------|
| 1 | *2478.00 | 112.83 PK | | | 3.47 V | 2 | 80.00 | 32.83 |
| 2 | *2478.00 | 111.63 AV | | | 3.47 V | 2 | 78.80 | 32.83 |
| 3 | 2483.50 | 62.04 PK | 74.00 | -11.96 | 3.47 V | 2 | 63.60 | -1.56 |
| 4 | 2483.50 | 50.54 AV | 54.00 | -3.46 | 3.47 V | 2 | 52.10 | -1.56 |
| 5 | 4956.00 | 49.51 PK | 74.00 | -24.49 | 2.42 V | 108 | 43.90 | 5.61 |
| 6 | 4956.00 | 40.31 AV | 54.00 | -13.69 | 2.42 V | 108 | 34.70 | 5.61 |

Remarks:

1. Emission Level(dBuV/m) = Raw Value(dBuV) + Correction Factor(dB/m)
2. Correction Factor(dB/m) = Antenna Factor(dB/m) + Cable Factor(dB) – Pre-Amplifier Factor(dB)
3. Margin value = Emission Level – Limit value
4. The other emission levels were very low against the limit.
5. " * ": Fundamental frequency, the limit was restricted at the RF Output Power.

| | | | |
|------------------------|----------------|--|--|
| RF Mode | TX BT-LE 1M | Channel | CH 39 : 2480 MHz |
| Frequency Range | 1 GHz ~ 25 GHz | Detector Function & Bandwidth | (PK) RB = 1 MHz, VB = 3 MHz (AV) RB = 1 MHz, VB = 3 MHz |
| Input Power | 120 Vac, 60 Hz | Environmental Conditions | 22°C, 68% RH |
| Tested By | Rex Wang | Test Date | 2022/7/4 |

Antenna Polarity & Test Distance : Horizontal at 3 m

| No | Frequency (MHz) | Emission Level (dBuV/m) | Limit (dBuV/m) | Margin (dB) | Antenna Height (m) | Table Angle (Degree) | Raw Value (dBuV) | Correction Factor (dB/m) |
|----------|-----------------|-------------------------|----------------|--------------|--------------------|----------------------|------------------|--------------------------|
| 1 | *2480.00 | 113.39 PK | | | 2.00 H | 63 | 80.56 | 32.83 |
| 2 | *2480.00 | 111.23 AV | | | 2.00 H | 63 | 78.40 | 32.83 |
| 3 | 2483.50 | 70.79 PK | 74.00 | -3.21 | 2.00 H | 63 | 72.35 | -1.56 |
| 4 | 2483.50 | 53.50 AV | 54.00 | -0.50 | 2.00 H | 63 | 55.06 | -1.56 |
| 5 | 4960.00 | 48.08 PK | 74.00 | -25.92 | 3.05 H | 111 | 42.44 | 5.64 |
| 6 | 4960.00 | 38.92 AV | 54.00 | -15.08 | 3.05 H | 111 | 33.28 | 5.64 |

Antenna Polarity & Test Distance : Vertical at 3 m

| No | Frequency (MHz) | Emission Level (dBuV/m) | Limit (dBuV/m) | Margin (dB) | Antenna Height (m) | Table Angle (Degree) | Raw Value (dBuV) | Correction Factor (dB/m) |
|----|-----------------|-------------------------|----------------|-------------|--------------------|----------------------|------------------|--------------------------|
| 1 | *2480.00 | 110.57 PK | | | 3.55 V | 10 | 77.74 | 32.83 |
| 2 | *2480.00 | 108.50 AV | | | 3.55 V | 10 | 75.67 | 32.83 |
| 3 | 2483.50 | 66.93 PK | 74.00 | -7.07 | 3.55 V | 10 | 68.49 | -1.56 |
| 4 | 2483.50 | 50.55 AV | 54.00 | -3.45 | 3.55 V | 10 | 52.11 | -1.56 |
| 5 | 4960.00 | 47.19 PK | 74.00 | -26.81 | 2.42 V | 106 | 41.55 | 5.64 |
| 6 | 4960.00 | 38.24 AV | 54.00 | -15.76 | 2.42 V | 106 | 32.60 | 5.64 |

Remarks:

1. Emission Level(dBuV/m) = Raw Value(dBuV) + Correction Factor(dB/m)
2. Correction Factor(dB/m) = Antenna Factor(dB/m) + Cable Factor(dB) – Pre-Amplifier Factor(dB)
3. Margin value = Emission Level – Limit value
4. The other emission levels were very low against the limit.
5. " * ": Fundamental frequency, the limit was restricted at the RF Output Power.

| | | | |
|------------------------|-----------------------|--|--|
| RF Mode | TX BT-LE 1M with 125K | Channel | CH 0 : 2402 MHz |
| Frequency Range | 1 GHz ~ 25 GHz | Detector Function & Bandwidth | (PK) RB = 1 MHz, VB = 3 MHz (AV) RB = 1 MHz, VB = 3 MHz |
| Input Power | 120 Vac, 60 Hz | Environmental Conditions | 22°C, 68% RH |
| Tested By | Rex Wang | Test Date | 2022/7/8 |

Antenna Polarity & Test Distance : Horizontal at 3 m

| No | Frequency (MHz) | Emission Level (dBuV/m) | Limit (dBuV/m) | Margin (dB) | Antenna Height (m) | Table Angle (Degree) | Raw Value (dBuV) | Correction Factor (dB/m) |
|----|-----------------|-------------------------|----------------|-------------|--------------------|----------------------|------------------|--------------------------|
| 1 | 2390.00 | 60.85 PK | 74.00 | -13.15 | 1.71 H | 54 | 62.30 | -1.45 |
| 2 | 2390.00 | 50.95 AV | 54.00 | -3.05 | 1.71 H | 54 | 52.40 | -1.45 |
| 3 | *2402.00 | 106.50 PK | | | 1.71 H | 54 | 73.66 | 32.84 |
| 4 | *2402.00 | 104.64 AV | | | 1.71 H | 54 | 71.80 | 32.84 |
| 5 | 4804.00 | 48.29 PK | 74.00 | -25.71 | 3.44 H | 59 | 42.60 | 5.69 |
| 6 | 4804.00 | 38.19 AV | 54.00 | -15.81 | 3.44 H | 59 | 32.50 | 5.69 |

Antenna Polarity & Test Distance : Vertical at 3 m

| No | Frequency (MHz) | Emission Level (dBuV/m) | Limit (dBuV/m) | Margin (dB) | Antenna Height (m) | Table Angle (Degree) | Raw Value (dBuV) | Correction Factor (dB/m) |
|----|-----------------|-------------------------|----------------|-------------|--------------------|----------------------|------------------|--------------------------|
| 1 | 2390.00 | 60.80 PK | 74.00 | -13.20 | 3.70 V | 2 | 62.30 | -1.50 |
| 2 | 2390.00 | 50.70 AV | 54.00 | -3.30 | 3.70 V | 2 | 52.20 | -1.50 |
| 3 | *2402.00 | 106.10 PK | | | 3.70 V | 2 | 73.30 | 32.80 |
| 4 | *2402.00 | 104.10 AV | | | 3.70 V | 2 | 71.30 | 32.80 |
| 5 | 4804.00 | 47.60 PK | 74.00 | -26.40 | 2.48 V | 106 | 41.80 | 5.80 |
| 6 | 4804.00 | 37.20 AV | 54.00 | -16.80 | 2.48 V | 106 | 31.40 | 5.80 |

Remarks:

1. Emission Level(dBuV/m) = Raw Value(dBuV) + Correction Factor(dB/m)
2. Correction Factor(dB/m) = Antenna Factor(dB/m) + Cable Factor(dB) – Pre-Amplifier Factor(dB)
3. Margin value = Emission Level – Limit value
4. The other emission levels were very low against the limit.
5. " * ": Fundamental frequency, the limit was restricted at the RF Output Power.

| | | | |
|------------------------|-----------------------|--|--|
| RF Mode | TX BT-LE 1M with 125K | Channel | CH 1 : 2404 MHz |
| Frequency Range | 1 GHz ~ 25 GHz | Detector Function & Bandwidth | (PK) RB = 1 MHz, VB = 3 MHz (AV) RB = 1 MHz, VB = 3 MHz |
| Input Power | 120 Vac, 60 Hz | Environmental Conditions | 22°C, 68% RH |
| Tested By | Rex Wang | Test Date | 2022/7/8 |

Antenna Polarity & Test Distance : Horizontal at 3 m

| No | Frequency (MHz) | Emission Level (dBuV/m) | Limit (dBuV/m) | Margin (dB) | Antenna Height (m) | Table Angle (Degree) | Raw Value (dBuV) | Correction Factor (dB/m) |
|----|-----------------|-------------------------|----------------|-------------|--------------------|----------------------|------------------|--------------------------|
| 1 | 2390.00 | 60.75 PK | 74.00 | -13.25 | 1.69 H | 54 | 62.20 | -1.45 |
| 2 | 2390.00 | 51.05 AV | 54.00 | -2.95 | 1.69 H | 54 | 52.50 | -1.45 |
| 3 | *2404.00 | 106.88 PK | | | 1.69 H | 54 | 74.04 | 32.84 |
| 4 | *2404.00 | 105.86 AV | | | 1.69 H | 54 | 73.02 | 32.84 |
| 5 | 4808.00 | 49.48 PK | 74.00 | -24.52 | 3.46 H | 55 | 43.80 | 5.68 |
| 6 | 4808.00 | 38.28 AV | 54.00 | -15.72 | 3.46 H | 55 | 32.60 | 5.68 |

Antenna Polarity & Test Distance : Vertical at 3 m

| No | Frequency (MHz) | Emission Level (dBuV/m) | Limit (dBuV/m) | Margin (dB) | Antenna Height (m) | Table Angle (Degree) | Raw Value (dBuV) | Correction Factor (dB/m) |
|----|-----------------|-------------------------|----------------|-------------|--------------------|----------------------|------------------|--------------------------|
| 1 | 2390.00 | 60.35 PK | 74.00 | -13.65 | 3.67 V | 1 | 61.80 | -1.45 |
| 2 | 2390.00 | 50.35 AV | 54.00 | -3.65 | 3.67 V | 1 | 51.80 | -1.45 |
| 3 | *2404.00 | 105.94 PK | | | 3.67 V | 1 | 73.10 | 32.84 |
| 4 | *2404.00 | 104.64 AV | | | 3.67 V | 1 | 71.80 | 32.84 |
| 5 | 4808.00 | 47.88 PK | 74.00 | -26.12 | 2.38 V | 107 | 42.20 | 5.68 |
| 6 | 4808.00 | 36.98 AV | 54.00 | -17.02 | 2.38 V | 107 | 31.30 | 5.68 |

Remarks:

1. Emission Level(dBuV/m) = Raw Value(dBuV) + Correction Factor(dB/m)
2. Correction Factor(dB/m) = Antenna Factor(dB/m) + Cable Factor(dB) – Pre-Amplifier Factor(dB)
3. Margin value = Emission Level – Limit value
4. The other emission levels were very low against the limit.
5. " * ": Fundamental frequency, the limit was restricted at the RF Output Power.

| | | | |
|------------------------|-----------------------|--|--|
| RF Mode | TX BT-LE 1M with 125K | Channel | CH 19 : 2440 MHz |
| Frequency Range | 1 GHz ~ 25 GHz | Detector Function & Bandwidth | (PK) RB = 1 MHz, VB = 3 MHz (AV) RB = 1 MHz, VB = 3 MHz |
| Input Power | 120 Vac, 60 Hz | Environmental Conditions | 22°C, 68% RH |
| Tested By | Rex Wang | Test Date | 2022/7/8 |

Antenna Polarity & Test Distance : Horizontal at 3 m

| No | Frequency (MHz) | Emission Level (dBuV/m) | Limit (dBuV/m) | Margin (dB) | Antenna Height (m) | Table Angle (Degree) | Raw Value (dBuV) | Correction Factor (dB/m) |
|----|-----------------|-------------------------|----------------|-------------|--------------------|----------------------|------------------|--------------------------|
| 1 | *2440.00 | 107.31 PK | | | 1.77 H | 55 | 74.50 | 32.81 |
| 2 | *2440.00 | 105.51 AV | | | 1.77 H | 55 | 72.70 | 32.81 |
| 3 | 4880.00 | 48.41 PK | 74.00 | -25.59 | 3.53 H | 55 | 42.90 | 5.51 |
| 4 | 4880.00 | 38.81 AV | 54.00 | -15.19 | 3.53 H | 55 | 33.30 | 5.51 |

Antenna Polarity & Test Distance : Vertical at 3 m

| No | Frequency (MHz) | Emission Level (dBuV/m) | Limit (dBuV/m) | Margin (dB) | Antenna Height (m) | Table Angle (Degree) | Raw Value (dBuV) | Correction Factor (dB/m) |
|----|-----------------|-------------------------|----------------|-------------|--------------------|----------------------|------------------|--------------------------|
| 1 | *2440.00 | 104.66 PK | | | 3.76 V | 15 | 71.85 | 32.81 |
| 2 | *2440.00 | 102.97 AV | | | 3.76 V | 15 | 70.16 | 32.81 |
| 3 | 4880.00 | 46.81 PK | 74.00 | -27.19 | 2.41 V | 100 | 41.30 | 5.51 |
| 4 | 4880.00 | 36.31 AV | 54.00 | -17.69 | 2.41 V | 100 | 30.80 | 5.51 |

Remarks:

1. Emission Level(dBuV/m) = Raw Value(dBuV) + Correction Factor(dB/m)
2. Correction Factor(dB/m) = Antenna Factor(dB/m) + Cable Factor(dB) – Pre-Amplifier Factor(dB)
3. Margin value = Emission Level – Limit value
4. The other emission levels were very low against the limit.
5. " * ": Fundamental frequency, the limit was restricted at the RF Output Power.

| | | | |
|------------------------|-----------------------|--|--|
| RF Mode | TX BT-LE 1M with 125K | Channel | CH 38 : 2478 MHz |
| Frequency Range | 1 GHz ~ 25 GHz | Detector Function & Bandwidth | (PK) RB = 1 MHz, VB = 3 MHz (AV) RB = 1 MHz, VB = 3 MHz |
| Input Power | 120 Vac, 60 Hz | Environmental Conditions | 22°C, 68% RH |
| Tested By | Rex Wang | Test Date | 2022/7/8 |

Antenna Polarity & Test Distance : Horizontal at 3 m

| No | Frequency (MHz) | Emission Level (dBuV/m) | Limit (dBuV/m) | Margin (dB) | Antenna Height (m) | Table Angle (Degree) | Raw Value (dBuV) | Correction Factor (dB/m) |
|----|-----------------|-------------------------|----------------|-------------|--------------------|----------------------|------------------|--------------------------|
| 1 | *2478.00 | 107.16 PK | | | 1.68 H | 55 | 74.33 | 32.83 |
| 2 | *2478.00 | 105.76 AV | | | 1.68 H | 55 | 72.93 | 32.83 |
| 3 | 2483.50 | 60.04 PK | 74.00 | -13.96 | 1.68 H | 55 | 61.60 | -1.56 |
| 4 | 2483.50 | 49.78 AV | 54.00 | -4.22 | 1.68 H | 55 | 51.34 | -1.56 |
| 5 | 4956.00 | 48.21 PK | 74.00 | -25.79 | 3.51 H | 55 | 42.60 | 5.61 |
| 6 | 4956.00 | 38.11 AV | 54.00 | -15.89 | 3.51 H | 55 | 32.50 | 5.61 |

Antenna Polarity & Test Distance : Vertical at 3 m

| No | Frequency (MHz) | Emission Level (dBuV/m) | Limit (dBuV/m) | Margin (dB) | Antenna Height (m) | Table Angle (Degree) | Raw Value (dBuV) | Correction Factor (dB/m) |
|----|-----------------|-------------------------|----------------|-------------|--------------------|----------------------|------------------|--------------------------|
| 1 | *2478.00 | 104.47 PK | | | 3.80 V | 16 | 71.64 | 32.83 |
| 2 | *2478.00 | 102.87 AV | | | 3.80 V | 16 | 70.04 | 32.83 |
| 3 | 2483.50 | 59.94 PK | 74.00 | -14.06 | 3.80 V | 16 | 61.50 | -1.56 |
| 4 | 2483.50 | 49.64 AV | 54.00 | -4.36 | 3.80 V | 16 | 51.20 | -1.56 |
| 5 | 4956.00 | 46.81 PK | 74.00 | -27.19 | 2.45 V | 103 | 41.20 | 5.61 |
| 6 | 4956.00 | 36.51 AV | 54.00 | -17.49 | 2.45 V | 103 | 30.90 | 5.61 |

Remarks:

1. Emission Level(dBuV/m) = Raw Value(dBuV) + Correction Factor(dB/m)
2. Correction Factor(dB/m) = Antenna Factor(dB/m) + Cable Factor(dB) – Pre-Amplifier Factor(dB)
3. Margin value = Emission Level – Limit value
4. The other emission levels were very low against the limit.
5. " * ": Fundamental frequency, the limit was restricted at the RF Output Power.

| | | | |
|------------------------|-----------------------|--|--|
| RF Mode | TX BT-LE 1M with 125K | Channel | CH 39 : 2480 MHz |
| Frequency Range | 1 GHz ~ 25 GHz | Detector Function & Bandwidth | (PK) RB = 1 MHz, VB = 3 MHz (AV) RB = 1 MHz, VB = 3 MHz |
| Input Power | 120 Vac, 60 Hz | Environmental Conditions | 22°C, 68% RH |
| Tested By | Rex Wang | Test Date | 2022/7/8 |

Antenna Polarity & Test Distance : Horizontal at 3 m

| No | Frequency (MHz) | Emission Level (dBuV/m) | Limit (dBuV/m) | Margin (dB) | Antenna Height (m) | Table Angle (Degree) | Raw Value (dBuV) | Correction Factor (dB/m) |
|----|-----------------|-------------------------|----------------|-------------|--------------------|----------------------|------------------|--------------------------|
| 1 | *2480.00 | 107.83 PK | | | 3.90 H | 145 | 75.00 | 32.83 |
| 2 | *2480.00 | 106.16 AV | | | 3.90 H | 145 | 73.33 | 32.83 |
| 3 | 2483.50 | 61.04 PK | 74.00 | -12.96 | 3.90 H | 145 | 62.60 | -1.56 |
| 4 | 2483.50 | 49.82 AV | 54.00 | -4.18 | 3.90 H | 145 | 51.38 | -1.56 |
| 5 | 4960.00 | 48.24 PK | 74.00 | -25.76 | 3.44 H | 55 | 42.60 | 5.64 |
| 6 | 4960.00 | 38.75 AV | 54.00 | -15.25 | 3.44 H | 55 | 33.11 | 5.64 |

Antenna Polarity & Test Distance : Vertical at 3 m

| No | Frequency (MHz) | Emission Level (dBuV/m) | Limit (dBuV/m) | Margin (dB) | Antenna Height (m) | Table Angle (Degree) | Raw Value (dBuV) | Correction Factor (dB/m) |
|----|-----------------|-------------------------|----------------|-------------|--------------------|----------------------|------------------|--------------------------|
| 1 | *2480.00 | 105.58 PK | | | 3.83 V | 354 | 72.75 | 32.83 |
| 2 | *2480.00 | 103.52 AV | | | 3.83 V | 354 | 70.69 | 32.83 |
| 3 | 2483.50 | 60.64 PK | 74.00 | -13.36 | 3.83 V | 354 | 62.20 | -1.56 |
| 4 | 2483.50 | 49.18 AV | 54.00 | -4.82 | 3.83 V | 354 | 50.74 | -1.56 |
| 5 | 4960.00 | 47.44 PK | 74.00 | -26.56 | 2.66 V | 108 | 41.80 | 5.64 |
| 6 | 4960.00 | 37.24 AV | 54.00 | -16.76 | 2.66 V | 108 | 31.60 | 5.64 |

Remarks:

1. Emission Level(dBuV/m) = Raw Value(dBuV) + Correction Factor(dB/m)
2. Correction Factor(dB/m) = Antenna Factor(dB/m) + Cable Factor(dB) – Pre-Amplifier Factor(dB)
3. Margin value = Emission Level – Limit value
4. The other emission levels were very low against the limit.
5. " * " : Fundamental frequency, the limit was restricted at the RF Output Power.

| | | | |
|------------------------|----------------|--|--|
| RF Mode | TX BT-LE 2M | Channel | CH 1 : 2404 MHz |
| Frequency Range | 1 GHz ~ 25 GHz | Detector Function & Bandwidth | (PK) RB = 1 MHz, VB = 3 MHz (AV) RB = 1 MHz, VB = 3 MHz |
| Input Power | 120 Vac, 60 Hz | Environmental Conditions | 22°C, 68% RH |
| Tested By | Rex Wang | Test Date | 2022/7/8 |

Antenna Polarity & Test Distance : Horizontal at 3 m

| No | Frequency (MHz) | Emission Level (dBuV/m) | Limit (dBuV/m) | Margin (dB) | Antenna Height (m) | Table Angle (Degree) | Raw Value (dBuV) | Correction Factor (dB/m) |
|----|-----------------|-------------------------|----------------|-------------|--------------------|----------------------|------------------|--------------------------|
| 1 | 2390.00 | 60.25 PK | 74.00 | -13.75 | 1.82 H | 55 | 61.70 | -1.45 |
| 2 | 2390.00 | 51.05 AV | 54.00 | -2.95 | 1.82 H | 55 | 52.50 | -1.45 |
| 3 | *2404.00 | 113.54 PK | | | 1.82 H | 55 | 80.70 | 32.84 |
| 4 | *2404.00 | 110.44 AV | | | 1.82 H | 55 | 77.60 | 32.84 |
| 5 | 4808.00 | 49.88 PK | 74.00 | -24.12 | 3.48 H | 52 | 44.20 | 5.68 |
| 6 | 4808.00 | 40.62 AV | 54.00 | -13.38 | 3.48 H | 52 | 34.94 | 5.68 |

Antenna Polarity & Test Distance : Vertical at 3 m

| No | Frequency (MHz) | Emission Level (dBuV/m) | Limit (dBuV/m) | Margin (dB) | Antenna Height (m) | Table Angle (Degree) | Raw Value (dBuV) | Correction Factor (dB/m) |
|----|-----------------|-------------------------|----------------|-------------|--------------------|----------------------|------------------|--------------------------|
| 1 | 2390.00 | 60.05 PK | 74.00 | -13.95 | 3.76 V | 1 | 61.50 | -1.45 |
| 2 | 2390.00 | 50.75 AV | 54.00 | -3.25 | 3.76 V | 1 | 52.20 | -1.45 |
| 3 | *2404.00 | 112.94 PK | | | 3.76 V | 1 | 80.10 | 32.84 |
| 4 | *2404.00 | 110.04 AV | | | 3.76 V | 1 | 77.20 | 32.84 |
| 5 | 4808.00 | 49.08 PK | 74.00 | -24.92 | 2.45 V | 104 | 43.40 | 5.68 |
| 6 | 4808.00 | 39.18 AV | 54.00 | -14.82 | 2.45 V | 104 | 33.50 | 5.68 |

Remarks:

1. Emission Level(dBuV/m) = Raw Value(dBuV) + Correction Factor(dB/m)
2. Correction Factor(dB/m) = Antenna Factor(dB/m) + Cable Factor(dB) – Pre-Amplifier Factor(dB)
3. Margin value = Emission Level – Limit value
4. The other emission levels were very low against the limit.
5. " * ": Fundamental frequency, the limit was restricted at the RF Output Power.

| | | | |
|------------------------|----------------|--|--|
| RF Mode | TX BT-LE 2M | Channel | CH 19 : 2440 MHz |
| Frequency Range | 1 GHz ~ 25 GHz | Detector Function & Bandwidth | (PK) RB = 1 MHz, VB = 3 MHz (AV) RB = 1 MHz, VB = 3 MHz |
| Input Power | 120 Vac, 60 Hz | Environmental Conditions | 22°C, 68% RH |
| Tested By | Rex Wang | Test Date | 2022/7/8 |

Antenna Polarity & Test Distance : Horizontal at 3 m

| No | Frequency (MHz) | Emission Level (dBuV/m) | Limit (dBuV/m) | Margin (dB) | Antenna Height (m) | Table Angle (Degree) | Raw Value (dBuV) | Correction Factor (dB/m) |
|----|-----------------|-------------------------|----------------|-------------|--------------------|----------------------|------------------|--------------------------|
| 1 | *2440.00 | 113.61 PK | | | 1.84 H | 57 | 80.80 | 32.81 |
| 2 | *2440.00 | 110.61 AV | | | 1.84 H | 57 | 77.80 | 32.81 |
| 3 | 4880.00 | 50.01 PK | 74.00 | -23.99 | 3.52 H | 53 | 44.50 | 5.51 |
| 4 | 4880.00 | 40.21 AV | 54.00 | -13.79 | 3.52 H | 53 | 34.70 | 5.51 |

Antenna Polarity & Test Distance : Vertical at 3 m

| No | Frequency (MHz) | Emission Level (dBuV/m) | Limit (dBuV/m) | Margin (dB) | Antenna Height (m) | Table Angle (Degree) | Raw Value (dBuV) | Correction Factor (dB/m) |
|----|-----------------|-------------------------|----------------|-------------|--------------------|----------------------|------------------|--------------------------|
| 1 | *2440.00 | 111.71 PK | | | 3.77 V | 4 | 78.90 | 32.81 |
| 2 | *2440.00 | 110.11 AV | | | 3.77 V | 4 | 77.30 | 32.81 |
| 3 | 4880.00 | 48.81 PK | 74.00 | -25.19 | 2.48 V | 106 | 43.30 | 5.51 |
| 4 | 4880.00 | 38.81 AV | 54.00 | -15.19 | 2.48 V | 106 | 33.30 | 5.51 |

Remarks:

1. Emission Level(dBuV/m) = Raw Value(dBuV) + Correction Factor(dB/m)
2. Correction Factor(dB/m) = Antenna Factor(dB/m) + Cable Factor(dB) – Pre-Amplifier Factor(dB)
3. Margin value = Emission Level – Limit value
4. The other emission levels were very low against the limit.
5. " * ": Fundamental frequency, the limit was restricted at the RF Output Power.

| | | | |
|------------------------|----------------|--|--|
| RF Mode | TX BT-LE 2M | Channel | CH 38 : 2478 MHz |
| Frequency Range | 1 GHz ~ 25 GHz | Detector Function & Bandwidth | (PK) RB = 1 MHz, VB = 3 MHz (AV) RB = 1 MHz, VB = 3 MHz |
| Input Power | 120 Vac, 60 Hz | Environmental Conditions | 22°C, 68% RH |
| Tested By | Rex Wang | Test Date | 2022/7/1 |

Antenna Polarity & Test Distance : Horizontal at 3 m

| No | Frequency (MHz) | Emission Level (dBuV/m) | Limit (dBuV/m) | Margin (dB) | Antenna Height (m) | Table Angle (Degree) | Raw Value (dBuV) | Correction Factor (dB/m) |
|----|-----------------|-------------------------|----------------|-------------|--------------------|----------------------|------------------|--------------------------|
| 1 | *2478.00 | 115.53 PK | | | 1.24 H | 269 | 82.70 | 32.83 |
| 2 | *2478.00 | 112.48 AV | | | 1.24 H | 269 | 79.65 | 32.83 |
| 3 | 2483.50 | 68.34 PK | 74.00 | -5.66 | 1.24 H | 269 | 69.90 | -1.56 |
| 4 | 2483.50 | 52.08 AV | 54.00 | -1.92 | 1.24 H | 269 | 53.64 | -1.56 |
| 5 | 4956.00 | 49.91 PK | 74.00 | -24.09 | 3.55 H | 67 | 44.30 | 5.61 |
| 6 | 4956.00 | 40.81 AV | 54.00 | -13.19 | 3.55 H | 67 | 35.20 | 5.61 |

Antenna Polarity & Test Distance : Vertical at 3 m

| No | Frequency (MHz) | Emission Level (dBuV/m) | Limit (dBuV/m) | Margin (dB) | Antenna Height (m) | Table Angle (Degree) | Raw Value (dBuV) | Correction Factor (dB/m) |
|----|-----------------|-------------------------|----------------|-------------|--------------------|----------------------|------------------|--------------------------|
| 1 | *2478.00 | 113.63 PK | | | 3.88 V | 354 | 80.80 | 32.83 |
| 2 | *2478.00 | 111.58 AV | | | 3.88 V | 354 | 78.75 | 32.83 |
| 3 | 2483.50 | 65.64 PK | 74.00 | -8.36 | 3.88 V | 354 | 67.20 | -1.56 |
| 4 | 2483.50 | 50.04 AV | 54.00 | -3.96 | 3.88 V | 354 | 51.60 | -1.56 |
| 5 | 4956.00 | 49.41 PK | 74.00 | -24.59 | 2.52 V | 106 | 43.80 | 5.61 |
| 6 | 4956.00 | 39.51 AV | 54.00 | -14.49 | 2.52 V | 106 | 33.90 | 5.61 |

Remarks:

1. Emission Level(dBuV/m) = Raw Value(dBuV) + Correction Factor(dB/m)
2. Correction Factor(dB/m) = Antenna Factor(dB/m) + Cable Factor(dB) – Pre-Amplifier Factor(dB)
3. Margin value = Emission Level – Limit value
4. The other emission levels were very low against the limit.
5. " * ": Fundamental frequency, the limit was restricted at the RF Output Power.

9 kHz ~ 1 GHz Worst-Case Data:

| | | | |
|------------------------|----------------|--|------------------|
| RF Mode | TX BT-LE 1M | Channel | CH 0 : 2402 MHz |
| Frequency Range | 30 MHz ~ 1 GHz | Detector Function & Bandwidth | (QP) RB = 120kHz |
| Input Power | 120 Vac, 60 Hz | Environmental Conditions | 23°C, 68% RH |
| Tested By | Adair Peng | Test Date | 2022/5/23 |

Antenna Polarity & Test Distance : Horizontal at 3 m

| No | Frequency (MHz) | Emission Level (dBuV/m) | Limit (dBuV/m) | Margin (dB) | Antenna Height (m) | Table Angle (Degree) | Raw Value (dBuV) | Correction Factor (dB/m) |
|----|-----------------|-------------------------|----------------|-------------|--------------------|----------------------|------------------|--------------------------|
| 1 | 79.47 | 31.32 QP | 40.00 | -8.68 | 1.00 H | 186 | 44.69 | -13.37 |
| 2 | 201.69 | 33.54 QP | 43.50 | -9.96 | 1.50 H | 133 | 45.09 | -11.55 |
| 3 | 218.18 | 29.76 QP | 46.00 | -16.24 | 1.50 H | 34 | 40.87 | -11.11 |
| 4 | 336.52 | 31.95 QP | 46.00 | -14.05 | 1.00 H | 275 | 38.00 | -6.05 |
| 5 | 451.95 | 27.87 QP | 46.00 | -18.13 | 1.00 H | 5 | 31.30 | -3.43 |
| 6 | 549.92 | 29.45 QP | 46.00 | -16.55 | 2.00 H | 246 | 31.13 | -1.68 |

Remarks:

1. Emission Level(dBuV/m) = Raw Value(dBuV) + Correction Factor(dB/m)
2. Correction Factor(dB/m) = Antenna Factor(dB/m) + Cable Factor(dB) – Pre-Amplifier Factor(dB)
3. Margin value = Emission Level – Limit value
4. The other emission levels were very low against the limit of frequency range 30 MHz ~ 1 GHz.
5. The emission levels were very low against the limit of frequency range 9 kHz ~ 30 MHz: the amplitude of spurious emissions attenuated more than 20 dB below the permissible value to be report.

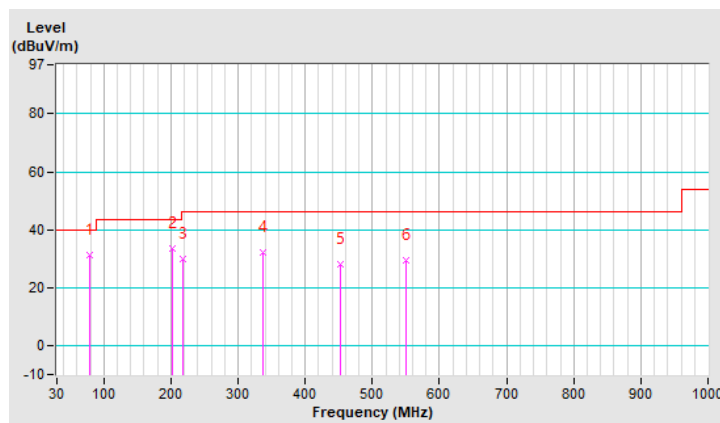

| | | | |
|------------------------|----------------|--|------------------|
| RF Mode | TX BT-LE 1M | Channel | CH 0 : 2402 MHz |
| Frequency Range | 30 MHz ~ 1 GHz | Detector Function & Bandwidth | (QP) RB = 120kHz |
| Input Power | 120 Vac, 60 Hz | Environmental Conditions | 23°C, 68% RH |
| Tested By | Adair Peng | Test Date | 2022/5/23 |

| Antenna Polarity & Test Distance : Vertical at 3 m | | | | | | | | |
|--|-----------------|-------------------------|----------------|-------------|--------------------|----------------------|------------------|--------------------------|
| No | Frequency (MHz) | Emission Level (dBuV/m) | Limit (dBuV/m) | Margin (dB) | Antenna Height (m) | Table Angle (Degree) | Raw Value (dBuV) | Correction Factor (dB/m) |
| 1 | 38.73 | 31.94 QP | 40.00 | -8.06 | 1.50 V | 16 | 41.84 | -9.90 |
| 2 | 51.34 | 37.95 QP | 40.00 | -2.05 | 1.00 V | 175 | 46.95 | -9.00 |
| 3 | 133.79 | 31.38 QP | 43.50 | -12.12 | 1.50 V | 18 | 41.18 | -9.80 |
| 4 | 152.22 | 32.02 QP | 43.50 | -11.48 | 1.00 V | 6 | 40.83 | -8.81 |
| 5 | 439.34 | 28.57 QP | 46.00 | -17.43 | 1.00 V | 78 | 32.25 | -3.68 |
| 6 | 550.89 | 30.65 QP | 46.00 | -15.35 | 1.00 V | 269 | 32.30 | -1.65 |

Remarks:

1. Emission Level(dBuV/m) = Raw Value(dBuV) + Correction Factor(dB/m)
2. Correction Factor(dB/m) = Antenna Factor(dB/m) + Cable Factor(dB) – Pre-Amplifier Factor(dB)
3. Margin value = Emission Level – Limit value
4. The other emission levels were very low against the limit of frequency range 30 MHz ~ 1 GHz.
5. The emission levels were very low against the limit of frequency range 9 kHz ~ 30 MHz: the amplitude of spurious emissions attenuated more than 20 dB below the permissible value to be report.

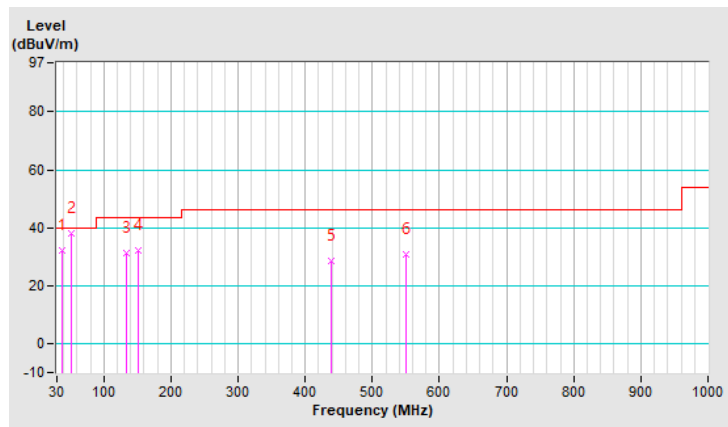

| | | | |
|------------------------|-----------------------|--|------------------|
| RF Mode | TX BT-LE 1M with 125K | Channel | CH 1 : 2404 MHz |
| Frequency Range | 30 MHz ~ 1 GHz | Detector Function & Bandwidth | (QP) RB = 120kHz |
| Input Power | 120 Vac, 60 Hz | Environmental Conditions | 23°C, 68% RH |
| Tested By | Adair Peng | Test Date | 2022/5/23 |

| Antenna Polarity & Test Distance : Horizontal at 3 m | | | | | | | | |
|--|-----------------|-------------------------|----------------|-------------|--------------------|----------------------|------------------|--------------------------|
| No | Frequency (MHz) | Emission Level (dBuV/m) | Limit (dBuV/m) | Margin (dB) | Antenna Height (m) | Table Angle (Degree) | Raw Value (dBuV) | Correction Factor (dB/m) |
| 1 | 62.01 | 31.25 QP | 40.00 | -8.75 | 1.50 H | 110 | 41.08 | -9.83 |
| 2 | 78.50 | 31.36 QP | 40.00 | -8.64 | 1.00 H | 179 | 44.52 | -13.16 |
| 3 | 152.22 | 29.42 QP | 43.50 | -14.08 | 1.00 H | 6 | 38.23 | -8.81 |
| 4 | 203.63 | 27.47 QP | 43.50 | -16.03 | 2.00 H | 260 | 39.01 | -11.54 |
| 5 | 327.79 | 30.75 QP | 46.00 | -15.25 | 1.50 H | 60 | 36.87 | -6.12 |
| 6 | 431.58 | 31.51 QP | 46.00 | -14.49 | 1.00 H | 31 | 35.38 | -3.87 |

Remarks:

1. Emission Level(dBuV/m) = Raw Value(dBuV) + Correction Factor(dB/m)
2. Correction Factor(dB/m) = Antenna Factor(dB/m) + Cable Factor(dB) – Pre-Amplifier Factor(dB)
3. Margin value = Emission Level – Limit value
4. The other emission levels were very low against the limit of frequency range 30 MHz ~ 1 GHz.
5. The emission levels were very low against the limit of frequency range 9 kHz ~ 30 MHz: the amplitude of spurious emissions attenuated more than 20 dB below the permissible value to be report.

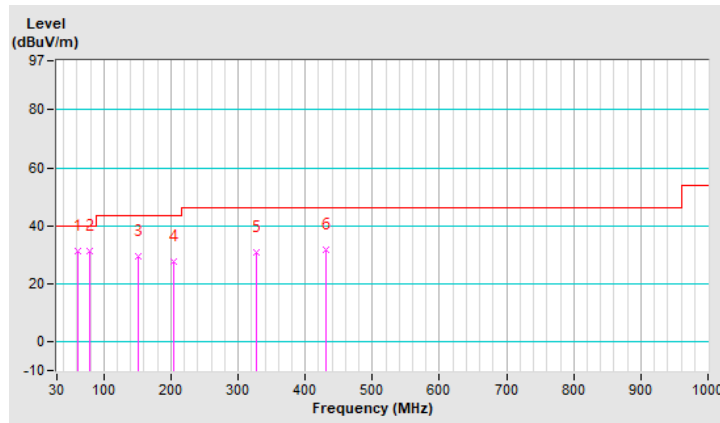

| | | | |
|------------------------|-----------------------|--|------------------|
| RF Mode | TX BT-LE 1M with 125K | Channel | CH 1 : 2404 MHz |
| Frequency Range | 30 MHz ~ 1 GHz | Detector Function & Bandwidth | (QP) RB = 120kHz |
| Input Power | 120 Vac, 60 Hz | Environmental Conditions | 23°C, 68% RH |
| Tested By | Adair Peng | Test Date | 2022/5/23 |

| Antenna Polarity & Test Distance : Vertical at 3 m | | | | | | | | |
|--|-----------------|-------------------------|----------------|-------------|--------------------|----------------------|------------------|--------------------------|
| No | Frequency (MHz) | Emission Level (dBuV/m) | Limit (dBuV/m) | Margin (dB) | Antenna Height (m) | Table Angle (Degree) | Raw Value (dBuV) | Correction Factor (dB/m) |
| 1 | 30.00 | 32.90 QP | 40.00 | -7.10 | 1.50 V | 211 | 43.07 | -10.17 |
| 2 | 64.92 | 36.07 QP | 40.00 | -3.93 | 1.50 V | 88 | 46.46 | -10.39 |
| 3 | 152.22 | 32.29 QP | 43.50 | -11.21 | 1.00 V | 34 | 41.10 | -8.81 |
| 4 | 424.79 | 33.18 QP | 46.00 | -12.82 | 1.00 V | 294 | 37.30 | -4.12 |
| 5 | 540.22 | 32.09 QP | 46.00 | -13.91 | 2.00 V | 267 | 33.89 | -1.80 |
| 6 | 591.63 | 31.20 QP | 46.00 | -14.80 | 1.00 V | 265 | 31.73 | -0.53 |

Remarks:

1. Emission Level(dBuV/m) = Raw Value(dBuV) + Correction Factor(dB/m)
2. Correction Factor(dB/m) = Antenna Factor(dB/m) + Cable Factor(dB) – Pre-Amplifier Factor(dB)
3. Margin value = Emission Level – Limit value
4. The other emission levels were very low against the limit of frequency range 30 MHz ~ 1 GHz.
5. The emission levels were very low against the limit of frequency range 9 kHz ~ 30 MHz: the amplitude of spurious emissions attenuated more than 20 dB below the permissible value to be report.

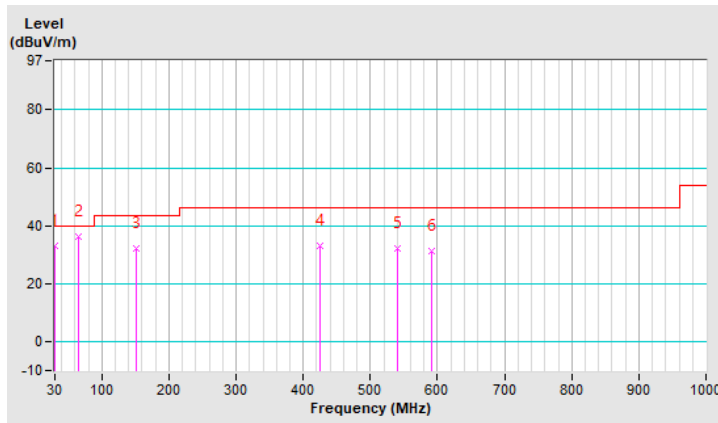

| | | | |
|------------------------|----------------|--|------------------|
| RF Mode | TX BT-LE 2M | Channel | CH 1 : 2404 MHz |
| Frequency Range | 30 MHz ~ 1 GHz | Detector Function & Bandwidth | (QP) RB = 120kHz |
| Input Power | 120 Vac, 60 Hz | Environmental Conditions | 23°C, 68% RH |
| Tested By | Adair Peng | Test Date | 2022/5/23 |

| Antenna Polarity & Test Distance : Horizontal at 3 m | | | | | | | | |
|--|-----------------|-------------------------|----------------|-------------|--------------------|----------------------|------------------|--------------------------|
| No | Frequency (MHz) | Emission Level (dBuV/m) | Limit (dBuV/m) | Margin (dB) | Antenna Height (m) | Table Angle (Degree) | Raw Value (dBuV) | Correction Factor (dB/m) |
| 1 | 78.50 | 30.74 QP | 40.00 | -9.26 | 1.50 H | 357 | 43.90 | -13.16 |
| 2 | 152.22 | 29.35 QP | 43.50 | -14.15 | 1.50 H | 34 | 38.16 | -8.81 |
| 3 | 222.06 | 27.47 QP | 46.00 | -18.53 | 1.00 H | 84 | 38.65 | -11.18 |
| 4 | 359.80 | 31.03 QP | 46.00 | -14.97 | 1.00 H | 268 | 36.88 | -5.85 |
| 5 | 445.16 | 29.09 QP | 46.00 | -16.91 | 1.00 H | 180 | 32.73 | -3.64 |
| 6 | 624.61 | 31.26 QP | 46.00 | -14.74 | 2.00 H | 72 | 31.21 | 0.05 |

Remarks:

1. Emission Level(dBuV/m) = Raw Value(dBuV) + Correction Factor(dB/m)
2. Correction Factor(dB/m) = Antenna Factor(dB/m) + Cable Factor(dB) – Pre-Amplifier Factor(dB)
3. Margin value = Emission Level – Limit value
4. The other emission levels were very low against the limit of frequency range 30 MHz ~ 1 GHz.
5. The emission levels were very low against the limit of frequency range 9 kHz ~ 30 MHz: the amplitude of spurious emissions attenuated more than 20 dB below the permissible value to be report.

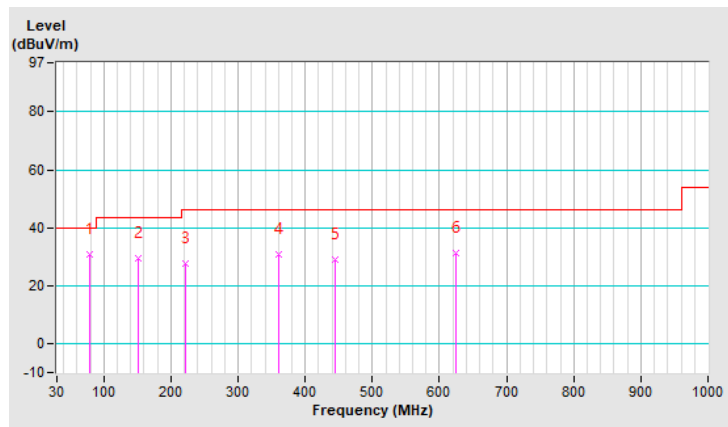

| | | | |
|------------------------|----------------|--|------------------|
| RF Mode | TX BT-LE 2M | Channel | CH 1 : 2404 MHz |
| Frequency Range | 30 MHz ~ 1 GHz | Detector Function & Bandwidth | (QP) RB = 120kHz |
| Input Power | 120 Vac, 60 Hz | Environmental Conditions | 23°C, 68% RH |
| Tested By | Adair Peng | Test Date | 2022/5/23 |

| Antenna Polarity & Test Distance : Vertical at 3 m | | | | | | | | |
|--|-----------------|-------------------------|----------------|-------------|--------------------|----------------------|------------------|--------------------------|
| No | Frequency (MHz) | Emission Level (dBuV/m) | Limit (dBuV/m) | Margin (dB) | Antenna Height (m) | Table Angle (Degree) | Raw Value (dBuV) | Correction Factor (dB/m) |
| 1 | 37.76 | 35.13 QP | 40.00 | -4.87 | 1.00 V | 212 | 44.81 | -9.68 |
| 2 | 48.43 | 35.68 QP | 40.00 | -4.32 | 1.00 V | 147 | 44.66 | -8.98 |
| 3 | 152.22 | 32.33 QP | 43.50 | -11.17 | 2.00 V | 89 | 41.14 | -8.81 |
| 4 | 350.10 | 23.40 QP | 46.00 | -22.60 | 1.00 V | 165 | 29.49 | -6.09 |
| 5 | 417.03 | 29.29 QP | 46.00 | -16.71 | 1.50 V | 165 | 33.81 | -4.52 |
| 6 | 585.81 | 32.21 QP | 46.00 | -13.79 | 1.50 V | 284 | 32.88 | -0.67 |

Remarks:

1. Emission Level(dBuV/m) = Raw Value(dBuV) + Correction Factor(dB/m)
2. Correction Factor(dB/m) = Antenna Factor(dB/m) + Cable Factor(dB) – Pre-Amplifier Factor(dB)
3. Margin value = Emission Level – Limit value
4. The other emission levels were very low against the limit of frequency range 30 MHz ~ 1 GHz.
5. The emission levels were very low against the limit of frequency range 9 kHz ~ 30 MHz: the amplitude of spurious emissions attenuated more than 20 dB below the permissible value to be report.

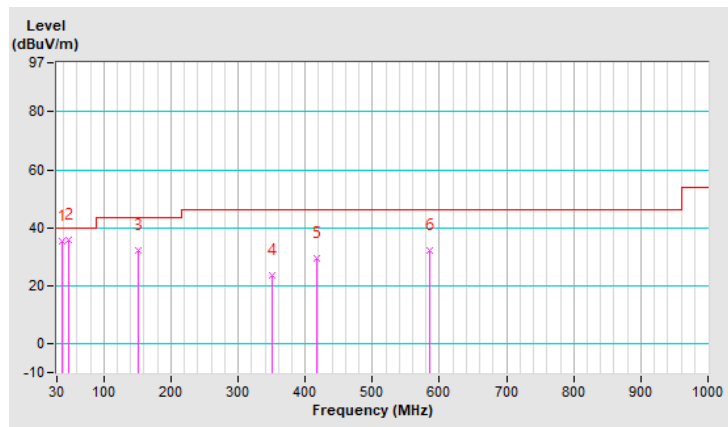

4.2 Conducted Emission Measurement

4.2.1 Limits of Conducted Emission Measurement

| Frequency (MHz) | Conducted Limit (dBuV) | |
|-----------------|------------------------|---------|
| | Quasi-Peak | Average |
| 0.15 - 0.5 | 66 - 56 | 56 - 46 |
| 0.50 - 5.0 | 56 | 46 |
| 5.0 - 30.0 | 60 | 50 |

- Note: 1. The lower limit shall apply at the transition frequencies.
 2. The limit decreases in line with the logarithm of the frequency in the range of 0.15 to 0.50 MHz.

4.2.2 Test Instruments

| Description & Manufacturer | Model No. | Serial No. | Date of Calibration | Due Date of Calibration |
|---|--------------------------|----------------|---------------------|-------------------------|
| Test Receiver ROHDE & SCHWARZ | ESR3 | 102412 | Jan. 22, 2022 | Jan. 21, 2023 |
| RF Coaxial Cable WORKEN | 5D-FB | Cable-cond2-01 | Sep. 4, 2021 | Sep. 3, 2022 |
| LISN/AMN ROHDE & SCHWARZ (EUT) | ESH2-Z5 | 100100 | Feb. 17, 2022 | Feb. 16, 2023 |
| LISN/AMN ROHDE & SCHWARZ (Peripheral) | ESH3-Z5 | 100312 | Sep. 17, 2021 | Sep. 16, 2022 |
| Software ADT | BV ADT_Cond_ V7.3.7.4 | NA | NA | NA |

- Note: 1. The calibration interval of the above test instruments is 12 months and the calibrations are traceable to NML/ROC and NIST/USA.
 2. The test was performed in HwaYa Shielded Room 2.
 3. The VCCI Site Registration No. is C-12047.

4.2.3 Test Procedures

- The EUT was placed 0.4 meters from the conducting wall of the shielded room with EUT being connected to the power mains through a line impedance stabilization network (LISN). Other support units were connected to the power mains through another LISN. The two LISNs provide 50 ohm/50 uH of coupling impedance for the measuring instrument.
- Both lines of the power mains connected to the EUT were checked for maximum conducted interference.
- The frequency range from 150 kHz to 30 MHz was searched. Emission levels under (Limit – 20 dB) was not recorded.

Note: The resolution bandwidth and video bandwidth of test receiver is 9 kHz for quasi-peak detection (QP) and average detection (AV) at frequency 0.15 MHz - 30 MHz.

4.2.4 Deviation from Test Standard

No deviation.

4.2.5 Test Setup

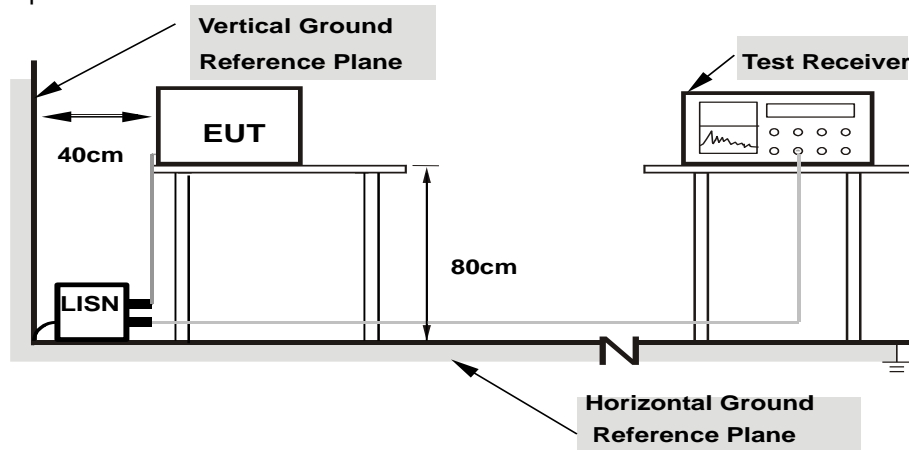

- Note:**
1. Support units were connected to second LISN.
 2. Both of LISNs (AMN) are 80 cm from EUT and at least 80 from other units and other metal planes

4.2.6 EUT Operating Conditions

- a. Placed the EUT on the testing table.
- b. Set the EUT under transmission condition continuously at specific channel frequency.

4.2.7 Test Results

CONDUCTED WORST-CASE DATA

Mode A

| | | | |
|------------------------|------------------|---|--------------------------------------|
| Frequency Range | 150 kHz ~ 30 MHz | Detector Function & Resolution Bandwidth | Quasi-Peak (QP) / Average (AV), 9kHz |
| Input Power | 120 Vac, 60 Hz | Environmental Conditions | 25°C, 75% RH |
| Tested by | Rex Wang | Test Date | 2022/5/25 |

| Phase Of Power : Line (L) | | | | | | | | | | |
|---------------------------|-----------------|------------------------|----------------------|-------|-----------------------|-------|--------------|-------|-------------|--------|
| No | Frequency (MHz) | Correction Factor (dB) | Reading Value (dBuV) | | Emission Level (dBuV) | | Limit (dBuV) | | Margin (dB) | |
| | | | Q.P. | AV. | Q.P. | AV. | Q.P. | AV. | Q.P. | AV. |
| 1 | 0.18519 | 10.14 | 40.21 | 26.98 | 50.35 | 37.12 | 64.25 | 54.25 | -13.90 | -17.13 |
| 2 | 0.20083 | 10.14 | 38.31 | 22.40 | 48.45 | 32.54 | 63.58 | 53.58 | -15.13 | -21.04 |
| 3 | 0.24775 | 10.14 | 33.54 | 19.48 | 43.68 | 29.62 | 61.83 | 51.83 | -18.15 | -22.21 |
| 4 | 1.90559 | 10.22 | 28.28 | 16.95 | 38.50 | 27.17 | 56.00 | 46.00 | -17.50 | -18.83 |
| 5 | 5.92116 | 10.26 | 20.68 | 13.37 | 30.94 | 23.63 | 60.00 | 50.00 | -29.06 | -26.37 |
| 6 | 24.02446 | 10.26 | 23.39 | 14.24 | 33.65 | 24.50 | 60.00 | 50.00 | -26.35 | -25.50 |

Remarks:

1. Q.P. and AV. are abbreviations of quasi-peak and average individually.
2. The emission levels of other frequencies were very low against the limit.
3. Margin value = Emission level – Limit value
4. Correction factor = Insertion loss + Cable loss
5. Emission Level = Correction Factor + Reading Value

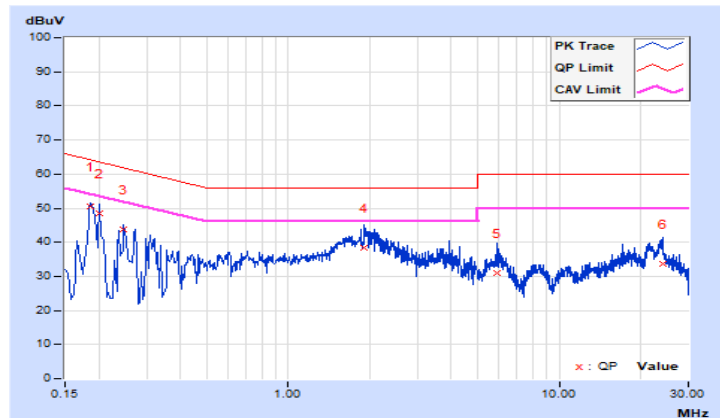

| | | | |
|------------------------|------------------|---|--------------------------------------|
| Frequency Range | 150 kHz ~ 30 MHz | Detector Function & Resolution Bandwidth | Quasi-Peak (QP) / Average (AV), 9kHz |
| Input Power | 120 Vac, 60 Hz | Environmental Conditions | 25°C, 75% RH |
| Tested by | Rex Wang | Test Date | 2022/5/25 |

| Phase Of Power : Neutral (N) | | | | | | | | | | |
|------------------------------|-----------------|------------------------|----------------------|--------------|-----------------------|--------------|--------------|--------------|---------------|---------------|
| No | Frequency (MHz) | Correction Factor (dB) | Reading Value (dBuV) | | Emission Level (dBuV) | | Limit (dBuV) | | Margin (dB) | |
| | | | Q.P. | AV. | Q.P. | AV. | Q.P. | AV. | Q.P. | AV. |
| 1 | 0.15391 | 10.14 | 31.85 | 10.86 | 41.99 | 21.00 | 65.79 | 55.79 | -23.80 | -34.79 |
| 2 | 0.18903 | 10.15 | 41.88 | 26.53 | 52.03 | 36.68 | 64.08 | 54.08 | -12.05 | -17.40 |
| 3 | 0.23993 | 10.15 | 34.93 | 16.66 | 45.08 | 26.81 | 62.10 | 52.10 | -17.02 | -25.29 |
| 4 | 0.26339 | 10.16 | 33.34 | 18.29 | 43.50 | 28.45 | 61.32 | 51.32 | -17.82 | -22.87 |
| 5 | 1.85867 | 10.23 | 24.96 | 14.84 | 35.19 | 25.07 | 56.00 | 46.00 | -20.81 | -20.93 |
| 6 | 21.36566 | 10.50 | 23.53 | 13.35 | 34.03 | 23.85 | 60.00 | 50.00 | -25.97 | -26.15 |

Remarks:

1. Q.P. and AV. are abbreviations of quasi-peak and average individually.
2. The emission levels of other frequencies were very low against the limit.
3. Margin value = Emission level – Limit value
4. Correction factor = Insertion loss + Cable loss
5. Emission Level = Correction Factor + Reading Value

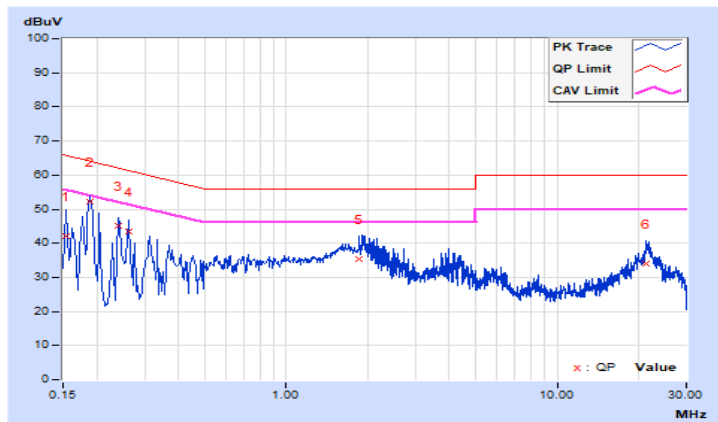

Mode B

| | | | |
|------------------------|------------------|---|--------------------------------------|
| Frequency Range | 150 kHz ~ 30 MHz | Detector Function & Resolution Bandwidth | Quasi-Peak (QP) / Average (AV), 9kHz |
| Input Power | 120 Vac, 60 Hz | Environmental Conditions | 25°C, 75% RH |
| Tested by | Rex Wang | Test Date | 2022/5/25 |

| Phase Of Power : Line (L) | | | | | | | | | | |
|---------------------------|-----------------|------------------------|----------------------|-------|-----------------------|-------|--------------|-------|-------------|--------|
| No | Frequency (MHz) | Correction Factor (dB) | Reading Value (dBuV) | | Emission Level (dBuV) | | Limit (dBuV) | | Margin (dB) | |
| | | | Q.P. | AV. | Q.P. | AV. | Q.P. | AV. | Q.P. | AV. |
| 1 | 0.15391 | 10.13 | 29.52 | 9.82 | 39.65 | 19.95 | 65.79 | 55.79 | -26.14 | -35.84 |
| 2 | 0.18910 | 10.14 | 38.90 | 26.34 | 49.04 | 36.48 | 64.08 | 54.08 | -15.04 | -17.60 |
| 3 | 0.25948 | 10.15 | 31.58 | 17.61 | 41.73 | 27.76 | 61.45 | 51.45 | -19.72 | -23.69 |
| 4 | 1.96033 | 10.22 | 28.60 | 17.24 | 38.82 | 27.46 | 56.00 | 46.00 | -17.18 | -18.54 |
| 5 | 5.91334 | 10.26 | 20.51 | 13.19 | 30.77 | 23.45 | 60.00 | 50.00 | -29.23 | -26.55 |
| 6 | 23.26592 | 10.29 | 23.70 | 14.21 | 33.99 | 24.50 | 60.00 | 50.00 | -26.01 | -25.50 |

Remarks:

1. Q.P. and AV. are abbreviations of quasi-peak and average individually.
2. The emission levels of other frequencies were very low against the limit.
3. Margin value = Emission level – Limit value
4. Correction factor = Insertion loss + Cable loss
5. Emission Level = Correction Factor + Reading Value

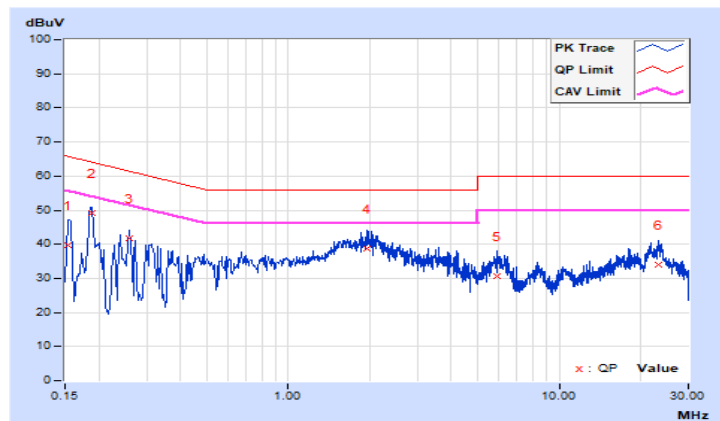

| | | | |
|------------------------|------------------|---|--------------------------------------|
| Frequency Range | 150 kHz ~ 30 MHz | Detector Function & Resolution Bandwidth | Quasi-Peak (QP) / Average (AV), 9kHz |
| Input Power | 120 Vac, 60 Hz | Environmental Conditions | 25°C, 75% RH |
| Tested by | Rex Wang | Test Date | 2022/5/25 |

| Phase Of Power : Neutral (N) | | | | | | | | | | |
|------------------------------|-----------------|------------------------|----------------------|-------|-----------------------|-------|--------------|-------|-------------|--------|
| No | Frequency (MHz) | Correction Factor (dB) | Reading Value (dBuV) | | Emission Level (dBuV) | | Limit (dBuV) | | Margin (dB) | |
| | | | Q.P. | AV. | Q.P. | AV. | Q.P. | AV. | Q.P. | AV. |
| 1 | 0.16173 | 10.14 | 26.05 | 5.80 | 36.19 | 15.94 | 65.37 | 55.37 | -29.18 | -39.43 |
| 2 | 0.18903 | 10.15 | 39.68 | 24.04 | 49.83 | 34.19 | 64.08 | 54.08 | -14.25 | -19.89 |
| 3 | 0.24775 | 10.15 | 32.48 | 18.52 | 42.63 | 28.67 | 61.83 | 51.83 | -19.20 | -23.16 |
| 4 | 1.96424 | 10.23 | 26.36 | 14.69 | 36.59 | 24.92 | 56.00 | 46.00 | -19.41 | -21.08 |
| 5 | 3.91142 | 10.27 | 18.17 | 8.31 | 28.44 | 18.58 | 56.00 | 46.00 | -27.56 | -27.42 |
| 6 | 21.18971 | 10.51 | 22.66 | 12.61 | 33.17 | 23.12 | 60.00 | 50.00 | -26.83 | -26.88 |

Remarks:

1. Q.P. and AV. are abbreviations of quasi-peak and average individually.
2. The emission levels of other frequencies were very low against the limit.
3. Margin value = Emission level – Limit value
4. Correction factor = Insertion loss + Cable loss
5. Emission Level = Correction Factor + Reading Value

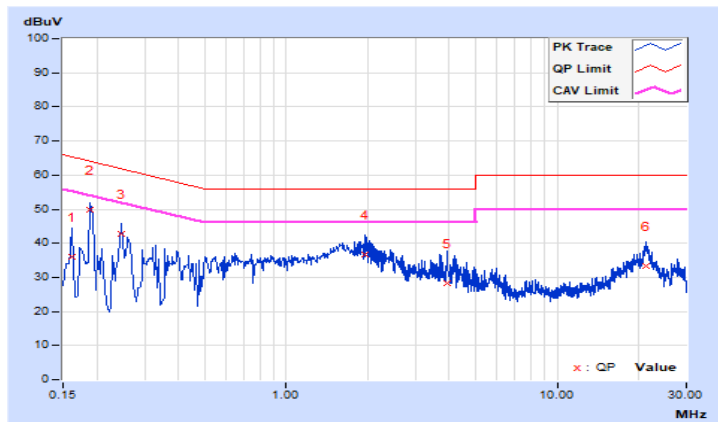

4.3 6 dB Bandwidth Measurement

4.3.1 Limits of 6 dB Bandwidth Measurement

The minimum of 6 dB Bandwidth Measurement is 0.5 MHz.

4.3.2 Test Setup

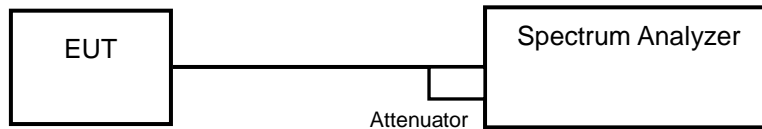

4.3.3 Test Instruments

Refer to section 4.1.2 to get information of above instrument.

4.3.4 Test Procedure

- Set resolution bandwidth (RBW) = 100 kHz
- Set the video bandwidth (VBW) $\geq 3 \times$ RBW, Detector = Peak.
- Trace mode = max hold.
- Sweep = auto couple.
- Measure the maximum width of the emission that is constrained by the frequencies associated with the two amplitude points (upper and lower) that are attenuated by 6 dB relative to the maximum level measured in the fundamental emission

4.3.5 Deviation from Test Standard

No deviation.

4.3.6 EUT Operating Conditions

The software provided by client to enable the EUT under transmission condition continuously at lowest, middle and highest channel frequencies individually.

4.3.7 Test Results

Mode A

<1MBaud PHY>

| Channel | Frequency (MHz) | 6 dB Bandwidth (MHz) | Minimum Limit (MHz) | Pass / Fail |
|---------|-----------------|----------------------|---------------------|-------------|
| 0 | 2402 | 0.66 | 0.5 | Pass |
| 1 | 2404 | 0.66 | 0.5 | Pass |
| 19 | 2440 | 0.66 | 0.5 | Pass |
| 38 | 2478 | 0.66 | 0.5 | Pass |
| 39 | 2480 | 0.66 | 0.5 | Pass |

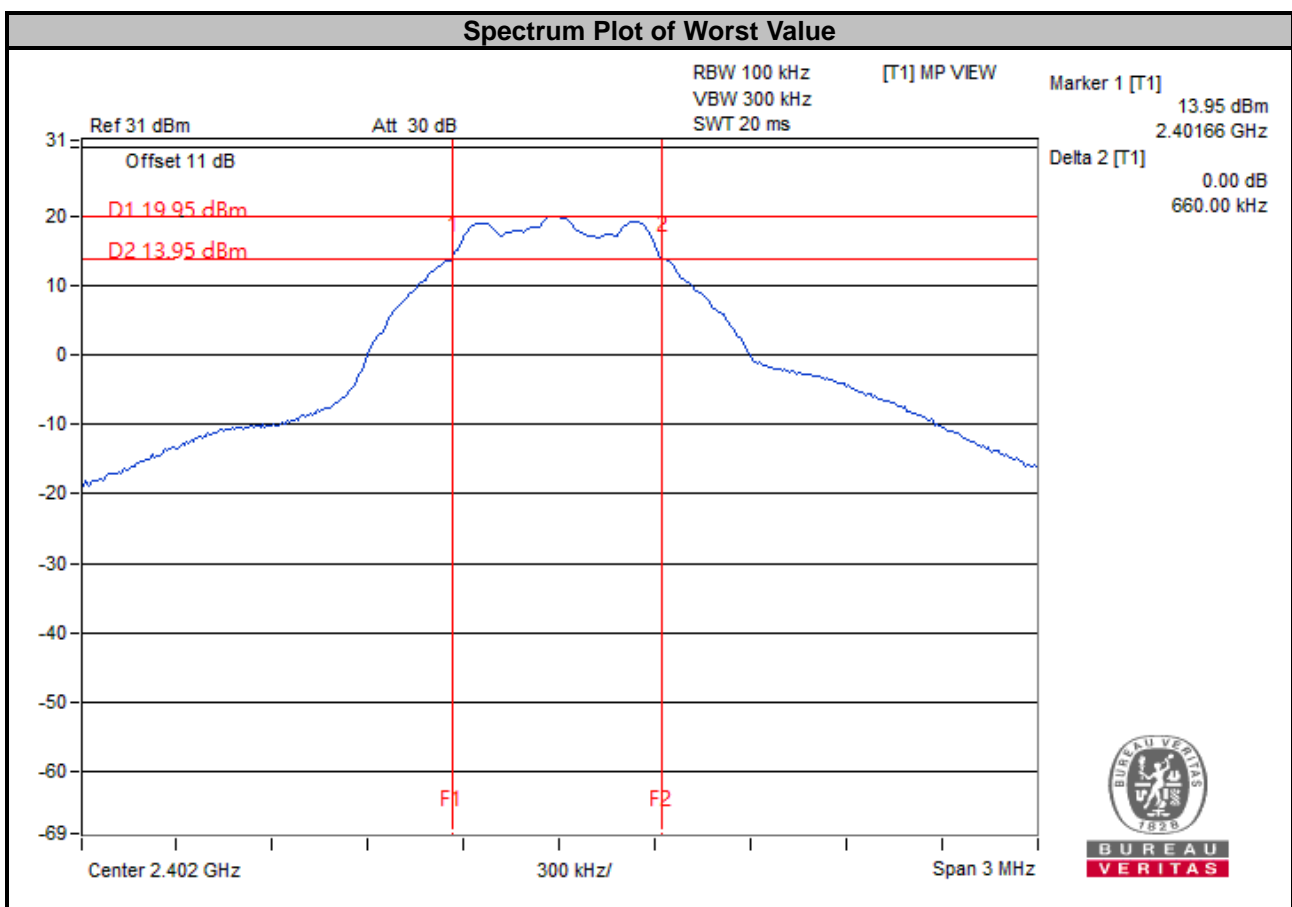

<1MBaud PHY with 125kbps>

| Channel | Frequency (MHz) | 6 dB Bandwidth (MHz) | Minimum Limit (MHz) | Pass / Fail |
|---------|-----------------|----------------------|---------------------|-------------|
| 0 | 2402 | 0.60 | 0.5 | Pass |
| 1 | 2404 | 0.60 | 0.5 | Pass |
| 19 | 2440 | 0.60 | 0.5 | Pass |
| 38 | 2478 | 0.60 | 0.5 | Pass |
| 39 | 2480 | 0.60 | 0.5 | Pass |

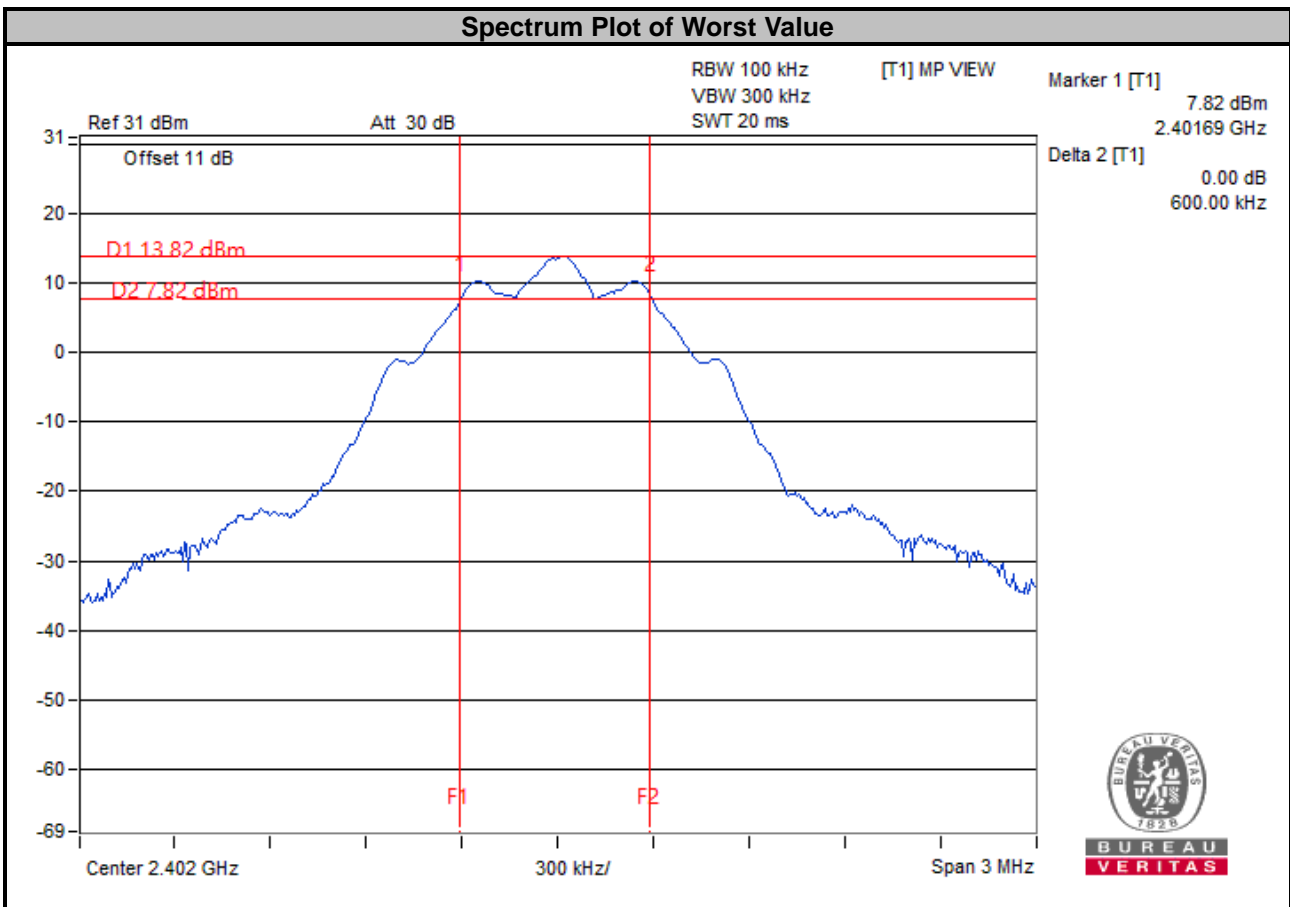

Mode B
<1Mbaud PHY>

| Channel | Frequency (MHz) | 6 dB Bandwidth (MHz) | Minimum Limit (MHz) | Pass / Fail |
|---------|-----------------|----------------------|---------------------|-------------|
| 0 | 2402 | 0.66 | 0.5 | Pass |
| 1 | 2404 | 0.65 | 0.5 | Pass |
| 19 | 2440 | 0.66 | 0.5 | Pass |
| 38 | 2478 | 0.66 | 0.5 | Pass |
| 39 | 2480 | 0.67 | 0.5 | Pass |

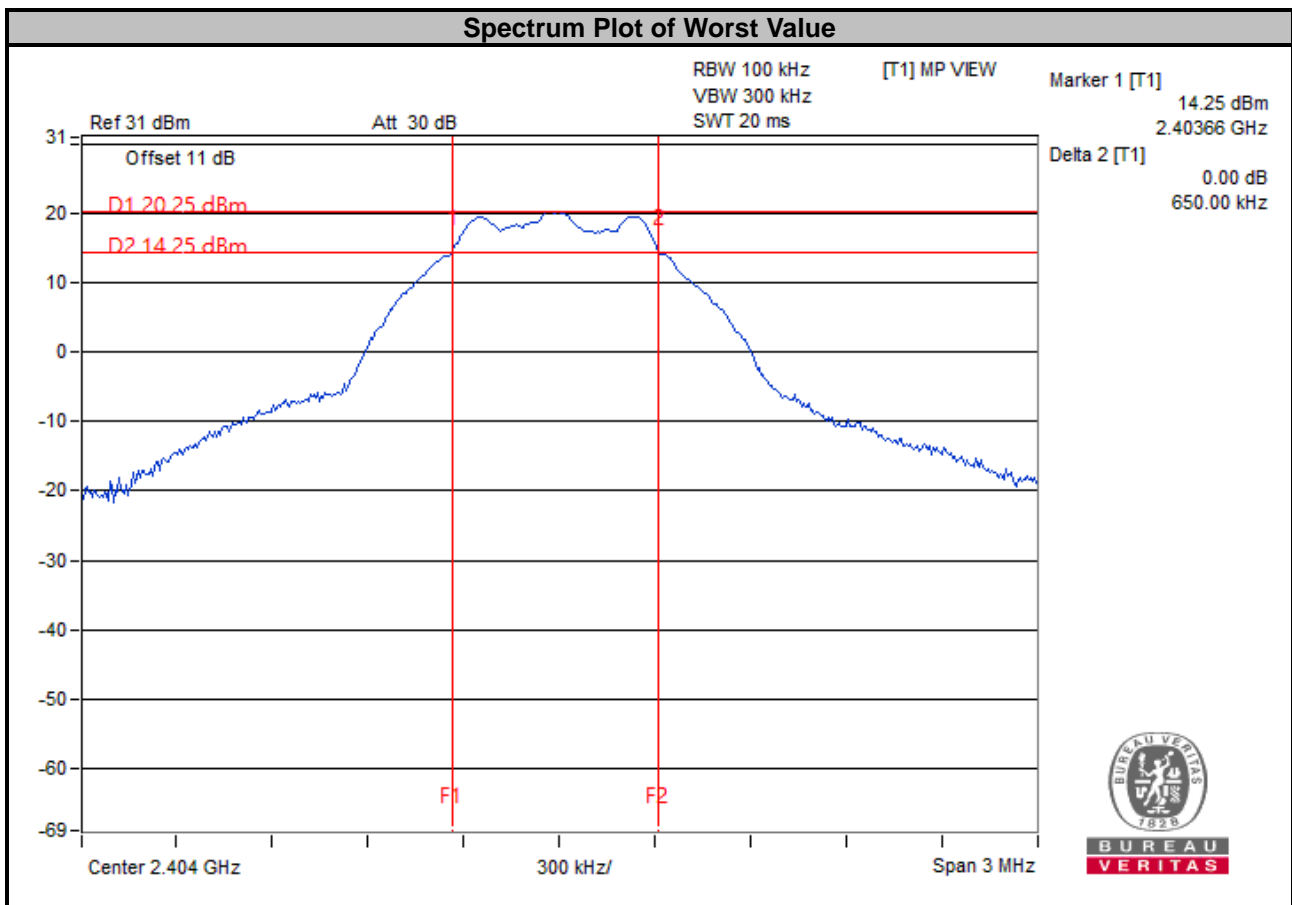

<1MBaud PHY with 125kbps>

| Channel | Frequency (MHz) | 6 dB Bandwidth (MHz) | Minimum Limit (MHz) | Pass / Fail |
|---------|-----------------|----------------------|---------------------|-------------|
| 0 | 2402 | 0.60 | 0.5 | Pass |
| 1 | 2404 | 0.60 | 0.5 | Pass |
| 19 | 2440 | 0.60 | 0.5 | Pass |
| 38 | 2478 | 0.60 | 0.5 | Pass |
| 39 | 2480 | 0.60 | 0.5 | Pass |

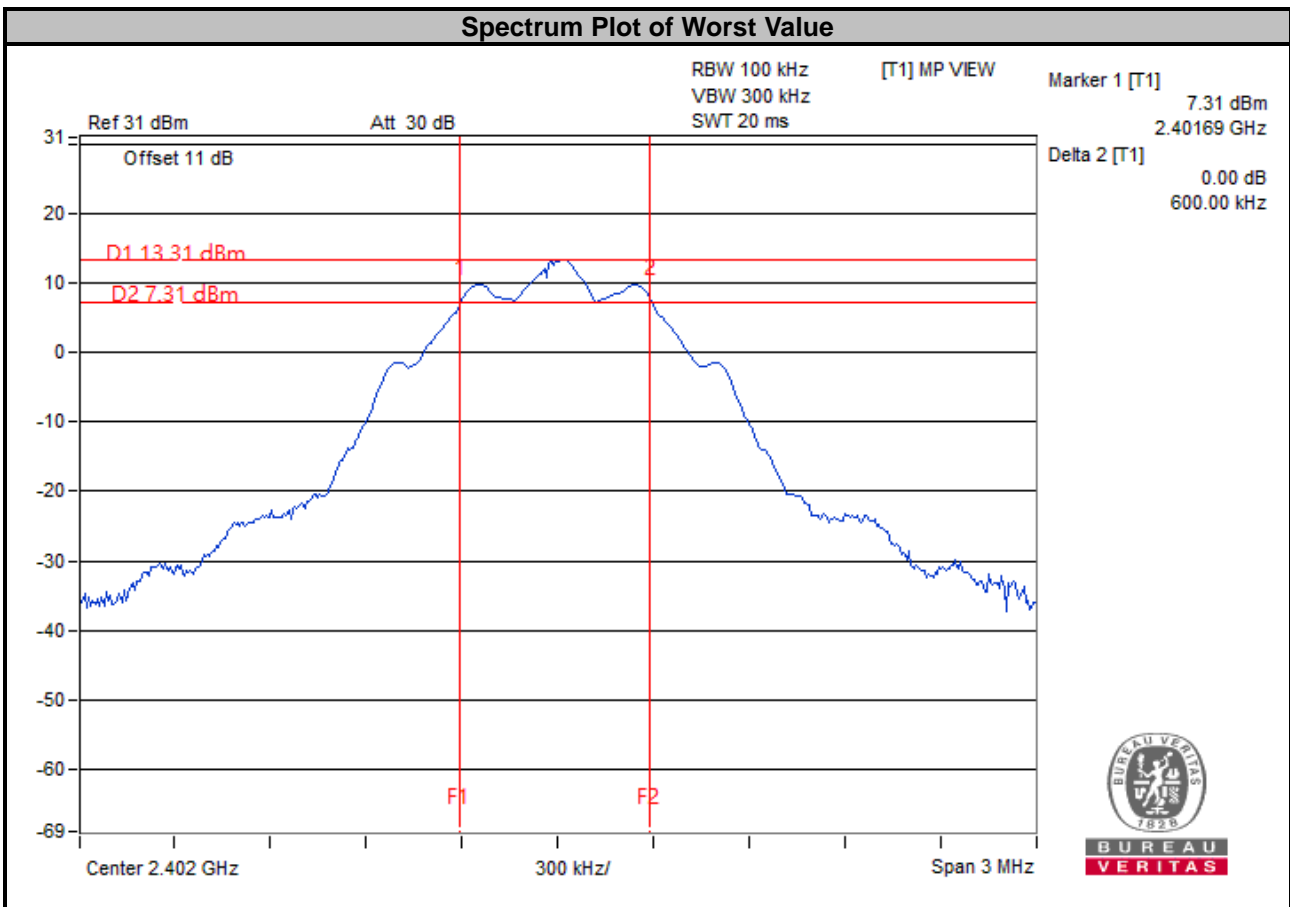

4.4 Occupied Bandwidth Measurement

4.4.1 Test Setup

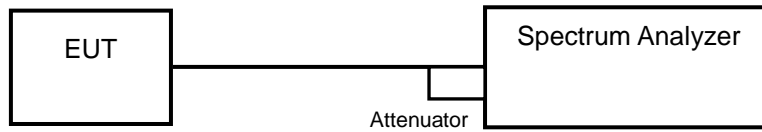

4.4.2 Test Instruments

Refer to section 4.1.2 to get information of above instrument.

4.4.3 Test Procedure

The transmitter output was connected to the spectrum analyzer through an attenuator. The bandwidth of the fundamental frequency was measured by spectrum analyzer with resolution bandwidth in the range of 1 % to 5 % of the anticipated emission bandwidth, and a video bandwidth at least 3x the resolution bandwidth and set the detector to sampling. The width of a frequency band such that, below the lower and above the upper frequency limits, the mean powers emitted are each equal to a specified percentage 0.5 % of the total mean power of a given emission.

4.4.4 Deviation from Test Standard

No deviation.

4.4.5 EUT Operating Conditions

The software provided by client to enable the EUT under transmission condition continuously at lowest, middle and highest channel frequencies individually.

<1MBaud PHY with 125kbps>

| Channel | Frequency (MHz) | Occupied Bandwidth (MHz) | Pass / Fail |
|---------|-----------------|--------------------------|-------------|
| 0 | 2402 | 1.05 | Pass |
| 1 | 2404 | 1.05 | Pass |
| 19 | 2440 | 1.04 | Pass |
| 38 | 2478 | 1.05 | Pass |
| 39 | 2480 | 1.04 | Pass |

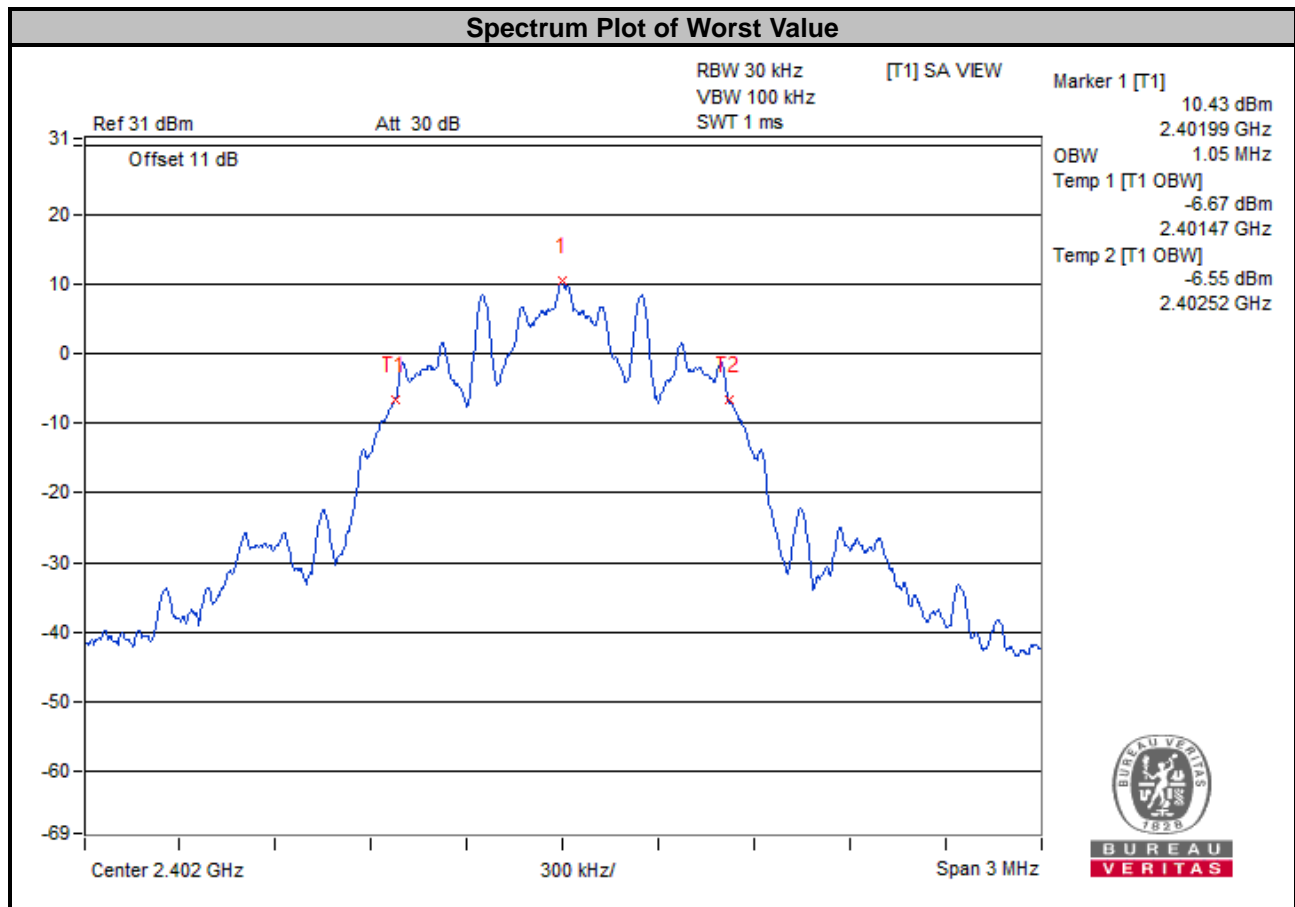

<2MBaud PHY>

| Channel | Frequency (MHz) | Occupied Bandwidth (MHz) | Pass / Fail |
|---------|-----------------|--------------------------|-------------|
| 1 | 2404 | 2.06 | Pass |
| 19 | 2440 | 2.06 | Pass |
| 38 | 2478 | 2.06 | Pass |

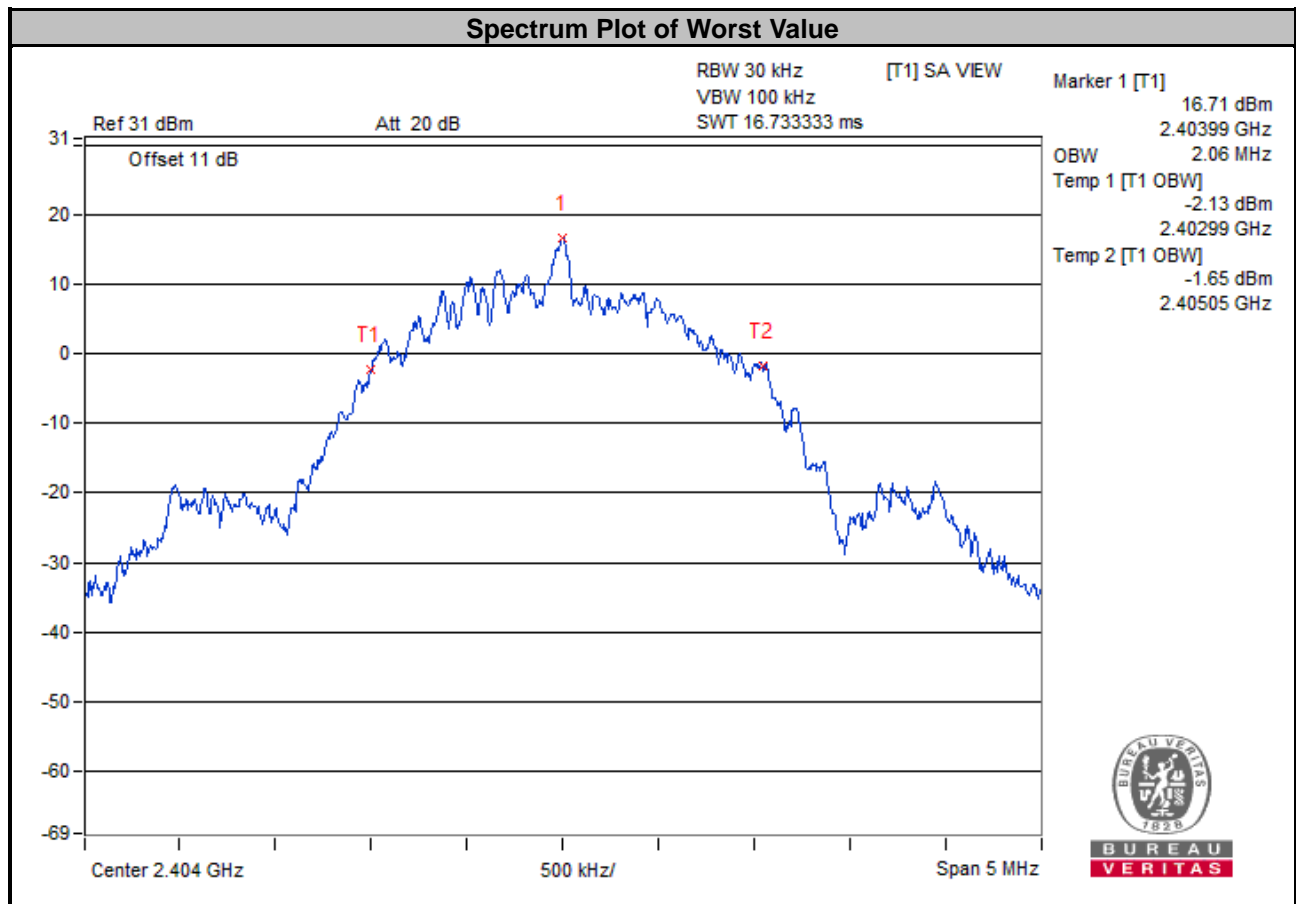

<1MBaud PHY with 125kbps>

| Channel | Frequency (MHz) | Occupied Bandwidth (MHz) | Pass / Fail |
|---------|-----------------|--------------------------|-------------|
| 0 | 2402 | 1.05 | Pass |
| 1 | 2404 | 1.05 | Pass |
| 19 | 2440 | 1.05 | Pass |
| 38 | 2478 | 1.05 | Pass |
| 39 | 2480 | 1.05 | Pass |

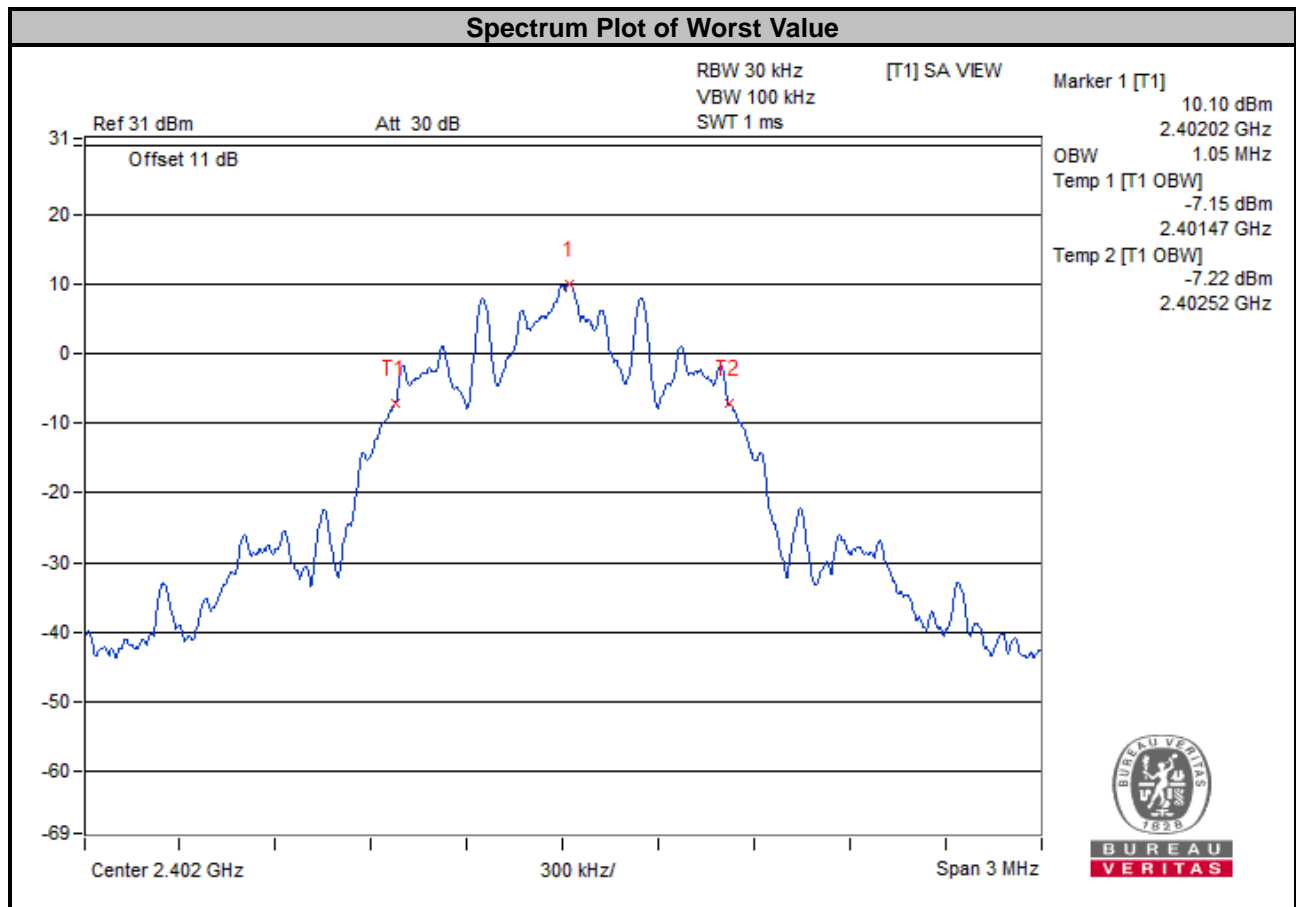

<2MBaud PHY>

| Channel | Frequency (MHz) | Occupied Bandwidth (MHz) | Pass / Fail |
|---------|-----------------|--------------------------|-------------|
| 1 | 2404 | 2.05 | Pass |
| 19 | 2440 | 2.06 | Pass |
| 38 | 2478 | 2.06 | Pass |

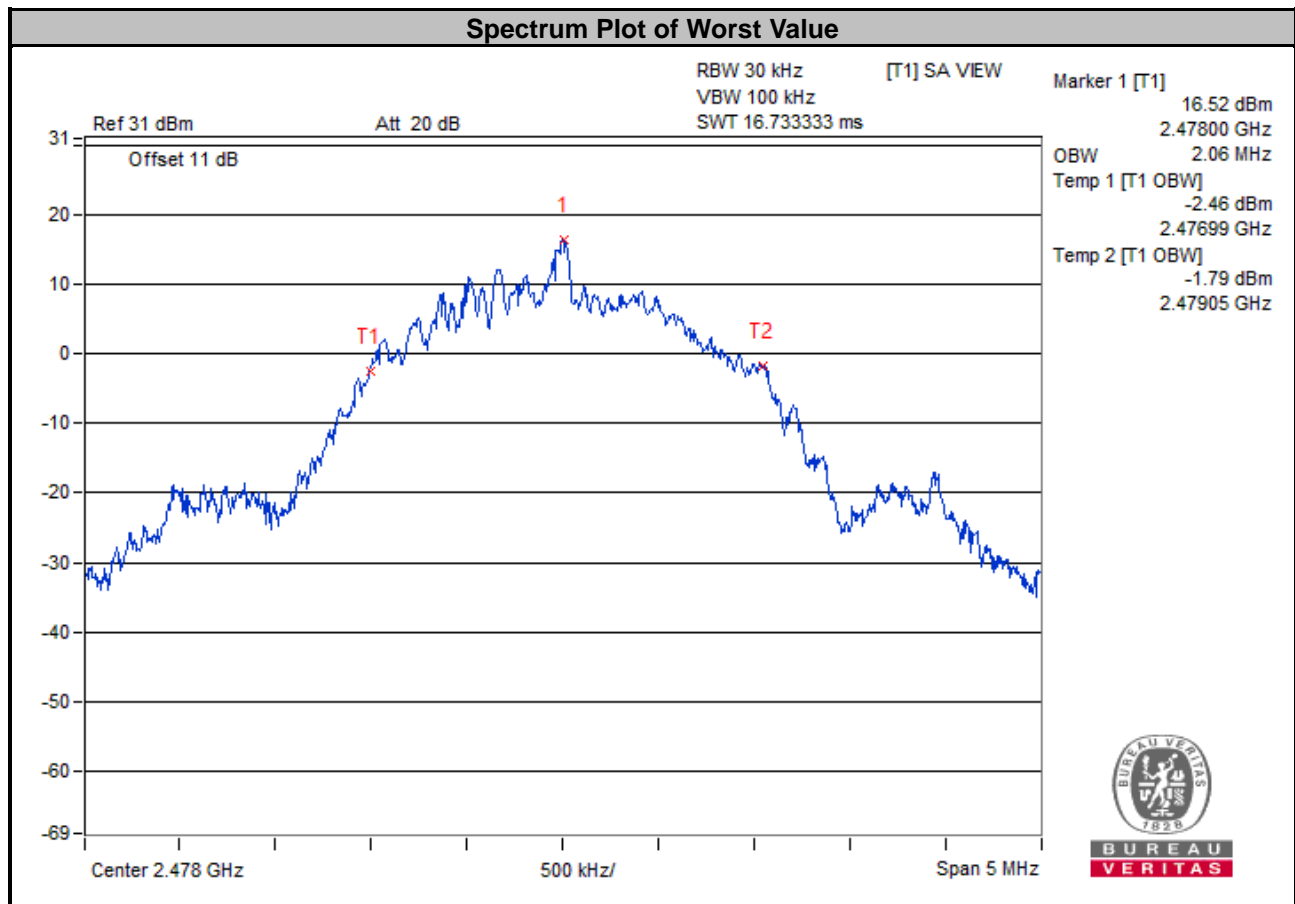

4.5 Conducted Output Power Measurement

4.5.1 Limits of Conducted Output Power Measurement

For systems using digital modulation in the 2400–2483.5 MHz bands: 1 Watt (30 dBm)

4.5.2 Test Setup

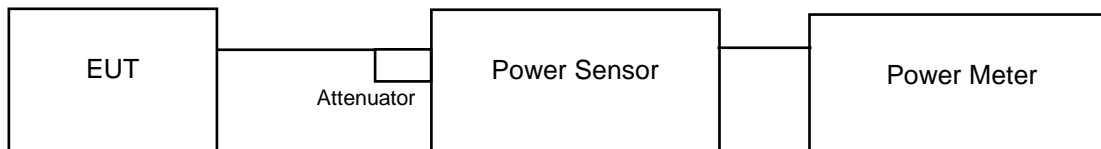

4.5.3 Test Instruments

Refer to section 4.1.2 to get information of above instrument.

4.5.4 Test Procedures

A peak power sensor was used on the output port of the EUT. A power meter was used to read the response of the peak power sensor. Record the power level.

Average power sensor was used to perform output power measurement, trigger and gating function of wide band power meter is enabled to measure max output power of TX on burst. Duty factor is not added to measured value.

4.5.5 Deviation from Test Standard

No deviation.

4.5.6 EUT Operating Conditions

The software provided by client to enable the EUT under transmission condition continuously at lowest, middle and highest channel frequencies individually.

4.5.7 Test Results

Mode A

<1MBaud PHY>

| Channel | Freq. (MHz) | Peak Power | | Average Power | | Power Limit (mW) | Pass / Fail |
|---------|-------------|------------|-------|---------------|-------|------------------|-------------|
| | | (mW) | (dBm) | (mW) | (dBm) | | |
| 0 | 2402 | 96.383 | 19.84 | 92.683 | 19.67 | 1000 | Pass |
| 1 | 2404 | 95.719 | 19.81 | 92.257 | 19.65 | 1000 | Pass |
| 19 | 2440 | 94.842 | 19.77 | 91.411 | 19.61 | 1000 | Pass |
| 38 | 2478 | 93.325 | 19.70 | 89.95 | 19.54 | 1000 | Pass |
| 39 | 2480 | 51.168 | 17.09 | 50.35 | 17.02 | 1000 | Pass |

<1MBaud PHY with 125kbps>

| Channel | Freq. (MHz) | Peak Power | | Average Power | | Power Limit (mW) | Pass / Fail |
|---------|-------------|------------|-------|---------------|-------|------------------|-------------|
| | | (mW) | (dBm) | (mW) | (dBm) | | |
| 0 | 2402 | 20.417 | 13.10 | 19.861 | 12.98 | 1000 | Pass |
| 1 | 2404 | 20.23 | 13.06 | 19.815 | 12.97 | 1000 | Pass |
| 19 | 2440 | 20.464 | 13.11 | 19.861 | 12.98 | 1000 | Pass |
| 38 | 2478 | 20.417 | 13.10 | 19.815 | 12.97 | 1000 | Pass |
| 39 | 2480 | 20.23 | 13.06 | 19.77 | 12.96 | 1000 | Pass |

<2MBaud PHY>

| Channel | Freq. (MHz) | Peak Power | | Average Power | | Power Limit (mW) | Pass / Fail |
|---------|-------------|------------|-------|---------------|-------|------------------|-------------|
| | | (mW) | (dBm) | (mW) | (dBm) | | |
| 1 | 2404 | 96.605 | 19.85 | 93.111 | 19.69 | 1000 | Pass |
| 19 | 2440 | 95.719 | 19.81 | 92.045 | 19.64 | 1000 | Pass |
| 38 | 2478 | 95.499 | 19.80 | 91.833 | 19.63 | 1000 | Pass |

Mode B
<1MBaud PHY>

| Channel | Freq. (MHz) | Peak Power | | Average Power | | Power Limit (mW) | Pass / Fail |
|---------|-------------|------------|-------|---------------|-------|------------------|-------------|
| | | (mW) | (dBm) | (mW) | (dBm) | | |
| 0 | 2402 | 94.842 | 19.77 | 91.622 | 19.62 | 1000 | Pass |
| 1 | 2404 | 94.406 | 19.75 | 91.411 | 19.61 | 1000 | Pass |
| 19 | 2440 | 93.325 | 19.70 | 90.365 | 19.56 | 1000 | Pass |
| 38 | 2478 | 92.897 | 19.68 | 89.95 | 19.54 | 1000 | Pass |
| 39 | 2480 | 50.699 | 17.05 | 49.774 | 16.97 | 1000 | Pass |

<1MBaud PHY with 125kbps>

| Channel | Freq. (MHz) | Peak Power | | Average Power | | Power Limit (mW) | Pass / Fail |
|---------|-------------|------------|-------|---------------|-------|------------------|-------------|
| | | (mW) | (dBm) | (mW) | (dBm) | | |
| 0 | 2402 | 20.512 | 13.12 | 19.861 | 12.98 | 1000 | Pass |
| 1 | 2404 | 20.559 | 13.13 | 19.907 | 12.99 | 1000 | Pass |
| 19 | 2440 | 20.37 | 13.09 | 19.77 | 12.96 | 1000 | Pass |
| 38 | 2478 | 20.464 | 13.11 | 19.815 | 12.97 | 1000 | Pass |
| 39 | 2480 | 20.417 | 13.10 | 19.77 | 12.96 | 1000 | Pass |

<2MBaud PHY>

| Channel | Freq. (MHz) | Peak Power | | Average Power | | Power Limit (mW) | Pass / Fail |
|---------|-------------|------------|-------|---------------|-------|------------------|-------------|
| | | (mW) | (dBm) | (mW) | (dBm) | | |
| 1 | 2404 | 94.406 | 19.75 | 91.411 | 19.61 | 1000 | Pass |
| 19 | 2440 | 93.756 | 19.72 | 90.573 | 19.57 | 1000 | Pass |
| 38 | 2478 | 93.325 | 19.70 | 89.95 | 19.54 | 1000 | Pass |

4.6 Power Spectral Density Measurement

4.6.1 Limits of Power Spectral Density Measurement

The Maximum of Power Spectral Density Measurement is 8 dBm in any 3 kHz band during any time interval of continuous transmission.

4.6.2 Test Setup



4.6.3 Test Instruments

Refer to section 4.1.2 to get information of above instrument.

4.6.4 Test Procedure

- a. Set analyzer center frequency to DTS channel center frequency.
- b. Set the span to 1.5 times the DTS bandwidth.
- c. Set the RBW to: $3 \text{ kHz} \leq \text{RBW} \leq 100 \text{ kHz}$.
- d. Set the VBW $\geq 3 \times \text{RBW}$.
- e. Detector = peak.
- f. Sweep time = auto couple.
- g. Trace mode = max hold.
- h. Allow trace to fully stabilize.
- i. Use the peak marker function to determine the maximum amplitude level within the RBW.

4.6.5 Deviation from Test Standard

No deviation.

4.6.6 EUT Operating Condition

The software provided by client to enable the EUT under transmission condition continuously at lowest, middle and highest channel frequencies individually.

4.6.7 Test Results

Mode A

<1MBaud PHY>

| Channel | Frequency (MHz) | PSD (dBm/3 kHz) | Limit (dBm/3 kHz) | Pass / Fail |
|---------|-----------------|-----------------|-------------------|-------------|
| 0 | 2402 | 6.06 | 8 | Pass |
| 1 | 2404 | 6.12 | 8 | Pass |
| 19 | 2440 | 5.92 | 8 | Pass |
| 38 | 2478 | 5.86 | 8 | Pass |
| 39 | 2480 | 3.13 | 8 | Pass |

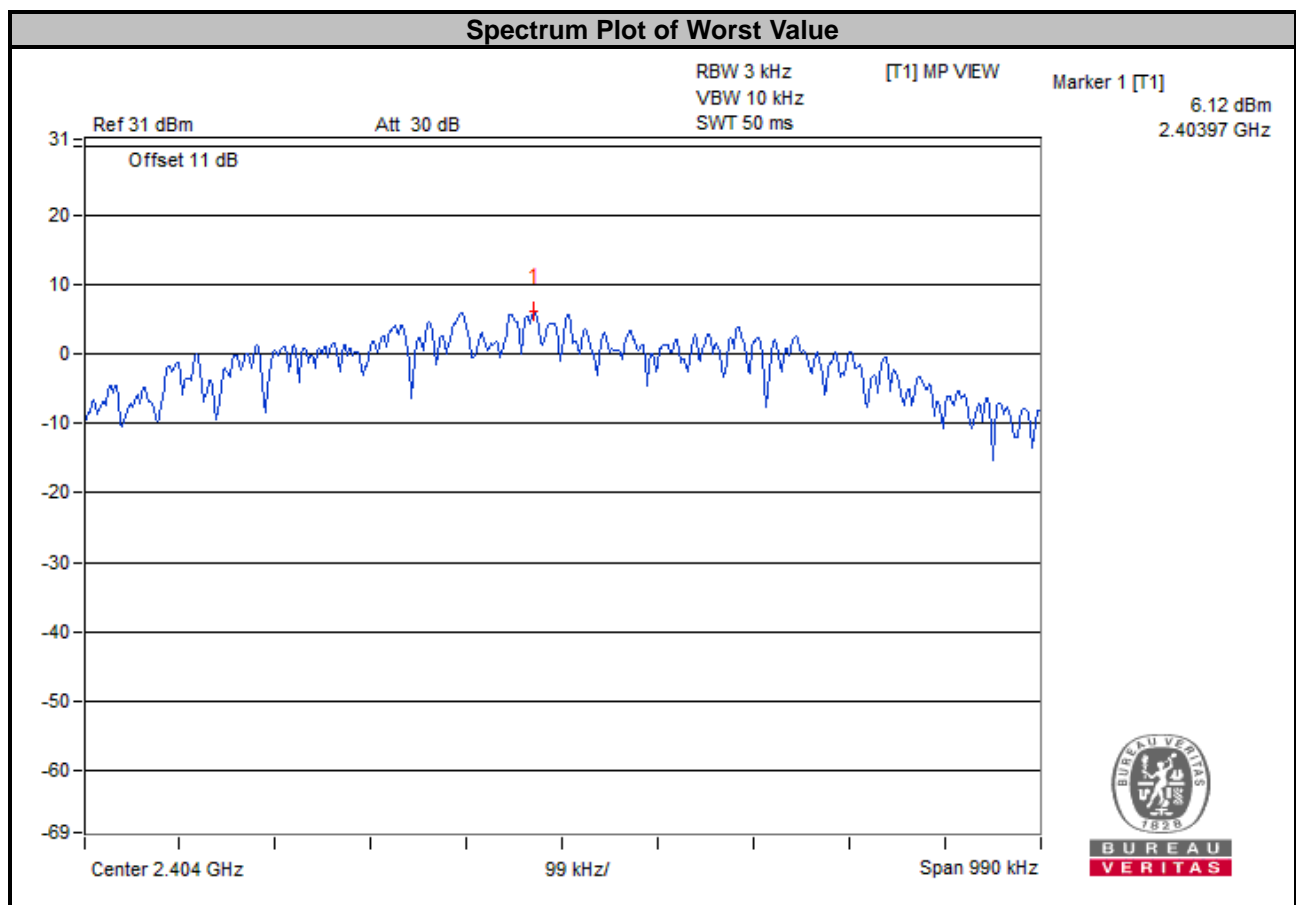

<1MBaud PHY with 125kbps>

| Channel | Frequency (MHz) | PSD (dBm/3 kHz) | Limit (dBm/3 kHz) | Pass / Fail |
|---------|-----------------|-----------------|-------------------|-------------|
| 0 | 2402 | 7.74 | 8 | Pass |
| 1 | 2404 | 7.20 | 8 | Pass |
| 19 | 2440 | 7.34 | 8 | Pass |
| 38 | 2478 | 7.11 | 8 | Pass |
| 39 | 2480 | 7.15 | 8 | Pass |

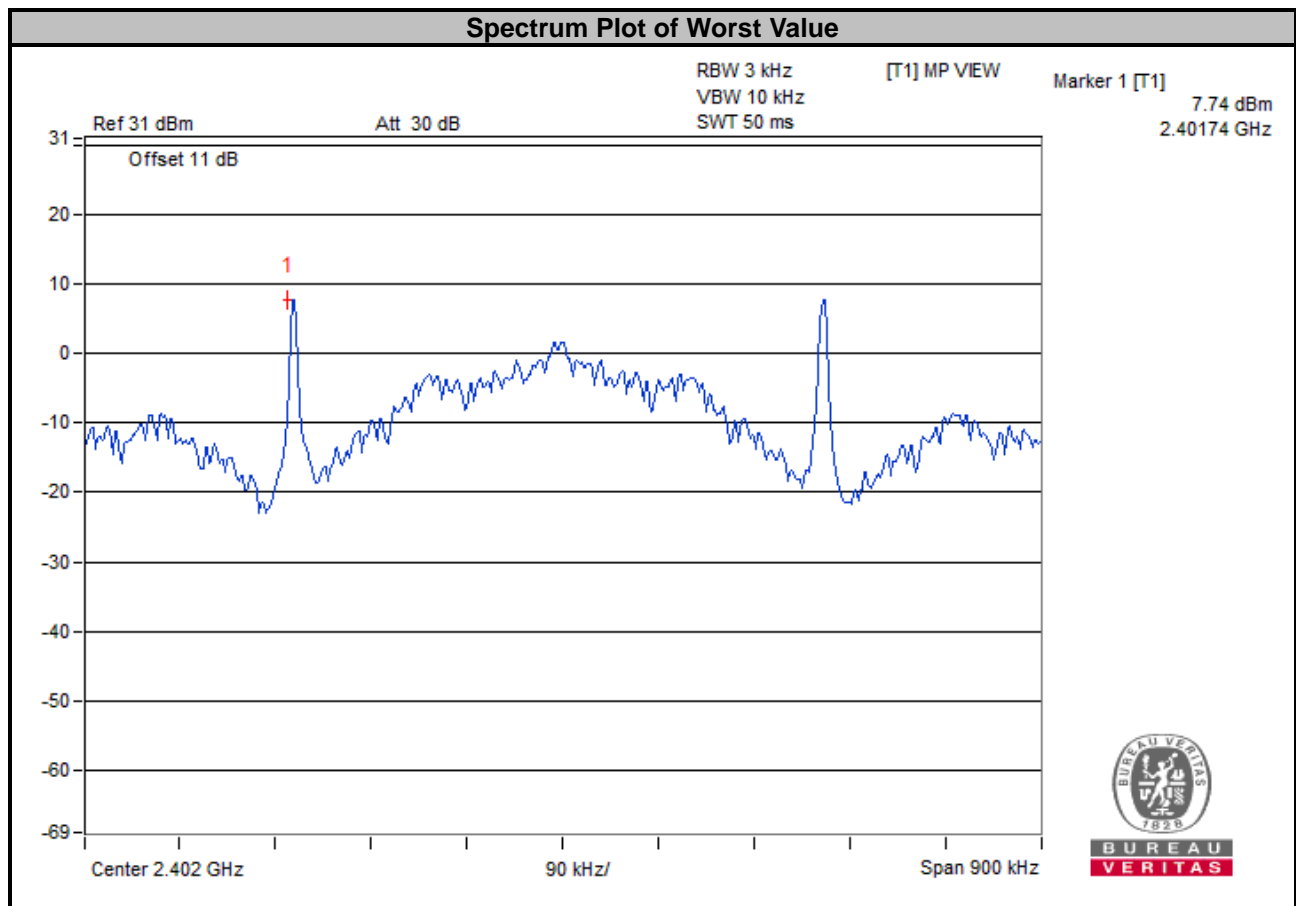

<2MBaud PHY>

| Channel | Frequency (MHz) | PSD (dBm/3 kHz) | Limit (dBm/3 kHz) | Pass / Fail |
|---------|-----------------|-----------------|-------------------|-------------|
| 1 | 2404 | 6.22 | 8 | Pass |
| 19 | 2440 | 6.23 | 8 | Pass |
| 38 | 2478 | 6.06 | 8 | Pass |

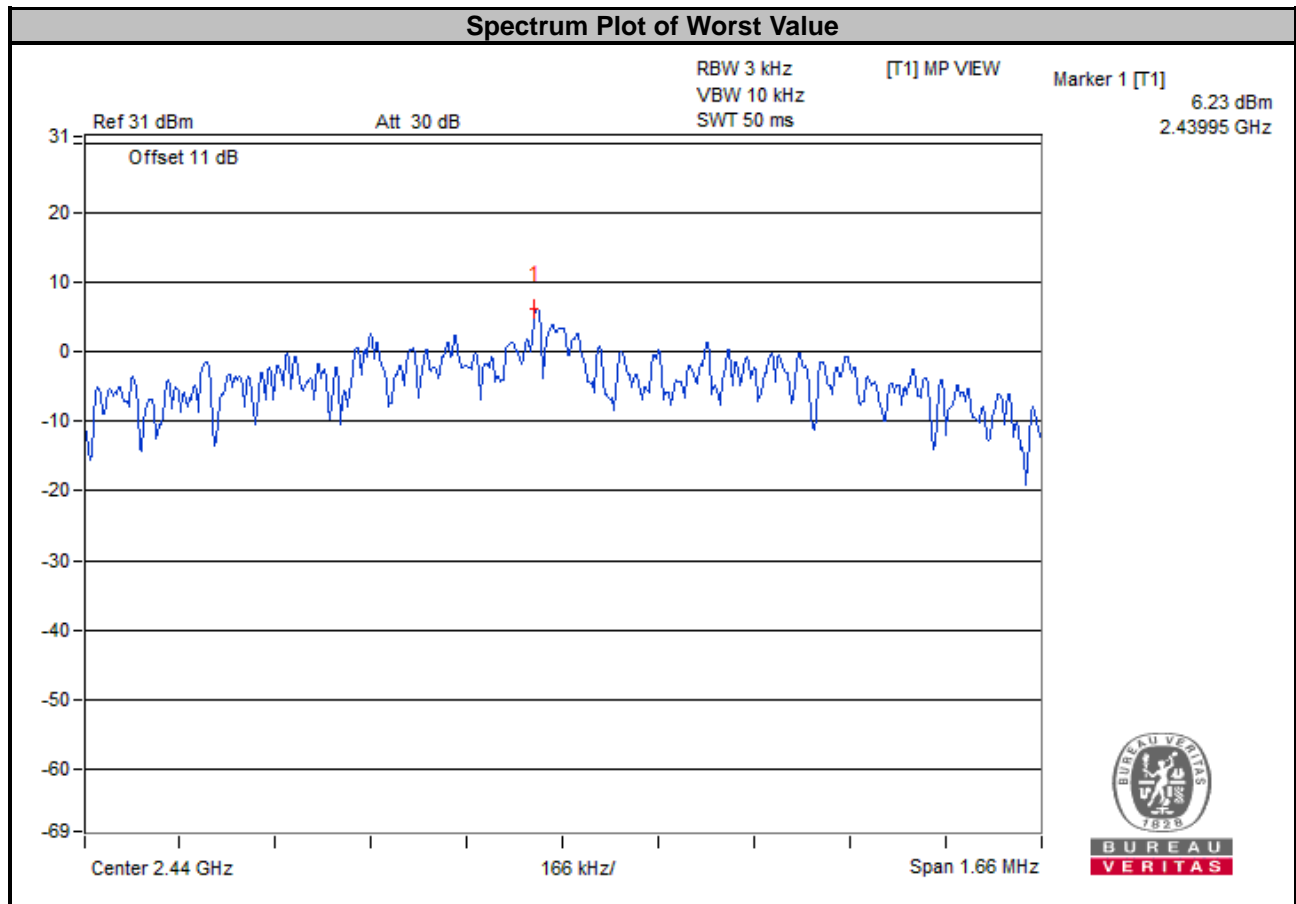

Mode B
<1Mbaud PHY>

| Channel | Frequency (MHz) | PSD (dBm/3 kHz) | Limit (dBm/3 kHz) | Pass / Fail |
|---------|-----------------|-----------------|-------------------|-------------|
| 0 | 2402 | 5.95 | 8 | Pass |
| 1 | 2404 | 5.69 | 8 | Pass |
| 19 | 2440 | 6.01 | 8 | Pass |
| 38 | 2478 | 5.92 | 8 | Pass |
| 39 | 2480 | 5.31 | 8 | Pass |

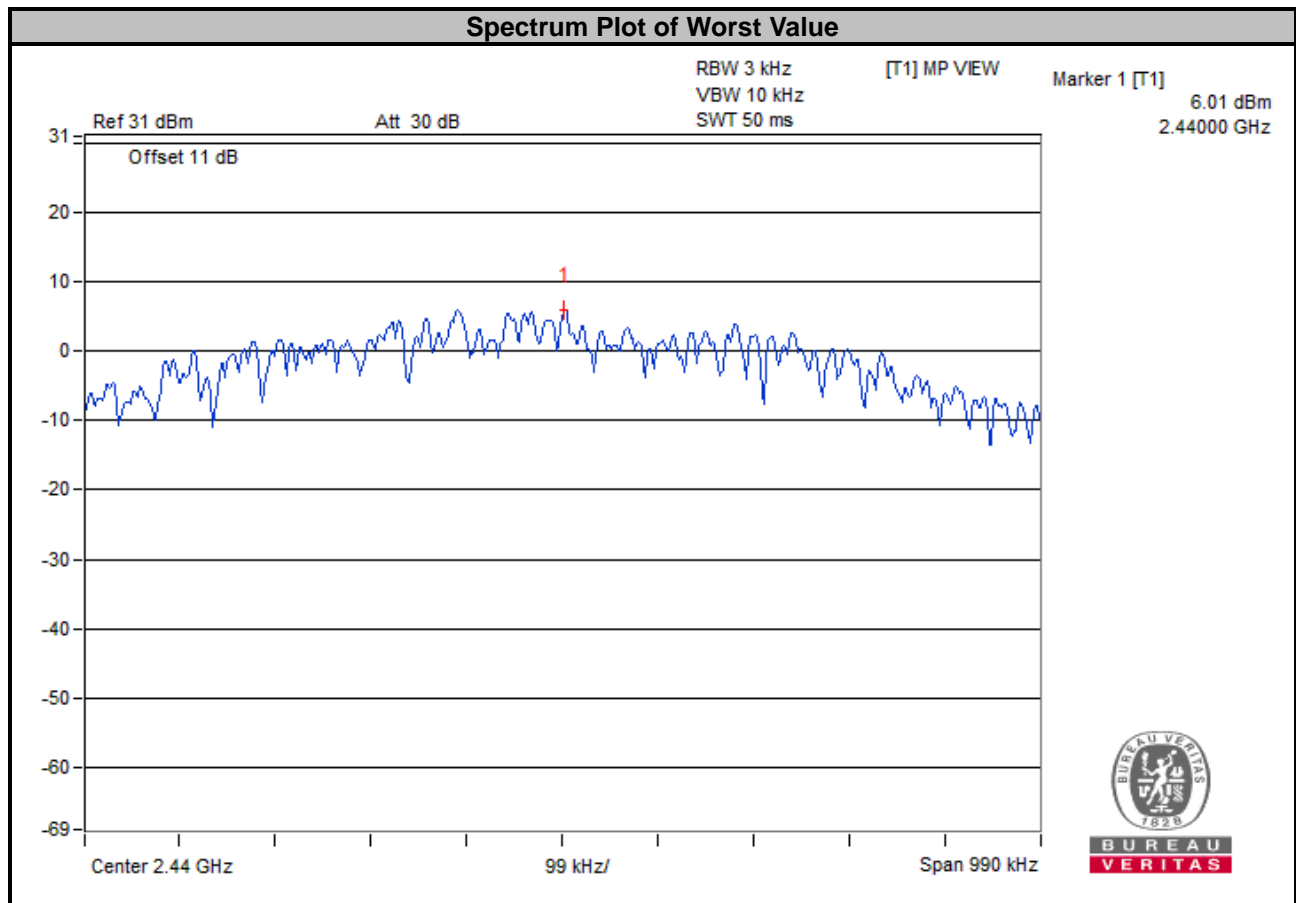

<1MBaud PHY with 125kbps>

| Channel | Frequency (MHz) | PSD (dBm/3 kHz) | Limit (dBm/3 kHz) | Pass / Fail |
|---------|-----------------|-----------------|-------------------|-------------|
| 0 | 2402 | 7.27 | 8 | Pass |
| 1 | 2404 | 7.21 | 8 | Pass |
| 19 | 2440 | 7.13 | 8 | Pass |
| 38 | 2478 | 7.10 | 8 | Pass |
| 39 | 2480 | 7.07 | 8 | Pass |

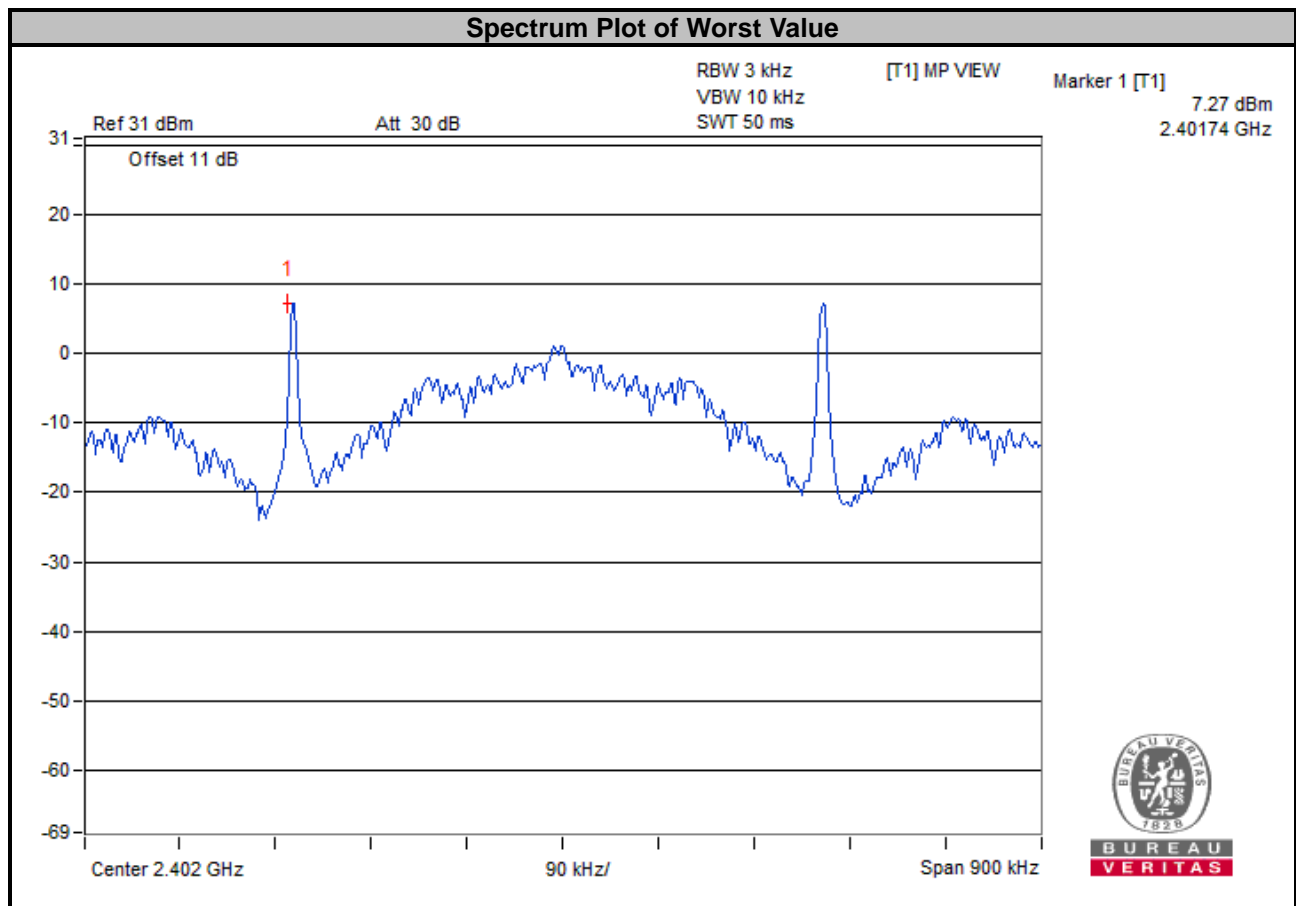

<2MBaud PHY>

| Channel | Frequency (MHz) | PSD (dBm/3 kHz) | Limit (dBm/3 kHz) | Pass / Fail |
|---------|-----------------|-----------------|-------------------|-------------|
| 1 | 2404 | 6.46 | 8 | Pass |
| 19 | 2440 | 6.42 | 8 | Pass |
| 38 | 2478 | 6.40 | 8 | Pass |

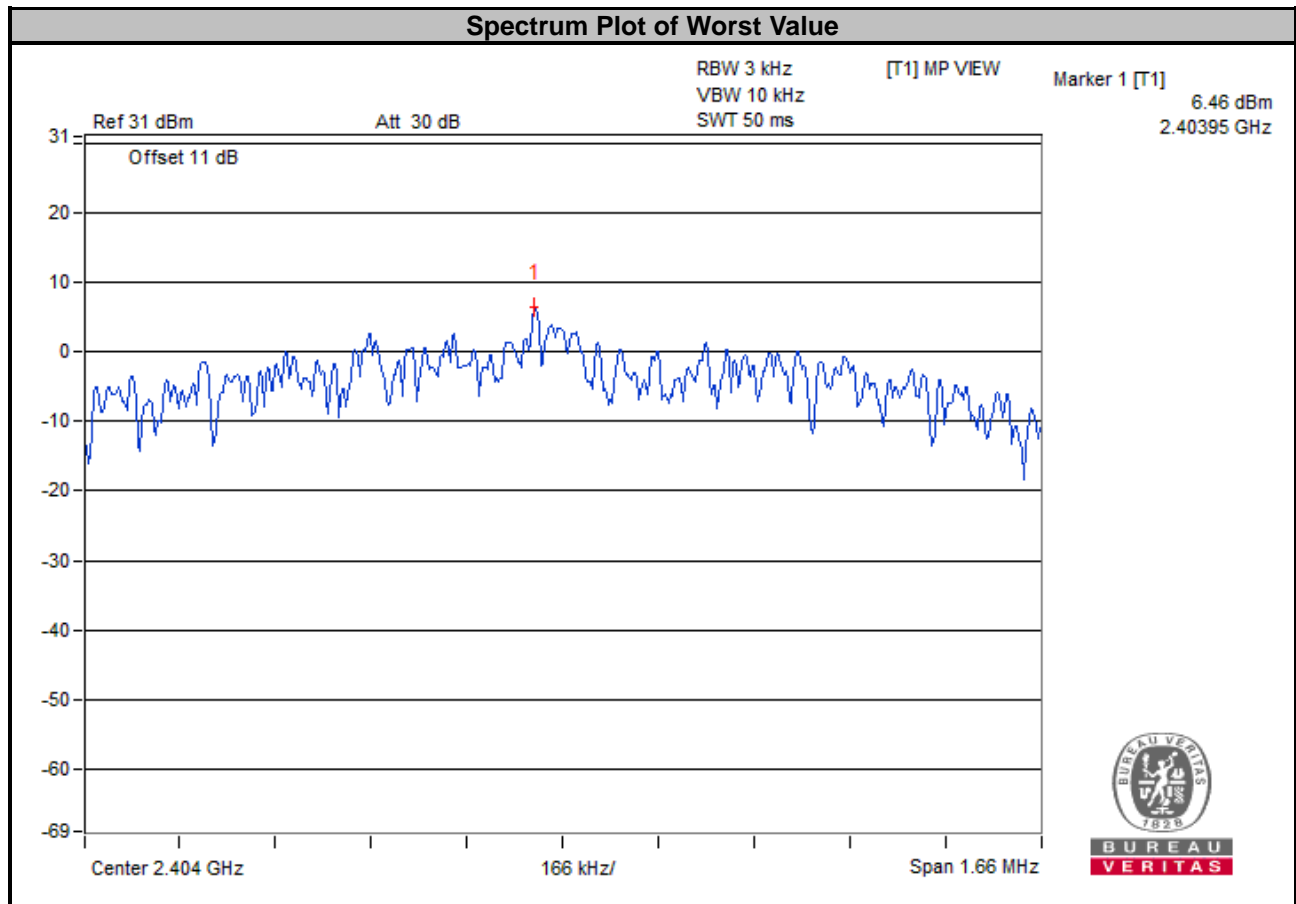

4.7 Conducted Out of Band Emission Measurement

4.7.1 Limits of Conducted Out of Band Emission Measurement

Below 20 dB of the highest emission level of operating band (in 100 kHz Resolution Bandwidth).

4.7.2 Test Setup

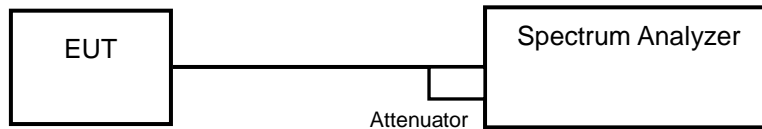

4.7.3 Test Instruments

Refer to section 4.1.2 to get information of above instrument.

4.7.4 Test Procedure

MEASUREMENT PROCEDURE REF

1. Set the RBW = 100 kHz.
2. Set the VBW \geq 300 kHz.
3. Detector = peak.
4. Sweep time = auto couple.
5. Trace mode = max hold.
6. Allow trace to fully stabilize.
7. Use the peak marker function to determine the maximum power level in any 100 kHz band segment within the fundamental EBW.

MEASUREMENT PROCEDURE OOBE

1. Set RBW = 100 kHz.
2. Set VBW \geq 300 kHz.
3. Detector = peak.
4. Sweep = auto couple.
5. Trace Mode = max hold.
6. Allow trace to fully stabilize.
7. Use the peak marker function to determine the maximum amplitude level.

4.7.5 Deviation from Test Standard

No deviation.

4.7.6 EUT Operating Condition

The software provided by client to enable the EUT under transmission condition continuously at lowest, middle and highest channel frequencies individually.

4.7.7 Test Results

The spectrum plots are attached on the following images. D1 line indicates the highest level, D2 line indicates the 20 dB offset below D1. It shows compliance with the requirement.

Mode A
<1Mbaud PHY>

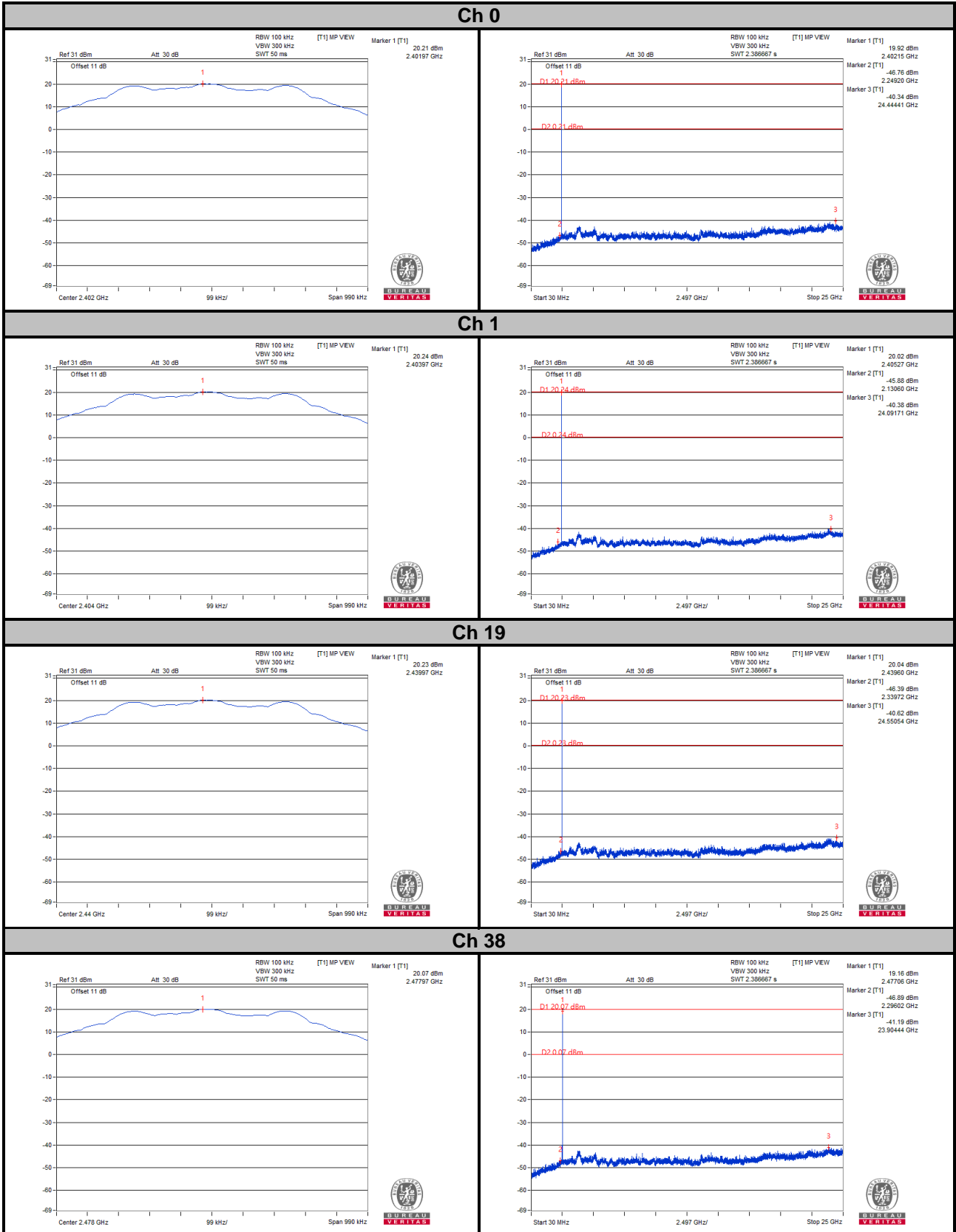

Ch 39

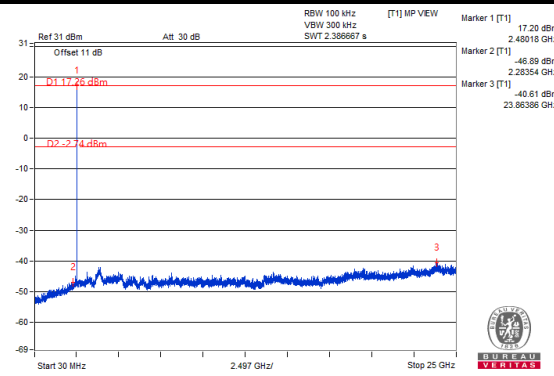
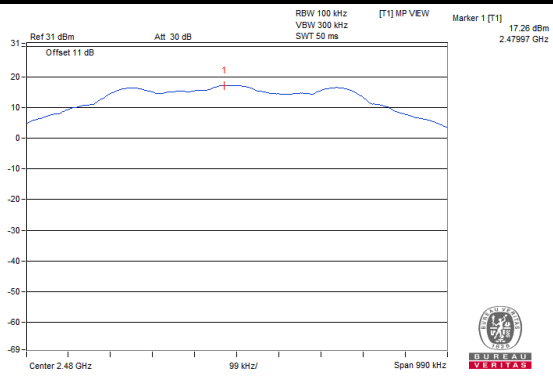

Ch 0 Band Edge

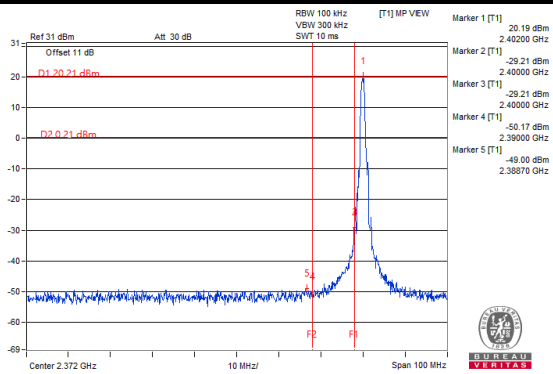

Ch 1 Band Edge

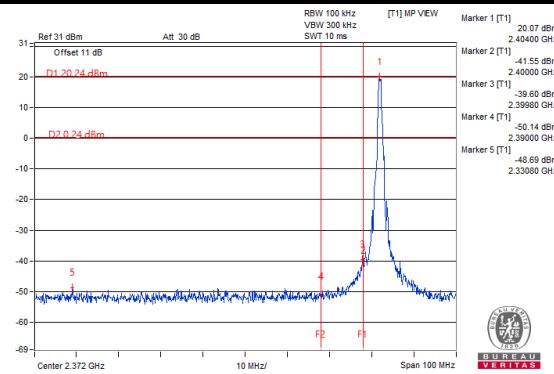

Ch 38 Band Edge

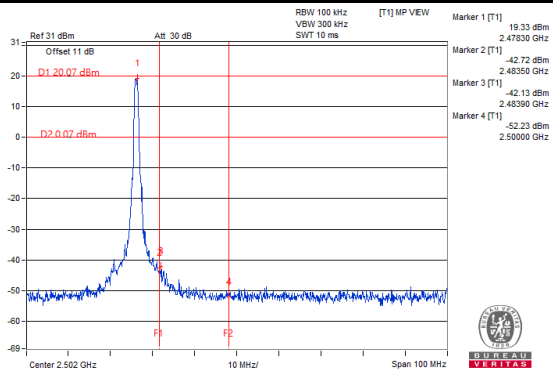

Ch 39 Band Edge

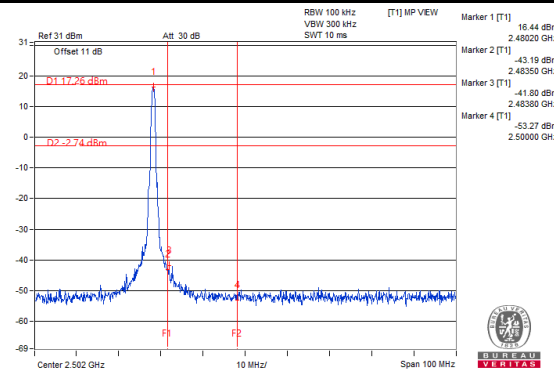

<1Mbaud PHY with 125kpbs>

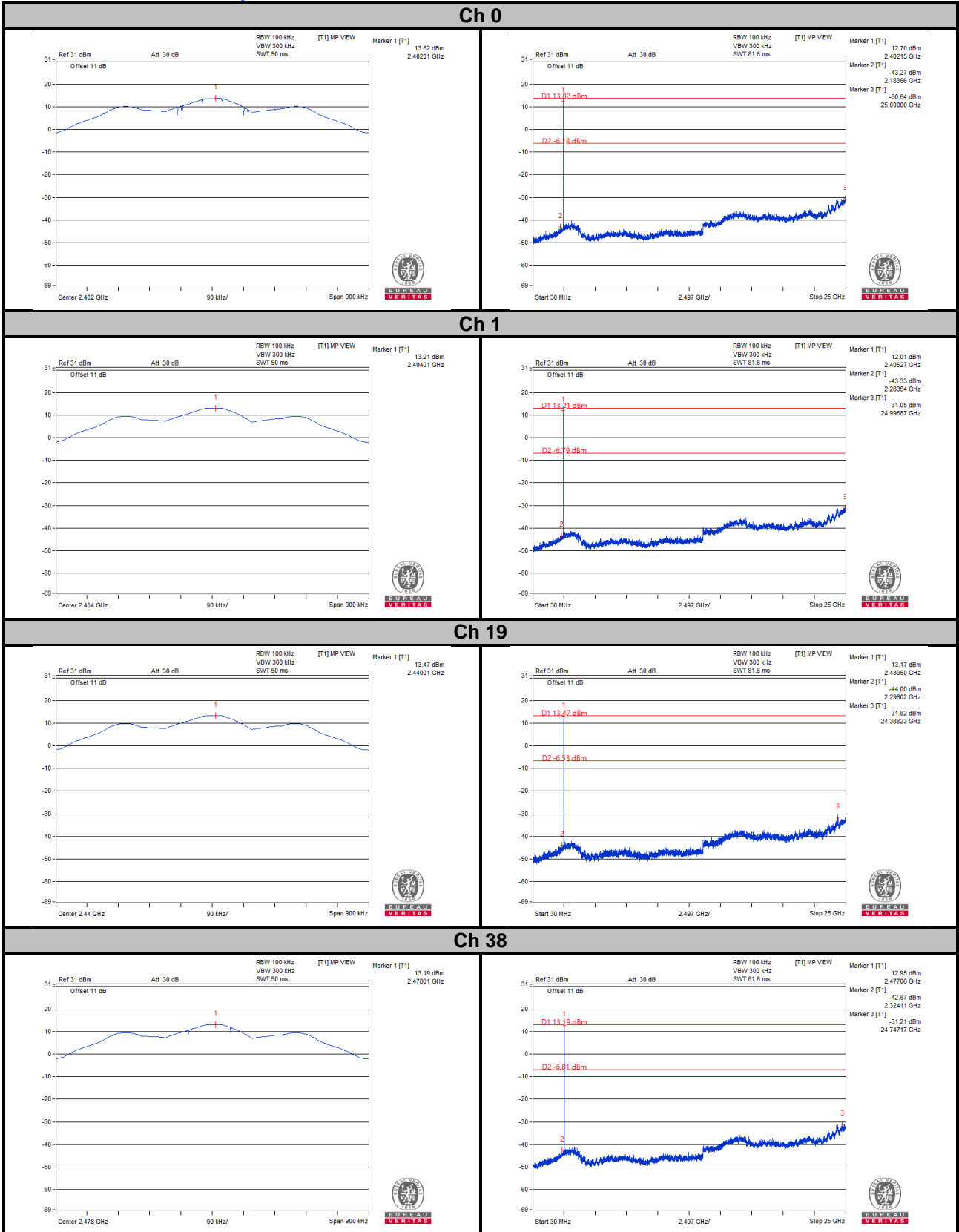

Ch 39

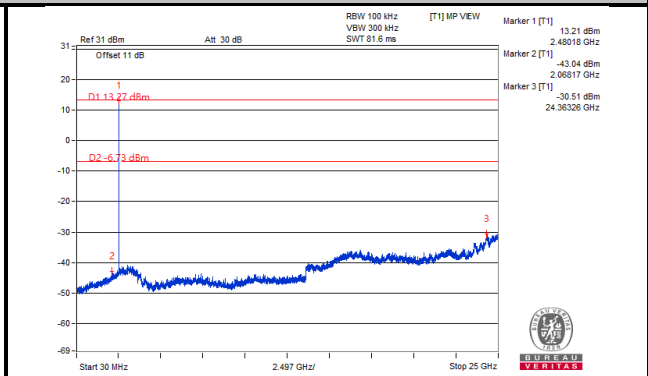
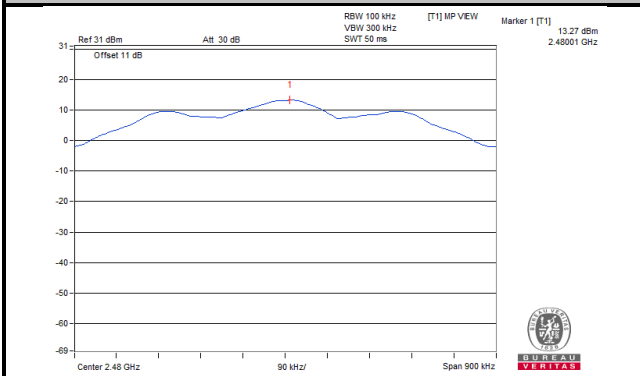

Ch 0 Band Edge

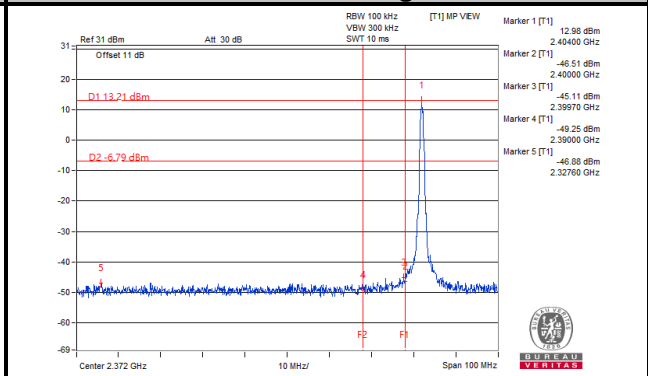
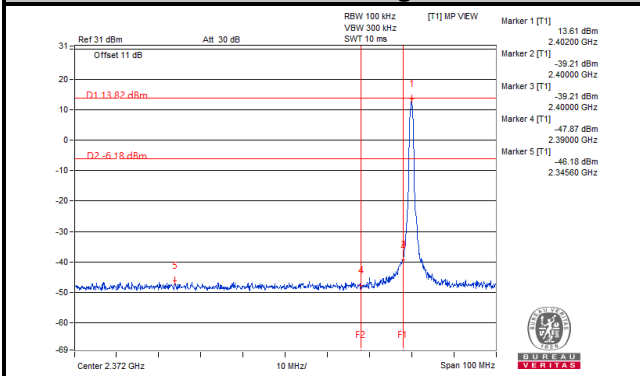

Ch 38 Band Edge

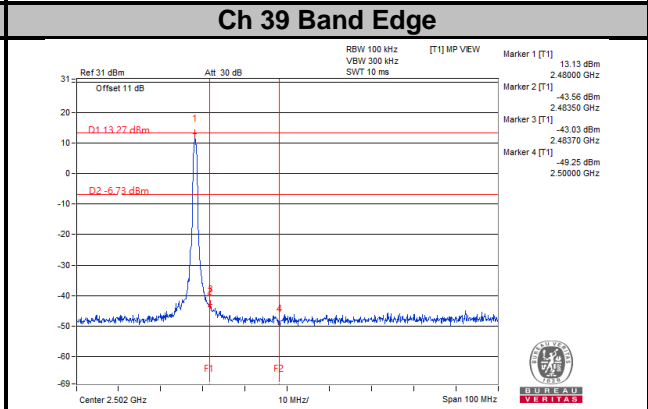
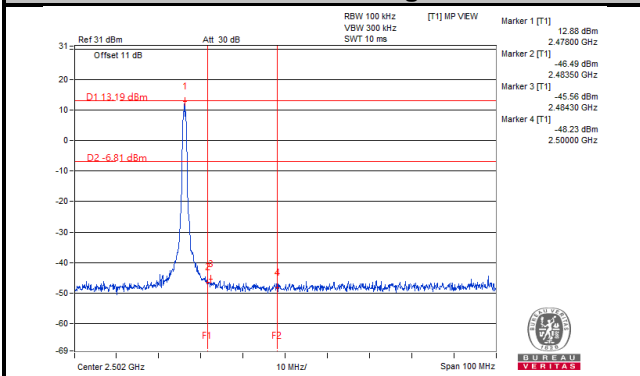

Ch 39 Band Edge

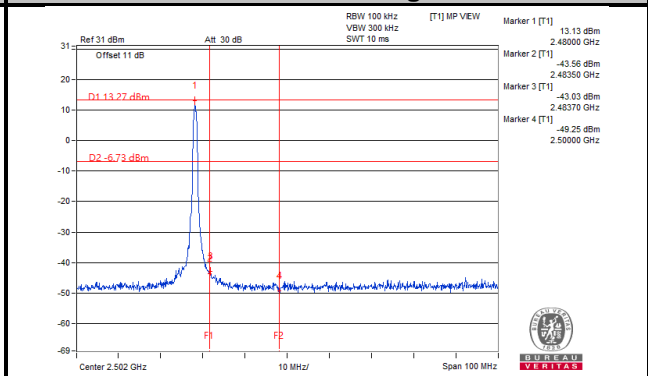
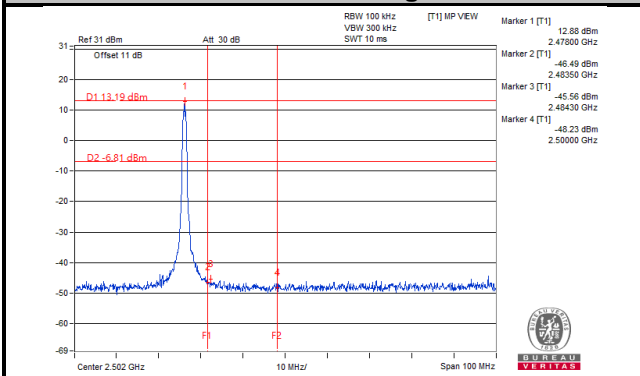

<2MBaud PHY>

Ch 1

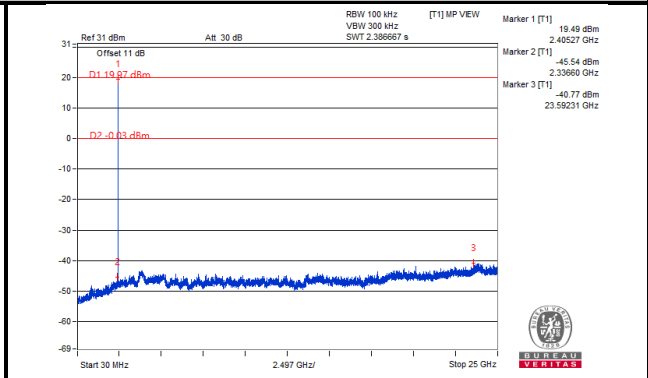
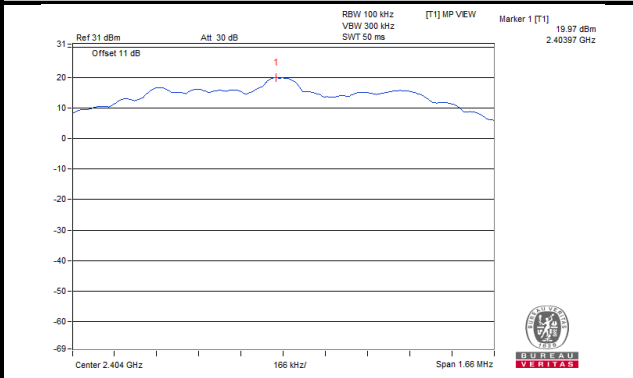

Ch 19

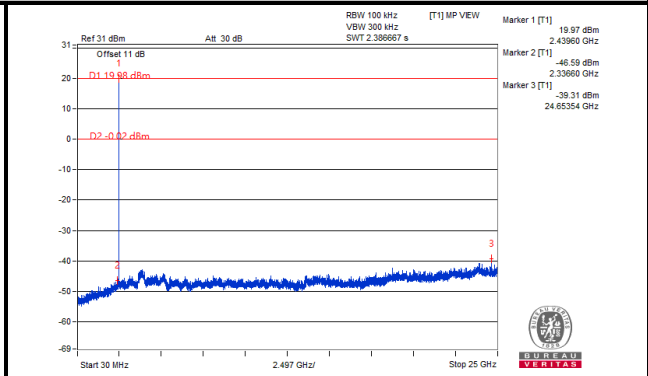
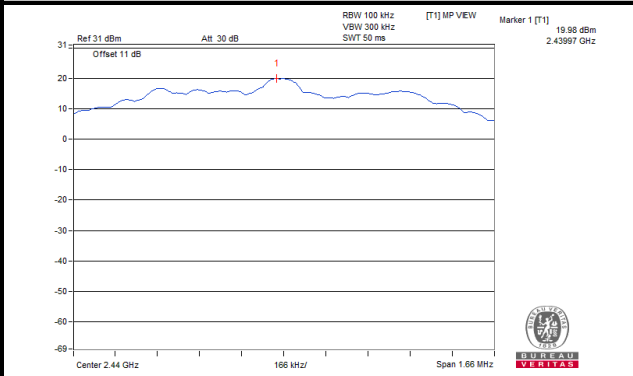

Ch 38

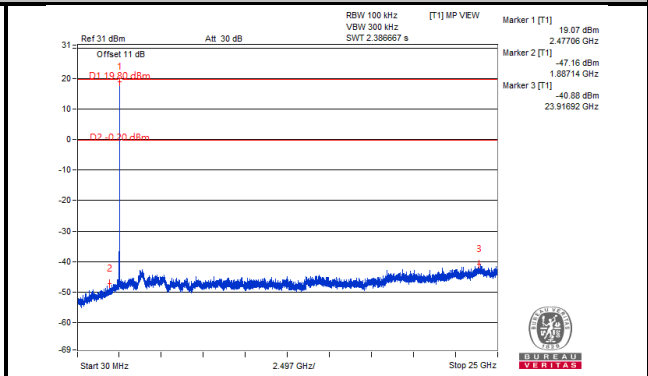
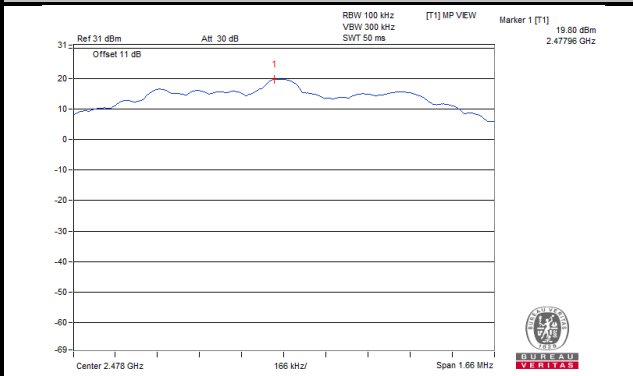

Ch 1 Band Edge

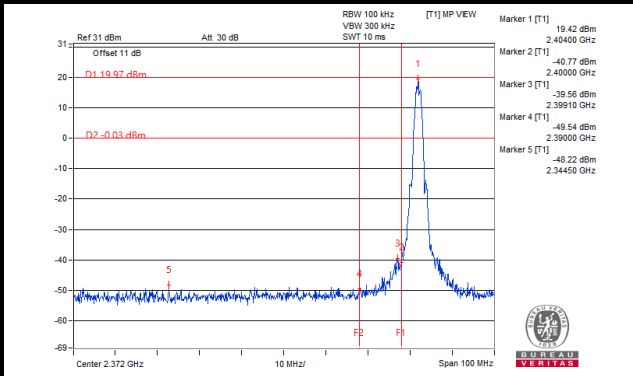

Ch 38 Band Edge

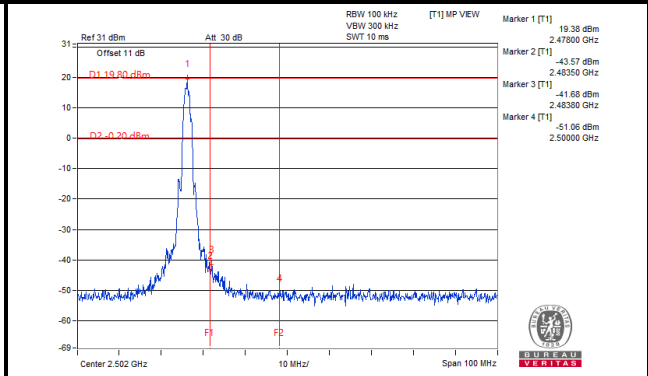

Mode B
<1Mbaud PHY>

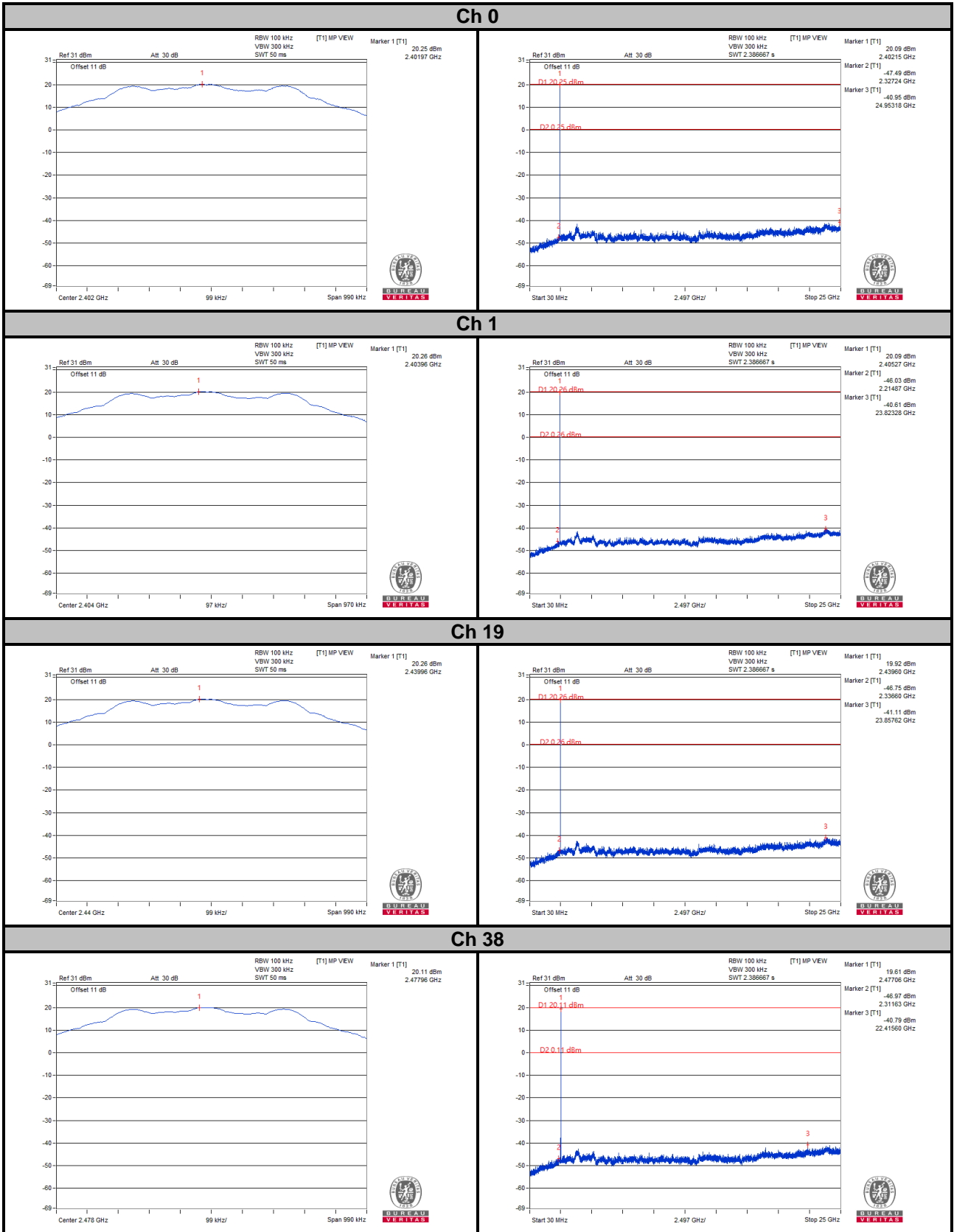

Ch 39

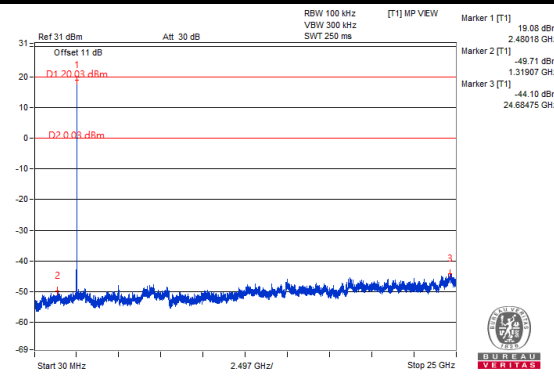
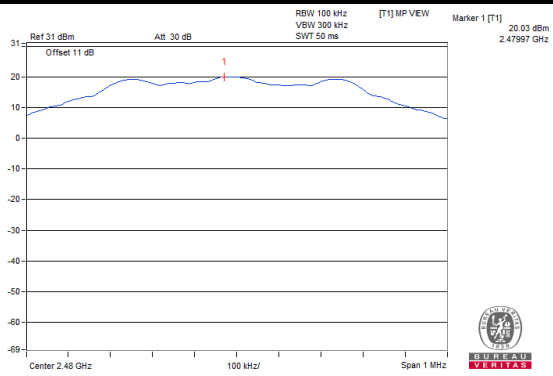

Ch 0 Band Edge

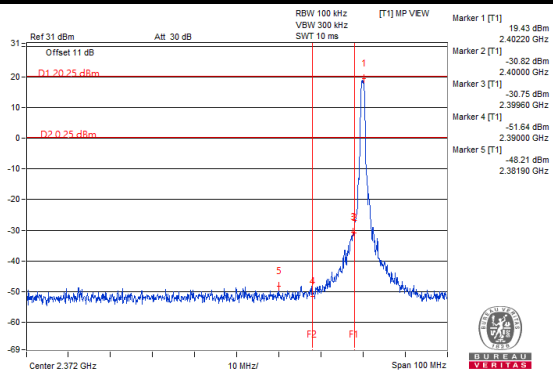

Ch 1 Band Edge

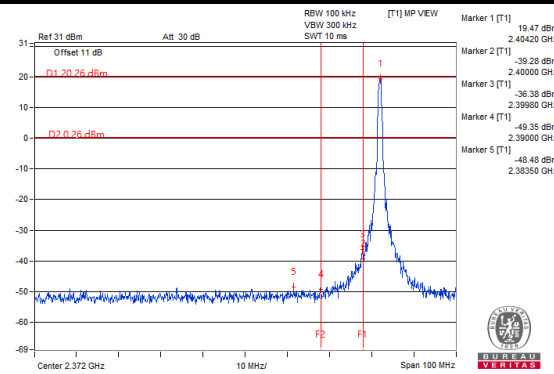

Ch 38 Band Edge

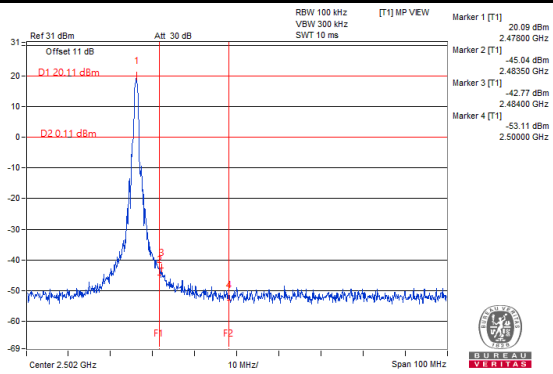

Ch 39 Band Edge

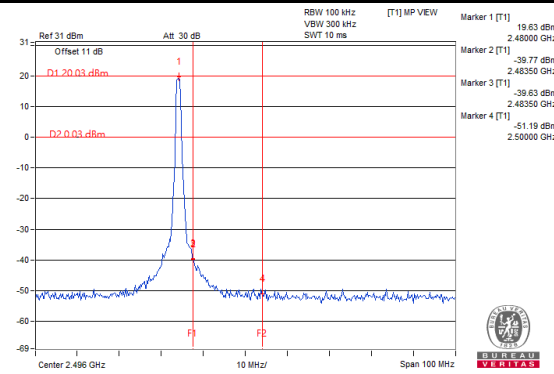

<1MBaud PHY with 125kpbs>

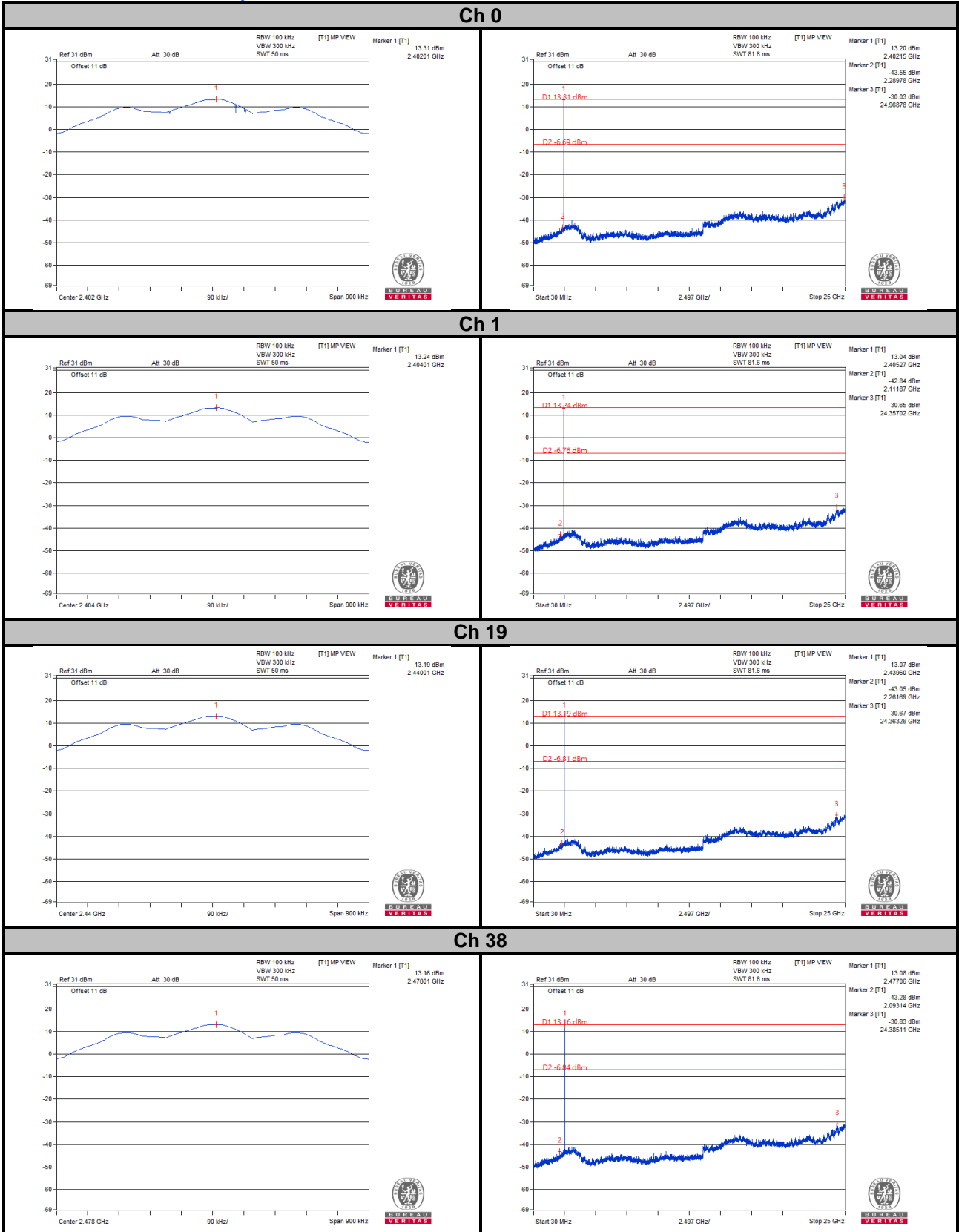

Ch 39

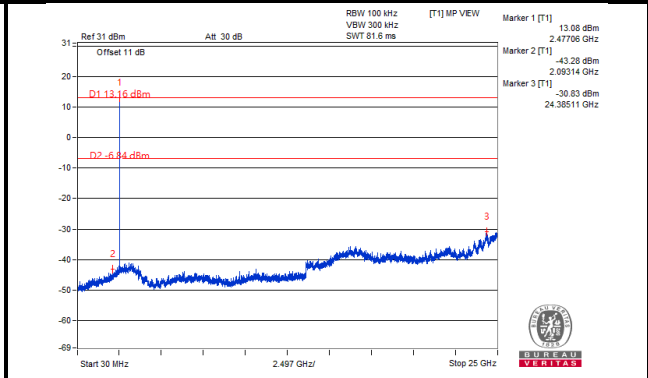
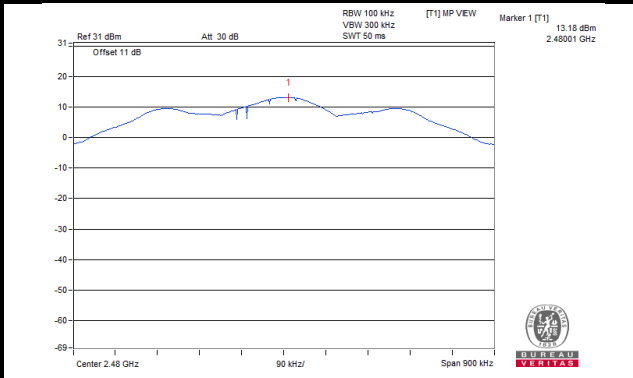

Ch 0 Band Edge

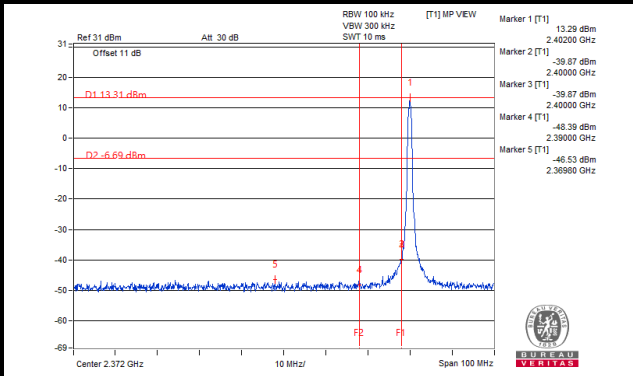

Ch 1 Band Edge

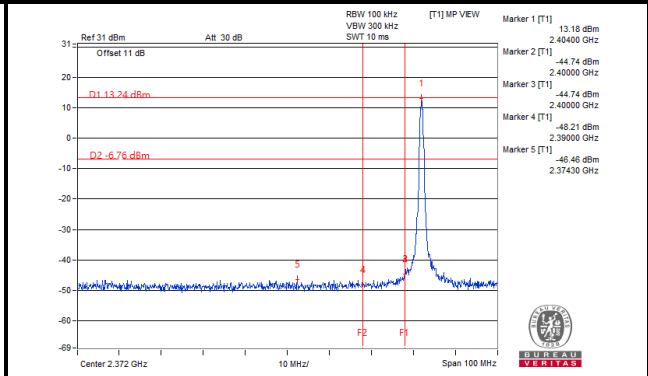

Ch 38 Band Edge

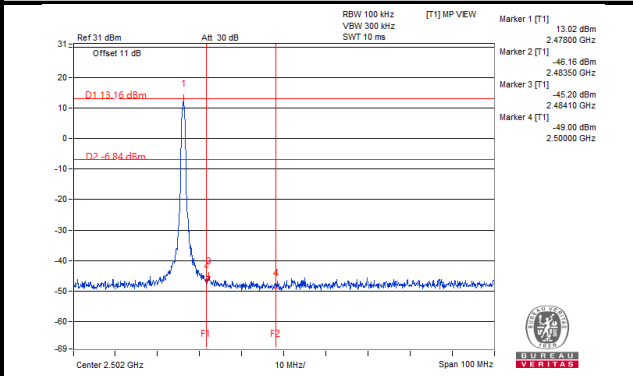

Ch 39 Band Edge

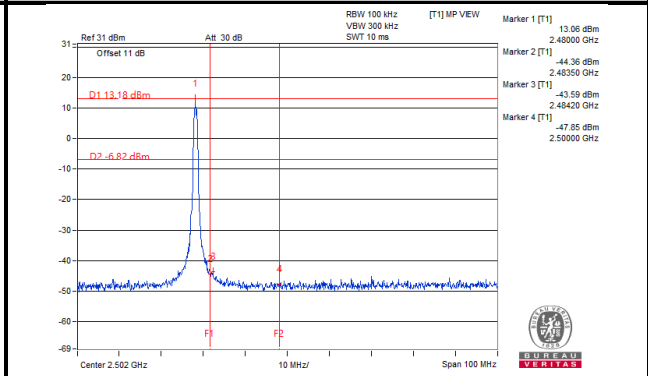

<2MBaud PHY>

Ch 1

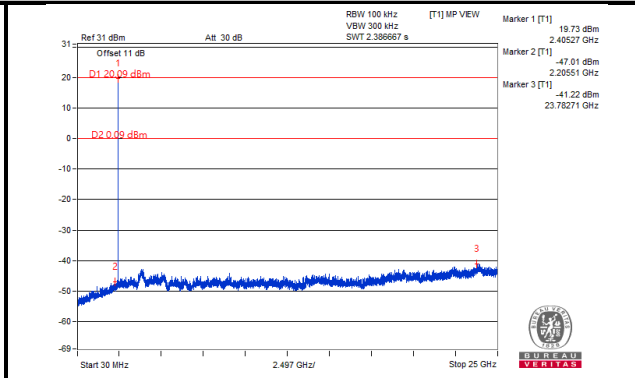
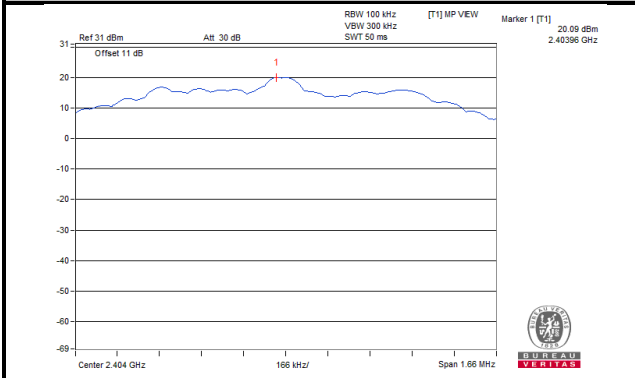

Ch 19

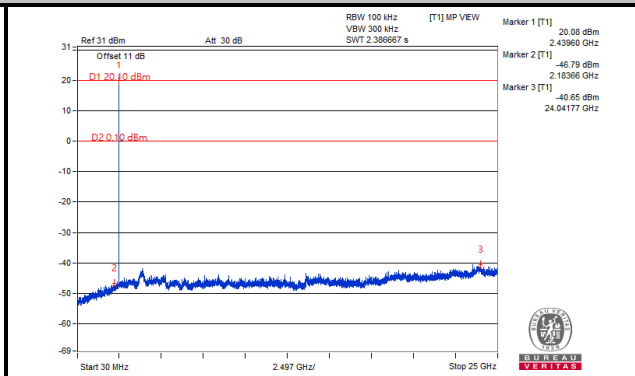
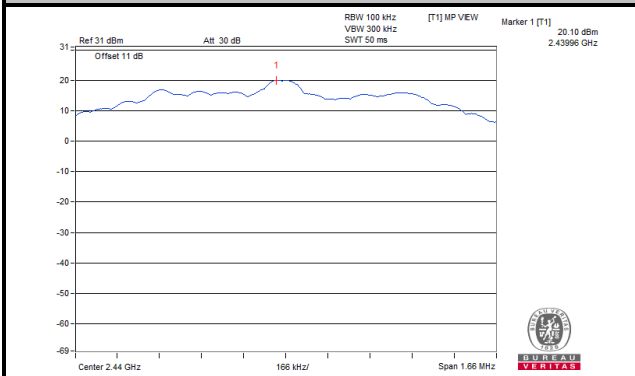

Ch 38

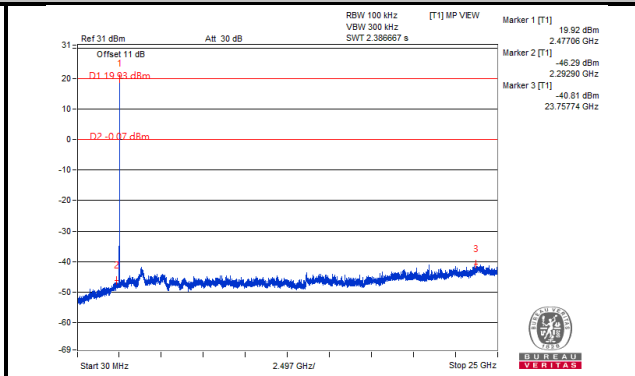
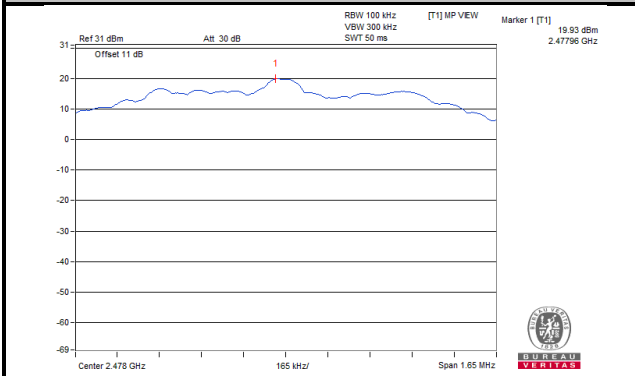

Ch 1 Band Edge

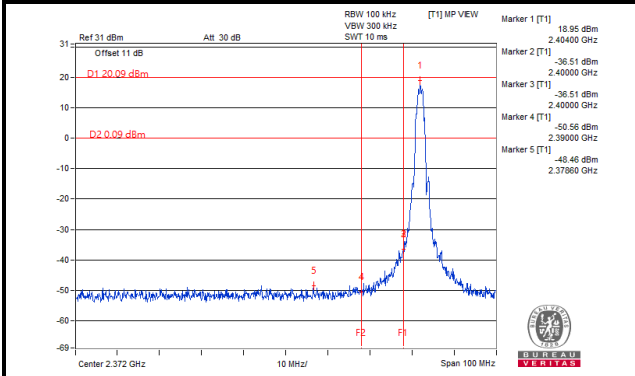

Ch 38 Band Edge

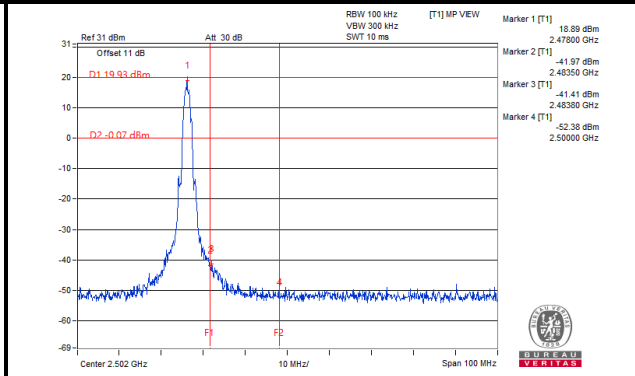

Annex A- Band Edge Measurement

Mode A

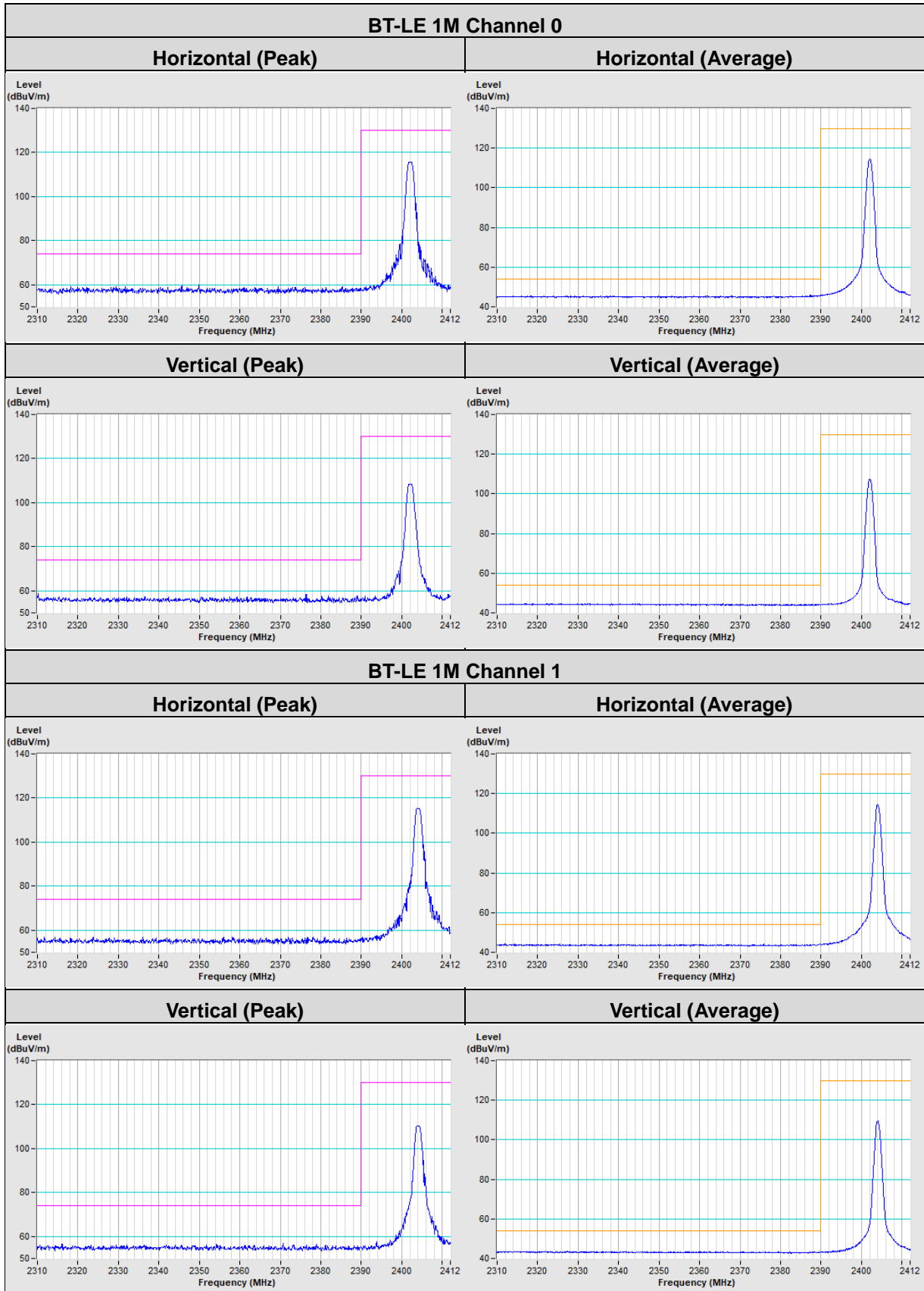

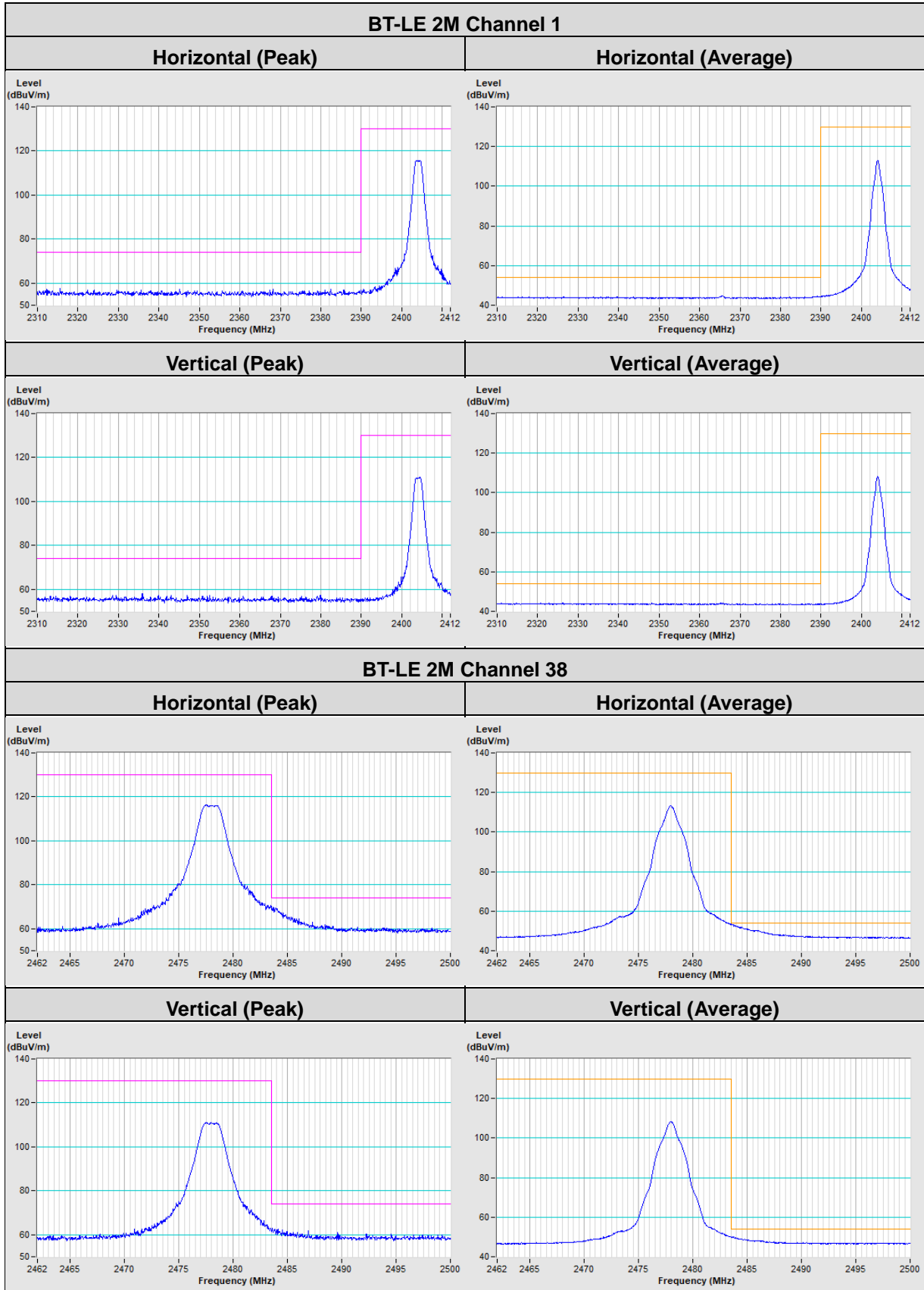

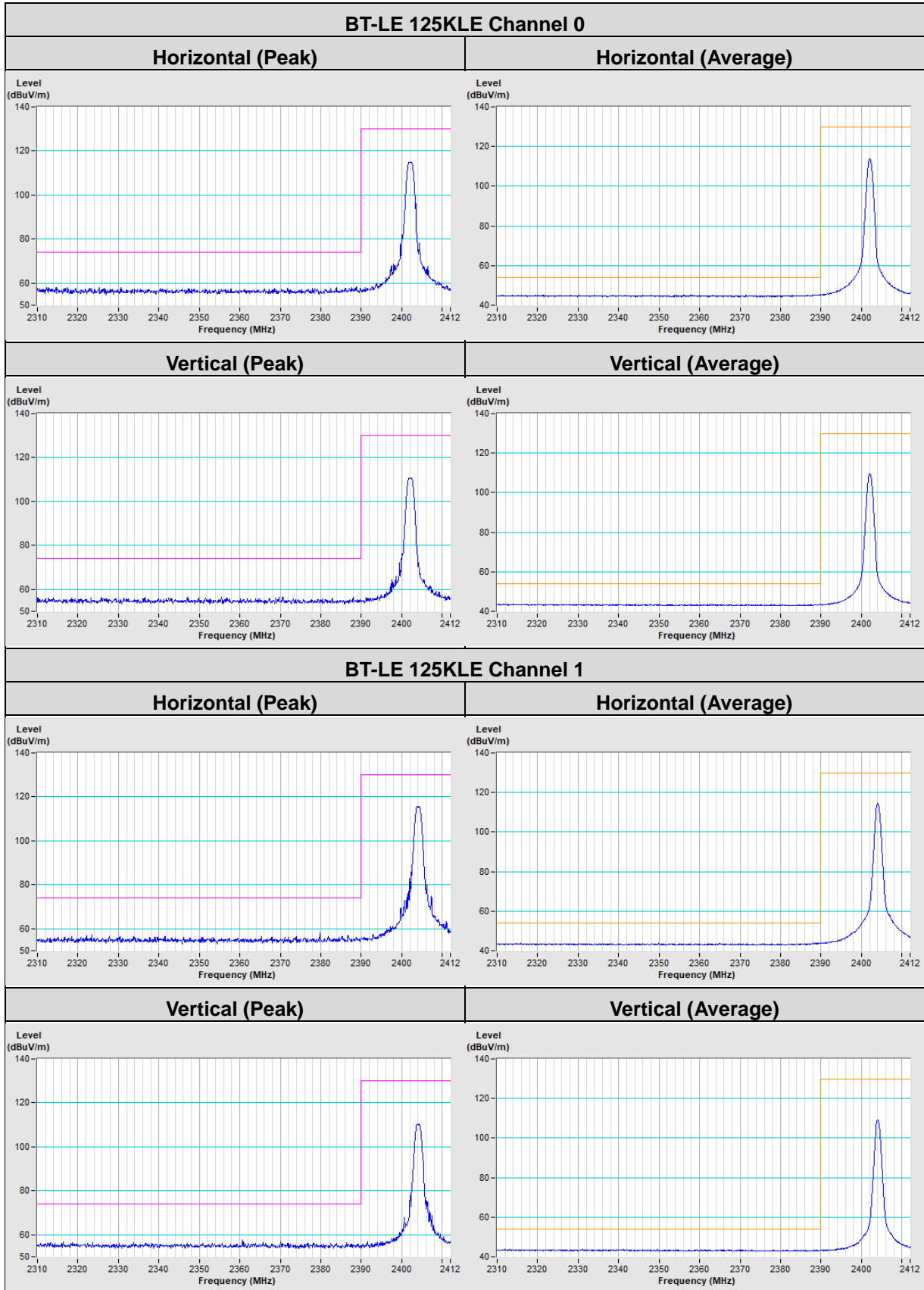

BT-LE 125KLE Channel 38

| | |
|--------------------------|-----------------------------|
| Horizontal (Peak) | Horizontal (Average) |
|--------------------------|-----------------------------|

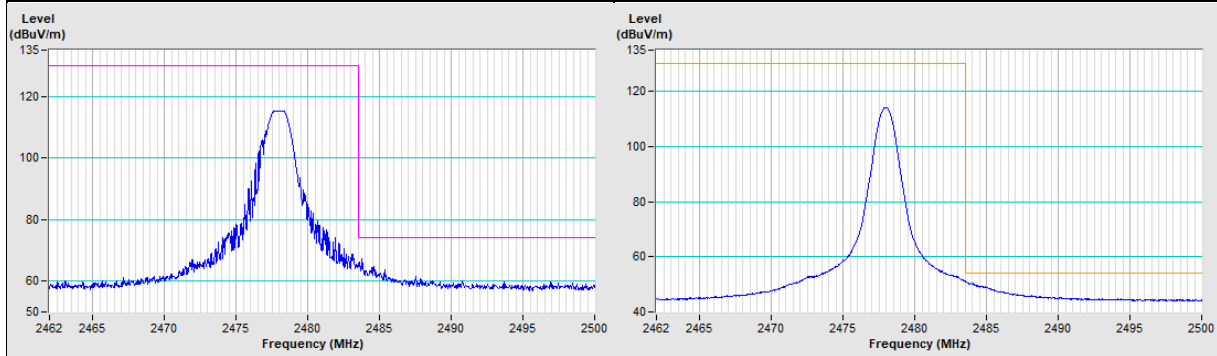

| | |
|------------------------|---------------------------|
| Vertical (Peak) | Vertical (Average) |
|------------------------|---------------------------|

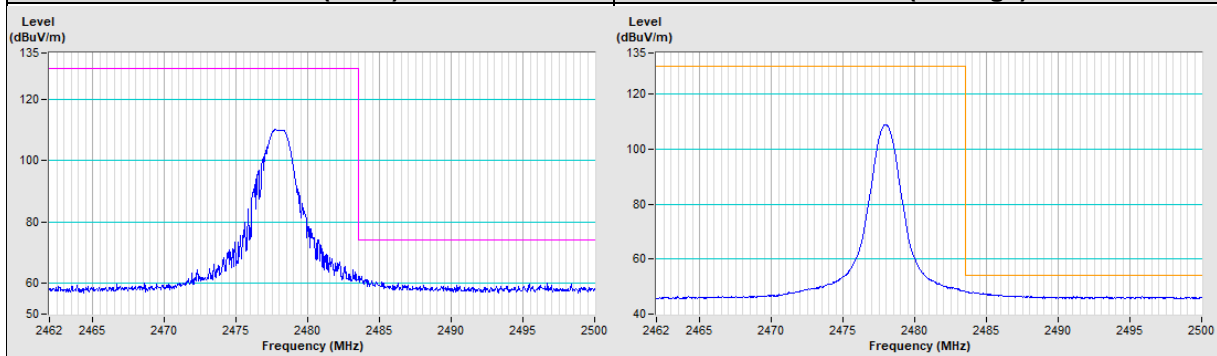

BT-LE 125KLE Channel 39

| | |
|--------------------------|-----------------------------|
| Horizontal (Peak) | Horizontal (Average) |
|--------------------------|-----------------------------|

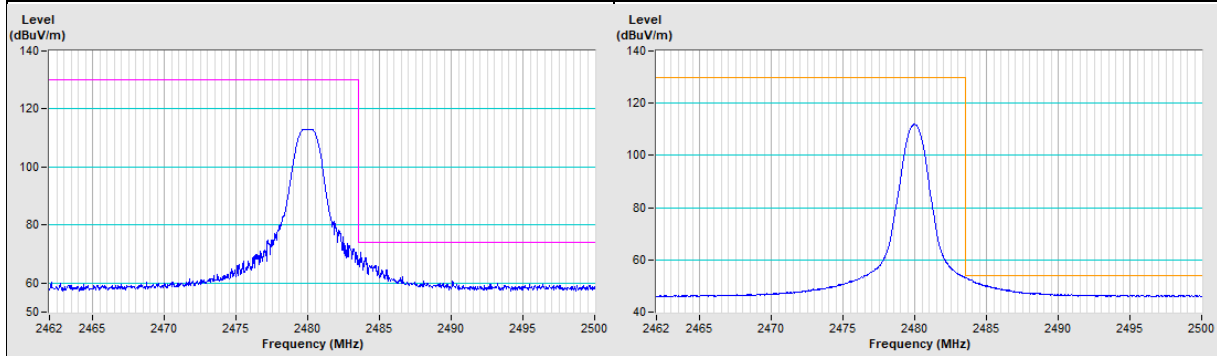

| | |
|------------------------|---------------------------|
| Vertical (Peak) | Vertical (Average) |
|------------------------|---------------------------|

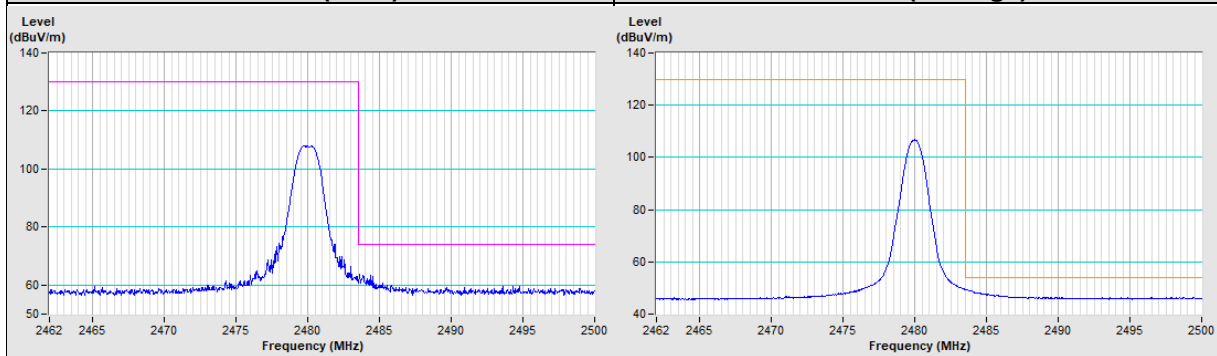

Mode B

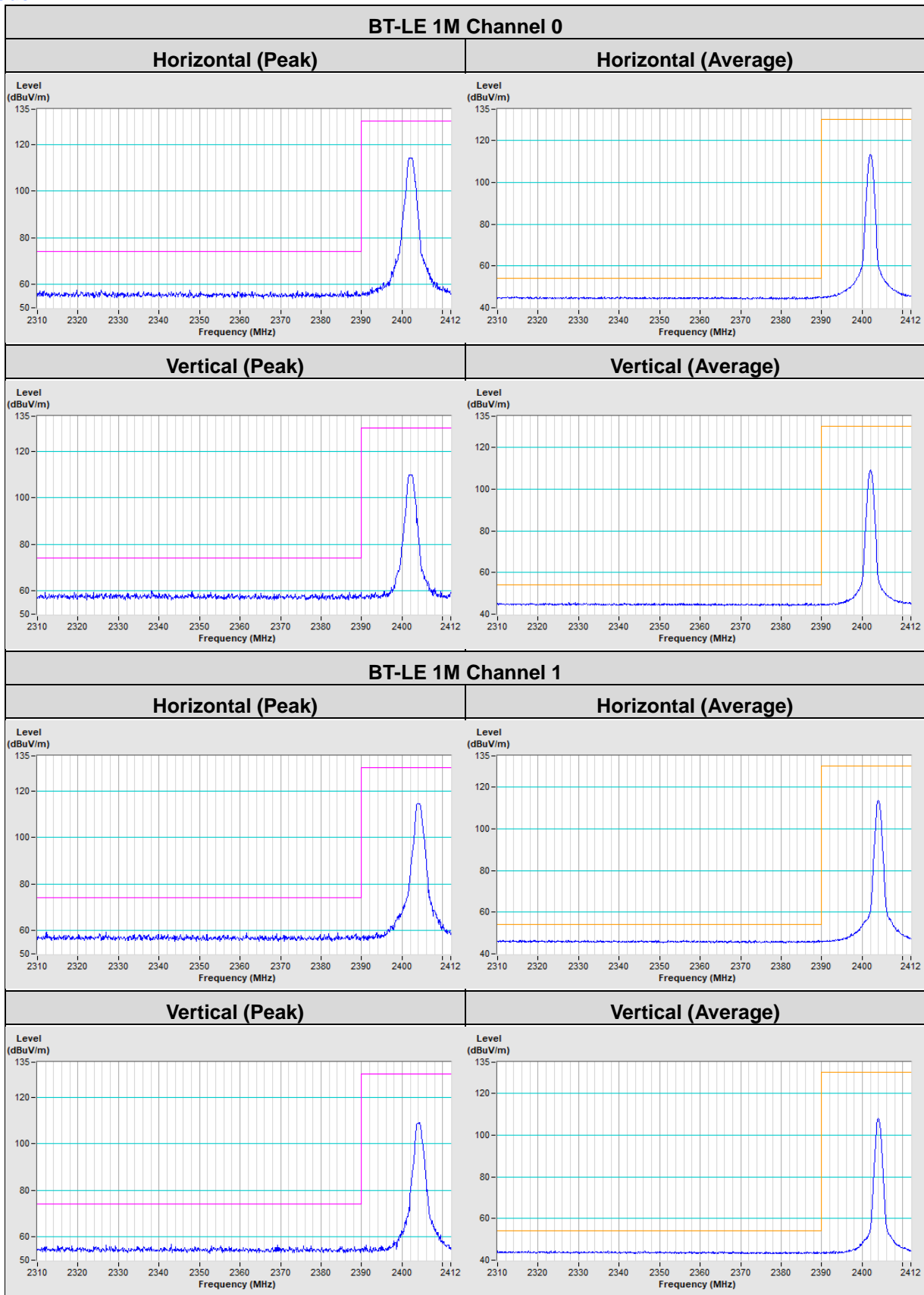

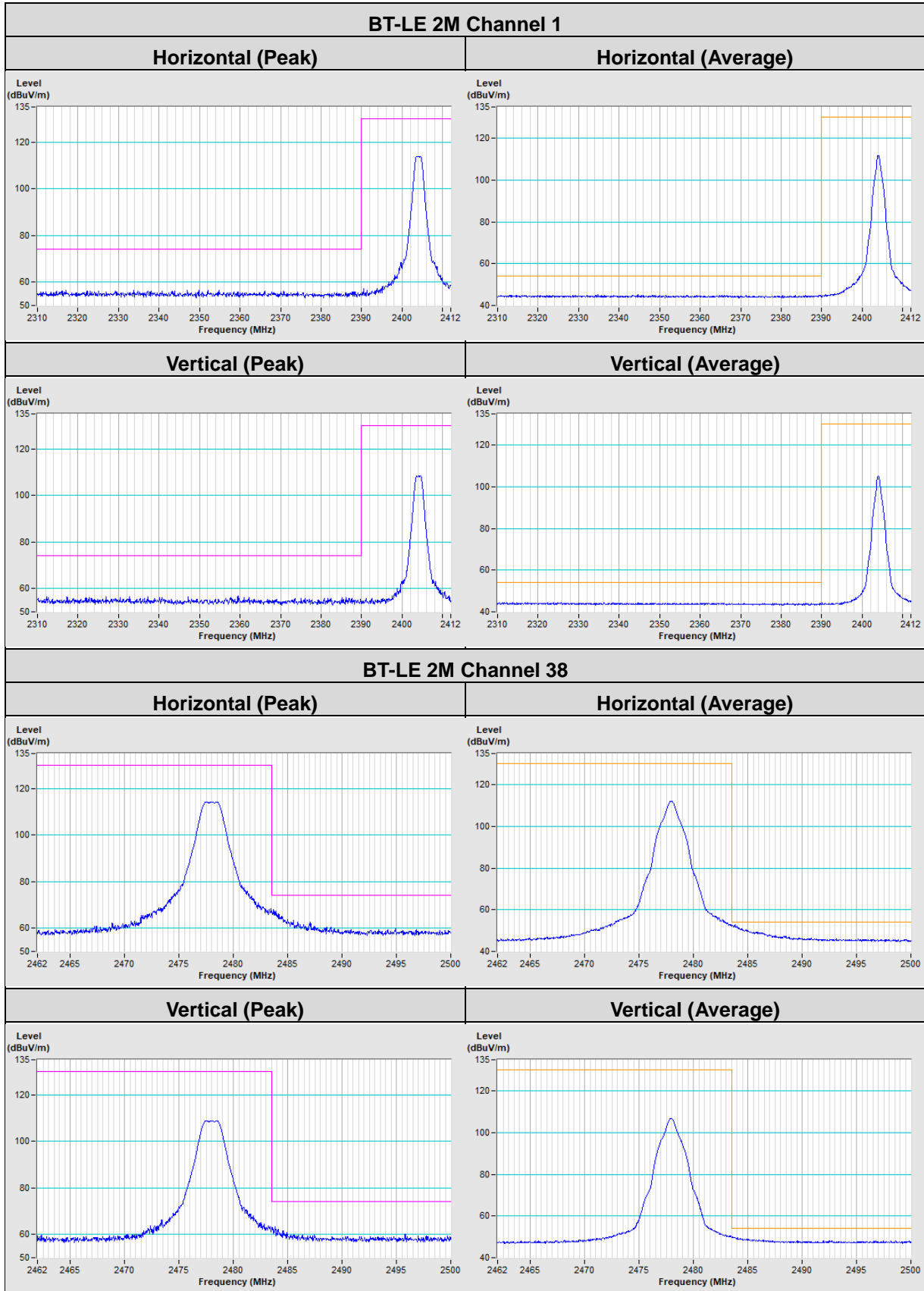

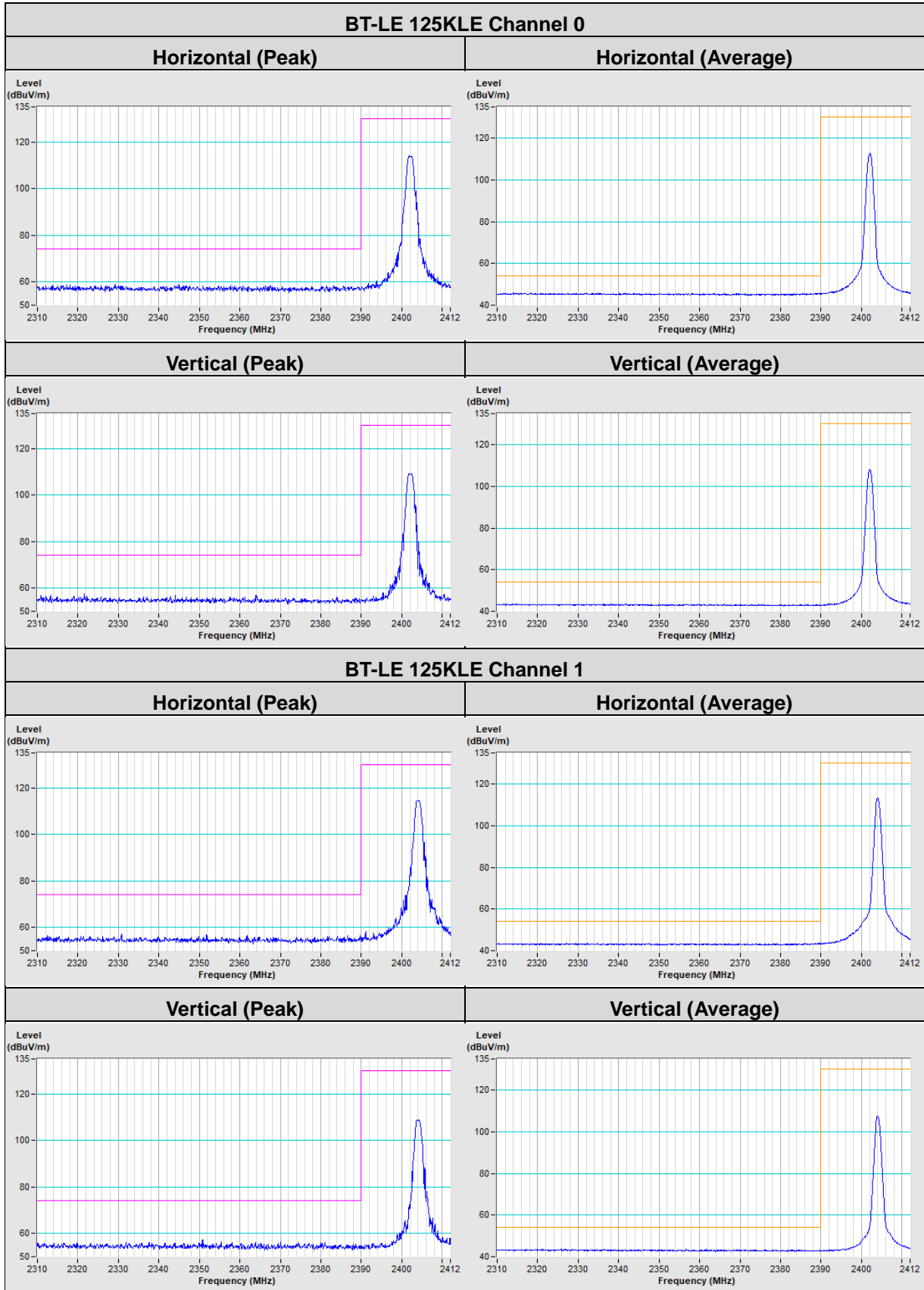

BT-LE 125KLE Channel 38

Horizontal (Peak) **Horizontal (Average)**

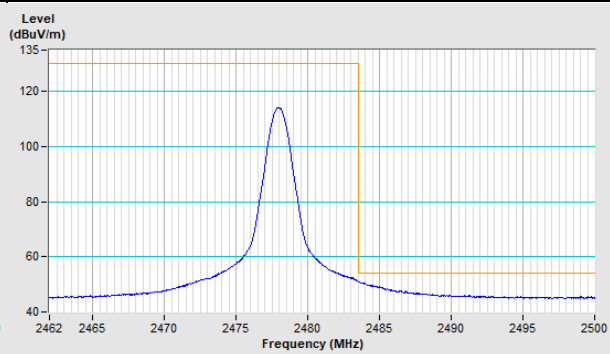
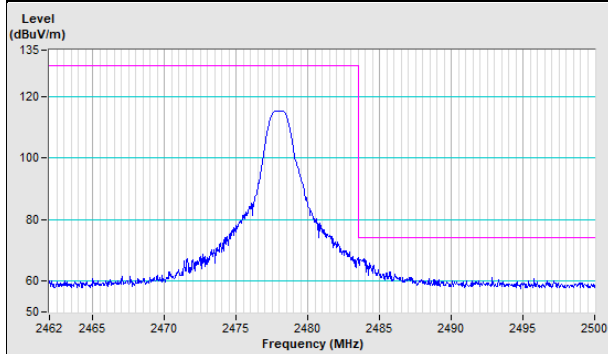

Vertical (Peak)

Vertical (Average)

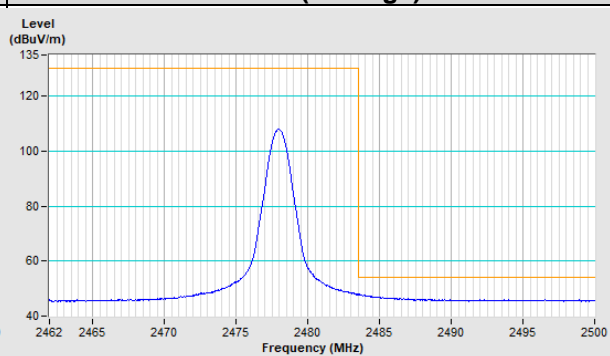
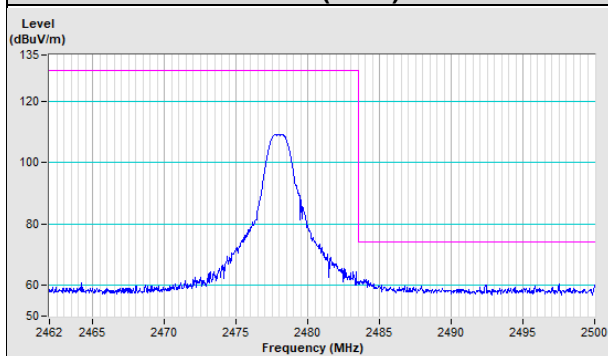

BT-LE 125KLE Channel 39

Horizontal (Peak) **Horizontal (Average)**

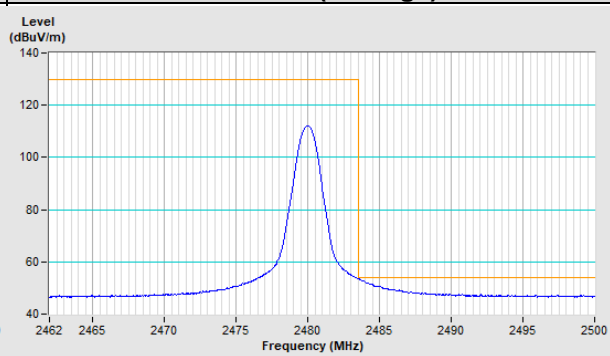
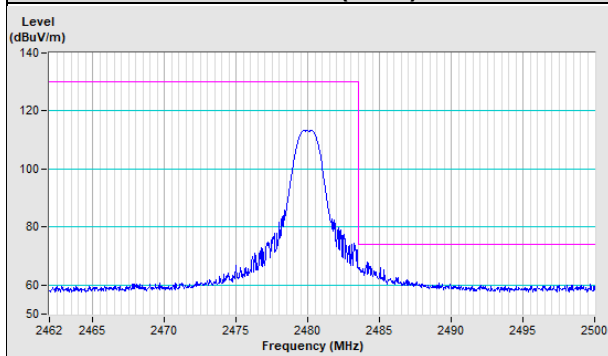

Vertical (Peak)

Vertical (Average)

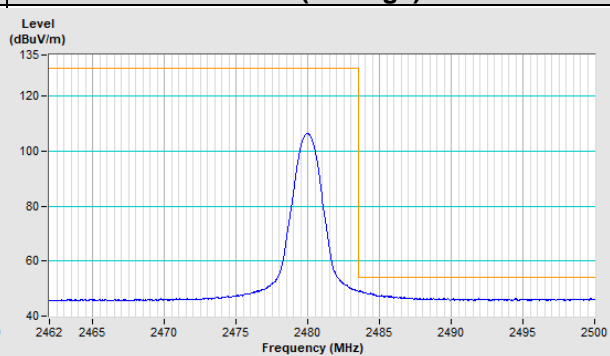
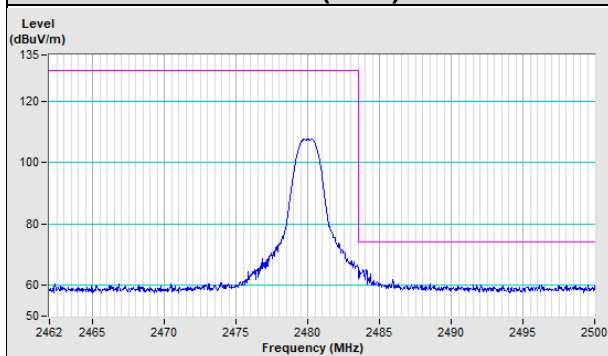

5 Pictures of Test Arrangements

Please refer to the attached file (Test Setup Photo).

Appendix – Information of the Testing Laboratories

We, Bureau Veritas Consumer Products Services (H.K.) Ltd., Taoyuan Branch, were founded in 1988 to provide our best service in EMC, Radio, Telecom and Safety consultation. Our laboratories are FCC recognized accredited test firms and accredited according to ISO/IEC 17025.

If you have any comments, please feel free to contact us at the following:

Lin Kou EMC/RF Lab

Tel: 886-2-26052180

Fax: 886-2-26051924

Hsin Chu EMC/RF/Telecom Lab

Tel: 886-3-6668565

Fax: 886-3-6668323

Hwa Ya EMC/RF/Safety Lab

Tel: 886-3-3183232

Fax: 886-3-3270892

Email: service.adt@tw.bureauveritas.com

Web Site: www.bureauveritas-adt.com

The address and road map of all our labs can be found in our web site also.

--- END ---