

Wireless External Antenna for 2.4 GHz Applications

Pulse Part Number: W1030

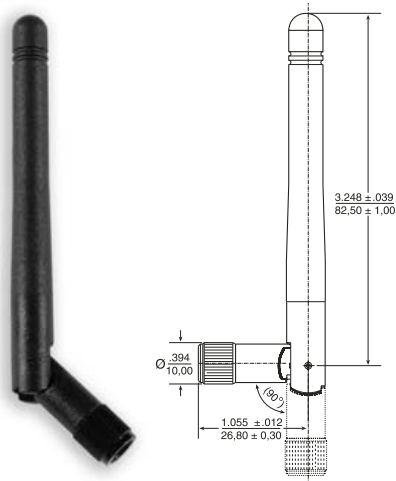

Features

- Shortest antennas in product line
- For WLAN devices using WiFi (802.11b/g), Bluetooth® and ZigBee™
- Omni-directional radiation pattern provides broad 360° coverage
- One-quarter wavelength dipole configuration
- Connection options easily integrate with OEM designs

Connector Options

- Reverse SMA (Male)*
- SMA (Male)

* Default Configuration – Please contact Pulse Applications Engineering for assistance in ordering connectors

Weight.....6.3 grams
 Carton.....20/bag; 500/carton

Dimensions: $\frac{\text{Inches}}{\text{mm}}$

Unless otherwise specified, all tolerances are $\pm \frac{.010}{0.25}$

Electrical Specifications @ 25 °C

Note: This part number is lead-free and RoHS compliant. No additional suffix or identifier is required.

Antenna Part No.	Frequency [GHz]	Gain [dBi]	Impedance [Nom]	VSWR	Polarization	Electrical Length	Radiation
W1030	2.4 – 2.5	2.0	50 Ω	≤ 2.0	Vertical	1/4, dipole	Omni

Pulse Antennas

Takatie 6
 90440 Kempele
 Finland
 Tel: +358 207 935 500
www.pulseeng.com/antennas

External Antennas Sales Contacts

USA 858 674 8100
 UK 44 1483 401 700
 France 33 3 84 35 04 04
 Singapore 65 6287 8998

Shanghai 86 21 32181071
 China 86 769 5538070
 Taiwan 886 2 26980228



Wireless External Antenna for 2.4 GHz Applications

Pulse Part Number: W1030

Application Notes

Omni-directional antennas provide a uniform, donut-shaped, 360° radiation pattern. The omni-directional pattern is suitable for point-to-multipoint broadcasting in all directions. This antenna is primarily used for WLAN

applications. However, it can also be used for a variety of other applications within the specified frequency range. When used as an access point, the antenna is ideally located at the center of the coverage area.

Gain Performance W1030

Horizontal Position

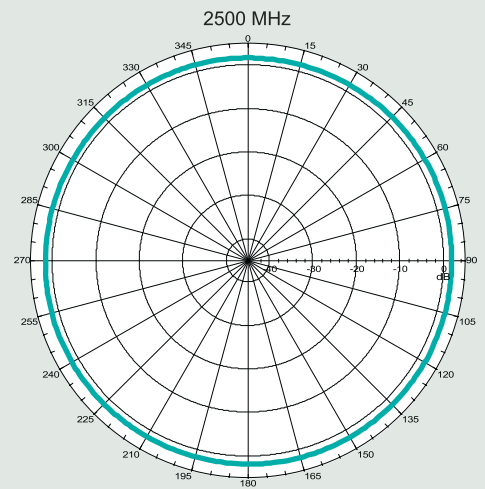
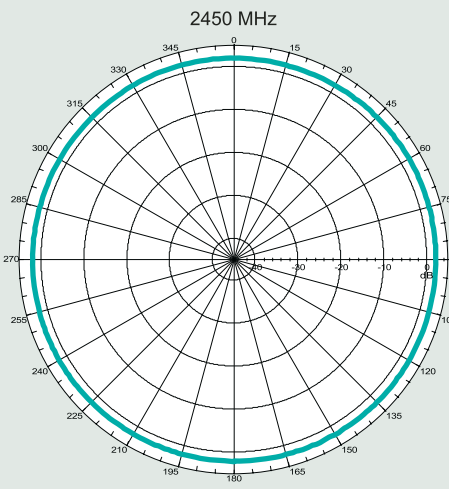
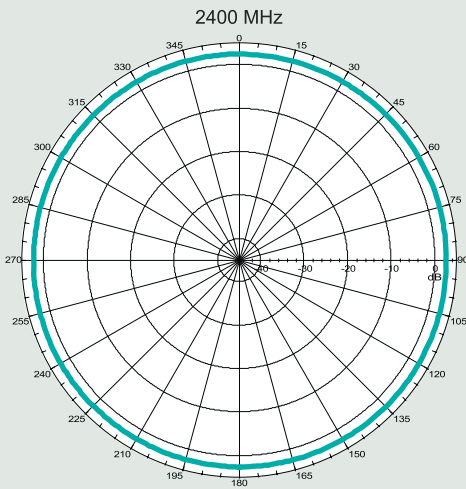

Vertical Position

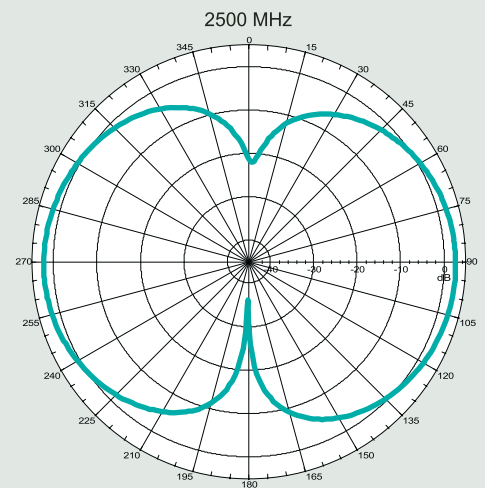
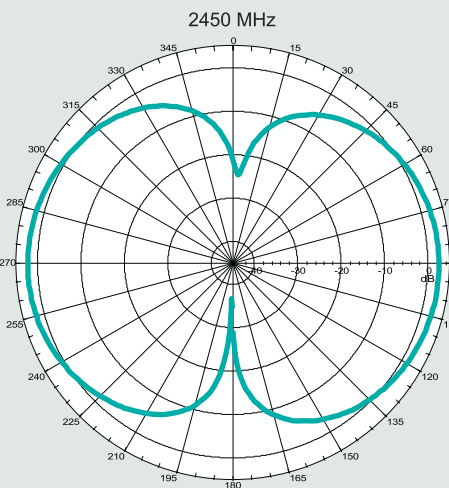
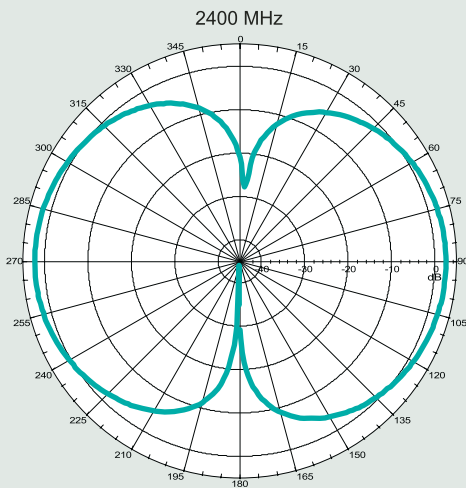

Pulse Antennas

Takatie 6
90440 Kempele
Finland
Tel: +358 207 935 500
www.pulseeng.com/antennas

External Antennas

Sales Contacts

USA 858 674 8100
UK 44 1483 401 700
France 33 3 84 35 04 04
Singapore 65 6287 8998

Shanghai 86 21 32181071
China 86 769 5538070
Taiwan 886 2 26980228

