



SASKEN

Silicon Labs Antenna Measurements

Aki Myllymäki

25th May 2021

Introduction

- In this document, measurement results are presented for the antenna of a module in a validation and certification board received from Silicon Laboratories:
 - Module 1 → xGM240Px2A
- Parameters measured:
 - Efficiency (dB)
 - Peak gain (dB)
 - 3D radiation pattern
 - 1D radiation pattern (dB), Polar Mode, Phi 0, Phi 90 and Theta 90 cuts
- Measurement frequencies:
 - Peak Gain/Efficiency over frequency 2000 - 3000 MHz, 20MHz steps
 - Gain patterns: 2402, 2440, 2480MHz
- In all measurements, module was placed in the same position and orientation as shown in the picture on right side.
- Antenna type: loop type ground radiation antenna

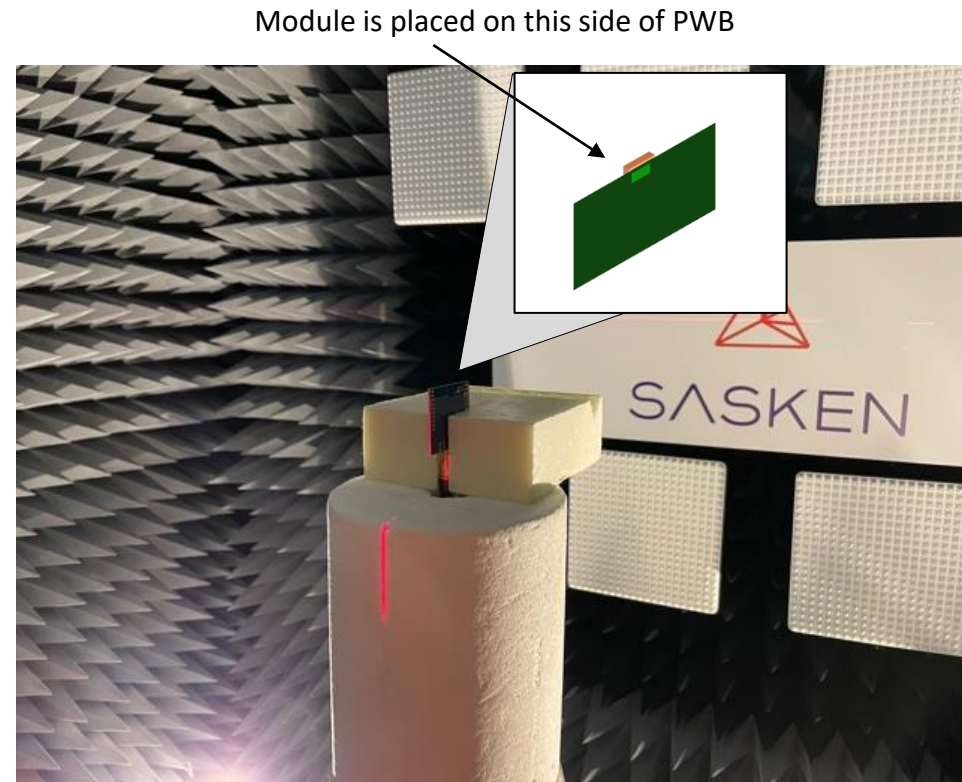

Module with antenna under test

Module 1 (xGM240Px2A)

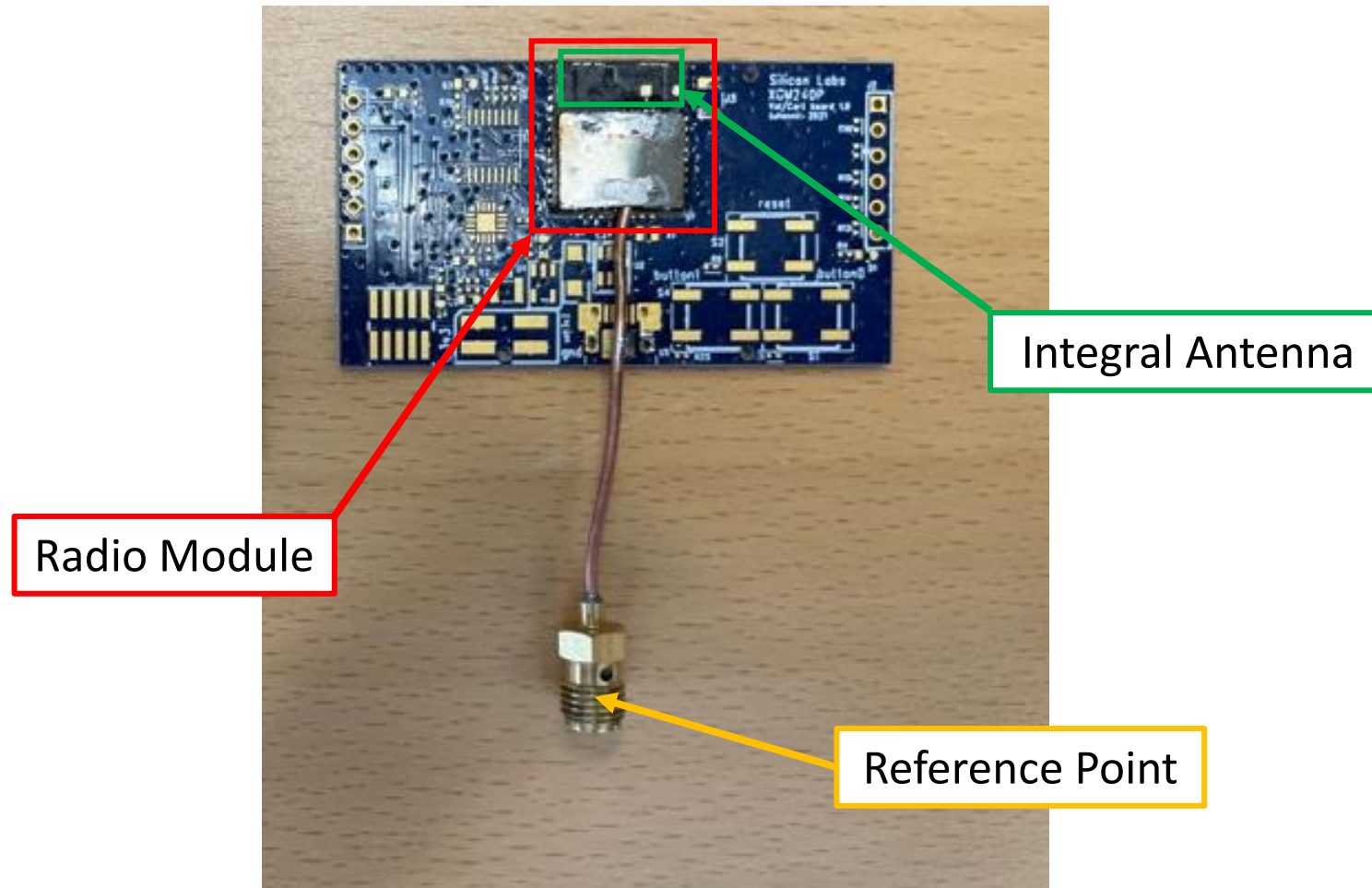

Sasken coordinate system

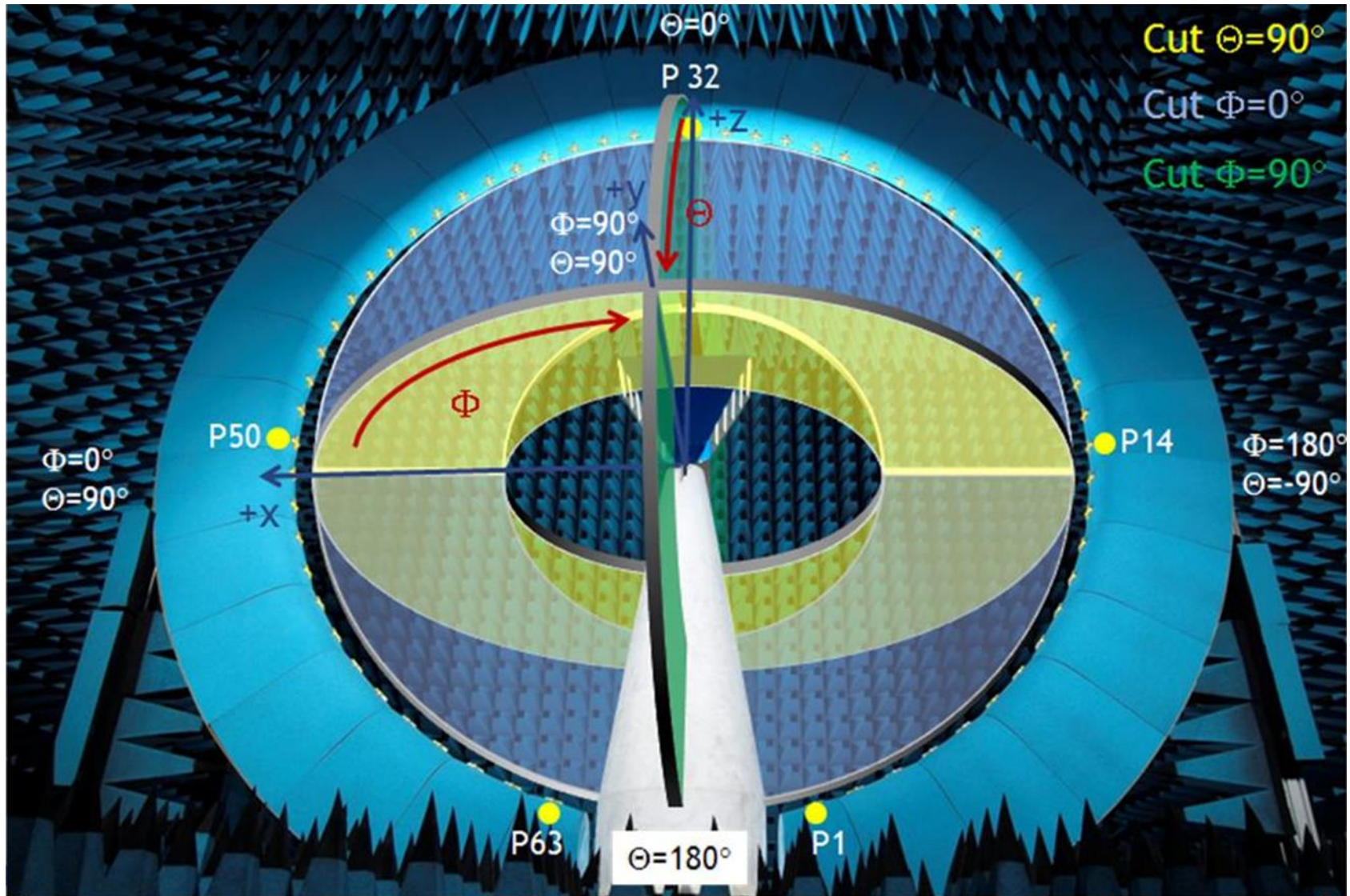

Satimo SG64 Setup

- SG64 has been developed to measure stand alone antennas or antennas integrated in subsystem. It is also ideal for CTIA certifiable measurement facilities.
- SG system can switch between the Probe Array Controller (PAC) for passive measurements and the Radio Communication Tester for active measurements.
 - For passive measurements it uses Analog RF Signal Generators for emitting from the probe array to the Antenna Under Test or from the Antenna Under Test to the probe array. The PAC is also a RF receiver for antenna measurements. The PAC controls as well the electronic scanning of the probe array. The Amplification Unit has RF amplifiers for both RX and TX channels.
 - For active measurements, the test is performed with a Multi-protocol Radio Communication Tester. It is used to communicate with the DUT and to measure the Total Radiated Power (TRP) and Total Isotropic Sensitivity (TIS).

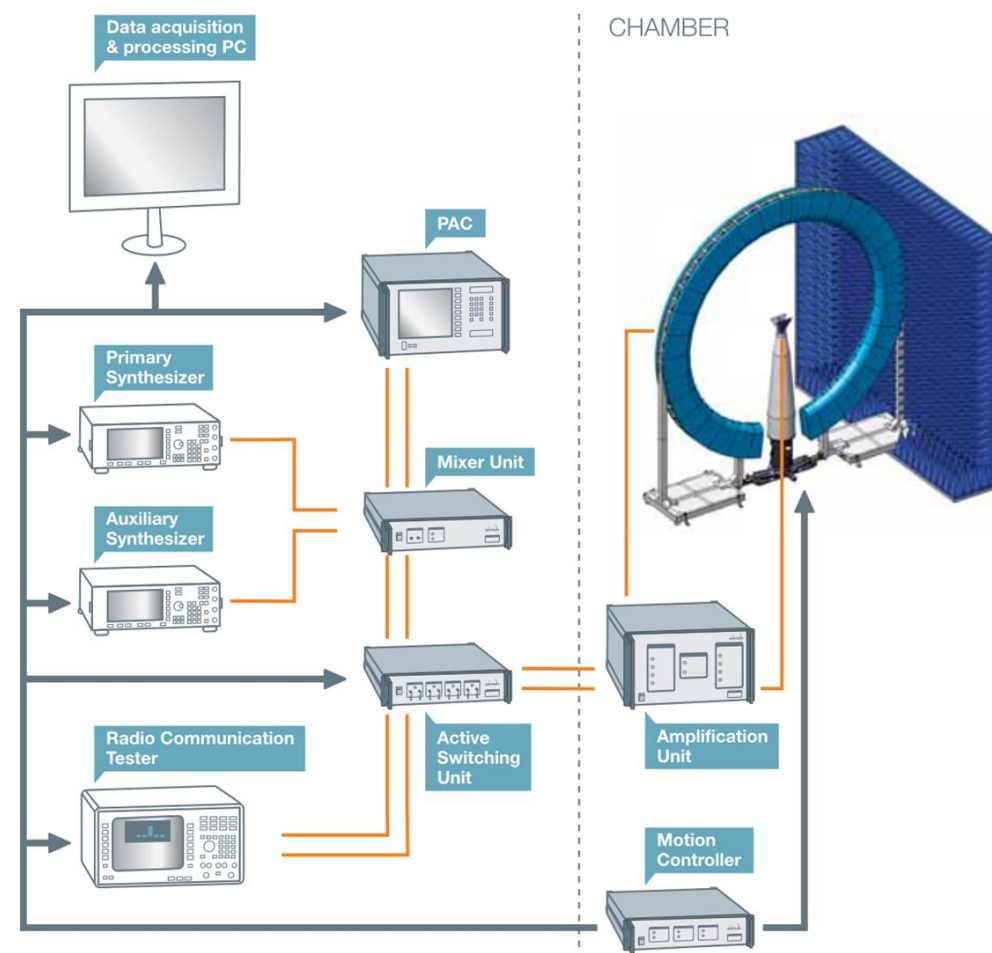

Passive Measurement Setup

- All antenna measurements were done using Satimo SG64 Passive Measurement Setup.
- Setup:
 - DUT is prepared with coaxial probe cable to be connected with antenna feed cable coming from the antenna mast on the turntable.
 - Satimo test system feeds the signal on specified frequencies through the antenna feed cable to DUT
 - The DUT is then rotated with turntable and the Satimo probe array will measure the signal from all directions for all rotation steps to get a 3D radiation pattern.
 - Near-field to far-field transformation will be then done to the measurement data.
- Calibration
 - System is calibrated to the reference point that is in the end of antenna feed cable on the antenna mast.
 - System calibration is done yearly by Satimo
 - last system calibration was done on week 37/2020
 - Measurement calibration is done with reference antennas.
 - Dual-Ridge Horn antenna SH400/S#0040 (0.4 - 6GHz)

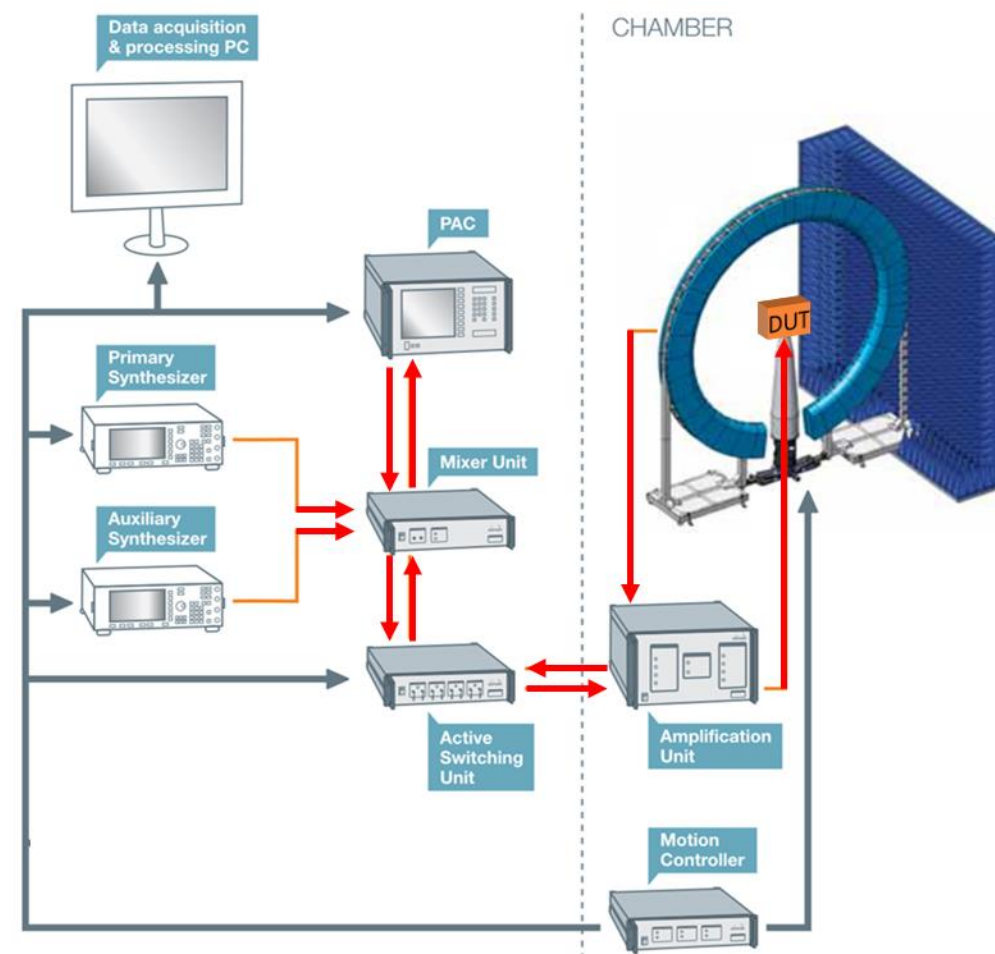

Module 1 (xGM240Px2A)

Measurement results



SASKEN

Efficiency (dB)

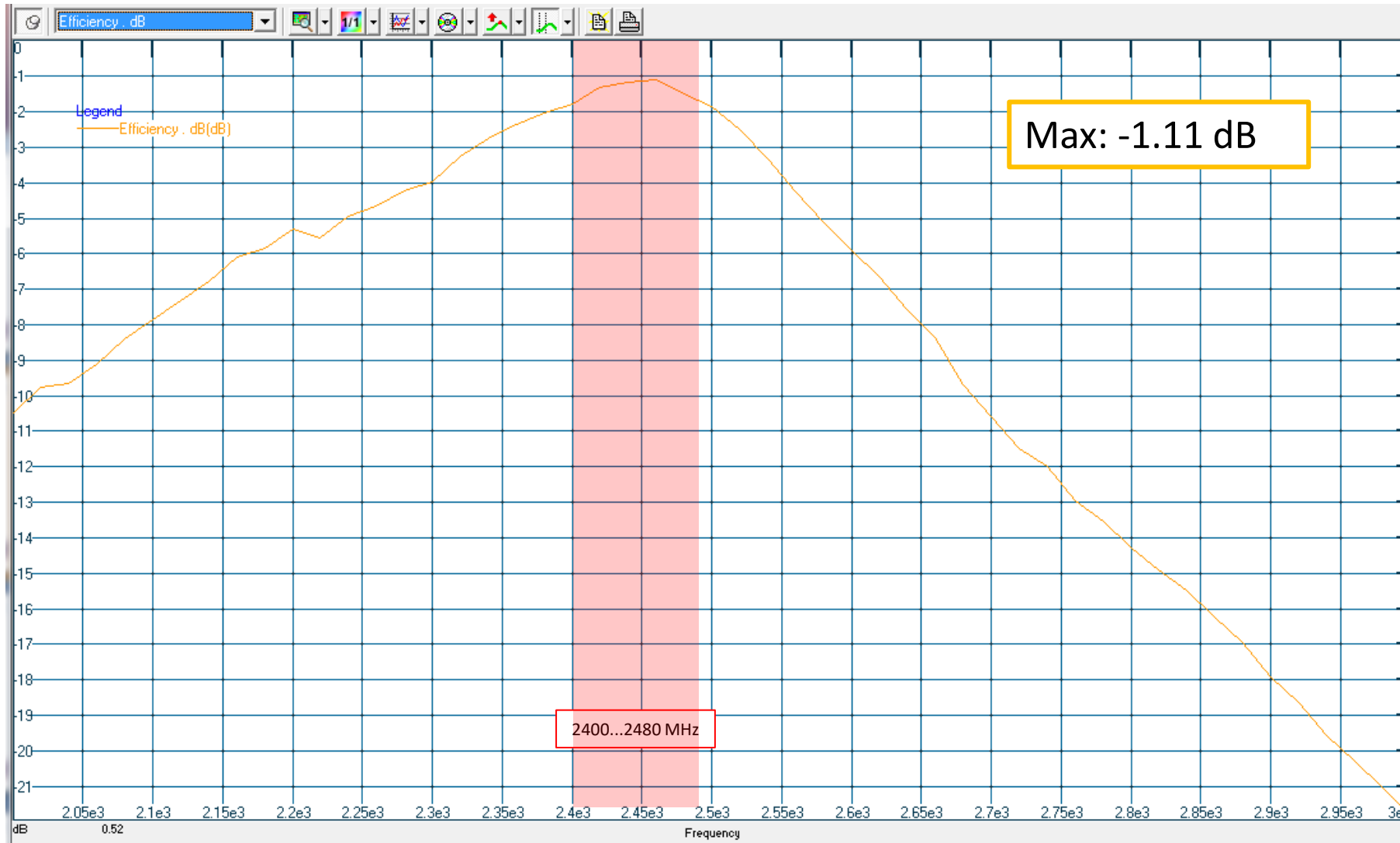

Peak Gain (dBi)

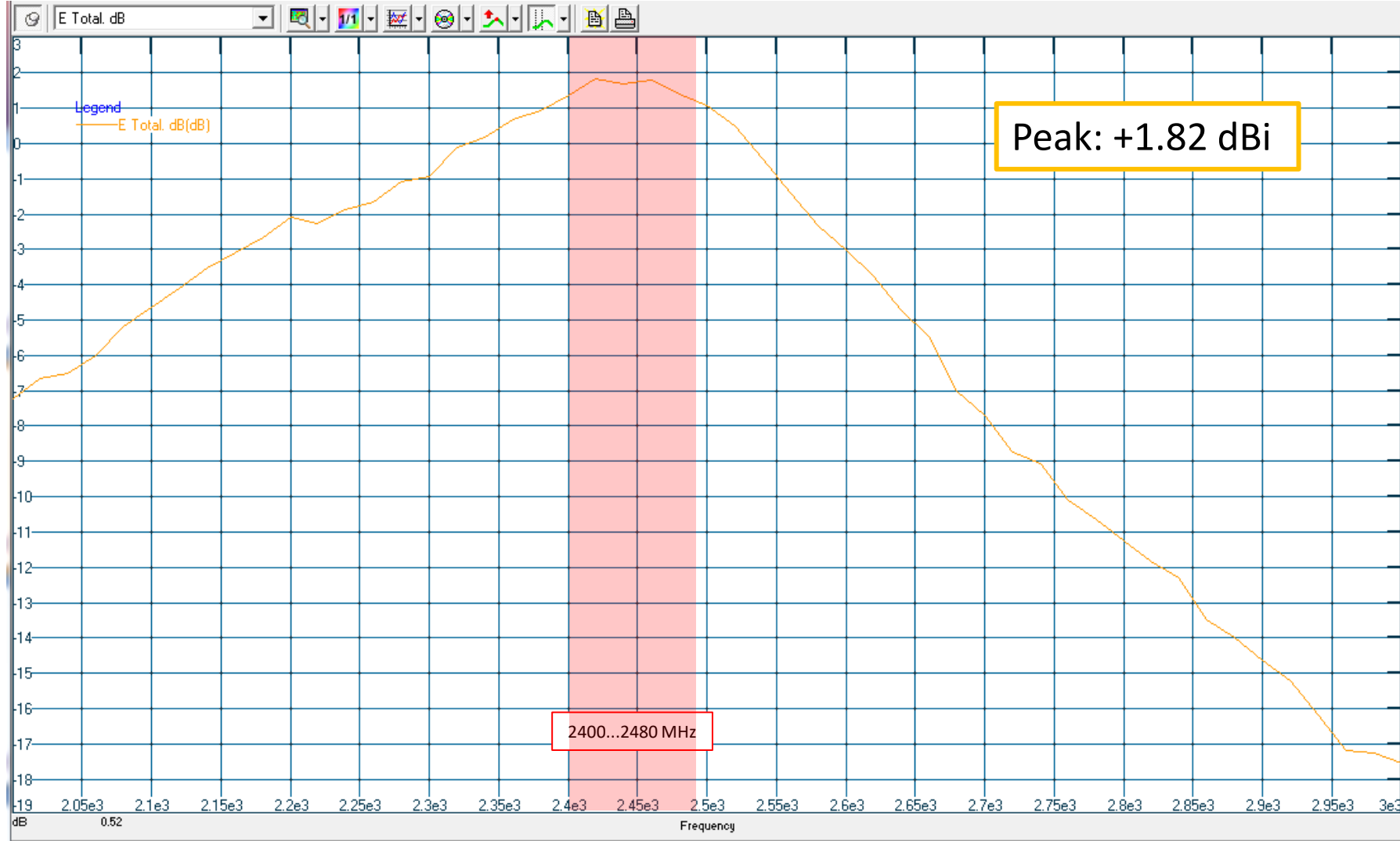

3D gain pattern @ 2402MHz, View 1

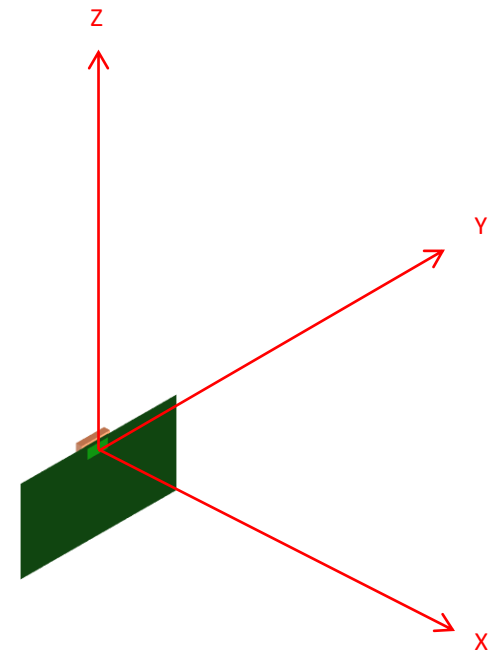
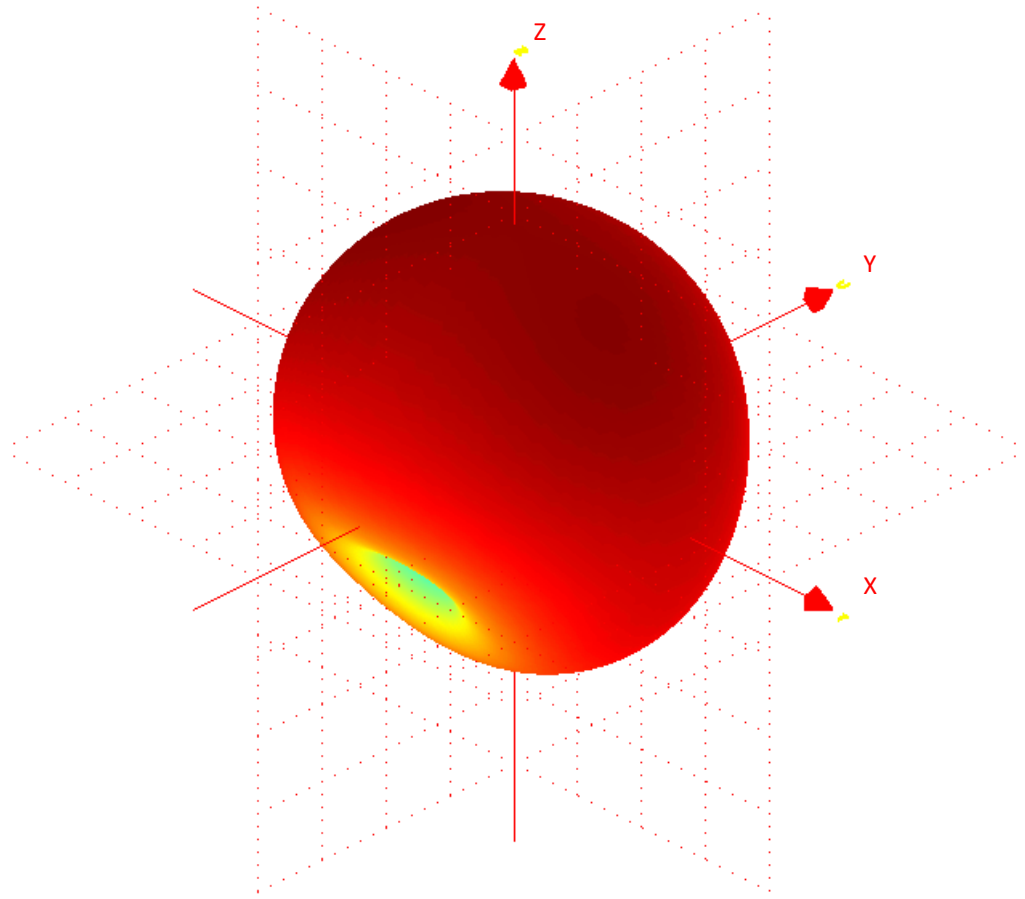

3D gain pattern @ 2402MHz, View 2

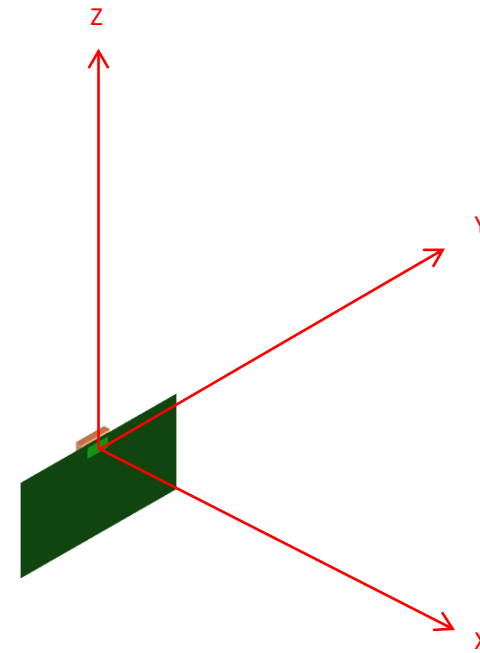
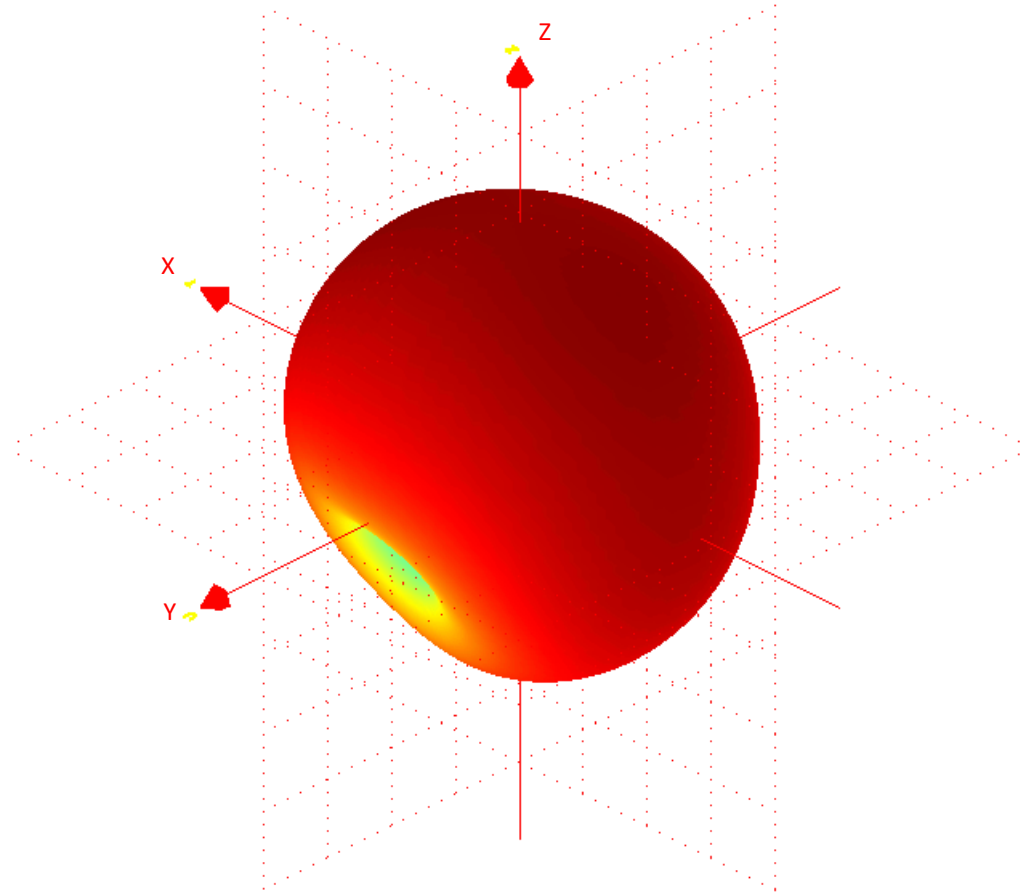

3D gain pattern @ 2440MHz, View 1

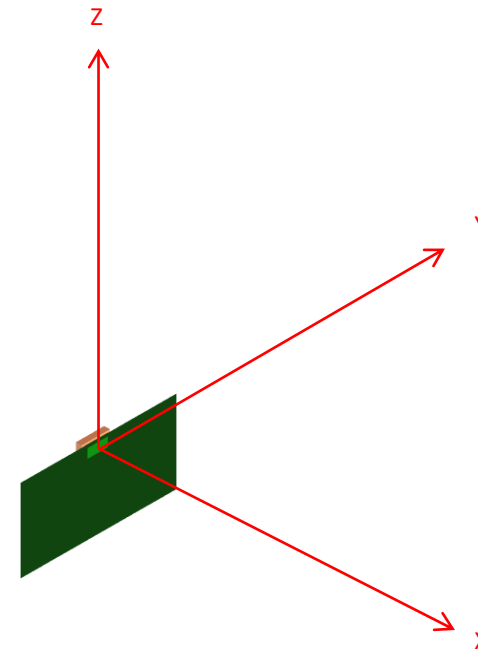
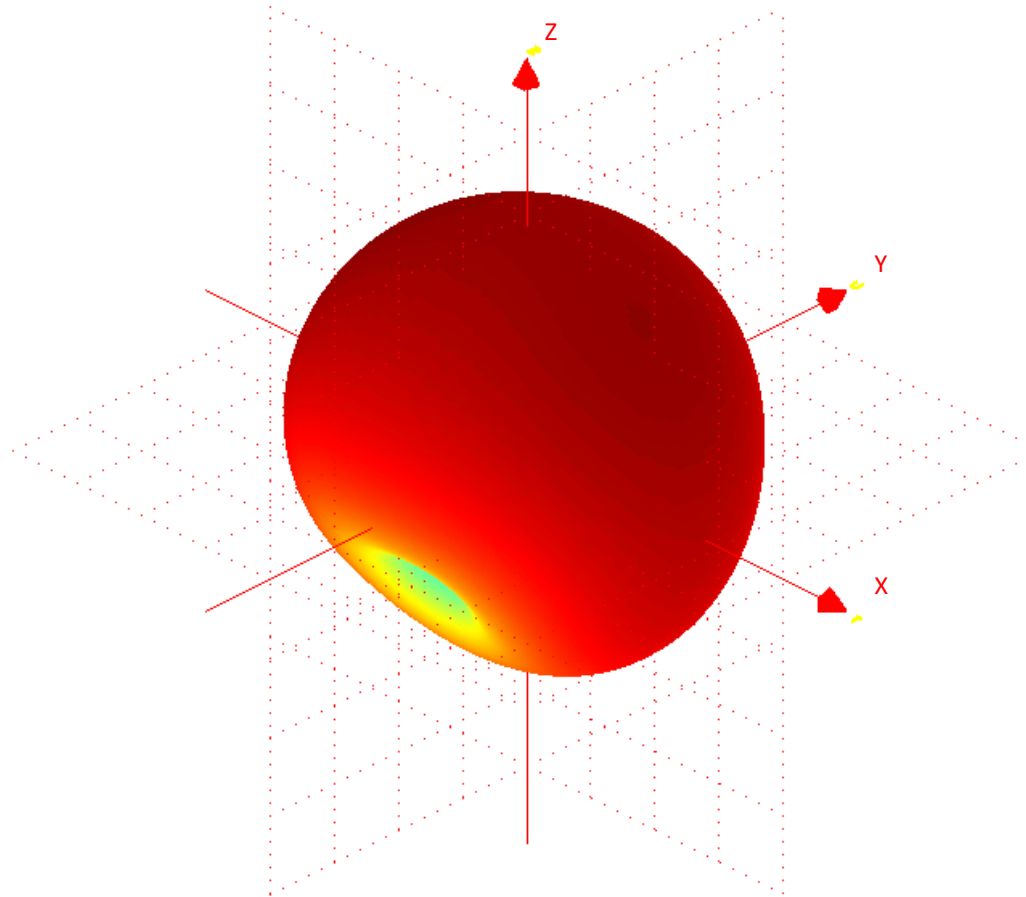

3D gain pattern @ 2440MHz, View 2

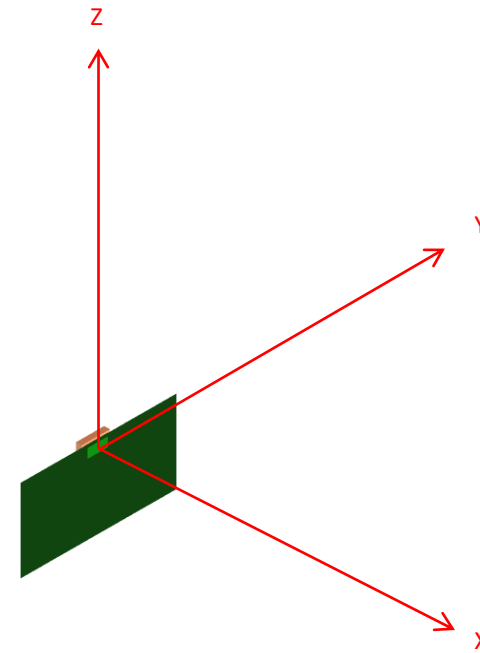
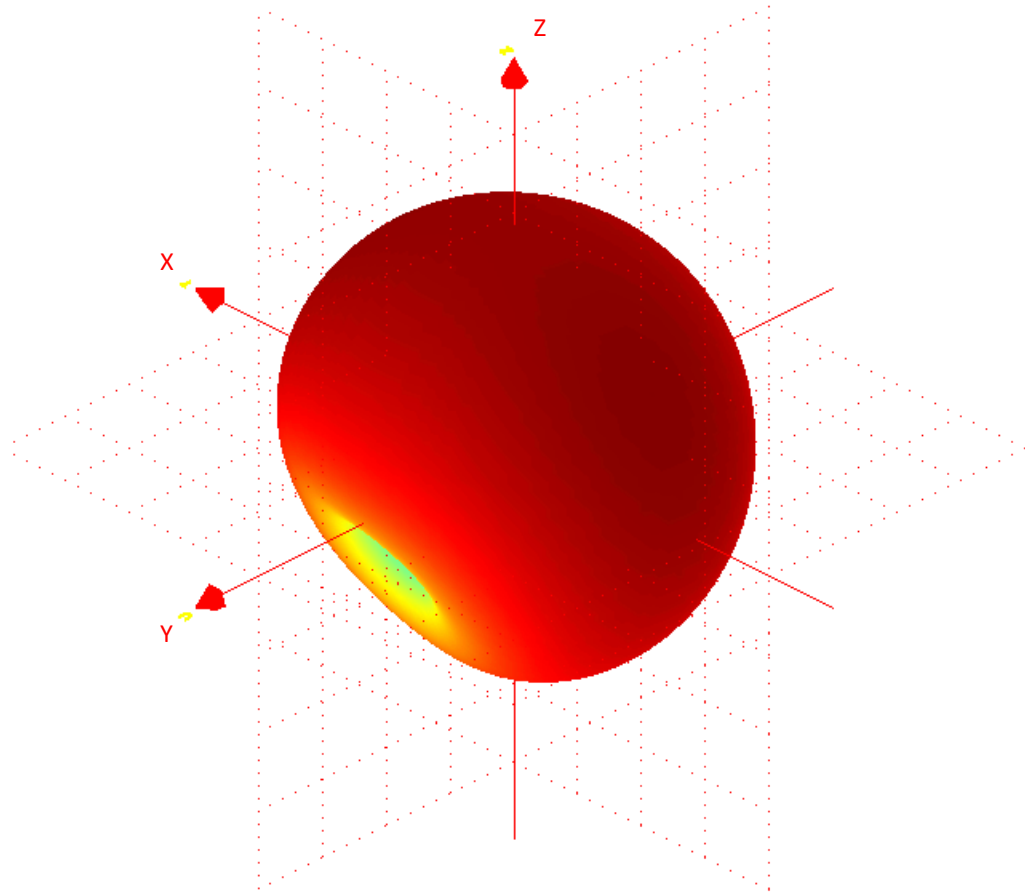

3D gain pattern @ 2480MHz, View 1

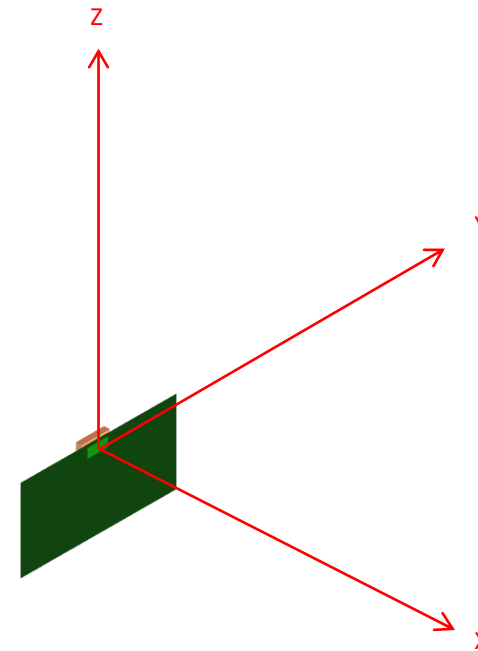
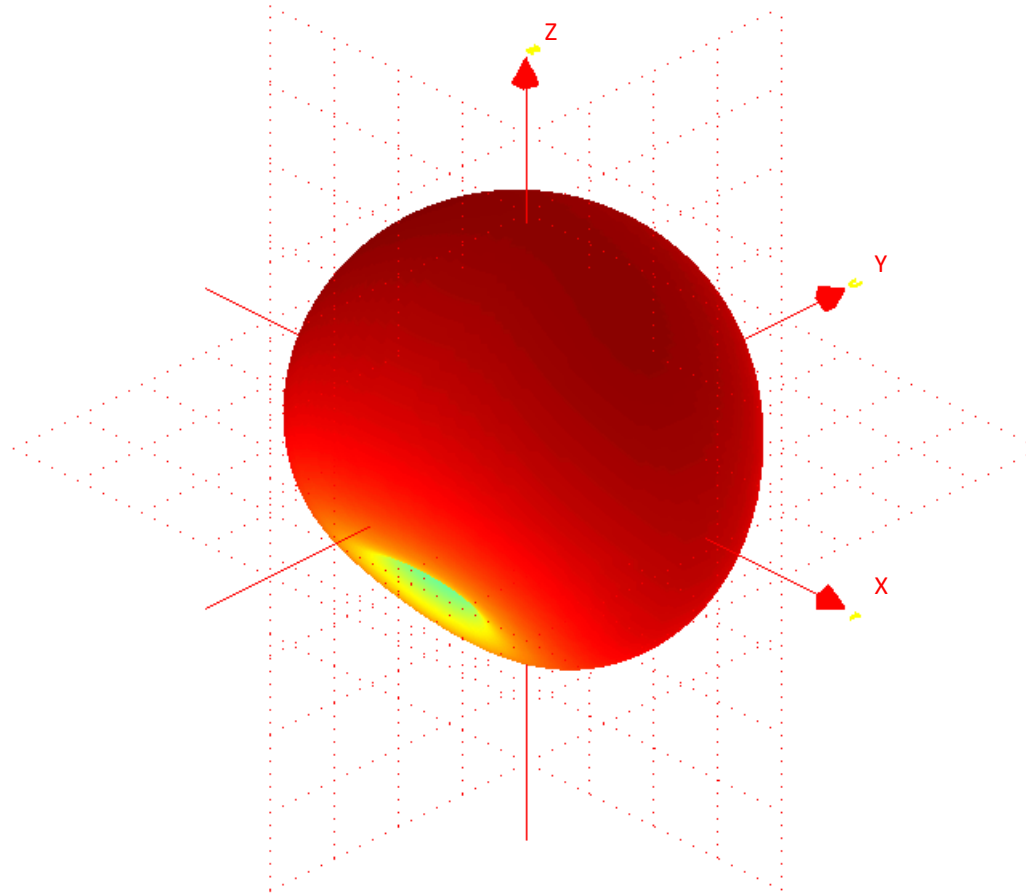

3D gain pattern @ 2480MHz, View 2

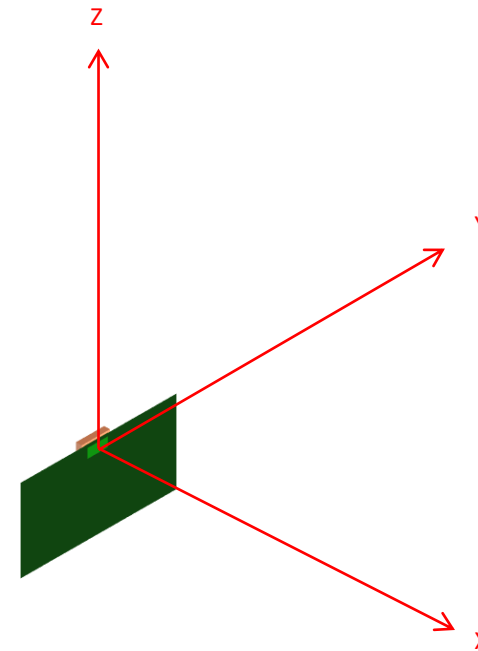
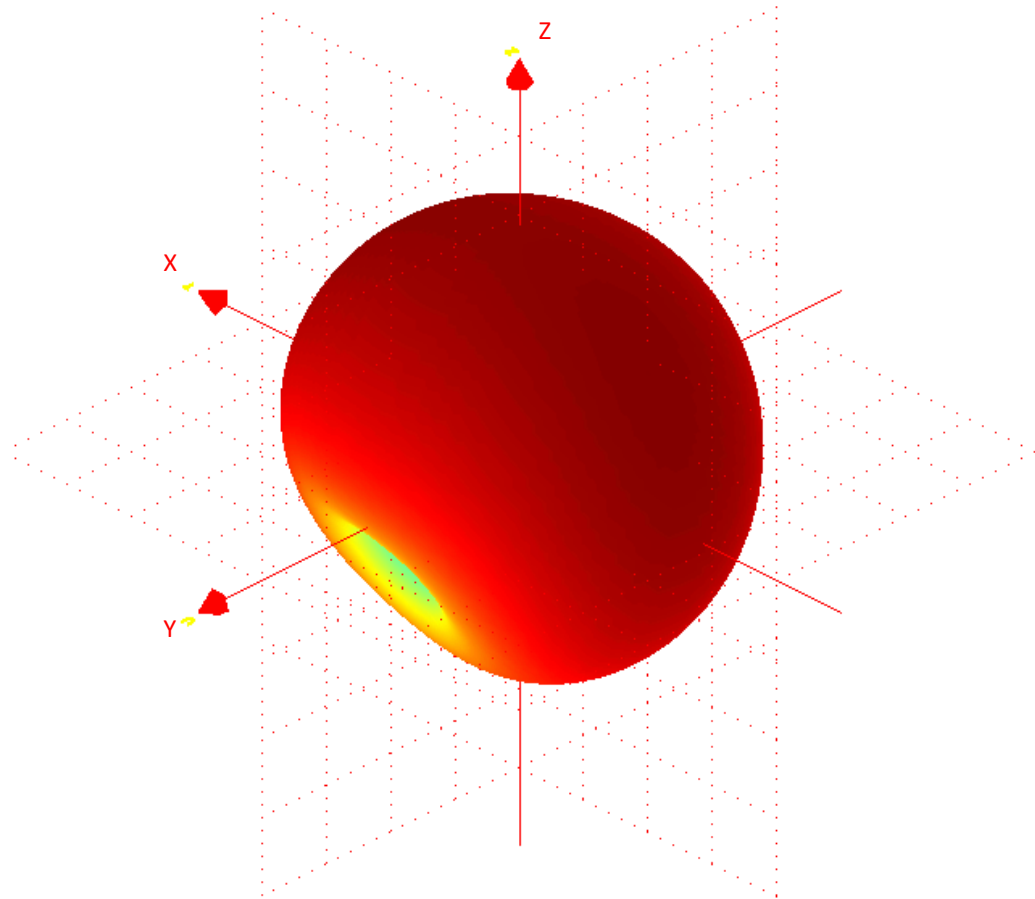

Phi0 Gain cut (dBi)

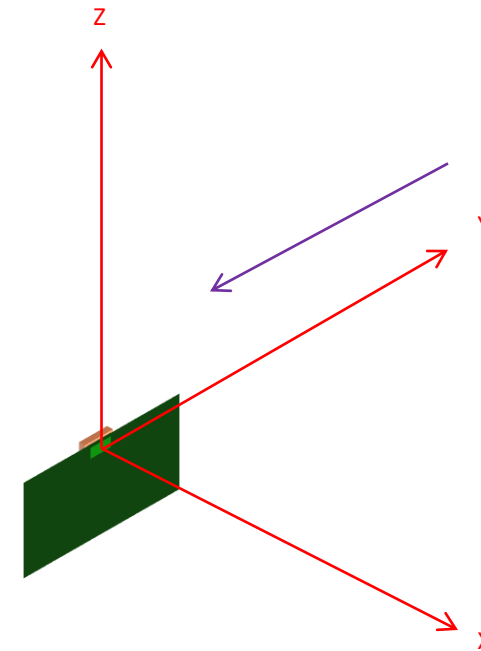
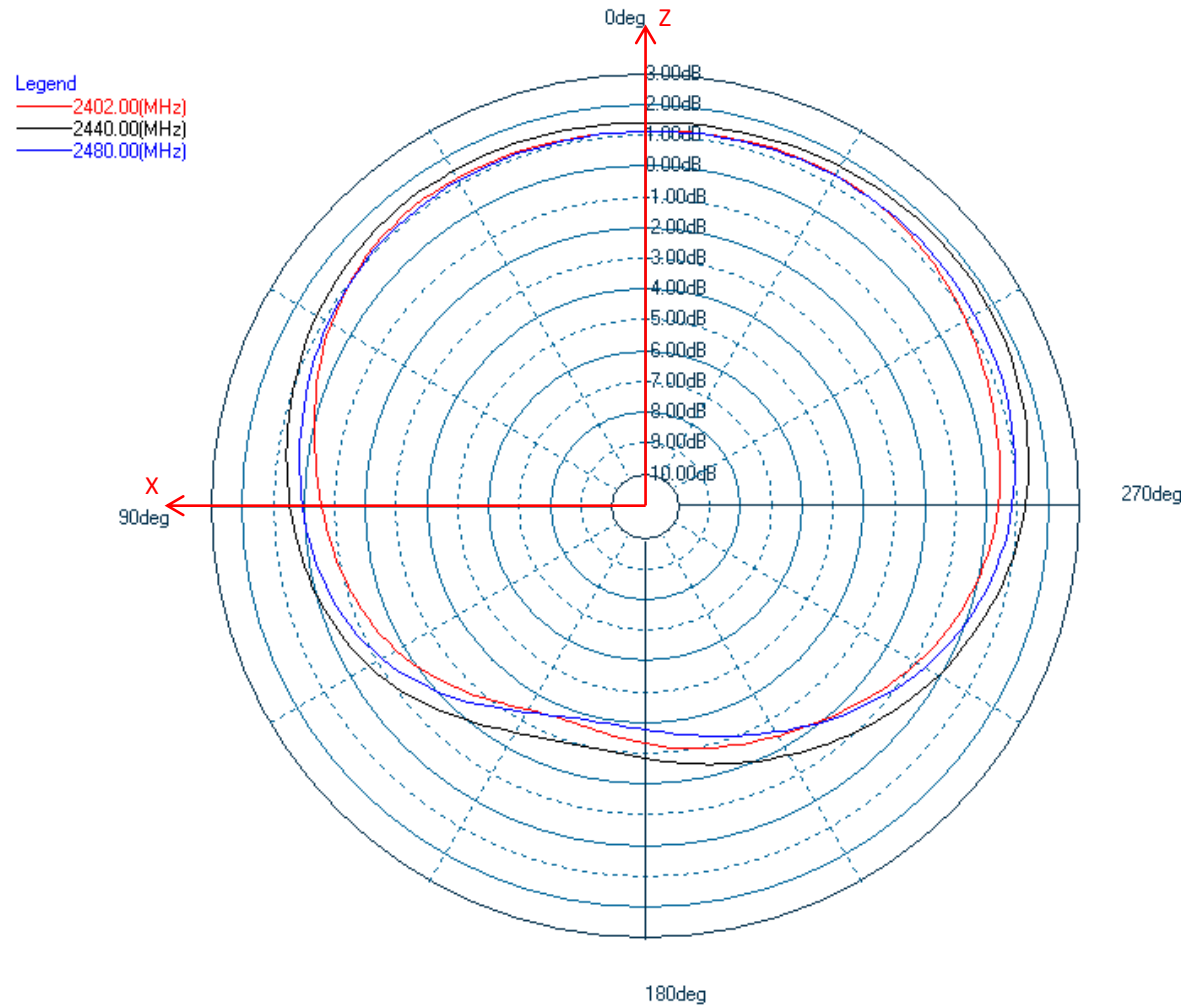

Phi90 Gain cut

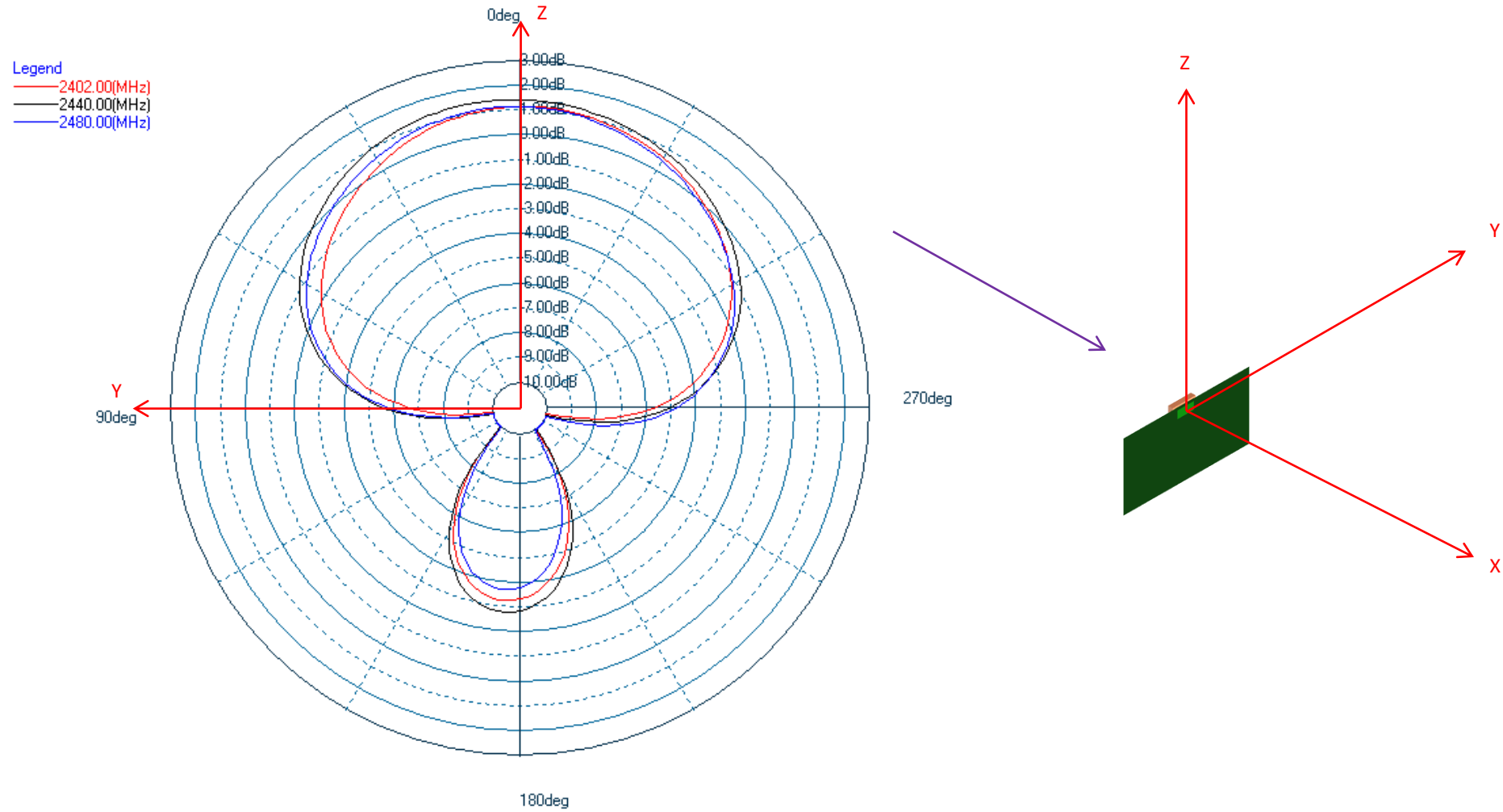

Theta90 Gain cut

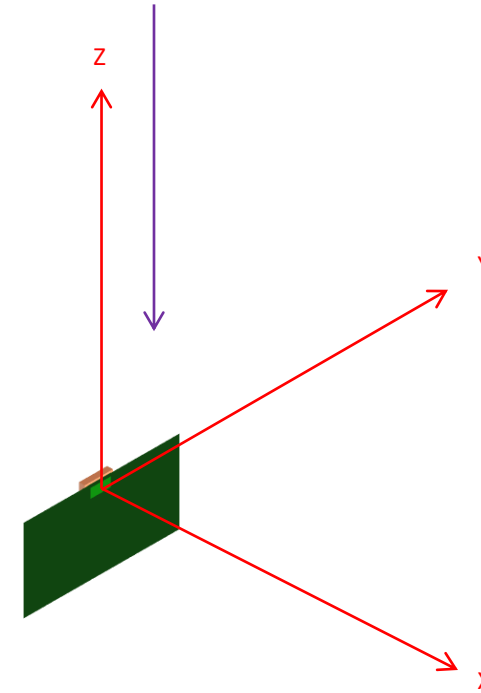
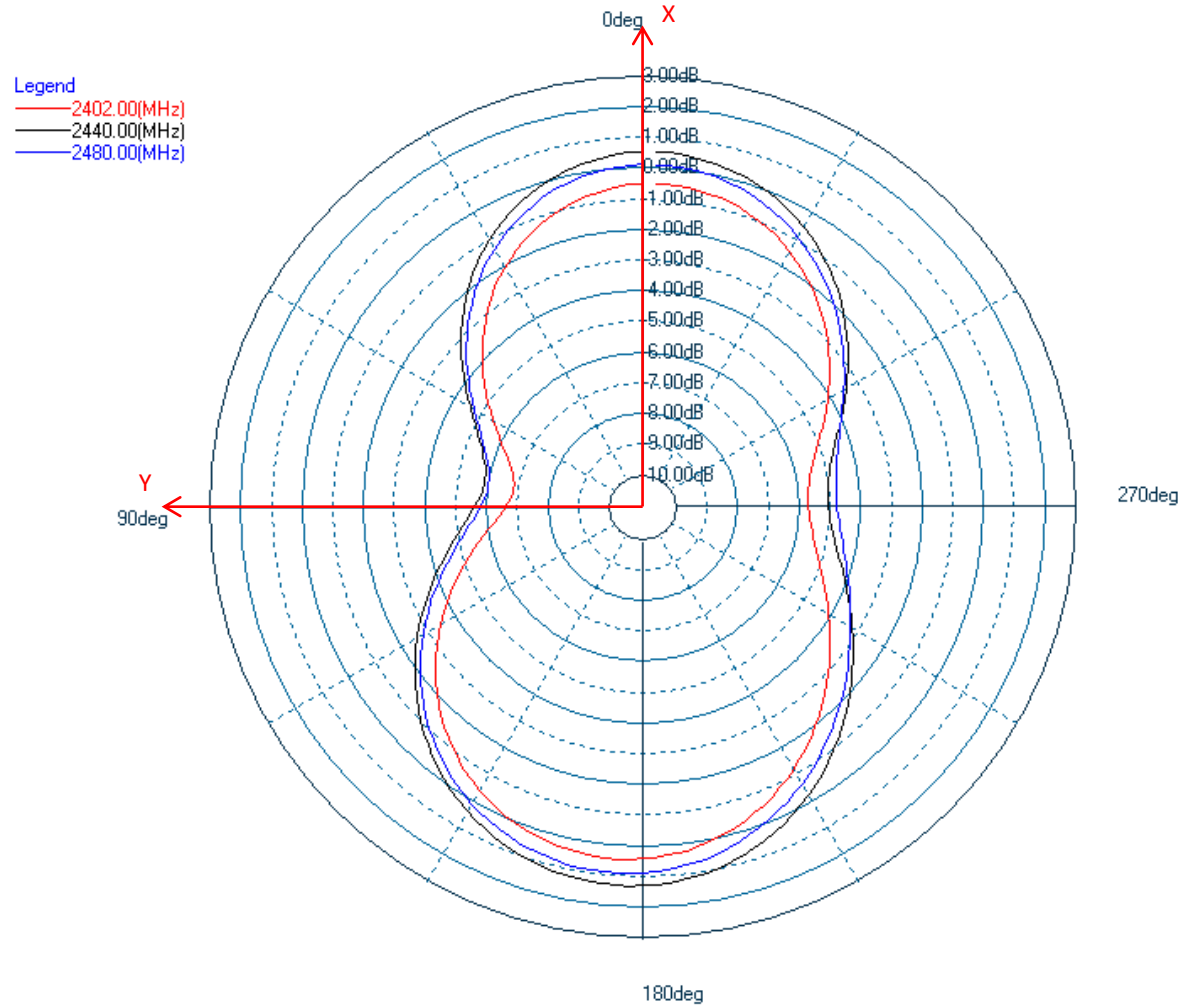



01ACD9

78BCG4

A01387

9898AA

ABGG77

AAB659

7G7GH6



SASKEN

Thank You