

## FCC Test Report

### (Bluetooth Low Energy\_DTS)

**Report No.:** RFCDBM-WTW-P22030865-1

**FCC ID:** QOQ-GM240P

**Test Model:** MGM240P22A

**Series Model:** BGM240P22A (refer to item 3.1 for more details)

**Received Date:** Mar. 22, 2022

**Test Date:** Apr. 07 ~ Apr. 19, 2022

**Issued Date:** Aug. 15, 2022

**Applicant:** Silicon Laboratories Finland Oy

**Address:** Alberga Business Park - Bldg D/Floor 5, Bertel Jungin aukio 3, 02600  
ESPOO, FINLAND

**Issued By:** Bureau Veritas Consumer Products Services (H.K.) Ltd., Taoyuan Branch  
Lin Kou Laboratories

**Lab Address:** No. 47-2, 14th Ling, Chia Pau Vil., Lin Kou Dist., New Taipei City, Taiwan

**Test Location (1):** No.19, Hwa Ya 2nd Rd., Wen Hwa Vil., Kwei Shan Dist., Taoyuan City  
33383, Taiwan

**Test Location (2):** No. 70, Wenming Rd., Guishan Dist., Taoyuan City 333, Taiwan

**FCC Registration /  
Designation Number (1):** 788550 / TW0003

**FCC Registration /  
Designation Number (2):** 281270 / TW0032



This report is governed by, and incorporates by reference, the Conditions of Testing as posted at the date of issuance of this report at <http://www.bureauveritas.com/home/about-us/our-business/cps/about-us/terms-conditions/> and is intended for your exclusive use. Any copying or replication of this report to or for any other person or entity, or use of our name or trademark, is permitted only with our prior written permission. This report sets forth our findings solely with respect to the test samples identified herein. The results set forth in this report are not indicative or representative of the quality or characteristics of the lot from which a test sample was taken or any similar or identical product unless specifically and expressly noted. Our report includes all of the tests requested by you and the results thereof based upon the information that you provided to us. Measurement uncertainty is only provided upon request for accredited tests. Statements of conformity are based on simple acceptance criteria without taking measurement uncertainty into account, unless otherwise requested in writing. You have 60 days from date of issuance of this report to notify us of any material error or omission caused by our negligence or if you require measurement uncertainty; provided, however, that such notice shall be in writing and shall specifically address the issue you wish to raise. A failure to raise such issue within the prescribed time shall constitute your unqualified acceptance of the completeness of this report, the tests conducted and the correctness of the report contents.

## Table of Contents

<b>Release Control Record</b> .....	<b>4</b>
<b>1 Certificate of Conformity</b> .....	<b>5</b>
<b>2 Summary of Test Results</b> .....	<b>6</b>
2.1 Measurement Uncertainty .....	7
2.2 Modification Record .....	7
<b>3 General Information</b> .....	<b>8</b>
3.1 General Description of EUT .....	8
3.2 Description of Test Modes .....	10
3.2.1 Test Mode Applicability and Tested Channel Detail .....	11
3.3 Duty Cycle of Test Signal .....	13
3.4 Description of Support Units .....	14
3.4.1 Configuration of System under Test .....	14
3.5 General Description of Applied Standards and References .....	15
<b>4 Test Types and Results</b> .....	<b>16</b>
4.1 Radiated Emission and Bandedge Measurement .....	16
4.1.1 Limits of Radiated Emission and Bandedge Measurement .....	16
4.1.2 Test Instruments .....	17
4.1.3 Test Procedures .....	18
4.1.4 Deviation from Test Standard .....	18
4.1.5 Test Set Up .....	19
4.1.6 EUT Operating Conditions .....	20
4.1.7 Test Results .....	21
4.2 Conducted Emission Measurement .....	31
4.2.1 Limits of Conducted Emission Measurement .....	31
4.2.2 Test Instruments .....	31
4.2.3 Test Procedures .....	31
4.2.4 Deviation from Test Standard .....	32
4.2.5 Test Setup .....	32
4.2.6 EUT Operating Conditions .....	32
4.2.7 Test Results .....	33
4.3 6 dB Bandwidth Measurement .....	35
4.3.1 Limits of 6 dB Bandwidth Measurement .....	35
4.3.2 Test Setup .....	35
4.3.3 Test Instruments .....	35
4.3.4 Test Procedure .....	35
4.3.5 Deviation from Test Standard .....	35
4.3.6 EUT Operating Conditions .....	35
4.3.7 Test Results .....	36
4.4 Occupied Bandwidth Measurement .....	38
4.4.1 Test Setup .....	38
4.4.2 Test Instruments .....	38
4.4.3 Test Procedure .....	38
4.4.4 Deviation from Test Standard .....	38
4.4.5 EUT Operating Conditions .....	38
4.4.6 Test Results .....	39
4.5 Conducted Output Power Measurement .....	41
4.5.1 Limits of Conducted Output Power Measurement .....	41
4.5.2 Test Setup .....	41
4.5.3 Test Instruments .....	41
4.5.4 Test Procedures .....	41
4.5.5 Deviation from Test Standard .....	41
4.5.6 EUT Operating Conditions .....	41
4.5.7 Test Results .....	42

4.6	Power Spectral Density Measurement .....	43
4.6.1	Limits of Power Spectral Density Measurement.....	43
4.6.2	Test Setup.....	43
4.6.3	Test Instruments .....	43
4.6.4	Test Procedure .....	43
4.6.5	Deviation from Test Standard .....	43
4.6.6	EUT Operating Condition .....	43
4.6.7	Test Results .....	44
4.7	Conducted Out of Band Emission Measurement .....	46
4.7.1	Limits of Conducted Out of Band Emission Measurement.....	46
4.7.2	Test Setup.....	46
4.7.3	Test Instruments .....	46
4.7.4	Test Procedure .....	46
4.7.5	Deviation from Test Standard .....	46
4.7.6	EUT Operating Condition .....	46
4.7.7	Test Results .....	47
<b>Annex A-</b>	<b>Band Edge Measurement .....</b>	<b>50</b>
<b>5</b>	<b>Pictures of Test Arrangements.....</b>	<b>53</b>
<b>Appendix –</b>	<b>Information of the Testing Laboratories .....</b>	<b>54</b>

### Release Control Record

Issue No.	Description	Date Issued
RFCDBM-WTW-P22030865-1	Original Release	Aug. 15, 2022

## 1 Certificate of Conformity

**Product:** Bluetooth Low Energy and 802.15.4 wireless radio module

**Brand:** Silicon Labs

**Test Model:** MGM240P22A

**Series Model:** BGM240P22A (refer to item 3.1 for more details)

**Sample Status:** Engineering samples fully representing the production modules

**Applicant:** Silicon Laboratories Finland Oy

**Test Date:** Apr. 07 ~ Apr. 19, 2022

**Standards:** 47 CFR FCC Part 15, Subpart C (Section 15.247)  
ANSI C63.10:2013

The above equipment has been tested by **Bureau Veritas Consumer Products Services (H.K.) Ltd., Taoyuan Branch**, and found compliance with the requirement of the above standards. The test record, data evaluation & Equipment Under Test (EUT) configurations represented herein are true and accurate accounts of the measurements of the sample's RF characteristics under the conditions specified in this report.

**Prepared by :** Gina Liu, **Date:** Aug. 15, 2022  
Gina Liu / Specialist

**Approved by :** Jeremy Lin, **Date:** Aug. 15, 2022  
Jeremy Lin / Project Engineer

## 2 Summary of Test Results

47 CFR FCC Part 15, Subpart C (Section 15.247)			
FCC Clause	Test Item	Result	Remarks
15.207	AC Power Conducted Emission	Pass	Meet the requirement of limit. Minimum passing margin is -16.68 dB at 0.15800 MHz.
15.205 & 209	Radiated Emissions	Pass	Meet the requirement of limit. Minimum passing margin is -5.35 dB at 2483.50 MHz.
15.247(d)	Band Edge Measurement	Pass	Meet the requirement of limit.
15.247(d)	Antenna Port Emission	Pass	Meet the requirement of limit.
15.247(a)(2)	6 dB Bandwidth	Pass	Meet the requirement of limit.
---	Occupied Bandwidth Measurement	Pass	Reference only
15.247(b)	Conducted Power	Pass	Meet the requirement of limit.
15.247(e)	Power Spectral Density	Pass	Meet the requirement of limit.
15.203	Antenna Requirement	Pass	MGM240P22A: these modules use an integral antenna, therefore comply with the requirement of 15.203 (see section 1.4 for details)

Note:

1. For 2.4G band compliance with rule 15.247(d) of the band-edge items, the test plots were recorded in Annex A. Test Procedures refer to report 4.1.3.
2. Determining compliance based on the results of the compliance measurement, not taking into account measurement instrumentation uncertainty.

## 2.1 Measurement Uncertainty

Where relevant, the following measurement uncertainty levels have been estimated for tests performed on the EUT as specified in CISPR 16-4-2:

Measurement	Frequency	Expanded Uncertainty (k=2) ( $\pm$ )
Conducted Emissions at mains ports	150 kHz ~ 30 MHz	2.79 dB
Radiated Emissions up to 1 GHz	9 kHz ~ 30 MHz	3.00 dB
	30 MHz ~ 200 MHz	2.91 dB
	200 MHz ~ 1000 MHz	2.92 dB
Radiated Emissions above 1 GHz	1 GHz ~ 18 GHz	1.76 dB
	18 GHz ~ 40 GHz	1.77 dB

## 2.2 Modification Record

There were no modifications required for compliance.

### 3 General Information

#### 3.1 General Description of EUT

<b>Product</b>	Bluetooth Low Energy and 802.15.4 wireless radio module
<b>Brand</b>	Silicon Labs
<b>Test Model</b>	MGM240P22A
<b>Series Model</b>	BGM240P22A
<b>Model Difference</b>	Refer to Note as below
<b>Status of EUT</b>	Engineering samples fully representing the production modules
<b>Power Supply Rating</b>	5.0 Vdc from host equipment 1.8 ~ 3.8 Vdc from DC power supply
<b>Modulation Type</b>	GFSK
<b>Modulation Technology</b>	DTS
<b>Transfer Rate</b>	1MBaud with 1Mbps transfer rate 1MBaud with Coded 125kbps transfer rate 1MBaud with Coded 500kbps 2MBaud with 2Mbps transfer rate
<b>Operating Frequency</b>	2402 ~ 2480 MHz
<b>Number of Channel</b>	1MBaud: 40 2MBaud: 37
<b>Output Power</b>	LE 4.0: 11.143 mW LE 5.0: 11.015 mW
<b>Antenna Type</b>	Refer to Note as below
<b>Antenna Connector</b>	N/A (have integral antenna)
<b>Accessory Device</b>	NA
<b>Data Cable Supplied</b>	NA

Note:

1. All models are listed as below. Model MGM240P22A is the representative for final test.

<b>Product Spec.</b>	<b>Model</b>
	MGM240P22A (covers BGM240P22A)
<b>Max nominal RF TX power, as declared by manufacturer</b>	Low-Power/ Bluetooth Low Energy and 802.15.4 (802.15.4 being disabled for BGM240P22A)
	10dBm
<b>Antenna type</b>	integral antenna
<b>Hardware</b>	<p>MGM240P22A (and BGM240P22A) --&gt; hardware variants with integral antenna and 10dBm max power, to be tested as DTS for both 802.15.4 and Bluetooth Low Energy</p> <p>These three hardware variants should be RF tested separately, because PAs are configured differently and also antenna matching components are different between them, meaning for example that conducted RF measurements cannot be assumed to deliver the exact same results across the three samples.</p> <p>MGM modules are the ones under testing as they support both 802.15.4 and Bluetooth Low Energy, whereas the BGM modules are the series models because they are exactly the same except for the 802.15.4 being disabled.</p>



2. The antenna information is listed as below.

Type	Connector	Gain (dBi)
Integral antenna	NA	1.82

\* The above Antenna information is declared by manufacturer and for more detailed features description, please refer to the manufacturer's specifications, the laboratory shall not be held responsible.

3. The above Antenna information is declared by manufacturer and for more detailed features description, please refer to the manufacturer's specifications, the laboratory shall not be held responsible.

4. The above EUT information is declared by manufacturer and for more detailed features description, please refers to the manufacturer's specifications or User's Manual.

5. The EUT has DTS and Hopping functions.

6. BT LE (DTS/FHSS) and 802.15.4 modes technology cannot transmit at same time.

7. Power setting is as below:

Test Mode: MGM240P22A	
Channel	Power Setting
0	100
1	100
19	100
38	100
39	100

### 3.2 Description of Test Modes

#### 1MBaud

40 channels are provided to this EUT:

Channel	Freq. (MHz)	Channel	Freq. (MHz)	Channel	Freq. (MHz)	Channel	Freq. (MHz)
<b>0</b>	<b>2402</b>	10	2422	20	2442	30	2462
<b>1</b>	<b>2404</b>	11	2424	21	2444	31	2464
2	2406	12	2426	22	2446	32	2466
3	2408	13	2428	23	2448	33	2468
4	2410	14	2430	24	2450	34	2470
5	2412	15	2432	25	2452	35	2472
6	2414	16	2434	26	2454	36	2474
7	2416	17	2436	27	2456	37	2476
8	2418	18	2438	28	2458	<b>38</b>	<b>2478</b>
9	2420	<b>19</b>	<b>2440</b>	29	2460	<b>39</b>	<b>2480</b>

Note: The channels which were indicated in bold type of the above channel list were selected as representative test channel. Therefore only the data of the test channels were recorded in this report.

#### 2MBaud

37 channels are provided to this EUT:

Channel	Freq. (MHz)	Channel	Freq. (MHz)	Channel	Freq. (MHz)	Channel	Freq. (MHz)
<b>1</b>	<b>2404</b>	11	2424	21	2444	31	2464
2	2406	-	-	22	2446	32	2466
3	2408	13	2428	23	2448	33	2468
4	2410	14	2430	24	2450	34	2470
5	2412	15	2432	25	2452	35	2472
6	2414	16	2434	26	2454	36	2474
7	2416	17	2436	27	2456	37	2476
8	2418	18	2438	28	2458	<b>38</b>	<b>2478</b>
9	2420	<b>19</b>	<b>2440</b>	29	2460		
10	2422	20	2442	30	2462		

Note: The channels which were indicated in bold type of the above channel list were selected as representative test channel. Therefore only the data of the test channels were recorded in this report.

### 3.2.1 Test Mode Applicability and Tested Channel Detail

#### <1MBaud PHY>

EUT Configure Mode	Applicable To				Description
	RE≥1G	RE<1G	PLC	APCM	
-	√	-	-	√	-

Where **RE≥1G**: Radiated Emission above 1 GHz      **RE<1G**: Radiated Emission below 1 GHz  
**PLC**: Power Line Conducted Emission      **APCM**: Antenna Port Conducted Measurement

**Note:** The EUT had been pre-tested on the positioned of each 3 axis. The worst case was found when positioned on **Y-plane**.  
**Note:** "-" means no effect.

#### **Radiated Emission Test (Above 1 GHz):**

- Pre-Scan has been conducted to determine the worst-case mode from all possible combinations between available modulations, data rates and antenna ports (if EUT with antenna diversity architecture).
- Following channel(s) was (were) selected for the final test as listed below.

EUT Configure Mode	Available Channel	Tested Channel	Modulation Type	Data Rate (Mbps)
-	0 to 39	0, 1, 19, 38, 39	GFSK	1

#### **Antenna Port Conducted Measurement:**

- This item includes all test value of each mode, but only includes spectrum plot of worst value of each mode.
- Pre-Scan has been conducted to determine the worst-case mode from all possible combinations between available modulations, data rates and antenna ports (if EUT with antenna diversity architecture).
- Following channel(s) was (were) selected for the final test as listed below.

EUT Configure Mode	Available Channel	Tested Channel	Modulation Type	Data Rate (Mbps)
-	0 to 39	0, 1, 19, 38, 39	GFSK	1

<2MBaud PHY>

EUT Configure Mode	Applicable To				Description
	RE≥1G	RE<1G	PLC	APCM	
-	√	√	√	√	-

Where **RE≥1G**: Radiated Emission above 1 GHz      **RE<1G**: Radiated Emission below 1 GHz  
**PLC**: Power Line Conducted Emission      **APCM**: Antenna Port Conducted Measurement

**Note:** The EUT had been pre-tested on the positioned of each 3 axis. The worst case was found when positioned on **Y-plane**.  
**Note:** "-" means no effect.

**Radiated Emission Test (Above 1 GHz):**

- Pre-Scan has been conducted to determine the worst-case mode from all possible combinations between available modulations, data rates and antenna ports (if EUT with antenna diversity architecture).
- Following channel(s) was (were) selected for the final test as listed below.

EUT Configure Mode	Available Channel	Tested Channel	Modulation Type	Data Rate (Mbps)
-	1 to 38	1, 19, 38	GFSK	2

**Radiated Emission Test (Below 1 GHz):**

- Pre-Scan has been conducted to determine the worst-case mode from all possible combinations between available modulations, data rates and antenna ports (if EUT with antenna diversity architecture).
- Following channel(s) was (were) selected for the final test as listed below.

EUT Configure Mode	Available Channel	Tested Channel	Modulation Type	Data Rate (Mbps)
-	1 to 38	19	GFSK	2

**Power Line Conducted Emission Test:**

- Pre-Scan has been conducted to determine the worst-case mode from all possible combinations between available modulations, data rates and antenna ports (if EUT with antenna diversity architecture).
- Following channel(s) was (were) selected for the final test as listed below.

EUT Configure Mode	Available Channel	Tested Channel	Modulation Type	Data Rate (Mbps)
-	1 to 38	19	GFSK	2

**Antenna Port Conducted Measurement:**

- This item includes all test value of each mode, but only includes spectrum plot of worst value of each mode.
- Pre-Scan has been conducted to determine the worst-case mode from all possible combinations between available modulations, data rates and antenna ports (if EUT with antenna diversity architecture).
- Following channel(s) was (were) selected for the final test as listed below.

EUT Configure Mode	Available Channel	Tested Channel	Modulation Type	Data Rate (Mbps)
-	1 to 38	1, 19, 38	GFSK	2

**Test Condition:**

Applicable To	Environmental Conditions	Input Power	Tested by
RE≥1G	25 deg. C, 65 % RH	120 Vac, 60 Hz (System)	Wade Huang
RE<1G	23deg. C, 66% RH	120 Vac, 60 Hz (System)	Wade Huang
PLC	25 deg. C, 69% RH	120 Vac, 60 Hz (System)	Wade Huang
APCM	25 deg. C, 60% RH	120 Vac, 60 Hz (System)	Alan Wu

**3.3 Duty Cycle of Test Signal**

Duty cycle of test signal is < 98 %, duty factor shall be considered.

**<1MBaud PHY>**

Duty cycle = 17.037/17.499 = 0.974, Duty factor =  $10 * \log(1/0.974) = 0.12$

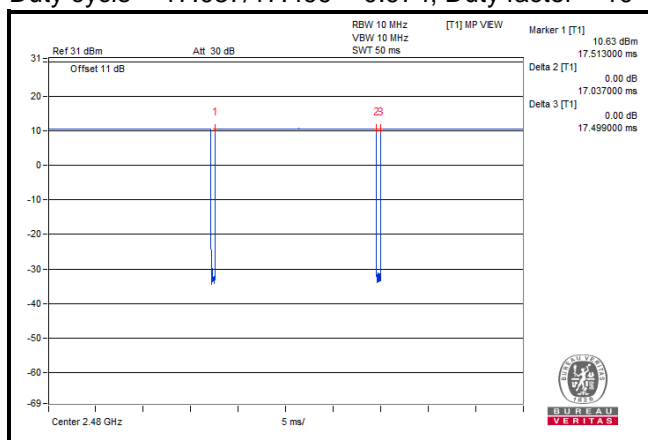

**<2MBaud PHY>**

Duty cycle = 0.995/1.253 = 0.794, Duty factor =  $10 * \log(1/0.794) = 1.00$

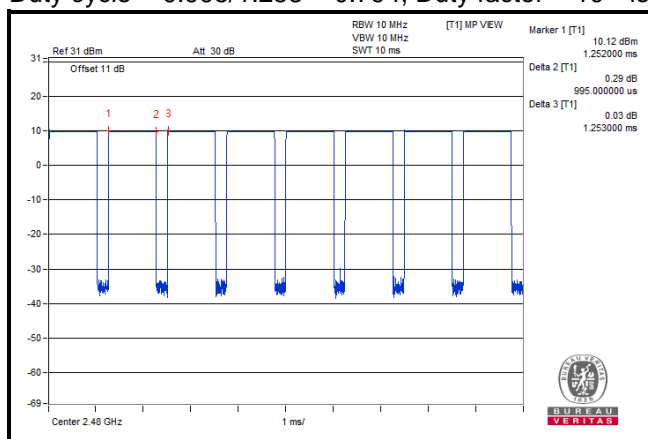

### 3.4 Description of Support Units

The EUT has been tested as an independent unit together with other necessary accessories or support units. The following support units or accessories were used to form a representative test configuration during the tests.

ID	Product	Brand	Model No.	Serial No.	FCC ID	Remarks
A.	Host Board optimized for certification testing of the EUT	Silicon Labs	NA	NA	NA	Provided by client
B.	Notebook	DELL	E5430	BPJVKV1	FCC DoC Approved	-

Note:

1. All power cords of the above support units are non-shielded (1.8m).
2. Item B acted as communication partners to transfer data.

ID	Cable Descriptions	Qty.	Length (m)	Shielding (Yes/No)	Cores (Qty.)	Remarks
1.	USB Cable	1	1.5	Y	0	Provided by client

#### 3.4.1 Configuration of System under Test

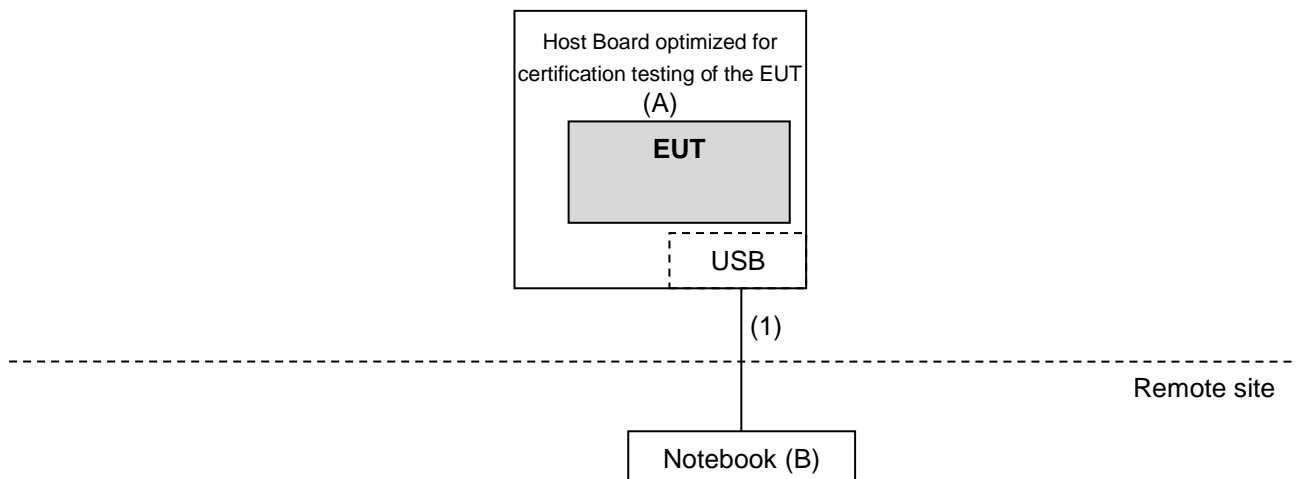

### **3.5 General Description of Applied Standards and References**

The EUT is a RF Product. According to the specifications of the manufacturer, it must comply with the requirements of the following standards and references:

#### **Test Standard:**

**FCC Part 15, Subpart C (15.247)**

ANSI C63.10-2013

All test items have been performed and recorded as per the above standards.

#### **References Test Guidance:**

**KDB 558074 D01 15.247 Meas Guidance v05r02**

All test items have been performed as a reference to the above KDB test guidance.

## 4 Test Types and Results

### 4.1 Radiated Emission and Bandedge Measurement

#### 4.1.1 Limits of Radiated Emission and Bandedge Measurement

Radiated emissions which fall in the restricted bands must comply with the radiated emission limits specified as below table. Other emissions shall be at least 20 dB below the highest level of the desired power:

Frequencies (MHz)	Field Strength (microvolts/meter)	Measurement Distance (meters)
0.009 ~ 0.490	2400/F (kHz)	300
0.490 ~ 1.705	24000/F (kHz)	30
1.705 ~ 30.0	30	30
30 ~ 88	100	3
88 ~ 216	150	3
216 ~ 960	200	3
Above 960	500	3

**Note:**

1. The lower limit shall apply at the transition frequencies.
2. Emission level (dBuV/m) = 20 log Emission level (uV/m).
3. For frequencies above 1000 MHz, the field strength limits are based on average detector, however, the peak field strength of any emission shall not exceed the maximum permitted average limits, specified above by more than 20 dB under any condition of modulation.



#### 4.1.2 Test Instruments

Description & Manufacturer	Model No.	Serial No.	Cal. Date	Cal. Due
Test Receiver KEYSIGHT	N9038B	MY60180018	Feb. 18, 2022	Feb. 17, 2023
Spectrum Analyzer KEYSIGHT	N9020B	MY60110462	Dec. 21, 2021	Dec. 20, 2022
BILOG Antenna SCHWARZBECK	VULB9168	9168-995	Oct. 28, 2021	Oct. 27, 2022
HORN Antenna RF SPIN	DRH18-E	210104A18E	Nov. 14, 2021	Nov. 13, 2022
HORN Antenna SCHWARZBECK	BBHA 9170	9170-995	Nov. 14, 2021	Nov. 13, 2022
Loop Antenna EMCI	EM-6879	269	Sep. 16, 2021	Sep. 15, 2022
Loop Antenna TESEQ	HLA 6121	45745	Jul. 21, 2021	Jul. 20, 2022
Preamplifier EMCI	EMC330N	980783	Jan. 17, 2022	Jan. 16, 2023
Preamplifier EMCI	EMC118A45SE	980810	Dec. 30, 2021	Dec. 29, 2022
Preamplifier EMCI	EMC184045SE	980787	Jan. 17, 2022	Jan. 16, 2023
RF signal cable EMCI	EMC104-SM-SM-(9000+3000+2000+1000)	201230+ 201242+201238+ 210101	Jan. 17, 2022	Jan. 16, 2023
RF signal cable EMCI	EMCCFD400-NM-NM-(9000+3000+500++500)	201252+ 201250+201247+ 201245	Jan. 17, 2022	Jan. 16, 2023
RF signal cable EMCI	EMC101G-KM-KM-(5000+3000+2000)	201259+201256+201253	Jan. 17, 2022	Jan. 16, 2023
Software BV CPS	ADT_Radiated_V7.6.15.9.5	NA	NA	NA
Turn Table Max-Full	MFT-151SS-0.5T	NA	NA	NA
Turn Table Controller Max-Full	MF-7802BS	MF780208675	NA	NA
Antenna Tower KaiTuo	NA	NA	NA	NA
Antenna Tower Controller KaiTuo	KT-2000	NA	NA	NA
Wideband Power Sensor KEYSIGHT	N1923A	MY58020002	Jan. 17, 2022	Jan. 16, 2023
Peak Power Analyzer KEYSIGHT	8990B	MY51000485	Jan. 18, 2022	Jan. 17, 2023
Spectrum Analyzer ROHDE & SCHWARZ	FSV40	100979	Mar. 25, 2022	Mar. 24, 2023

Note: 1. The calibration interval of the above test instruments is 12 months and the calibrations are traceable to NML/ROC and NIST/USA.  
2. The test was performed in WM Chamber 7.

#### 4.1.3 Test Procedures

##### **For Radiated Emission below 30 MHz**

- a. The EUT was placed on the top of a rotating table 0.8 meters above the ground at a 3 meter chamber room. The table was rotated 360 degrees to determine the position of the highest radiation.
- b. The EUT was set 3 meters away from the interference-receiving antenna, which was mounted on the top of a variable-height antenna tower.
- c. Parallel, perpendicular, and ground-parallel orientations of the antenna are set to make the measurement.
- d. For each suspected emission, the EUT was arranged to its worst case and the rotatable table was turned from 0 degrees to 360 degrees to find the maximum reading.
- e. The test-receiver system was set to Quasi-Peak Detect Function and Specified Bandwidth with Maximum Hold Mode.

##### **Note:**

1. The resolution bandwidth and video bandwidth of test receiver/spectrum analyzer is 9 kHz at frequency below 30 MHz.

##### **For Radiated Emission above 30 MHz**

- a. The EUT was placed on the top of a rotating table 0.8 meters (for 30 MHz ~ 1 GHz) / 1.5 meters (for above 1 GHz) above the ground at 3 meter chamber room for test. The table was rotated 360 degrees to determine the position of the highest radiation.
- b. The EUT was set 3 meters away from the interference-receiving antenna, which was mounted on the top of a variable-height antenna tower.
- c. The height of antenna is varied from one meter to four meters above the ground to determine the maximum value of the field strength. Both horizontal and vertical polarizations of the antenna are set to make the measurement.
- d. For each suspected emission, the EUT was arranged to its worst case and then the antenna was tuned to heights from 1 meter to 4 meters and the rotatable table was turned from 0 degrees to 360 degrees to find the maximum reading.
- e. The test-receiver system was set to quasi-peak detect function and specified bandwidth with maximum hold mode when the test frequency is below 1 GHz.
- f. The test-receiver system was set to peak and average detected function and specified bandwidth with maximum hold mode when the test frequency is above 1 GHz. If the peak reading value also meets average limit, measurement with the average detector is unnecessary.

##### **Note:**

1. The resolution bandwidth and video bandwidth of test receiver/spectrum analyzer is 120 kHz for Quasi-peak detection (QP) at frequency below 1 GHz.
2. The resolution bandwidth of test receiver/spectrum analyzer is 1 MHz and the video bandwidth is 3 MHz for Peak detection (PK) at frequency above 1 GHz.
3. The resolution bandwidth of test receiver/spectrum analyzer is 1 MHz and the video bandwidth is  $\geq 1/T$  (Duty cycle < 98 %) or 10 Hz (Duty cycle  $\geq 98$  %) for Average detection (AV) at frequency above 1 GHz. (LE 1M: RBW = 1 MHz, VBW = 3 kHz ; LE 2M: RBW = 1 MHz, VBW = 5.2 kHz)
4. All modes of operation were investigated and the worst-case emissions are reported.

#### 4.1.4 Deviation from Test Standard

No deviation.

4.1.5 Test Set Up

<Radiated Emission below 30 MHz>

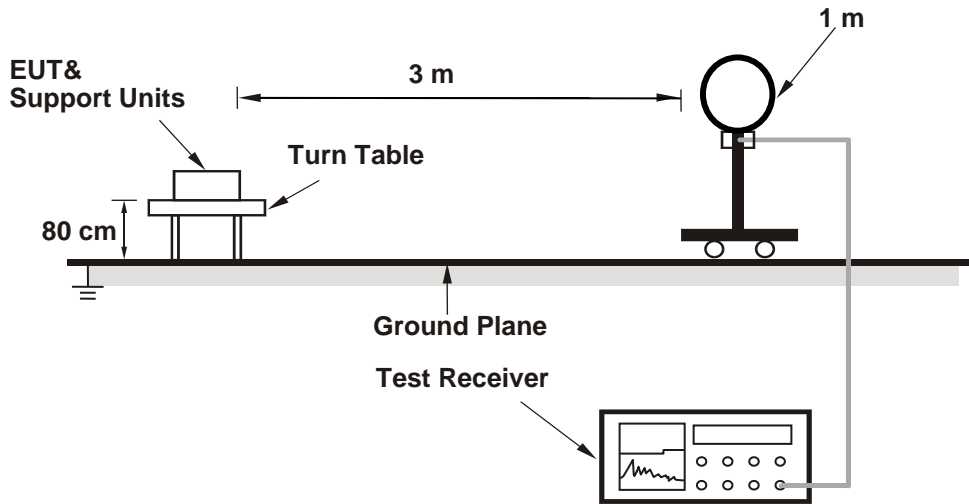

<Radiated Emission 30 MHz to 1 GHz>

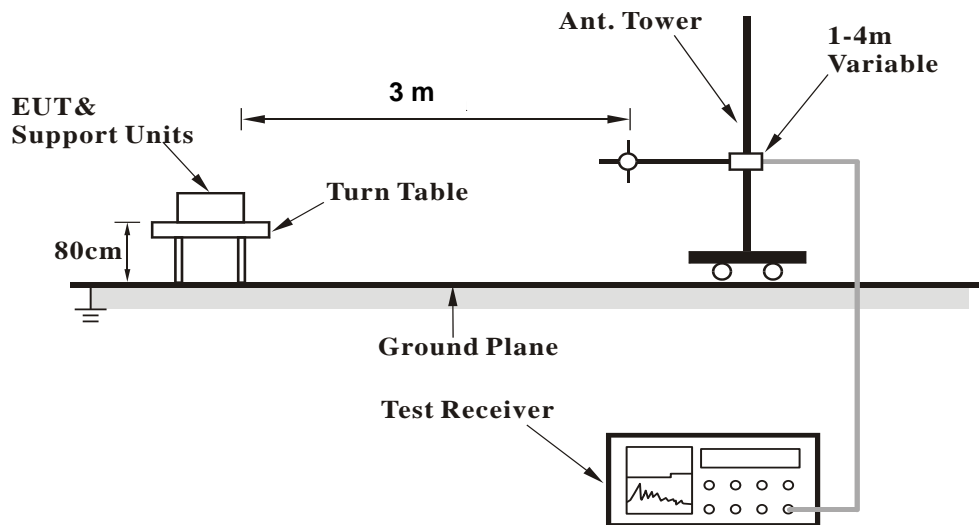

**<Radiated Emission above 1 GHz>**

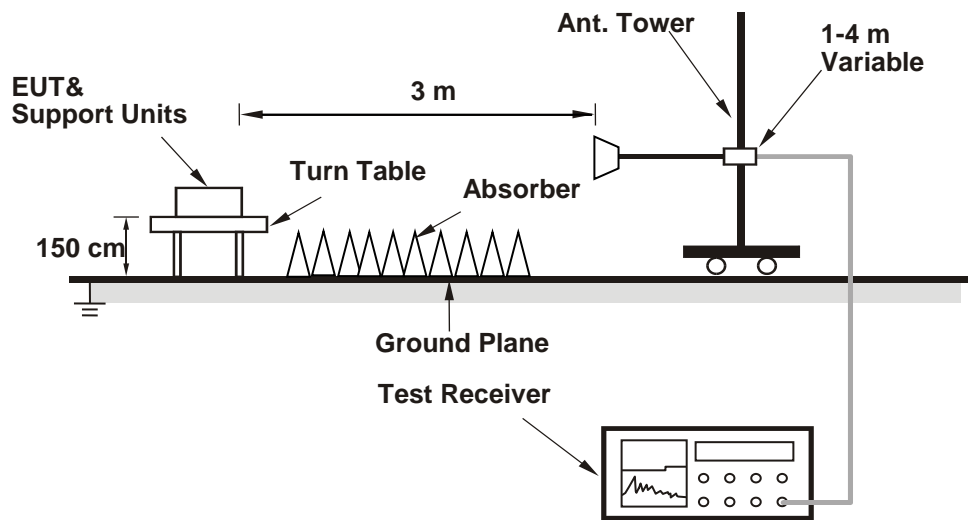

For the actual test configuration, please refer to the attached file (Test Setup Photo).

**4.1.6 EUT Operating Conditions**

- a. Placed the EUT on the testing table.
- b. Set the EUT under transmission condition continuously at specific channel frequency.

#### 4.1.7 Test Results

##### Above 1 GHz Data:

<b>RF Mode</b>	TX BT-LE 1M	<b>Channel</b>	CH 0 : 2402 MHz
<b>Frequency Range</b>	1 GHz ~ 25 GHz	<b>Detector Function &amp; Bandwidth</b>	(PK) RB = 1 MHz, VB = 3 MHz (AV) RB = 1 MHz, VB = 3 kHz
<b>Input Power</b>	120 Vac, 60 Hz	<b>Environmental Conditions</b>	23°C, 68% RH
<b>Tested By</b>	Wade Huang	<b>Test Date</b>	2022/4/7

##### Antenna Polarity & Test Distance : Horizontal at 3 m

No	Frequency (MHz)	Emission Level (dBuV/m)	Limit (dBuV/m)	Margin (dB)	Antenna Height (m)	Table Angle (Degree)	Raw Value (dBuV)	Correction Factor (dB/m)
1	2390.00	58.21 PK	74.00	-15.79	3.30 H	353	26.28	31.93
2	2390.00	44.30 AV	54.00	-9.70	3.30 H	353	12.37	31.93
3	*2402.00	98.20 PK			3.30 H	353	66.29	31.91
4	*2402.00	97.46 AV			3.30 H	353	65.55	31.91
5	4804.00	49.78 PK	74.00	-24.22	1.42 H	29	47.70	2.08
6	4804.00	39.20 AV	54.00	-14.80	1.42 H	29	37.12	2.08

##### Antenna Polarity & Test Distance : Vertical at 3 m

No	Frequency (MHz)	Emission Level (dBuV/m)	Limit (dBuV/m)	Margin (dB)	Antenna Height (m)	Table Angle (Degree)	Raw Value (dBuV)	Correction Factor (dB/m)
1	2390.00	57.83 PK	74.00	-16.17	1.36 V	178	25.90	31.93
2	2390.00	44.51 AV	54.00	-9.49	1.36 V	178	12.58	31.93
3	*2402.00	107.90 PK			1.36 V	178	75.99	31.91
4	*2402.00	107.15 AV			1.36 V	178	75.24	31.91
5	4804.00	47.83 PK	74.00	-26.17	1.56 V	288	45.75	2.08
6	4804.00	36.36 AV	54.00	-17.64	1.56 V	288	34.28	2.08

##### Remarks:

1. Emission Level(dBuV/m) = Raw Value(dBuV) + Correction Factor(dB/m)
2. Correction Factor(dB/m) = Antenna Factor(dB/m) + Cable Factor(dB) – Pre-Amplifier Factor(dB)
3. Margin value = Emission Level – Limit value
4. The other emission levels were very low against the limit.
5. " \* ": Fundamental frequency.

<b>RF Mode</b>	TX BT-LE 1M	<b>Channel</b>	CH 1 : 2404 MHz
<b>Frequency Range</b>	1 GHz ~ 25 GHz	<b>Detector Function &amp; Bandwidth</b>	(PK) RB = 1 MHz, VB = 3 MHz (AV) RB = 1 MHz, VB = 3 kHz
<b>Input Power</b>	120 Vac, 60 Hz	<b>Environmental Conditions</b>	23°C, 68% RH
<b>Tested By</b>	Wade Huang	<b>Test Date</b>	2022/4/7

**Antenna Polarity & Test Distance : Horizontal at 3 m**

No	Frequency (MHz)	Emission Level (dBuV/m)	Limit (dBuV/m)	Margin (dB)	Antenna Height (m)	Table Angle (Degree)	Raw Value (dBuV)	Correction Factor (dB/m)
1	2390.00	57.93 PK	74.00	-16.07	3.31 H	356	26.00	31.93
2	2390.00	44.18 AV	54.00	-9.82	3.31 H	356	12.25	31.93
3	*2404.00	98.21 PK			3.31 H	356	66.30	31.91
4	*2404.00	97.40 AV			3.31 H	356	65.49	31.91
5	4808.00	49.64 PK	74.00	-24.36	1.42 H	30	47.55	2.09
6	4808.00	39.43 AV	54.00	-14.57	1.42 H	30	37.34	2.09

**Antenna Polarity & Test Distance : Vertical at 3 m**

No	Frequency (MHz)	Emission Level (dBuV/m)	Limit (dBuV/m)	Margin (dB)	Antenna Height (m)	Table Angle (Degree)	Raw Value (dBuV)	Correction Factor (dB/m)
1	2390.00	57.31 PK	74.00	-16.69	1.31 V	178	25.38	31.93
2	2390.00	44.47 AV	54.00	-9.53	1.31 V	178	12.54	31.93
3	*2404.00	107.76 PK			1.31 V	178	75.85	31.91
4	*2404.00	106.96 AV			1.31 V	178	75.05	31.91
5	4808.00	48.20 PK	74.00	-25.80	1.56 V	287	46.11	2.09
6	4808.00	36.80 AV	54.00	-17.20	1.56 V	287	34.71	2.09

**Remarks:**

1. Emission Level(dBuV/m) = Raw Value(dBuV) + Correction Factor(dB/m)
2. Correction Factor(dB/m) = Antenna Factor(dB/m) + Cable Factor(dB) – Pre-Amplifier Factor(dB)
3. Margin value = Emission Level – Limit value
4. The other emission levels were very low against the limit.
5. " \* " : Fundamental frequency.

<b>RF Mode</b>	TX BT-LE 1M	<b>Channel</b>	CH 19 : 2440 MHz
<b>Frequency Range</b>	1 GHz ~ 25 GHz	<b>Detector Function &amp; Bandwidth</b>	(PK) RB = 1 MHz, VB = 3 MHz (AV) RB = 1 MHz, VB = 3 kHz
<b>Input Power</b>	120 Vac, 60 Hz	<b>Environmental Conditions</b>	23°C, 68% RH
<b>Tested By</b>	Wade Huang	<b>Test Date</b>	2022/4/7

**Antenna Polarity & Test Distance : Horizontal at 3 m**

No	Frequency (MHz)	Emission Level (dBuV/m)	Limit (dBuV/m)	Margin (dB)	Antenna Height (m)	Table Angle (Degree)	Raw Value (dBuV)	Correction Factor (dB/m)
1	*2440.00	98.15 PK			3.28 H	349	66.32	31.83
2	*2440.00	97.35 AV			3.28 H	349	65.52	31.83
3	4880.00	47.22 PK	74.00	-26.78	1.47 H	25	45.09	2.13
4	4880.00	35.47 AV	54.00	-18.53	1.47 H	25	33.34	2.13

**Antenna Polarity & Test Distance : Vertical at 3 m**

No	Frequency (MHz)	Emission Level (dBuV/m)	Limit (dBuV/m)	Margin (dB)	Antenna Height (m)	Table Angle (Degree)	Raw Value (dBuV)	Correction Factor (dB/m)
1	*2440.00	108.01 PK			1.49 V	161	76.18	31.83
2	*2440.00	107.44 AV			1.49 V	161	75.61	31.83
3	4880.00	47.07 PK	74.00	-26.93	1.00 V	157	44.94	2.13
4	4880.00	34.92 AV	54.00	-19.08	1.00 V	157	32.79	2.13

**Remarks:**

1. Emission Level(dBuV/m) = Raw Value(dBuV) + Correction Factor(dB/m)
2. Correction Factor(dB/m) = Antenna Factor(dB/m) + Cable Factor(dB) – Pre-Amplifier Factor(dB)
3. Margin value = Emission Level – Limit value
4. The other emission levels were very low against the limit.
5. " \* " : Fundamental frequency.

<b>RF Mode</b>	TX BT-LE 1M	<b>Channel</b>	CH 38 : 2478 MHz
<b>Frequency Range</b>	1 GHz ~ 25 GHz	<b>Detector Function &amp; Bandwidth</b>	(PK) RB = 1 MHz, VB = 3 MHz (AV) RB = 1 MHz, VB = 3 kHz
<b>Input Power</b>	120 Vac, 60 Hz	<b>Environmental Conditions</b>	23°C, 68% RH
<b>Tested By</b>	Wade Huang	<b>Test Date</b>	2022/4/7

**Antenna Polarity & Test Distance : Horizontal at 3 m**

No	Frequency (MHz)	Emission Level (dBuV/m)	Limit (dBuV/m)	Margin (dB)	Antenna Height (m)	Table Angle (Degree)	Raw Value (dBuV)	Correction Factor (dB/m)
1	*2478.00	99.20 PK			3.45 H	18	67.34	31.86
2	*2478.00	98.48 AV			3.45 H	18	66.62	31.86
3	2483.50	59.07 PK	74.00	-14.93	3.45 H	18	27.20	31.87
4	2483.50	44.76 AV	54.00	-9.24	3.45 H	18	12.89	31.87
5	4956.00	46.09 PK	74.00	-27.91	1.46 H	24	43.85	2.24
6	4956.00	33.84 AV	54.00	-20.16	1.46 H	24	31.60	2.24

**Antenna Polarity & Test Distance : Vertical at 3 m**

No	Frequency (MHz)	Emission Level (dBuV/m)	Limit (dBuV/m)	Margin (dB)	Antenna Height (m)	Table Angle (Degree)	Raw Value (dBuV)	Correction Factor (dB/m)
1	*2478.00	107.54 PK			1.41 V	342	75.68	31.86
2	*2478.00	106.74 AV			1.41 V	342	74.88	31.86
3	2483.50	56.54 PK	74.00	-17.46	1.41 V	342	24.67	31.87
4	2483.50	46.16 AV	54.00	-7.84	1.41 V	342	14.29	31.87
5	4956.00	46.67 PK	74.00	-27.33	1.55 V	285	44.43	2.24
6	4956.00	33.71 AV	54.00	-20.29	1.55 V	285	31.47	2.24

**Remarks:**

1. Emission Level(dBuV/m) = Raw Value(dBuV) + Correction Factor(dB/m)
2. Correction Factor(dB/m) = Antenna Factor(dB/m) + Cable Factor(dB) – Pre-Amplifier Factor(dB)
3. Margin value = Emission Level – Limit value
4. The other emission levels were very low against the limit.
5. " \* " : Fundamental frequency.



<b>RF Mode</b>	TX BT-LE 1M	<b>Channel</b>	CH 39 : 2480 MHz
<b>Frequency Range</b>	1 GHz ~ 25 GHz	<b>Detector Function &amp; Bandwidth</b>	(PK) RB = 1 MHz, VB = 3 MHz (AV) RB = 1 MHz, VB = 3 kHz
<b>Input Power</b>	120 Vac, 60 Hz	<b>Environmental Conditions</b>	23°C, 68% RH
<b>Tested By</b>	Wade Huang	<b>Test Date</b>	2022/4/7

**Antenna Polarity & Test Distance : Horizontal at 3 m**

No	Frequency (MHz)	Emission Level (dBuV/m)	Limit (dBuV/m)	Margin (dB)	Antenna Height (m)	Table Angle (Degree)	Raw Value (dBuV)	Correction Factor (dB/m)
1	*2480.00	99.04 PK			3.46 H	17	67.17	31.87
2	*2480.00	98.23 AV			3.46 H	17	66.36	31.87
3	2483.50	58.48 PK	74.00	-15.52	3.46 H	17	26.61	31.87
4	2483.50	45.29 AV	54.00	-8.71	3.46 H	17	13.42	31.87
5	4960.00	46.24 PK	74.00	-27.76	1.45 H	29	43.99	2.25
6	4960.00	34.16 AV	54.00	-19.84	1.45 H	29	31.91	2.25

**Antenna Polarity & Test Distance : Vertical at 3 m**

No	Frequency (MHz)	Emission Level (dBuV/m)	Limit (dBuV/m)	Margin (dB)	Antenna Height (m)	Table Angle (Degree)	Raw Value (dBuV)	Correction Factor (dB/m)
1	*2480.00	107.39 PK			1.30 V	344	75.52	31.87
2	*2480.00	106.61 AV			1.30 V	344	74.74	31.87
3	2483.50	59.17 PK	74.00	-14.83	1.30 V	344	27.30	31.87
<b>4</b>	<b>2483.50</b>	<b>48.65 AV</b>	<b>54.00</b>	<b>-5.35</b>	<b>1.30 V</b>	<b>344</b>	<b>16.78</b>	<b>31.87</b>
5	4960.00	47.34 PK	74.00	-26.66	1.57 V	286	45.09	2.25
6	4960.00	33.76 AV	54.00	-20.24	1.57 V	286	31.51	2.25

**Remarks:**

1. Emission Level(dBuV/m) = Raw Value(dBuV) + Correction Factor(dB/m)
2. Correction Factor(dB/m) = Antenna Factor(dB/m) + Cable Factor(dB) – Pre-Amplifier Factor(dB)
3. Margin value = Emission Level – Limit value
4. The other emission levels were very low against the limit.
5. " \* " : Fundamental frequency.

<b>RF Mode</b>	TX BT-LE 2M	<b>Channel</b>	CH 1 : 2404 MHz
<b>Frequency Range</b>	1 GHz ~ 25 GHz	<b>Detector Function &amp; Bandwidth</b>	(PK) RB = 1 MHz, VB = 3 MHz (AV) RB = 1 MHz, VB = 5.2 kHz
<b>Input Power</b>	120 Vac, 60 Hz	<b>Environmental Conditions</b>	23°C, 68% RH
<b>Tested By</b>	Wade Huang	<b>Test Date</b>	2022/4/7

**Antenna Polarity & Test Distance : Horizontal at 3 m**

No	Frequency (MHz)	Emission Level (dBuV/m)	Limit (dBuV/m)	Margin (dB)	Antenna Height (m)	Table Angle (Degree)	Raw Value (dBuV)	Correction Factor (dB/m)
1	2390.00	57.12 PK	74.00	-16.88	3.81 H	157	25.19	31.93
2	2390.00	44.26 AV	54.00	-9.74	3.81 H	157	12.33	31.93
3	*2404.00	98.91 PK			3.81 H	157	67.00	31.91
4	*2404.00	96.51 AV			3.81 H	157	64.60	31.91
5	4808.00	48.78 PK	74.00	-25.22	1.47 H	25	46.69	2.09
6	4808.00	37.60 AV	54.00	-16.40	1.47 H	25	35.51	2.09

**Antenna Polarity & Test Distance : Vertical at 3 m**

No	Frequency (MHz)	Emission Level (dBuV/m)	Limit (dBuV/m)	Margin (dB)	Antenna Height (m)	Table Angle (Degree)	Raw Value (dBuV)	Correction Factor (dB/m)
1	2390.00	57.44 PK	74.00	-16.56	1.54 V	350	25.51	31.93
2	2390.00	44.42 AV	54.00	-9.58	1.54 V	350	12.49	31.93
3	*2404.00	108.49 PK			1.54 V	350	76.58	31.91
4	*2404.00	106.08 AV			1.54 V	350	74.17	31.91
5	4808.00	47.89 PK	74.00	-26.11	1.37 V	292	45.80	2.09
6	4808.00	35.27 AV	54.00	-18.73	1.37 V	292	33.18	2.09

**Remarks:**

1. Emission Level(dBuV/m) = Raw Value(dBuV) + Correction Factor(dB/m)
2. Correction Factor(dB/m) = Antenna Factor(dB/m) + Cable Factor(dB) – Pre-Amplifier Factor(dB)
3. Margin value = Emission Level – Limit value
4. The other emission levels were very low against the limit.
5. " \* " : Fundamental frequency.

<b>RF Mode</b>	TX BT-LE 2M	<b>Channel</b>	CH 19 : 2440 MHz
<b>Frequency Range</b>	1 GHz ~ 25 GHz	<b>Detector Function &amp; Bandwidth</b>	(PK) RB = 1 MHz, VB = 3 MHz (AV) RB = 1 MHz, VB = 5.2 kHz
<b>Input Power</b>	120 Vac, 60 Hz	<b>Environmental Conditions</b>	23°C, 68% RH
<b>Tested By</b>	Wade Huang	<b>Test Date</b>	2022/4/7

**Antenna Polarity & Test Distance : Horizontal at 3 m**

No	Frequency (MHz)	Emission Level (dBuV/m)	Limit (dBuV/m)	Margin (dB)	Antenna Height (m)	Table Angle (Degree)	Raw Value (dBuV)	Correction Factor (dB/m)
1	*2440.00	98.30 PK			3.69 H	156	66.47	31.83
2	*2440.00	95.86 AV			3.69 H	156	64.03	31.83
3	4880.00	44.91 PK	74.00	-29.09	1.39 H	35	42.78	2.13
4	4880.00	34.31 AV	54.00	-19.69	1.39 H	35	32.18	2.13

**Antenna Polarity & Test Distance : Vertical at 3 m**

No	Frequency (MHz)	Emission Level (dBuV/m)	Limit (dBuV/m)	Margin (dB)	Antenna Height (m)	Table Angle (Degree)	Raw Value (dBuV)	Correction Factor (dB/m)
1	*2440.00	108.60 PK			2.22 V	342	76.77	31.83
2	*2440.00	106.19 AV			2.22 V	342	74.36	31.83
3	4880.00	46.71 PK	74.00	-27.29	1.38 V	290	44.58	2.13
4	4880.00	33.79 AV	54.00	-20.21	1.38 V	290	31.66	2.13

**Remarks:**

1. Emission Level(dBuV/m) = Raw Value(dBuV) + Correction Factor(dB/m)
2. Correction Factor(dB/m) = Antenna Factor(dB/m) + Cable Factor(dB) – Pre-Amplifier Factor(dB)
3. Margin value = Emission Level – Limit value
4. The other emission levels were very low against the limit.
5. " \* " : Fundamental frequency.

<b>RF Mode</b>	TX BT-LE 2M	<b>Channel</b>	CH 38 : 2478 MHz
<b>Frequency Range</b>	1 GHz ~ 25 GHz	<b>Detector Function &amp; Bandwidth</b>	(PK) RB = 1 MHz, VB = 3 MHz (AV) RB = 1 MHz, VB = 5.2 kHz
<b>Input Power</b>	120 Vac, 60 Hz	<b>Environmental Conditions</b>	23°C, 68% RH
<b>Tested By</b>	Wade Huang	<b>Test Date</b>	2022/4/7

**Antenna Polarity & Test Distance : Horizontal at 3 m**

No	Frequency (MHz)	Emission Level (dBuV/m)	Limit (dBuV/m)	Margin (dB)	Antenna Height (m)	Table Angle (Degree)	Raw Value (dBuV)	Correction Factor (dB/m)
1	*2478.00	98.27 PK			3.59 H	161	66.41	31.86
2	*2478.00	95.86 AV			3.59 H	161	64.00	31.86
3	2483.50	57.97 PK	74.00	-16.03	3.59 H	161	26.10	31.87
4	2483.50	44.83 AV	54.00	-9.17	3.59 H	161	12.96	31.87
5	4956.00	46.27 PK	74.00	-27.73	1.35 H	41	44.03	2.24
6	4956.00	33.45 AV	54.00	-20.55	1.35 H	41	31.21	2.24

**Antenna Polarity & Test Distance : Vertical at 3 m**

No	Frequency (MHz)	Emission Level (dBuV/m)	Limit (dBuV/m)	Margin (dB)	Antenna Height (m)	Table Angle (Degree)	Raw Value (dBuV)	Correction Factor (dB/m)
1	*2478.00	107.70 PK			1.87 V	348	75.84	31.86
2	*2478.00	105.23 AV			1.87 V	348	73.37	31.86
3	2483.50	57.05 PK	74.00	-16.95	1.87 V	348	25.18	31.87
4	2483.50	47.23 AV	54.00	-6.77	1.87 V	348	15.36	31.87
5	4956.00	46.07 PK	74.00	-27.93	1.35 V	294	43.83	2.24
6	4956.00	33.18 AV	54.00	-20.82	1.35 V	294	30.94	2.24

**Remarks:**

1. Emission Level(dBuV/m) = Raw Value(dBuV) + Correction Factor(dB/m)
2. Correction Factor(dB/m) = Antenna Factor(dB/m) + Cable Factor(dB) – Pre-Amplifier Factor(dB)
3. Margin value = Emission Level – Limit value
4. The other emission levels were very low against the limit.
5. " \* " : Fundamental frequency.

**9 kHz ~ 1 GHz Worst-Case Data:**

<b>RF Mode</b>	TX BT-LE 2M	<b>Channel</b>	CH 19 : 2440 MHz
<b>Frequency Range</b>	30 MHz ~ 1 GHz	<b>Detector Function &amp; Bandwidth</b>	(QP) RB = 120kHz
<b>Input Power</b>	120 Vac, 60 Hz	<b>Environmental Conditions</b>	23°C, 66% RH
<b>Tested By</b>	Wade Huang	<b>Test Date</b>	2022/4/11

**Antenna Polarity & Test Distance : Horizontal at 3 m**

No	Frequency (MHz)	Emission Level (dBuV/m)	Limit (dBuV/m)	Margin (dB)	Antenna Height (m)	Table Angle (Degree)	Raw Value (dBuV)	Correction Factor (dB/m)
1	157.07	25.75 QP	43.50	-17.75	1.99 H	260	38.90	-13.15
2	224.97	22.05 QP	46.00	-23.95	1.51 H	6	38.86	-16.81
3	257.95	22.64 QP	46.00	-23.36	1.01 H	105	37.17	-14.53
4	308.39	22.49 QP	46.00	-23.51	1.51 H	304	35.31	-12.82
5	435.46	25.03 QP	46.00	-20.97	1.01 H	268	34.36	-9.33
6	575.14	32.29 QP	46.00	-13.71	1.51 H	269	38.87	-6.58

**Remarks:**

1. Emission Level(dBuV/m) = Raw Value(dBuV) + Correction Factor(dB/m)
2. Correction Factor(dB/m) = Antenna Factor(dB/m) + Cable Factor(dB) – Pre-Amplifier Factor(dB)
3. Margin value = Emission Level – Limit value
4. The other emission levels were very low against the limit of frequency range 30 MHz ~ 1 GHz.
5. The emission levels were very low against the limit of frequency range 9 kHz ~ 30 MHz: the amplitude of spurious emissions attenuated more than 20 dB below the permissible value to be report.

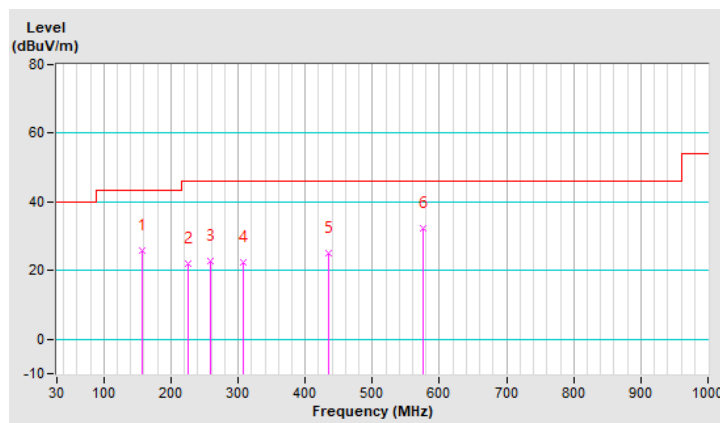

<b>RF Mode</b>	TX BT-LE 2M	<b>Channel</b>	CH 19 : 2440 MHz
<b>Frequency Range</b>	30 MHz ~ 1 GHz	<b>Detector Function &amp; Bandwidth</b>	(QP) RB = 120kHz
<b>Input Power</b>	120 Vac, 60 Hz	<b>Environmental Conditions</b>	23°C, 66% RH
<b>Tested By</b>	Wade Huang	<b>Test Date</b>	2022/4/11

Antenna Polarity & Test Distance : Vertical at 3 m								
No	Frequency (MHz)	Emission Level (dBuV/m)	Limit (dBuV/m)	Margin (dB)	Antenna Height (m)	Table Angle (Degree)	Raw Value (dBuV)	Correction Factor (dB/m)
1	44.55	28.59 QP	40.00	-11.41	1.01 V	103	41.94	-13.35
2	147.37	22.72 QP	43.50	-20.78	1.01 V	36	35.91	-13.19
3	158.04	26.95 QP	43.50	-16.55	1.01 V	2	40.09	-13.14
4	315.18	23.20 QP	46.00	-22.80	1.49 V	145	35.74	-12.54
5	482.99	25.63 QP	46.00	-20.37	1.01 V	168	34.21	-8.58
6	572.23	29.95 QP	46.00	-16.05	1.01 V	230	36.63	-6.68

**Remarks:**

1. Emission Level(dBuV/m) = Raw Value(dBuV) + Correction Factor(dB/m)
2. Correction Factor(dB/m) = Antenna Factor(dB/m) + Cable Factor(dB) – Pre-Amplifier Factor(dB)
3. Margin value = Emission Level – Limit value
4. The other emission levels were very low against the limit of frequency range 30 MHz ~ 1 GHz.
5. The emission levels were very low against the limit of frequency range 9 kHz ~ 30 MHz: the amplitude of spurious emissions attenuated more than 20 dB below the permissible value to be report.

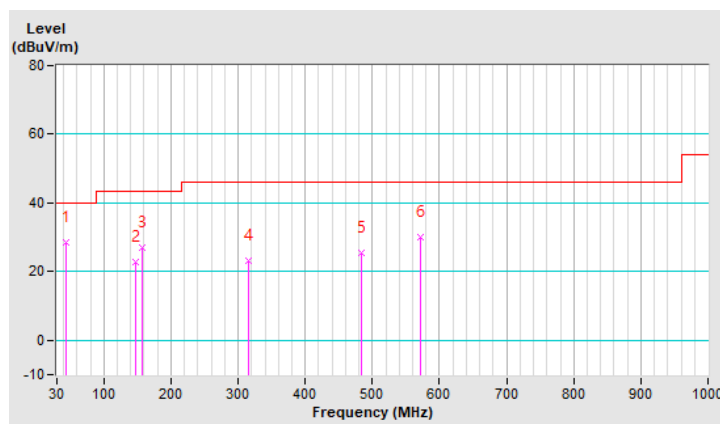

## 4.2 Conducted Emission Measurement

### 4.2.1 Limits of Conducted Emission Measurement

Frequency (MHz)	Conducted Limit (dBUV)	
	Quasi-Peak	Average
0.15 - 0.5	66 - 56	56 - 46
0.50 - 5.0	56	46
5.0 - 30.0	60	50

- Note: 1. The lower limit shall apply at the transition frequencies.  
 2. The limit decreases in line with the logarithm of the frequency in the range of 0.15 to 0.50 MHz.

### 4.2.2 Test Instruments

Description & Manufacturer	Model No.	Serial No.	Date of Calibration	Due Date of Calibration
Test Receiver ROHDE & SCHWARZ	ESR3	102412	Jan. 22, 2022	Jan. 21, 2023
RF Coaxial Cable WORKEN	5D-FB	Cable-cond2-01	Sep. 4, 2021	Sep. 3, 2022
LISN/AMN ROHDE & SCHWARZ (EUT)	ESH2-Z5	100100	Feb. 17, 2022	Feb. 16, 2023
LISN/AMN ROHDE & SCHWARZ (Peripheral)	ESH3-Z5	100312	Sep. 17, 2021	Sep. 16, 2022
Software ADT	BV ADT_Cond_ V7.3.7.4	NA	NA	NA

- Note: 1. The calibration interval of the above test instruments is 12 months and the calibrations are traceable to NML/ROC and NIST/USA.  
 2. The test was performed in HwaYa Shielded Room 2.  
 3. The VCCI Site Registration No. is C-12047.

### 4.2.3 Test Procedures

- The EUT was placed 0.4 meters from the conducting wall of the shielded room with EUT being connected to the power mains through a line impedance stabilization network (LISN). Other support units were connected to the power mains through another LISN. The two LISNs provide 50 ohm/50 uH of coupling impedance for the measuring instrument.
- Both lines of the power mains connected to the EUT were checked for maximum conducted interference.
- The frequency range from 150 kHz to 30 MHz was searched. Emission levels under (Limit – 20 dB) was not recorded.

**Note:** The resolution bandwidth and video bandwidth of test receiver is 9 kHz for quasi-peak detection (QP) and average detection (AV) at frequency 0.15 MHz - 30 MHz.

#### 4.2.4 Deviation from Test Standard

No deviation.

#### 4.2.5 Test Setup

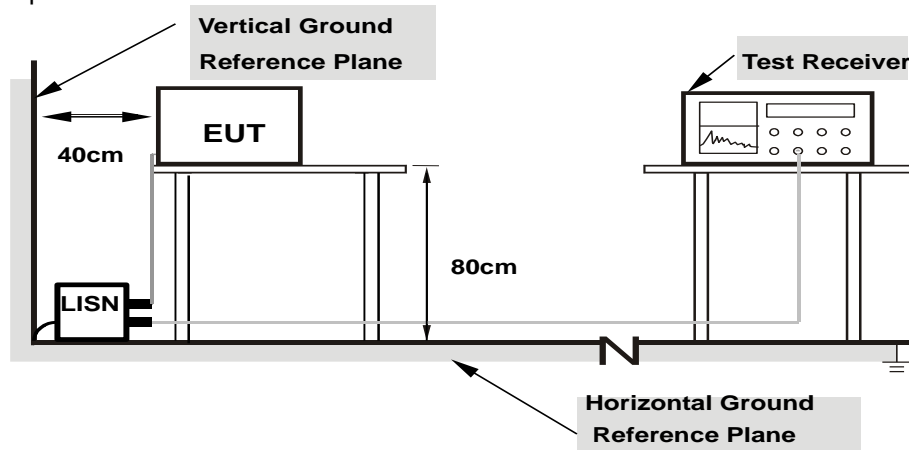

- Note:**
1. Support units were connected to second LISN.
  2. Both of LISNs (AMN) are 80 cm from EUT and at least 80 from other units and other metal planes

#### 4.2.6 EUT Operating Conditions

- a. Placed the EUT on the testing table.
- b. Set the EUT under transmission condition continuously at specific channel frequency.



#### 4.2.7 Test Results

#### CONDUCTED WORST-CASE DATA

<b>Frequency Range</b>	150 kHz ~ 30 MHz	<b>Detector Function &amp; Resolution Bandwidth</b>	Quasi-Peak (QP) / Average (AV), 9kHz
<b>Input Power</b>	120 Vac, 60 Hz	<b>Environmental Conditions</b>	25°C, 69% RH
<b>Tested by</b>	Wade Huang	<b>Test Date</b>	2022/4/11

Phase Of Power : Line (L)										
No	Frequency (MHz)	Correction Factor (dB)	Reading Value (dBuV)		Emission Level (dBuV)		Limit (dBuV)		Margin (dB)	
			Q.P.	AV.	Q.P.	AV.	Q.P.	AV.	Q.P.	AV.
1	0.15800	10.13	38.76	22.59	48.89	32.72	65.57	55.57	-16.68	-22.85
2	0.18085	10.14	34.97	18.23	45.11	28.37	64.45	54.45	-19.34	-26.08
3	0.20200	10.14	30.10	13.52	40.24	23.66	63.53	53.53	-23.29	-29.87
4	0.25000	10.15	24.88	12.23	35.03	22.38	61.76	51.76	-26.73	-29.38
5	2.00600	10.22	18.75	9.76	28.97	19.98	56.00	46.00	-27.03	-26.02
6	22.83400	10.30	16.52	6.40	26.82	16.70	60.00	50.00	-33.18	-33.30

#### Remarks:

1. Q.P. and AV. are abbreviations of quasi-peak and average individually.
2. The emission levels of other frequencies were very low against the limit.
3. Margin value = Emission level – Limit value
4. Correction factor = Insertion loss + Cable loss
5. Emission Level = Correction Factor + Reading Value

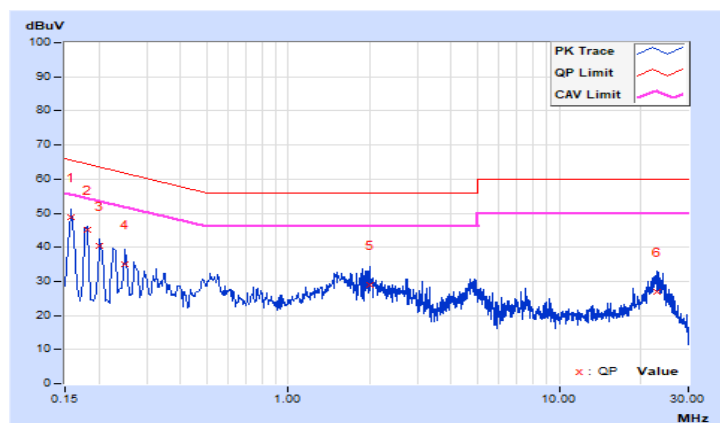

<b>Frequency Range</b>	150 kHz ~ 30 MHz	<b>Detector Function &amp; Resolution Bandwidth</b>	Quasi-Peak (QP) / Average (AV), 9kHz
<b>Input Power</b>	120 Vac, 60 Hz	<b>Environmental Conditions</b>	25°C, 69% RH
<b>Tested by</b>	Wade Huang	<b>Test Date</b>	2022/4/11

Phase Of Power : Neutral (N)										
No	Frequency (MHz)	Correction Factor (dB)	Reading Value (dBuV)		Emission Level (dBuV)		Limit (dBuV)		Margin (dB)	
			Q.P.	AV.	Q.P.	AV.	Q.P.	AV.	Q.P.	AV.
1	0.16600	10.14	34.79	19.43	44.93	29.57	65.16	55.16	-20.23	-25.59
2	0.19265	10.15	33.84	18.11	43.99	28.26	63.92	53.92	-19.93	-25.66
3	0.22565	10.15	26.95	12.02	37.10	22.17	62.61	52.61	-25.51	-30.44
4	0.22565	10.15	26.77	12.16	36.92	22.31	62.61	52.61	-25.69	-30.30
5	1.58600	10.22	21.88	16.85	32.10	27.07	56.00	46.00	-23.90	-18.93
6	21.07400	10.51	15.46	6.03	25.97	16.54	60.00	50.00	-34.03	-33.46

**Remarks:**

1. Q.P. and AV. are abbreviations of quasi-peak and average individually.
2. The emission levels of other frequencies were very low against the limit.
3. Margin value = Emission level – Limit value
4. Correction factor = Insertion loss + Cable loss
5. Emission Level = Correction Factor + Reading Value

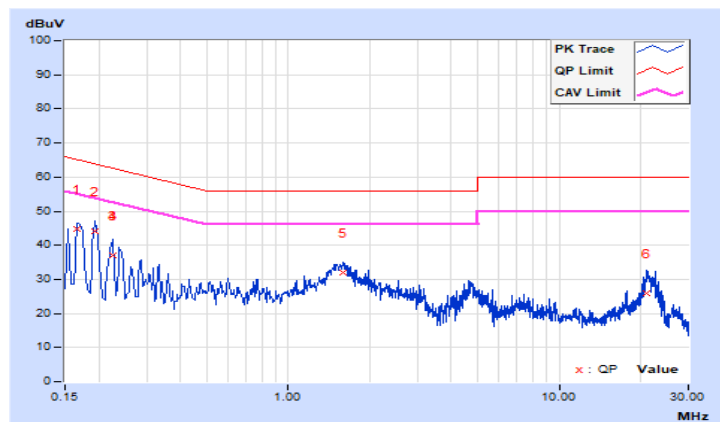

### 4.3 6 dB Bandwidth Measurement

#### 4.3.1 Limits of 6 dB Bandwidth Measurement

The minimum of 6 dB Bandwidth Measurement is 0.5 MHz.

#### 4.3.2 Test Setup

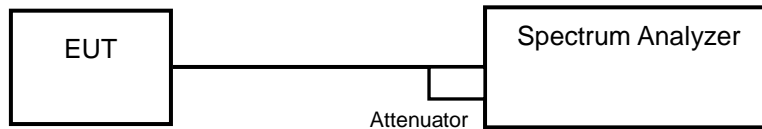

#### 4.3.3 Test Instruments

Refer to section 4.1.2 to get information of above instrument.

#### 4.3.4 Test Procedure

- a. Set resolution bandwidth (RBW) = 100 kHz
- b. Set the video bandwidth (VBW)  $\geq 3 \times$  RBW, Detector = Peak.
- c. Trace mode = max hold.
- d. Sweep = auto couple.
- e. Measure the maximum width of the emission that is constrained by the frequencies associated with the two amplitude points (upper and lower) that are attenuated by 6 dB relative to the maximum level measured in the fundamental emission

#### 4.3.5 Deviation from Test Standard

No deviation.

#### 4.3.6 EUT Operating Conditions

The software provided by client to enable the EUT under transmission condition continuously at lowest, middle and highest channel frequencies individually.



<2MBaud PHY>

Channel	Frequency (MHz)	6 dB Bandwidth (MHz)	Minimum Limit (MHz)	Pass / Fail
1	2404	1.10	0.5	Pass
19	2440	1.10	0.5	Pass
38	2478	1.11	0.5	Pass

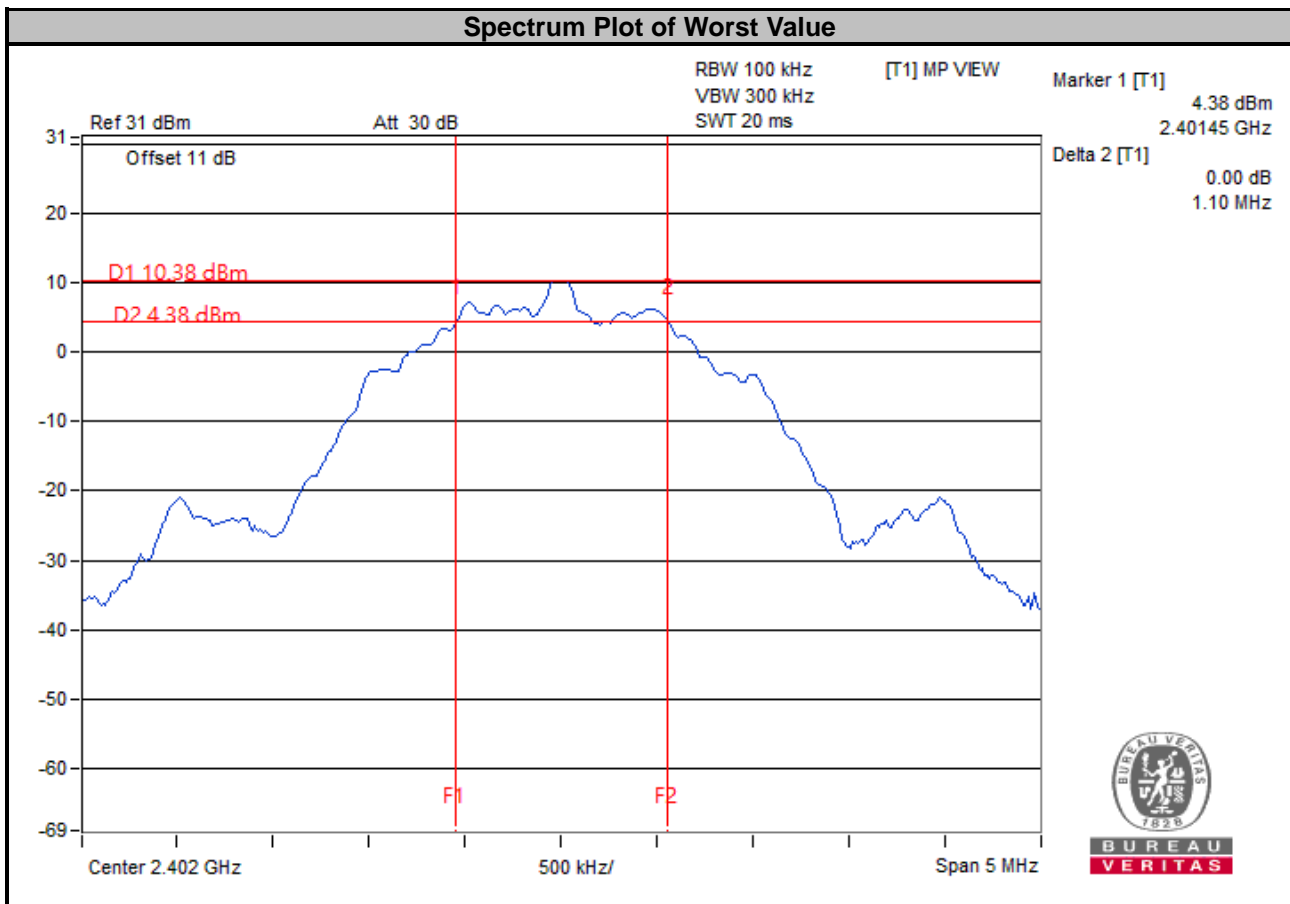

## 4.4 Occupied Bandwidth Measurement

### 4.4.1 Test Setup

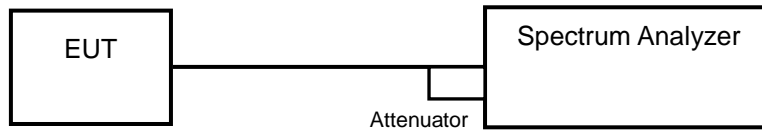

### 4.4.2 Test Instruments

Refer to section 4.1.2 to get information of above instrument.

### 4.4.3 Test Procedure

The transmitter output was connected to the spectrum analyzer through an attenuator. The bandwidth of the fundamental frequency was measured by spectrum analyzer with resolution bandwidth in the range of 1 % to 5 % of the anticipated emission bandwidth, and a video bandwidth at least 3x the resolution bandwidth and set the detector to sampling. The width of a frequency band such that, below the lower and above the upper frequency limits, the mean powers emitted are each equal to a specified percentage 0.5 % of the total mean power of a given emission.

### 4.4.4 Deviation from Test Standard

No deviation.

### 4.4.5 EUT Operating Conditions

The software provided by client to enable the EUT under transmission condition continuously at lowest, middle and highest channel frequencies individually.

#### 4.4.6 Test Results

<1Mbaud PHY>

Channel	Frequency (MHz)	Occupied Bandwidth (MHz)	Pass / Fail
0	2402	1.05	Pass
1	2404	1.05	Pass
19	2440	1.05	Pass
38	2478	1.05	Pass
39	2480	1.05	Pass

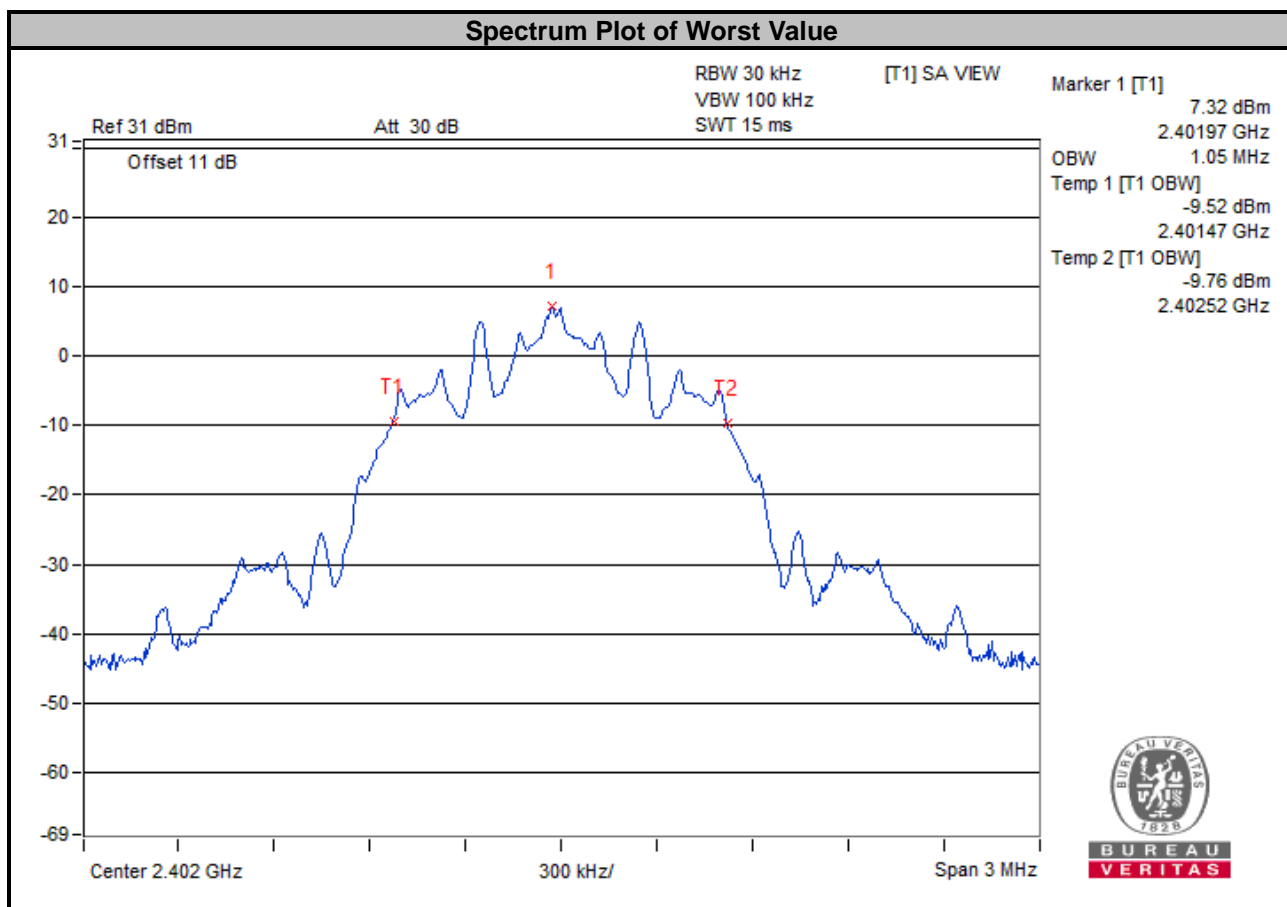

<2MBaud PHY>

Channel	Frequency (MHz)	Occupied Bandwidth (MHz)	Pass / Fail
1	2404	2.02	Pass
19	2440	2.03	Pass
38	2478	2.04	Pass

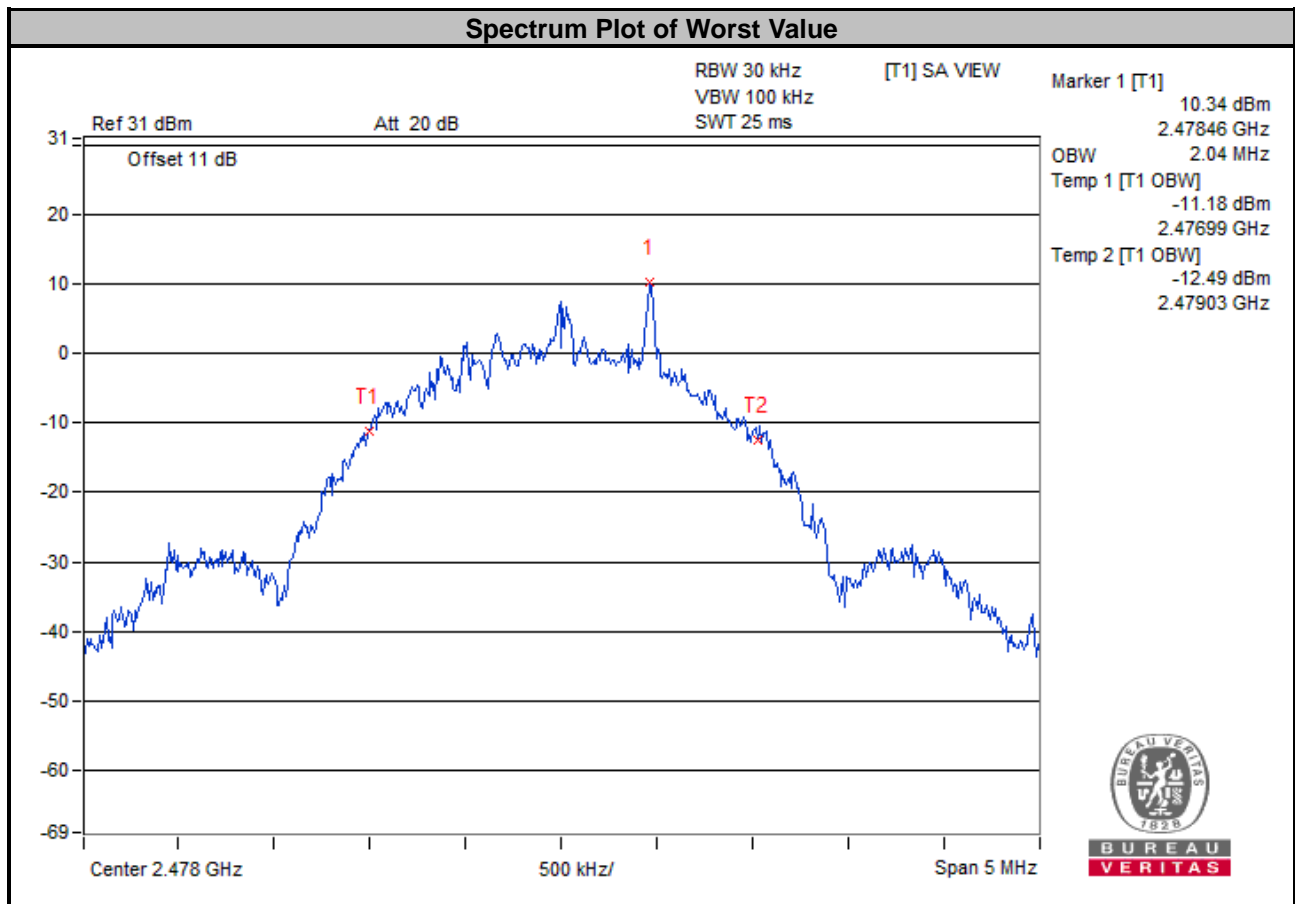



## 4.5 Conducted Output Power Measurement

### 4.5.1 Limits of Conducted Output Power Measurement

For systems using digital modulation in the 2400–2483.5 MHz bands: 1 Watt (30 dBm)

### 4.5.2 Test Setup

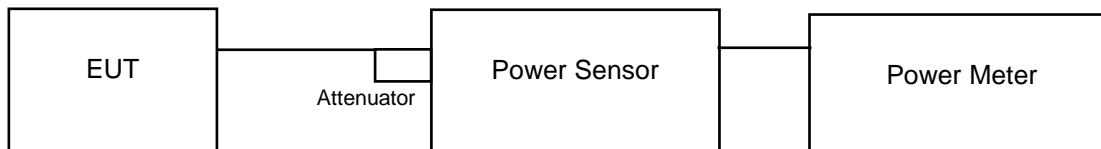

### 4.5.3 Test Instruments

Refer to section 4.1.2 to get information of above instrument.

### 4.5.4 Test Procedures

A peak power sensor was used on the output port of the EUT. A power meter was used to read the response of the peak power sensor. Record the power level.

Average power sensor was used to perform output power measurement, trigger and gating function of wide band power meter is enabled to measure max output power of TX on burst. Duty factor is not added to measured value.

### 4.5.5 Deviation from Test Standard

No deviation.

### 4.5.6 EUT Operating Conditions

The software provided by client to enable the EUT under transmission condition continuously at lowest, middle and highest channel frequencies individually.

#### 4.5.7 Test Results

##### <1MBaud PHY>

Channel	Freq. (MHz)	Peak Power		Average Power		Power Limit (mW)	Pass / Fail
		(mW)	(dBm)	(mW)	(dBm)		
0	2402	11.143	10.47	10.116	10.05	1000	Pass
1	2404	11.092	10.45	10.093	10.04	1000	Pass
19	2440	10.99	10.41	9.908	9.96	1000	Pass
38	2478	10.789	10.33	9.661	9.85	1000	Pass
39	2480	10.641	10.27	9.594	9.82	1000	Pass

##### <2MBaud PHY>

Channel	Freq. (MHz)	Peak Power		Average Power		Power Limit (mW)	Pass / Fail
		(mW)	(dBm)	(mW)	(dBm)		
1	2404	11.015	10.42	10.093	10.04	1000	Pass
19	2440	10.789	10.33	9.84	9.93	1000	Pass
38	2478	10.593	10.25	9.638	9.84	1000	Pass

## 4.6 Power Spectral Density Measurement

### 4.6.1 Limits of Power Spectral Density Measurement

The Maximum of Power Spectral Density Measurement is 8 dBm in any 3 kHz band during any time interval of continuous transmission.

### 4.6.2 Test Setup

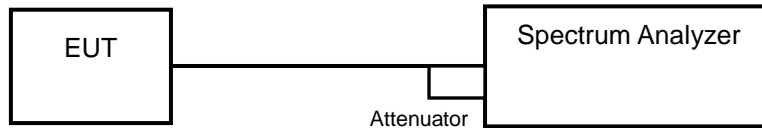

### 4.6.3 Test Instruments

Refer to section 4.1.2 to get information of above instrument.

### 4.6.4 Test Procedure

- a. Set analyzer center frequency to DTS channel center frequency.
- b. Set the span to 1.5 times the DTS bandwidth.
- c. Set the RBW to:  $3 \text{ kHz} \leq \text{RBW} \leq 100 \text{ kHz}$ .
- d. Set the VBW  $\geq 3 \times \text{RBW}$ .
- e. Detector = peak.
- f. Sweep time = auto couple.
- g. Trace mode = max hold.
- h. Allow trace to fully stabilize.
- i. Use the peak marker function to determine the maximum amplitude level within the RBW.

### 4.6.5 Deviation from Test Standard

No deviation.

### 4.6.6 EUT Operating Condition

The software provided by client to enable the EUT under transmission condition continuously at lowest, middle and highest channel frequencies individually.

#### 4.6.7 Test Results

<1Mbaud PHY>

Channel	Frequency (MHz)	PSD (dBm/3 kHz)	Limit (dBm/3 kHz)	Pass / Fail
0	2402	3.52	8	Pass
1	2404	3.50	8	Pass
19	2440	3.40	8	Pass
38	2478	3.33	8	Pass
39	2480	3.31	8	Pass

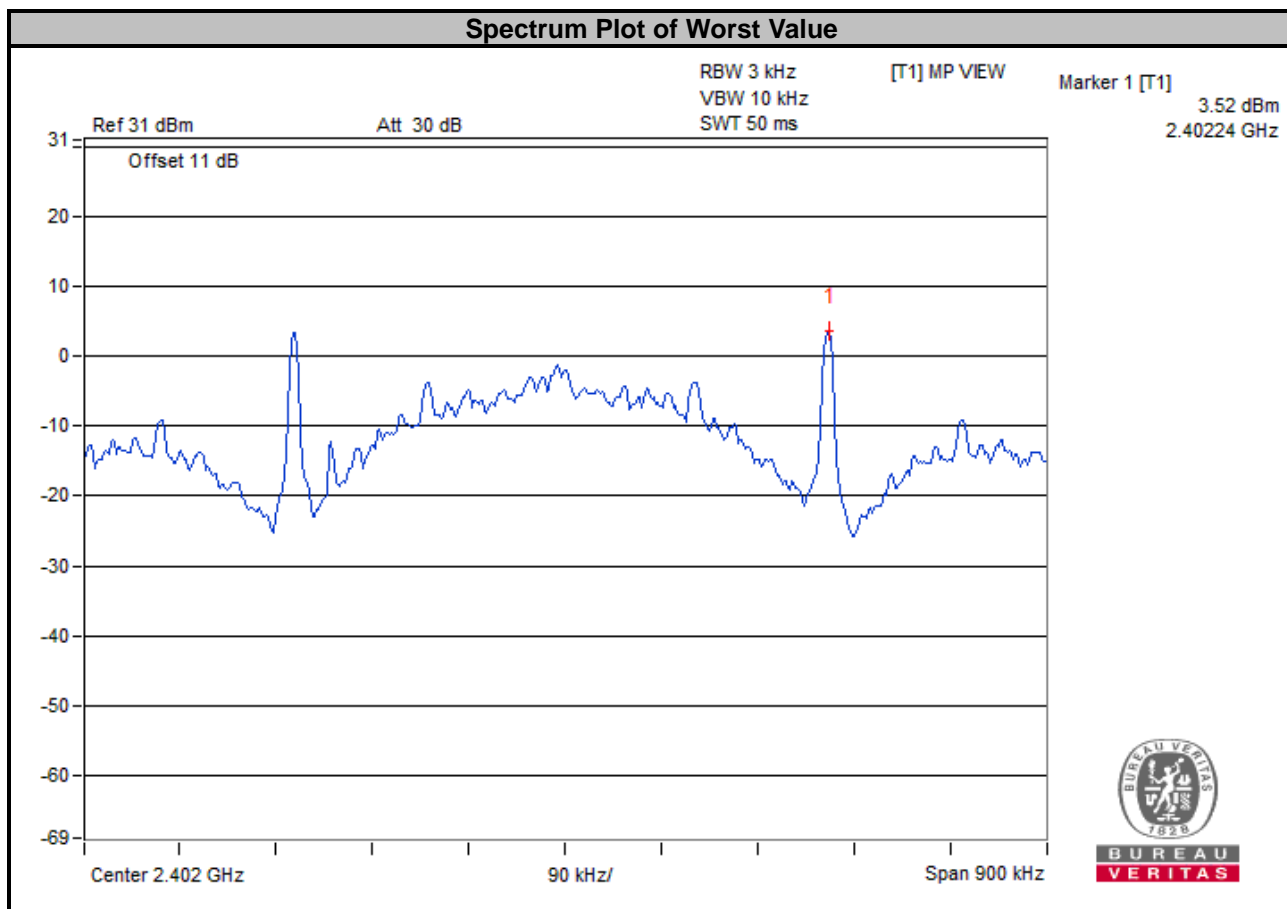

<2MBaud PHY>

Channel	Frequency (MHz)	PSD (dBm/3 kHz)	Limit (dBm/3 kHz)	Pass / Fail
1	2404	6.71	8	Pass
19	2440	6.64	8	Pass
38	2478	6.41	8	Pass

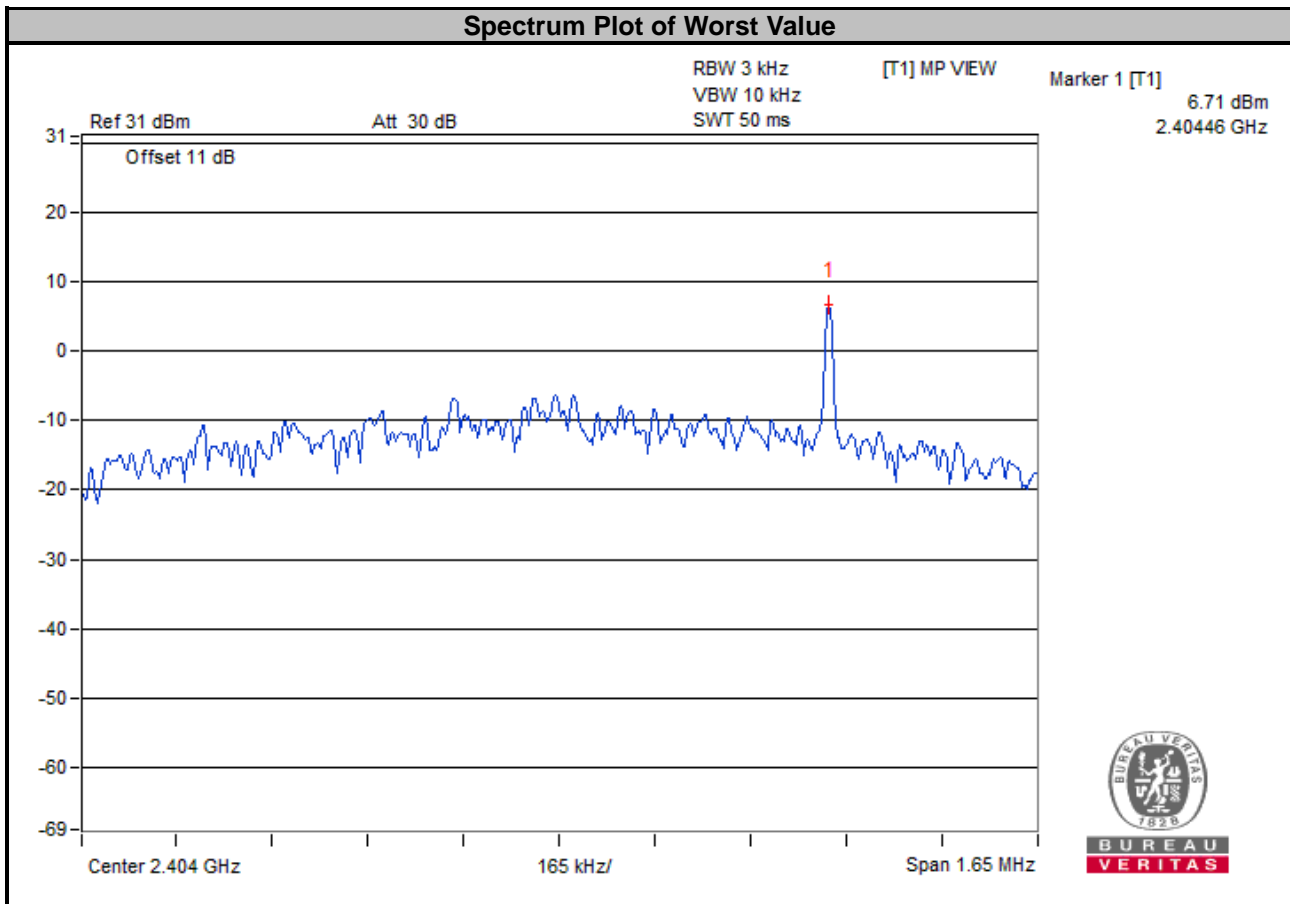

## 4.7 Conducted Out of Band Emission Measurement

### 4.7.1 Limits of Conducted Out of Band Emission Measurement

Below 20 dB of the highest emission level of operating band (in 100 kHz Resolution Bandwidth).

### 4.7.2 Test Setup



### 4.7.3 Test Instruments

Refer to section 4.1.2 to get information of above instrument.

### 4.7.4 Test Procedure

#### MEASUREMENT PROCEDURE REF

1. Set the RBW = 100 kHz.
2. Set the VBW  $\geq$  300 kHz.
3. Detector = peak.
4. Sweep time = auto couple.
5. Trace mode = max hold.
6. Allow trace to fully stabilize.
7. Use the peak marker function to determine the maximum power level in any 100 kHz band segment within the fundamental EBW.

#### MEASUREMENT PROCEDURE OOB

1. Set RBW = 100 kHz.
2. Set VBW  $\geq$  300 kHz.
3. Detector = peak.
4. Sweep = auto couple.
5. Trace Mode = max hold.
6. Allow trace to fully stabilize.
7. Use the peak marker function to determine the maximum amplitude level.

### 4.7.5 Deviation from Test Standard

No deviation.

### 4.7.6 EUT Operating Condition

The software provided by client to enable the EUT under transmission condition continuously at lowest, middle and highest channel frequencies individually.

### 4.7.7 Test Results

The spectrum plots are attached on the following images. D1 line indicates the highest level, D2 line indicates the 20 dB offset below D1. It shows compliance with the requirement.

<1Mbaud PHY>

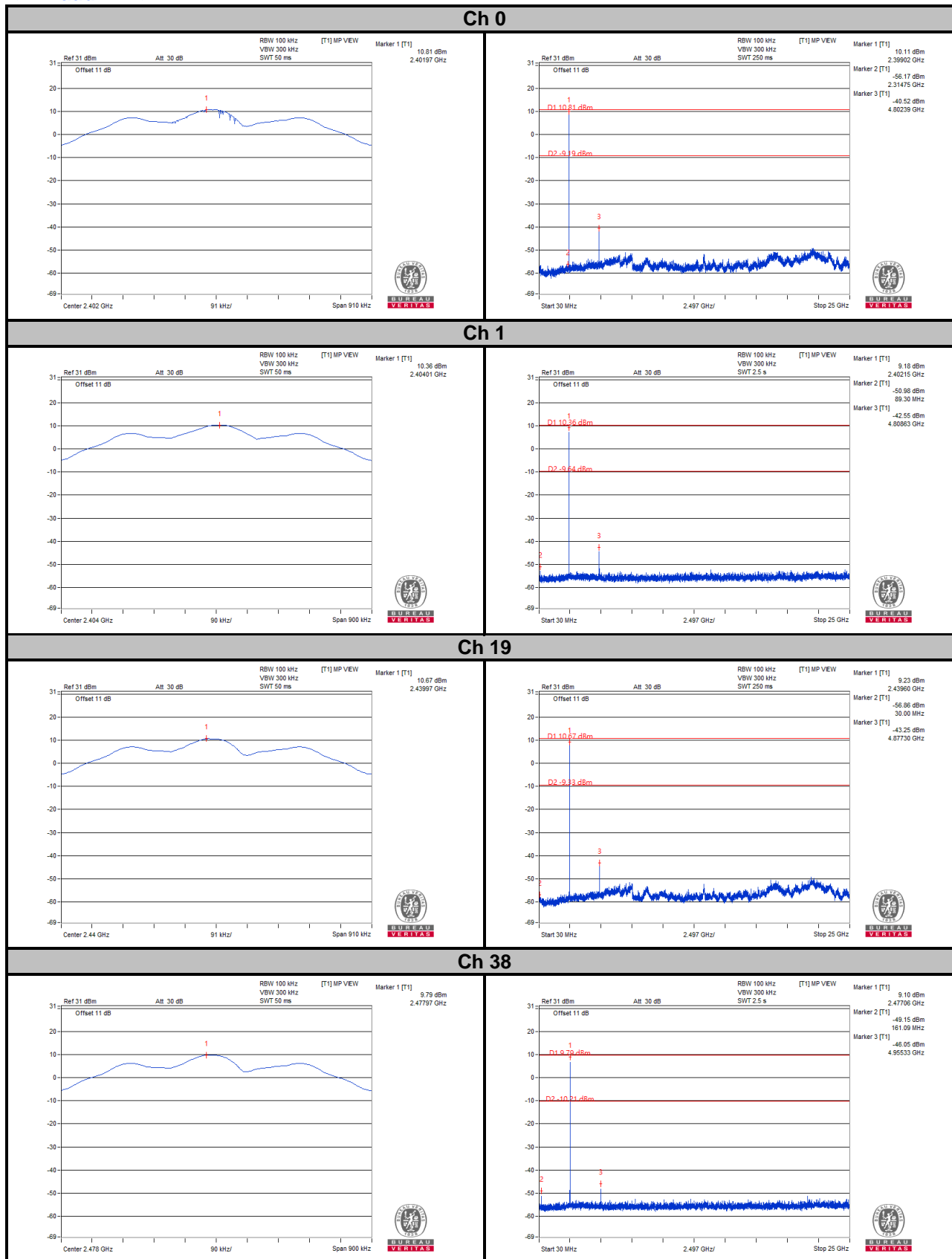

### Ch 39

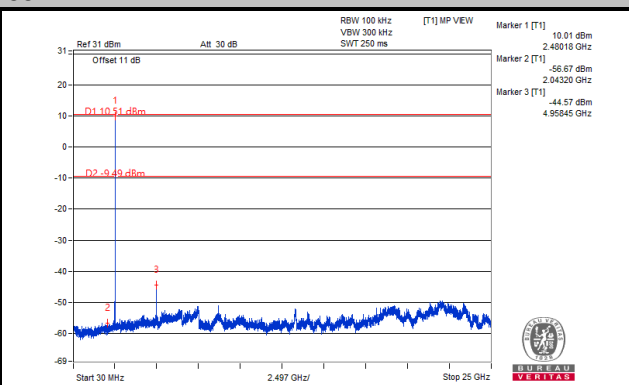
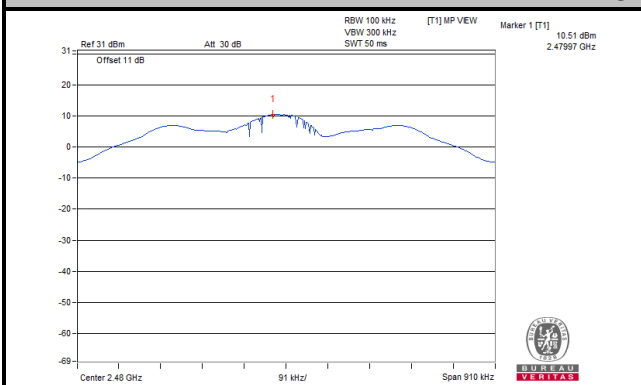

### Ch 0 Band Edge

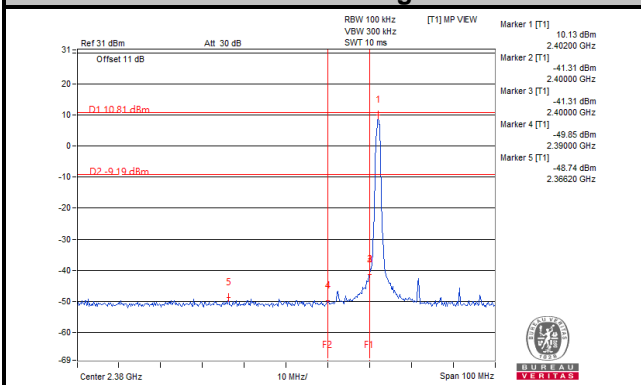

### Ch 1 Band Edge

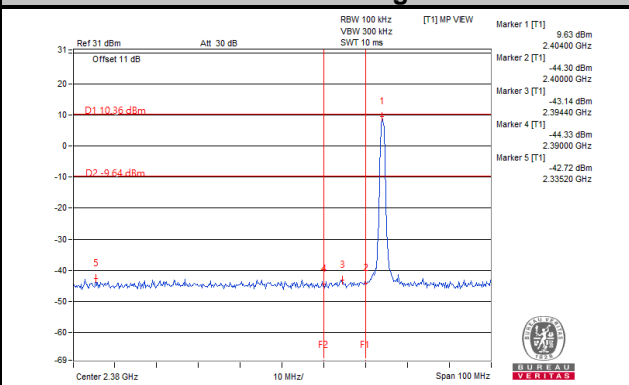

### Ch 38 Band Edge

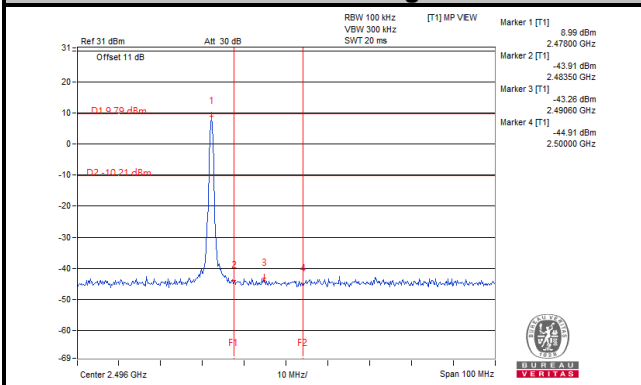

### Ch 39 Band Edge

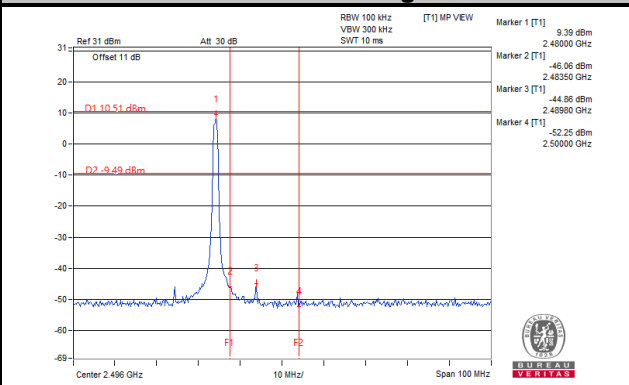



<2MBaud PHY>

Ch 1

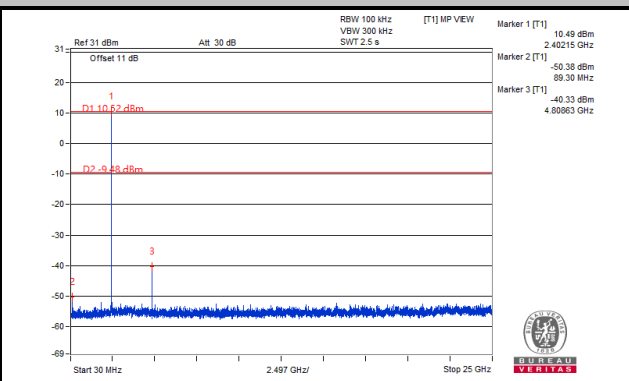
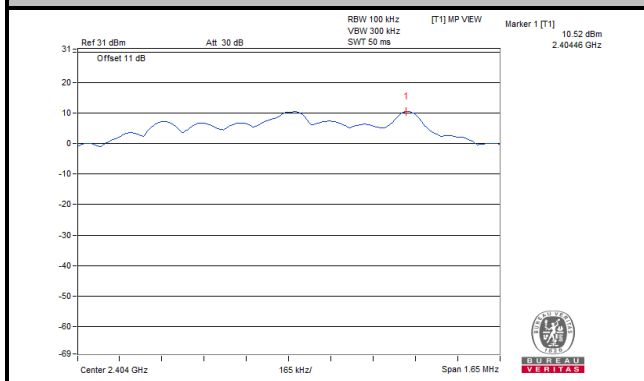

Ch 19

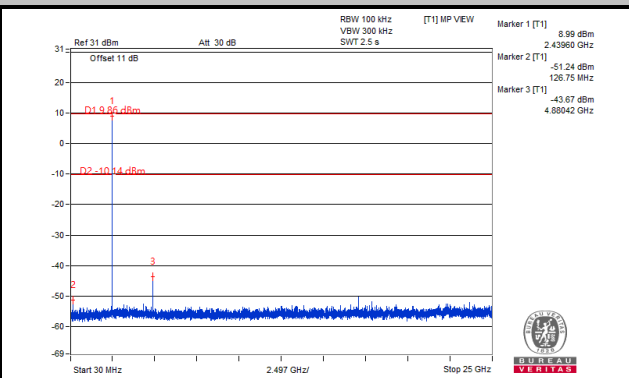
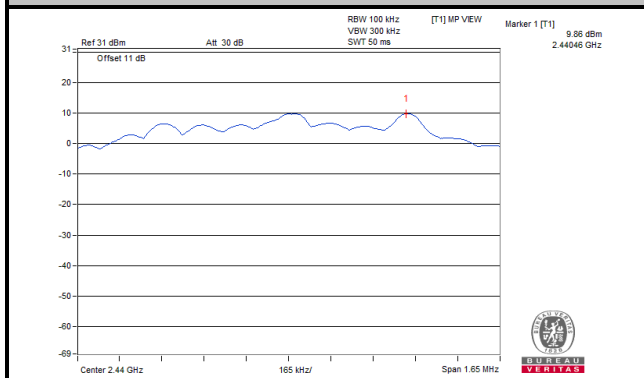

Ch 38

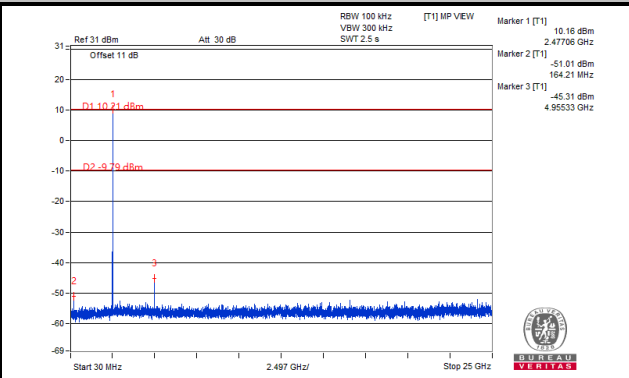
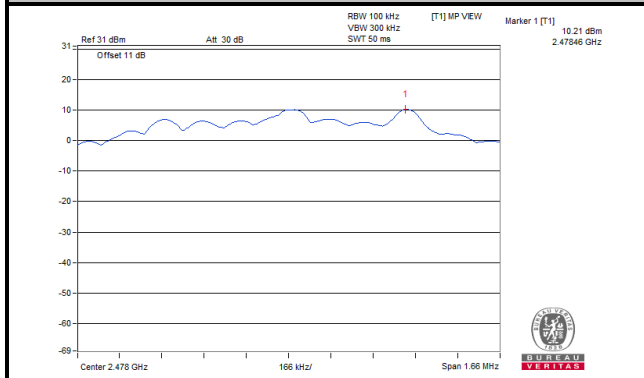

Ch 1 Band Edge

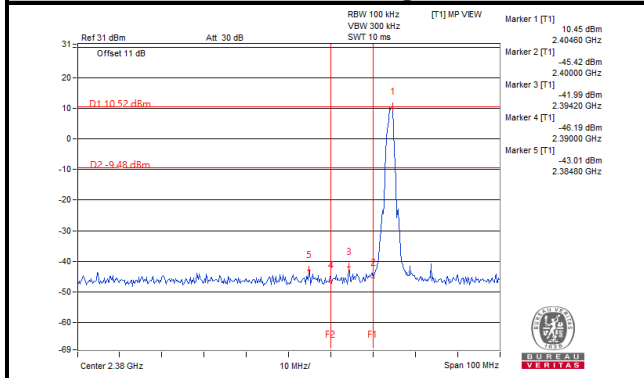

Ch 38 Band Edge

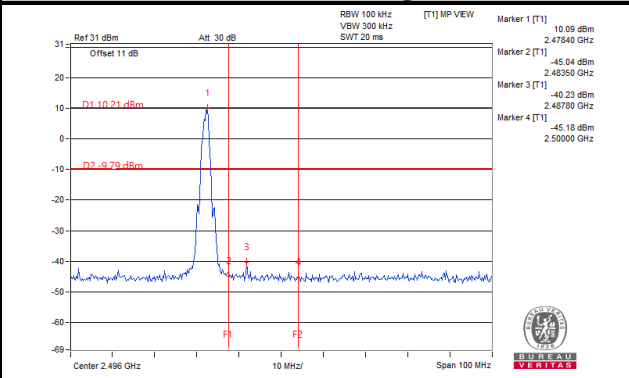

### Annex A- Band Edge Measurement

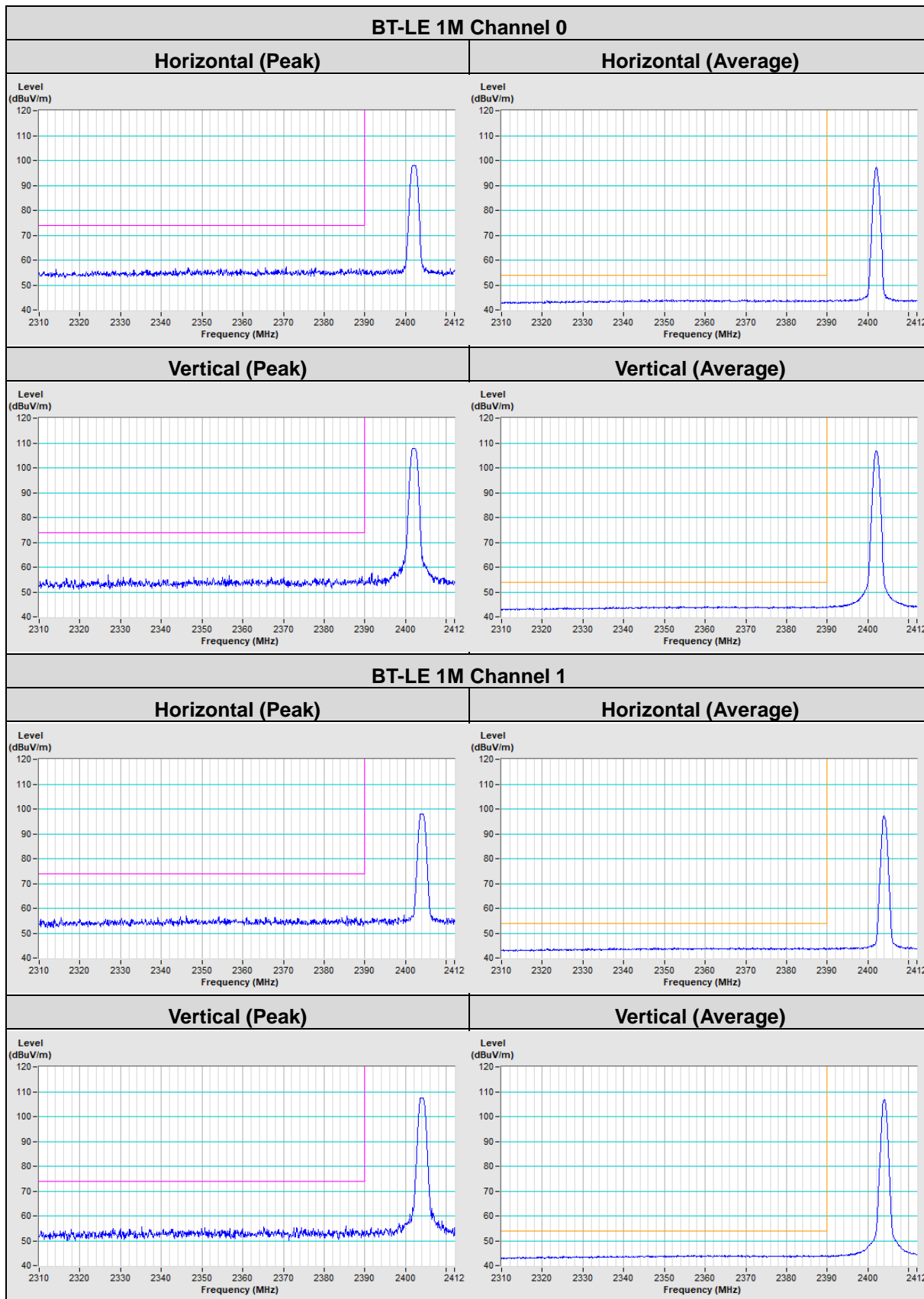



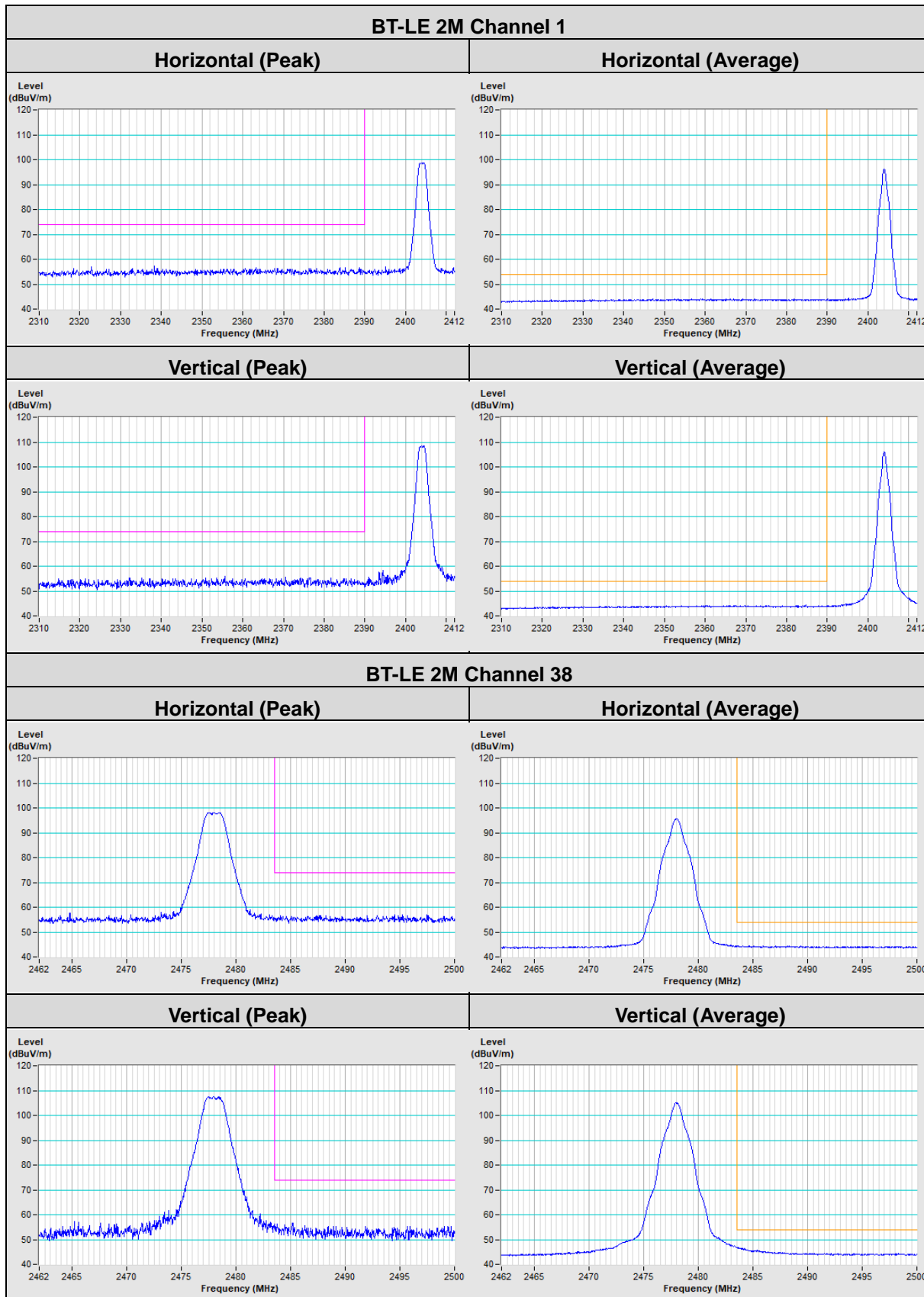

## 5 Pictures of Test Arrangements

Please refer to the attached file (Test Setup Photo).

## Appendix – Information of the Testing Laboratories

We, Bureau Veritas Consumer Products Services (H.K.) Ltd., Taoyuan Branch, were founded in 1988 to provide our best service in EMC, Radio, Telecom and Safety consultation. Our laboratories are FCC recognized accredited test firms and accredited according to ISO/IEC 17025.

If you have any comments, please feel free to contact us at the following:

**Lin Kou EMC/RF Lab**

Tel: 886-2-26052180

Fax: 886-2-26051924

**Hsin Chu EMC/RF/Telecom Lab**

Tel: 886-3-6668565

Fax: 886-3-6668323

**Hwa Ya EMC/RF/Safety Lab**

Tel: 886-3-3183232

Fax: 886-3-3270892

**Email:** [service.adt@tw.bureauveritas.com](mailto:service.adt@tw.bureauveritas.com)

**Web Site:** [www.bureauveritas-adt.com](http://www.bureauveritas-adt.com)

The address and road map of all our labs can be found in our web site also.

--- END ---