

FCC Test Report

(Bluetooth-LE)

Report No.: RFBHSC-WTW-P21030831-1

FCC ID: QOQ-BT122

Test Model: BT122-A

Received Date: Mar. 23, 2021

Test Date: Mar. 30, 2021 ~ Apr. 09, 2021

Issued Date: Apr. 27, 2021

Applicant: Silicon Laboratories Finland Oy

Address: Alberga Business Park - Bldg D/Floor 5, Bertel Jungin aukio 3, 02600
ESPOO, FINLAND

Issued By: Bureau Veritas Consumer Products Services (H.K.) Ltd., Taoyuan Branch
Lin Kou Laboratories

Lab Address: No. 47-2, 14th Ling, Chia Pau Vil., Lin Kou Dist., New Taipei City, Taiwan

Test Location: No.19, Hwa Ya 2nd Rd., Wen Hwa Vil., Kwei Shan Dist., Taoyuan City
33383, Taiwan

**FCC Registration /
Designation Number:** 788550 / TW0003



This report is for your exclusive use. Any copying or replication of this report to or for any other person or entity, or use of our name or trademark, is permitted only with our prior written permission. This report sets forth our findings solely with respect to the test samples identified herein. The results set forth in this report are not indicative or representative of the quality or characteristics of the lot from which a test sample was taken or any similar or identical product unless specifically and expressly noted. Our report includes all of the tests requested by you and the results thereof based upon the information that you provided to us. You have 60 days from date of issuance of this report to notify us of any material error or omission caused by our negligence, provided, however, that such notice shall be in writing and shall specifically address the issue you wish to raise. A failure to raise such issue within the prescribed time shall constitute your unqualified acceptance of the completeness of this report, the tests conducted and the correctness of the report contents. Unless specific mention, the uncertainty of measurement has been explicitly taken into account to declare the compliance or non-compliance to the specification.

Table of Contents

Release Control Record	4
1 Certificate of Conformity	5
2 Summary of Test Results.....	6
2.1 Measurement Uncertainty.....	6
2.2 Modification Record	6
3 General Information	7
3.1 General Description of EUT	7
3.2 Description of Test Modes.....	8
3.2.1 Test Mode Applicability and Tested Channel Detail.....	9
3.3 Duty Cycle of Test Signal	10
3.4 Description of Support Units	11
3.4.1 Configuration of System under Test	11
3.5 General Description of Applied Standards and References	11
4 Test Types and Results	12
4.1 Radiated Emission and Bandedge Measurement	12
4.1.1 Limits of Radiated Emission and Bandedge Measurement	12
4.1.2 Test Instruments	13
4.1.3 Test Procedures.....	14
4.1.4 Deviation from Test Standard	14
4.1.5 Test Set Up	15
4.1.6 EUT Operating Conditions.....	16
4.1.7 Test Results	17
4.2 Conducted Emission Measurement.....	22
4.2.1 Limits of Conducted Emission Measurement	22
4.2.2 Test Instruments	22
4.2.3 Test Procedures.....	22
4.2.4 Deviation from Test Standard	23
4.2.5 Test Setup.....	23
4.2.6 EUT Operating Conditions.....	23
4.2.7 Test Results	24
4.3 6 dB Bandwidth Measurement.....	26
4.3.1 Limits of 6 dB Bandwidth Measurement.....	26
4.3.2 Test Setup.....	26
4.3.3 Test Instruments	26
4.3.4 Test Procedure	26
4.3.5 Deviation from Test Standard	26
4.3.6 EUT Operating Conditions.....	26
4.3.7 Test Results	27
4.4 Occupied Bandwidth Measurement.....	28
4.4.1 Test Setup.....	28
4.4.2 Test Instruments	28
4.4.3 Test Procedure	28
4.4.4 Deviation from Test Standard	28
4.4.5 EUT Operating Conditions.....	28
4.4.6 Test Results	29
4.5 Conducted Output Power Measurement	30
4.5.1 Limits of Conducted Output Power Measurement.....	30
4.5.2 Test Setup.....	30
4.5.3 Test Instruments	30
4.5.4 Test Procedures.....	30
4.5.5 Deviation from Test Standard	30
4.5.6 EUT Operating Conditions.....	30
4.5.7 Test Results	30

4.6	Power Spectral Density Measurement	31
4.6.1	Limits of Power Spectral Density Measurement.....	31
4.6.2	Test Setup.....	31
4.6.3	Test Instruments	31
4.6.4	Test Procedure	31
4.6.5	Deviation from Test Standard	31
4.6.6	EUT Operating Condition	31
4.6.7	Test Results	32
4.7	Conducted Out of Band Emission Measurement	33
4.7.1	Limits of Conducted Out of Band Emission Measurement.....	33
4.7.2	Test Setup.....	33
4.7.3	Test Instruments	33
4.7.4	Test Procedure	33
4.7.5	Deviation from Test Standard	33
4.7.6	EUT Operating Condition	33
4.7.7	Test Results	34
Annex A-	Band Edge Measurement	35
5	Pictures of Test Arrangements.....	36
Appendix –	Information of the Testing Laboratories	37

Release Control Record

Issue No.	Description	Date Issued
RFBHSK-WTW-P21030831-1	Original Release	Apr. 27, 2021

1 Certificate of Conformity

Product: Bluetooth Dual-mode BR/EDR and Low Energy wireless radio module

Brand: Silicon Labs

Test Model: BT122-A

Sample Status: Engineering samples fully representing production modules

Applicant: Silicon Laboratories Finland Oy

Test Date: Mar. 30, 2021 ~ Apr. 09, 2021

Standards: 47 CFR FCC Part 15, Subpart C (Section 15.247)
ANSI C63.10:2013

The above equipment has been tested by **Bureau Veritas Consumer Products Services (H.K.) Ltd., Taoyuan Branch**, and found compliance with the requirement of the above standards. The test record, data evaluation & Equipment Under Test (EUT) configurations represented herein are true and accurate accounts of the measurements of the sample's RF characteristics under the conditions specified in this report.

Prepared by :  , Date: Apr. 27, 2021
Lena Wang / Specialist

Approved by :  , Date: Apr. 27, 2021
Dylan Chiou / Senior Project Engineer

2 Summary of Test Results

47 CFR FCC Part 15, Subpart C (Section 15.247)			
FCC Clause	Test Item	Result	Remarks
15.207	AC Power Conducted Emission	Pass	Meet the requirement of limit. Minimum passing margin is -16.23 dB at 0.47800 MHz.
15.205 & 209	Radiated Emissions	Pass	Meet the requirement of limit. Minimum passing margin is -5.1 dB at 82.38 MHz.
15.247(d)	Band Edge Measurement	Pass	Meet the requirement of limit.
15.247(d)	Antenna Port Emission	Pass	Meet the requirement of limit.
15.247(a)(2)	6 dB Bandwidth	Pass	Meet the requirement of limit.
---	Occupied Bandwidth Measurement	Pass	Reference only
15.247(b)	Conducted Power	Pass	Meet the requirement of limit.
15.247(e)	Power Spectral Density	Pass	Meet the requirement of limit.
15.203	Antenna Requirement	Pass	No antenna connector is used.

Note:

- For 2.4G band compliance with rule 15.247(d) of the band-edge items, the test plots were recorded in Annex A. Test Procedures refer to report 4.1.3.
- Determining compliance based on the results of the compliance measurement, not taking into account measurement instrumentation uncertainty.

2.1 Measurement Uncertainty

Where relevant, the following measurement uncertainty levels have been estimated for tests performed on the EUT as specified in CISPR 16-4-2:

Measurement	Frequency	Expanded Uncertainty (k=2) (±)
Conducted Emissions at mains ports	150 kHz ~ 30 MHz	2.79 dB
Radiated Emissions up to 1 GHz	9 kHz ~ 30 MHz	3.04 dB
	30 MHz ~ 200 MHz	2.93 dB
	200 MHz ~ 1000 MHz	2.95 dB
Radiated Emissions above 1 GHz	1 GHz ~ 18 GHz	2.26 dB
	18 GHz ~ 40 GHz	1.94 dB

2.2 Modification Record

There were no modifications required for compliance.

3 General Information

3.1 General Description of EUT

Product	Bluetooth Dual-mode BR/EDR and Low Energy wireless radio module
Brand	Silicon Labs
Test Model	BT122-A
Status of EUT	Engineering samples fully representing production modules
Power Supply Rating	Host board supply: 5V (by USB port) - Module supply: 3.3V (by host board's regulator)" Host board supply: 5V (by USB port, not in use) - Module supply: 3.3V (by external lab supply)
Modulation Type	GFSK
Transfer Rate	1 Mbps
Operating Frequency	2402 ~ 2480 MHz
Number of Channel	40
Output Power (Peak Power)	5.458 mW
Antenna Type	Chip antenna with 2.1 dBi gain
Antenna Connector	N/A
Accessory Device	N/A
Data Cable Supplied	N/A

Note:

1. Power setting is as below:

Modulation type: GFSK	
Channel	Power Setting
0	Default
19	Default
39	Default

2. The DUT was configured to transmit at its max power.
3. The above Antenna information is declared by manufacturer and for more detailed features description, please refer to the manufacturer's specifications, the laboratory shall not be held responsible.
4. The above EUT information is declared by manufacturer and for more detailed features description, please refers to the manufacturer's specifications or User's Manual.

3.2 Description of Test Modes

40 channels are provided to this EUT:

Channel	Freq. (MHz)	Channel	Freq. (MHz)	Channel	Freq. (MHz)	Channel	Freq. (MHz)
0	2402	10	2422	20	2442	30	2462
1	2404	11	2424	21	2444	31	2464
2	2406	12	2426	22	2446	32	2466
3	2408	13	2428	23	2448	33	2468
4	2410	14	2430	24	2450	34	2470
5	2412	15	2432	25	2452	35	2472
6	2414	16	2434	26	2454	36	2474
7	2416	17	2436	27	2456	37	2476
8	2418	18	2438	28	2458	38	2478
9	2420	19	2440	29	2460	39	2480

3.2.1 Test Mode Applicability and Tested Channel Detail

EUT Configure Mode	Applicable To				Description
	RE \geq 1G	RE<1G	PLC	APCM	
-	√	√	√	√	-

Where **RE \geq 1G**: Radiated Emission above 1 GHz **RE<1G**: Radiated Emission below 1 GHz
PLC: Power Line Conducted Emission **APCM**: Antenna Port Conducted Measurement

Note: The EUT had been pre-tested on the positioned of each 3 axis. The worst case was found when positioned on **Z-plane**.
Note: “-” means no effect.

Radiated Emission Test (Above 1 GHz):

- Pre-Scan has been conducted to determine the worst-case mode from all possible combinations between available modulations, data rates and antenna ports (if EUT with antenna diversity architecture).
- Following channel(s) was (were) selected for the final test as listed below.

EUT Configure Mode	Available Channel	Tested Channel	Modulation Type	Data Rate (Mbps)
-	0 to 39	0, 19, 39	GFSK	1

Radiated Emission Test (Below 1 GHz):

- Pre-Scan has been conducted to determine the worst-case mode from all possible combinations between available modulations, data rates and antenna ports (if EUT with antenna diversity architecture).
- Following channel(s) was (were) selected for the final test as listed below.

EUT Configure Mode	Available Channel	Tested Channel	Modulation Type	Data Rate (Mbps)
-	0 to 39	39	GFSK	1

Power Line Conducted Emission Test:

- Pre-Scan has been conducted to determine the worst-case mode from all possible combinations between available modulations, data rates and antenna ports (if EUT with antenna diversity architecture).
- Following channel(s) was (were) selected for the final test as listed below.

EUT Configure Mode	Available Channel	Tested Channel	Modulation Type	Data Rate (Mbps)
-	0 to 39	39	GFSK	1

Antenna Port Conducted Measurement:

- This item includes all test value of each mode, but only includes spectrum plot of worst value of each mode.
- Pre-Scan has been conducted to determine the worst-case mode from all possible combinations between available modulations, data rates and antenna ports (if EUT with antenna diversity architecture).
- Following channel(s) was (were) selected for the final test as listed below.

EUT Configure Mode	Available Channel	Tested Channel	Modulation Type	Data Rate (Mbps)
-	0 to 39	0, 19, 39	GFSK	1

Test Condition:

Applicable To	Environmental Conditions	Input Power	Tested by
RE≥1G	25 deg. C, 65 % RH	120 Vac, 60 Hz	Greg Lin
RE<1G	25 deg. C, 65 % RH	120 Vac, 60 Hz	Greg Lin
PLC	25 deg. C, 65 % RH	120 Vac, 60 Hz	Greg Lin
APCM	25 deg. C, 65 % RH	5 Vdc	Iven Tseng

3.3 Duty Cycle of Test Signal

Duty cycle of test signal is < 98 %, duty factor shall be considered.

Duty cycle = $0.405/0.627 = 0.646$, Duty factor = $10 * \log(1/0.646) = 1.90$

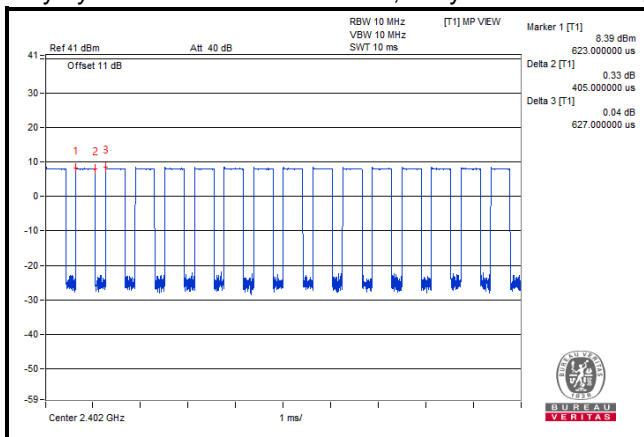

3.4 Description of Support Units

The EUT has been tested as an independent unit together with other necessary accessories or support units. The following support units or accessories were used to form a representative test configuration during the tests.

No.	Product	Brand	Model No.	Serial No.	FCC ID
A	DC Power Supply	Topward	3303D	N/A	N/A
B	Notebook	Lenovo	20J4 MD A003TW	PF-11H9AK	N/A

No.	Signal Cable Description Of The Above Support Units
1.	DC Cable: 3m
2.	USB Cable: 3m, Provided by client

Note:

1. All power cords of the above support units are non-shielded (1.8m).
2. Items B acted as communication partners to transfer data.

3.4.1 Configuration of System under Test

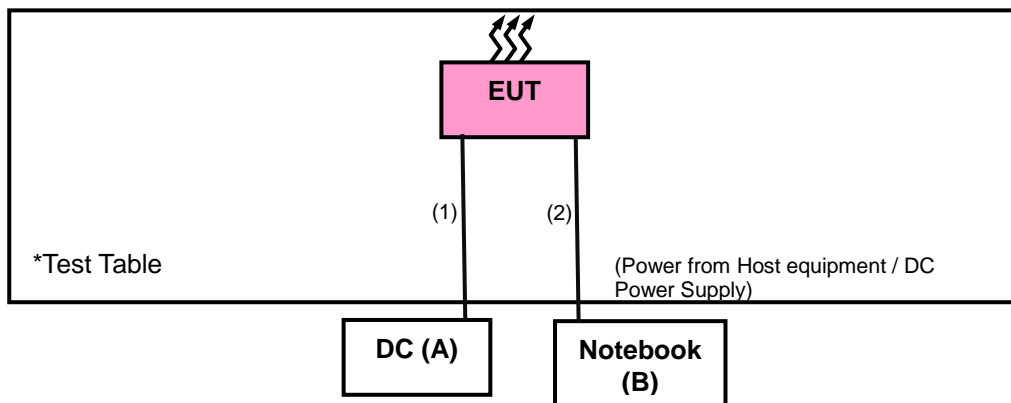

3.5 General Description of Applied Standards and References

The EUT is a RF Product. According to the specifications of the manufacturer, it must comply with the requirements of the following standards and references:

Test Standard:

FCC Part 15, Subpart C (15.247)

ANSI C63.10-2013

All test items have been performed and recorded as per the above standards.

References Test Guidance:

KDB 558074 D01 15.247 Meas Guidance v05r02

All test items have been performed as a reference to the above KDB test guidance.

4 Test Types and Results

4.1 Radiated Emission and Bandedge Measurement

4.1.1 Limits of Radiated Emission and Bandedge Measurement

Radiated emissions which fall in the restricted bands must comply with the radiated emission limits specified as below table. Other emissions shall be at least 20 dB below the highest level of the desired power:

Frequencies (MHz)	Field Strength (microvolts/meter)	Measurement Distance (meters)
0.009 ~ 0.490	2400/F (kHz)	300
0.490 ~ 1.705	24000/F (kHz)	30
1.705 ~ 30.0	30	30
30 ~ 88	100	3
88 ~ 216	150	3
216 ~ 960	200	3
Above 960	500	3

Note:

1. The lower limit shall apply at the transition frequencies.
2. Emission level (dBuV/m) = 20 log Emission level (uV/m).
3. For frequencies above 1000 MHz, the field strength limits are based on average detector, however, the peak field strength of any emission shall not exceed the maximum permitted average limits, specified above by more than 20 dB under any condition of modulation.

4.1.2 Test Instruments

Description & Manufacturer	Model No.	Serial No.	Date of Calibration	Due Date of Calibration
Test Receiver KEYSIGHT	N9038A	MY55420137	Apr. 22, 2020	Apr. 21, 2021
Spectrum Analyzer ROHDE & SCHWARZ	FSP40	100039	Jun. 12, 2020	Jun. 11, 2021
BILOG Antenna SCHWARZBECK	VULB9168	9168-160	Nov. 06, 2020	Nov. 05, 2021
HORN Antenna SCHWARZBECK	BBHA 9120 D	9120D-1169	Nov. 22, 2020	Nov. 21, 2021
HORN Antenna SCHWARZBECK	BBHA 9170	BBHA9170241	Nov. 22, 2020	Nov. 21, 2021
Preamplifier Agilent (Below 1GHz)	8447D	2944A10638	Jun. 08, 2020	Jun. 07, 2021
Preamplifier Agilent (Above 1GHz)	8449B	3008A02367	Feb. 17, 2021	Feb. 16, 2022
RF signal cable HUBER+SUHNER&EMCI	SUCOFLEX 104 & EMC104-SM- SM8000	CABLE-CH9-02 (248780+171006)	Jan. 16, 2021	Jan. 15, 2022
RF signal cable HUBER+SUHNER	SUCOFLEX 104	CABLE-CH9- (250795/4)	Jan. 16, 2021	Jan. 15, 2022
RF signal cable Woken	8D-FB	Cable-CH9-01	Jun. 08, 2020	Jun. 07, 2021
Software BV ADT	ADT_Radiated_ V7.6.15.9.5	NA	NA	NA
Antenna Tower & Turn BV ADT	AT100	AT93021705	NA	NA
Turn Table BV ADT	TT100	TT93021705	NA	NA
Turn Table Controller BV ADT	SC100	SC93021705	NA	NA
Boresight Antenna Fixture	FBA-01	FBA-SIP01	NA	NA
DC Power Supply Topward	3303D	N/A	NA	NA
Digital Multimeter Fluke	87-III	70360742	Jun. 23, 2020	Jun. 22, 2021
Spectrum Analyzer ROHDE & SCHWARZ	FSV40	100980	Apr. 20, 2020	Apr. 19, 2021

Note: 1. The calibration interval of the above test instruments is 12 months and the calibrations are traceable to NML/ROC and NIST/USA.

2. The test was performed in HwaYa Chamber 9.

4.1.3 Test Procedures

For Radiated Emission below 30 MHz

- a. The EUT was placed on the top of a rotating table 0.8 meters above the ground at a 3 meter chamber room. The table was rotated 360 degrees to determine the position of the highest radiation.
- b. The EUT was set 3 meters away from the interference-receiving antenna, which was mounted on the top of a variable-height antenna tower.
- c. Parallel, perpendicular, and ground-parallel orientations of the antenna are set to make the measurement.
- d. For each suspected emission, the EUT was arranged to its worst case and the rotatable table was turned from 0 degrees to 360 degrees to find the maximum reading.
- e. The test-receiver system was set to Quasi-Peak Detect Function and Specified Bandwidth with Maximum Hold Mode.

Note:

1. The resolution bandwidth and video bandwidth of test receiver/spectrum analyzer is 9 kHz at frequency below 30 MHz.

For Radiated Emission above 30 MHz

- a. The EUT was placed on the top of a rotating table 0.8 meters (for 30 MHz ~ 1 GHz) / 1.5 meters (for above 1 GHz) above the ground at 3 meter chamber room for test. The table was rotated 360 degrees to determine the position of the highest radiation.
- b. The EUT was set 3 meters away from the interference-receiving antenna, which was mounted on the top of a variable-height antenna tower.
- c. The height of antenna is varied from one meter to four meters above the ground to determine the maximum value of the field strength. Both horizontal and vertical polarizations of the antenna are set to make the measurement.
- d. For each suspected emission, the EUT was arranged to its worst case and then the antenna was tuned to heights from 1 meter to 4 meters and the rotatable table was turned from 0 degrees to 360 degrees to find the maximum reading.
- e. The test-receiver system was set to quasi-peak detect function and specified bandwidth with maximum hold mode when the test frequency is below 1 GHz.
- f. The test-receiver system was set to peak and average detected function and specified bandwidth with maximum hold mode when the test frequency is above 1 GHz. If the peak reading value also meets average limit, measurement with the average detector is unnecessary.

Note:

1. The resolution bandwidth and video bandwidth of test receiver/spectrum analyzer is 120 kHz for Quasi-peak detection (QP) or Peak detection (PK) at frequency below 1 GHz.
2. The resolution bandwidth of test receiver/spectrum analyzer is 1 MHz and the video bandwidth is 3 MHz for Peak detection (PK) at frequency above 1 GHz.
3. The resolution bandwidth of test receiver/spectrum analyzer is 1 MHz and the video bandwidth is $\geq 1/T$ (Duty cycle < 98 %) or 10 Hz (Duty cycle ≥ 98 %) for Average detection (AV) at frequency above 1 GHz. (RBW = 1 MHz, VBW = 3 kHz)
4. All modes of operation were investigated and the worst-case emissions are reported.

4.1.4 Deviation from Test Standard

No deviation.

4.1.5 Test Set Up

<Radiated Emission below 30 MHz>

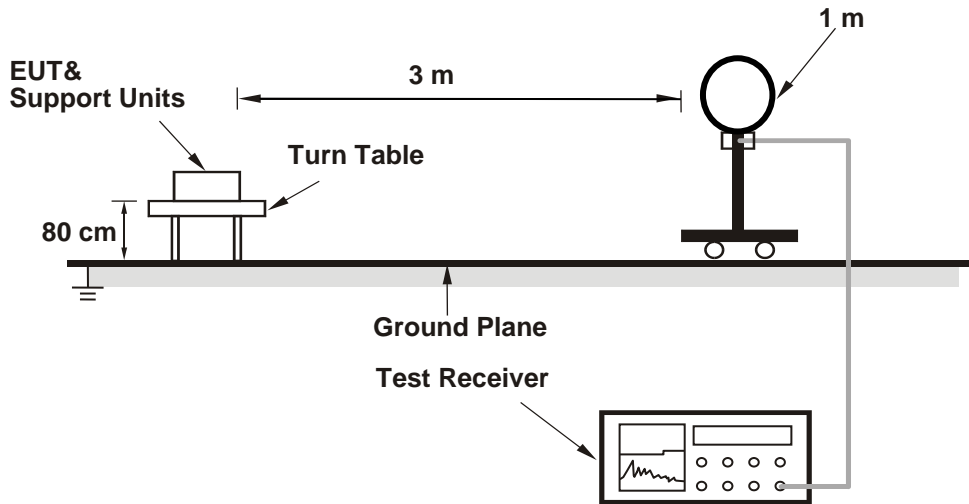

<Radiated Emission 30 MHz to 1 GHz>

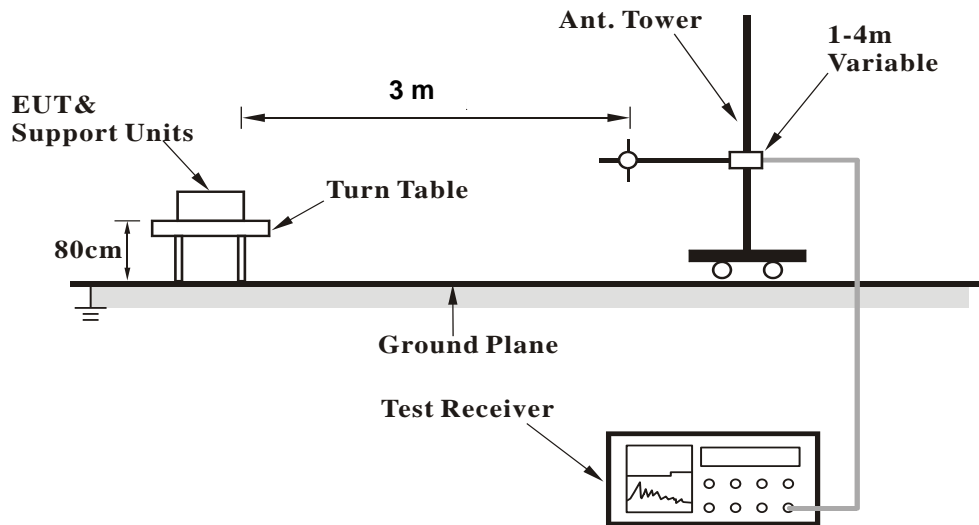

<Radiated Emission above 1 GHz>

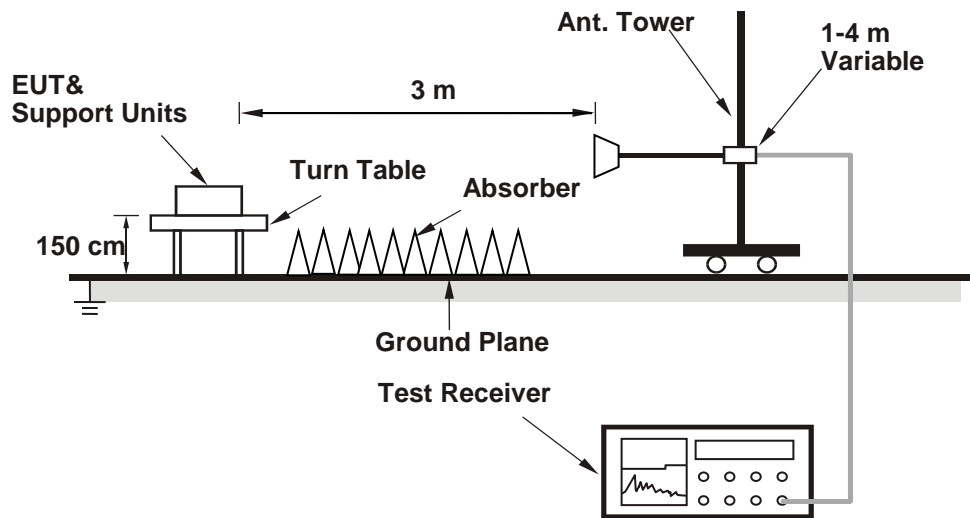

For the actual test configuration, please refer to the attached file (Test Setup Photo).

4.1.6 EUT Operating Conditions

- a. Placed the EUT on the testing table.
- b. Set the EUT under transmission condition continuously at specific channel frequency.

4.1.7 Test Results

Above 1 GHz Data:

RF Mode	TX BT_LE-1M	Channel	CH 0 : 2402 MHz
Frequency Range	1GHz ~ 25GHz	Detector Function	Peak (PK) Average (AV)

Antenna Polarity & Test Distance : Horizontal at 3 m								
No	Frequency (MHz)	Emission Level (dBuV/m)	Limit (dBuV/m)	Margin (dB)	Antenna Height (m)	Table Angle (Degree)	Raw Value (dBuV)	Correction Factor (dB/m)
1	2390.00	58.0 PK	74.0	-16.0	2.10 H	356	26.8	31.2
2	2390.00	43.9 AV	54.0	-10.1	2.10 H	356	12.7	31.2
3	*2402.00	102.4 PK			2.10 H	356	71.2	31.2
4	*2402.00	101.7 AV			2.10 H	356	70.5	31.2
5	4804.00	45.3 PK	74.0	-28.7	1.04 H	36	43.1	2.2
6	4804.00	34.5 AV	54.0	-19.5	1.04 H	36	32.3	2.2
Antenna Polarity & Test Distance : Vertical at 3 m								
No	Frequency (MHz)	Emission Level (dBuV/m)	Limit (dBuV/m)	Margin (dB)	Antenna Height (m)	Table Angle (Degree)	Raw Value (dBuV)	Correction Factor (dB/m)
1	2390.00	56.6 PK	74.0	-17.4	3.52 V	261	25.4	31.2
2	2390.00	43.4 AV	54.0	-10.6	3.52 V	261	12.2	31.2
3	*2402.00	99.4 PK			3.52 V	261	68.2	31.2
4	*2402.00	98.6 AV			3.52 V	261	67.4	31.2
5	4804.00	44.9 PK	74.0	-29.1	3.43 V	302	42.7	2.2
6	4804.00	34.0 AV	54.0	-20.0	3.43 V	302	31.8	2.2

Remarks:

1. Emission Level(dBuV/m) = Raw Value(dBuV) + Correction Factor(dB/m)
2. Correction Factor(dB/m) = Antenna Factor(dB/m) + Cable Factor(dB) – Pre-Amplifier Factor(dB)
3. Margin value = Emission Level – Limit value
4. The other emission levels were very low against the limit.
5. " * ": Fundamental frequency.

RF Mode	TX BT_LE-1M	Channel	CH 19 : 2440 MHz
Frequency Range	1GHz ~ 25GHz	Detector Function	Peak (PK) Average (AV)

Antenna Polarity & Test Distance : Horizontal at 3 m

No	Frequency (MHz)	Emission Level (dBuV/m)	Limit (dBuV/m)	Margin (dB)	Antenna Height (m)	Table Angle (Degree)	Raw Value (dBuV)	Correction Factor (dB/m)
1	*2440.00	103.4 PK			2.16 H	13	72.3	31.1
2	*2440.00	102.5 AV			2.16 H	13	71.4	31.1
3	4880.00	45.3 PK	74.0	-28.7	1.04 H	26	43.3	2.0
4	4880.00	34.2 AV	54.0	-19.8	1.04 H	26	32.2	2.0

Antenna Polarity & Test Distance : Vertical at 3 m

No	Frequency (MHz)	Emission Level (dBuV/m)	Limit (dBuV/m)	Margin (dB)	Antenna Height (m)	Table Angle (Degree)	Raw Value (dBuV)	Correction Factor (dB/m)
1	*2440.00	100.3 PK			3.52 V	254	69.2	31.1
2	*2440.00	99.4 AV			3.52 V	254	68.3	31.1
3	4880.00	44.9 PK	74.0	-29.1	3.36 V	302	42.9	2.0
4	4880.00	34.1 AV	54.0	-19.9	3.36 V	302	32.1	2.0

Remarks:

1. Emission Level(dBuV/m) = Raw Value(dBuV) + Correction Factor(dB/m)
2. Correction Factor(dB/m) = Antenna Factor(dB/m) + Cable Factor(dB) – Pre-Amplifier Factor(dB)
3. Margin value = Emission Level – Limit value
4. The other emission levels were very low against the limit.
5. " * ": Fundamental frequency.

RF Mode	TX BT_LE-1M	Channel	CH 39 : 2480 MHz
Frequency Range	1GHz ~ 25GHz	Detector Function	Peak (PK) Average (AV)

Antenna Polarity & Test Distance : Horizontal at 3 m

No	Frequency (MHz)	Emission Level (dBuV/m)	Limit (dBuV/m)	Margin (dB)	Antenna Height (m)	Table Angle (Degree)	Raw Value (dBuV)	Correction Factor (dB/m)
1	*2480.00	102.3 PK			2.04 H	19	71.2	31.1
2	*2480.00	101.4 AV			2.04 H	19	70.3	31.1
3	2483.50	58.0 PK	74.0	-16.0	2.04 H	19	26.9	31.1
4	2483.50	46.5 AV	54.0	-7.5	2.04 H	19	15.4	31.1
5	4960.00	45.2 PK	74.0	-28.8	1.06 H	28	42.9	2.3
6	4960.00	34.1 AV	54.0	-19.9	1.06 H	28	31.8	2.3

Antenna Polarity & Test Distance : Vertical at 3 m

No	Frequency (MHz)	Emission Level (dBuV/m)	Limit (dBuV/m)	Margin (dB)	Antenna Height (m)	Table Angle (Degree)	Raw Value (dBuV)	Correction Factor (dB/m)
1	*2480.00	99.3 PK			3.47 V	256	68.2	31.1
2	*2480.00	98.4 AV			3.47 V	256	67.3	31.1
3	2483.50	56.3 PK	74.0	-17.7	3.47 V	256	25.2	31.1
4	2483.50	45.4 AV	54.0	-8.6	3.47 V	256	14.3	31.1
5	4960.00	44.7 PK	74.0	-29.3	3.31 V	308	42.4	2.3
6	4960.00	34.1 AV	54.0	-19.9	3.31 V	308	31.8	2.3

Remarks:

1. Emission Level(dBuV/m) = Raw Value(dBuV) + Correction Factor(dB/m)
2. Correction Factor(dB/m) = Antenna Factor(dB/m) + Cable Factor(dB) – Pre-Amplifier Factor(dB)
3. Margin value = Emission Level – Limit value
4. The other emission levels were very low against the limit.
5. " * ": Fundamental frequency.

9 kHz ~ 30 MHz Data:

The amplitude of spurious emissions attenuated more than 20 dB below the permissible value is not required to be report.

30 MHz ~ 1 GHz Worst-Case Data:

RF Mode	TX BT_LE-1M	Channel	CH 39 : 2480 MHz
Frequency Range	30MHz ~ 1GHz	Detector Function	Quasi-Peak (QP)

Antenna Polarity & Test Distance : Horizontal at 3 m								
No	Frequency (MHz)	Emission Level (dBuV/m)	Limit (dBuV/m)	Margin (dB)	Antenna Height (m)	Table Angle (Degree)	Raw Value (dBuV)	Correction Factor (dB/m)
1	30.00	30.9 QP	40.0	-9.1	1.00 H	212	41.2	-10.3
2	99.84	38.0 QP	43.5	-5.5	1.25 H	247	51.1	-13.1
3	166.77	32.6 QP	43.5	-10.9	1.50 H	204	41.0	-8.4
4	232.73	30.3 QP	46.0	-15.7	1.00 H	68	40.3	-10.0
5	431.58	34.6 QP	46.0	-11.4	1.25 H	162	38.5	-3.9
6	800.18	35.0 QP	46.0	-11.0	1.00 H	254	31.6	3.4

Remarks:

1. Emission Level(dBuV/m) = Raw Value(dBuV) + Correction Factor(dB/m)
2. Correction Factor(dB/m) = Antenna Factor(dB/m) + Cable Factor(dB) – Pre-Amplifier Factor(dB)
3. Margin value = Emission Level – Limit value
4. The other emission levels were very low against the limit of frequency range 30MHz~1000MHz.
5. The emission levels were very low against the limit of frequency range 9kHz~30MHz: the amplitude of spurious emissions attenuated more than 20 dB below the permissible value to be report.

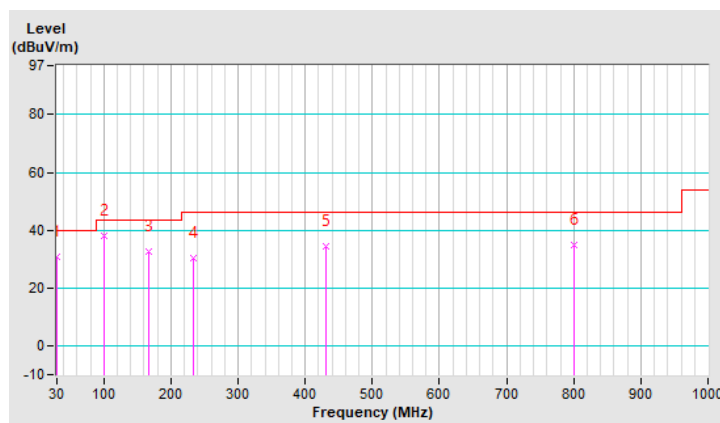

RF Mode	TX BT_LE-1M	Channel	CH 39 : 2480 MHz
Frequency Range	30MHz ~ 1GHz	Detector Function	Quasi-Peak (QP)

Antenna Polarity & Test Distance : Vertical at 3 m								
No	Frequency (MHz)	Emission Level (dBuV/m)	Limit (dBuV/m)	Margin (dB)	Antenna Height (m)	Table Angle (Degree)	Raw Value (dBuV)	Correction Factor (dB/m)
1	30.97	34.3 QP	40.0	-5.7	1.25 V	6	44.9	-10.6
2	82.38	34.9 QP	40.0	-5.1	1.50 V	6	48.7	-13.8
3	165.80	31.8 QP	43.5	-11.7	1.00 V	208	40.2	-8.4
4	232.73	30.8 QP	46.0	-15.2	1.50 V	85	40.8	-10.0
5	365.62	29.2 QP	46.0	-16.8	1.25 V	39	34.5	-5.3
6	909.79	36.7 QP	46.0	-9.3	1.00 V	126	31.3	5.4

Remarks:

1. Emission Level(dBuV/m) = Raw Value(dBuV) + Correction Factor(dB/m)
2. Correction Factor(dB/m) = Antenna Factor(dB/m) + Cable Factor(dB) – Pre-Amplifier Factor(dB)
3. Margin value = Emission Level – Limit value
4. The other emission levels were very low against the limit of frequency range 30MHz~1000MHz.
5. The emission levels were very low against the limit of frequency range 9kHz~30MHz: the amplitude of spurious emissions attenuated more than 20 dB below the permissible value to be report.

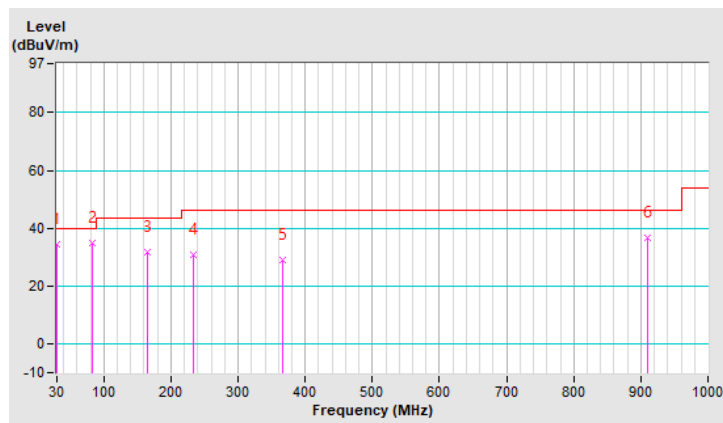

4.2 Conducted Emission Measurement

4.2.1 Limits of Conducted Emission Measurement

Frequency (MHz)	Conducted Limit (dBUV)	
	Quasi-Peak	Average
0.15 - 0.5	66 - 56	56 - 46
0.50 - 5.0	56	46
5.0 - 30.0	60	50

- Note: 1. The lower limit shall apply at the transition frequencies.
 2. The limit decreases in line with the logarithm of the frequency in the range of 0.15 to 0.50 MHz.

4.2.2 Test Instruments

Description & Manufacturer	Model No.	Serial No.	Date of Calibration	Due Date of Calibration
Test Receiver ROHDE & SCHWARZ	ESR3	102783	Dec. 21, 2020	Dec. 20, 2021
RF signal cable (with 10dB PAD) Woken	5D-FB	Cable-cond2-01	Sep. 04, 2020	Sep. 03, 2021
LISN/AMN ROHDE & SCHWARZ (EUT)	ESH2-Z5	100100	Jan. 28, 2021	Jan. 27, 2022
LISN/AMN ROHDE & SCHWARZ (Peripheral)	ESH3-Z5	100312	Aug. 18, 2020	Aug. 17, 2021
Software ADT	BV ADT_Cond_ V7.3.7.4	NA	NA	NA

- Note: 1. The calibration interval of the above test instruments is 12 months and the calibrations are traceable to NML/ROC and NIST/USA.
 2. The test was performed in HwaYa Shielded Room 2 (Conduction 2).
 3. The VCCI Site Registration No. is C-12047.

4.2.3 Test Procedures

- The EUT was placed 0.4 meters from the conducting wall of the shielded room with EUT being connected to the power mains through a line impedance stabilization network (LISN). Other support units were connected to the power mains through another LISN. The two LISNs provide 50 ohm/50 uH of coupling impedance for the measuring instrument.
- Both lines of the power mains connected to the EUT were checked for maximum conducted interference.
- The frequency range from 150 kHz to 30 MHz was searched. Emission levels under (Limit – 20 dB) was not recorded.

Note: The resolution bandwidth and video bandwidth of test receiver is 9 kHz for quasi-peak detection (QP) and average detection (AV) at frequency 0.15 MHz - 30 MHz.

4.2.4 Deviation from Test Standard

No deviation.

4.2.5 Test Setup

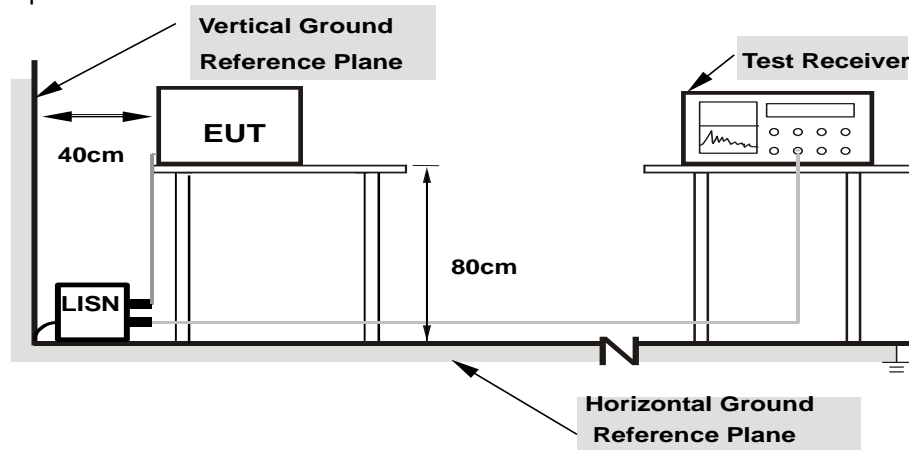

**Note: 1.Support units were connected to second LISN.
2.Both of LISNs (AMN) are 80 cm from EUT and at least 80 from other units and other metal planes**

4.2.6 EUT Operating Conditions

- a. Placed the EUT on the testing table.
- b. Set the EUT under transmission condition continuously at specific channel frequency.

4.2.7 Test Results

Frequency Range	150kHz ~ 30MHz	Detector Function & Resolution Bandwidth	Quasi-Peak (QP) / Average (AV), 9kHz
Input Power	120Vac, 60Hz	Environmental Conditions	25°C, 75%RH
Tested by	Greg Lin	Test Date	2021/3/31

Phase Of Power : Line (L)										
No	Frequency (MHz)	Correction Factor (dB)	Reading Value (dBuV)		Emission Level (dBuV)		Limit (dBuV)		Margin (dB)	
			Q.P.	AV.	Q.P.	AV.	Q.P.	AV.	Q.P.	AV.
1	0.17400	10.07	35.88	22.76	45.95	32.83	64.77	54.77	-18.82	-21.94
2	0.23000	10.08	28.48	13.08	38.56	23.16	62.45	52.45	-23.89	-29.29
3	0.48063	10.10	26.72	14.93	36.82	25.03	56.33	46.33	-19.51	-21.30
4	1.70600	10.15	22.84	12.17	32.99	22.32	56.00	46.00	-23.01	-23.68
5	3.51400	10.21	17.79	7.47	28.00	17.68	56.00	46.00	-28.00	-28.32
6	9.05000	10.30	22.89	15.73	33.19	26.03	60.00	50.00	-26.81	-23.97

Remarks:

1. Q.P. and AV. are abbreviations of quasi-peak and average individually.
2. The emission levels of other frequencies were very low against the limit.
3. Margin value = Emission level – Limit value
4. Correction factor = Insertion loss + Cable loss
5. Emission Level = Correction Factor + Reading Value

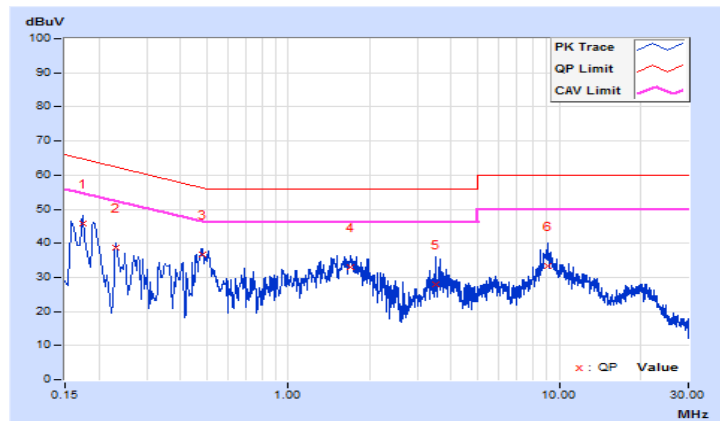

Frequency Range	150kHz ~ 30MHz	Detector Function & Resolution Bandwidth	Quasi-Peak (QP) / Average (AV), 9kHz
Input Power	120Vac, 60Hz	Environmental Conditions	25°C, 75%RH
Tested by	Greg Lin	Test Date	2021/3/31

Phase Of Power : Neutral (N)										
No	Frequency (MHz)	Correction Factor (dB)	Reading Value (dBuV)		Emission Level (dBuV)		Limit (dBuV)		Margin (dB)	
			Q.P.	AV.	Q.P.	AV.	Q.P.	AV.	Q.P.	AV.
1	0.15000	10.08	35.36	19.15	45.44	29.23	66.00	56.00	-20.56	-26.77
2	0.19800	10.08	34.76	18.51	44.84	28.59	63.69	53.69	-18.85	-25.10
3	0.47800	10.11	30.03	18.71	40.14	28.82	56.37	46.37	-16.23	-17.55
4	1.78200	10.17	23.49	12.89	33.66	23.06	56.00	46.00	-22.34	-22.94
5	3.75000	10.25	17.33	7.00	27.58	17.25	56.00	46.00	-28.42	-28.75
6	9.05400	10.39	17.30	9.26	27.69	19.65	60.00	50.00	-32.31	-30.35

Remarks:

1. Q.P. and AV. are abbreviations of quasi-peak and average individually.
2. The emission levels of other frequencies were very low against the limit.
3. Margin value = Emission level – Limit value
4. Correction factor = Insertion loss + Cable loss
5. Emission Level = Correction Factor + Reading Value

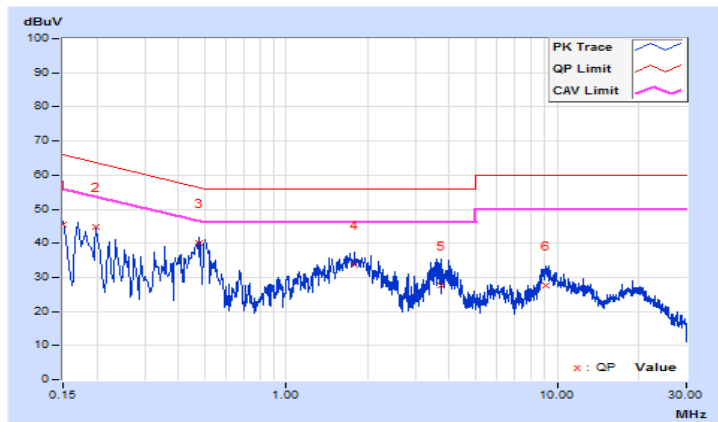

4.3 6 dB Bandwidth Measurement

4.3.1 Limits of 6 dB Bandwidth Measurement

The minimum of 6 dB Bandwidth Measurement is 0.5 MHz.

4.3.2 Test Setup



4.3.3 Test Instruments

Refer to section 4.1.2 to get information of above instrument.

4.3.4 Test Procedure

- a. Set resolution bandwidth (RBW) = 100 kHz
- b. Set the video bandwidth (VBW) $\geq 3 \times$ RBW, Detector = Peak.
- c. Trace mode = max hold.
- d. Sweep = auto couple.
- e. Measure the maximum width of the emission that is constrained by the frequencies associated with the two amplitude points (upper and lower) that are attenuated by 6 dB relative to the maximum level measured in the fundamental emission

4.3.5 Deviation from Test Standard

No deviation.

4.3.6 EUT Operating Conditions

The software provided by client to enable the EUT under transmission condition continuously at lowest, middle and highest channel frequencies individually.

4.3.7 Test Results

Channel	Frequency (MHz)	6 dB Bandwidth (MHz)	Minimum Limit (MHz)	Pass / Fail
0	2402	0.68	0.5	Pass
19	2440	0.67	0.5	Pass
39	2480	0.67	0.5	Pass

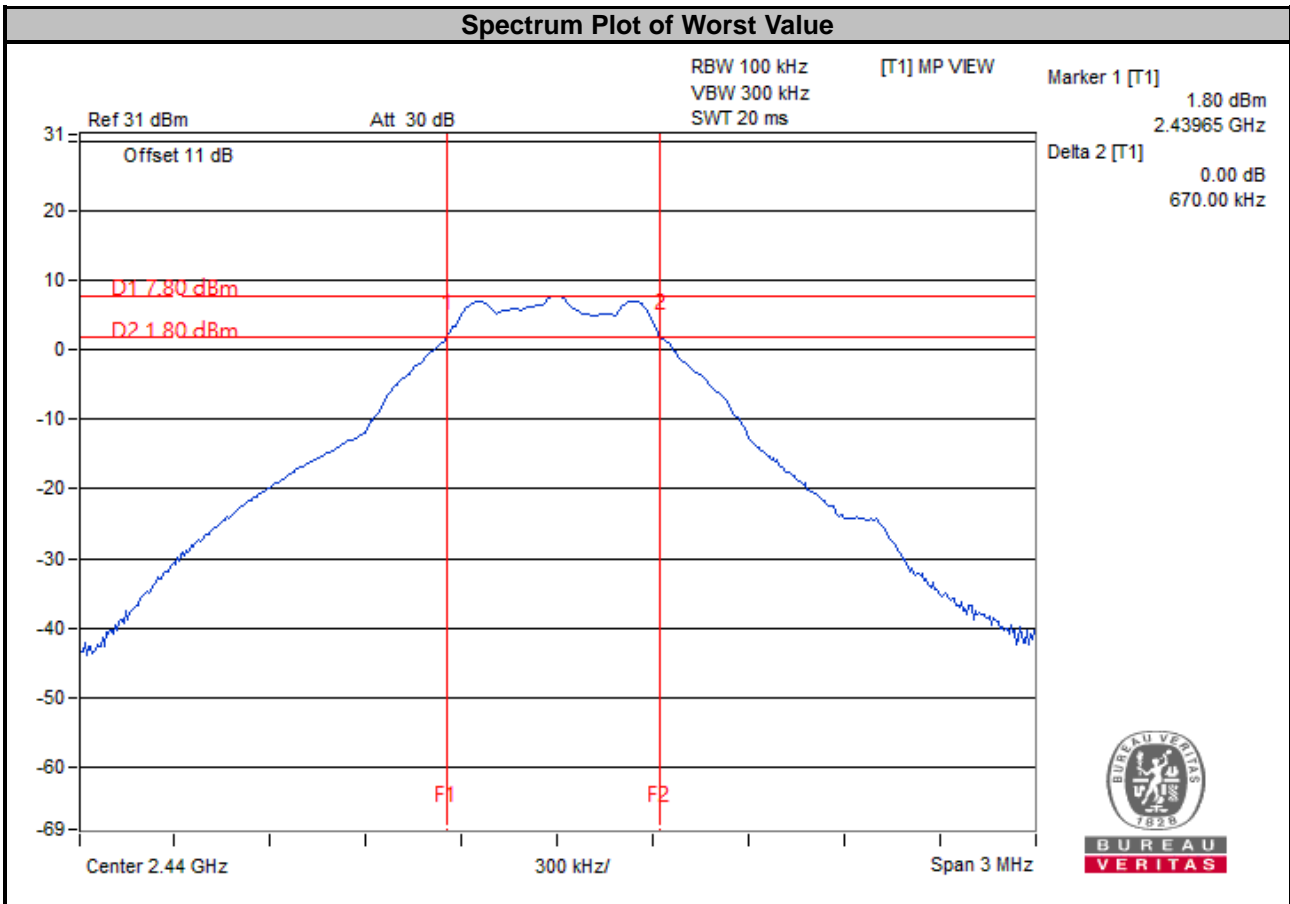

4.4 Occupied Bandwidth Measurement

4.4.1 Test Setup



4.4.2 Test Instruments

Refer to section 4.1.2 to get information of above instrument.

4.4.3 Test Procedure

The transmitter output was connected to the spectrum analyzer through an attenuator. The bandwidth of the fundamental frequency was measured by spectrum analyzer with resolution bandwidth in the range of 1 % to 5 % of the anticipated emission bandwidth, and a video bandwidth at least 3x the resolution bandwidth and set the detector to sampling. The width of a frequency band such that, below the lower and above the upper frequency limits, the mean powers emitted are each equal to a specified percentage 0.5 % of the total mean power of a given emission.

4.4.4 Deviation from Test Standard

No deviation.

4.4.5 EUT Operating Conditions

The software provided by client to enable the EUT under transmission condition continuously at lowest, middle and highest channel frequencies individually.

4.4.6 Test Results

Channel	Frequency (MHz)	Occupied Bandwidth (MHz)	Pass / Fail
0	2402	1.04	Pass
19	2440	1.01	Pass
39	2480	1.01	Pass

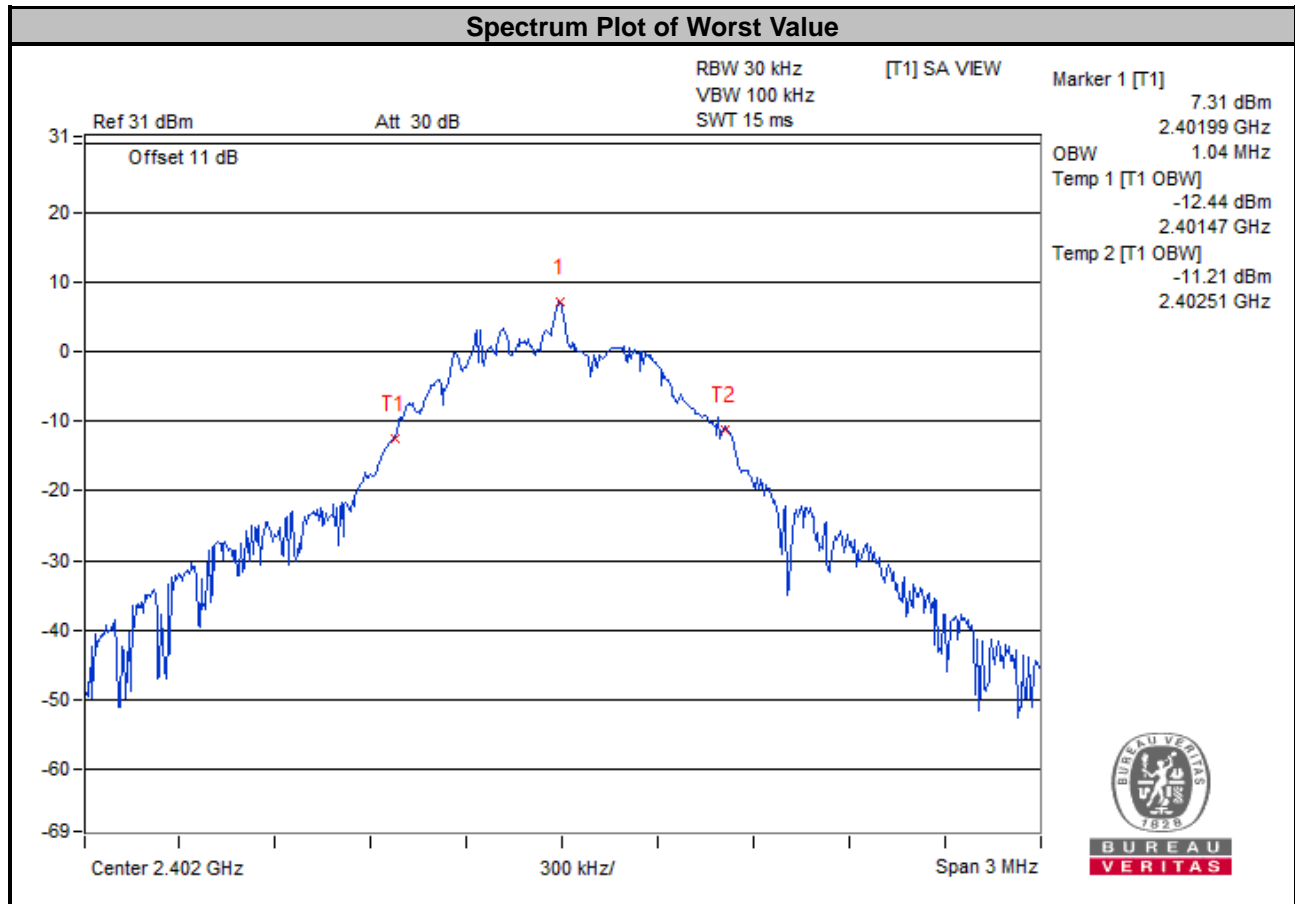

4.5 Conducted Output Power Measurement

4.5.1 Limits of Conducted Output Power Measurement

For systems using digital modulation in the 2400–2483.5 MHz bands: 1 Watt (30 dBm)

4.5.2 Test Setup

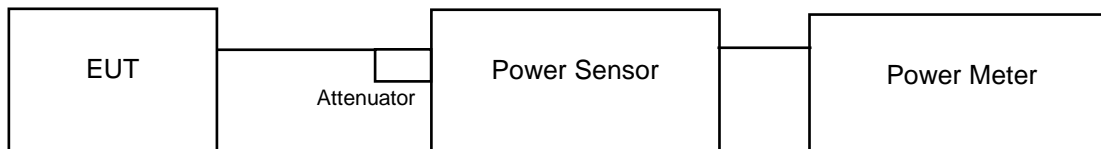

4.5.3 Test Instruments

Refer to section 4.1.2 to get information of above instrument.

4.5.4 Test Procedures

A peak power sensor was used on the output port of the EUT. A power meter was used to read the response of the peak power sensor. Record the power level.

Average power sensor was used to perform output power measurement, trigger and gating function of wide band power meter is enabled to measure max output power of TX on burst. Duty factor is not added to measured value.

4.5.5 Deviation from Test Standard

No deviation.

4.5.6 EUT Operating Conditions

The software provided by client to enable the EUT under transmission condition continuously at lowest, middle and highest channel frequencies individually.

4.5.7 Test Results

Channel	Freq. (MHz)	Peak Power		Average Power		Power Limit (mW)	Pass / Fail
		(mW)	(dBm)	(mW)	(dBm)		
0	2402	5.458	7.37	5.445	7.36	1000	Pass
19	2440	5.224	7.18	5.212	7.17	1000	Pass
39	2480	5.129	7.10	5.117	7.09	1000	Pass

4.6 Power Spectral Density Measurement

4.6.1 Limits of Power Spectral Density Measurement

The Maximum of Power Spectral Density Measurement is 8 dBm in any 3 kHz band during any time interval of continuous transmission.

4.6.2 Test Setup



4.6.3 Test Instruments

Refer to section 4.1.2 to get information of above instrument.

4.6.4 Test Procedure

- a. Set analyzer center frequency to DTS channel center frequency.
- b. Set the span to 1.5 times the DTS bandwidth.
- c. Set the RBW to: $3 \text{ kHz} \leq \text{RBW} \leq 100 \text{ kHz}$.
- d. Set the VBW $\geq 3 \times \text{RBW}$.
- e. Detector = peak.
- f. Sweep time = auto couple.
- g. Trace mode = max hold.
- h. Allow trace to fully stabilize.
- i. Use the peak marker function to determine the maximum amplitude level within the RBW.

4.6.5 Deviation from Test Standard

No deviation.

4.6.6 EUT Operating Condition

The software provided by client to enable the EUT under transmission condition continuously at lowest, middle and highest channel frequencies individually.

4.6.7 Test Results

Channel	Frequency (MHz)	PSD (dBm/3 kHz)	Limit (dBm/3 kHz)	Pass / Fail
0	2402	-6.86	8	Pass
19	2440	-7.19	8	Pass
39	2480	-6.90	8	Pass

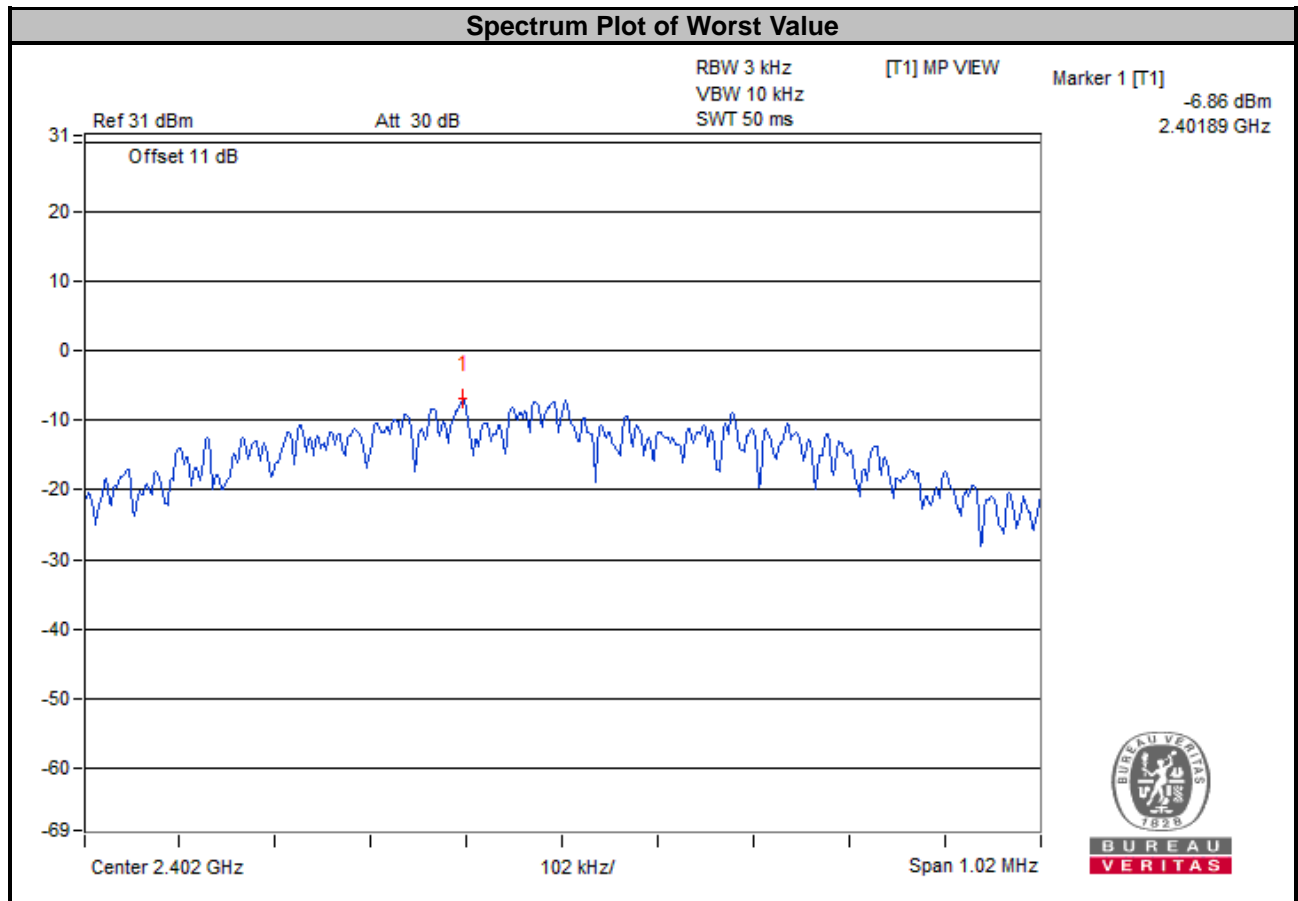

4.7 Conducted Out of Band Emission Measurement

4.7.1 Limits of Conducted Out of Band Emission Measurement

Below -20 dB of the highest emission level of operating band (in 100 kHz Resolution Bandwidth).

4.7.2 Test Setup



4.7.3 Test Instruments

Refer to section 4.1.2 to get information of above instrument.

4.7.4 Test Procedure

MEASUREMENT PROCEDURE REF

1. Set the RBW = 100 kHz.
2. Set the VBW \geq 300 kHz.
3. Detector = peak.
4. Sweep time = auto couple.
5. Trace mode = max hold.
6. Allow trace to fully stabilize.
7. Use the peak marker function to determine the maximum power level in any 100 kHz band segment within the fundamental EBW.

MEASUREMENT PROCEDURE OOBE

1. Set RBW = 100 kHz.
2. Set VBW \geq 300 kHz.
3. Detector = peak.
4. Sweep = auto couple.
5. Trace Mode = max hold.
6. Allow trace to fully stabilize.
7. Use the peak marker function to determine the maximum amplitude level.

4.7.5 Deviation from Test Standard

No deviation.

4.7.6 EUT Operating Condition

The software provided by client to enable the EUT under transmission condition continuously at lowest, middle and highest channel frequencies individually.

4.7.7 Test Results

The spectrum plots are attached on the following images. D1 line indicates the highest level, D2 line indicates the 20 dB offset below D1. It shows compliance with the requirement.

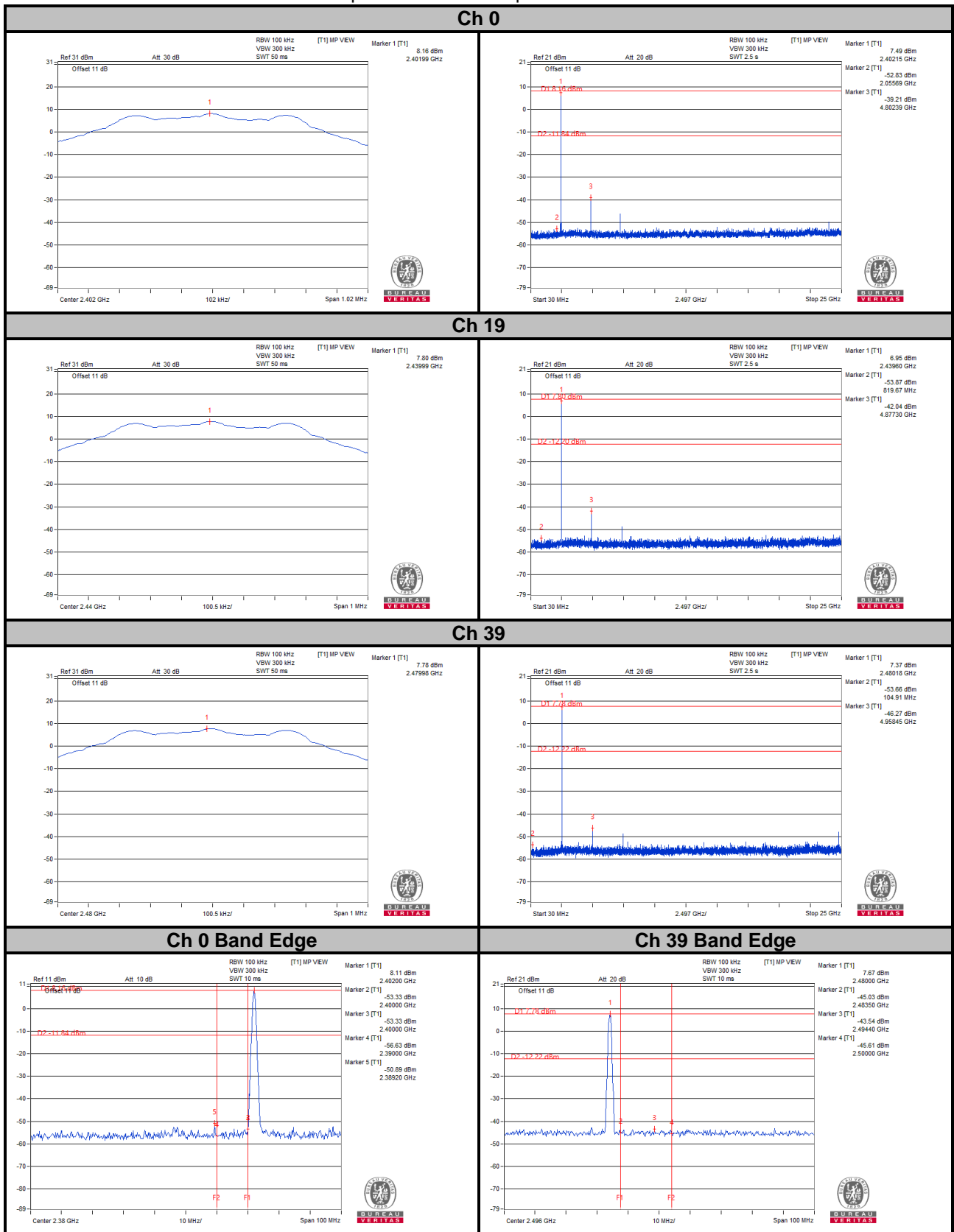

Annex A- Band Edge Measurement

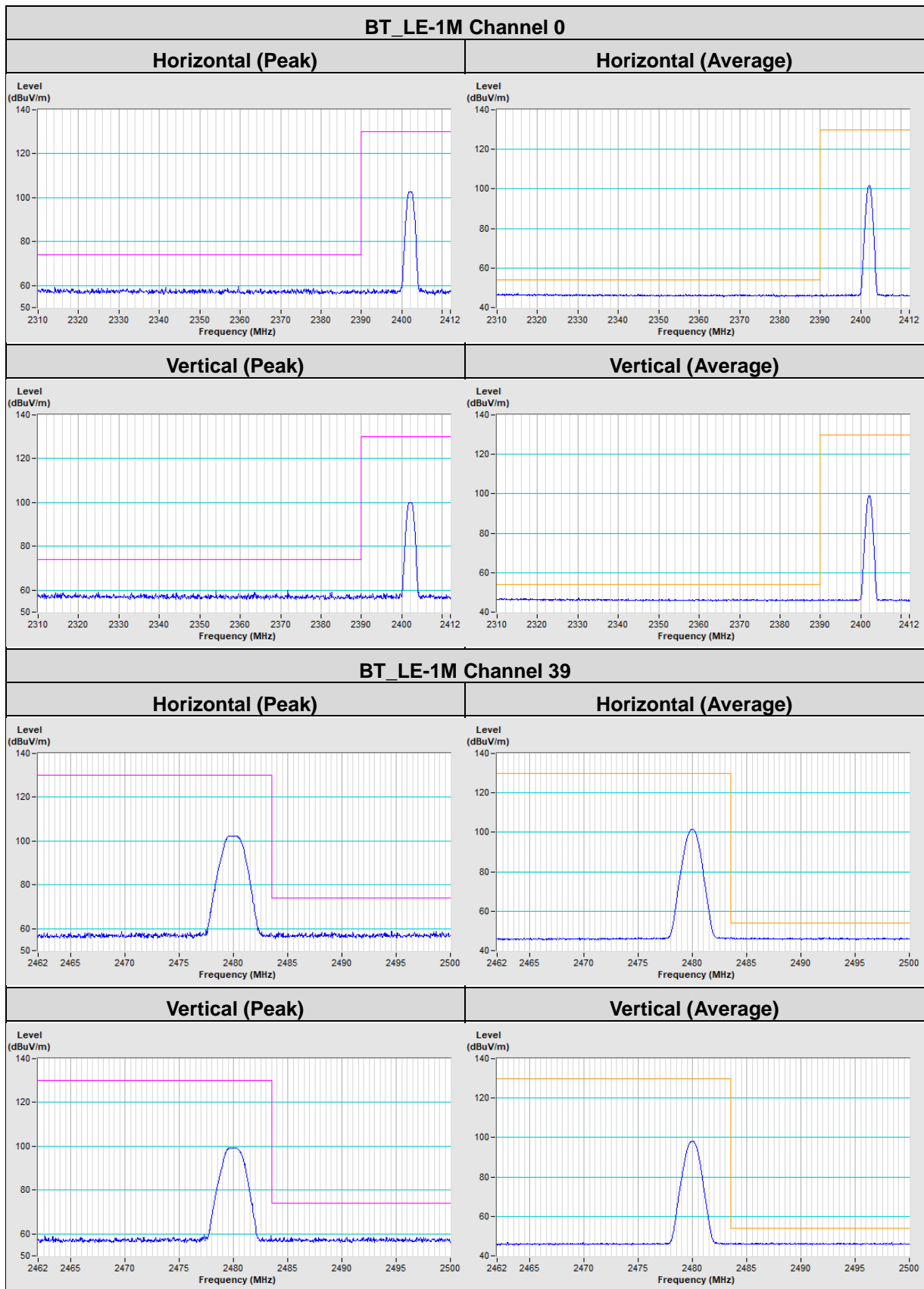

5 Pictures of Test Arrangements

Please refer to the attached file (Test Setup Photo).

Appendix – Information of the Testing Laboratories

We, Bureau Veritas Consumer Products Services (H.K.) Ltd., Taoyuan Branch, were founded in 1988 to provide our best service in EMC, Radio, Telecom and Safety consultation. Our laboratories are FCC recognized accredited test firms and accredited according to ISO/IEC 17025.

If you have any comments, please feel free to contact us at the following:

Lin Kou EMC/RF Lab

Tel: 886-2-26052180

Fax: 886-2-26051924

Hsin Chu EMC/RF/Telecom Lab

Tel: 886-3-6668565

Fax: 886-3-6668323

Hwa Ya EMC/RF/Safety Lab

Tel: 886-3-3183232

Fax: 886-3-3270892

Email: service.adt@tw.bureauveritas.com

Web Site: www.bureauveritas-adt.com

The address and road map of all our labs can be found in our web site also.

--- END ---