

FCC Part 15.249
RSS-GEN ISSUE 5 February 2021 AMENDMENT 2
RSS-210, ISSUE 10, April 2020 AMENDMENT
TEST REPORT

For

Jasco Products Company LLC

10 e memorial road Office Attn M Simpkins, oklahoma city, United States 73114

FCC ID: QOBZWA3017
IC: 6924A-ZWA3017

Report Type: Original Report	Product Type: In-Wall Smart Dimmer
Report Producer : <u>Coco Lin</u>	
Report Number : <u>RXZ220209005RF01</u>	
Report Date : <u>2022-06-07</u>	
Reviewed By: <u>Andy Shih</u> <i>Andy Shih</i>	
Prepared By: Bay Area Compliance Laboratories Corp. (New Taipei Laboratory) 70, Lane 169, Sec. 2, Datong Road, Xizhi Dist., New Taipei City 22183, Taiwan, R.O.C. Tel: +886 (2) 2647 6898 Fax: +886 (2) 2647 6895 www.bacl.com.tw	

Revision History

Revision	No.	Report Number	Issue Date	Description	Author/ Revised by
0.0	RXZ220209005	RXZ220209005RF01	2022-06-07	Original Report	Coco Lin

TABLE OF CONTENTS

1. General Information 5

 1.1 Product Description for Equipment under Test (EUT) 5

 1.2 Objective 6

 1.3 Related Submittal(s)/Grant(s)..... 6

 1.4 Test Methodology..... 6

 1.5 Statement of Compliance 6

 1.6 Measurement Uncertainty 7

 1.7 Environmental Conditions..... 7

 1.8 Test Facility..... 7

2. System Test Configuration 8

 2.1 Description of Test Configuration..... 8

 2.2 Equipment Modifications 8

 2.3 EUT Exercise Software 8

 2.4 Support Equipment List and Details..... 8

 2.5 External Cable List and Details..... 8

 2.6 Test Mode..... 8

 2.7 Block Diagram of Test Setup 9

3. Summary of Test Results 11

4. Test Equipment List and Details..... 12

5. RSS-102 § 2.5.2 – EXEMPTION LIMITS FROM ROUTINE EVALUATION - RF EXPOSURE EVALUATION 13

 5.1 Applicable Standard 13

 5.2 RF Exposure Evaluation Result 13

6. FCC §15.203 & RSS-GEN CLAUSE 6.8 – Antenna Requirements 14

 6.1 Applicable Standard 14

 6.2 Antenna Information 14

7. FCC §15.207(a) & RSS-GEN CLAUSE 8.8 – AC Line Conducted Emissions 15

 7.1 Applicable Standard..... 15

 7.2 EUT Setup 16

 7.3 EMI Test Receiver Setup 16

 7.4 Test Procedure..... 16

 7.5 Corrected Factor & Margin Calculation 17

 7.6 Test Results 18

8. FCC §15.209, §15.205 , §15.249 & RSS-210 ANNEX B.10, RSS-GEN CLAUSE 8.10 - Radiated Emissions 22

 8.1 Applicable Standard 22

 8.2 EUT Setup 23

 8.3 EMI Test Receiver & Spectrum Analyzer Setup..... 23

 8.4 Test Procedure..... 23

 8.5 Corrected Factor & Margin Calculation 24

 8.6 Test Results Summary..... 24

 8.7 Test Results 25

9 FCC §15.215(c) & RSS-GEN CLAUSE 6.7 – 20 dB Bandwidth Testing and 99% OCCUPIED BANDWIDTH 29

9.1	Applicable Standard	29
9.2	Test Procedure	30
9.3	Test Results	30

1. General Information

1.1 Product Description for Equipment under Test (EUT)

Applicant	Jasco Products Company LLC
	10 e memorial road Office Attn M Simpkins, oklahoma city, United States 73114
Manufacturer	Jasco Products Company LLC
	10 e memorial road Office Attn M Simpkins, oklahoma city, United States 73114
Brand(Trade) Name	Jasco/enbrighten/Ultrapro
Product (Equipment)	In-Wall Smart Dimmer
Main Model Name	ZWA3017ENB
Series Model Name	ZWA3017JAS
HVIN	ZWA3017ENB , ZWA3017JAS
Model Discrepancy	The major electrical and mechanical constructions of series models are identical to the basic model, except different Market segmentation. The model, ZWA3017ENB is the testing sample, and the final test data are shown on this test report.
Frequency Range	908.4 / 916 MHz
Antenna Specification	Metal antenna / -3.95 dBi
Power Operation (Voltage Range)	<input checked="" type="checkbox"/> AC 120V/60Hz <input type="checkbox"/> Adapter <input type="checkbox"/> By AC Power Cord <input type="checkbox"/> PoE
	<input type="checkbox"/> DC Type <input type="checkbox"/> from Battery <input type="checkbox"/> DC Power Supply <input type="checkbox"/> External from USB Cable <input type="checkbox"/> External DC Adapter
	<input type="checkbox"/> Host System
Received Date	Nov. 05, 2021
Date of Test	Feb. 10, 2022 ~ Feb. 14, 2022

*All measurement and test data in this report was gathered from production sample serial number: RXZ220209005-01 (Assigned by BAACL, New Taipei Laboratory).

1.2 Objective

This report is prepared on behalf of *Jasco Products Company LLC* in accordance with Part 2-Subpart J, and Part 15-Subparts A and C of the Federal Communication Commission's rules, and RSS-210, Issue 10, April 2020 Amendment of the Innovation, Science and Economic Development Canada, and RSS-Gen Issue 5, February 2021 Amendment 2, General Requirements for Compliance of Radio Apparatus.

1.3 Related Submittal(s)/Grant(s)

N/A.

1.4 Test Methodology

All measurements contained in this report were conducted with ANSI C63.10-2013, American National Standard of Procedures for Compliance Testing of Unlicensed Wireless Devices, and RSS-210, Issue 10, April 2020 Amendment of the Innovation, Science and Economic Development Canada, and RSS-Gen Issue 5, February 2021 Amendment 2, General Requirements for Compliance of Radio Apparatus.

1.5 Statement of Compliance

Decision Rule: No, (The test results do not include MU judgment)

It may not be duplicated or used in part without prior written consent from Bay Area Compliance Laboratories Corp. (New Taipei Laboratory).

Any unauthorized alteration, forgery or falsification of the content or appearance of this document is unlawful and offenders may be prosecuted to the fullest extent of the law.

Unless otherwise stated the results shown in this test report refer only to the sample(s) tested.

The determination of the test results does not require consideration of the uncertainty of the measurement, unless the assessment is required by customer agreement, regulation or standard document specification.

Bay Area Compliance Laboratories Corp. (New Taipei Laboratory) is not responsible for the authenticity of the information provided by the applicant that affects the test results.

1.6 Measurement Uncertainty

Parameter		Uncertainty
AC Mains		+/- 2.36 dB
Occupied Bandwidth		+/- 0.35 MHz
	30 MHz~1GHz	+/- 5.22 dB
	1 GHz~18 GHz	+/- 6.12 dB
	18 GHz~40 GHz	+/- 4.99 dB
Temperature		+/- 1.27 °C
Humidity		+/- 3 %

1.7 Environmental Conditions

Test Site	Test Data	Temperature (°C)	Relative Humidity (%)	ATM Pressure (hPa)	Test Engineer
AC Line Conducted Emissions	2022/02/14	21.9	59	1010	Boris Kao
Radiation Spurious Emissions	2022/02/10	19.8	69	1010	Howard Chen
Emission Bandwidth	2022/02/14	21.9	59	1010	Howard Chen

1.8 Test Facility

The Test site used by Bay Area Compliance Laboratories Corp. (New Taipei Laboratory) to collect test data is located on

☒70, Lane 169, Sec. 2, Datong Road, Xizhi Dist., New Taipei City 22183, Taiwan, R.O.C.

Bay Area Compliance Laboratories Corp. (New Taipei Laboratory) is accredited to ISO 17025 by Taiwan Accreditation Foundation (TAF code: 3732) and the FCC designation No.TW3732 under the Mutual Recognition Agreement (MRA) in FCC Test.

The lab has been recognized by Innovation, Science and Economic Development Canada to test to Canadian radio equipment requirements, the CAB identifier: TW3732.

2. System Test Configuration

2.1 Description of Test Configuration

The system was configured for testing in an engineering mode, which was provided by manufacturer. The engineering mode was configured the system transmitting with maximum power.

Channel List

Channel	Frequency (MHz)
1	908.4
2	916.0

Tested with channel 1 and 2.

2.2 Equipment Modifications

No modification was made to the EUT.

2.3 EUT Exercise Software

Use the button to switch the test channel.

Test Frequency	Low	High
Power Level Setting	Default	Default

2.4 Support Equipment List and Details

Description	Manufacturer	Model Number
LED Bulbs	NEWWIN	JTS-LED60WL, 112W
LED Tube	JAA	L281016H, 240W

2.5 External Cable List and Details

Cable Description	Length (m)	From	To
Power Cable	0.8	EUT	LED Bulbs / LED Tube

2.6 Test Mode

Pre-scan

AC Line Conducted Emissions and Radiated Spurious Emissions

Mode 1: maximum output voltage with minimum operating output current + Transmitting.

Mode 2: maximum output current with minimum operating voltage + Transmitting.

Mode 3: maximum operating output power (maximum voltage and current) + Transmitting.

Mode 4: minimum operating output power (minimum voltage and current) + Transmitting.

Worst case is Mode 3: maximum operating output power (maximum voltage and current) + Transmitting.

Mode 3: maximum operating output power (maximum voltage and current) + Transmitting Test all items.

2.7 Block Diagram of Test Setup

See test photographs attached in setup photos for the actual connections between EUT and support equipment.

Radiation:

Below 1GHz:

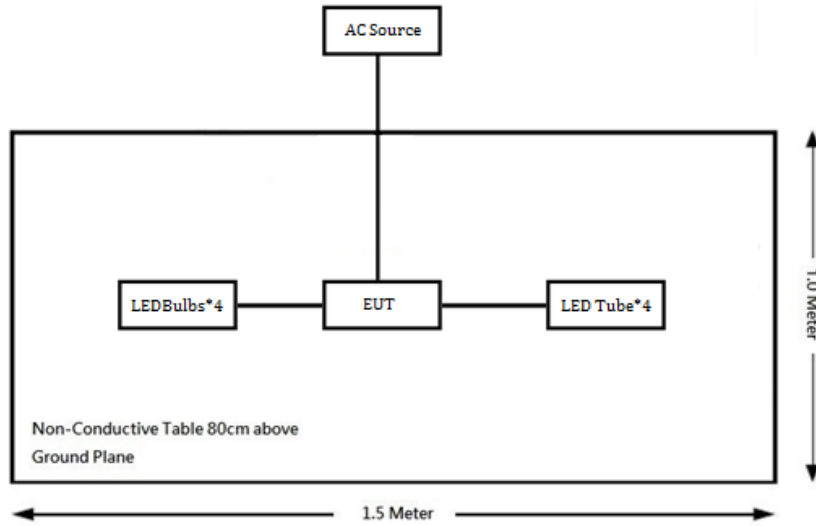

Above 1GHz:

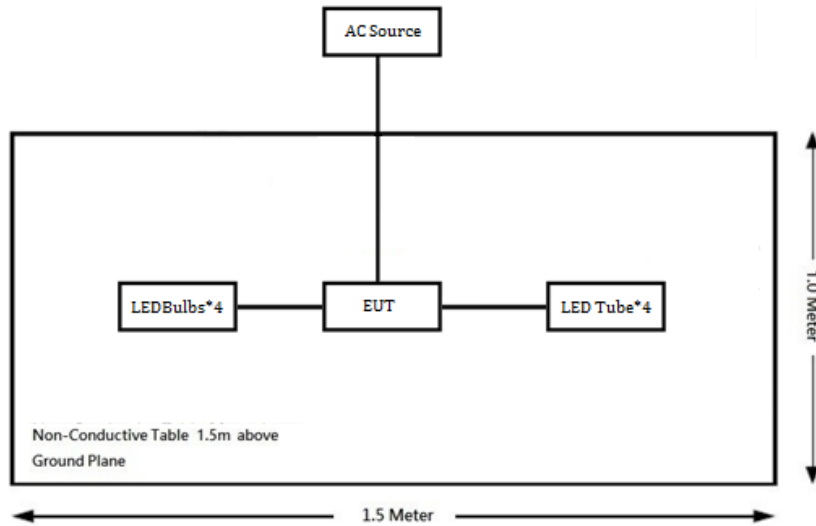

Conduction:

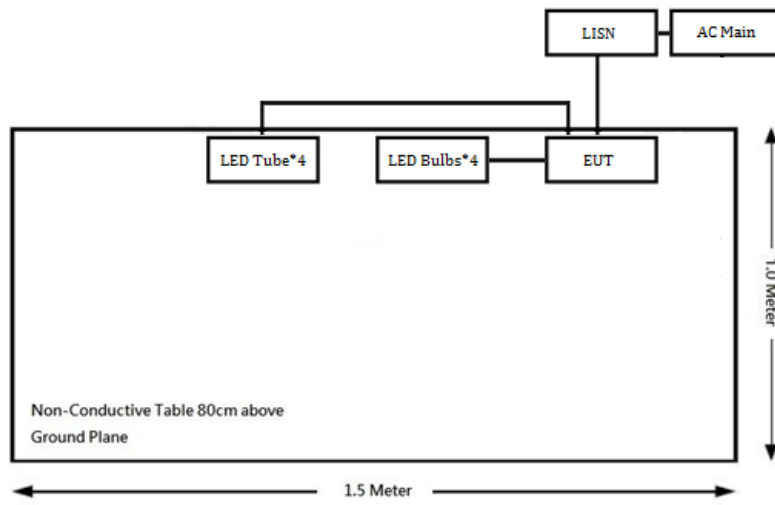

3. Summary of Test Results

FCC Rules	Description of Test	Results
§RSS-102 Clause 2.5.2	Exemption Limits From Routine Evaluation- RF Exposure Evaluation	Compliance
§15.203 RSS-GEN Clause 6.8	Antenna Requirement	Compliance
§15.207 (a) RSS-Gen Clause 8.8	AC Line Conducted Emissions	Compliance
§15.205, §15.209, §15.249 RSS-210 Annex B.10 RSS-Gen Clause 8.10	Radiated Emissions	Compliance
§15.215 (c) RSS-Gen Clause 6.7	20 dB Emission Bandwidth 99% Occupied Bandwidth	Compliance

4. Test Equipment List and Details

AC Line Conduction Room (CON-A)					
LISN	Rohde & Schwarz	ENV216	101612	2022/1/14	2023/1/13
EMI Test Receiver	Rohde & Schwarz	ESW8	100947	2021/7/23	2022/7/22
Pulse Limiter	Rohde & Schwarz	ESH3Z2	TXZEM104	2021/7/29	2022/7/28
RF Cable	EMEC	EM-CB5D	1	2021/6/11	2022/6/10
Software	AUDIX	E3	V9.150826k	N.C.R	N.C.R
Radiation 3M Room (966-A)					
Active Loop Antenna	ETS-Lindgren	6502	35796	2021/3/16	2022/3/15
Bilog Antenna with 6 dB Attenuator	SUNOL SCIENCES & MINI-CIRCUITS	JB3 &EM-ATT6000-6-NN	A090816-2&ATT-09-003	2022/1/26	2023/1/25
Horn Antenna	EMCO	SAS-571	1020	2021/4/23	2022/4/22
Preamplifier	Sonoma	310N	130602	2021/6/8	2022/6/7
Preamplifier	A.H. system Inc.	PAM-0118P	470	2021/3/15	2022/3/14
Spectrum Analyzer	Rohde & Schwarz	FSV40	101435	2022/1/13	2023/1/12
EMI Test Receiver	Rohde & Schwarz	ESR7	101419	2021/11/9	2022/11/8
Micro flex Cable	UTIFLEX	UFB197C-1-2362-70U-70U	225757-001	2022/1/24	2023/1/23
Coaxial Cable	COMMATE	PEWC	8Dr	2021/12/24	2022/12/23
Coaxial Cable	UTIFLEX	UFB311A-Q-1440-300300	220490-006	2022/1/24	2023/1/23
Coaxial Cable	JUNFLON	J12J102248-00-B-5	AUG-07-15-044	2021/12/24	2022/12/23
Cable	EMC	EMC105-SM-SM-10000	201003	2022/1/24	2023/1/23
Software	Farad	EZ_EM	BACL-03A1	N.C.R	N.C.R
Conducted Room					
Spectrum Analyzer	Rohde & Schwarz	FSV40	101140	2021/12/21	2022/12/20
Cable	UTIFLEX	UFA210A	9435	2021/10/5	2022/10/4

***Statement of Traceability:** BACL Corp. attests that all of the calibrations on the equipment items listed above were traceable to the SI System of Units via the R.O.C. Center for Measurement Standards of the Electronics Testing Center, Taiwan (ETC) or to another internationally recognized National Metrology Institute (NMI), and were compliant with the current Taiwan Accreditation Foundation (TAF) requirements.

5. RSS-102 § 2.5.2 – EXEMPTION LIMITS FROM ROUTINE EVALUATION - RF EXPOSURE EVALUATION

5.1 Applicable Standard

RF exposure evaluation is required if the separation distance between the user and/or bystander and the device's radiating element is greater than 20 cm, except when the device operates as follows:

- below 20 MHz and the source-based, time-averaged maximum e.i.r.p. of the device is equal to or less than 1 W (adjusted for tune-up tolerance);
- at or above 20 MHz and below 48 MHz and the source-based, time-averaged maximum e.i.r.p. of the device is equal to or less than $4.49/f^{0.5}$ W (adjusted for tune-up tolerance), where f is in MHz;
- at or above 48 MHz and below 300 MHz and the source-based, time-averaged maximum e.i.r.p. of the device is equal to or less than 0.6 W (adjusted for tune-up tolerance);
- at or above 300 MHz and below 6 GHz and the source-based, time-averaged maximum e.i.r.p. of the device is equal to or less than $1.31 \times 10^{-2} f^{0.6834}$ W (adjusted for tune-up tolerance), where f is in MHz;
- at or above 6 GHz and the source-based, time-averaged maximum e.i.r.p. of the device is equal to or less than 5 W (adjusted for tune-up tolerance).

In these cases, the information contained in the RF exposure technical brief may be limited to information that demonstrates how the e.i.r.p. was derived.

5.2 RF Exposure Evaluation Result

$$\text{EIRP} = 83.42 \text{ dB}\mu\text{V/m} - 95.2 = -11.78 \text{ dBm}$$

$$\text{Tune-up power} = -11.5 \text{ dBm} = 0.07 \text{ mW}$$

Exemption from Routine Evaluation Limit is:

$$1.31 \times 10^{-2} f^{0.6834} = 1.31 \times 10^{-2} \times 908.4^{0.6834} = 1.38 \text{ W} > 0.07 \text{ mW}$$

Result: The device meets the exemption requirement.

6. FCC §15.203 & RSS-GEN CLAUSE 6.8 – Antenna Requirements

6.1 Applicable Standard

For intentional device, according to §15.203, an intentional radiator shall be designed to ensure that no antenna other than that furnished by the responsible party shall be used.

According to RSS-Gen §6.8, The applicant for equipment certification shall provide a list of all antenna types that may be used with the transmitter, where applicable (i.e. for transmitters with detachable antenna), indicating the maximum permissible antenna gain (in dBi) and the required impedance for each antenna. The test report shall demonstrate the compliance of the transmitter with the limit for maximum equivalent isotropically radiated power (e.i.r.p.) specified in the applicable RSS, when the transmitter is equipped with any antenna type, selected from this list.

For expediting the testing, measurements may be performed using only the antenna with highest gain of each combination of transmitter and antenna type, with the transmitter output power set at the maximum level. However, the transmitter shall comply with the applicable requirements under all operational conditions and when in combination with any type of antenna from the list provided in the test report (and in the notice to be included in the user manual, provided below).

When measurements at the antenna port are used to determine the RF output power, the effective gain of the device's antenna shall be stated, based on a measurement or on data from the antenna's manufacturer. The test report shall state the RF power, output power setting and spurious emission measurements with each antenna type that is used with the transmitter being tested.

For licence-exempt equipment with detachable antennas, the user manual shall also contain the following notice in a conspicuous location:

This radio transmitter [enter the device's ISED certification number] has been approved by Innovation, Science and Economic Development Canada to operate with the antenna types listed below, with the maximum permissible gain indicated. Antenna types not included in this list that have a gain greater than the maximum gain indicated for any type listed are strictly prohibited for use with this device.

Immediately following the above notice, the manufacturer shall provide a list of all antenna types which can be used with the transmitter, indicating the maximum permissible antenna gain (in dBi) and the required impedance for each antenna type.

6.2 Antenna Information

Type	Antenna Gain	Impedance
Metal antenna	-3.95 dBi	50Ω

Result: Compliance.

7. FCC §15.207(a) & RSS-GEN CLAUSE 8.8 – AC Line Conducted Emissions

7.1 Applicable Standard

According to §15.207

For an intentional radiator that is designed to be connected to the public utility (AC) power line, the radio frequency voltage that is conducted back onto the AC power line on any frequency or frequencies within the band 150 kHz to 30 MHz shall not exceed the limits in the following table, as measured using a 50 μ H/50 ohms line impedance stabilization network (LISN). Compliance with the provisions of this paragraph shall be based on the measurement of the radio frequency voltage between each power line and ground at the power terminal. The lower limit applies at the boundary between the frequencies ranges.

According to RSS-GEN CLAUSE 8.8

Unless stated otherwise in the applicable RSS, for radio apparatus that are designed to be connected to the public utility AC power network, the radio frequency voltage that is conducted back onto the AC power line on any frequency or frequencies within the range 150 kHz to 30 MHz shall not exceed the limits in table 4, as measured using a 50 μ H / 50 Ω line impedance stabilization network. This requirement applies for the radio frequency voltage measured between each power line and the ground terminal of each AC power-line mains cable of the EUT.

For an EUT that connects to the AC power lines indirectly, through another device, the requirement for compliance with the limits in table 4 shall apply at the terminals of the AC power-line mains cable of a representative support device, while it provides power to the EUT. The lower limit applies at the boundary between the frequency ranges. The device used to power the EUT shall be representative of typical applications.

Frequency of Emission (MHz)	Conducted Limit (dBuV)	
	Quasi-Peak	Average
0.15-0.5	66 to 56 ^{Note 1}	56 to 46 ^{Note 1}
0.5-5	56	46
5-30	60	50

Note 1: Decreases with the logarithm of the frequency.

7.2 EUT Setup

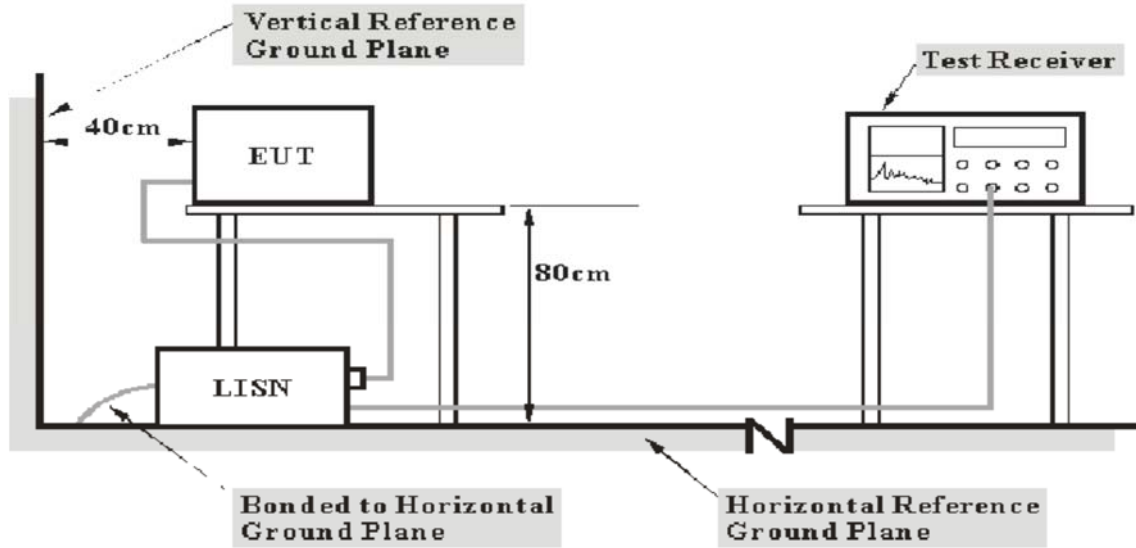

- Note:**
1. Support units were connected to second LISN.
 2. Both of LISNs (AMN) 80 cm from EUT and at the least 80 cm from other units and other metal planes support units.

The setup of EUT is according with per ANSI C63.10-2013 measurement procedure. The specification used was with the FCC Part 15.207 and RSS-GEN limits.

7.3 EMI Test Receiver Setup

The EMI test receiver was set to investigate the spectrum from 150kHz to 30MHz.

During the conducted emission test, the EMI test receiver was set with the following configurations

Frequency Range	IF B/W
150kHz – 30MHz	9kHz

7.4 Test Procedure

During the conducted emission test, the adapter was connected to the outlet of the LISN.

Maximizing procedure was performed on the six (6) highest emissions of the EUT.

All data was recorded in the Quasi-peak and average detection mode.

7.5 Corrected Factor & Margin Calculation

The factor is calculated by adding LISN/ISN VDF (Voltage Division Factor), Cable Loss and Transient Limiter Attenuation. The basic equation is as follows:

$$\text{Factor} = \text{LISN VDF} + \text{Cable Loss} + \text{Transient Limiter Attenuation}$$

The “Over Limit” column of the following data tables indicates the degree of compliance with the applicable limit. For example, an over limit of -7 dB means the emission is 7 dB below the limit. The equation for Over Limit calculation is as follows:

$$\text{Over Limit} = \text{Level} - \text{Limit Line}$$

7.6 Test Results

Test Mode: Transmitting

(worst case is High channel)

Main: AC120 V, 60 Hz, Line

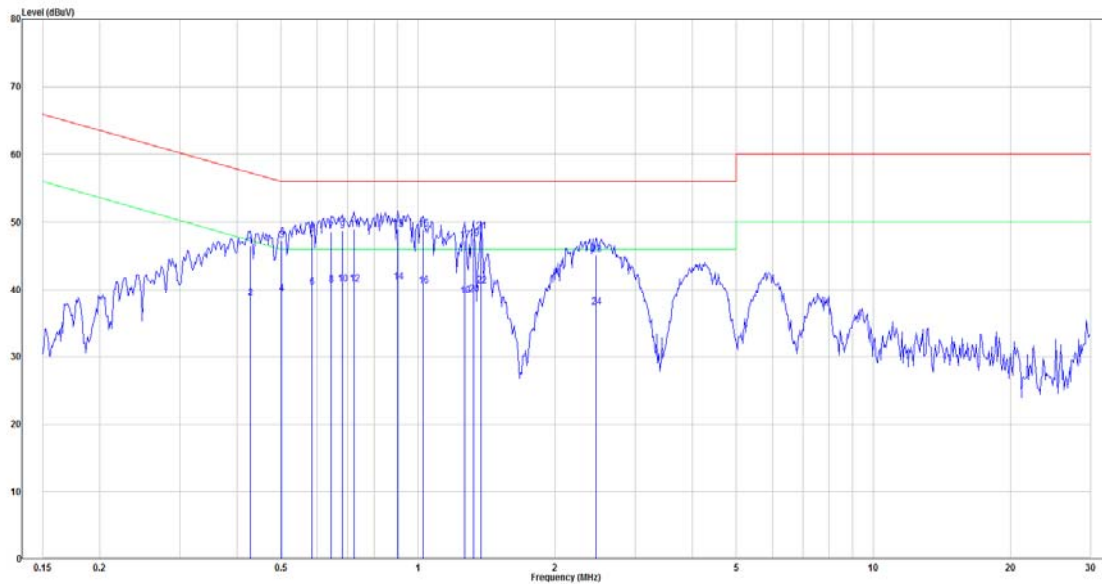

No.	Frequency (MHz)	Reading (dBμV)	Correct Factor(dB)	Result (dBμV)	Limit (dBμV)	Over limit (dB)	Remark
1	0.428	26.96	19.52	46.48	57.29	-10.81	QP
2	0.428	19.20	19.52	38.72	47.29	-8.57	Average
3	0.502	27.83	19.52	47.35	56.00	-8.65	QP
4	0.502	19.83	19.52	39.35	46.00	-6.65	Average
5	0.585	28.73	19.52	48.25	56.00	-7.75	QP
6	0.585	20.82	19.52	40.34	46.00	-5.66	Average
7	0.644	29.06	19.53	48.59	56.00	-7.41	QP
8	0.644	21.19	19.53	40.72	46.00	-5.28	Average
9	0.683	29.21	19.53	48.74	56.00	-7.26	QP
10	0.683	21.32	19.53	40.85	46.00	-5.15	Average
11	0.724	29.39	19.53	48.92	56.00	-7.08	QP
12	0.724	21.25	19.53	40.78	46.00	-5.22	Average
13	0.904	29.41	19.54	48.95	56.00	-7.05	QP
14	0.904	21.69	19.54	41.23	46.00	-4.77	Average
15	1.027	29.40	19.54	48.94	56.00	-7.06	QP
16	1.027	21.07	19.54	40.61	46.00	-5.39	Average
17	1.269	27.78	19.55	47.33	56.00	-8.67	QP
18	1.269	19.52	19.55	39.07	46.00	-6.93	Average
19	1.324	28.04	19.55	47.59	56.00	-8.41	QP

20	1.324	19.73	19.55	39.28	46.00	-6.72	Average
21	1.374	29.11	19.55	48.66	56.00	-7.34	QP
22	1.374	21.07	19.55	40.62	46.00	-5.38	Average
23	2.461	25.64	19.59	45.23	56.00	-10.77	QP
24	2.461	17.71	19.59	37.30	46.00	-8.70	Average

Note:

Level = Read Level + Factor

Over Limit = Level – Limit Line

Factor = (LISN, ISN, PLC or current probe) Factor + Cable Loss + Attenuator

Main: AC120 V, 60 Hz, Neutral

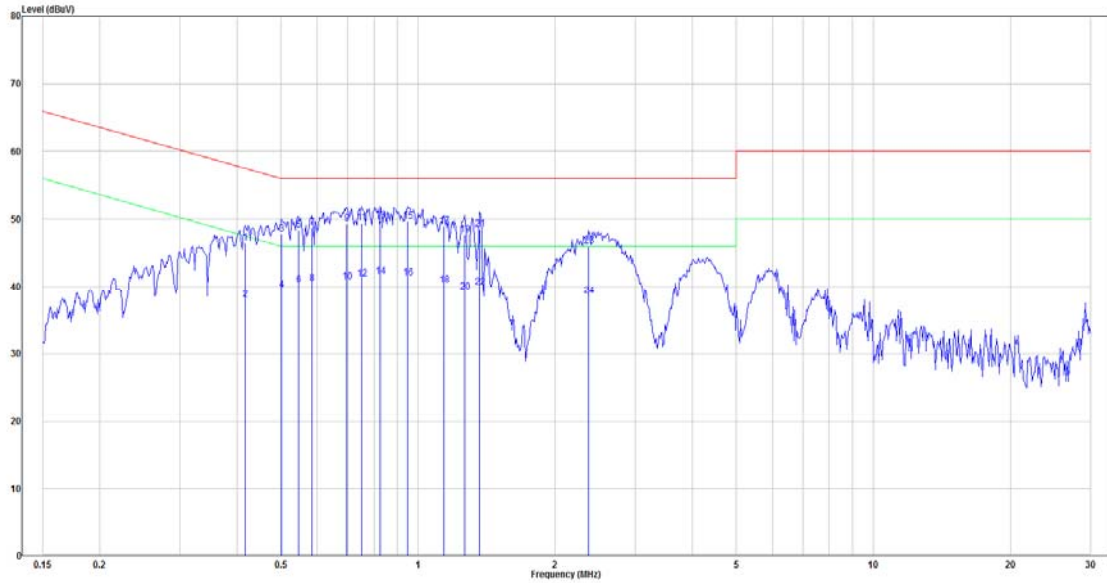

No.	Frequency (MHz)	Reading (dBµV)	Correct Factor(dB)	Result (dBµV)	Limit (dBµV)	Over limit (dB)	Remark
1	0.417	26.98	19.51	46.49	57.51	-11.02	QP
2	0.417	18.45	19.51	37.96	47.51	-9.55	Average
3	0.502	28.30	19.52	47.82	56.00	-8.18	QP
4	0.502	19.97	19.52	39.49	46.00	-6.51	Average
5	0.546	28.91	19.52	48.43	56.00	-7.57	QP
6	0.546	20.71	19.52	40.23	46.00	-5.77	Average
7	0.585	29.17	19.52	48.69	56.00	-7.31	QP
8	0.585	20.95	19.52	40.47	46.00	-5.53	Average
9	0.697	29.75	19.52	49.27	56.00	-6.73	QP
10	0.697	21.22	19.52	40.74	46.00	-5.26	Average
11	0.751	29.90	19.53	49.43	56.00	-6.57	QP
12	0.751	21.66	19.53	41.19	46.00	-4.81	Average
13	0.826	30.27	19.53	49.80	56.00	-6.20	QP
14	0.826	22.07	19.53	41.60	46.00	-4.40	Average
15	0.948	30.17	19.53	49.70	56.00	-6.30	QP
16	0.948	21.82	19.53	41.35	46.00	-4.65	Average
17	1.141	29.38	19.54	48.92	56.00	-7.08	QP
18	1.141	20.69	19.54	40.23	46.00	-5.77	Average
19	1.269	28.16	19.54	47.70	56.00	-8.30	QP
20	1.269	19.68	19.54	39.22	46.00	-6.78	Average
21	1.367	28.99	19.54	48.53	56.00	-7.47	QP
22	1.367	20.35	19.54	39.89	46.00	-6.11	Average

23	2.371	26.46	19.58	46.04	56.00	-9.96	QP
24	2.371	18.98	19.58	38.56	46.00	-7.44	Average

Note:

Level = Read Level + Factor

Over Limit = Level – Limit Line

Factor = (LISN, ISN, PLC or current probe) Factor + Cable Loss + Attenuator

8. FCC §15.209, §15.205 , §15.249 & RSS-210 ANNEX B.10, RSS-GEN CLAUSE 8.10 - Radiated Emissions

8.1 Applicable Standard

As per FCC§15.249 (a), except as provided in paragraph (b) of this section, the field strength of emissions from intentional radiators operated within these frequency bands shall comply with the following:

Fundamental frequency	Field strength of fundamental (millivolts/meter)	Field strength of harmonics (microvolts/meter)
920-928 MHz	50	500
2400-2483.5 MHz	50	500
5725-5875 MHz	50	500
24.0-24.25 GHz	250	2500

As per FCC§15.249 (c), Field strength limits are specified at a distance of 3 meters.

(d) Emissions radiated outside of the specified frequency bands, except for harmonics, shall be attenuated by at least 50 dB below the level of the fundamental or to the general radiated emission limits in §15.209, whichever is the lesser attenuation.

According to RSS-210 Issue 10 Clause Annex B B.10 (a): The field strength of fundamental and harmonic emissions, measured at 3 m, shall not exceed 50 mV/m and 0.5 mV/m respectively.

According to RSS-210 Issue 10 Clause Annex B B.10 (b): Emissions radiated outside of the specified frequency bands, except for harmonic emissions, shall be attenuated by at least 50 dB below the level of the fundamental emissions or to the general field strength limits listed in RSS-GEN Issue 5, whichever is less stringent.

Field strength limits at various frequencies		
Fundamental frequency	Field strength (mV/m)	
	Fundamental emissions	Harmonic emissions
920-928 MHz	50	0.5
2400-2483.5 MHz	50	0.5
5725-5875 MHz	50	0.5
24.0-24.25 GHz	250	2.5

As per RSS-210 Issue 10 Clause Annex B B.10, Field strength limits are specified at a distance of 3 meters.

8.2 EUT Setup

Below 1 GHz:

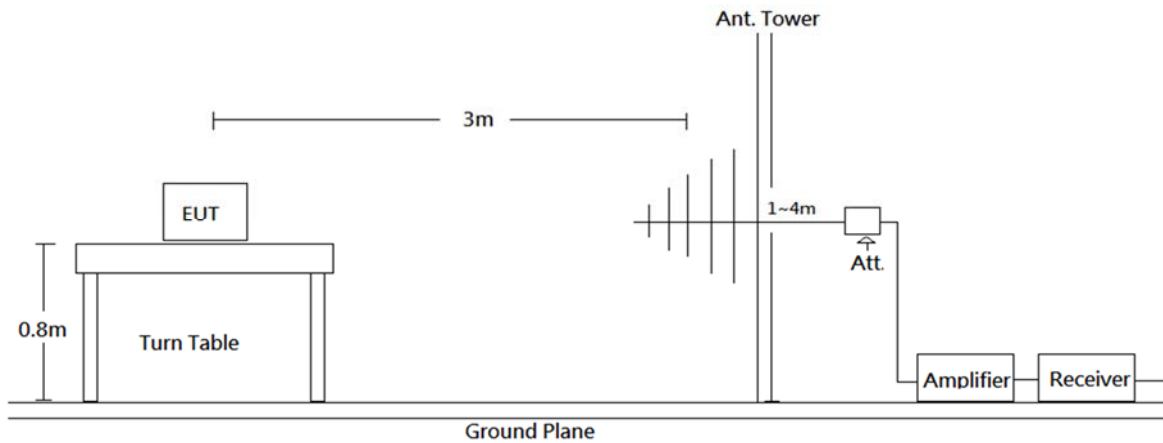

Above 1 GHz:

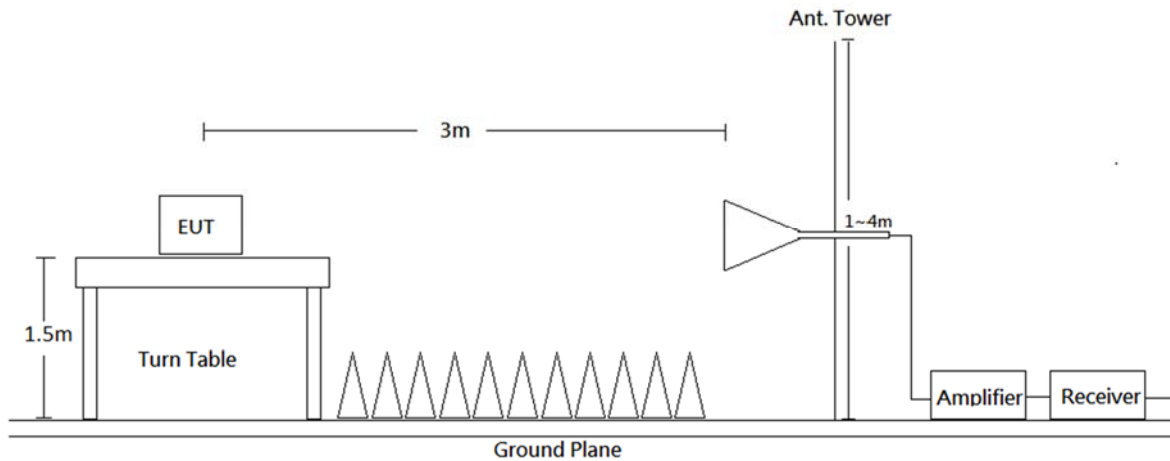

Radiated emission tests were performed in the 3 meters chamber test site, using the setup accordance with the ANSI C63.10-2013. The specification used was the FCC 15.205, FCC 15.209, FCC 15.249 and RSS-GEN, RSS-210 limits.

8.3 EMI Test Receiver & Spectrum Analyzer Setup

The system was studied from 30 MHz to 10 GHz. During radiated emission testing, the EMI test setup refers to ANSI C63.10 4.1.4.2.4.

8.4 Test Procedure

Maximizing procedure was performed on the highest emissions to ensure that the EUT complied with all installation combinations.

All data was recorded in the Quasi-peak detector mode from 30 MHz to 1 GHz and PK and average detector modes for frequencies above 1 GHz.

8.5 Corrected Factor & Margin Calculation

The Correct Factor is calculated by adding the Antenna Factor and Cable Loss, and subtracting the Amplifier Gain from the Meter Reading. The basic equation is as follows:

$$\text{Correct Factor} = \text{Antenna Factor} + \text{Cable Loss} - \text{Amplifier Gain}$$

The “Margin” column of the following data tables indicates the degree of compliance with the applicable limit. For example, a margin of -7 dB means the emission is 7 dB below the limit. The equation for margin calculation is as follows:

$$\text{Margin} = \text{Result} - \text{Limit}$$

8.6 Test Results Summary

According to the data in the following table, the EUT complied with the FCC 15.205, FCC 15.209, FCC 15.249 and RSS-210, RSS-Gen Limit.

8.7 Test Results

Test Mode: Transmitting

(Pre-scan with three orthogonal axis, and worse case as Z axis.)

Horizontal (worst case is High channel)

Fundamental:

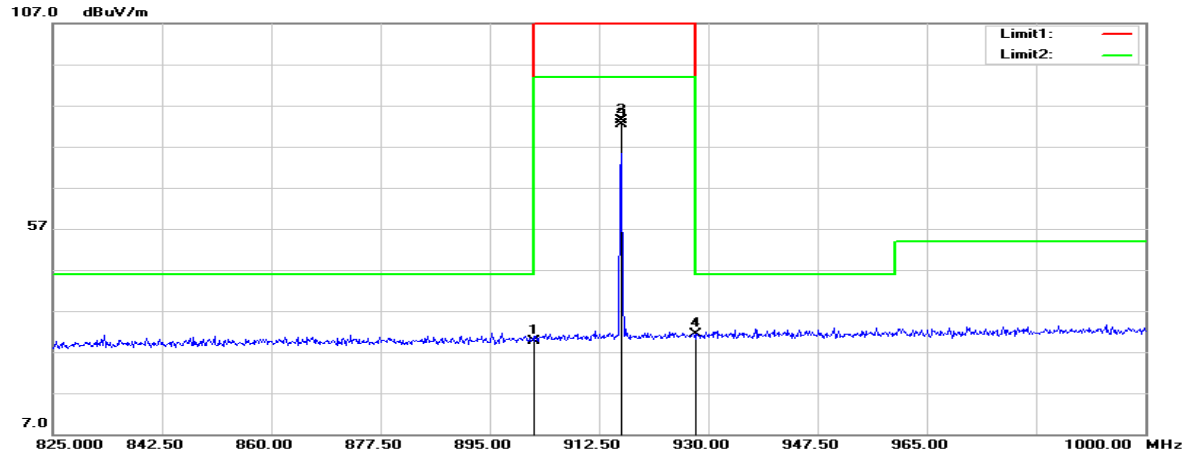

30MHz-1GHz:

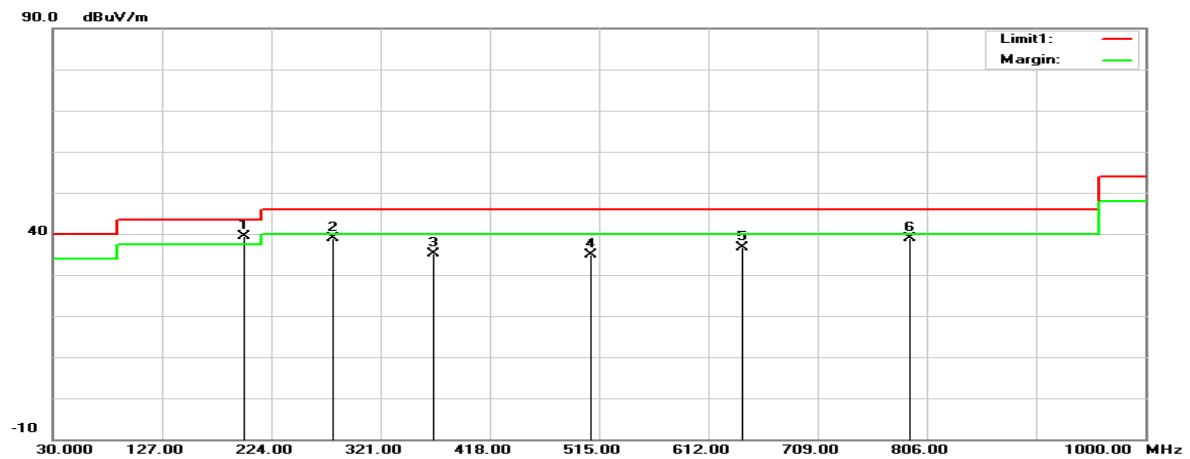

1GHz-10GHz:

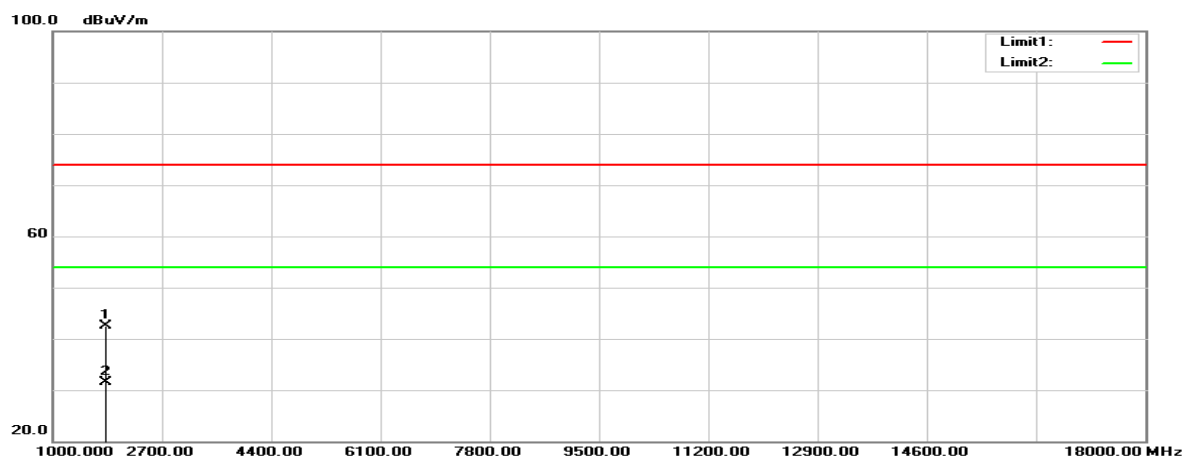

Vertical

Fundamental:

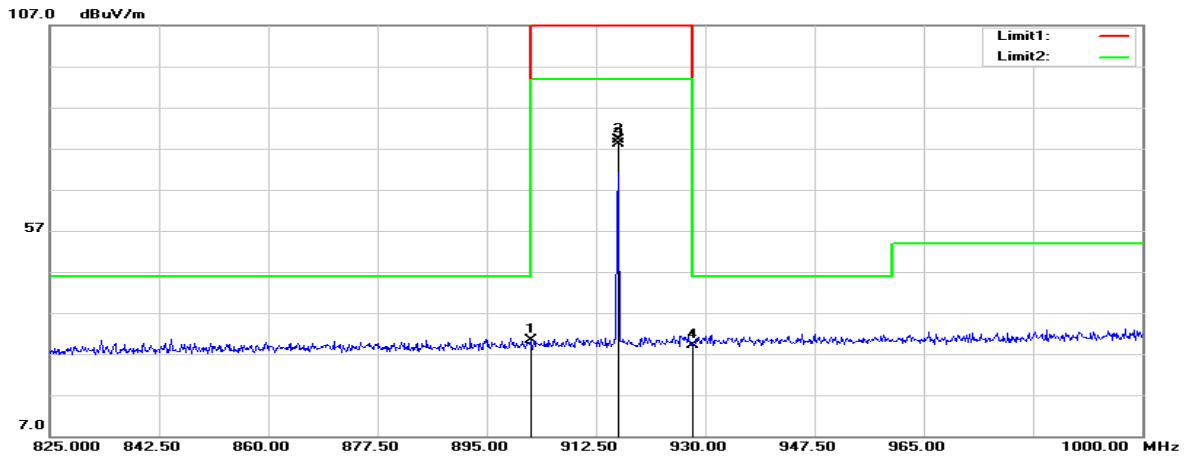

30MHz-1GHz:

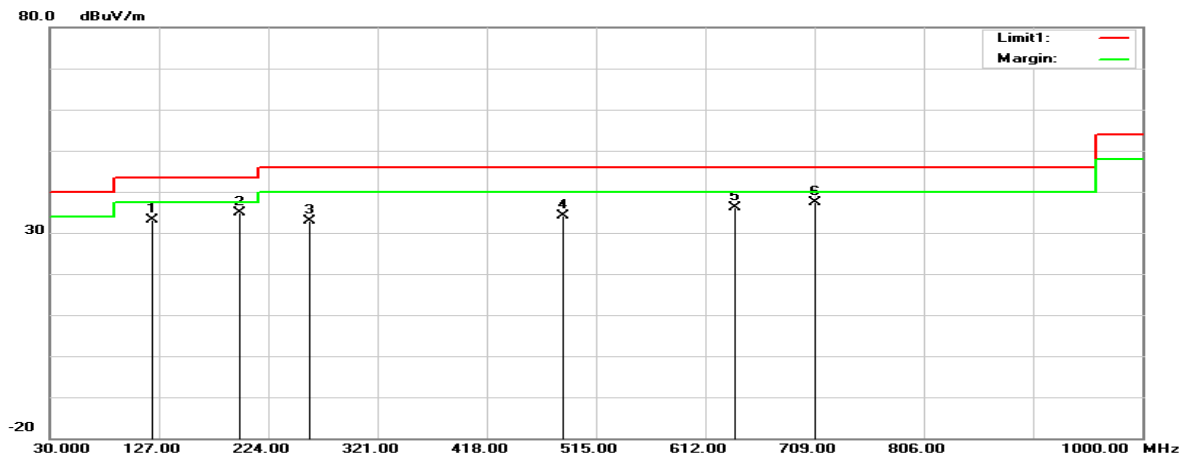

1GHz-10GHz:

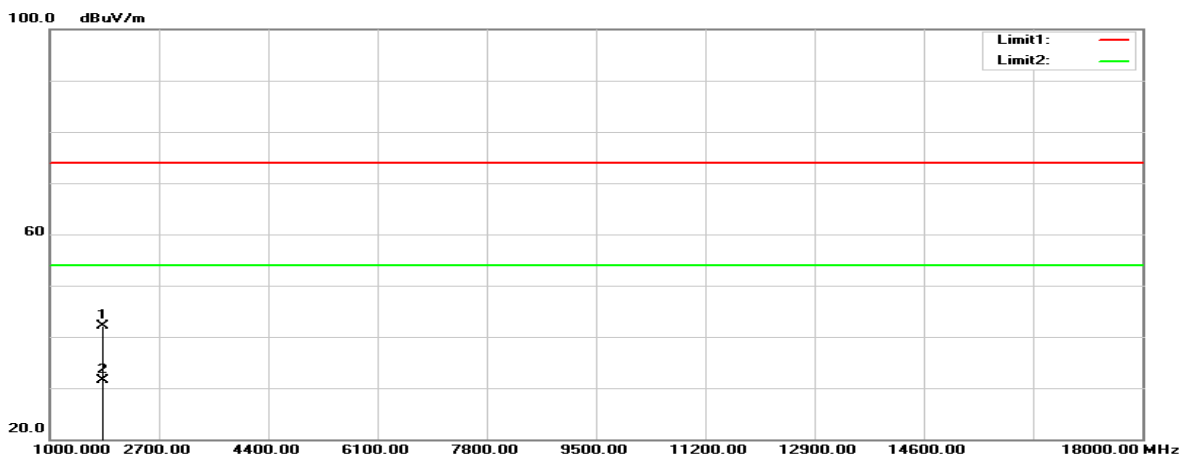

30MHz ~ 10GHz**Horizontal**

Frequency (MHz)	Reading (dB μ V)	Correct Factor(dB/m)	Result (dB μ V/m)	Limit (dB μ V/m)	Margin (dB)	Height (cm)	Degree ($^{\circ}$)	Remark
Low channel								
902.0000	28.64	1.01	29.65	46.00	-16.35	100	286	peak
908.4000	81.27	1.33	82.60	114.00	-31.40	100	286	peak
908.4000	80.54	1.33	81.87	94.00	-12.13	100	286	AVG
928.0000	28.34	1.79	30.13	46.00	-15.87	100	286	peak
1816.800	59.41	-12.46	46.95	74.00	-27.05	157	211	peak
1816.800	48.56	-12.46	36.10	54.00	-17.90	157	211	AVG
High channel								
199.7500	50.49	-10.99	39.50	43.50	-4.00	100	242	peak
278.3200	49.04	-10.27	38.77	46.00	-7.23	100	271	peak
367.5600	43.72	-8.70	35.02	46.00	-10.98	100	359	peak
508.2100	40.44	-5.65	34.79	46.00	-11.21	100	359	peak
642.0700	40.72	-3.97	36.75	46.00	-9.25	100	14	peak
790.4800	39.88	-1.10	38.78	46.00	-7.22	100	312	peak
902.0000	28.55	1.01	29.56	46.00	-16.44	100	275	peak
916.0000	81.83	1.59	83.42	114.00	-30.58	100	275	peak
916.0000	80.68	1.59	82.27	94.00	-11.73	100	275	AVG
928.0000	29.55	1.79	31.34	46.00	-14.66	100	275	peak
1832.000	54.82	-12.31	42.51	74.00	-31.49	162	173	peak
1832.000	43.77	-12.31	31.46	54.00	-22.54	162	173	AVG

Result = Reading + Correct Factor

Margin = Result – Limit

Correct Factor = Antenna Factor + Cable Loss – Amplifier Gain

Spurious emissions more than 20 dB below the limit were not reported.

Vertical

Frequency (MHz)	Reading (dB μ V)	Correct Factor(dB/m)	Result (dB μ V/m)	Limit (dB μ V/m)	Margin (dB)	Height (cm)	Degree ($^{\circ}$)	Remark
Low channel								
902.0000	29.05	1.01	30.06	46.00	-15.94	100	325	peak
908.4750	77.54	1.33	78.87	114.00	-35.13	100	325	peak
908.4750	76.38	1.33	77.71	94.00	-16.29	100	325	AVG
928.0000	28.23	1.79	30.02	46.00	-15.98	100	325	peak
1816.800	52.55	-12.46	40.09	74.00	-33.91	155	164	peak
1816.800	42.92	-12.46	30.46	54.00	-23.54	155	164	AVG
High channel								
121.1800	43.39	-10.21	33.18	43.50	-10.32	100	280	peak
198.7800	45.93	-11.09	34.84	43.50	-8.66	100	290	peak
260.8600	44.48	-11.53	32.95	46.00	-13.05	100	271	peak
485.9000	40.00	-5.88	34.12	46.00	-11.88	100	193	peak
638.1900	40.30	-4.12	36.18	46.00	-9.82	100	182	peak
709.9700	40.02	-2.69	37.33	46.00	-8.67	100	115	peak
902.0000	29.37	1.01	30.38	46.00	-15.62	100	339	peak
916.0000	77.44	1.59	79.03	114.00	-34.97	100	339	peak
916.0000	76.58	1.59	78.17	94.00	-15.83	100	339	AVG
928.0000	27.39	1.79	29.18	46.00	-16.82	100	339	peak
1832.000	54.36	-12.31	42.05	74.00	-31.95	154	322	peak
1832.000	43.82	-12.31	31.51	54.00	-22.49	154	322	AVG

Result = Reading + Correct Factor

Margin = Result – Limit

Correct Factor = Antenna Factor + Cable Loss – Amplifier Gain

Spurious emissions more than 20 dB below the limit were not reported.

9 FCC §15.215(c) & RSS-GEN CLAUSE 6.7 – 20 dB Bandwidth Testing and 99% OCCUPIED BANDWIDTH

9.1 Applicable Standard

Intentional radiators operating under the alternative provisions to the general emission limits, as contained in § 15.217 through 15.257 and in Subpart E of this part, must be designed to ensure that the 20 dB bandwidth of the emission, or whatever bandwidth may otherwise be specified in the specific rule section under which the equipment operates, is contained within the frequency band designated in the rule section under which the equipment is operated.

According to RSS-Gen Clause 6.7:

The occupied bandwidth or the “99% emission bandwidth” is defined as the frequency range between two points, one above and the other below the carrier frequency, within which 99% of the total transmitted power of the fundamental transmitted emission is contained. The occupied bandwidth shall be reported for all equipment in addition to the specified bandwidth required in the applicable RSSs.

In some cases, the “x dB bandwidth” is required, which is defined as the frequency range between two points, one at the lowest frequency below and one at the highest frequency above the carrier frequency, at which the maximum power level of the transmitted emission is attenuated x dB below the maximum inband power level of the modulated signal, where the two points are on the outskirts of the in-band emission.

The following conditions shall be observed for measuring the occupied bandwidth and x dB bandwidth:

The transmitter shall be operated at its maximum carrier power measured under normal test conditions.

The span of the spectrum analyzer shall be set large enough to capture all products of the modulation process, including the emission skirts, around the carrier frequency, but small enough to avoid having other emissions (e.g. on adjacent channels) within the span.

The detector of the spectrum analyzer shall be set to “Sample”. However, a peak, or peak hold, may be used in place of the sampling detector since this usually produces a wider bandwidth than the actual bandwidth (worst-case measurement). Use of a peak hold (or “Max Hold”) may be necessary to determine the occupied / x dB bandwidth if the device is not transmitting continuously.

The resolution bandwidth (RBW) shall be in the range of 1% to 5% of the actual occupied / x dB bandwidth and the video bandwidth (VBW) shall not be smaller than three times the RBW value. Video averaging is not permitted.

Note: It may be necessary to repeat the measurement a few times until the RBW and VBW are in compliance with the above requirement.

9.2 Test Procedure

1. Check the calibration of the measuring instrument using either an internal calibrator or a known signal from an external generator.
2. Position the EUT without connection to measurement instrument. Turn on the EUT and connect it to measurement instrument. Then set it to any one convenient frequency within its operating range. Set a reference level on the measuring instrument equal to the highest peak value.
3. Measure the frequency difference of two frequencies that were attenuated 20 dB from the reference level. Record the frequency difference as the emission bandwidth.
4. Repeat above procedures until all frequencies measured were complete.

For the 99% emission bandwidth, the trace data points are recovered and directly summed in linear power level terms. The recovered amplitude data points, beginning at the lowest frequency, are placed in a running sum until 0.5% of the total is reached, and that frequency recorded. The process is repeated for the highest frequency data points (starting at the highest frequency, at the right side of the span, and going down in frequency). This frequency is then recorded. The difference between the two recorded frequencies is the occupied bandwidth (or the 99% emission bandwidth).

9.3 Test Results

Channel	Frequency (MHz)	20 dB Emission Bandwidth (kHz)	99% Occupied Bandwidth (kHz)
Low	908.4	99.9	94.07
High	916	115.8	115.77

Please refer to the following plots

20 dB Emission Bandwidth

Low Channel

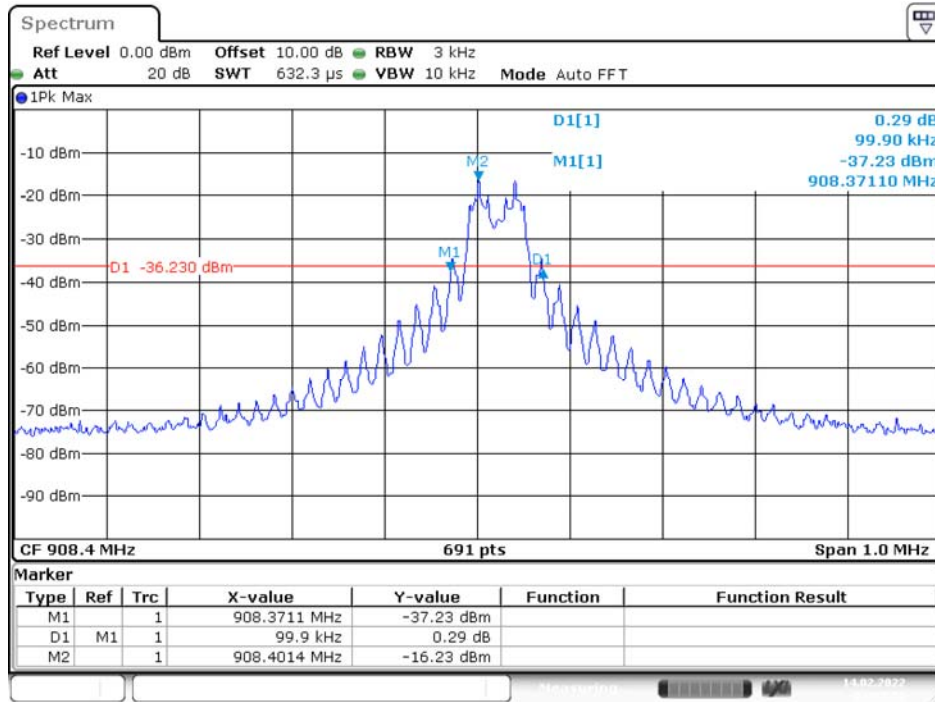

Date: 14.FEB.2022 03:31:57

High Channel

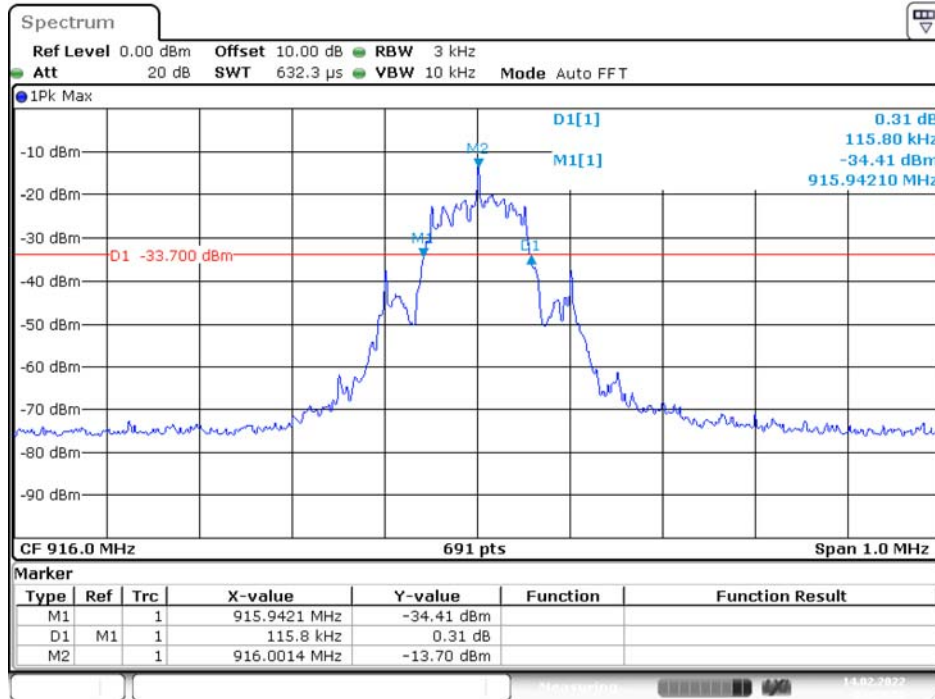

Date: 14.FEB.2022 03:29:58

99% Occupied Bandwidth

Low Channel

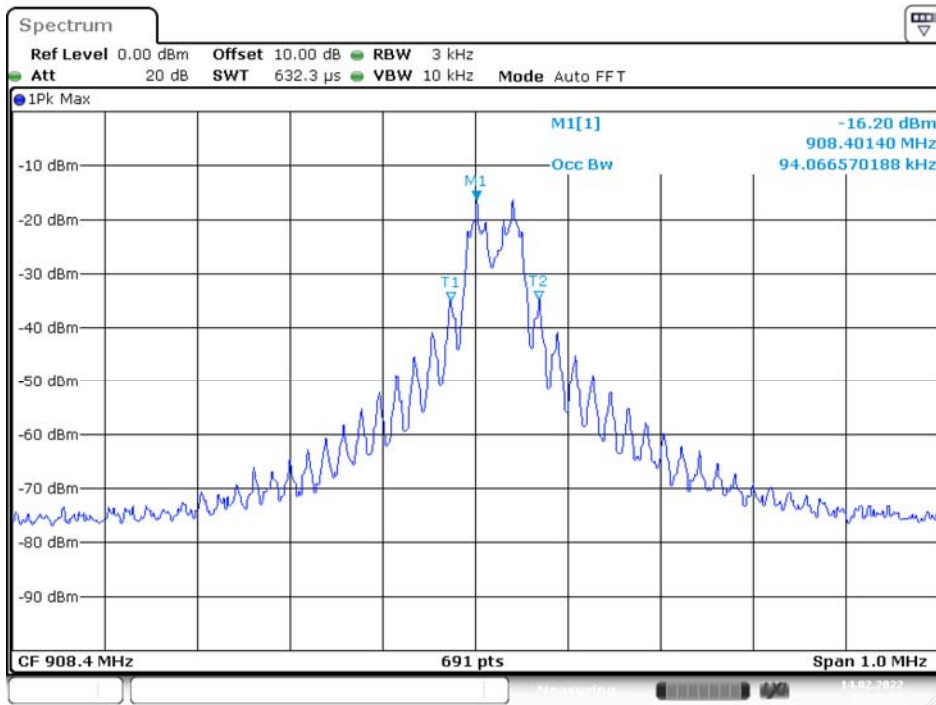

Date: 14.FEB.2022 03:40:19

High Channel

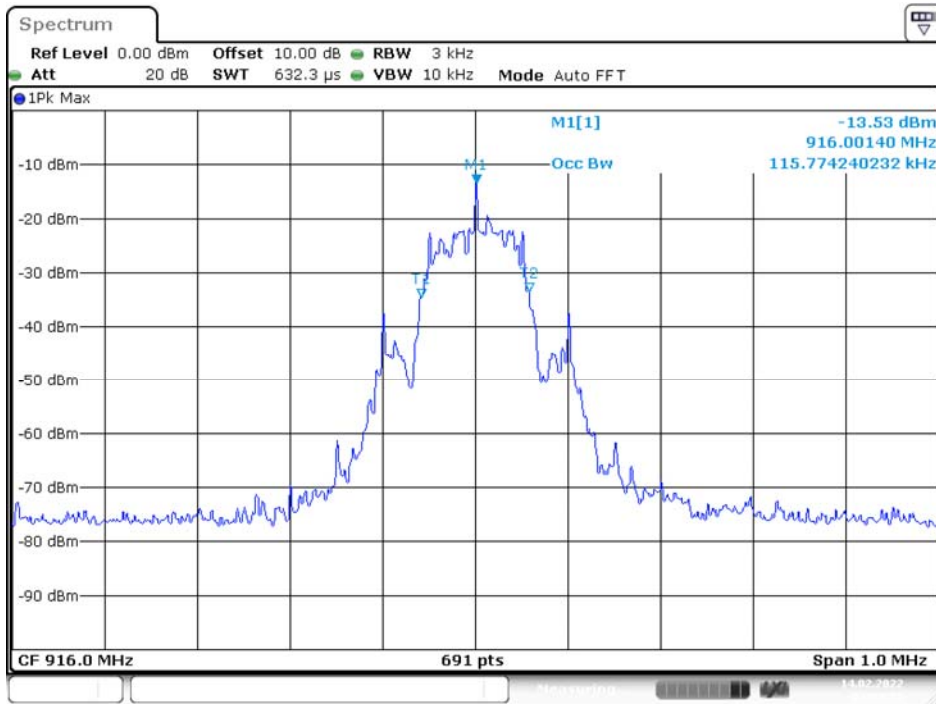

Date: 14.FEB.2022 03:38:28

***** END OF REPORT *****