



TEST REPORT

Product : WiFi Module
Model Name : CB3S
Report No. : PTC24010602005E-RF01

Prepared for

NIE-TECH Co., Ltd

Jilian commercial center 9001, Jinxiu road No.2, Changan Town, Dongguan City, Guangdong Prov.,
CHINA

Prepared by

Precise Testing & Certification Co., Ltd

Building 1, No. 6, Tongxin Road, Dongcheng Street, Dongguan, Guangdong, China

TEL: +86-769-3880 8222

FAX: +86-769-3882 6111





1 Test Result Certification

Applicant's name : NIE-TECH Co., Ltd
Address : Jilian commercial center 9001, Jinxiu road No.2, Changan Town, Dongguan City, GuangDongProv., CHINA
Manufacture's name : NIE-TECH Co., Ltd
Address : Jilian commercial center 9001, Jinxiu road No.2, Changan Town, Dongguan City, GuangDongProv., CHINA
Product name : WiFi Module
Model name : CB3S
Standards : GB/T 9410-2008; ANSI/IEEE Std 149-1979
Test Date : Jan. 23, 2024 to Jan. 24, 2024
Date of Issue : Jan. 24, 2024
Test Result : Pass

This device described above has been tested by PTC, and the test results show that the equipment under test (EUT) is in compliance with the GB/T 9410 and ANSI/IEEE Std 149 requirements. And it is applicable only to the tested sample identified in the report.

This report shall not be reproduced except in full, without the written approval of PTC, this document may be altered or revised by PTC, personal only, and shall be noted in the revision of the document.

Test Engineer:

Technical Manager:





Revision History of Report

Vision No.	Date	Revisions	Modifier
00	Jan. 24, 2024	Initial Issue	



Contents

1 Test Result Certification	2
2 Test Summary	5
3 Test Site	6
3.1 Test Facility	6
3.2 Measurement Uncertainty	6
3.3 List Of Test And Measurement Instruments	6
3.4 Test environmental	6
3.5 Test Setup	7
4 EUT Description	8
5 Test Data	9
5.1 Typical free space efficiency and gain	9
5.2 Typical free space radiation pattern	10
5.3 3D Pattern	12
6 EUT setup photo of free space OTA testing	14
7 EUT appearance	15



2 Test Summary

Name	Parameter	Method	Standard no.
Mobile communication antenna	Antenna gain	Generic specification for antennas used in the mobile communications	GB/T 9410-2008
	Radiation pattern		
Antenna	Radiation efficiency	IEEE Standard Test Procedures for Antennas	ANSI/IEEE Std 149-1979
	Gain and directivity		



3 Test Site

3.1 Test Facility

Name	Precise Testing & Certification Co., Ltd
Address	Building 1, No. 6, Tongxin Road, Dongcheng Street, Dongguan, Guangdong, China

3.2 Measurement Uncertainty

The uncertainty was calculated on the basis of the GUM published by ISO, using the inclusion factor of $K=2$ and the 95% confidence level to express the extended uncertainty.

Item	Uncertainty
Antenna gain	$\pm 0.68\text{dB}$
Radiation efficiency	$\pm 0.68\text{dB}$

3.3 List Of Test And Measurement Instruments

Name of Equipment	Manufacturer	Serial No.	Last Cal.	Calibration Interval
24 probe microwave chamber	YIHENG ELECTPONC	4*4*4	Jan. 10,2024	1 Year
Network Analyzer	E5071C	Agilent	Jan. 10,2024	1 Year
XH.PassiveTest 2.7.6	XH-IOT	/	/	/

3.4 Test environmental

Environment Parameter	Selected Values During the Testes	
Relative Humidity	45% to 55%	
Value	Temperature($^{\circ}\text{C}$)	Voltage(V)
NTNV	20 to 24	N/A

Note: NV: Normal Voltage; NT: Normal Temperature



3.5 Test Setup

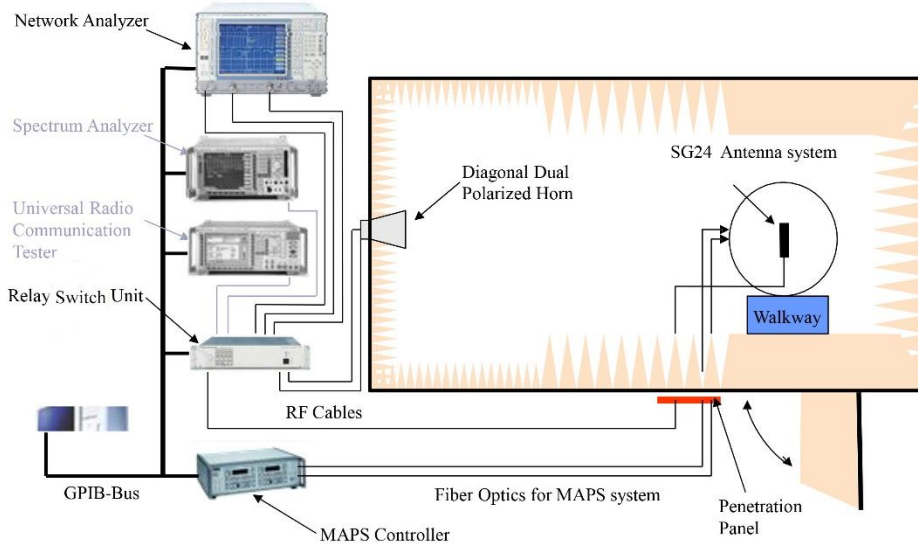



4 EUT Description

Product Name	WiFi Module
Sample Model	CB3S
Size	/
Test Item	Antenna gain; Radiation pattern and efficiency
Antenna Type	PCB Antenna
Frequency Range	2400MHz-2500MHz



5 Test Data

5.1 Typical free space efficiency and gain

Frequency/MHz	Efficiency / dB	Efficiency / %	Max Gain/dBi	Avg Gain/dBi
2400	-3.09	49.09	4.75	-3.09
2410	-3.04	49.66	4.99	-3.04
2420	-3.17	48.19	5.26	-3.17
2430	-3.17	48.19	4.88	-3.17
2440	-3.2	47.86	4.56	-3.2
2450	-3.41	45.6	4.58	-3.41
2460	-3.53	44.36	4.31	-3.53
2470	-3.57	43.95	4.1	-3.57
2480	-3.52	44.46	4.55	-3.52
2490	-3.52	44.46	4.41	-3.52
2500	-3.36	46.13	4.18	-3.36

5.2 Typical free space radiation pattern

(1) X-Z Plane:
V Phi=0

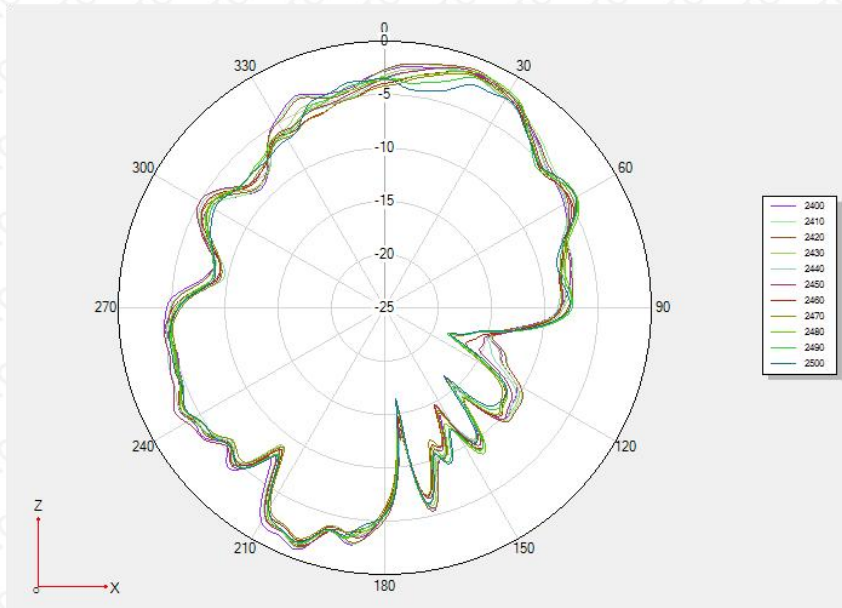

(2) Y-Z Plane:
V Phi=90

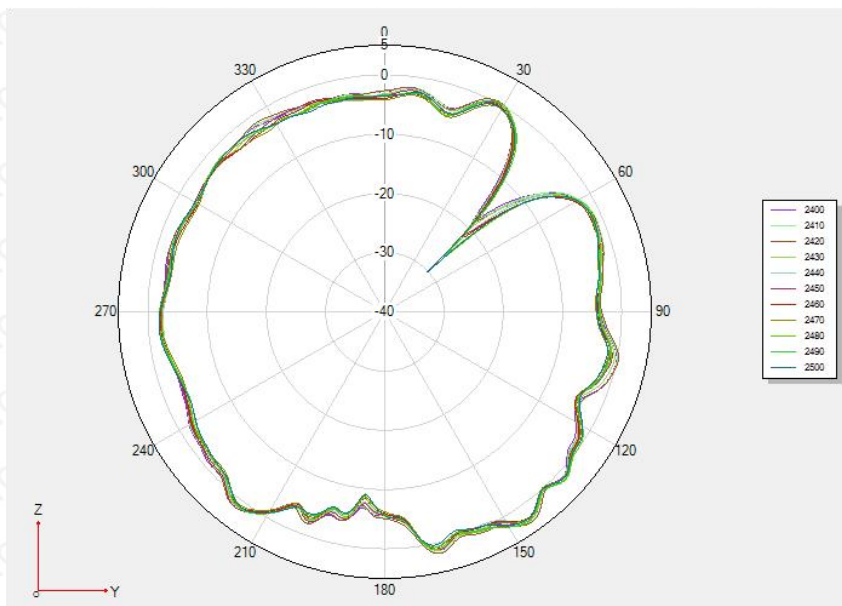



(3)X-Y Plane:
H Theta=90

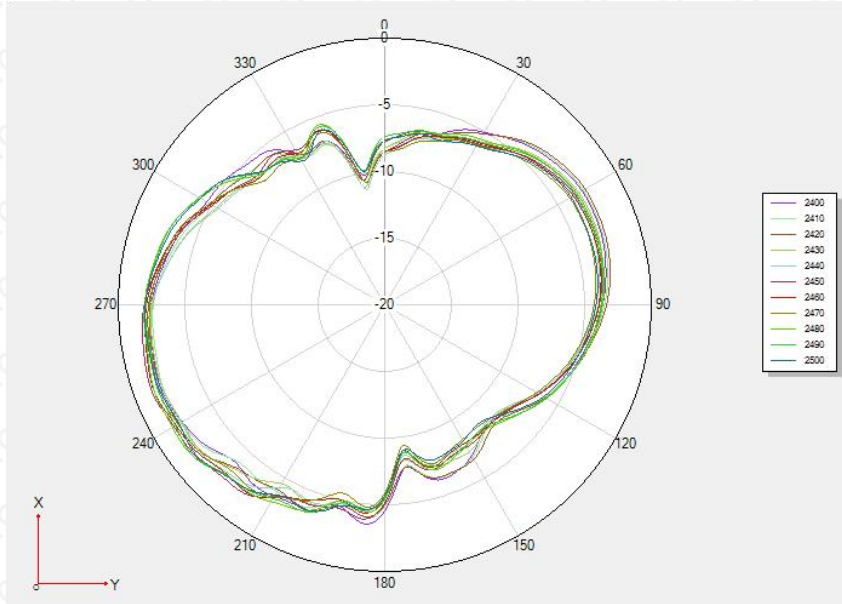



5.3 3D Pattern

3D Pattern for 2400MHz

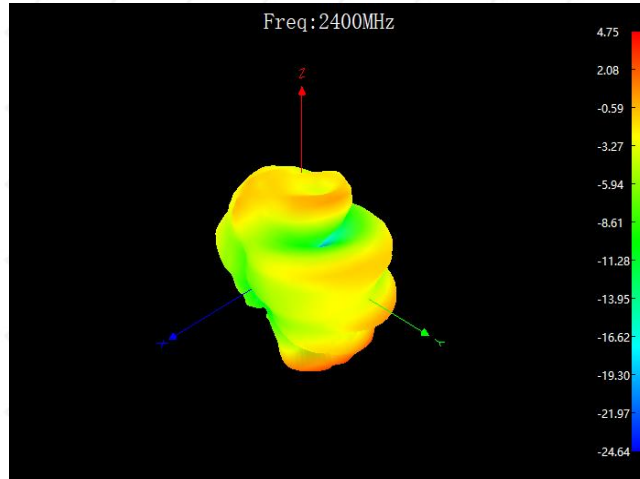

3D Pattern for 2450MHz

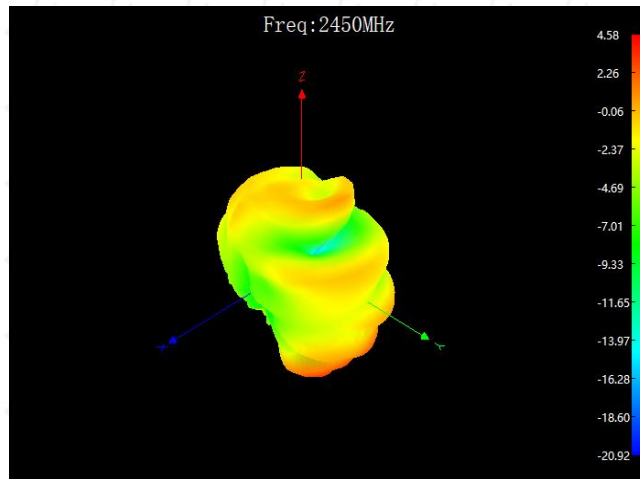



3D Pattern for 2500MHz

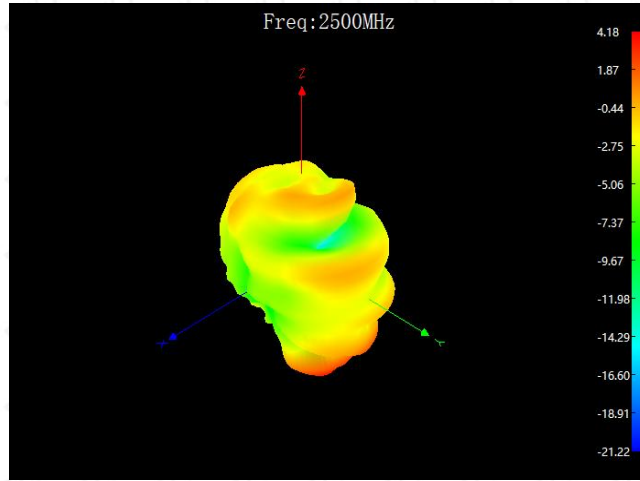



6 EUT setup photo of free space OTA testing

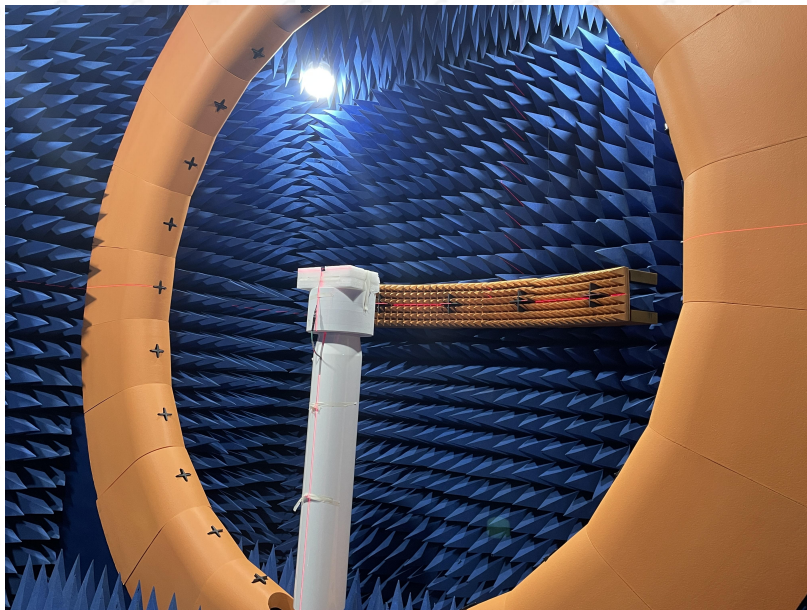
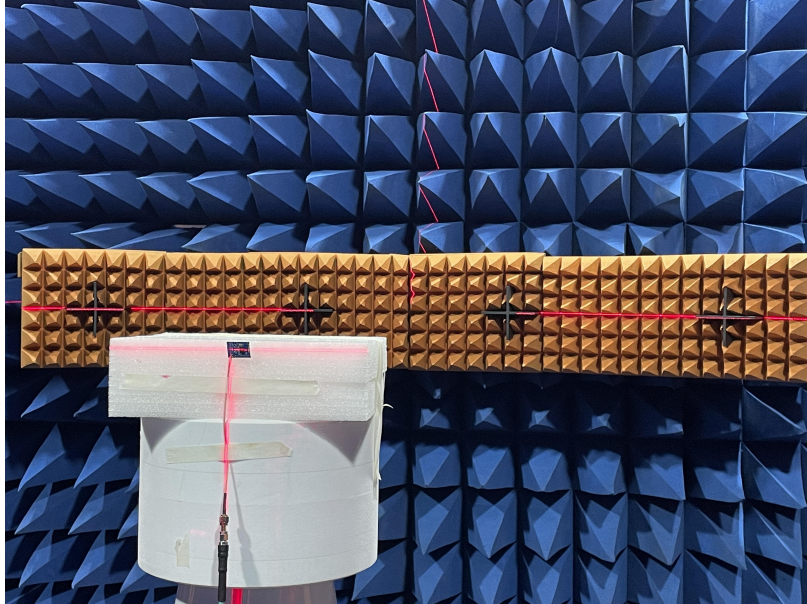



7 EUT appearance



4. Antenna Dimensions

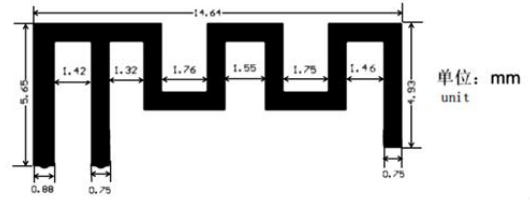

*****THE END REPORT*****