



SPORTON International Inc.

No. 52, Hwa Ya 1st Rd., Kwei-Shan Hsiang, TaoYuan Hsien, Taiwan, R.O.C.
Ph: 886-3-327-3456 / FAX: 886-3-327-0973 / www.sporton.com.tw

FCC RADIO TEST REPORT

Applicant's company	Wistron NeWeb Corporation
Applicant Address	20 Park Avenue II, Hsinchu Science Park, Hsinchu 308, Taiwan, R.O.C.
FCC ID	NKRUWMWBT-CWM01
Manufacturer's company	Wistron NeWeb Corporation
Manufacturer Address	20 Park Avenue II, Hsinchu Science Park, Hsinchu 308, Taiwan, R.O.C.

Product Name	MOD-SM WNC BLUETOOTH/WLAN CWM-01
Brand Name	WNC
Model Name	CWN-01 / UWM-WBT
Test Rule	47 CFR FCC Part 15 Subpart C § 15.247
Test Freq. Range	2400 ~ 2483.5MHz
Received Date	Nov. 29, 2011
Final Test Date	Dec. 05, 2011
Submission Type	Original Equipment



Statement

Test result included is only for the Bluetooth part of the product.

The test result in this report refers exclusively to the presented test model / sample.

Without written approval of SPORTON International Inc., the test report shall not be reproduced except in full.

The measurements and test results shown in this test report were made in accordance with the procedures and found in compliance with the limit given in **ANSI C63.10-2009** and **47 CFR FCC Part 15 Subpart C**.

The test equipment used to perform the test is calibrated and traceable to NML/ROC.



Table of Contents

1. CERTIFICATE OF COMPLIANCE	1
2. SUMMARY OF THE TEST RESULT	2
3. GENERAL INFORMATION	3
3.1. Product Details.....	3
3.2. Accessories.....	3
3.3. Table for Filed Antenna.....	3
3.4. Table for Carrier Frequencies	4
3.5. Table for Test Modes	4
3.6. Table for Testing Locations.....	4
3.7. Table for Supporting Units	5
3.8. Table for Parameters of Test Software Setting	5
3.9. Test Configurations	6
4. TEST RESULT	9
4.1. AC Power Line Conducted Emissions Measurement.....	9
4.2. Maximum Peak Output Power Measurement	13
4.3. Hopping Channel Separation Measurement	15
4.4. Number of Hopping Frequency Measurement.....	20
4.5. Dwell Time Measurement.....	22
4.6. Radiated Emissions Measurement	29
4.7. Band Edge Emissions Measurement	38
4.8. Antenna Requirements	41
5. LIST OF MEASURING EQUIPMENTS	42
6. TEST LOCATION.....	44
7. TAF CERTIFICATE OF ACCREDITATION	45
APPENDIX A. TEST PHOTOS	A1 ~ A7
APPENDIX B. MAXIMUM PERMISSIBLE EXPOSURE	B1 ~ B3
APPENDIX C. CO-LOCATION REPORT	C1 ~C3



History of This Test Report

REPORT NO.	VERSION	DESCRIPTION	ISSUED DATE
FR1D0821AB	Rev. 01	Initial issue of report	Dec. 22, 2011

1. CERTIFICATE OF COMPLIANCE

Product Name : MOD-SM WNC BLUETOOTH/WLAN CWM-01
Brand Name : WNC
Model Name : CWN-01 / UWM-WBT
Applicant : Wistron NeWeb Corporation
Test Rule Part(s) : 47 CFR FCC Part 15 Subpart C § 15.247

Sporton International as requested by the applicant to evaluate the EMC performance of the product sample received on Nov. 29, 2011 would like to declare that the tested sample has been evaluated and found to be in compliance with the tested rule parts. The data recorded as well as the test configuration specified is true and accurate for showing the sample's EMC nature.

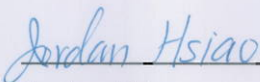

Jordan Hsiao

SPORTON INTERNATIONAL INC.

2. SUMMARY OF THE TEST RESULT

Applied Standard: 47 CFR FCC Part 15 Subpart C				
Part	Rule Section	Description of Test	Result	Under Limit
4.1	15.207	AC Power Line Conducted Emissions	Complies	17.19 dB
4.2	15.247(b)(1)	Maximum Peak Conducted Output Power	Complies	14.65 dB
4.3	15.247(a)(1)	Hopping Channel Separation	Complies	-
4.4	15.247(b)(1)	Number of Hopping Frequency	Complies	-
4.5	15.247(a)(1)	Dwell Time	Complies	-
4.6	15.247(d)	Radiated Emissions	Complies	3.57 dB
4.7	15.247(d)	Band Edge Emissions	Complies	0.50 dB
4.8	15.203	Antenna Requirements	Complies	-

Test Items	Uncertainty	Remark
AC Power Line Conducted Emissions	±2.3dB	Confidence levels of 95%
Maximum Peak Conducted Output Power	±0.8dB	Confidence levels of 95%
Hopping Channel Separation	±8.5×10 ⁻⁸	Confidence levels of 95%
Radiated Emissions (9kHz~30MHz)	±0.8dB	Confidence levels of 95%
Radiated Emissions (30MHz~1000MHz)	±1.9dB	Confidence levels of 95%
Radiated / Band Edge Emissions (1GHz~18GHz)	±1.9dB	Confidence levels of 95%
Radiated Emissions (18GHz~40GHz)	±1.9dB	Confidence levels of 95%
Temperature	±0.7°C	Confidence levels of 95%
Humidity	±3.2%	Confidence levels of 95%
DC / AC Power Source	±1.4%	Confidence levels of 95%

3. GENERAL INFORMATION

3.1. Product Details

Items	Description
Power Type	From host system
Modulation	FHSS (GFSK / $\pi/4$ -DQPSK / 8DPSK)
Data Rate (Mbps)	GFSK: 1 ; $\pi/4$ -QPSK: 2 ; 8DPSK: 3
Frequency Range	2400 ~ 2483.5MHz
Channel Number	79
Channel Band Width (99%)	1.1520 MHz
Conducted Output Power	6.35 dBm
Carrier Frequencies	Please refer to section 3.4
Antenna	Please refer to section 3.3

3.2. Accessories

N/A

3.3. Table for Filed Antenna

Ant.	Brand	Model Name	Antenna Type	Connector	Gain (dBi)
1	-	-	Dipole Antenna	Reversed-SMA	2
2	-	-	Dipole Antenna	Reversed-SMA	2

Note: The EUT has two antennas (1TX, 1RX).

<For WLAN Function>:

Only Ant. 1 can be used as transmitting/receiving antenna.

<For Bluetooth Function>:

Only Ant. 2 can be used as transmitting/receiving antenna.

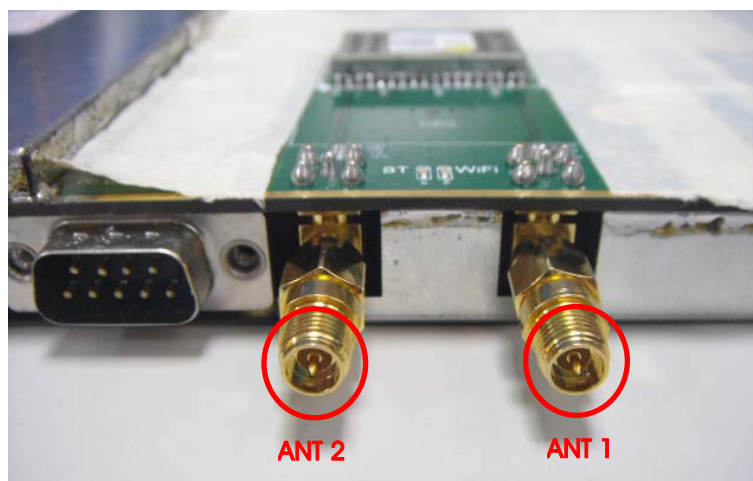

3.4. Table for Carrier Frequencies

Frequency Band	Channel No.	Frequency	Channel No.	Frequency
2400~2483.5MHz	0	2402 MHz	40	2442 MHz
	1	2403 MHz	:	:
	:	:	77	2479 MHz
	38	2440 MHz	78	2480 MHz
	39	2441 MHz	-	-

3.5. Table for Test Modes

Preliminary tests were performed in different data rate to find the worst radiated emission. The data rate shown in the table below is the worst-case rate with respect to the specific test item. Investigation has been done on all the possible configurations for searching the worst cases. The following table is a list of the test modes shown in this test report.

Test Items	Mode	Data Rate	Channel	Antenna
AC Power Conducted Emissions	Normal Link	3 Mbps	Hopping 0~78	-
Max. Conducted Output Power	GFSK	3 Mbps	0/39/78	2
Hopping Channel Separation	GFSK	3 Mbps	0~1/39~40/77~78	2
Number of Hopping Frequency	GFSK	3 Mbps	0~78	2
Dwell Time	3DH1/3DH3/3DH5	3 Mbps	0/39/78	2
Radiated Emissions Below 1GHz	GFSK	3 Mbps	39	2
Radiated Emissions Above 1GHz	GFSK	3 Mbps	0/39/78	2
Band Edge Emissions	GFSK	3 Mbps	0/78	2

Note:

<For MPE and Co-location Test>:

The EUT could be applied with Bluetooth and wireless LAN function; therefore Maximum Permissible Exposure (please refer to Appendix B) and Co-location (please refer to Appendix C) tests are added for simultaneously transmit between Bluetooth and wireless LAN function.

3.6. Table for Testing Locations

Test Site No.	Site Category	Location	FCC Reg. No.	IC File No.	VCCI Reg. No
03CH01-CB	SAC	Hsin Chu	262045	IC 4086D	-
CO01-CB	Conduction	Hsin Chu	262045	IC 4086D	-
TH01-CB	OVEN Room	Hsin Chu	-	-	-

Open Area Test Site (OATS); Semi Anechoic Chamber (SAC); Fully Anechoic Chamber (FAC).

Please refer section 6 for Test Site Address.

3.7. Table for Supporting Units

Support Unit	Brand	Model	FCC ID
Notebook	DELL	M1330	E2K4965AGNM
Mouse	Logitech	M-U0026	DoC
Modem	ACEEX	DM1414	IFAXDM1414

3.8. Table for Parameters of Test Software Setting

During testing, Channel & Power Controlling Software provided by the customer was used to control the operating channel as well as the output power level. The RF output power selection is for the setting of RF output power expected by the customer and is going to be fixed on the firmware of the final end product.

Power Parameters of Bluetooth

Test Software Version	DutApiClass 1.0.3.06		
Frequency	2402 MHz	2441 MHz	2480 MHz
Power Parameters	Default	Default	Default

During the test, "DutApiClass 1.0.3.06" under WIN XP was executed the test program to control the EUT continuously transmit RF signal.

3.9. Test Configurations

3.9.1. Radiation Emissions Test Configuration

Test Configuration: 30MHz~1GHz

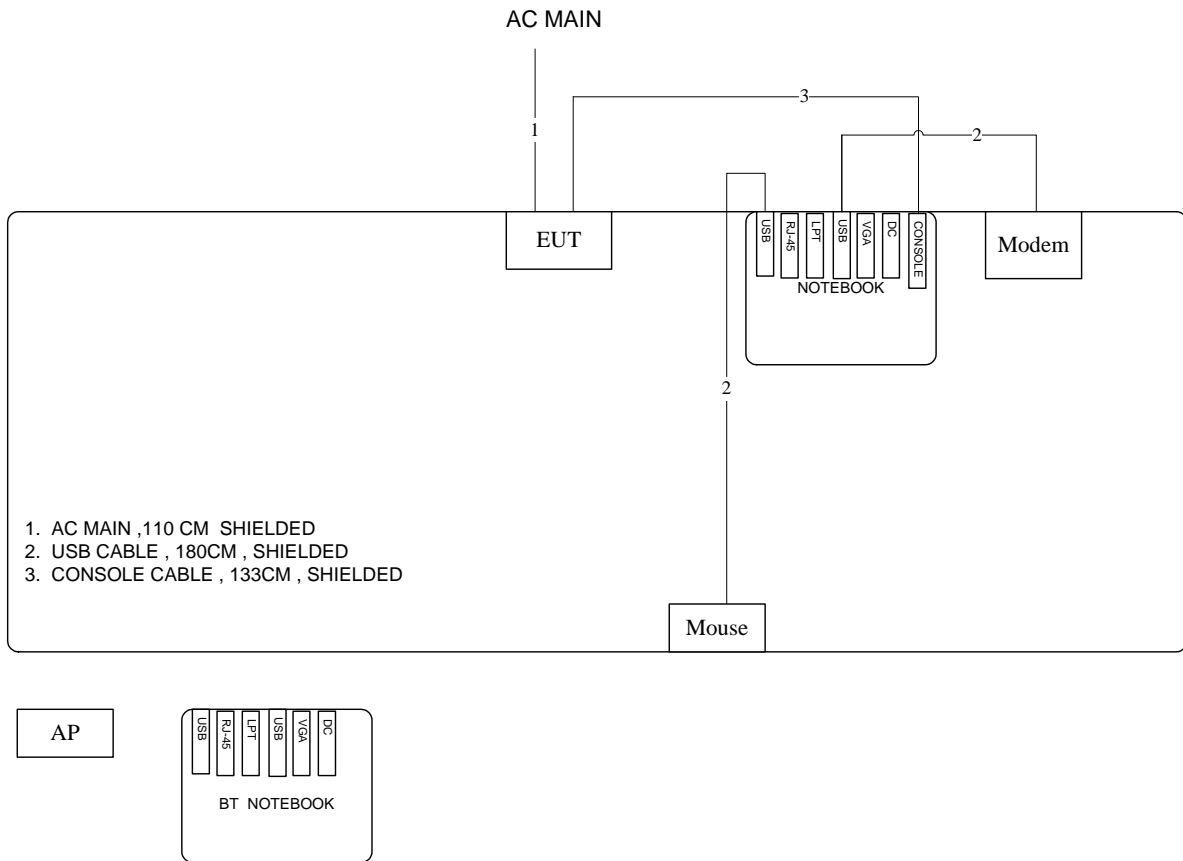

Test Configuration: above 1GHz

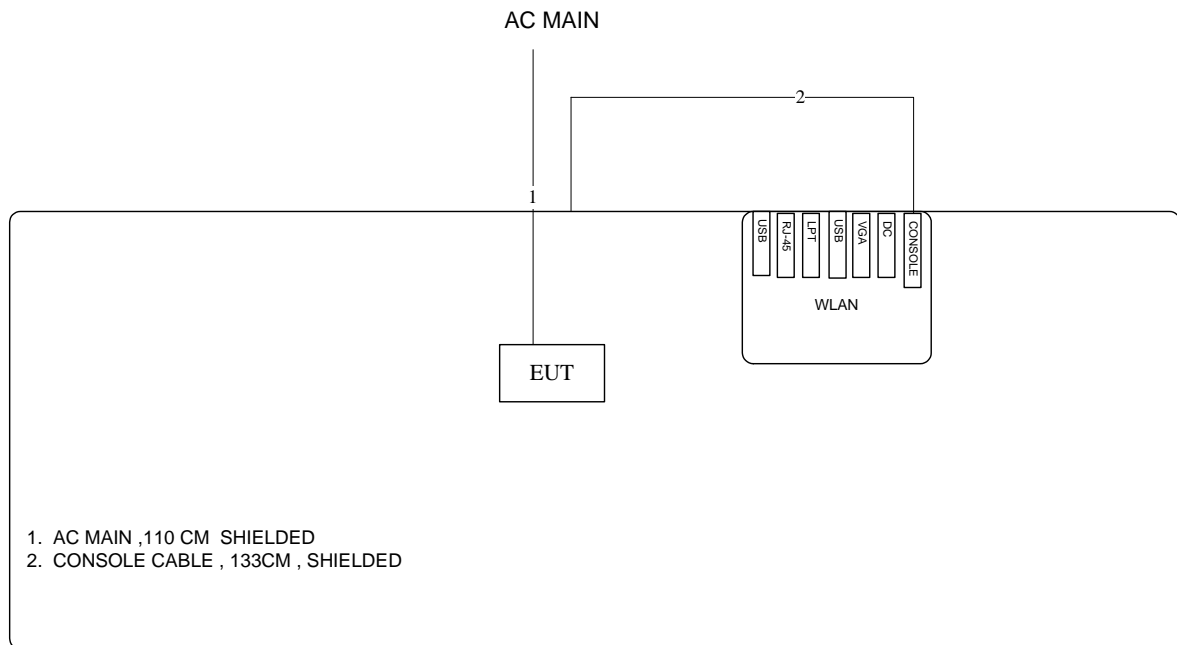

3.9.2. AC Power Line Conduction Emissions Test Configuration

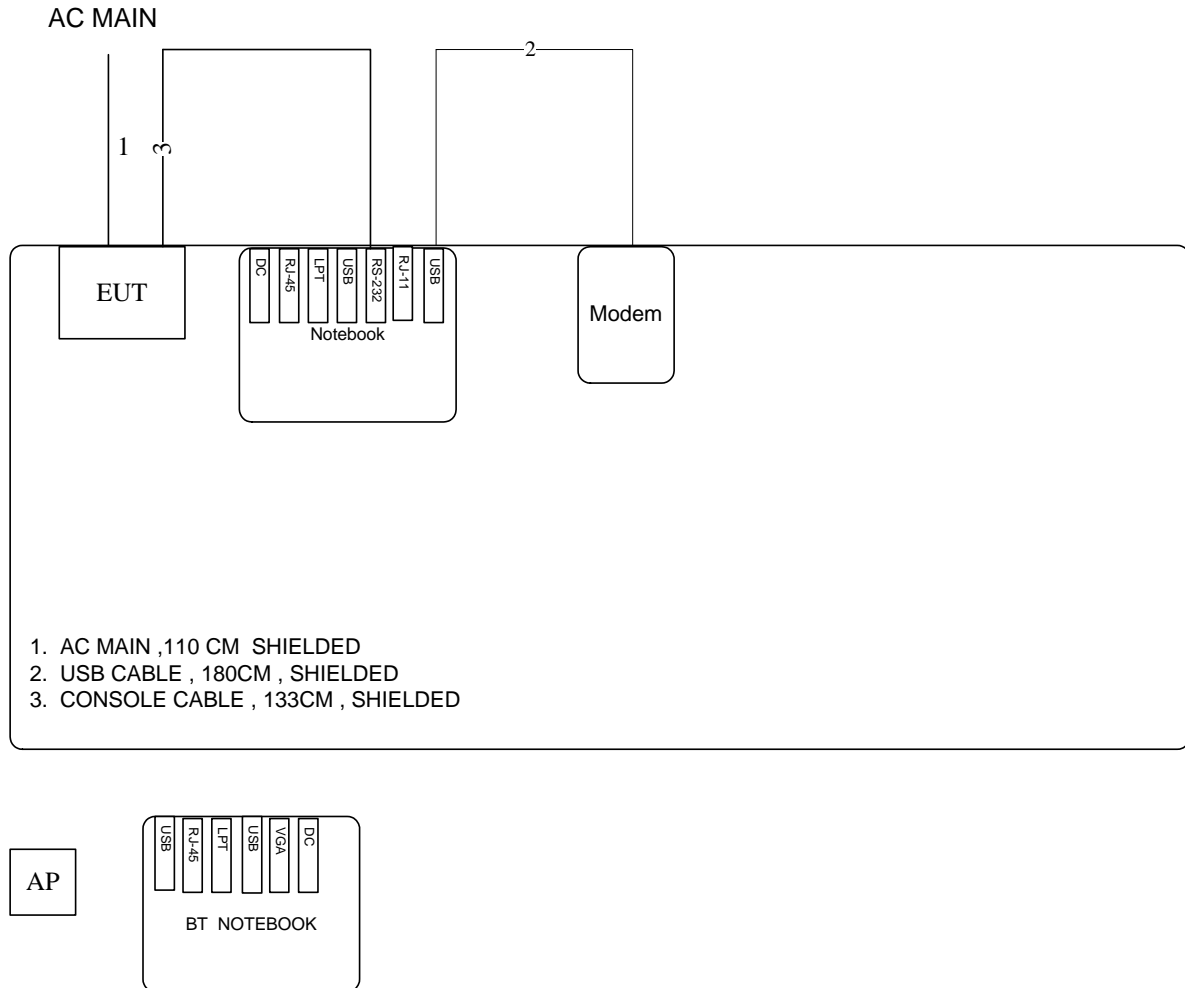

4. TEST RESULT

4.1. AC Power Line Conducted Emissions Measurement

4.1.1. Limit

For a Low-power Radio-frequency Device which is designed to be connected to the AC power line, the radio frequency voltage that is conducted back onto the AC power line on any frequency or frequencies within the band 150 kHz to 30 MHz shall not exceed below limits table.

Frequency (MHz)	QP Limit (dBuV)	AV Limit (dBuV)
0.15~0.5	66~56	56~46
0.5~5	56	46
5~30	60	50

4.1.2. Measuring Instruments and Setting

Please refer to section 5 of equipments list in this report. The following table is the setting of the receiver.

Receiver Parameters	Setting
Attenuation	10 dB
Start Frequency	0.15 MHz
Stop Frequency	30 MHz
IF Bandwidth	9 KHz

4.1.3. Test Procedures

1. Configure the EUT according to ANSI C63.10. The EUT or host of EUT has to be placed 0.4 meter far from the conducting wall of the shielding room and at least 80 centimeters from any other grounded conducting surface.
2. Connect EUT or host of EUT to the power mains through a line impedance stabilization network (LISN).
3. All the support units are connected to the other LISNs. The LISN should provide 50uH/50ohms coupling impedance.
4. The frequency range from 150 KHz to 30 MHz was searched.
5. Set the test-receiver system to Peak Detect Function and Specified Bandwidth with Maximum Hold Mode.
6. The measurement has to be done between each power line and ground at the power terminal.

4.1.4. Test Setup Layout

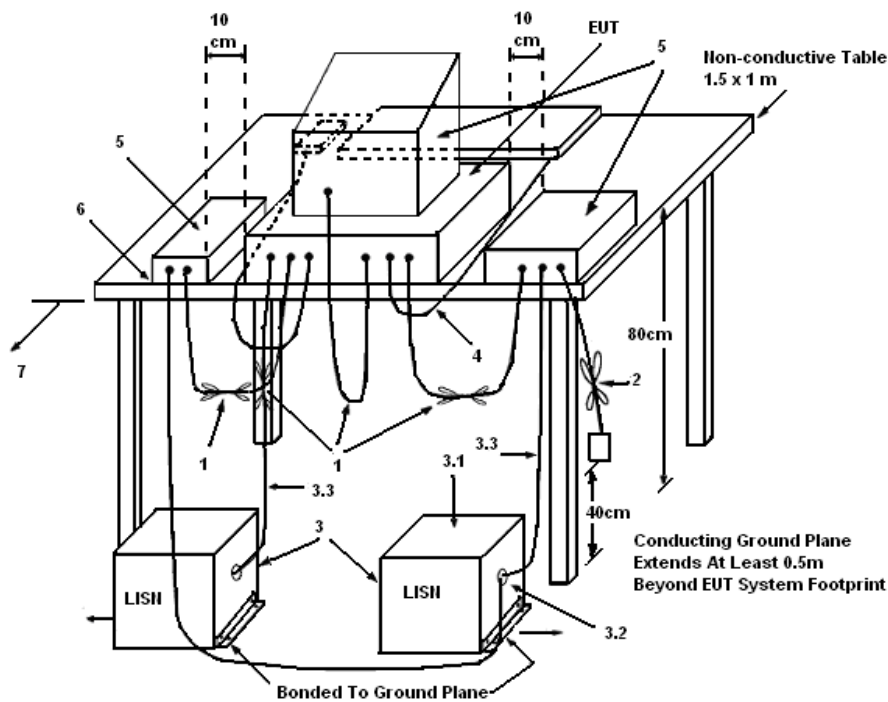

LEGEND:

- (1) Interconnecting cables that hang closer than 40 cm to the ground plane shall be folded back and forth in the center forming a bundle 30 to 40 cm long.
- (2) I/O cables that are not connected to a peripheral shall be bundled in the center. The end of the cable may be terminated, if required, using the correct terminating impedance. The overall length shall not exceed 1 m.
- (3) EUT connected to one LISN. Unused LISN measuring port connectors shall be terminated in 50 Ω . LISN can be placed on top of, or immediately beneath, reference ground plane.
 - (3.1) All other equipment powered from additional LISN(s).
 - (3.2) Multiple outlet strip can be used for multiple power cords of non-EUT equipment.
 - (3.3) LISN at least 80 cm from nearest part of EUT chassis.
- (4) Cables of hand-operated devices, such as keyboards, mice, etc., shall be placed as for normal use.
- (5) Non-EUT components of EUT system being tested.
- (6) Rear of EUT, including peripherals, shall all be aligned and flush with rear of tabletop.
- (7) Rear of tabletop shall be 40 cm removed from a vertical conducting plane that is bonded to the ground plane.

4.1.5. Test Deviation

There is no deviation with the original standard.

4.1.6. EUT Operation during Test

The EUT was placed on the test table and programmed in normal function.

4.1.7. Results of AC Power Line Conducted Emissions Measurement

Temperature	24°C	Humidity	63%
Test Engineer	Kane Liu	Phase	Line
Configuration	Normal Link		

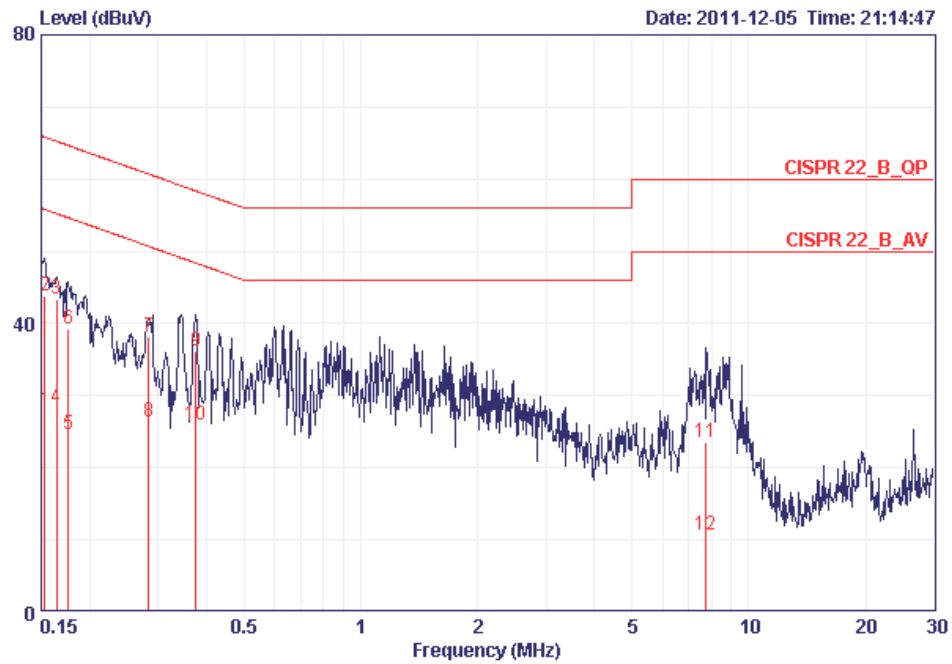

	Freq	Level	Over Limit	Limit Line	Read Level	LISN Factor	Cable Loss	Remark
	MHz	dBuV	dB	dBuV	dBuV	dB	dB	
1	0.15321	27.90	-27.92	55.82	27.63	0.07	0.20	AVERAGE
2	0.15321	43.89	-21.93	65.82	43.62	0.07	0.20	QP
3	0.16414	43.34	-21.91	65.25	43.07	0.07	0.20	QP
4	0.16414	28.39	-26.86	55.25	28.12	0.07	0.20	AVERAGE
5	0.17584	24.67	-30.01	54.68	24.41	0.06	0.20	AVERAGE
6	0.17584	39.24	-25.44	64.68	38.98	0.06	0.20	QP
7	0.28408	38.13	-22.57	60.70	37.89	0.04	0.20	QP
8	0.28408	26.35	-24.35	50.70	26.11	0.04	0.20	AVERAGE
9	0.37512	36.27	-22.11	58.39	36.04	0.03	0.20	QP
10	0.37512	25.83	-22.55	48.39	25.60	0.03	0.20	AVERAGE
11	7.769	23.49	-36.51	60.00	22.81	0.28	0.40	QP
12	7.769	10.58	-39.42	50.00	9.90	0.28	0.40	AVERAGE

Temperature	24°C	Humidity	63%
Test Engineer	Kane Liu	Phase	Neutral
Configuration	Normal Link		

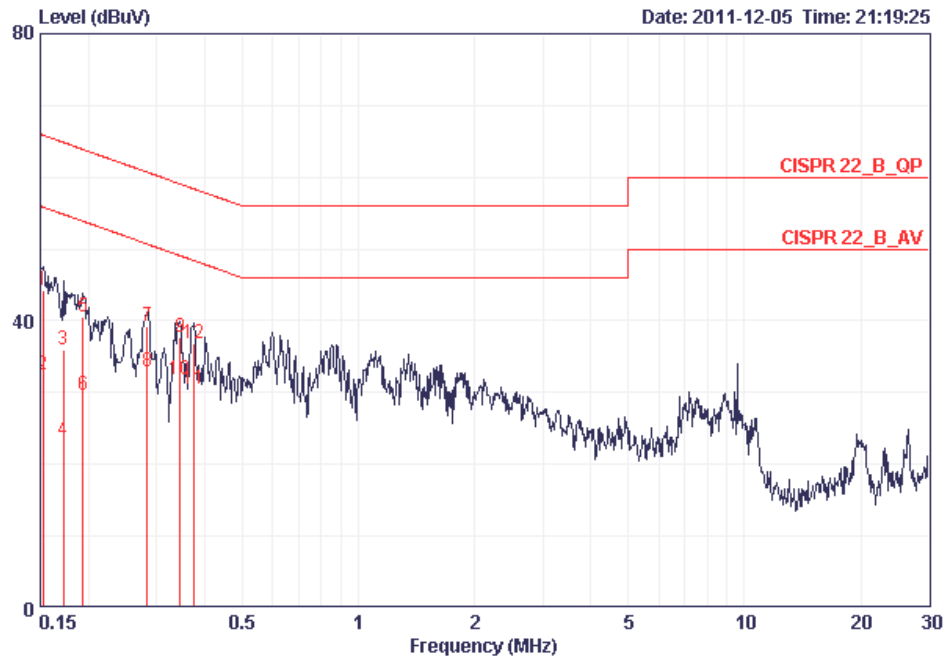

	Freq	Level	Over Limit	Limit Line	Read Level	LISN Factor	Cable Loss	Remark
	MHz	dBuV	dB	dBuV	dBuV	dB	dB	
1	0.15240	44.24	-21.62	65.87	43.94	0.10	0.20	QP
2	0.15240	32.40	-23.46	55.87	32.10	0.10	0.20	AVERAGE
3	0.17215	36.05	-28.80	64.86	35.76	0.09	0.20	QP
4	0.17215	23.35	-31.50	54.86	23.06	0.09	0.20	AVERAGE
5	0.19344	40.48	-23.40	63.89	40.20	0.08	0.20	QP
6	0.19344	29.60	-24.28	53.89	29.32	0.08	0.20	AVERAGE
7	0.28328	39.22	-21.49	60.72	38.95	0.07	0.20	QP
8	0.28328	32.92	-17.79	50.72	32.65	0.07	0.20	AVERAGE
9	0.34463	37.73	-21.36	59.09	37.46	0.07	0.20	QP
10	0.34463	31.90	-17.19	49.09	31.63	0.07	0.20	AVERAGE
11	0.37512	30.60	-17.79	48.39	30.33	0.07	0.20	AVERAGE
12	0.37512	36.83	-21.56	58.39	36.56	0.07	0.20	QP

Note: Level = Read Level + LISN Factor + Cable Loss.

4.2. Maximum Peak Output Power Measurement

4.2.1. Limit

For frequency hopping systems operating in the 2400-2483.5 MHz band employing at least 75 non-overlapping hopping channels, the limit for peak output power is 1Watt (30dBm). For all other frequency hopping systems in the 2400-2483.5 MHz band: 0.125 watts (21dBm). The limited has to be reduced by the amount in dB that the gain of the antenna exceed 6dBi. In case of point-to-point operation, the limit has to be reduced by 1 dB for every 3dB that the directional gain of the antenna exceeds 6dBi.

4.2.2. Measuring Instruments and Setting

Please refer to section 5 of equipments list in this report. The following table is the setting of the power meter.

Power Meter Parameter	Setting
Filter No.	Auto
Measurement time	0.135 s ~ 26 s
Used Peak Sensor	MA2411B

4.2.3. Test Procedures

7. The transmitter output (antenna port) was connected to the power meter.
8. Turn on the EUT and power meter and then record the peak power value.
9. Repeat above procedures on all channels needed to be tested.

4.2.4. Test Setup Layout

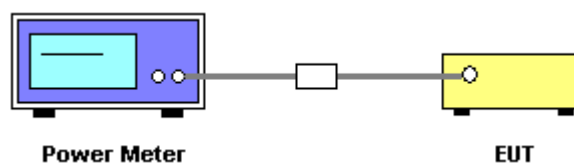

4.2.5. Test Deviation

There is no deviation with the original standard.

4.2.6. EUT Operation during Test

The EUT was programmed to be in continuously transmitting mode.

4.2.7. Test Result of Maximum Peak Output Power

Temperature	23°C	Humidity	63%
Test Engineer	Satoshi Yang	Configurations	GFSK
Test Date	Nov. 29, 2011		

Channel	Frequency	Conducted Power (dBm)	Max. Limit (dBm)	Result
0	2402 MHz	6.12	21.00	Complies
39	2441 MHz	6.35	21.00	Complies
78	2480 MHz	5.30	21.00	Complies

4.3. Hopping Channel Separation Measurement

4.3.1. Limit

Frequency hopping systems shall have hopping channel carrier frequencies separated by a minimum of 25 kHz or the 20 dB bandwidth of the hopping channel, whichever is greater. Alternatively, frequency hopping systems operating in the 2400-2483.5 MHz band may have hopping channel carrier frequencies that are separated by 25 kHz or two-thirds of the 20 dB bandwidth of the hopping channel, whichever is greater.

4.3.2. Measuring Instruments and Setting

Please refer to section 5 of equipments list in this report. The following table is the setting of spectrum analyzer.

Spectrum Parameter	Setting
Attenuation	Auto
Span Frequency	> Measurement Bandwidth or Channel Separation
RB	30 kHz (20dB Bandwidth) / 100 kHz (Channel Separation)
VB	100 kHz (20dB Bandwidth) / 300 kHz (Channel Separation)
Detector	Peak
Trace	Max Hold
Sweep Time	Auto

4.3.3. Test Procedures

1. The transmitter output (antenna port) was connected to the spectrum analyzer in peak hold mode.
2. The resolution bandwidth of 30 kHz and the video bandwidth of 100 kHz were utilized for 20 dB bandwidth measurement.
3. The resolution bandwidth of 100 kHz and the video bandwidth of 300 kHz were utilized for channel separation measurement.

4.3.4. Test Setup Layout

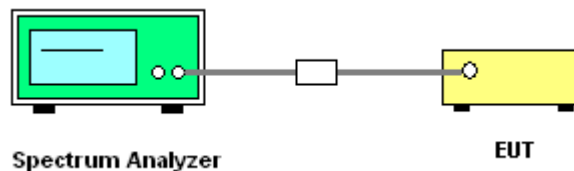

4.3.5. Test Deviation

There is no deviation with the original standard.

4.3.6. EUT Operation during Test

The EUT was programmed to be in continuously transmitting mode.

4.3.7. Test Result of Hopping Channel Separation

Temperature	23°C	Humidity	63%
Test Engineer	Satoshi Yang	Configurations	GFSK

Frequency	Ch. Separation (MHz)	20dB Bandwidth (MHz)	2/3 of 20dB Bandwidth (MHz)	99% Occupied Bandwidth (MHz)	Result
2402 MHz	1.00	1.2520	0.834666667	1.1400	Complies
2441 MHz	1.00	1.2600	0.84	1.1520	Complies
2480 MHz	1.00	1.2600	0.84	1.1480	Complies

Ch. Separation Limits: >20dB bandwidth or >2/3 of 20dB bandwidth

20 dB Bandwidth Plot on Channel 0 / 2402 MHz

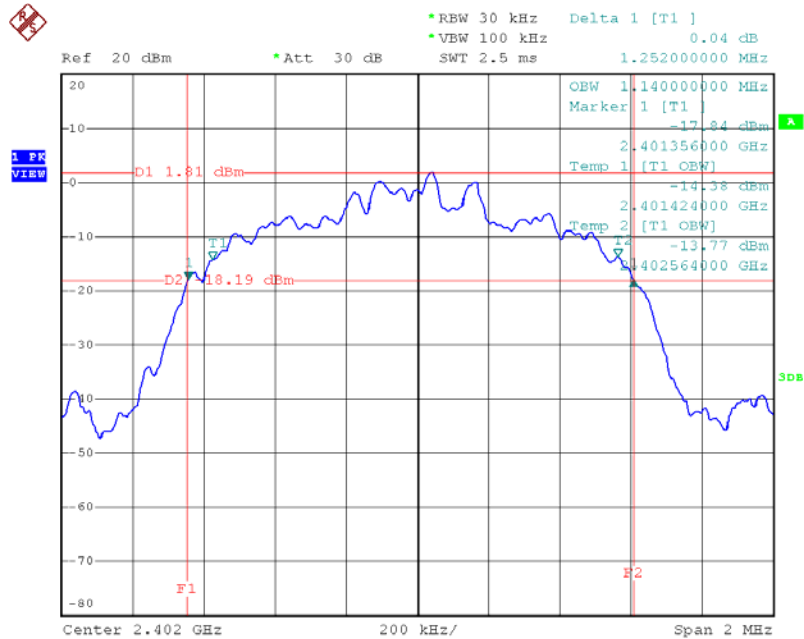

Date: 2.DEC.2011 12:56:37

20 dB Bandwidth Plot on Channel 39 / 2441 MHz

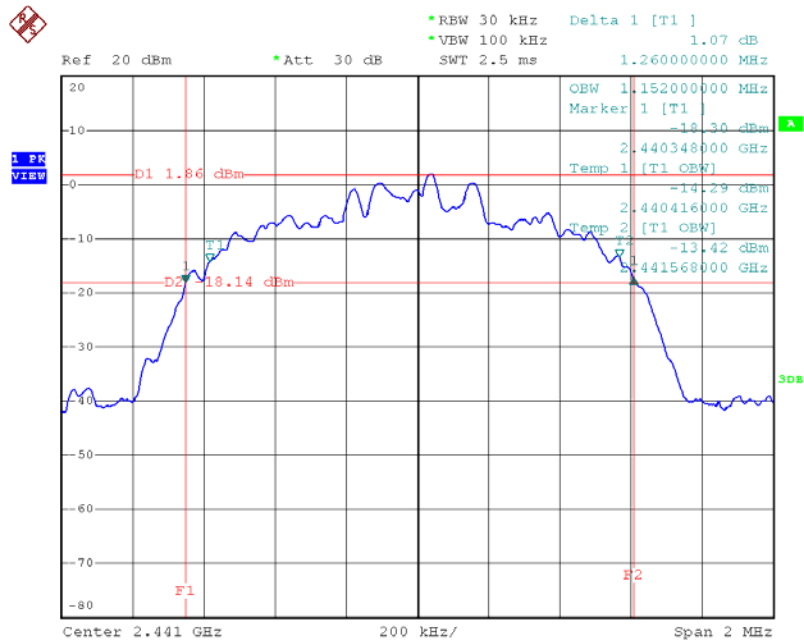

Date: 2.DEC.2011 13:02:27

20 dB Bandwidth Plot on Channel 78 / 2480 MHz

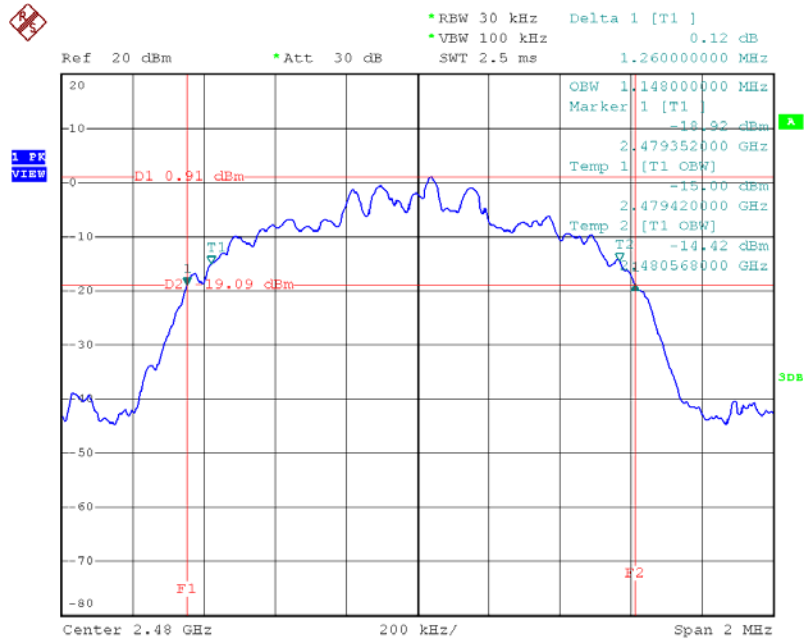

Date: 2.DEC.2011 13:05:05

Channel Separation Plot on Channel 0~1 / 2402 MHz ~ 2403 MHz

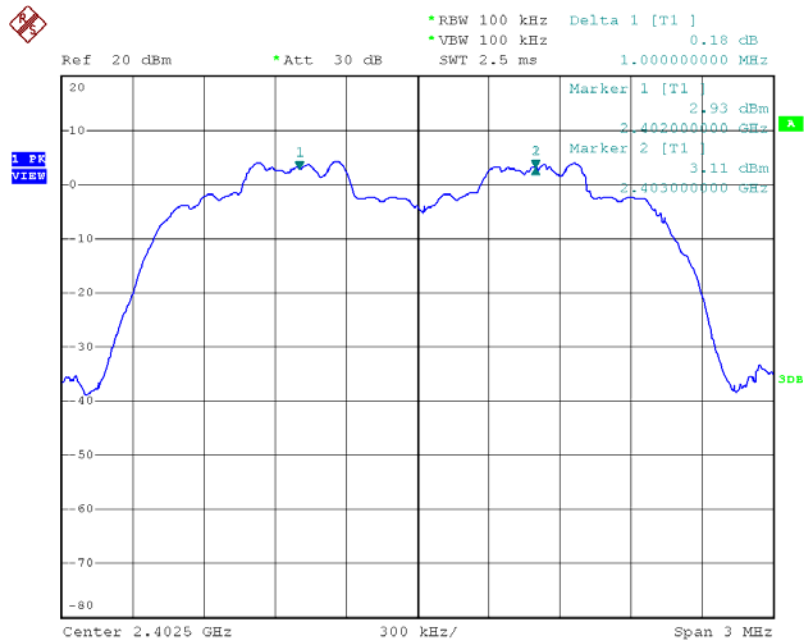

Date: 2.DEC.2011 12:53:20

Channel Separation Plot on Channel 39~40 / 2441 MHz ~ 2442 MHz

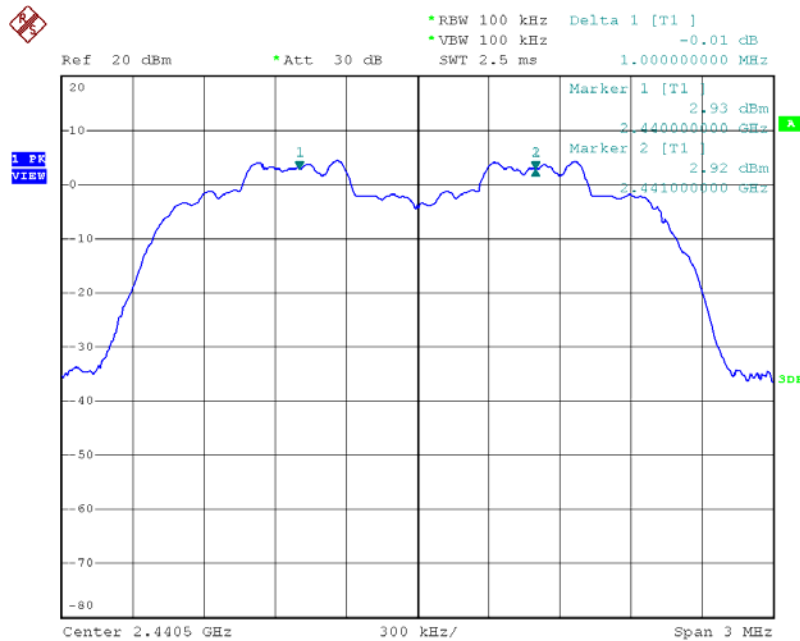

Date: 2.DEC.2011 12:51:00

Channel Separation Plot on Channel 77~78 / 2479 MHz ~ 2480 MHz

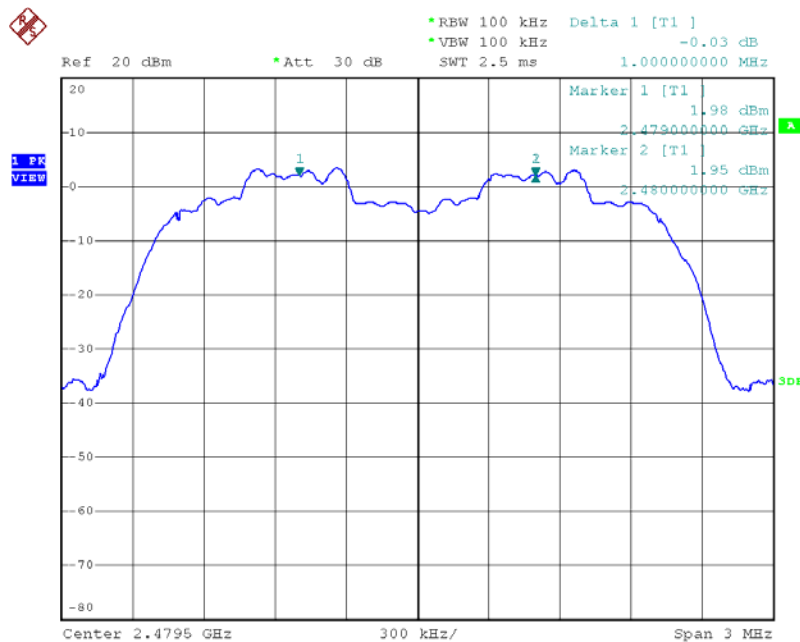

Date: 2.DEC.2011 12:47:27

4.4. Number of Hopping Frequency Measurement

4.4.1. Limit

At least 15 hopping frequencies, and should be equally spaced.

4.4.2. Measuring Instruments and Setting

Please refer to section 5 of equipments list in this report. The following table is the setting of spectrum analyzer.

Spectrum Parameters	Setting
Attenuation	Auto
Span Frequency	> Operating Frequency Range
RB	100 kHz
VB	100 kHz
Detector	Peak
Trace	Max Hold
Sweep Time	Auto

4.4.3. Test Procedures

1. The transmitter output (antenna port) was connected to the spectrum analyzer in peak hold mode.
2. The resolution bandwidth of 100 kHz and the video bandwidth of 100 kHz were utilized.
3. Observe frequency hopping in 2400MHz~2483.5MHz, there are at least 75 non-overlapping channels.

4.4.4. Test Setup Layout

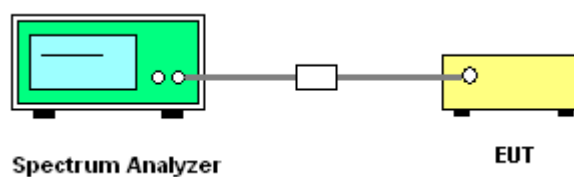

4.4.5. Test Deviation

There is no deviation with the original standard.

4.4.6. EUT Operation during Test

The EUT was programmed to be in continuously transmitting mode.

4.4.7. Test Result of Number of Hopping Frequency

Temperature	23°C	Humidity	63%
Test Engineer	Satoshi Yang	Configurations	GFSK

Modulation Type	Channel No.	Frequency (MHz)	Hopping Ch. (Channels)	Min. Limit (Channels)	Test Result
GFSK	0 ~ 78	2402 ~ 2480	79	75	Complies

Number of Hopping Channel Plot on Channel 0~78 / 2402 MHz ~ 2480 MHz

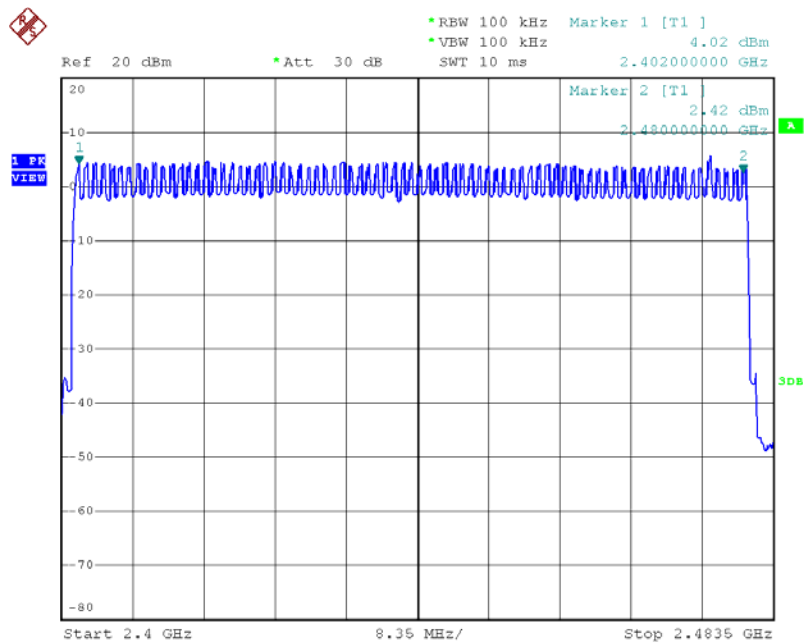

Date: 2.DEC.2011 14:13:49

4.5. Dwell Time Measurement

4.5.1. Limit

Frequency hopping systems in the 2400-2483.5 MHz band shall use at least 15 channels. The average time of occupancy on any channel shall not be greater than 0.4 seconds within a period of 0.4 seconds multiplied by the number of hopping channels employed.

4.5.2. Measuring Instruments and Setting

Please refer to section 5 of equipments list in this report. The following table is the setting of spectrum analyzer.

Spectrum Parameter	Setting
Attenuation	Auto
Span Frequency	0 MHz
RB	1000 kHz
VB	1000 kHz
Detector	Peak
Trace	Single Trigger

4.5.3. Test Procedures

1. The transmitter output (antenna port) was connected to the spectrum analyzer
2. Set RBW of spectrum analyzer to 1000kHz and VBW to 1000kHz.
3. Use a video trigger with the trigger level set to enable triggering only on full pulses.
4. Sweep Time is more than once pulse time.
5. Set the center frequency on any frequency would be measure and set the frequency span to zero span.
6. Measure the maximum time duration of one single pulse.
7. Set the EUT for 3DH5, 3DH3 and 3DH1 packet transmitting.
8. Measure the maximum time duration of one single pulse.

4.5.4. Test Setup Layout

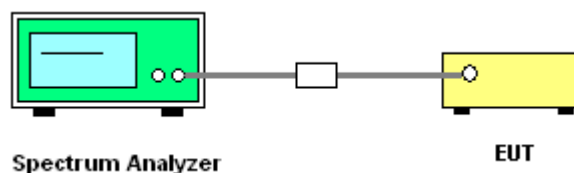

4.5.5. Test Deviation

There is no deviation with the original standard.

4.5.6. EUT Operation during Test

The EUT was programmed to be in continuously transmitting mode.

4.5.7. Test Result of Dwell Time

Temperature	23°C	Humidity	63%
Test Engineer	Satoshi Yang	Configurations	Bluetooth / 3DH1, 3DH3, 3DH5

Data Packet	Frequency (MHz)	Pulse Duration (ms)	Dwell Time in (s)	Limits (s)	Test Result
3DH5	2402 MHz	2.9000	0.3093	0.4000	Complies
3DH3	2402 MHz	1.6400	0.2624	0.4000	Complies
3DH1	2402 MHz	0.3900	0.1248	0.4000	Complies
3DH5	2441 MHz	2.9000	0.3093	0.4000	Complies
3DH3	2441 MHz	1.6400	0.2624	0.4000	Complies
3DH1	2441 MHz	0.3900	0.1248	0.4000	Complies
3DH5	2480 MHz	0.4300	0.0459	0.4000	Complies
3DH3	2480 MHz	1.6400	0.2624	0.4000	Complies
3DH1	2480 MHz	0.3900	0.1248	0.4000	Complies

Remark:

Dwell Time = 79(channels) x 0.4(s) x average hopping channel x package transfer time (us)

79 channels come from the Hopping Channel number.

Average Hopping Channel = hops / sweep time

Dwell Time Plot on Channel 0 / 3DH5 / 2402 MHz

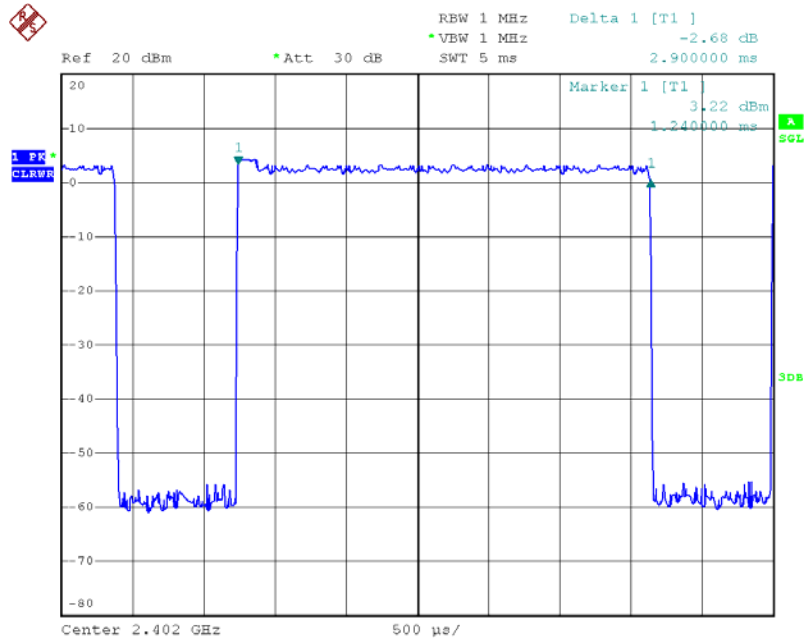

Date: 2.DEC.2011 12:18:57

Dwell Time Plot on Channel 0 / 3DH3 / 2402 MHz

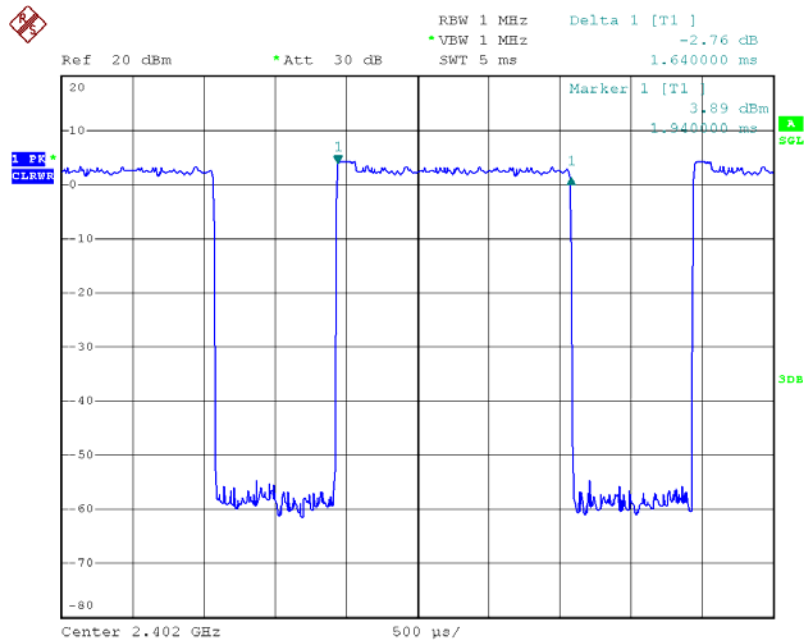

Date: 2.DEC.2011 12:32:21

Dwell Time Plot on Channel 0 / 3DH1 / 2402 MHz

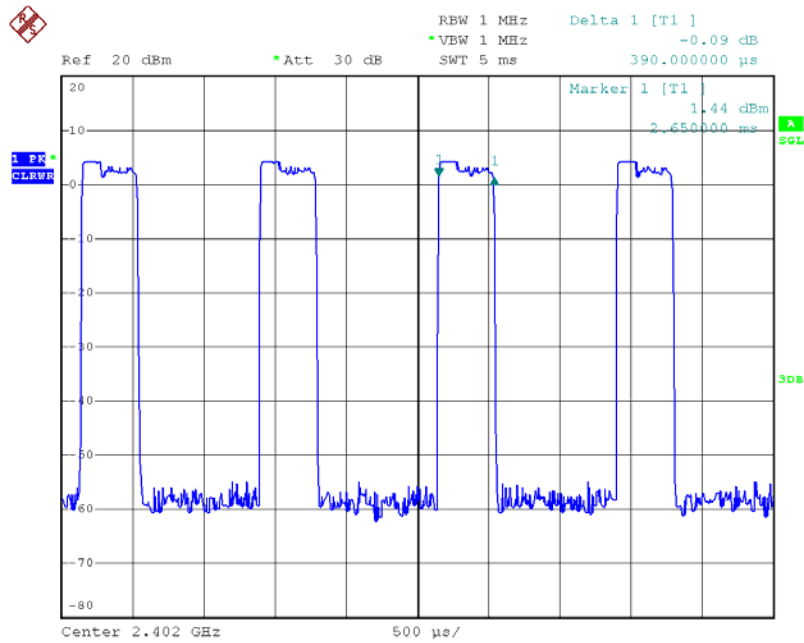

Date: 2.DEC.2011 12:33:39

Dwell Time Plot on Channel 39 / 3DH5 / 2441 MHz

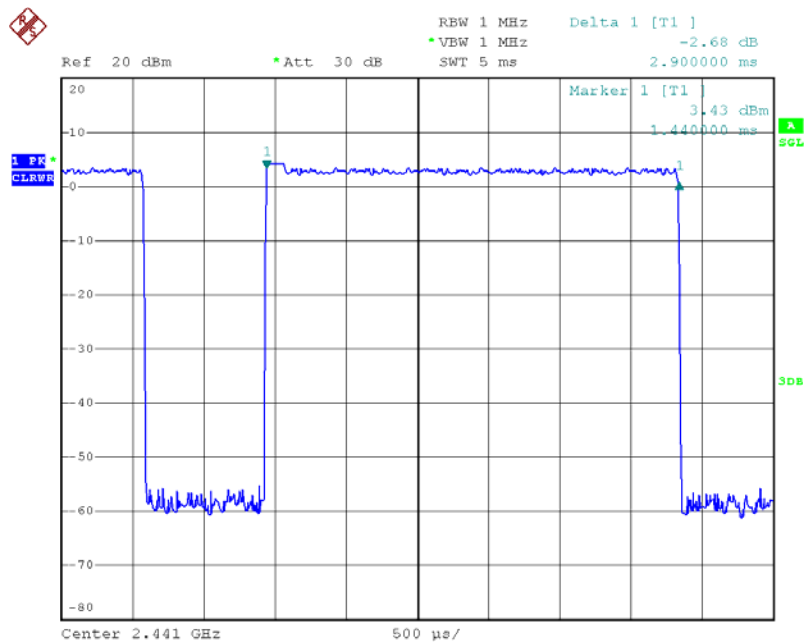

Date: 2.DEC.2011 12:21:58

Dwell Time Plot on Channel 39 / 3DH3 / 2441 MHz

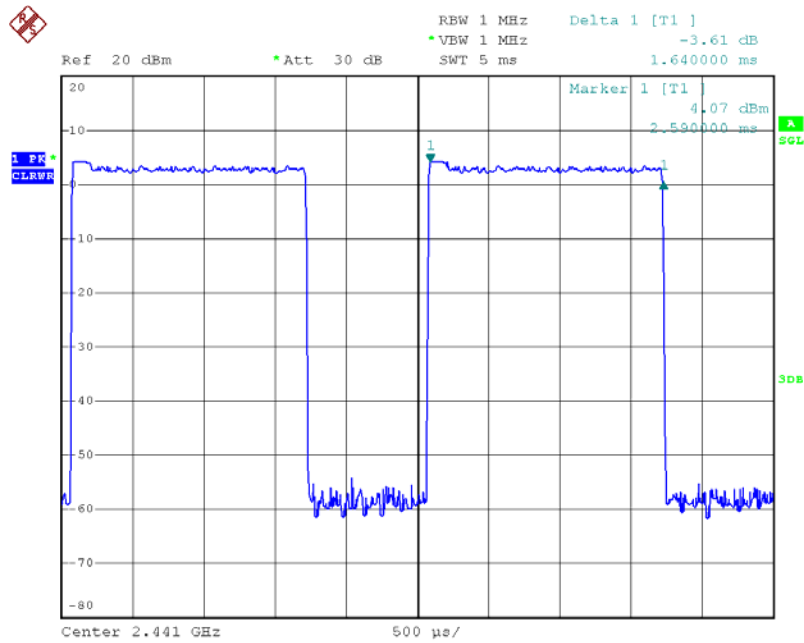

Date: 2.DEC.2011 12:25:25

Dwell Time Plot on Channel 39 / 3DH1 / 2441 MHz

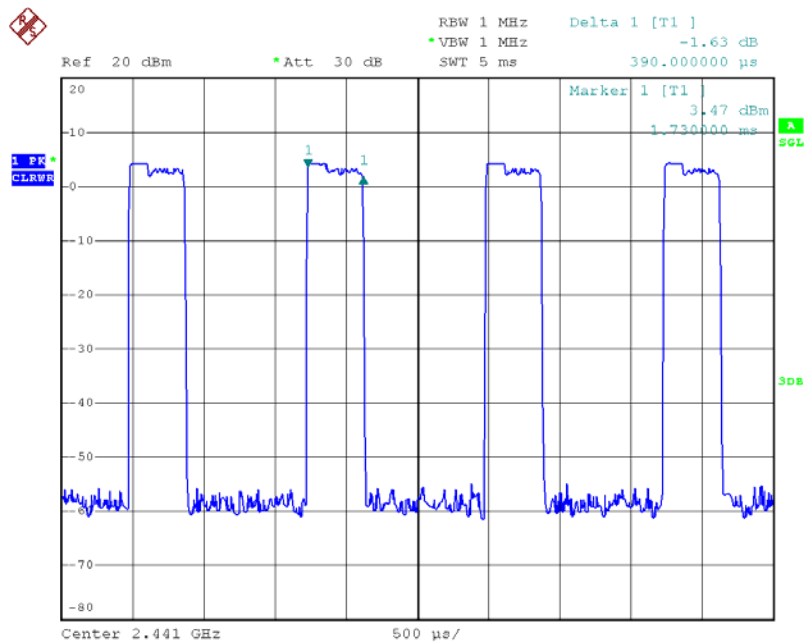

Date: 2.DEC.2011 12:34:51

Dwell Time Plot on Channel 78 / 3DH5 / 2480 MHz

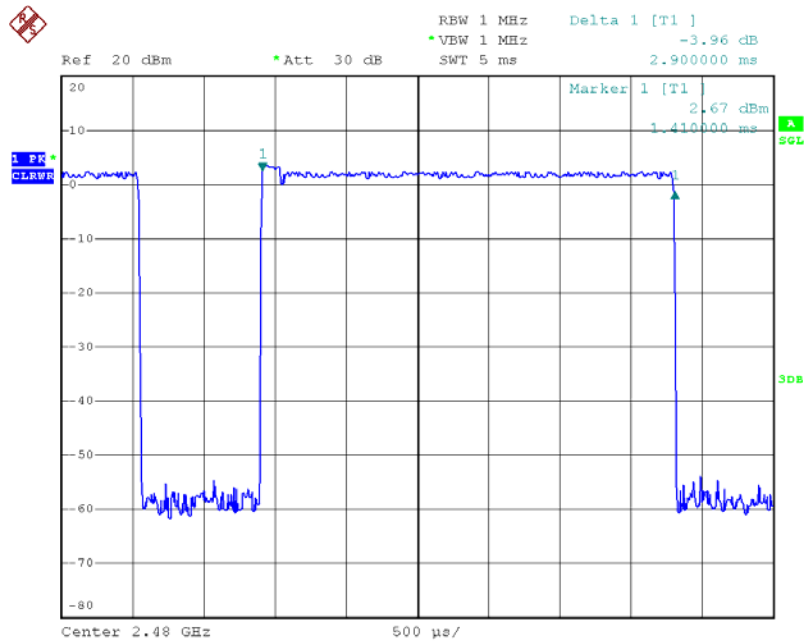

Date: 2.DEC.2011 12:23:14

Dwell Time Plot on Channel 78 / 3DH3 / 2480 MHz

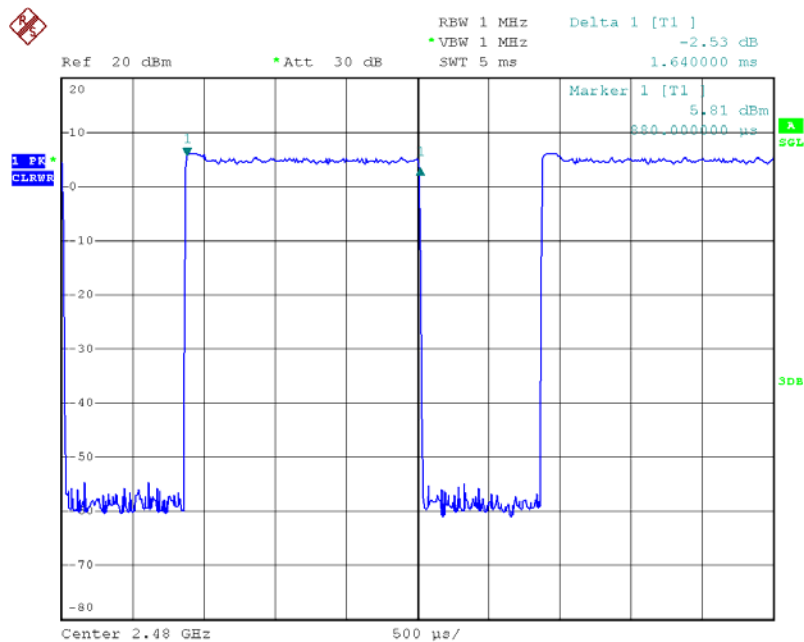

Date: 2.DEC.2011 12:24:15

Dwell Time Plot on Channel 78 / 3DH1 / 2480 MHz

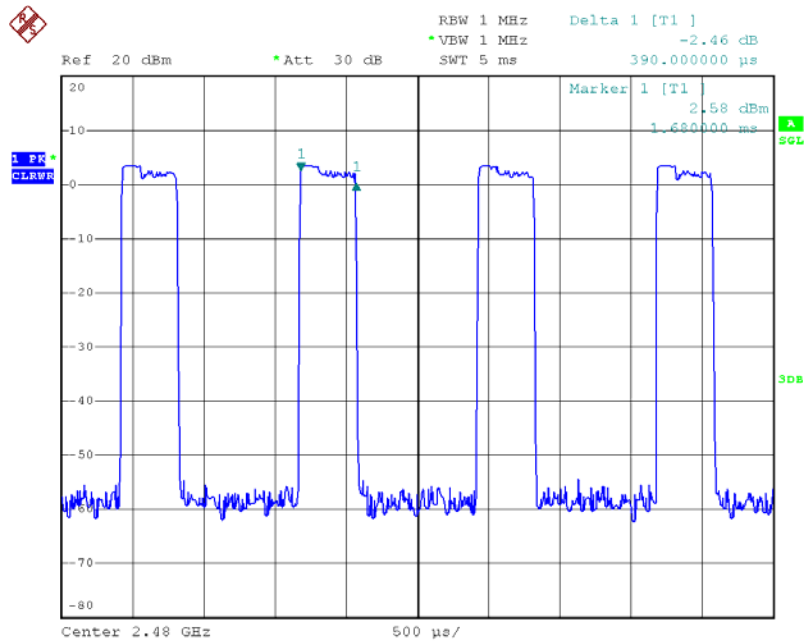

Date: 2.DEC.2011 12:39:40

4.6. Radiated Emissions Measurement

4.6.1. Limit

20dBc in any 100 kHz bandwidth outside the operating frequency band. In case the emission fall within the restricted band specified on 15.205(a), then the 15.209(a) limit in the table below has to be followed.

Frequencies (MHz)	Field Strength (micorvolts/meter)	Measurement Distance (meters)
0.009~0.490	2400/F(KHz)	300
0.490~1.705	24000/F(KHz)	30
1.705~30.0	30	30
30~88	100	3
88~216	150	3
216~960	200	3
Above 960	500	3

4.6.2. Measuring Instruments and Setting

Please refer to section 5 of equipments list in this report. The following table is the setting of spectrum analyzer and receiver.

Spectrum Parameter	Setting
Attenuation	Auto
Start Frequency	1000 MHz
Stop Frequency	10th carrier harmonic
RB / VB (Emission in restricted band)	1MHz / 1MHz for Peak, 1 MHz / 10Hz for Average
RB / VB (Emission in non-restricted band)	1000KHz / 1000KHz for peak

Receiver Parameter	Setting
Attenuation	Auto
Start ~ Stop Frequency	9kHz~150kHz / RB 200Hz for QP
Start ~ Stop Frequency	150kHz~30MHz / RB 9kHz for QP
Start ~ Stop Frequency	30MHz~1000MHz / RB 120kHz for QP

4.6.3. Test Procedures

1. Configure the EUT according to ANSI C63.10. The EUT was placed on the top of the turntable 0.8 meter above ground. The phase center of the receiving antenna mounted on the top of a height-variable antenna tower was placed 3 meters far away from the turntable.
2. Power on the EUT and all the supporting units. The turntable was rotated by 360 degrees to determine the position of the highest radiation.
3. The height of the broadband receiving antenna was varied between one meter and four meters above ground to find the maximum emissions field strength of both horizontal and vertical polarization.
4. For each suspected emissions, the antenna tower was scan (from 1 M to 4 M) and then the turntable was rotated (from 0 degree to 360 degrees) to find the maximum reading.
5. Set the test-receiver system to Peak or CISPR quasi-peak Detect Function with specified bandwidth under Maximum Hold Mode.
6. For emissions above 1GHz, use 1MHz VBW and RBW for peak reading. Then 1MHz RBW and 10Hz VBW for average reading in spectrum analyzer.
7. When the radiated emissions limits are expressed in terms of the average value of the emissions, and pulsed operation is employed, the measurement field strength shall be determined by averaging over one complete pulse train, including blanking intervals, as long as the pulse train does not exceed 0.1 seconds. As an alternative (provided the transmitter operates for longer than 0.1 seconds) or in cases where the pulse train exceeds 0.1 seconds, the measured field strength shall be determined from the average absolute voltage during a 0.1 second interval during which the field strength is at its maximum value.
8. If the emissions level of the EUT in peak mode was 3 dB lower than the average limit specified, then testing will be stopped and peak values of EUT will be reported, otherwise, the emissions which do not have 3 dB margin will be repeated one by one using the quasi-peak method for below 1GHz.
9. For testing above 1GHz, the emissions level of the EUT in peak mode was lower than average limit (that means the emissions level in peak mode also complies with the limit in average mode), then testing will be stopped and peak values of EUT will be reported, otherwise, the emissions will be measured in average mode again and reported.
10. In case the emission is lower than 30MHz, loop antenna has to be used for measurement and the recorded data should be QP measured by receiver. High – Low scan is not required in this case.

4.6.4. Test Setup Layout

For radiated emissions below 1GHz

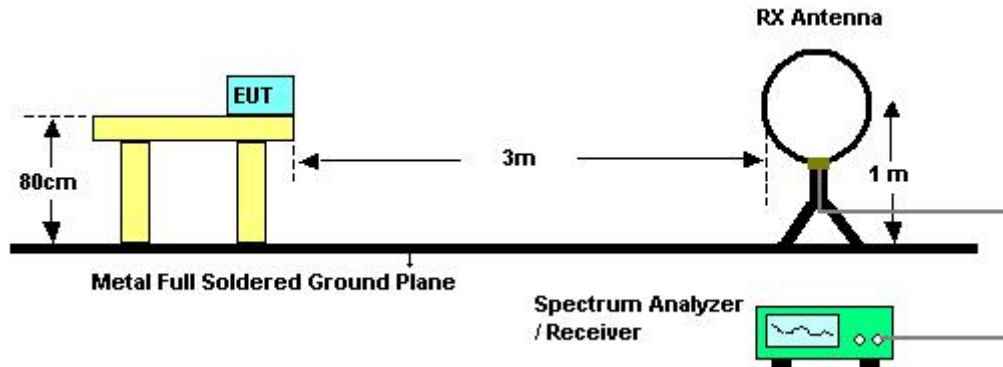

For radiated emissions above 1GHz

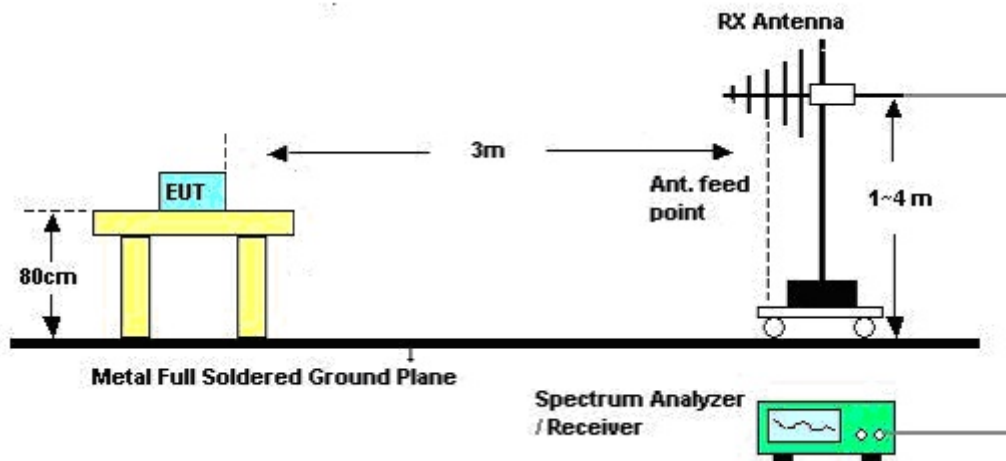

4.6.5. Test Deviation

There is no deviation with the original standard.

4.6.6. EUT Operation during Test

The EUT was programmed to be in continuously transmitting mode.

4.6.7. Results of Radiated Emissions (9kHz~30MHz)

Temperature	21°C	Humidity	60%
Test Engineer	Rion Li	Test Date	Dec. 01, 2011
Configurations	Normal Link		

Freq. (MHz)	Level (dBuV)	Over Limit (dB)	Limit Line (dBuV)	Remark
-	-	-	-	See Note

Note:

The amplitude of spurious emissions which are attenuated by more than 20dB below the permissible value has no need to be reported.

Distance extrapolation factor = $40 \log(\text{specific distance} / \text{test distance})$ (dB);

Limit line = specific limits (dBuV) + distance extrapolation factor.

4.6.8. Results of Radiated Emissions (30MHz~1GHz)

Temperature	21°C	Humidity	60%
Test Engineer	Rion Li	Configurations	Normal Link

Horizontal

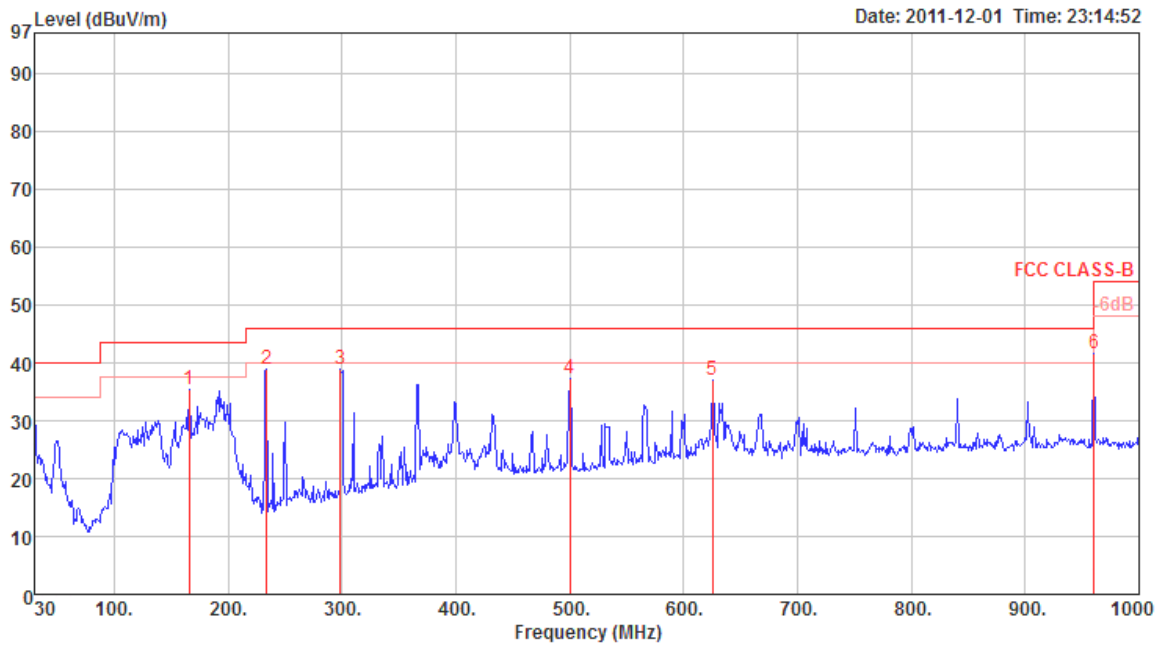

	Freq	Level	Limit Line	Over Limit	Read Level	Cable Loss	Preamp Factor	Antenna Factor	T/Pos	A/Pos	Remark	Pol/Phase	Aux Factor
	MHz	dBuV/m	dBuV/m	dB	dBuV	dB	dB	dB/m	deg	cm			dB
1	165.80	35.48	43.50	-8.02	51.03	1.92	27.27	9.80	0	400	Peak	HORIZONTAL	0.00
2	233.70	38.85	46.00	-7.15	52.90	2.29	27.03	10.69	0	400	Peak	HORIZONTAL	0.00
3	298.69	38.92	46.00	-7.08	49.77	2.51	26.90	13.54	0	400	Peak	HORIZONTAL	0.00
4	500.45	37.32	46.00	-8.68	43.94	3.38	28.10	18.10	0	400	Peak	HORIZONTAL	0.00
5	625.58	36.92	46.00	-9.08	41.53	3.82	28.07	19.64	0	400	Peak	HORIZONTAL	0.00
6	960.23	41.49	54.00	-12.51	42.53	4.86	27.16	21.26	0	400	Peak	HORIZONTAL	0.00

Vertical

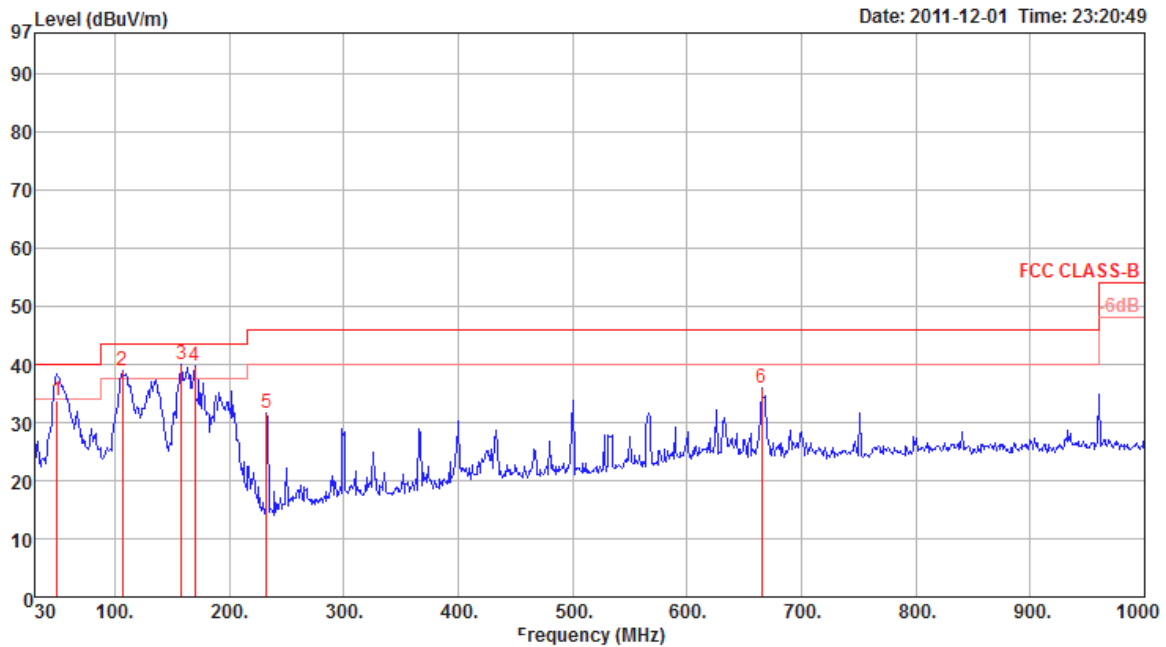

	Freq	Level	Limit	Over	Read	Cable	Preamp	Antenna	T/Pos	A/Pos	Remark	Pol/Phase	Aux
	MHz	dBuV/m	dBuV/m	dB	dBuV	dB	dB	dB/m	deg	cm			dB
1	q	49.40	33.68	40.00	-6.32	52.40	1.05	27.80	8.03	334	100 QP	VERTICAL	0.00
2	!	106.63	38.78	43.50	-4.72	52.73	1.55	27.57	12.07	0	100 Peak	VERTICAL	0.00
3	p	158.04	39.93	43.50	-3.57	55.32	1.86	27.31	10.06	0	100 Peak	VERTICAL	0.00
4	!	169.68	39.69	43.50	-3.81	55.27	1.94	27.25	9.73	0	100 Peak	VERTICAL	0.00
5		232.73	31.71	46.00	-14.29	45.76	2.29	27.03	10.69	0	100 Peak	VERTICAL	0.00
6		665.35	35.83	46.00	-10.17	40.43	3.98	28.03	19.45	0	100 Peak	VERTICAL	0.00

Note:

The amplitude of spurious emissions which are attenuated by more than 20 dB below the permissible value has no need to be reported.

Emission level (dBuV/m) = 20 log Emission level (uV/m).

Corrected Reading: Antenna Factor + Cable Loss + Read Level - Preamp Factor = Level.

4.6.9. Results for Radiated Emissions (1GHz~10th Harmonic)

Temperature	21°C	Humidity	60%
Test Engineer	Rion Li	Configurations	Channel 0
Test Date	Dec. 01, 2011		

Horizontal

	Freq	Level	Limit Line	Over Limit	Read Level	CableAntenna Loss	Antenna Factor	Preamp Factor	Remark	A/Pos	T/Pos	Pol/Phase
	MHz	dBuV/m	dBuV/m	dB	dBuV	dB	dB/m	dB		cm	deg	
1	4803.89	31.88	54.00	-22.12	27.51	6.21	33.36	35.20	Average	100	207	HORIZONTAL
2	4803.97	45.27	74.00	-28.73	40.90	6.21	33.36	35.20	Peak	100	207	HORIZONTAL

Vertical

	Freq	Level	Limit Line	Over Limit	Read Level	CableAntenna Loss	Antenna Factor	Preamp Factor	Remark	A/Pos	T/Pos	Pol/Phase
	MHz	dBuV/m	dBuV/m	dB	dBuV	dB	dB/m	dB		cm	deg	
1	4803.83	50.71	74.00	-23.29	46.34	6.21	33.36	35.20	Peak	155	108	VERTICAL
2	4803.99	43.59	54.00	-10.41	39.22	6.21	33.36	35.20	Average	155	108	VERTICAL

Temperature	21°C	Humidity	60%
Test Engineer	Rion Li	Configurations	Channel 39
Test Date	Dec. 01, 2011		

Horizontal

	Freq	Level	Limit Line	Over Limit	Read Level	CableAntenna Loss	Antenna Factor	Preamp Factor	Remark	A/Pos	T/Pos	Pol/Phase
	MHz	dBuV/m	dBuV/m	dB	dBuV	dB	dB/m	dB		cm	deg	
1	4881.96	45.58	74.00	-28.42	41.01	6.29	33.48	35.20	Peak	100	301	HORIZONTAL
2	4882.11	31.98	54.00	-22.02	27.41	6.29	33.48	35.20	Average	100	301	HORIZONTAL

Vertical

	Freq	Level	Limit Line	Over Limit	Read Level	CableAntenna Loss	Antenna Factor	Preamp Factor	Remark	A/Pos	T/Pos	Pol/Phase
	MHz	dBuV/m	dBuV/m	dB	dBuV	dB	dB/m	dB		cm	deg	
1	4882.01	34.06	54.00	-19.94	29.49	6.29	33.48	35.20	Average	140	105	VERTICAL
2	4882.43	47.63	74.00	-26.37	43.06	6.29	33.48	35.20	Peak	140	105	VERTICAL

Temperature	21°C	Humidity	60%
Test Engineer	Rion Li	Configurations	Channel 78
Test Date	Dec. 01, 2011		

Horizontal

	Freq	Level	Limit Line	Over Limit	Read Level	Cable Loss	Antenna Factor	Preamp Factor	Remark	A/Pos	T/Pos	Pol/Phase
	MHz	dBuV/m	dBuV/m	dB	dBuV	dB	dB/m	dB		cm	deg	
1	4959.83	31.63	54.00	-22.37	26.82	6.37	33.64	35.20	Average	100	40	HORIZONTAL
2	4959.99	45.47	74.00	-28.53	40.66	6.37	33.64	35.20	Peak	100	40	HORIZONTAL

Vertical

	Freq	Level	Limit Line	Over Limit	Read Level	Cable Loss	Antenna Factor	Preamp Factor	Remark	A/Pos	T/Pos	Pol/Phase
	MHz	dBuV/m	dBuV/m	dB	dBuV	dB	dB/m	dB		cm	deg	
1	4959.97	33.15	54.00	-20.85	28.34	6.37	33.64	35.20	Average	109	155	VERTICAL
2	4960.15	46.45	74.00	-27.55	41.64	6.37	33.64	35.20	Peak	109	155	VERTICAL

Note:

The amplitude of spurious emissions which are attenuated by more than 20dB below the permissible value has no need to be reported.

Emission level (dBuV/m) = 20 log Emission level (uV/m).

Corrected Reading: Antenna Factor + Cable Loss + Read Level - Preamp Factor = Level.

4.7. Band Edge Emissions Measurement

4.7.1. Limit

20dBc in any 100 kHz bandwidth outside the operating frequency band. In case the emission fall within the restricted band specified on 15.205(a), then the 15.209(a) limit in the table below has to be followed.

Frequencies (MHz)	Field Strength (micovolts/meter)	Measurement Distance (meters)
0.009~0.490	2400/F(KHz)	300
0.490~1.705	24000/F(KHz)	30
1.705~30.0	30	30
30~88	100	3
88~216	150	3
216~960	200	3
Above 960	500	3

4.7.2. Measuring Instruments and Setting

Please refer to section 5 of equipments list in this report. The following table is the setting of the spectrum analyzer.

Spectrum Parameter	Setting
Attenuation	Auto
Span Frequency	100 MHz
RB / VB (Emission in restricted band)	1MHz / 1MHz for Peak, 1 MHz / 10Hz for Average
RB / VB (Emission in non-restricted band)	100 KHz /100 KHz for Peak

4.7.3. Test Procedures

1. The test procedure is the same as section 4.5.3, only the frequency range investigated is limited to 100MHz around bandedges.
2. In case the emission is fail due to the used RB/VB is too wide, marker-delta method of FCC Public Notice DA00-705 will be followed.

4.7.4. Test Setup Layout

This test setup layout is the same as that shown in section 4.6.4.

4.7.5. Test Deviation

There is no deviation with the original standard.

4.7.6. EUT Operation during Test

The EUT was programmed to be in continuously transmitting mode.

4.7.7. Test Result of Band Edge and Fundamental Emissions

Temperature	21°C	Humidity	60%
Test Engineer	Rion Li	Configurations	Channel 0, 39, 78
Test Date	Dec. 01, 2011		

Channel 0

	Freq	Level	Limit Line	Over Limit	Read Level	CableAntenna Loss	Antenna Factor	Preamp Factor	Remark	A/Pos	T/Pos	Pol/Phase
	MHz	dBuV/m	dBuV/m	dB	dBuV	dB	dB/m	dB		cm	deg	
1	2322.00	46.92	54.00	-7.08	14.96	4.07	27.89	0.00	Average	100	80	VERTICAL
2	2322.00	56.94	74.00	-17.06	24.98	4.07	27.89	0.00	Peak	100	80	VERTICAL
3	2402.00	108.46				4.14	28.09	0.00	Average	100	80	VERTICAL
4	2402.00	109.40				4.14	28.09	0.00	Peak	100	80	VERTICAL

Item 3, 4 are the fundamental frequency at 2402 MHz.

Channel 39

	Freq	Level	Limit Line	Over Limit	Read Level	CableAntenna Loss	Antenna Factor	Preamp Factor	Remark	A/Pos	T/Pos	Pol/Phase
	MHz	dBuV/m	dBuV/m	dB	dBuV	dB	dB/m	dB		cm	deg	
1	2360.80	57.69	74.00	-16.31	25.63	4.09	27.97	0.00	Peak	100	80	VERTICAL
2	2361.00	50.16	54.00	-3.84	18.10	4.09	27.97	0.00	Average	100	80	VERTICAL
3	2441.00	107.90				4.18	28.18	0.00	Average	100	80	VERTICAL
4	2441.00	108.81				4.18	28.18	0.00	Peak	100	80	VERTICAL
5	2483.50	44.34	54.00	-9.66	11.87	4.21	28.26	0.00	Average	100	80	VERTICAL
6	2487.10	55.81	74.00	-18.19	23.30	4.21	28.30	0.00	Peak	100	80	VERTICAL

Item 3, 4 are the fundamental frequency at 2441 MHz.

Channel 78

	Freq	Level	Limit Line	Over Limit	Read Level	CableAntenna Loss	Antenna Factor	Preamp Factor	Remark	A/Pos	T/Pos	Pol/Phase
	MHz	dBuV/m	dBuV/m	dB	dBuV	dB	dB/m	dB		cm	deg	
1	2480.00	107.02				4.21	28.26	0.00	Average	100	80	VERTICAL
2	2480.20	107.93				4.21	28.26	0.00	Peak	100	80	VERTICAL
3	2483.50	53.50	54.00	-0.50	21.03	4.21	28.26	0.00	Average	100	80	VERTICAL
4	2483.70	62.50	74.00	-11.50	30.03	4.21	28.26	0.00	Peak	100	80	VERTICAL

Item 1, 2 are the fundamental frequency at 2480 MHz.

Note:

Emission level (dBuV/m) = 20 log Emission level (uV/m).

Corrected Reading: Antenna Factor + Cable Loss + Read Level - Preamp Factor = Level.

Low Band Edge Plot on Channel 0 / 2402 MHz

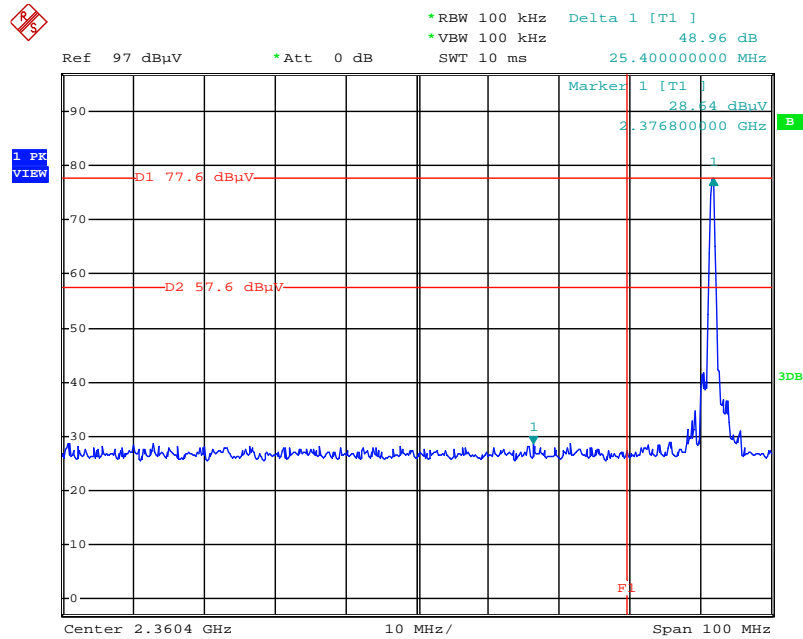

Date: 28.NOV.2011 22:05:55

High Band Edge Plot on Channel 78 / 2480 MHz

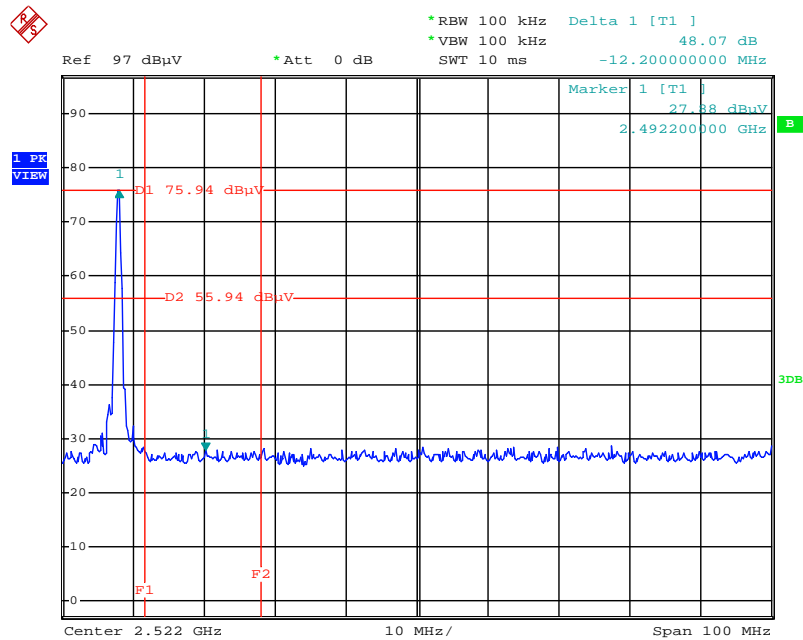

Date: 28.NOV.2011 22:00:01

4.8. Antenna Requirements

4.8.1. Limit

Except for special regulations, the Low-power Radio-frequency Devices must not be equipped with any jacket for installing an antenna with extension cable. An intentional radiator shall be designed to ensure that no antenna other than that furnished by the responsible party shall be used with the device. The use of a permanently attached antenna or of an antenna that uses a unique coupling to the intentional radiator shall be considered sufficient to comply with the provisions of this Section. The manufacturer may design the unit so that the user can replace a broken antenna, but the use of a standard antenna jack or electrical connector is prohibited. Further, this requirement does not apply to intentional radiators that must be professionally installed.

4.8.2. Antenna Connector Construction

Please refer to section 3.3 in this test report, antenna connector complied with the requirements.

5. LIST OF MEASURING EQUIPMENTS

Instrument	Manufacturer	Model No.	Serial No.	Characteristics	Calibration Date	Remark
EMI Test Receiver	R&S	ESCS 30	100377	9kHz ~ 2.75GHz	Sep. 14, 2011	Conduction (CO01-CB)
LISN	F.C.C.	FCC-LISN-50-16-2	04083	150kHz ~ 100MHz	Oct. 28, 2011	Conduction (CO01-CB)
V- LISN	Schwarzbeck	NSLK 8127	8127-478	9K ~ 30MHz	Nov. 30, 2011	Conduction (CO01-CB)
PULSE LIMITER	R&S	ESH3-Z2	100430	9K~30MHz	Jan. 04, 2011	Conduction (CO01-CB)
COND Cable	-	Cable	-	0.15MHz~30MHz	Dec. 4, 2011	Conduction (CO01-CB)
BILOG ANTENNA	Schaffner	CBL6112D	22021	20MHz ~ 2GHz	Oct. 29, 2011	Radiation (03CH01-CB)
Horn Antenna	EMCO	3115	00075790	750MHz~18GHz	Nov. 22, 2011	Radiation (03CH01-CB)
Pre-Amplifier	Agilent	8447D	2944A10991	0.1MHz ~ 1.3GHz	Nov. 17, 2011	Radiation (03CH01-CB)
Pre-Amplifier	Agilent	8449B	3008A02310	1GHz ~ 26.5GHz	Nov. 23, 2011	Radiation (03CH01-CB)
Spectrum analyzer	R&S	FSP40	100056	9KHz~40GHz	Nov. 03, 2011	Radiation (03CH01-CB)
EMI Test Receiver	R&S	ESCS 30	100355	9KHz ~ 2.75GHz	Mar. 22, 2011	Radiation (03CH01-CB)
Loop Antenna	Teseq	HLA 6120	24155	9 kHz - 30 MHz	Sep. 09, 2010*	Radiation (03CH01-CB)
Turn Table	INN CO	CO 2000	N/A	0 ~ 360 degree	N/A	Radiation (03CH01-CB)
Antenna Mast	INN CO	CO2000	N/A	1 m - 4 m	N/A	Radiation (03CH01-CB)
RF Cable-low	Woken	Low Cable-1	N/A	30 MHz - 1 GHz	Nov. 17, 2011	Radiation (03CH01-CB)
RF Cable-high	Woken	High Cable-1	N/A	1 GHz – 26.5 GHz	Nov. 17, 2011	Radiation (03CH01-CB)
RF Cable-high	Woken	High Cable-2	N/A	1 GHz – 26.5 GHz	Nov. 17, 2011	Radiation (03CH01-CB)
RF Cable-high	Woken	High Cable-3	N/A	1 GHz - 40 GHz	Nov. 17, 2011	Radiation (03CH01-CB)
RF Cable-high	Woken	High Cable-4	N/A	1 GHz - 40 GHz	Nov. 17, 2011	Radiation (03CH01-CB)
Signal analyzer	R&S	FSV40	100979	9KHz~40GHz	Sep. 26, 2011	Conducted (TH01-CB)
Thermo-Hygro Meter	N/A	HC 520	#1	15~70 degree	Nov. 02, 2011	Conducted (TH01-CB)
RF Power Divider	HP	11636A	00306	2GHz ~ 18GHz	N/A	Conducted (TH01-CB)
RF Power Splitter	Anaren	44100	1839	2GHz ~ 18GHz	N/A	Conducted (TH01-CB)
RF Power Splitter	Anaren	42100	17930	2GHz ~ 18GHz	N/A	Conducted (TH01-CB)
RF Cable-high	Woken	High Cable-7	-	1 GHz – 26.5 GHz	Nov. 17, 2011	Conducted (TH01-CB)
RF Cable-high	Woken	High Cable-8	-	1 GHz – 26.5 GHz	Nov. 17, 2011	Conducted (TH01-CB)

Instrument	Manufacturer	Model No.	Serial No.	Characteristics	Calibration Date	Remark
RF Cable-high	Woken	High Cable-9	-	1 GHz – 26.5 GHz	Nov. 17, 2011	Conducted (TH01-CB)
RF Cable-high	Woken	High Cable-10	-	1 GHz – 26.5 GHz	Nov. 17, 2011	Conducted (TH01-CB)
RF Cable-high	Woken	High Cable-11	-	1 GHz – 26.5 GHz	Nov. 17, 2011	Conducted (TH01-CB)
RF Cable-high	Woken	High Cable-12	-	1 GHz – 26.5 GHz	Nov. 17, 2011	Conducted (TH01-CB)
RF Cable-high	Woken	High Cable-13	-	1 GHz – 26.5 GHz	Nov. 17, 2011	Conducted (TH01-CB)
Power Sensor	Anritsu	MA2411B	0917223	300MHz~40GHz	Nov. 01, 2011	Conducted (TH01-CB)
Power Meter	Anritsu	ML2495A	1035008	300MHz~40GHz	Nov. 01, 2011	Conducted (TH01-CB)

Note: Calibration Interval of instruments listed above is one year.

Note: * Calibration Interval of instruments listed above is two years.

6. TEST LOCATION

SHIJR	ADD : 6Fl., No. 106, Sec. 1, Shintai 5th Rd., Shijr City, Taipei, Taiwan 221, R.O.C. TEL : 886-2-2696-2468 FAX : 886-2-2696-2255
HWA YA	ADD : No. 52, Hwa Ya 1st Rd., Kwei-Shan Hsiang, Tao Yuan Hsien, Taiwan, R.O.C. TEL : 886-3-327-3456 FAX : 886-3-318-0055
LINKOU	ADD : No. 30-2, Dingfu Tsuen, Linkou Shiang, Taipei, Taiwan 244, R.O.C TEL : 886-2-2601-1640 FAX : 886-2-2601-1695
DUNGHU	ADD : No. 3, Lane 238, Kangle St., Neihu Chiu, Taipei, Taiwan 114, R.O.C. TEL : 886-2-2631-4739 FAX : 886-2-2631-9740
JUNGHE	ADD : 7Fl., No. 758, Jungjeng Rd., Junghe City, Taipei, Taiwan 235, R.O.C. TEL : 886-2-8227-2020 FAX : 886-2-8227-2626
NEIHU	ADD : 4Fl., No. 339, Hsin Hu 2 nd Rd., Taipei 114, Taiwan, R.O.C. TEL : 886-2-2794-8886 FAX : 886-2-2794-9777
JHUBEI	ADD : No.8, Lane 724, Bo-ai St., Jhubei City, HsinChu County 302, Taiwan, R.O.C. TEL : 886-3-656-9065 FAX : 886-3-656-9085

7. TAF CERTIFICATE OF ACCREDITATION



Certificate No. : L1190-110702

財團法人全國認證基金會
Taiwan Accreditation Foundation

Certificate of Accreditation

This is to certify that

Sporton International Inc.

EMC & Wireless Communications Laboratory

No.52, Hwa Ya 1st Road, Hwa Ya Technology Park, Kwei-Shan Hsiang, Tao Yuan Hsien,
Taiwan, R.O.C.

is accredited in respect of laboratory

Accreditation Criteria : ISO/IEC 17025:2005
Accreditation Number : 1190
Originally Accredited : December 15, 2003
Effective Period : January 10, 2010 to January 09, 2013
Accredited Scope : Testing Field, see described in the Appendix
Specific Accreditation Program : Accreditation Program for Designated Testing Laboratory for Commodities Inspection
Accreditation Program for Telecommunication Equipment Testing Laboratory
Accreditation Program for BSMI Mutual Recognition Arrangement with Foreign Authorities



Jay-San Chen
President, Taiwan Accreditation Foundation
Date : July 02, 2011

P1, total 22 pages

The Appendix forms an integral part of this Certificate, which shall be invalid when use without the Appendix