

WITH NAVIGATION (2ND SECTION)

TABLE OF CONTENTS

1	QUICK GUIDE	9
2	APPLICATION-“Map”	19
3	APPLICATION-THE OTHERS	73
4	AUDIO SYSTEM	99
5	Bluetooth® HANDS-FREE SYSTEM	153
6	VOICE COMMAND SYSTEM	185
7	VEHICLE INFORMATION	189
8	SETUP	195
9	REAR VIEW MONITOR SYSTEM	213
	INDEX	221

Introduction

DISPLAY AUDIO SYSTEM OWNER'S MANUAL

This manual explains the operation of the Display Audio system. Please read this manual carefully to ensure proper use. Keep this manual in your vehicle at all times.

The screen shots in this document and the actual screens of the Display Audio system differ depending on whether the functions and/or a contract existed and the map data available at the time of producing this document.

NAVIGATION SYSTEM

The Navigation System is one of the most technologically advanced vehicle accessories ever developed. The system receives satellite signals from the Global Positioning System (GPS) operated by the U.S. Department of Defense. Using these signals and other vehicle sensors, the system indicates your present position and assists in locating a desired destination.

The navigation system is designed to select efficient routes from your present starting location to your destination. The system is also designed to direct you to a destination that is unfamiliar to you in an efficient manner. The system is developed by "Harman International" using "Navteq" maps. The calculated routes may not be the shortest nor the least traffic congested. Your own personal local knowledge or "short cut" may at times be faster than the calculated routes.

The navigation system's database includes Point of Interest categories to allow you to easily select destinations such as restaurants and hotels. If a destination is not in the database, you can enter the street address or a major intersection close to it and the system will guide you there.

The system will provide both a visual map and audio instructions. The audio instructions will announce the distance remaining and the direction to turn in approaching an intersection. These voice instructions will help you keep your eyes on the road and are timed to provide enough time to allow you to maneuver, change lanes or slow down.

Please be aware that all current vehicle navigation systems have certain limitations that may affect their ability to perform properly. The accuracy of the vehicle's position depends on the satellite condition, road configuration, vehicle condition or other circumstances. For more information on the limitations of the system, refer to page 66.

TOYOTA MOTOR CORPORATION

IMPORTANT INFORMATION ABOUT THIS MANUAL

For safety reasons, this manual indicates items requiring particular attention with the following marks.



CAUTION

- This is a warning against anything which may cause injury to people if the warning is ignored. You are informed about what you must or must not do in order to reduce the risk of injury to yourself and others.



NOTICE

- This is a warning against anything which may cause damage to the vehicle or its equipment if the warning is ignored. You are informed about what you must or must not do in order to avoid or reduce the risk of damage to your vehicle and its equipment.

SAFETY INSTRUCTION



To use this system in the safest possible manner, follow all the safety tips shown below.

This system is intended to assist in reaching the destination and, if used properly, can do so. The driver is solely responsible for the safe operation of your vehicle and the safety of your passengers.

Do not use any feature of this system to the extent it becomes a distraction and prevents safe driving. The first priority while driving should always be the safe operation of the vehicle. While driving, be sure to observe all traffic regulations.

Prior to the actual use of this system, learn how to use it and become thoroughly familiar with it. Read the entire Display Audio system Owner's manual to make sure you understand the system. Do not allow other people to use this system until they have read and understood the instructions in this manual.

For your safety, some functions may become inoperable when driving. Unavailable screen buttons are dimmed. Only when the vehicle is not moving, can the destination and route selection be done.

CAUTION

- For safety, the driver should not operate the Display Audio system while he/she is driving. Insufficient attention to the road and traffic may cause an accident.
- While driving, be sure to obey the traffic regulations and maintain awareness of the road conditions. If a traffic sign on the road has been changed, route guidance may not have the updated information such as the direction of a one way street.

While driving, listen to the voice instructions as much as possible and glance at the screen briefly and only when it is safe. However, do not totally rely on voice guidance. Use it just for reference. If the system cannot determine the current vehicle position correctly, there is a possibility of incorrect, late, or non-voice guidance.

The data in the system may occasionally be incomplete. Road conditions, including driving restrictions (no left turns, street closures, etc.) frequently change. Therefore, before following any instruction from the system, look to see whether the instruction can be done safely and legally.

This system cannot warn about such things as the safety of an area, condition of streets, and availability of emergency services. If unsure about the safety of an area, do not drive into it. Under no circumstances is this system a substitute for the driver's personal judgement.

Use this system only in locations where it is legal to do so. Some states/provinces may have laws prohibiting the use of video and navigation screens next to the driver.

TABLE OF CONTENTS

1 QUICK GUIDE

1. CONTROLS AND FEATURES	10
OVERVIEW BUTTONS	10
SYSTEM FUNCTION INDEX.....	12
TOUCH SCREEN OPERATION	14

2 APPLICATION-“Map”

1. NAVIGATION OPERATION	20
QUICK REFERENCE	20
NAVIGATION SYSTEM FUNCTION INDEX.....	23
MAP SCREEN OPERATION	25
MAP ICONS.....	29
2. DESTINATION SEARCH.....	33
DESTINATION SEARCH.....	33
3. ROUTE GUIDANCE.....	42
STARTING ROUTE GUIDANCE	42
ROUTE GUIDANCE	44
SETTING AND DELETING THE ROUTE.....	46
4. MY DESTINATIONS	52
REGISTERING A ENTRY.....	52
DISPLAYING AND EDITING THE ENTRY INFORMATION.....	58
SENDING STORED CONTACTS TO A USB MEMORY	60
5. NAVIGATION SETTING	61
MAP SETTINGS	61
ROUTE SETTINGS	64
6. NAVIGATION SYSTEM INFORMATION	66
LIMITATIONS OF THE NAVIGATION SYSTEM.....	66
MAP INFORMATION	68

3 APPLICATION-THE OTHERS

1. APPLICATIONS OPERATION.....	74
QUICK REFERENCE.....	74
PICTURE SLIDESHOW	75
EMAIL.....	77
CALENDAR.....	79
2. ENTUNE SERVICE	80
ENTUNE SERVICE.....	80
OPERATING NAVIGATION FUNCTION USING ENTUNE SERVICE.....	83
OPERATING AN APPLICATION USING ENTUNE SERVICE.....	93

4 AUDIO SYSTEM

1. AUDIO SYSTEM OPERATION	100
QUICK REFERENCE.....	100
SOME BASICS.....	102
RADIO OPERATION.....	106
RADIO OPERATION (XM [®] Satellite Radio BROADCAST).....	112
CD PLAYER OPERATION.....	117
USB MEMORY/iPod OPERATION	123
AUX DEVICE OPERATION	130
Bluetooth [®] AUDIO OPERATION	132
STEERING SWITCHES	141
AUDIO SYSTEM OPERATING HINTS.....	144

5

Bluetooth® HANDS-FREE SYSTEM

1. BASIC INFORMATION

BEFORE OPERATION 154

QUICK REFERENCE 154

HANDS-FREE SYSTEM 157

CONNECTING A
Bluetooth® PHONE 161

REGISTERING A ENTRY 165

2. TELEPHONE OPERATION 170

CALLING ON A Bluetooth® PHONE ... 170

RECEIVING CALLS ON A
Bluetooth® PHONE 175

TALKING ON A Bluetooth® PHONE ... 176

3. SHORT MESSAGE FUNCTION 179

SHORT MESSAGE FUNCTION..... 179

6

VOICE COMMAND SYSTEM

1. VOICE COMMAND SYSTEM OPERATION 186

VOICE COMMAND SYSTEM..... 186

7

VEHICLE INFORMATION

1. VEHICLE INFORMATION 190

QUICK REFERENCE 190

FUEL CONSUMPTION 191

TIRE PRESSURE WARNING
SYSTEM 193

8

SETUP

1. SETUP OPERATION 196

QUICK REFERENCE 196

GENERAL SETTINGS..... 197

DISPLAY SETTINGS..... 200

Bluetooth® SETTINGS..... 202

PHONE SETTINGS 209

AUDIO SETTINGS..... 210

VEHICLE SETTINGS..... 211

9

REAR VIEW MONITOR SYSTEM

1. REAR VIEW MONITOR SYSTEM 214

REAR VIEW MONITOR SYSTEM
OPERATION 214

DRIVING PRECAUTIONS
(WITH REAR VIEW MONITOR
GUIDE LINES) 218

INDEX

ALPHABETICAL INDEX..... 222

1

2

3

4

5

6

7

8

9

1

QUICK GUIDE

1 CONTROLS AND FEATURES

1. OVERVIEW BUTTONS	10
2. SYSTEM FUNCTION INDEX.....	12
3. TOUCH SCREEN OPERATION....	14
INPUT SCREEN OPERATION	14
LIST SCREEN OPERATION	16

1

2

3

4

5

6

7

8

9

1. OVERVIEW BUTTONS

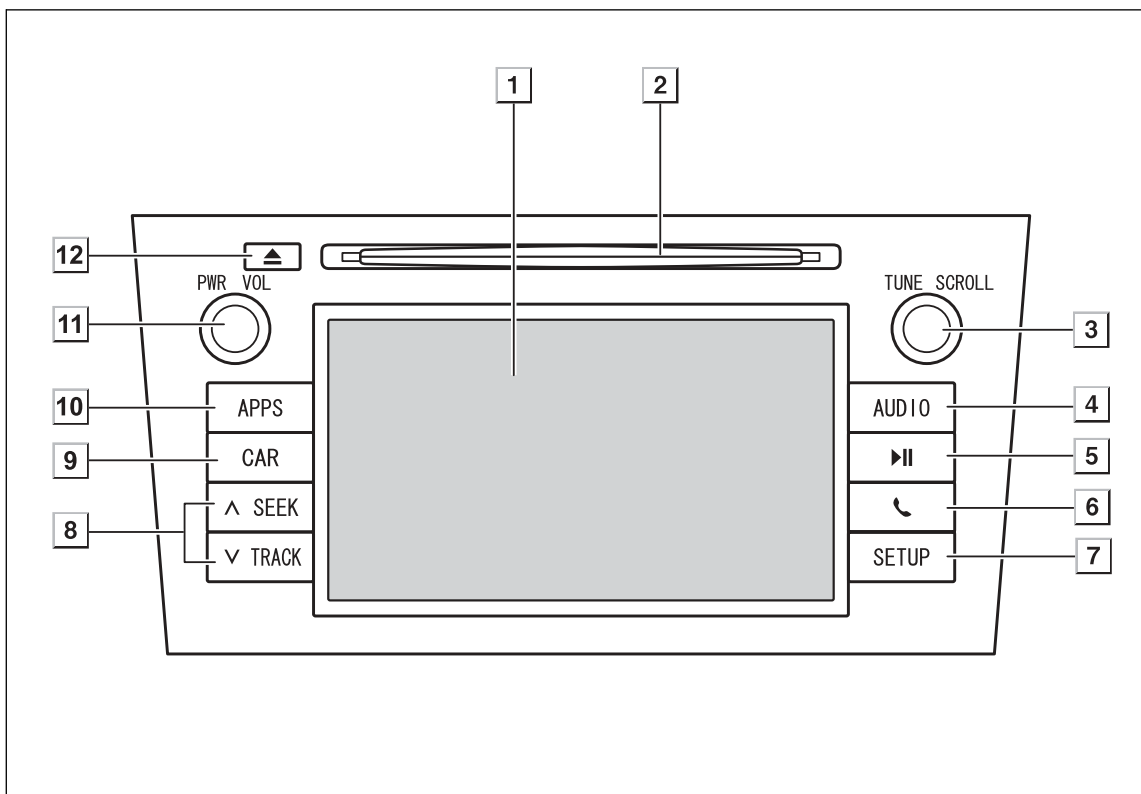

* The actual design and button position may differ depending on the vehicle. For details, see Section 3 of “Owner’s Manual”.

No.	Name	Function	Page
1	Touch screen display	By touching the screen with your finger, you can control the selected functions.	14
2	Disc slot	Insert a disc into this slot. The CD player turns on immediately.	117
3	“TUNE SCROLL” knob	Turn this knob to select radio station bands, tracks and files. Also, the knob can be used for selection from the list display.	103
4	“AUDIO” button	Press this button to access the audio system. The audio system turns on in the last mode used.	100, 102, 103
5	▶ button*	Press this button to pause or resume playing the music.	—
6	 button	Press this button to access the Bluetooth® hands-free system.	154
7	“SETUP” button	Press this button to customize the function settings.	196

No.	Name	Function	Page
8	“SEEK/TRACK” button	Press the “^” or “v” button to seek up or down for a radio station, or to access a desired track or file.	107, 114, 119, 121, 124, 137
9	“CAR” button*	Press this button to access the vehicle information system.	190
10	“APPS” button	Press to display a list of applications.	20, 74
11	“PWR VOL” knob	Press this knob to turn the audio system on and off, and turn it to adjust the volume.	102
12	 button	Press this button to eject a disc.	117

*: If equipped

2. SYSTEM FUNCTION INDEX

APPLICATION SYSTEM

To access the application system, press the **“APPS”** button. The “Applications” menu screen will be displayed. The driver can use the navigation system and the other applications. For details, see page 19, 73.



Bluetooth® HANDS-FREE SYSTEM

To access the Bluetooth® hands-free system, press the  button. The driver can make or receive phone calls without taking their hands off the steering wheel. For details, see page 153.



AUDIO SYSTEM

To access the audio system, press the **“AUDIO”** button. The audio control screen will be displayed. Audio sources: Radio, CDs, iPod, USB, AUX and Bluetooth® audio. For details, see page 99.



VOICE COMMAND SYSTEM

To access the voice command system, press the  switch on the steering wheel. The driver can operate the Display Audio system by giving a command. For details, see page 185.



VEHICLE INFORMATION (IF EQUIPPED)

To access the vehicle information system, press the **"CAR"** button. Fuel consumption and tire pressure can be checked. For details, see page 189.

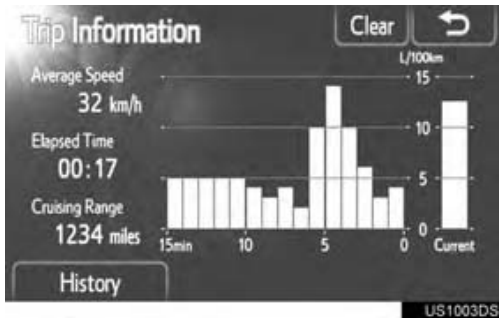

SETUP

To customize the function settings, press the **"SETUP"** button. The interface language can also be changed from the setup menu. For details, see page 195.



REAR VIEW MONITOR SYSTEM

Shifting into the "R" position will automatically show the view behind the rear of the vehicle on the display screen. For details, see page 213.



3. TOUCH SCREEN OPERATION

This system is operated mainly by the screen buttons on the screen.

- To prevent damage to the screen, lightly touch screen buttons on the screen with the finger. When a screen button on the screen is touched, a beep sounds. (To set a beep sound, see page 197.)
- Do not use objects other than your finger to touch the screen.



NOTICE

- To prevent the 12-volt battery from being discharged, do not leave the system on longer than necessary when the engine is not running.

INFORMATION

- If the system does not respond to a touch on a screen button, move the finger away from the screen and then touch it again.
- Dimmed screen buttons cannot be operated.
- Wipe off fingerprints using a glass cleaning cloth. Do not use chemical cleaners to clean the touch screen.
- The displayed image may become darker and moving images may be slightly distorted when the display is cold.
- Under extremely cold conditions, the screen may not be displayed and the data input by a user may be deleted. Also, the screen buttons may be harder than usual to depress.
- When you look at the screen through polarized material such as polarized sunglasses, the screen may be dark and hard to see. If so, look at the screen from different angles, adjust the screen settings (See “DISPLAY SETTINGS” on page 200.), or take off your sunglasses.

INPUT SCREEN OPERATION

When searching for an address or a name, letters and numbers can be input via the screen.

INFORMATION

- Letters cannot be input while driving.

INPUTTING LETTERS AND NUMBERS

- Touch the keys directly to input letters or numbers.



: Touch to delete one letter. Touch and hold to continue deleting letters.

- Touch “OK”.

INFORMATION

- When a character is input, a hint will appear displaying a possible match for the word to be searched.
- Currently unavailable screen buttons will be dimmed.
- When an entry is too long to be displayed in the input field, the last section of the input text will be displayed with the initial section displayed as “...”.
- If the vehicle starts moving while letters are being input, a warning message will be displayed and letters cannot be input. Touch “**Previous**” to return to the previous screen.



CHANGING BETWEEN LOWER CASE AND UPPER CASE

1 Touch **A>a** or **a>A**.



A>a : Touch to enter in lower case.

a>A : Touch to enter in upper case.

Each time **A>a** or **a>A** is touched, input will change between upper case and lower case input.

INFORMATION

- In the following situations, the input mode will automatically change between upper and lower case.
 - When the keyboard layout is changed to upper case input, the layout will automatically change back to lower case input after one letter has been entered.
 - When “/”, “&”, “.” or “(” is input, the keyboard layout will automatically be changed to upper case input.
 - When all characters are deleted, the keyboard layout will automatically change to upper case input.

INPUTTING SYMBOLS

1 Touch **A+U**.



2 Touch **ÉØÛ** (**éøü**) or **@+#**.



i **ÉØÛ** (**éøü**) keyboard layout



i **@+#** keyboard layout



3 Touch the symbol keys directly to input symbols.

ENTERING FROM THE LIST OF MATCHING ENTRIES

On certain screens, a candidate entry text or word prediction list based on the input letters will be displayed. The desired item can be selected and entered.

1 Enter letters.



- If a candidate entry text displayed in the input field is what is desired, touch “OK”.
- Touching  displays the candidate entry text list. The number of matching items is shown. Up to 300 items are displayed.
- The list will be displayed automatically, if the number of matching entries is 5 or less.

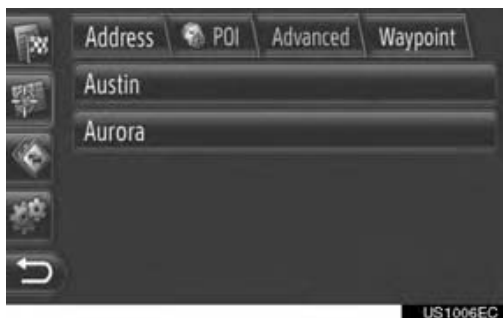

2 Touch desired item.



LIST SCREEN OPERATION

When a list is displayed, use the appropriate screen button to scroll through the list.



 or : Touch to shift to the next or previous page.

• By touching and holding this screen button, the screen can be scrolled up or down. Scrolling will automatically stop when the top/bottom of the list is reached.

: Touch to have entries that are too long to fit in the current field scrolled automatically from right to left.

: This indicates the displayed screen's position.

INFORMATION

- While driving, changing pages will be limited.

CHARACTER JUMP BUTTONS IN LISTS

Some lists contain character screen buttons, “**ABC**”, “**DEF**” etc., which allow a direct jump to list entries that begin with the same letter as the character screen button.

- 1 Touch one of the character screen buttons.



INFORMATION

- Every time the same character screen button is touched, the list starting with the subsequent character is displayed.

1 NAVIGATION OPERATION

- 1. QUICK REFERENCE 20**
- 2. NAVIGATION SYSTEM
FUNCTION INDEX 23**
- 3. MAP SCREEN OPERATION 25**
 - TO DISPLAY MAP SCREEN 25
 - MAP SCREEN OPERATION 25
- 4. MAP ICONS 29**
 - POI* ICONS 29

2 DESTINATION SEARCH

- 1. DESTINATION SEARCH 33**
 - DESTINATION SEARCH ON THE
“My Destinations” SCREEN 33
 - DESTINATION SEARCH ON THE
“Enter Destination” SCREEN 35

*: Point of Interest

APPLICATION-“Map”

3 ROUTE GUIDANCE

- 1. STARTING ROUTE GUIDANCE 42**
 STARTING ROUTE GUIDANCE
 SCREEN 42
 SETTING THE ROUTE 43
- 2. ROUTE GUIDANCE 44**
 ROUTE GUIDANCE SCREEN 44
 VOICE GUIDANCE 45
- 3. SETTING AND DELETING THE ROUTE 46**
 SETTING FROM THE “Options”
 SCREEN 46
 ADDING DESTINATIONS 49
 DETOURING A SEGMENT ON THE
 ROUTE 51

4 MY DESTINATIONS

- 1. REGISTERING A ENTRY 52**
 REGISTERING A NEW ENTRY 52
- 2. DISPLAYING AND EDITING THE ENTRY INFORMATION 58**
 DISPLAYING AND EDITING THE
 ENTRY INFORMATION 58
- 3. SENDING STORED CONTACTS TO A USB MEMORY 60**
 SENDING STORED CONTACTS TO A
 USB MEMORY 60

5 NAVIGATION SETTING

- 1. MAP SETTINGS 61**
 SETTING THE MAP 61
- 2. ROUTE SETTINGS 64**
 SETTING THE ROUTE OPTIONS 64

6 NAVIGATION SYSTEM INFORMATION

- 1. LIMITATIONS OF THE NAVIGATION SYSTEM 66**
- 2. MAP INFORMATION 68**

1. NAVIGATION OPERATION

1. QUICK REFERENCE

The navigation application and several other applications can be accessed by pressing the “**APPS**” button.

When the “**APPS**” button is pressed, the “Applications” menu screen that was last displayed is returned to. Touch  to display the “Applications” menu screen.

i “Applications” menu screen

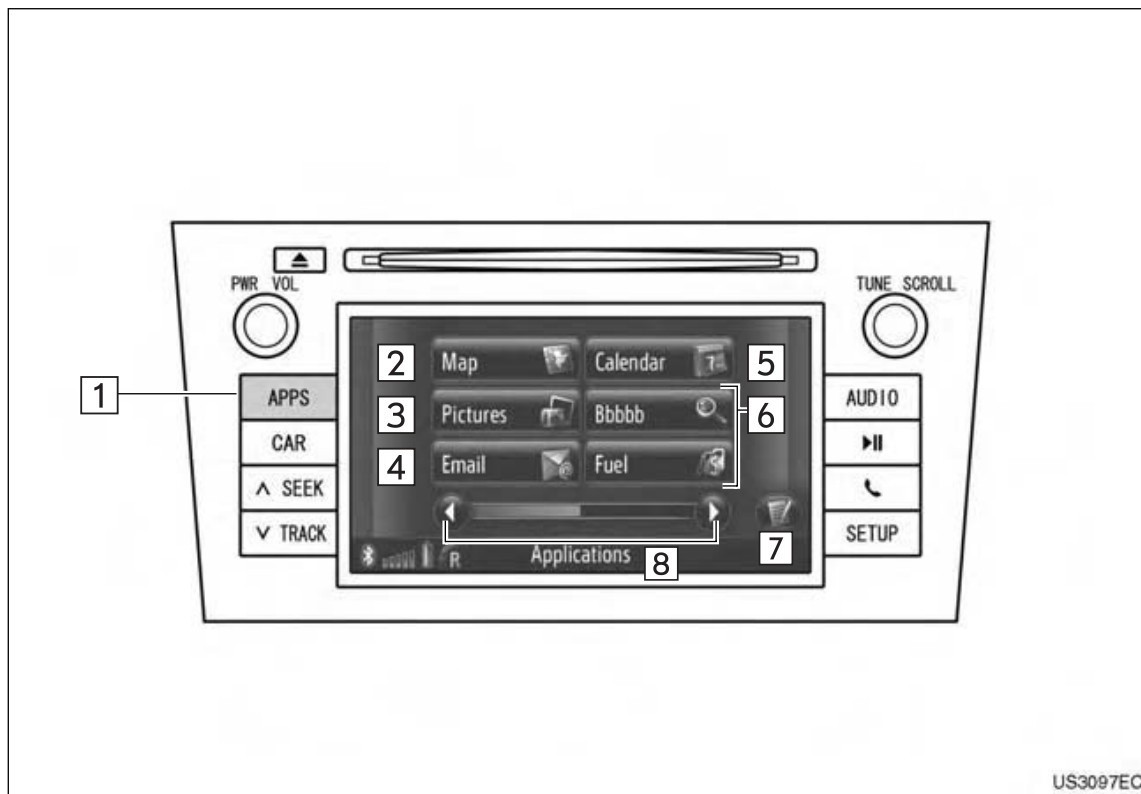

No.	Function	Page
1	Press to display a list of applications.	∞
2	“Map” provides the user with navigation, route calculation, destination entry (manually or via voice recognition), turn by turn directions, and real-time traffic.	25
3	Touch to view pictures stored on a USB memory.	75
4	Touch to display Emails.	77
5	Touch to access the connected phone’s calendar, tasks and notes.	79
6	Touch to access the applications.	83, 85, 93
7	Touch to close or delete the applications.	93, 94
8	Touch to shift to the next or previous page.	∞

To display the “Navigation” menu screen, touch “Dest” on the map. From this screen, destinations can be entered and route-related settings can be changed.

i “Navigation” menu screen

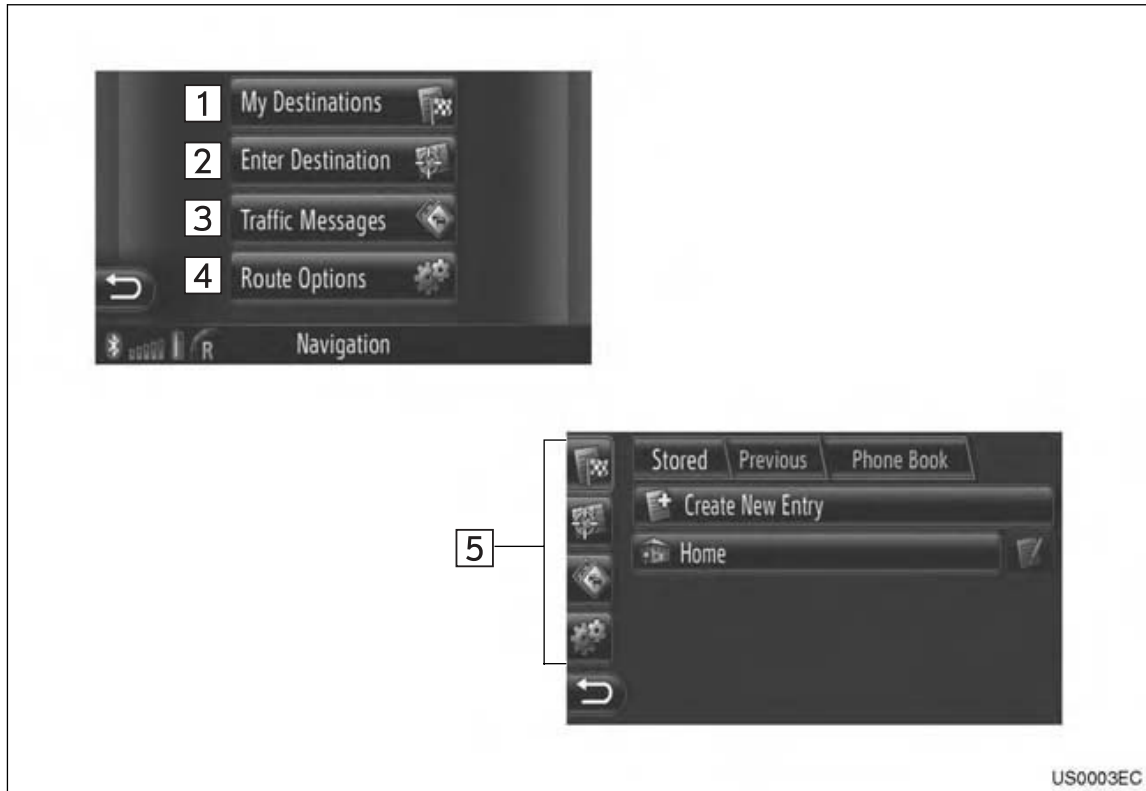

No.	Function	Page
1	Touch to display the “My Destinations” screen. A destination can be entered by selecting an item from the list of stored destinations, previous destinations or the addresses from the connected phone’s phone book.	33
2	Touch to display the “Enter Destination” screen. A destination can be entered by address, POI or using advanced options. It can also be added as a waypoint to a destination.	35, 49
3	Touch to display the “Traffic Messages” screen. Traffic messages function is using Entune service. It contains a list of traffic messages relating to the set route, all traffic messages and warnings.	86
4	Touch to display the “Route Options” screen. The route preferences, avoidance criteria and traffic messages function can be adjusted.	64
5	Touch the corresponding icon to change to the “My Destinations”, “Enter Destination”, “Traffic Messages” or “Route Options” screen.	33, 35, 49, 64, 86

i Overview guidance screen



No.	Function	Page
1	This symbol indicates a map layout. Touching this symbol changes the map layout.	28
2	Displays the distance, the estimated travel time to the destination, or the estimated arrival time at the destination.	44
3	Displays traffic information on the route.	86
4	Displays the distance to the next turn with the arrow indicating the turn direction.	44
5	Touch to display the "Options" screen.	46
6	Touch to display the "Navigation" menu screen.	21
7	Displays the current street name.	44
8	Touch to display the "Applications" menu screen.	20, 74
9	Touch to hear voice guidance and/or adjust the volume of voice guidance.	45
10	Touch to change the map scale.	27

i Map

Displaying maps	Page
Viewing the map screen	25
Displaying the current vehicle position	25
Viewing the current vehicle position vicinity map	27
Changing the scale	27
Changing the map layout	27
Displaying Point of Interest Icons	29
Viewing traffic messages	86
Searching destination	Page
Searching the destination	33
Setting the entry registered with the system as the destination	33

i Route guidance

Before starting route guidance	Page
Recalculating the route	43
Viewing alternative routes	42
Starting route guidance	42
Before starting or during route guidance	Page
Viewing the route	46
Adding destinations	49
Recalculating the route	47
Changing the estimated travel/arrival time display	63

During route guidance	Page
Stopping route guidance	46
Adjusting route guidance volume	45
Displaying the entire route map	46

i Memory point

Memory point	Page
Registering the entry	52
Editing the entry	58
Loading the entry from external devices	56

3. MAP SCREEN OPERATION

TO DISPLAY MAP SCREEN

1 Press the "APPS" button.

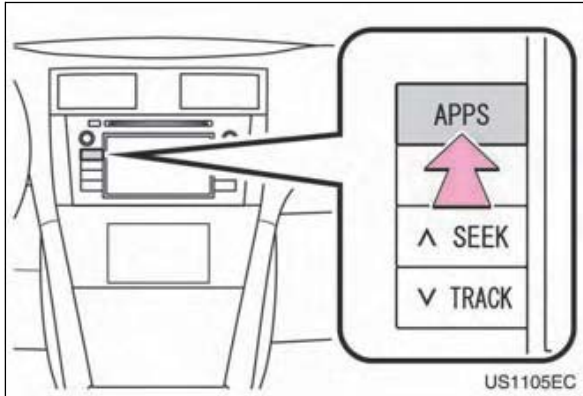

When the "APPS" button is pressed, the "Applications" menu screen that was last displayed will be returned to. Touch  until the "Applications" menu screen is displayed.

2 Touch "Map".



3 Touch "Confirm".



After about a few seconds, the "CAUTION" screen automatically switches to the map screen.

INFORMATION

- The "CAUTION" screen will be displayed when the screen is changed to the map screen for the first time after the engine switch has been in the "ACC" or "ON" position.
- If "Map" is touched while the map is loading or an application is in use, a pop-up window will be displayed. When the loading process is complete, the map screen will be displayed.

MAP SCREEN OPERATION

CURRENT VEHICLE POSITION DISPLAY

When starting the navigation system, the current position is displayed first. This screen displays the current vehicle position and a map of the surrounding area.



The current vehicle position mark  appears in the center of the map screen.

INFORMATION

- The vehicle icon can be changed. (See page 61.)
- While driving, the current vehicle position mark is fixed on the screen and the map moves.
- The current position is automatically set as the vehicle receives signals from the GPS (Global Positioning System). If the current position is not correct, it is automatically corrected after the vehicle receives signals from the GPS.
- After 12-volt battery disconnection, or on a new vehicle, the current position may not be correct. As soon as the system receives signals from the GPS, the correct current position is displayed.

CURRENT LOCATION AND GPS INFORMATION

Current location, geo-coordinates and GPS information are displayed.

- 1 Touch **“Options”** on the map.
- 2 Touch **“Location & GPS Information”**.

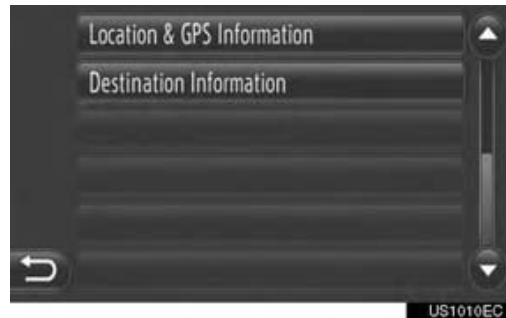

- 3 An information screen will be displayed.





On this screen, the following information is displayed.

No.	Information
1	The information provided varies, depending whether the road currently being travelled on is a free-way or a street.
2	Latitude and Longitude
3	Amount of available satellites and the altitude.

SCREEN SCROLL OPERATION

When any point on the map is touched, that point moves to the center of the screen and is shown by the cursor mark .



- If a finger is continuously held on the screen, the map will continue scrolling in that direction until the finger is removed.
- A street name or geo-coordinates of the touched point will be shown, depending on the scale of the map.
- After the screen is scrolled, the map remains centered at the selected location until another function is activated. The current vehicle position mark will continue to move along your actual route and may move off the screen. When  is touched, the current vehicle position mark returns to the center of the screen and the map moves as the vehicle proceeds along the designated route.
- When the scroll feature is used, the current vehicle position mark may disappear from the screen. Touch  to display the current vehicle position on the map screen.

- When **“Calculate”** is touched, the starting route guidance screen is displayed. (See page 42.)
- When **“Save”** is touched, the point is registered in the “Stored” list on the “My Destinations” screen. (See page 54.)

MAP CONFIGURATIONS

Any of the following map configurations can be selected.

MAP SCALE

- 1 Touch **“+”** or **“-”** to change the scale of the map screen.



INFORMATION

- The scale range is from 150 ft to 250 miles.
- After the scale has been changed, the new scale indicator will be displayed in the upper left area of the screen for a while.

MAP LAYOUT

The map layout can be changed from “3D Heading”, “2D Heading” or “2D North”.

1 Touch  or .



2 Touch the desired map layout.



“3D Heading”: Touch to display 3D map. The direction of vehicle travel is always up.
 “2D Heading”: Touch to display 2D map. The direction of vehicle travel is always up.
 “2D North”: Touch to display 2D map. Regardless of the direction of vehicle travel, north is always up.

i 3D Heading



i 2D Heading



i 2D North



‘ Map layout can be also changed by “Map Settings”. (See page 61.)

4. MAP ICONS

POI ICONS

DISPLAY POI ICONS

Points of Interest such as gas stations and restaurants can be displayed on the map screen. Their location can also be set as a destination.

POI icons are displayed on the map.



You can select a particular type of Point of Interest displayed on the screen. (See page 61.)

















LIST OF POI ICONS

i Public

Icon	Name
	Library
	College/University
	School
	Tourist office
	Cemetery, funeral director
	Government Office, Institution, City hall, Community gen.
	Community

Icon	Name
	Court house
	Place of worship
	Accommodation, Hotel/Motel
	Pharmacy
	Convention Center, Exhibition Center
	Finance, Bank
	Cash Dispenser
	Post Office
	Business, B. General, B. facility
	Medical, Doctor, Health & Care
	Ambulance, Hospital/Polyclinic
	Fire Station
	Police Station
	Phone Box, Communication
	Dentist
	Veterinarian

i Traffic







Icon	Name
	Car Dealer/Repairer, Repair Facility, Repair General, Car Wash, Tire Repair
	Car Dealer
	Highway Exit
	Airport, Dep. /Arrival, Ground, International, Domestic
	Bus Terminal, Bus Stop, Transportation, Public Transp. Stop, Transport general
	Railway Station
	Metropolitan Train
	Gas Station
	Rent-a-Car,-Facility, -Parking
	Ferry Terminal
	Parking, Open Parking Area, P. Area general
	Parking Garage
	Open P.A. P+P
	Rest Area
	Motoring Organization, Automobile Club
	Mover, Moving Company

Icon	Name
	Motorcycle Dealer

















i Clubbing



Icon	Name
	Multiple POI
	Bar, Nightlife
	Leisure, Cultural Center, Theater, Music Center, Concert Hall
	Cinema
	Casino
	Cafe/Bar, Cafe
	Restaurant, French, Belgian, Chinese, German, Greek, Vegetarian, Fast Food, Grill, Sea Food, Sandwich, Steak...

i Sport

Icon	Name
	Sport, Sport General, sport activities
	Golf Course
	Race Track
	Stadium, Sports Center, Hippodrome
	Water Sports
	Bowling

i Leisure

Icon	Name
	Amusement Park
	Winery
	Museum
	Shopping, Market Place, Shopping Center, Factory Outlet
	Shop, Department Store, Drive-through-bottle-shop
	Tourist Attractions, Important Tourist Attractions
	Park/Recreational Area
	Yacht Basin, Harbour
	Camping Ground
	Grocery Store
	Historical Monument
	RV Park, Camping
	Bookstore
	Hair & Beauty
	Photography
	Shoestore
	Wine & Liquor

Icon	Name
	Clothing
	Cleaning & Laundry

2

APPLICATION-"Map"

DISPLAYING POI INFORMATION

1 Touch the desired POI icon on the map.

2 Touch .

i One POI



i Multiple POI



3 POI information will be displayed.

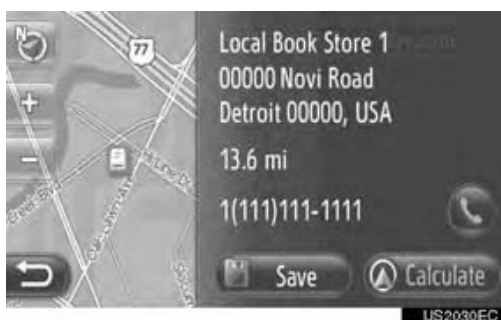

- ‘ When **“Calculate”** is touched, the starting route guidance screen is displayed. (See page 42.)
- ‘ When **“Save”** is touched, the point is registered in the “Stored” list on the “My Destinations” screen. (See page 54.)
- ‘ When  is touched, the registered telephone number is called.

1. DESTINATION SEARCH

DESTINATION SEARCH ON THE “My Destinations” SCREEN

There are several ways to search a destination.

- (a) Destination search by stored destinations
- (b) Destination search by previous destinations
- (c) Destination search by the connected phone’s phone book

- 1 Touch “**Dest**” on the map.
- 2 Touch “**My Destinations**”.



The “My Destinations” screen can be displayed by touching  on any of the “Navigation” screens.

- 3 Touch the tab for the desired method.



Please refer to the following pages for a description of each operation.

DESTINATION SEARCH BY “Stored”

Destinations can be selected from the destinations registered with the system. To use this function, it is necessary to register the entry. (See page 52.)

- 1 Touch “**Stored**” on the “My Destinations” screen.
- 2 Touch the desired entry.



Touch  to display and edit the entry information. (See page 58.)

- 3 The starting route guidance screen will be displayed. (See page 42.)

INFORMATION

- If “**Home**” has not been registered, a message will be displayed and the setting screen will automatically appear. (See page 53.)

DESTINATION SEARCH BY “Previous”

A destination can be selected from the past destination list.

- 1 Touch “**Previous**” on the “My Destinations” screen.
- 2 Touch the desired entry.



Touch  to display and edit the entry information. (See page 58.)

- 3 The starting route guidance screen will be displayed. (See page 42.)

INFORMATION

- The list can contain a maximum of 100 entries. When the maximum is reached, the oldest destination is deleted, making room for the new destination to be stored in the list.

DESTINATION SEARCH BY “Phone Book”

A destination can be set using the address of a contact from the phone book of a connected cellular phone. Before using this function, connect a Bluetooth® phone with a phone profile. (See page 203.)

If a contact does not have address information stored, the entry will be dimmed.

- 1 Touch “**Phone Book**” on the “My Destinations” screen.
- 2 Touch the desired entry.



Touch “**Search Contact**” to search by the contact's name.

Touch  to display and edit the entry information. (See page 58.)

- 3 The starting route guidance screen will be displayed. (See page 42.)

INFORMATION

- “**Search Contact**” cannot be operated while driving.

DESTINATION SEARCH ON THE “Enter Destination” SCREEN

There are several ways to search a destination.

- (a) Destination search by address
- (b) Destination search by POI
- (c) Destination search by advanced

- 1 Touch “**Dest**” on the map.
- 2 Touch “**Enter Destination**”.

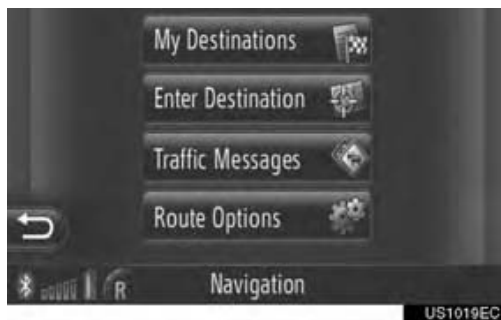

- The “Enter Destination” screen can be displayed by touching  on any of the “Navigation” screens.

- 3 Touch the tab for the desired method.



- Please refer to the following pages for a description of each operation.

DESTINATION SEARCH BY “Address”

A destination can be searched using a city name or zip code.

- 1 Touch “**Address**” on the “Enter Destination” screen.
- 2 Touch “**Country**”.



- 3 Touch the desired country.



- 4 Touch “**State**” and enter the desired state (USA and Mexico) or province (Canada).



- 5 Touch “**City**” or “**Zip**” to enter the city name or zip code.



When either a “**City**” or “**Zip**” is entered, the other will be entered automatically.

- 6 Touch “**Street**” to enter the street name.
- 7 Touch “**No.**” to enter the street No.
- 8 Touch “**Calculate Route**”.
- 9 The starting route guidance screen will be displayed. (See page 42.)

INFORMATION

- “**Calculate Route**” can be selected once a “**City**” or “**Zip**” has been entered. If “**Calculate Route**” is touched when only “**City**” or “**Zip**” has been entered, a route search starts with the center of the city entered as the destination.
- While driving, screen buttons other than “**Country**” cannot be selected.

DESTINATION SEARCH BY “POI”

POIs in a specific area can be searched by category, name or from the map.

SEARCHING “By Category”

- 1 Touch “**POI**” on the “Enter Destination” screen.
- 2 Touch “**By Category**”.



- 3 Touch the desired item to search the area. (See page 38.)



- 4 Touch the desired category.

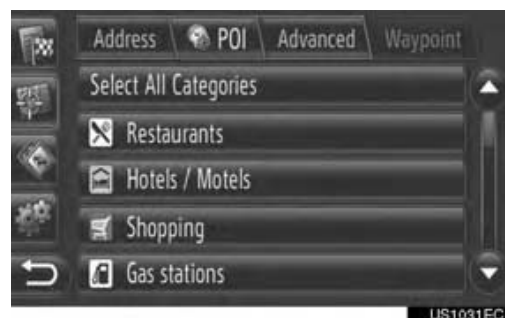

- 5 Touch  for the desired item.

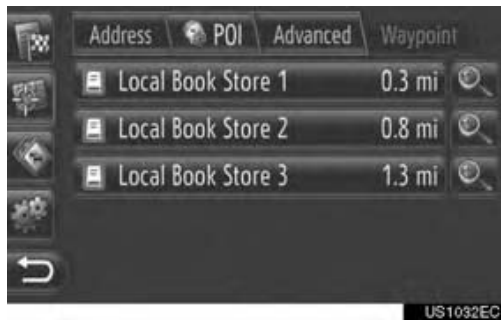

- If you touch the desired item, the starting route guidance screen will be displayed directly. (See page 42.)

- 6 Touch **“Calculate”**.

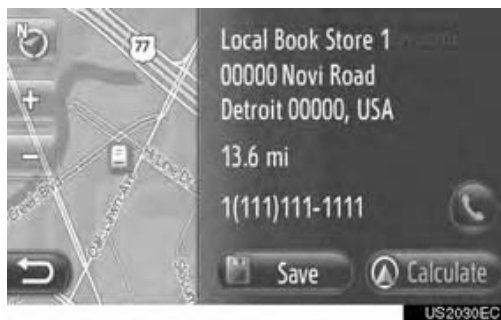

- When **“Save”** is touched, the point is registered in the “Stored” list on the “My Destinations” screen. (See page 54.)

- When  is touched, the registered telephone number is called.

- 7 The starting route guidance screen will be displayed. (See page 42.)

INFORMATION

- The POI search result list is sorted by distance to the POI. The distance can be sorted by the following methods:
 - When the search area is set to **“At Current Position”**, **“Around”** or **“Along Route”**, the distance will be calculated from the current position to the POI.
 - When the search area is set to **“At Destination”**, the distance will be calculated from the destination to the POI.

SEARCHING “By Name”

- 1 Touch **“POI”** on the “Enter Destination” screen.
- 2 Touch **“By Name”** on the “POI” screen.
- 3 Touch the desired item to search the area. (See page 38.)
- 4 Input POI name.



- 5 Touch **“OK”**.
- 6 Follow the steps “SEARCHING “By Category”” from “STEP 5”. (See page 36.)

INFORMATION

- Searching **“By Name”** cannot be operated while driving.

■ SELECTING “By Map”

- 1 Touch “**POI**” on the “Enter Destination” screen.
- 2 Touch “**By Map**” on the “POI” screen.
- 3 Touch the desired item to search the area. (See page 38.)
- 4 Touch the desired POI icon on the map.
- 5 Follow the steps “SEARCHING “By Category”” from “STEP 5”. (See page 36.)

INFORMATION

- Depending on the current map scale, not all POI icons will be available for selection.

■ SELECTING THE SEARCH AREA

- 1 Touch “**By Category**”, “**By Name**” or “**By Map**”.

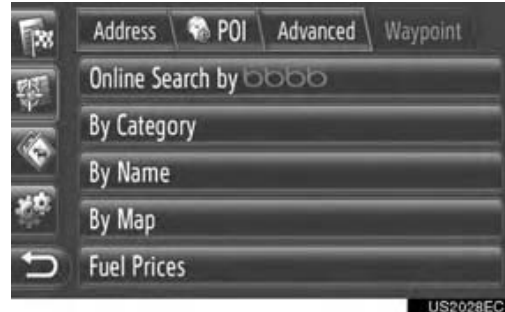

- 2 Touch the desired item to search the area.



“**At Current Position**”: Around the current position

“**Around**”: Around the defined country (See page 39.)

“**At Destination**”: Around the main destination

“**Along Route**”: Along the current route

INFORMATION

- When route guidance is not in use, “**At Destination**” and “**Along Route**” cannot be selected.
- When “**At Destination**” is selected, POIs around the destination will be searched. POIs around waypoints will not be searched.

i Selecting “**Around**” area

If you select “**Around**”, touch “**Define**” to select the desired search area.

- 1 Touch “**Country**” to select a country.

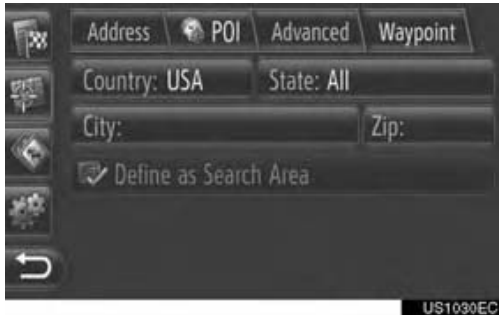

- 2 Touch “**State**” and enter the desired state (USA and Mexico) or province (Canada).
- 3 Touch “**City**” or “**Zip**” to enter the name or zip code.
 - When either a “**City**” or “**Zip**” is entered, the other will be entered automatically.
- 4 Touch “**Define as Search Area**”.

INFORMATION

- If only country is selected, a countrywide POI search is possible.

ONLINE SEARCH

A destination can be selected via Entune service. For detailed information about “Online Search”, see page 83.

FUEL PRICES

Fuel Prices function is using Entune service. It enables the navigation system to display current fuel prices and gas station locations, which can be set as a destination if desired.

For detailed information about “Fuel Prices”, see page 85.

DESTINATION SEARCH BY “Advanced”

- 1 Touch “**Advanced**” on the “Enter Destination” screen.
- 2 Touch the desired method to search the destination.

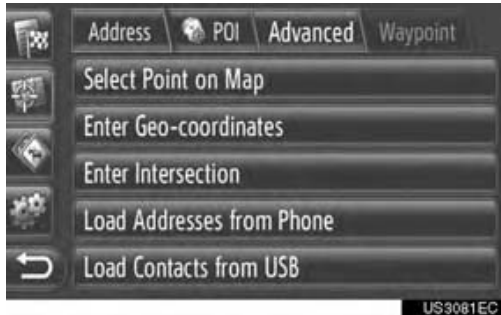

- ‘ Please refer to the following pages for a description of each operation.

SELECTING ON MAP

- 1 Touch “**Select Point on Map**” on the “Advanced” screen.
- 2 Touch the desired point on the map.



- 3 Touch “**Calculate**”.



- ‘ When “**Save**” is touched, the point is registered in the “Stored” list on the “My Destinations” screen. (See page 54.)

- 4 The starting route guidance screen will be displayed. (See page 42.)

ENTER GEO-COORDINATES

Geo coordinates can be entered in DMS format (Degrees[∇], Minutes', Seconds"). Only coordinate values that can potentially exist are able to be entered. Impossible coordinate values and their relevant screen buttons will be dimmed.

- 1 Touch **"Enter Geo-coordinates"** on the "Advanced" screen.
- 2 Touch **"N"** or **"S"**.



- 3 Input the latitude (Degrees[∇], Minutes', Seconds").
- 4 Touch **"W"** or **"E"**.
- 5 Input the longitude (Degrees[∇], Minutes', Seconds").
- 6 Touch **"OK"**.
- 7 Touch **"Calculate"**.



When **"Save"** is touched, the point is registered in the "Stored" list on the "My Destinations" screen. (See page 55.)

- 8 The starting route guidance screen will be displayed. (See page 42.)

INFORMATION

- If a destination that is not located on a road is set, the vehicle will be guided to the point on a road nearest to the destination.
- This function cannot be operated while driving.

ENTER INTERSECTION

- 1 Touch **"Enter Intersection"** on the "Advanced" screen.
- 2 Touch **"Country"** to select a country.



- 3 Touch **"State"** and enter the desired state (USA and Mexico) or province (Canada).
- 4 Touch **"City"** or **"Zip"** to enter the city name or zip code.
- 5 Touch **"Street"** to input the name of the first intersecting street and then touch **"OK"**.
- 6 Touch **"Street"** to input the name of the second intersecting street and then touch **"OK"**.
- 7 Touch **"Start Calculation"**.
- 8 The starting route guidance screen will be displayed. (See page 42.)

1. STARTING ROUTE GUIDANCE

STARTING ROUTE GUIDANCE SCREEN

After searching the destination, the starting route guidance screen will be displayed.

According to the setting, either the normal screen or route alternatives screen will be displayed. (See page 64.)

! CAUTION

● Be sure to obey traffic regulations and keep road conditions in mind while driving. If a traffic sign on the road has been changed, the route guidance may not indicate such changed information.

NORMAL SCREEN

The recommended route will be displayed on the map.

1 Touch **“Start”**.



‘ **“Preferences”**: Touch to adjust the route preferences before starting the route guidance. (See page 43.)

‘ **“Avoid”**: Touch to adjust the avoidance criteria before starting the route guidance. (See page 43.)

2 Starts route guidance. (See page 44.)

INFORMATION

- The default recommended route can be changed. (See pages 43 and 64.)
- The arrival time or the remaining time will be displayed in the upper right area of the map. Each time the area is touched, the display switches between displaying the arrival time and remaining time.
- Distance of the entire route is displayed on the map.
- The starting route guidance screen will always be displayed in 2D North.

ROUTE ALTERNATIVES SCREEN

Three recommended routes are displayed on the map.

1 Touch one of the three recommended routes to select it.



‘ **“Avoid”**: Touch to adjust the avoidance criteria before starting the route guidance. (See page 43.)

2 Start route guidance. (See page 44.)

INFORMATION

- The arrival time and distance of the entire route will be displayed in the list.
- The starting route guidance screen will always be displayed in 2D North.

SETTING THE ROUTE

SETTING THE ROUTE PREFERENCES

- 1 Touch **“Preferences”** on the starting route guidance screen.
- 2 Touch the desired item.

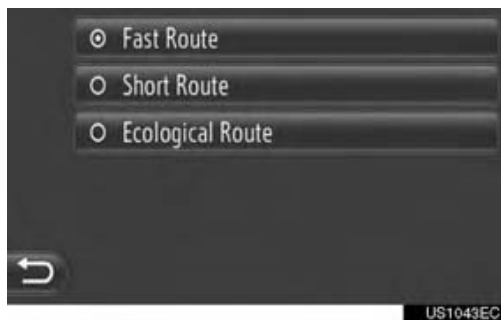

“Fast Route”: Touch to calculate the fastest route.

“Short Route”: Touch to calculate the shortest route.

“Ecological Route”: Touch to calculate an ecological route.

- 3 The route will be recalculated.

SETTING THE AVOIDANCE CRITERIA

- 1 Touch **“Avoid”** on the starting route guidance screen.
- 2 Touch the desired item.



“Avoid Freeways”: Touch to avoid freeways.

“Avoid Toll Roads”: Touch to avoid toll roads.

“Avoid Tunnels”: Touch to avoid tunnels.

“Avoid Ferries”: Touch to avoid ferries.

“Avoid Border Crossings”: Touch to avoid border crossings.

- 3 Touch .

- 4 The route will be recalculated.

INFORMATION

- Setting the route preference and avoidance can be also changed from the “Route Options” screen. (See page 64.)

2. ROUTE GUIDANCE

ROUTE GUIDANCE SCREEN

While guiding the route, the following screen will be displayed.



On this screen, the following information is displayed.

No.	Information
1	Distance and travel/arrival time to the destination
2	Traffic message on the route (See page 86.)
3	The colored section of the bar reduces as the vehicle approaches the next turn
4	Distance to the next turn with the arrow indicating the turn direction
5	The name of the road currently being travelled on
6	Guidance route
7	Current position

SIGNPOSTS

When approaching the turn, a signpost will automatically be displayed.



LANE RECOMMENDATION

When approaching a maneuver, the lane recommendation will automatically be displayed.





INFORMATION

- If the vehicle goes off the guided route, the route will be recalculated.
- For some areas, the roads have not been completely digitized in our database. For this reason, the route guidance may select a road that should not be traveled on.
- The above items will be displayed depending on the map scale.
- The displaying of the above items can be switched off. (See page 61.)

VOICE GUIDANCE

The voice guidance provides various messages as you approach an intersection, or other points where maneuvering the vehicle is necessary.



- When  is touched while route guidance is active, the last navigation announcement will be repeated.
- After touching , touch “+” or “-” to adjust the volume level of the navigation announcements.
- After touching “+” or “-”, short audible information will be given to control the current volume level (e.g. turn up/turn down).

INFORMATION

- The street names may not be pronounced correctly or clearly due to the text to-speech function.
- On freeways, interstates or other highways with higher speed limits, the voice guidance will be made at earlier points than on city streets in order to allow time to maneuver the vehicle.
- If the system cannot determine the current vehicle position correctly (in cases of poor GPS signal reception), the voice guidance may be early or delayed.

CAUTION

- Be sure to obey the traffic regulations and keep the road condition in mind especially when you are driving on IPD roads. The route guidance may not have the updated information such as the direction of a one way street.

3. SETTING AND DELETING THE ROUTE

Routes can be checked, changed and recalculated during route guidance.

SETTING FROM THE “Options” SCREEN

Checking and setting routes is mainly performed from the “Options” screen.

1 Touch “Options”.



2 Touch the desired items.

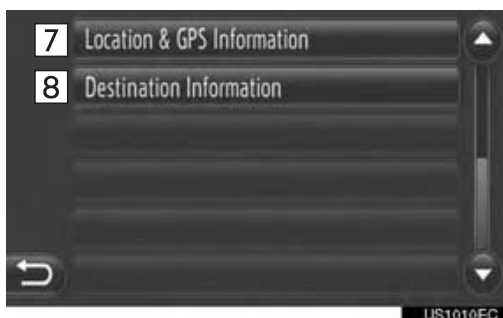
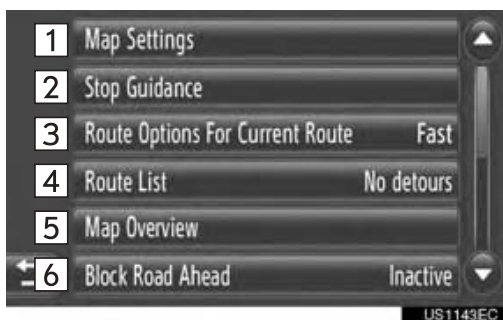

On this screen, the following functions can be operated.

No.	Function
1	Touch to change the map setting. (See page 61.)
2	Touch to stop the current route guidance.
3	Touch to set the route preferences and the avoidance criteria for the route calculation. (See page 47.) (The current status is displayed on the right of the item.)
4	Touch to display a list of the different segments of the route. It is also possible to define a detour. (See page 47.) (The current status is displayed on the right of the item.)
5	Touch to display the complete route.
6	Touch to block a fixed distance on the road ahead. (See page 48.) (The current status is displayed on the right of the item.)
7	Touch to display the current location, geo-coordinates and GPS information. (See page 26.)
8	Touch to display the destination's information. (See page 48.)

SETTING THE ROUTE PREFERENCE OR AVOIDANCE CRITERIA

- 1 Touch **“Route Options For Current Route”** on the “Options” screen.
- 2 Touch the desired item to change the route setting.



“Preferences”: Touch to adjust the route preferences. (See page 43.)

“Avoid”: Touch to adjust the avoidance criteria. (See page 43.)

- 3 The route will be recalculated.

DISPLAYING THE ROUTE LIST

A list of the different segments of the route can be displayed.

- 1 Touch **“Route List”** on the “Options” screen.
- 2 Touch the desired item to display the segment.



- 3 Guidance arrow, street name, distance to the point are displayed.

- 3 The detail of the segment is displayed.



- ◀ or ▶: Touch to display the next or previous segment.

- 3 Touch **“Detour”** to detour the desired segment. (See page 51.)

2

APPLICATION-“Map”

BLOCK ROAD AHEAD

A fixed distance on the road ahead can be blocked.

- 1 Touch “**Block Road Ahead**” on the “Options” screen.
- 2 Touch the desired item to select the desired detour distance.



“**Deactivate Block Road Ahead**”: Touch to deactivate the function.

“**Block Next 1 mi**” ~ “**Block Next 12mi**”: Touch to detour the next 1 mile ~ 12 miles of the current route (road).

‘ “**Deactivate Block Road Ahead**” can be selected when the block road ahead function has been activated.

3 The route will be recalculated.

- ‘ A blocked route will be marked in the map.
- ‘ After the blocked route has been detoured, the block road ahead function will automatically be deactivated.

DISPLAYING THE DESTINATION INFORMATION

The destination information is displayed.

- 1 Touch “**Destination Information**” on the “Options” screen.
- 2 The destination information screen will be displayed.

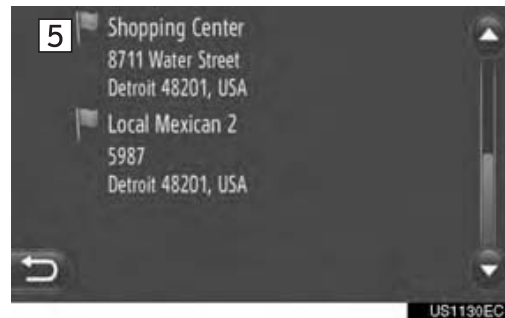

‘ On this screen, the following information is displayed.

No.	Information
1	Address of destination
2	Selected route preference
3	Selected avoidance criteria
4	Arrival time, remaining time and distance to destination
5	Address of each waypoint (if entered)

ADDING DESTINATIONS

Destinations can be added and the route changed accordingly.

- 1 Touch “**Dest**” on the map.
- 2 Touch “**Enter Destination**”.



- The “Enter Destination” screen can be displayed by touching  on any of the “Navigation” screens.

- 3 Touch “**Waypoint**” on the “Enter Destination” screen.
- 4 Touch the desired method to search the destination.

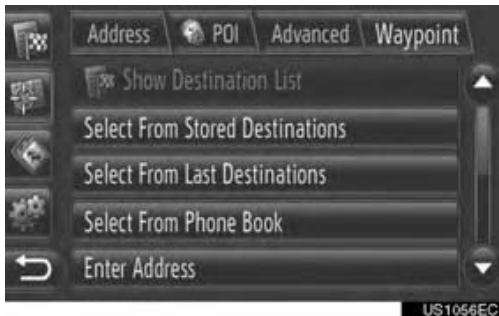

- For detailed information about searching the destination on the map, see page 33.

- i If you search the destination by “**Enter Address**”

- 5 Touch “**Add as Waypoint**”.

- i If you search the destination by “**Select Point on Map**” or “**Enter Geo-coordinates**”

- 5 Touch “**Add**”.

- i If you search the destination by the other methods



- 5 Touch the desired entry.

- 6 Touch “**Insert Waypoint**” to select the position of the waypoint.



- 7 The route will be recalculated.

INFORMATION

- In addition to the main destination, a maximum of 4 waypoints can be set.
- The main destination is marked by , the waypoints are marked by .

EDITING DESTINATIONS

- 1 Touch **“Show Destination List”** on the **“Waypoint”** screen.

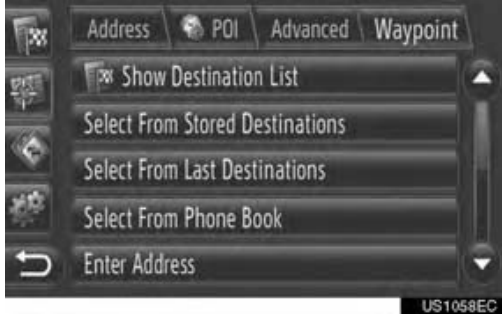



- 2 Touch the desired destination to be edited.



- 3 Touch desired item.



On this screen, the following functions can be operated.

No.	Function
1	Touch to register the point in the “Stored” list on the “My Destinations” screen. (See page 55.)
2	Touch to change the order of the destinations. Touch  or  to move the destination up or down the order displayed on the next screen.
3	Touch to delete the destination.
4	Touch to delete all waypoints.

INFORMATION

- If the main destination is deleted, the last waypoint before the deleted destination will become the new main destination.

DETOURING A SEGMENT ON THE ROUTE

When detouring a segment, the detour route can be changed.

DETOURING THE SEGMENT

- 1 Display the route list. (See page 47.)
- 2 Touch the desired segment to detour.



- 3 Touch “Detour”.



◀ or ▶: Touch to display the next or previous segment.

- 4 The route will be recalculated.

CANCELLING THE DETOURED SEGMENT

- 1 Display the route list. (See page 47.)
- 2 Touch “Detours”.



- 3 Touch “Detour Off”.



- ‘ If there is more than one point to detour, a list of points to detour will be displayed. Select points from the list to cancel detouring them.
- 4 The route will be recalculated.

4. MY DESTINATIONS

1. REGISTERING A ENTRY

REGISTERING A NEW ENTRY

Up to 200 destinations can be registered with this system.

INFORMATION

- This function cannot be operated while driving.

REGISTERING FROM THE “My Destinations” SCREEN

- 1 Touch “Dest” on the map.
- 2 Touch “My Destinations”.



‘ The “My Destinations” screen can be displayed by touching  on any of the “Navigation” screens.

- 3 Touch “Stored” on the “My Destinations” screen.
- 4 Touch “Create New Entry”.



- 5 Input the entry address. (See page 35.)



- 6 Touch “Save New Entry”.

- 7 Input the entry name.



- 8 Touch “OK”.

- 9 The entry is saved in the “Stored” list.



‘ Touch  to display and edit the entry information. (See page 58.)

■ REGISTERING "Home"

If **"Home"** has not been registered, touching **"Home"** allows a home address to be registered.

- 1 Touch **"Home"**.

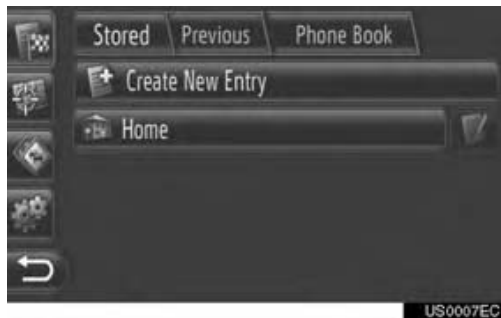

- 2 Touch **"Yes"**.



- 3 Touch the desired method to search the point.

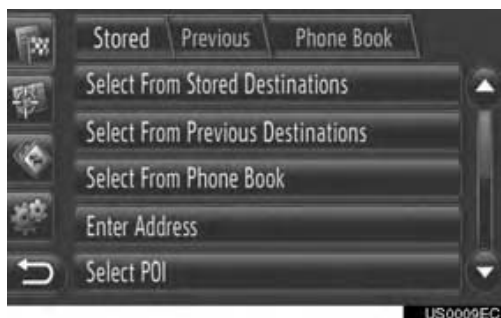

- ‘ For details about searching the point on the map, see page 33.

- i If you search the destination by **"Enter Address"**

- 4 Touch **"Save as Home Address"**.

- i If you search the destination by **"Select Point on Map"** or **"Enter Geo-coordinates"**

- 4 Touch **"Save"**.

- i If you search the destination by the other methods

- 4 Touch the desired entry from the list.

- 5 The entry is registered as **"Home"** in the **"Stored"** list.

‘ Touch  to display and edit the entry information. (See page 58.)

REGISTERING FROM THE MAP

- 1 Touch the desired point on the map.
- 2 Touch **“Save”**.



- 3 Follow the steps **“REGISTERING FROM THE “My Destinations” SCREEN”** from **“STEP 7”**. (See page 52.)

REGISTERING FROM POI

- 1 Search the point by **“POI”**. (See pages 32 and 36.)
- 2 Touch **“Save”**.

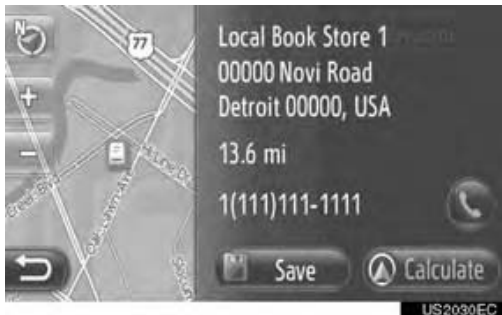

- 3 Follow the steps **“REGISTERING FROM THE “My Destinations” SCREEN”** from **“STEP 7”**. (See page 52.)

REGISTERING FROM THE LIST

REGISTERING FROM THE LIST ON THE “Previous” OR “Phone Book” SCREEN

- 1 Search the point by **“Previous”** or **“Phone Book”**. (See pages 34 and 34.)
- 2 Touch  next to the desired item.



- 3 Touch **“Add to Stored Destinations”**.

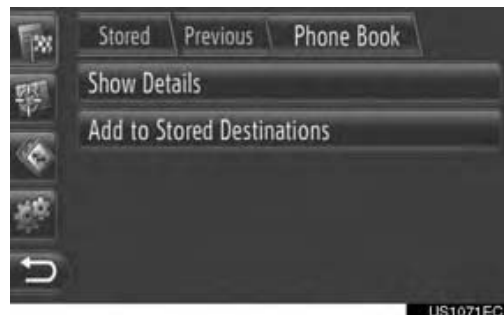

- 4 Follow the steps **“REGISTERING FROM THE “My Destinations” SCREEN”** from **“STEP 7”**. (See page 52.)

INFORMATION

- If the contact includes an address and a phone number, they will be stored in the **“Stored”** list on the **“My Destinations”** screen and **“Contacts”** screen. (See pages 52 and 165.)

REGISTERING FROM THE DESTINATION LIST

- 1 Display the “Show Destination List” screen. (See page 50.)
- 2 Touch the desired destination.



- 3 Touch “Add to Stored Destinations”.



- 4 Follow the steps “REGISTERING FROM THE “My Destinations” SCREEN” from “STEP 7”. (See page 52.)

REGISTERING FROM GEO-COORDINATES

- 1 Search the point by “Enter Geo-coordinates”. (See page 41.)
- 2 Touch “Save”.



- 3 Follow the steps “REGISTERING FROM THE “My Destinations” SCREEN” from “STEP 7”. (See page 52.)

REGISTERING FROM AN EXTERNAL DEVICE

“vCard” formatted data can be transferred from a USB memory to this system. Transferred addresses and numbers will be stored in the “Stored” list on the “My Destinations” screen and “Contacts” screen. (See pages 52 and 165.)

LOADING ADDRESSES VIA A USB MEMORY

- 1 Open the cover of the USB/AUX port and connect a USB memory.

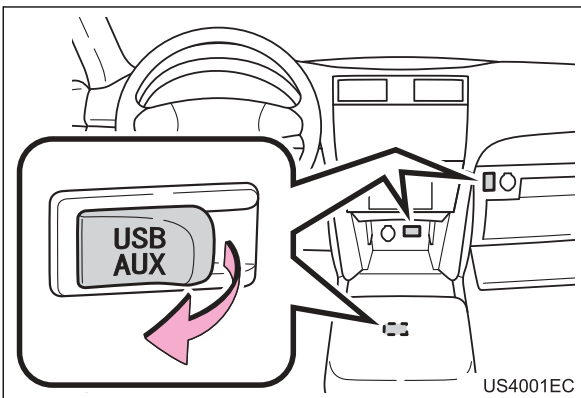

The USB/AUX port is located on the instrument panel, or in the console box or glove box etc. The location and design are different depending on the vehicle. For details, see the Pictorial index of “Owner’s Manual”.

- 2 Touch “Dest” on the map.
- 3 Touch “Enter Destination”.



The “Enter Destination” screen can be displayed by touching  on any of the “Navigation” screens.

- 4 Touch “Advanced” on the “Enter Destination” screen.
- 5 Touch “Load Contacts from USB”.



- 6 The following screen will be displayed while loading the data.



- To cancel this function, touch “Cancel”.
- 7 The following screen will be displayed when loading is complete.

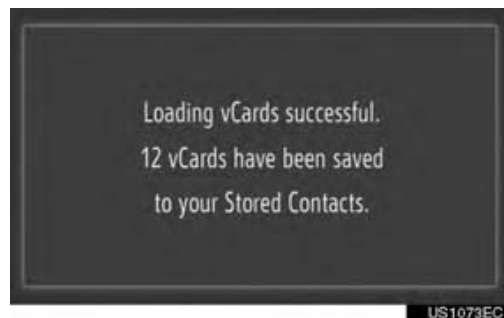

- 8 The entry is registered in the “Stored” list on the “My Destinations” screen and “Contacts” screen. (See pages 52 and 165.)

NOTICE

- Do not turn off the engine while downloading.

INFORMATION

- If a message similar to the one below is displayed, delete X item(s) in the “Stored” list on the “My Destinations” screen and “Contacts” screen to make room for the new destination(s). (See pages 58 and 168.)



LOADING ADDRESSES FROM A PHONE

Address and number will be stored in the “Stored” list on the “My Destinations” screen and “Contacts” screen. (See pages 52 and 165.) For detailed information about “Load Addresses from Phone”, see page 91.

2. DISPLAYING AND EDITING THE ENTRY INFORMATION

DISPLAYING AND EDITING THE ENTRY INFORMATION

Detailed information of entries in the list can be displayed or edited.

- 1 Touch  next to the desired item on the “My Destinations” screen.

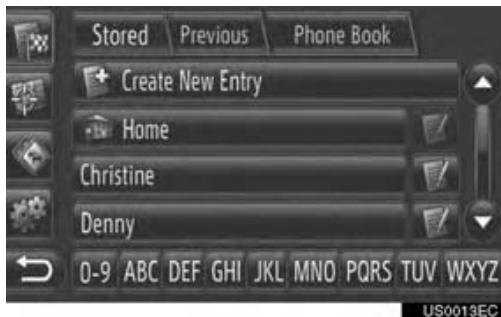

- i The entry options screen of “Stored” list

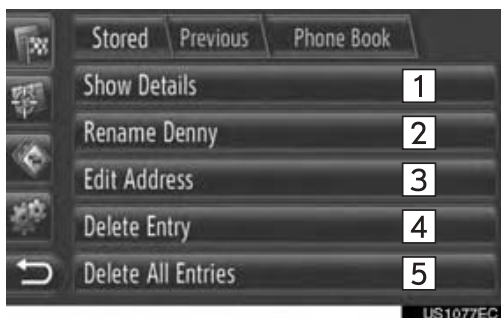

- i The entry options screen of “Previous” list

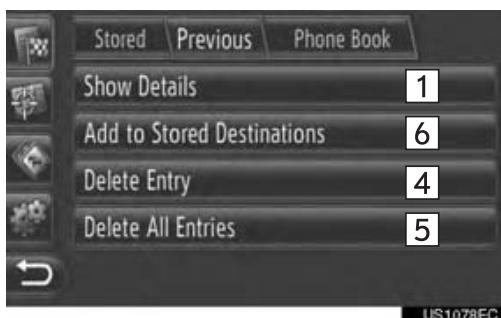

- i The entry options screen of “Phone Book” list

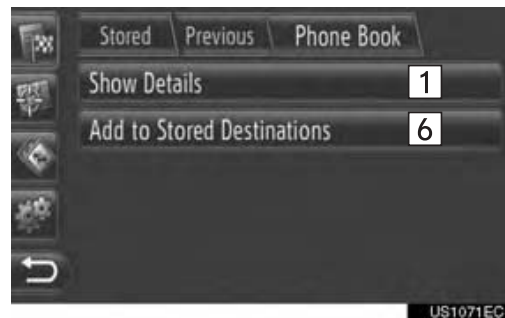

- i On this screen, the following functions can be operated.

NO.	Function
1	Touch to display the details of the entry information. (See page 59.)
2	Touch to change the entry name. (See page 59.)
3	Touch to edit the address. (See page 59.)
4	Touch to delete the entry.
5	Touch to delete all entries.
6	Touch to register the entry in the “Stored” list on the “My Destinations” screen and “Contacts” screen. (See page 54.)

SHOW DETAILS OF THE ENTRY

- 1 Touch **“Show Details”** on the entry options screen.
- 2 This screen will be displayed.



- The address will be marked on the map.
- The address and a picture, if available, of the contact from the system's phone book will be displayed.

- When you touch **“Start”**, the starting route guidance screen will be displayed.

CHANGING THE ENTRY NAME

- 1 Touch **“Rename XX”** on the entry options screen.
- 2 Input the new name.



- 3 Touch **“OK”**.

INFORMATION

- This function cannot be operated while driving.

EDITING THE ADDRESS

- 1 Touch **“Edit Address”** on the entry options screen.
- 2 Input the new address. (See page 35.)



- 3 Touch **“Save Changes”**.

INFORMATION

- This function cannot be operated while driving.
- If an entry that is transferred from a cellular phone is edited, the change will affect the entry in the “Stored” list on the “My Destinations” screen and “Contacts” screen. (See pages 52 and 165.)

3. SENDING STORED CONTACTS TO A USB MEMORY

SENDING STORED CONTACTS TO A USB MEMORY

The entries stored in the “Stored” list on the “My Destinations” screen and “Contacts” screen (See pages 52 and 165.) can be transferred to a USB memory.

- 1 Open the cover of the USB/AUX port and connect a USB memory.

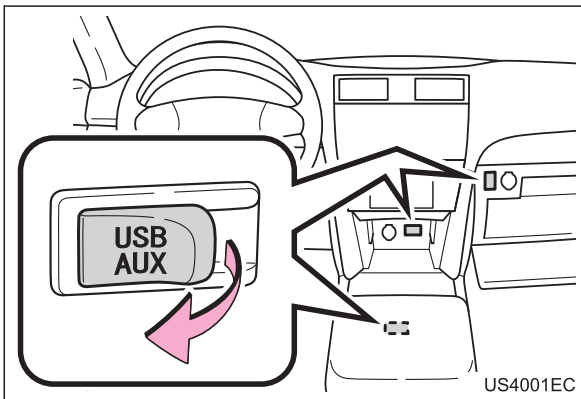

The USB/AUX port is located on the instrument panel, or in the console box or glove box etc. The location and design are different depending on the vehicle. For details, see the Pictorial index of “Owner’s Manual”.

- 2 Press the “SETUP” button.

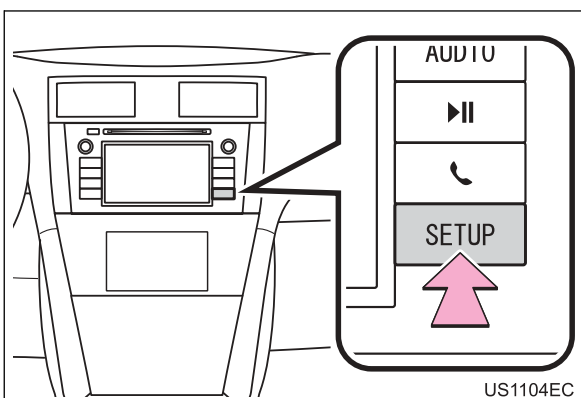

- 3 Touch “General”.

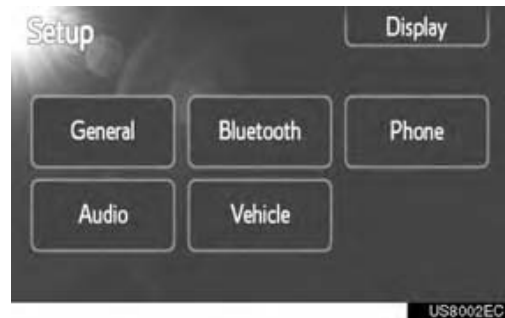

- 4 Touch “Send Stored Contacts to USB”.



- 5 The following screen will be displayed while sending the data.



To cancel this function, touch “Cancel”.

- 6 The following screen will be displayed when sending data to the USB memory is complete.



1. MAP SETTINGS

SETTING THE MAP

1 Touch “Options”.



2 Touch “Map Settings”.

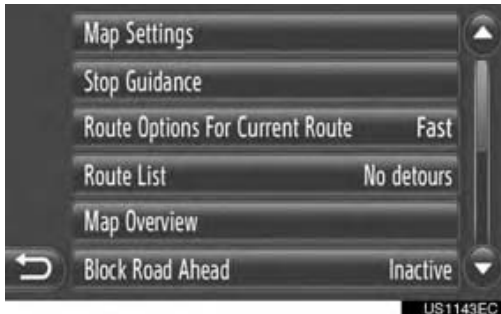

3 Touch the item to be set.

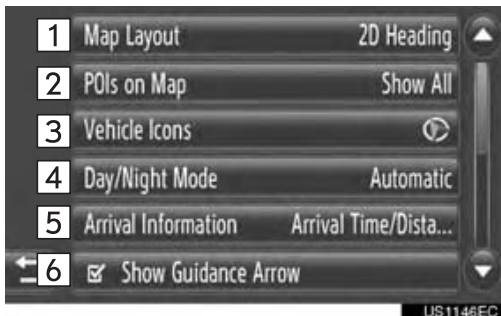

On this screen, the following functions can be set.

No.	Function
1	Touch to change the map layout. (See page 28.)
2	Touch to set the display of POI icon categories. (See page 62.)
3	Touch to change the vehicle icon. (See page 62.)
4	Touch to change the screen to “Day” or “Night”. (See page 63.)
5	Touch to change the estimated time between “Arrival Time/Distance” and “Remaining Time/Distance” to the destination. (See page 63.)
6	Touch to set the display of the route guidance arrow on or off. (See page 44.)
7	Touch to set the display of the name of the road currently being travelled on to on or off. (See page 44.)
8	Touch to set the display of signposts on or off. (See page 44.)
9	Touch to set the display of the lane recommendation on or off. (See page 44.)
10	Touch to set the display of the traffic message icons on or off. (See page 44.)

2

APPLICATION-“Map”

INFORMATION

- The current setting of each item is displayed on its right.
- Selected item’s checkboxes will change to  when the item has been selected. All selected items will be activated simultaneously.

POIS ON MAP

POI categories displayed on the map can be selected.

- 1 Touch “**POIs on Map**” on the “Map Settings” screen.
- 2 Select the POI categories.



On this screen, the following functions can be operated.

No.	Function
1	Touch to display all categories.
2	Touch to hide all icons.
3	Touch to display the selected icons.
4	Touch to select items from other categories.

- 3 Touch .

VEHICLE ICONS

The vehicle icon can be changed.

- 1 Touch “**Vehicle Icons**” on the “Map Settings” screen.
- 2 Touch the desired icon.

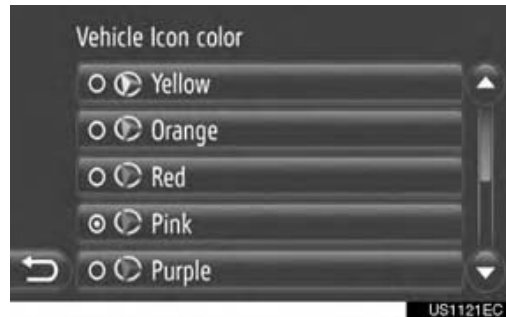

- 3 Touch .

DAY/NIGHT MODE

The screen can be changed to day mode or night mode.

- 1 Touch **“Day/Night Mode”** on the “Map Settings” screen.
- 2 Touch the desired item.

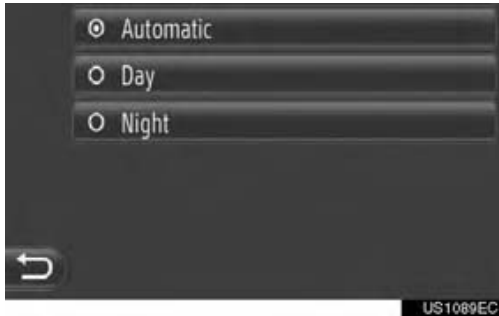

“Automatic”: Touch to change the screen to day or night mode depending on the position of the headlight switch.

“Day”: Touch to always display the map in day mode.

“Night”: Touch to always display the map in night mode.

- 3 Touch .

ARRIVAL INFORMATION

The estimated time to the destination can be changed between arrival time/distance and remaining time/distance. It can also be turned off.

- 1 Touch **“Arrival Information”** on the “Map Settings” screen.
- 2 Touch the desired item.



“Off”: Touch to turn off the estimated time/distance.

“Arrival Time/Distance”: Touch to display the arrival time in the upper right area of the map. The distance to the destination will also be displayed.

“Remaining Time/Distance”: Touch to display the remaining time to reach the destination in the upper right area of the map. The distance to the destination will also be displayed.

- 3 Touch .

2. ROUTE SETTINGS

SETTING THE ROUTE
OPTIONSSETTING THE ROUTE
CALCULATION

The route preferences for the route calculation can be set.

- 1 Touch **“Dest”** on the map.
- 2 Touch **“Route Options”**.



The “Route Options” screen can be displayed by touching  on any of the “Navigation” screens.

- 3 Touch **“Preferences”** on the “Route Options” screen.
- 4 Touch the desired item.

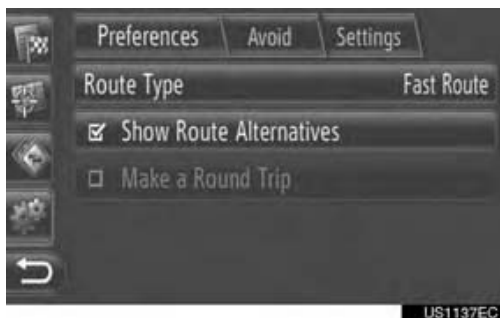

“Route Type”: Touch to select the route type between **“Fast Route”**, **“Short Route”** and **“Ecological Route”**.

“Show Route Alternatives”: Touch to display 3 routes (fastest, shortest and ecological) on the map after a route calculation.

“Make a Round Trip”: Touch to have the route automatically calculated back to the starting point after the set destination has been reached.

Entered waypoints will also be considered on the way back to the starting point.

- 5 Touch .

INFORMATION

- **“Show Route Alternatives”** and **“Make a Round Trip”** are not selectable at the same time.

SETTING THE AVOIDANCE CRITERIA FOR THE ROUTE CALCULATION

The avoidance criteria for the route calculation can be set.

- 1 Touch “**Dest**” on the map.
- 2 Touch “**Route Options**”.



- The “Route Options” screen can be displayed by touching  on any of the “Navigation” screens.

- 3 Touch “**Avoid**” on the “Route Options” screen.
- 4 Touch the desired item.



“**Avoid Freeways**”: Touch to avoid freeways.

“**Avoid Toll Roads**”: Touch to avoid toll roads.

“**Avoid Tunnels**”: Touch to avoid tunnels.

“**Avoid Ferries**”: Touch to avoid ferries.

“**Avoid Border Crossings**”: Touch to avoid border crossings.

- 5 Touch .

1. LIMITATIONS OF THE NAVIGATION SYSTEM

This navigation system calculates the current vehicle position using satellite signals, various vehicle signals, map data, etc. However, an accurate position may not be shown depending on satellite condition, road configuration, vehicle condition or other circumstances.

The Global Positioning System (GPS) developed and operated by the U.S. Department of Defense provides an accurate current vehicle position, normally using 4 or more satellites, and in some case 3 satellites. The GPS system has a certain level of inaccuracy. While the navigation system will compensate for this most of the time, occasional positioning errors of up to 300 feet (100 m) can and should be expected. Generally, position errors will be corrected within a few seconds.



The GPS signal may be physically obstructed, leading to inaccurate vehicle position on the map display. Tunnels, tall buildings, trucks, or even the placement of objects on the instrument panel may obstruct the GPS signals.

The GPS satellites may not send signals due to repairs or improvements being made to them.

Even when the navigation system is receiving clear GPS signals, the vehicle position may not be shown accurately or inappropriate route guidance may occur in some cases.



NOTICE

- The installation of window tinting may obstruct the GPS signals. Most window tinting contains some metallic content that will interfere with GPS signal reception of the antenna. We advise against the use of window tinting on vehicles equipped with navigation systems.
- Accurate current vehicle position may not be shown in the following cases:
- When driving on a small angled Y-shaped road.
 - When driving on a winding road.
 - When driving on a slippery road such as in sand, gravel, snow, etc.
 - When driving on a long straight road.
 - When motorway and surface streets run in parallel.
 - After moving by ferry or vehicle carrier.
 - When a long route is searched during high speed driving.
 - When driving without setting the current position calibration correctly.
 - After repeating a change of direction by going forward and backward, or turning on a turntable in the parking lot.
 - When leaving a covered parking lot or parking garage.
 - When a roof carrier is installed.
 - When driving with tire chains installed.
 - When the tires are worn.
 - After replacing a tire or tires.
 - When using tires that are smaller or larger than the factory specifications.
 - When the tire pressure in any of the four tires is not correct.

Inappropriate route guidance may occur in the following cases:

- When turning at an intersection off the designated route guidance.
- If you set more than one destination but skip one of them, auto reroute will display a route returning to the destination that was skipped.
- When turning at an intersection for which there is no route guidance.
- When passing through an intersection for which there is no route guidance.
- During auto reroute, the route guidance may not be available for the next turn to the right or left.
- It may take a long time to operate auto reroute during high speed driving. In auto reroute, a detour route may be shown.
- After auto reroute, the route may not be changed.
- An unnecessary U-turn may be shown or announced.
- A location may have multiple names and the system will announce one or more.
- Some routes may not be searched.
- If the route to your destination includes gravel, unpaved roads or alleys, the route guidance may not be shown.
- Your destination point might be shown on the opposite side of the street.
- When a portion of the route has regulations prohibiting the entry of the vehicle that vary by time or season or other reasons.
- The road and map data stored in the navigation system may not be complete or may not be the latest version.

INFORMATION

- This navigation system uses tire turning data and is designed to work with factory-specified tires for the vehicle. Installing tires that are larger or smaller than the originally equipped diameter may cause inaccurate display of the current vehicle position. The tire pressure also affects the diameter of the tires so make sure the tire pressure of all four tires is correct.

2. MAP INFORMATION

END-USER TERMS

The data ("Data") is provided for your personal, internal use only and not for resale. It is protected by copyright, and is subject to the following terms and conditions which are agreed to by you, on the one hand, and Harman ("Harman") and its licensors (including their licensors and suppliers) on the other hand.

© 2011 NAVTEQ B.V., © Bundesamt für Eich- und Vermessungswesen, © EuroGeographics, source: © IGN 2009 – BD TOPO[®], Die Grundlagendaten wurden mit Genehmigung der zuständigen Behörden entnommen, Contains Ordnance Survey data © Crown copyright and database right 2010 Contains Royal Mail data © Royal Mail copyright and database right 2010, Copyright Geomatics Ltd., Copyright © 2003; Top-Map Ltd., La Banca Dati Italiana è stata prodotta usando quale riferimento anche cartografia numerica ed al tratto prodotta e fornita dalla Regione Toscana., Copyright © 2000; Norwegian Mapping Authority, Source: IgeoE – Portugal, Información geográfica propiedad del CNIG, Based upon electronic data Ó National Land Survey Sweden., Topografische Grundlage: Ó Bundesamt für Landestopographie.. All rights reserved.

TERMS AND CONDITIONS

PLEASE READ THIS END USER LICENSE AGREEMENT CAREFULLY BEFORE USING THE NAVTEQ DATABASE

NOTICE TO THE USER

THIS IS A LICENSE AGREEMENT - AND NOT AN AGREEMENT FOR SALE – BETWEEN YOU AND NAVTEQ B.V. FOR YOUR COPY OF THE NAVTEQ NAVIGABLE MAP DATA-BASE, INCLUDING ASSOCIATED COMPUTER SOFTWARE, MEDIA AND EXPLANATORY PRINTED DOCUMENTATION PUBLISHED BY NAVTEQ (JOINTLY "THE DATABASE"). BY USING THE DATABASE, YOU ACCEPT AND AGREE TO ALL TERMS AND CONDITIONS OF THIS END USER LICENSE AGREEMENT ("AGREEMENT"). IF YOU DO NOT AGREE TO THE TERMS OF THIS AGREEMENT, PROMPTLY RETURN THE DATABASE, ALONG WITH ALL OTHER ACCOMPANYING ITEMS, TO YOUR SUPPLIER FOR A REFUND.

OWNERSHIP

The Database and the copyrights and intellectual property or neighboring rights therein are owned by NAVTEQ or its licensors. Ownership of the media on which the Database is contained is retained by NAVTEQ and/or your supplier until after you have paid in full any amounts due to NAVTEQ and/or your supplier pursuant to this Agreement or similar agreement(s) under which goods are provided to you.

LICENSE GRANT

NAVTEQ grants you a non-exclusive license to use the Database for your personal use or, if applicable, for use in your business' internal operations. This license does not include the right to grant sub-licenses.

LIMITATIONS ON USE

The Database is restricted for use in the specific system for which it was created. Except to the extent explicitly permitted by mandatory laws (e.g. national laws based on the European Software Directive (91/250) and the Database Directive (96/9)), you may not extract or reutilize substantial parts of the contents of the Database nor reproduce, copy, modify, adapt, translate, disassemble, decompile, reverse engineer any portion of the Database. If you wish to obtain interoperability information as meant in (the national laws based on) the European Software Directive, you shall grant NAVTEQ reasonable opportunity to provide said information on reasonable terms, including costs, to be determined by NAVTEQ.

TRANSFER OF LICENSE

You may not transfer the Database to third parties, except when installed in the system for which it was created or when you do not retain any copy of the Database, and provided that the transferee agrees to all terms and conditions of this Agreement and confirms this in writing to NAVTEQ. Multi-disc sets may only be transferred or sold as a complete set as provided by NAVTEQ and not as subset thereof.

LIMITED WARRANTY

NAVTEQ warrants that, subject to the warnings set out below, for a period of 12 months after acquisition of your copy of the Database, it will perform substantially in accordance with NAVTEQ's Criteria for Accuracy and Completeness existing on the date you acquired the Database; these criteria are available from NAVTEQ at your request. If the Database does not perform in accordance with this limited warranty, NAVTEQ will use reasonable efforts to repair or replace your non-conforming copy of the Database. If these efforts do not lead to performance of the Database in accordance with the warranties set out herein, you will have the option to either receive a reasonable refund of the price you paid for the Database or to rescind this Agreement. This shall be NAVTEQ's entire liability and your sole remedy against NAVTEQ. Except as expressly provided in this section, NAVTEQ does not warrant nor make any representations regarding the use of results of the use of the Database in terms of its correctness, accuracy, reliability, or otherwise. NAVTEQ does not warrant that the Database is or will be error free. No oral or written information or advice provided by NAVTEQ, your supplier or any other person shall create a warranty or in any way increase the scope of the limited warranty described above. The limited warranty set forth in this Agreement does not affect or prejudice any statutory legal rights that you may have under the legal warranty against hidden defects.

If you did not acquire the Database from NAVTEQ directly, you may have statutory rights against the person from whom you have acquired the Database in addition to the rights granted by NAVTEQ hereunder according to the law of your jurisdiction. The above warranty of NAVTEQ shall not affect such statutory rights and you may assert such rights in addition to the warranty rights granted herein.

LIMITATION OF LIABILITY

The price of the Database does not include any consideration for assumption of risk of consequential, indirect or unlimited direct damages which may arise in connection with your use of the Database. Accordingly, in no event shall NAVTEQ be liable for any consequential or indirect damages, including without limitation, loss of revenue, data, or use, incurred by you or any third party arising out of your use of the Database, whether in an action in contract or tort or based on a warranty, even if NAVTEQ has been advised of the possibility of such damages. In any event NAVTEQ's liability for direct damages is limited to the price of your copy of the Database.

THE LIMITED WARRANTY AND LIMITATION OF LIABILITY, SET FORTH IN THIS AGREEMENT, DO NOT AFFECT OR PREJUDICE YOUR STATUTORY RIGHTS WHERE YOU HAVE ACQUIRED THE DATABASE OTHERWISE THAN IN THE COURSE OF A BUSINESS.

WARNINGS

The Database may contain inaccurate or incomplete information due to the passage of time, changing circumstances, sources used and the nature of collecting comprehensive geographic data, any of which may lead to incorrect results. The Database does not include or reflect information on - inter alia - neighborhood safety; law enforcement; emergency assistance; construction work; road or lane closures; vehicle or speed restrictions; road slope or grade; bridge height, weight or other limits; road or traffic conditions; special events; traffic congestion; or travel time.

GOVERNING LAW

This Agreement shall be governed by the laws of the jurisdiction, in which you reside at the date of acquisition of the Database. Should you at that moment reside outside the European Union or Switzerland, the law of the jurisdiction within the European Union or Switzerland where you acquired the Database shall apply. In all other cases, or if the jurisdiction where you acquired the Database cannot be defined, the laws of the Netherlands shall apply. The courts competent at your place of residence at the time you acquired the Database shall have jurisdiction over any dispute arising out of, or relating to this Agreement, without prejudice to NAVTEQ' right to bring claims at your then current place of residence.

APPLICATION-THE OTHERS

1 APPLICATIONS OPERATION

- 1. QUICK REFERENCE..... 74**
- 2. PICTURE SLIDESHOW 75**
 - DISPLAYING THE PICTURES..... 75
 - PLAYING PICTURE SLIDESHOWS 76
- 3. EMAIL 77**
 - RECEIVING A NEW EMAIL 77
 - CHECKING "Email" 77
- 4. CALENDAR 79**
 - CHECKING CALENDAR 79

2 ENTUNE SERVICE

- 1. ENTUNE SERVICE 80**
 - BEFORE USING ENTUNE 80
 - AVAILABILITY OF SERVICE..... 82
 - INITIALIZING PERSONAL DATA 82
- 2. OPERATING NAVIGATION
FUNCTION USING ENTUNE
SERVICE 83**
 - ONLINE SEARCH..... 83
 - FUEL PRICES 85
 - TRAFFIC MESSAGES..... 86
 - LOADING ADDRESSES FROM A
PHONE..... 91
- 3. OPERATING AN APPLICATION
USING ENTUNE SERVICE 93**
 - OPERATING AN APPLICATION 93
 - IF A MESSAGE APPEARS ON THE
SCREEN 95

1

2

3

4

5

6

7

8

9

1. APPLICATIONS OPERATION

1. QUICK REFERENCE

The navigation application and several other applications can be accessed by pressing the “**APPS**” button.

When the “**APPS**” button is pressed, the “Applications” menu screen that was last displayed is returned to. Touch  to display the “Applications” menu screen.

i “Applications” menu screen

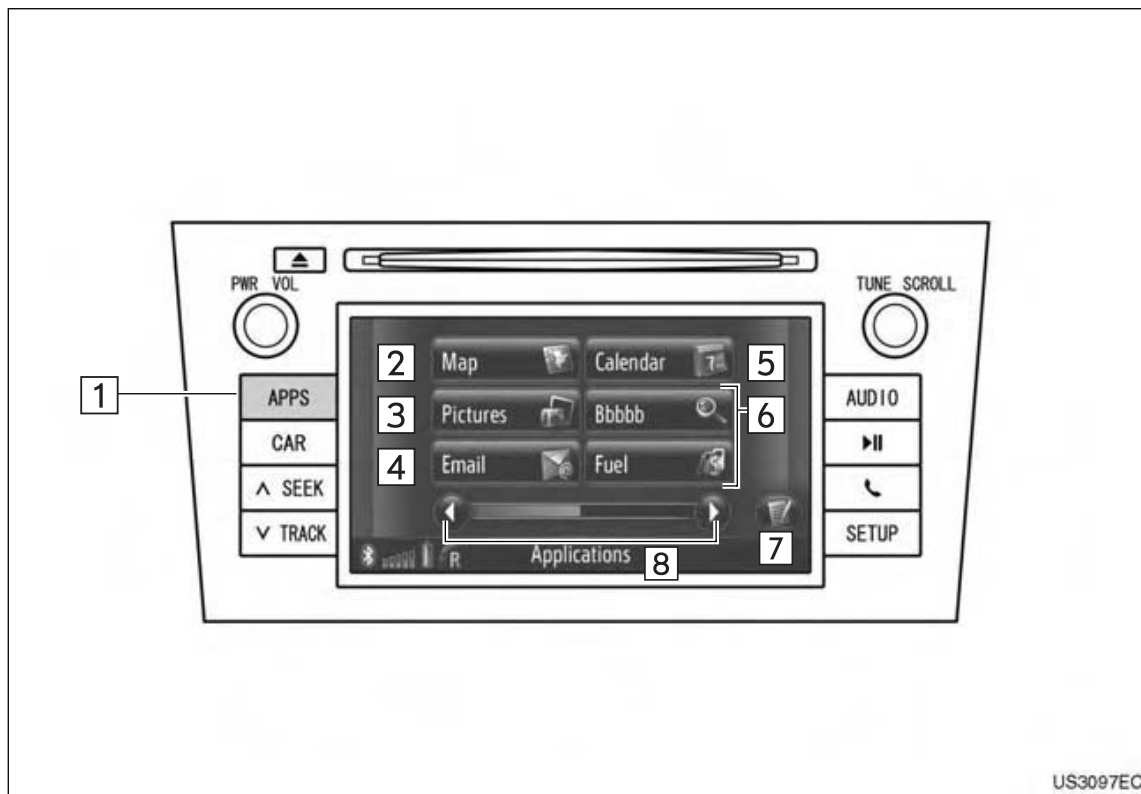

No.	Function	Page
1	Press to display a list of applications.	∞
2	“Map” provides the user with navigation, route calculation, destination entry (manually or via voice recognition), turn by turn directions, and real-time traffic.	25
3	Touch to view pictures stored on a USB memory.	75
4	Touch to display Emails.	77
5	Touch to access the connected phone’s calendar, tasks and notes.	79
6	Touch to access the applications.	83, 85, 93
7	Touch to close or delete the applications.	93, 94
8	Touch to shift to the next or previous page.	∞

2. PICTURE SLIDESHOW

When the vehicle is stopped, pictures stored on a USB memory can be viewed.



INFORMATION

- Images cannot be viewed while driving.
- When the vehicle starts moving while viewing pictures, a pop-up window will be displayed and pictures cannot be displayed. Touch **“Previous”** to return to the previous screen.
- Available image data format: JPEG, PNG and BMP

DISPLAYING THE PICTURES

- 1 Open the cover of the USB/AUX port and connect a USB memory.

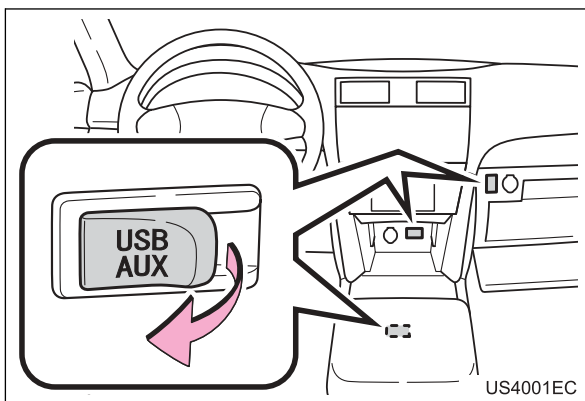

The USB/AUX port is located on the instrument panel, or in the console box or glove box etc. The location and design are different depending on the vehicle. For details, see the Pictorial index of *“Owner’s Manual”*.

- 2 Press the **“APPS”** button to display the **“Applications”** menu screen.

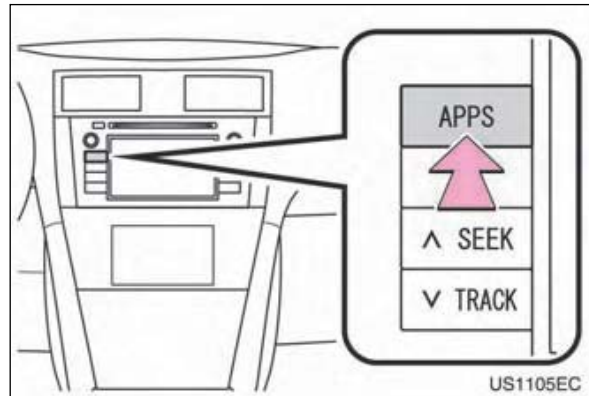

- If the **“Applications”** menu screen is not displayed, touch  until it is displayed.

- 3 Touch **“Pictures”**.



- 4 The slideshow starts automatically.



: Touch to stop the slideshow.

INFORMATION

- All readable pictures on the device are displayed in chronological order. The slideshow will repeat when it is finished.
- The pictures will be changed every few seconds.

PLAYING PICTURE SLIDESHOWS

A slideshow can be played, paused, and desired images can be selected.

- 1 Touch **“Show”**.



- 2 Operating switches will be displayed.

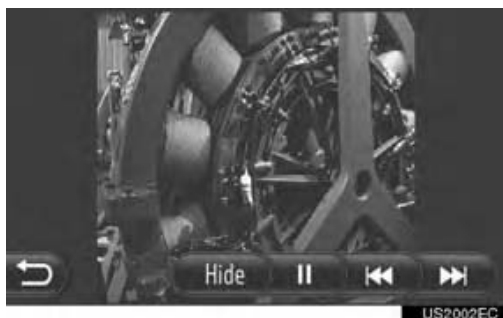

“Hide”: Touch to close the slideshow options.



: Touch to pause the slideshow.



: Touch to play the slideshow again.



: Touch to display the previous picture.



: Touch to display the next picture.

INFORMATION

- When the slideshow is playing, the pause and skip screen buttons disappear automatically after a few seconds.

3. EMAIL

Incoming Emails to a connected Bluetooth® capable phone can be downloaded. Before using this application, connect the Bluetooth® phone with phone profile. (See page 203.)

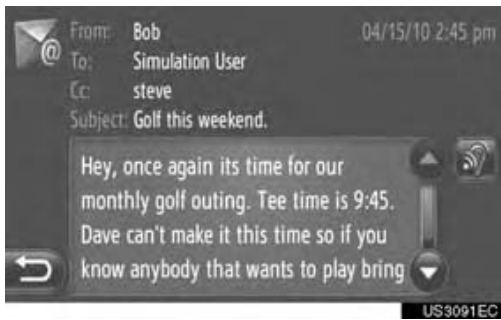

RECEIVING A NEW EMAIL

When a new Email is received, a pop-up window is displayed on the screen.



This function can be set to “On” or “Off”. (See page 209.)

CHECKING “Email”

1 Press the “APPS” button to display the “Applications” menu screen.

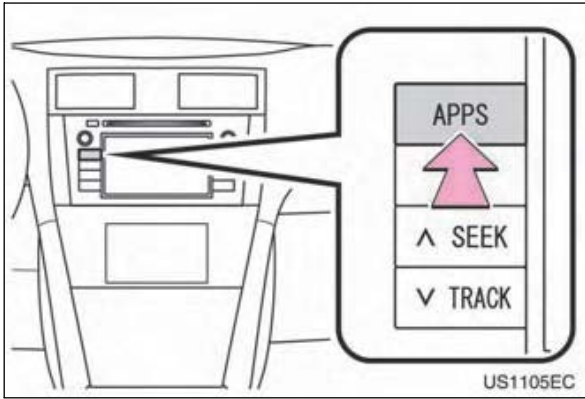

If the “Applications” menu screen is not displayed, touch  until it is displayed.

2 Touch “Email”.



When the downloading of an Email has been completed, the mail list will be displayed.

3 Touch the desired Email.



The state of Email is shown by the following icons.

 : Unread mail

 : Read mail

 : Important mail

4 The text of the Email is displayed.

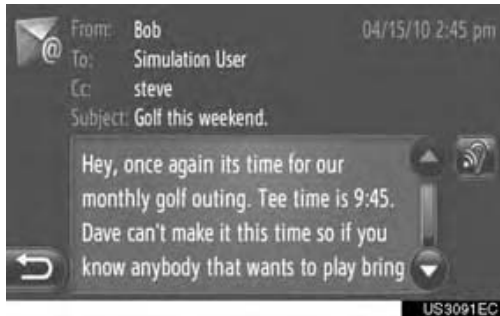

 : Touch to have the Email read out.

To cancel this function, touch .



NOTICE

- Do not turn off the engine while downloading.

INFORMATION

- Email cannot be sent.

4. CALENDAR

Calendar entries, tasks and notes from a connected Bluetooth® capable phone can be downloaded. Before using this application, connect the Bluetooth® phone with phone profile. (See page 203.)



When the downloading of the calendar is complete, the current day's calendar entries will be displayed.

3 When a displayed schedule entry is touched, the entry's detailed information is displayed.

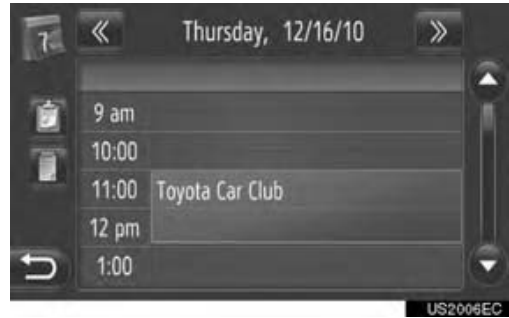

CHECKING CALENDAR

1 Press the "APPS" button to display the "Applications" menu screen.

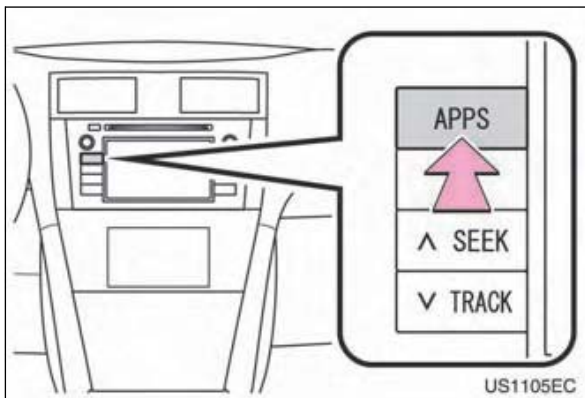



If the "Applications" menu screen is not displayed, touch  until it is displayed.

2 Touch "Calendar".



: Touch to display the previous day's schedule.

: Touch to display the following day's schedule.

: Touch to display the current day's tasks.

: Touch to display the notes.

 NOTICE

Do not turn off the engine while downloading.

INFORMATION

Calendar entries cannot be edited.

1. ENTUNE SERVICE¹

BEFORE USING ENTUNE

USER REGISTRATION

When purchasing the vehicle, an email address is registered at your Toyota dealer. If your email address was not registered at your Toyota dealer, your email address can be registered at the Entune website. A user registration guidance email containing a web address will be sent.

- 1 Perform user registration from the designated web address.

LOGIN PROCESS TO ENTUNE SERVICE

If the following screen is displayed when you use the Entune service, enter the login information.

- 1 Touch “enTune Username”.



- 2 Input the username and then touch “OK”.

- 3 Touch “enTune Password”.



- 4 Input the password and then touch “OK”.

- 5 Touch “Confirm Login Information”.



- When “Remember Password” is on, the entered user login information will be remembered for every login.

¹: Entune is available in the 48 states, D.C. and Alaska.

REGISTERING THE DOWNLOADED ENTUNE APPLICATION

- 1 Download the Entune application using your cellular phone.
- 2 Run the Entune application on your cellular phone.
- 3 Enter a user name and password into the Entune application on your cellular phone.

INFORMATION

- If your email address was not registered at your Toyota dealer when the vehicle was purchased, an email address can be registered at <http://www.toyota.com/entune/>.
- Entune operational procedures can also be confirmed by visiting <http://www.toyota.com/entune/>.
- This system supports the following service.
 - Bluetooth® Specification
Ver.1.1 or higher
(Recommended: Ver.2.1 + EDR or higher)
 - Profiles
HFP (Hands Free Profile)
Ver.1.0 or higher
(Recommended: Ver.1.5 or higher)
DUN (Dial-Up Networking Profile)
Ver.1.1 or higher
PAN (Personal Area Network)
Ver. 1.0
PBAP (Phone Book Access Profile)
Ver.1.0 or higher
SSP (Serial Port Profile)
MAP (Message Access Profile)
 - Application
PIM (Personal Information Manager)
- If your cellular phone does not support HFP, you cannot register the Bluetooth® phone, or use DUN/PAN or PBAP profiles individually.
- If the connected Bluetooth® phone version is older than recommended or incompatible, this function may not be used.

AVAILABILITY OF SERVICE

- Entune is available in the 48 states, D.C. and Alaska.

INFORMATION

- When using Entune, depending on the details of your cellular phone contract, data usage fees may apply. Confirm data usage fees before using this service.
- In this section, the required operations to activate application, connect a cellular phone to the navigation system and registration steps for Entune are explained. For details regarding Entune operations and each of the application, refer to <http://www.toyota.com/entune/>.

INITIALIZING PERSONAL DATA

The personal data used in application can be reset. (See “DELETE PERSONAL DATA” on page 199.)

- The following personal data can be deleted and returned to their default settings:
 - Downloaded contents
 - Radio stations that were listened to
 - Input history

INFORMATION

- Once initialized, data will be erased. Pay close attention when initializing the data.

ONLINE SEARCH

A destination can be selected via on-line search.

Before using this function, connect a Bluetooth® phone with an internet profile. (See page 203.)

- 1 Touch “Dest” on the map.
- 2 Touch “Enter Destination”.



The “Enter Destination” screen can be displayed by touching  on any of the “Navigation” screens.

- 3 Touch “POI” on the “Enter Destination” screen.
- 4 Touch “Online Search by Xxxx”.



- Online search can be entered on the “Applications” menu screen.
- When the following screen is displayed, enter the user login information and then touch “Confirm Login Information”. (See page 80.)



- When the cost warning or roaming warning screen is displayed, touch “Continue”. This function can be set to on or off. (See page 208.)

- 5 Touch “Search Area”.

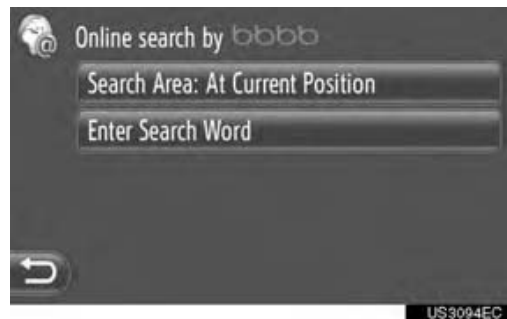

- 6 Select the desired search area.



“At Current Position”: Touch to define the area at the current position.

“Define City”: Touch to define the area by city name. Input the city name and then touch “OK”.

“From Map”: Touch to define the area on map. Touch the desired city on the map and then touch “Select”.

“At Destination”: Touch to define the area around the main destination. When route guidance is not in use, “At Destination” cannot be selected.

7 Touch “**Enter Search Word**”.

8 Input the search word and then touch “**OK**”.



9 The search results will be displayed. Touch the desired item.



Up to 20 items will be searched when performing an online search.

“**Download More**”: Touch to search up to 20 new items. Up to 60 items can be downloaded.

“**Previous Results**”: Touch to display the previous result.

“**Next Results**”: Touch to display the next result.

10 Touch “**Calculate**”.



“**Details**”: Touch to display the details of the point information.

: Touch to call the registered telephone number.

11 The starting route guidance screen will be displayed. (See page 42.)

INFORMATION

- The color of  indicates if online connection is active or not. After a timeout of 1 minute, an active online connection will automatically be terminated.

FUEL PRICES

It enables the navigation system to display current fuel prices and gas station locations, which can be set as a destination if desired.

Before using this function, connect a Bluetooth® phone with an internet profile. (See page 203.)

- 1 Touch “**Dest**” on the map.
- 2 Touch “**Enter Destination**”.



- ‘ The “Enter Destination” screen can be displayed by touching  on any of the “Navigation” screens.
- 3 Touch “**POI**” on the “Enter Destination” screen.
 - 4 Touch “**Fuel Prices**” on the “POI” screen.
- ‘ When the login information screen is displayed, enter the user login information and then touch “**Confirm Login Information**”. (See page 80.)
 - ‘ When the cost warning or roaming warning screen is displayed, touch “**Continue**”. This function can be set to on or off. (See page 208.)

- 5 Touch  for the desired item.





- ‘ On this screen, the following functions can be operated.

No.	Function
1	Touch to display search result list sorted by company brand.
2	Touch to display search result list sorted by the price.
3	Touch to display search result list sorted by the distance.
4	Touch to select the desired fuel type.

- ‘ If you touch the desired item, the starting route guidance screen will be displayed directly. (See page 42.)

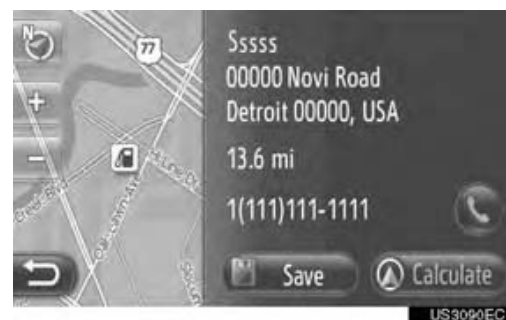
- 6 Touch “**Calculate**”.



- ‘ When “**Save**” is touched, the point is registered in the “Stored” list on the “My Destinations” screen. (See page 54.)
- ‘ When  is touched, the registered telephone number is called.

- 7 The starting route guidance screen will be displayed. (See page 42.)

TRAFFIC MESSAGES

It contains a list of traffic messages relating to the set route, all traffic messages and warnings.

Before using this function, connect a Bluetooth® phone with an internet profile. (See page 203.)

DISPLAYING TRAFFIC MESSAGES

- 1 Touch “Dest” on the map.
- 2 Touch “Traffic Messages”.



- The “Traffic Messages” screen can be displayed by touching  on any of the “Navigation” screens or “Traffic” on the “Applications” menu screen.
- When the login information screen is displayed, enter the user login information and then touch “**Confirm Login Information**”. (See page 80.)
- When the cost warning or roaming warning screen is displayed, touch “**Continue**”. This function can be set to on or off. (See page 208.)

- 3 Touch “On Route”, “Show All” or “Warnings” to select the desired list.



“**On Route**”: During route guidance, the traffic messages relating to the set route will be displayed.



“**Show All**”: All traffic messages will be displayed.

“**Warnings**”: Traffic messages with warnings will be displayed.

- 4 Touch the desired message.





On this screen, the following information is displayed.

No.	Information
1	Street number
2	Route segment If route segment is not available, information such as street name, city name, region or country will be displayed.
3	 : Icon of an incident  : Icon of an incident on the route  : Icon of an incident on the detoured route
4	Distance to incident

5 The traffic message will be displayed.















 or : Touch to display next or previous traffic message.

: Touch to have the traffic message read out. To cancel this function, touch



“More”: Touch to display all messages.

LIST OF TRAFFIC MESSAGE ICONS

Icon	Name
	Slippery
	Bad weather
	Wind
	Snow fall
	Traffic
	Heavy traffic
	Accident
	Road construction
	Narrow track
	Warning
	Blockage
	Security checkpoint
	Information

DETOURING A SEGMENT FROM A TRAFFIC MESSAGE LIST

If a traffic message relates to the route being travelled, the desired segment can be detoured.



DETOURING THE SEGMENT

- 1 Displaying the traffic information list. (See page 86.)
- 2 Touch “**On Route**” on the “Traffic Messages” screen.
- 3 Touch the desired segment to detour.



- 4 Touch “**Detour**”.



 or : Touch to display the next or previous message.

: Touch to have the traffic message read out. To cancel this function, touch



“**More**”: Touch to display all traffic messages.



- 5 The route will be recalculated.

The mark of the TMC on the “On Route” screen changes into .

CANCELLING THE DETOURED SEGMENT

- 1 Touch the detoured segment on the “On Route” screen.
- 2 Touch “**Detour Off**”.



 or : Touch to display the next or previous message.

: Touch to have the traffic message read out. To cancel this function, touch



“**More**”: Touch to display all traffic messages.

- 3 The route will be recalculated.

The mark of the TMC on the “On Route” screen changes to .

RECALCULATING THE ROUTE BY THE TRAFFIC MESSAGES

You will be informed about relevant traffic messages on the route by a pop-up window.

A pop-up window may differ depending on the traffic message settings. (See page 91.)

IF “Automatic” IS SELECTED

- 1 The following screen will be displayed.



- 2 The route will be recalculated automatically.

IF “Manual” IS SELECTED

- 1 The following screen will be displayed.



“**Consider**”: Touch to display with the current route, the TMC event and the suggested detour.

“**Ignore**”: Touch to ignore the message.

- i If “**Consider**” is selected

- 2 Touch “**Ignore**” or “**Detour**”.



“**Ignore**”: Touch to ignore the message.

“**Detour**”: Touch to recalculate the route.

TRAFFIC MESSAGE SETTINGS

- 1 Touch “**Dest**” on the map.
- 2 Touch “**Route Options**”.



The “Route Options” screen can be displayed by touching  on any of the “Navigation” screens.

- 3 Touch “**Settings**”.



Please refer to the following pages for a description of each setting.

SETTING “Radius Filter”

Once the radius filter has been set, only traffic messages within the radius will be displayed in the traffic message list.

- 1 Touch “**Radius Filter**” on the “Settings” screen.
- 2 Touch desired item.



“**Off**”: Touch to deactivate the function.

“**6 mi**” ~ “**60 mi**”: Touch to set the radius from 6 miles to 60 miles.

- 3 Touch .

SETTING “Dynamic Reroute”

The method of reroute can be set.

- 1 Touch “**Dynamic Reroute**” on the “Settings” screen.
- 2 Touch the desired item.



“**Off**”: Touch to disable receiving traffic messages and no reroute will be calculated.

“**Automatic**”: Touch to enable relevant traffic messages on the route to be displayed as a pop-up window and activate automatic reroute calculation.

“**Manual**”: Touch to enable relevant traffic messages on the route to be displayed as a pop-up window but disable automatic reroute calculation. The user decides if reroute calculation is desirable or not.

- 3 Touch .

LOADING ADDRESSES FROM A PHONE

Addresses and numbers will be stored in the “Stored” list on the “My Destinations” screen and “Contacts” screen. (See pages 52 and 165.)

- 1 Touch “**Dest**” on the map.
- 2 Touch “**Enter Destination**”.



- The “Enter Destination” screen can be displayed by touching  on any of the “Navigation” screens.

- 3 Touch “**Advanced**” on the “Enter Destination” screen.
- 4 Touch “**Load Addresses from Phone**”

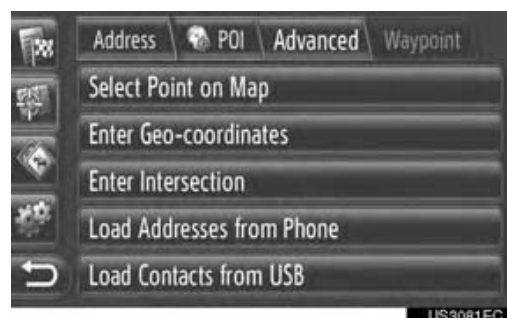

- When the login information screen is displayed, enter the user login information and then touch “**Confirm Login Information**”. (See page 80.)

When the cost warning or roaming warning screen is displayed, touch **“Continue”**. This function can be set to on or off. (See page 208.)

5 The following screen will be displayed when loading is complete.



6 The entry is registered in the “Stored” list on the “My Destinations” screen and “Contacts” screen. (See pages 52 and 165.)



NOTICE

- Do not turn off the engine while downloading.

INFORMATION

- If a message similar to the one below is displayed, delete X item(s) in the “Stored” list on the “My Destinations” screen and “Contacts” screen to make room for the new destination(s). (See pages 58 and 168.)



OPERATING AN APPLICATION

Before using applications, connect the Bluetooth® phone with an internet profile. (See page 203.) If a Bluetooth® connection with an internet profile is not currently active, applications will be dimmed.

OPENING/CLOSING AN APPLICATION

OPENING AN APPLICATION

- 1 Press the “APPS” button to display the “Applications” menu screen.

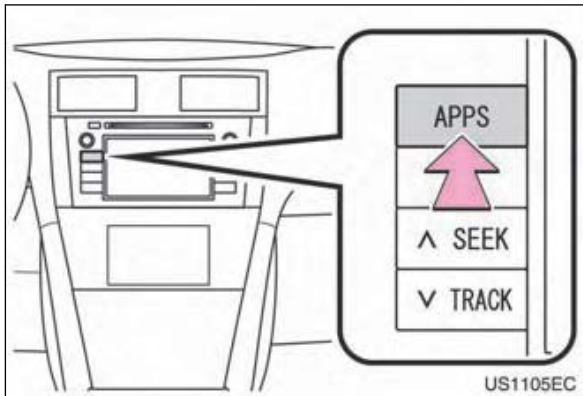

- ‘ If the “Applications” menu screen is not displayed, touch  until it is displayed.

- 2 Touch the desired application.



- ‘ When the login information screen is displayed, enter the user login information and then touch “**Confirm Login Information**”. (See page 80.)

- ‘ When the cost warning or roaming warning screen is displayed, touch “**Continue**”. This function can be set to on or off. (See page 208.)
- ‘ Several downloaded applications can be opened at the same time and the desired application can be selected.
- ‘  is displayed on the left side of application names that are currently open.

- 3 The application is opened.



- ‘  (on some applications): Touch to update the data

CLOSING AN APPLICATION

- 1 Touch .



- 2 Touch “**Close**” on the right side of the application to be closed.



DELETING AN APPLICATION

- 1 Touch .



- 2 Touch “**Delete**” on the right side of the application to be deleted.



- Applications that displayed “Delete” on the right side of the application can be removed.
- 3 The following confirmation screen will be displayed. Touch “**Yes**”.



IF A MESSAGE APPEARS ON THE SCREEN

When problems occur starting up the application player, a message will appear on the screen. Referring to the table below to identify the problem, take the suggested corrective action.

Message	Display conditions	Corrective action
“This feature is unavailable while transferring contacts.”	Contacts are being transferred manually from the phone book.	When the transfer of contacts is complete, perform the operation.
“There is a problem with the Bluetooth ¹ connection. For troubleshooting assistance, please visit toyota.com or call 1-800-331-4331.”	The cellular phone cannot be connected.	Refer to http://www.toyota.com/entune/ to confirm if the phone is compatible or not.
“This feature is unavailable during a handsfree call.”	A hands-free call is in progress.	After the hands-free call is finished, perform the operation.
To use the services, an active application needs to be running on your phone. For more information, please visit toyota.com .	The Entune application cannot be connected to SSP.	Refer to http://www.toyota.com/entune/ to confirm if the phone is SSP compatible or not, and then activate the Entune application.
Apps connection was dropped. Please check your phone.	Communication was disconnected.	After a few moments, retry the operation.

¹: Bluetooth is a registered trademark of Bluetooth SIG, Inc.

1 AUDIO SYSTEM OPERATION

1. QUICK REFERENCE	100
2. SOME BASICS	102
TURNING THE AUDIO SYSTEM ON OR OFF	102
CONTROLS USING THE “TUNE SCROLL” KNOB	103
SWITCHING AUDIO SOURCE	103
DSP CONTROL	104
TONE AND BALANCE	105
3. RADIO OPERATION	106
SWITCHING TO RADIO MODE.....	106
PRESETTING A STATION	106
SELECTING A STATION	107
RADIO BROADCAST DATA SYSTEM	107
TRAFFIC ANNOUNCEMENT	108
USING HD Radio™ TECHNOLOGY....	109

AUDIO SYSTEM

4. RADIO OPERATION (XM[®] Satellite Radio BROADCAST)	112	7. AUX DEVICE OPERATION.....	130
HOW TO SUBSCRIBE TO AN XM [®] Satellite Radio	112	CONNECTING A PORTABLE AUDIO DEVICE.....	130
DISPLAYING THE RADIO ID.....	112	SWITCHING TO AUX MODE	131
SWITCHING TO SATELLITE RADIO MODE	113	PLAYING A PORTABLE AUDIO DEVICE.....	131
CHANNEL CATEGORY	113	8. Bluetooth[®] AUDIO OPERATION	132
PRESETTING A CHANNEL	113	SWITCHING TO Bluetooth [®] AUDIO MODE	133
SELECTING A CHANNEL.....	114	CONNECTING Bluetooth [®] AUDIO	134
DISPLAYING THE TITLE AND NAME	114	PLAYING Bluetooth [®] AUDIO.....	137
IF THE SATELLITE RADIO TUNER MALFUNCTIONS.....	115	9. STEERING SWITCHES.....	141
5. CD PLAYER OPERATION	117	STEERING SWITCHES (WITH TWO DIRECTION STEERING SWITCH).....	141
INSERTING OR EJECTING A DISC...	117	STEERING SWITCHES (WITH FOUR DIRECTION STEERING SWITCH).....	142
SWITCHING TO CD MODE	118	10. AUDIO SYSTEM OPERATING HINTS.....	144
PLAYING AN AUDIO CD	118	RADIO RECEPTION.....	144
PLAYING A MP3/WMA DISC.....	120	iPod.....	145
6. USB MEMORY/iPod OPERATION	123	USB MEMORY	146
CONNECTING A USB MEMORY OR iPod	123	CARING FOR YOUR CD PLAYER AND DISCS.....	146
SWITCHING TO USB OR iPod MODE	124	MP3/WMA FILES.....	148
PLAYING A USB MEMORY OR iPod	124	CD-R AND CD-RW DISCS	149
		TERMS	150
		Gracenote [®]	151

1. AUDIO SYSTEM OPERATION

1. QUICK REFERENCE

To access the audio system, press the **“AUDIO”** button. The audio system turns on in the last mode used.

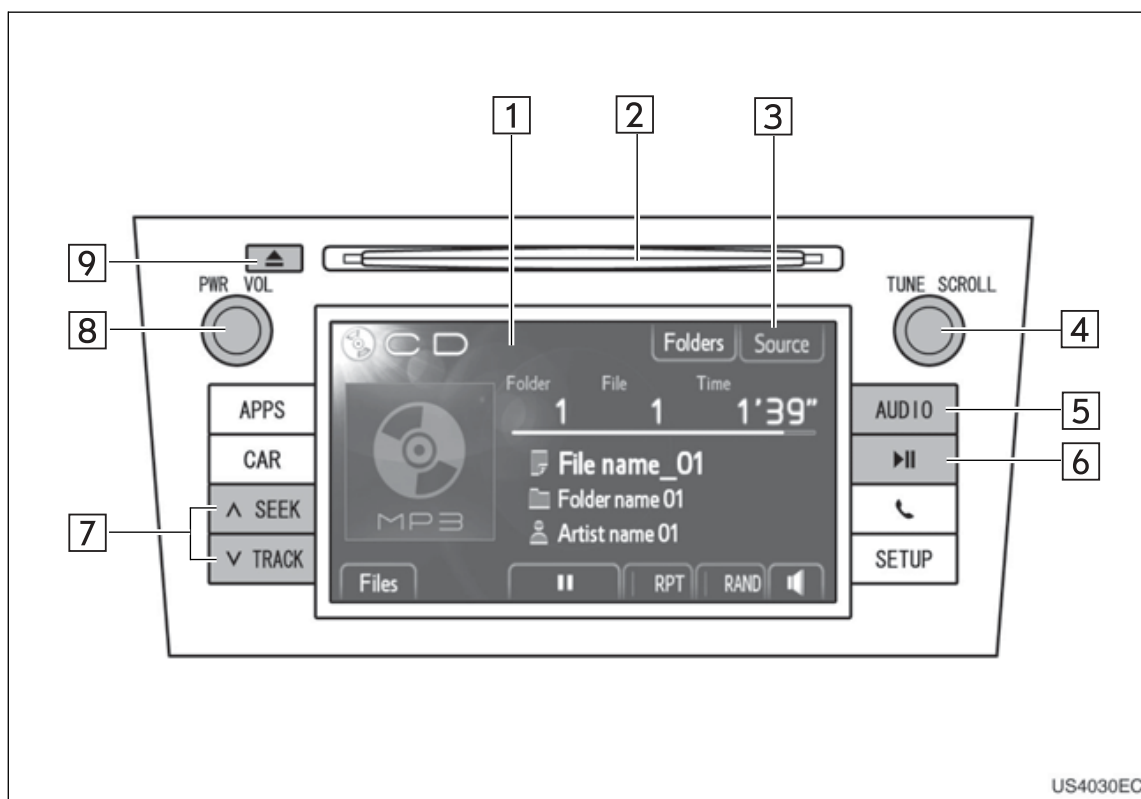

The actual design and button position may differ depending on the vehicle. For details, see Section 3 of *“Owner’s Manual”*.

No.	Name	Function	Page
1	Audio control screen	A selected audio source is displayed, and it can be operated with the touch screen controls.	∞
2	Disc slot	Insert a disc into this slot. The CD player turns on immediately.	117
3	“Source”	Touch to select your desired audio sources. The audio source selection screen will be displayed.	103
4	“TUNE SCROLL” knob	Turn to select radio station bands, tracks and files. Also, the knob can be used for selection from the list display.	103
5	“AUDIO” button	Press to display the audio control screen. The audio system turns on in the last mode used.	102, 103
6	▶ button*	Press to pause or resume playing the music.	∞

No.	Name	Function	Page
7	“SEEK/TRACK” button	Press the “^” or “v” button to seek up or down for a station, or to access a desired track or file.	107, 114, 119, 121, 124, 137
8	“PWR VOL” knob	Press to turn the audio system on and off, and turn to adjust the volume.	102
9	 button	Press to eject a disc.	117

*: If equipped

1. AUDIO SYSTEM OPERATION

2. SOME BASICS

This section describes some of the basic features of the audio system. Some information may not pertain to your system.

Your audio system works when the engine switch is turned to the “ACC” or “ON” position.

CAUTION

- For vehicles sold in U.S.A. and Canada: Part 15 of the FCC Rules
FCC Warning: Changes or modifications in construction not expressly approved by the party responsible for compliance could void the user’s authority to operate the equipment. Radio frequency exposure. This device is approved for Mobile Application only and, to comply with applicable FCC radio frequency exposure regulations, must be used with a distance of at least 7.9 in. (20 cm) between the antenna and the body of any person at all time during use.
- Laser products
 - Do not take this unit apart or attempt to make any changes yourself. This is an intricate unit that uses a laser pickup to retrieve information from the surface of compact discs. The laser is carefully shielded so that its rays remain inside the cabinet. Therefore, never try to disassemble the player or alter any of its parts since you may be exposed to laser rays and dangerous voltages.
 - This product utilizes a laser. Use of controls or adjustments or performance of procedures other than those specified herein may result in hazardous radiation exposure.

NOTICE

- To prevent the 12-volt battery from being discharged, do not leave the audio system on longer than necessary when the engine is not running.

TURNING THE AUDIO SYSTEM ON OR OFF

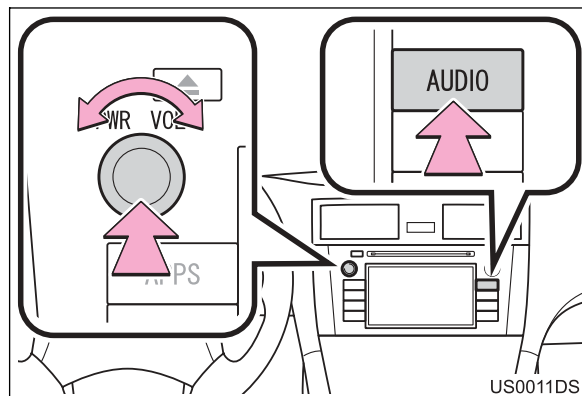

“**AUDIO**” button: Press this button to display screen buttons for the audio system.

“**PWR VOL**” knob: Press this knob to turn the audio system on and off. Turn this knob to adjust the volume. The system turns on in the last mode used.

INFORMATION

- If the volume is adjusted while music is paused or muted, the pause or mute will be cancelled.

CONTROLS USING THE “TUNE SCROLL” KNOB

i Radio mode

Radio stations can be tuned in manually using this knob.

i Modes other than radio

Tracks, songs or files can be selected using the knob.

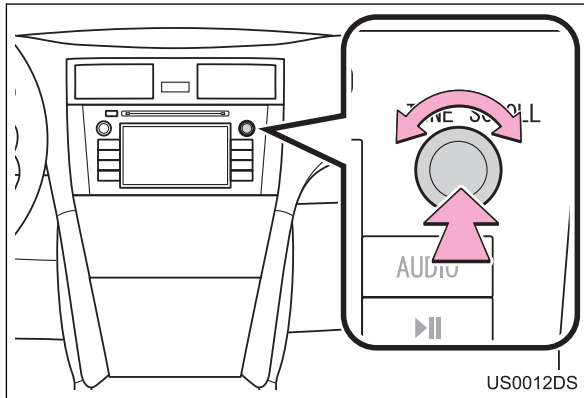

i When a list displayed

When a list is displayed on the screen, turn the “**TUNE SCROLL**” knob to move the cursor box to select a desired item from the list, and pressing the knob will play it. The track that is being played is highlighted.



SWITCHING AUDIO SOURCE

1 Press the “**AUDIO**” button.

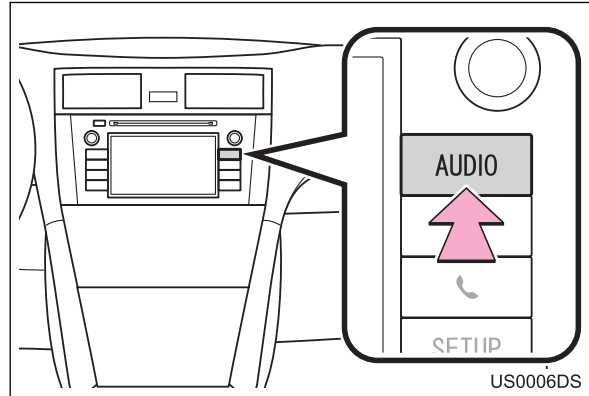

The audio system turns on in the last mode used.

2 Touch “**Source**” on the screen.



3 Touch a desired audio source.



INFORMATION

- You cannot select dimmed screen buttons. Connect the audio device before selecting.

DSP CONTROL

1 Press the **“AUDIO”** button.

2 Touch  or .

i USB memory/iPod and Bluetooth® audio modes



DSP control can be set from the “Options” screen. Touch **“Options”** and then touch **“Sound Settings”** on the next screen.

i Modes other than USB memory/iPod and Bluetooth® audio



3 Touch the **“DSP”** tab to display this screen.

i Without JBL sound system

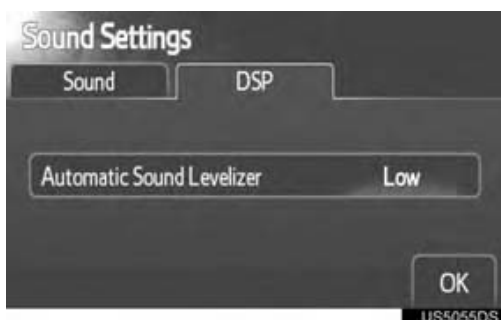

i With JBL sound system

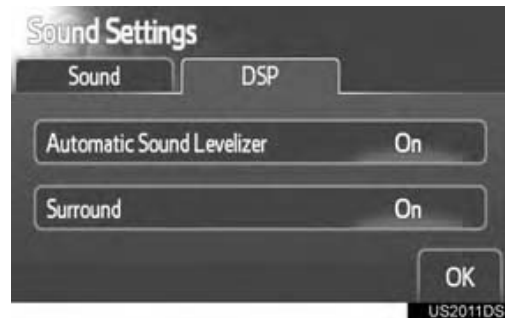

4 Touch the desired screen button.

AUTOMATIC SOUND LEVELIZER (ASL)

The system adjusts to the optimum volume and tone quality according to vehicle speed to compensate for increased vehicle noise.

i Without JBL sound system

1 Touch **“On”** of “Automatic Sound Levelizer”.

2 Touch **“OK”**.

i With JBL sound system

1 Touch **“High”**, **“Mid”** or **“Low”** of “Automatic Sound Levelizer”.

2 Touch **“OK”**.

SURROUND FUNCTION (IF EQUIPPED)

1 Touch **“On”** of “Surround”.

2 Touch **“OK”**.

TONE AND BALANCE



TONE

How good an audio program sounds is largely determined by the mix of the treble, mid and bass levels. In fact, different kinds of music and vocal programs usually sound better with different mixes of treble, mid and bass.

BALANCE

A good balance of the left and right stereo channels and of the front and rear sound levels is also important.

Keep in mind that when listening to a stereo recording or broadcast, changing the right/left balance will increase the volume of one group of sounds while decreasing the volume of another.

- 1 Press the **"AUDIO"** button.
 - 2 Touch  or .
- i USB memory/iPod and Bluetooth® audio modes



- Tone and balance can be set from the "Options" screen. Touch **"Options"** and then touch **"Sound Settings"** on the next screen.

- i Modes other than USB memory/iPod and Bluetooth® audio



- 3 Touch the **"Sound"** tab to display this screen.

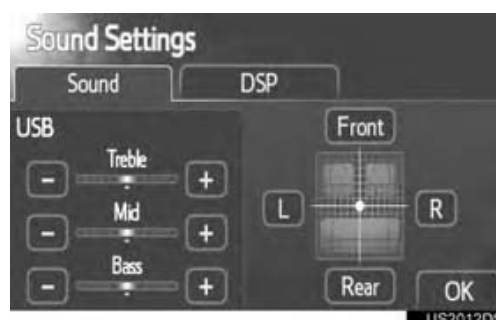

- 4 Touch the desired screen button.
 - "Treble" "+" or "-"**: To adjust high-pitched tones.
 - "Mid" "+" or "-"**: To adjust mid-pitched tones.
 - "Bass" "+" or "-"**: To adjust low-pitched tones.
 - "Front" or "Rear"**: To adjust the sound balance between the front and rear speakers.
 - "L" or "R"**: To adjust the sound balance between the left and right speakers.
- 5 Touch **"OK"**.

INFORMATION

- The tone of each mode can be adjusted.

3. RADIO OPERATION

SWITCHING TO RADIO MODE

- 1 Press the **“AUDIO”** button.

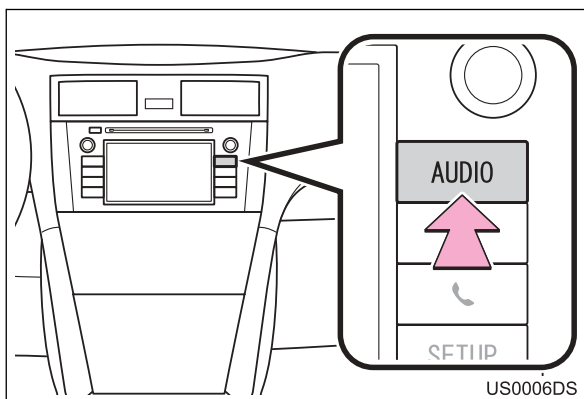

‘ The audio system turns on in the last mode used.

- 2 Touch **“Source”** on the screen.



- 3 Touch **“AM”** or **“FM”** on the screen.



PRESETTING A STATION

Radio mode has a mix preset function, which can store up to 36 stations (6 station per page Δ 6 page) from any of the AM, FM or SAT bands.

- 1 Tune in the desired station.
- 2 Touch one of the left side screen buttons **(1-6)** and hold it until a beep is heard. This sets the frequency to the screen button. The station's frequency will be displayed in the screen button.



- ‘ To change the preset station to a different one, follow the same procedure.
- ‘ Touch **<<** or **>>** to change the preset page.

SELECTING A STATION

Tune in the desired station using one of the following methods.

Preset tuning: Touch one of the mix preset channels on the left side of the screen to select the desired station. The screen button is highlighted and the station frequency appears on the screen.

Manual tuning: Search for a desired radio station by turning the “**TUNE SCROLL**” knob.

Seek tuning: Press the “**^**” or “**v**” button of “**SEEK/TRACK**”. The radio will begin seeking up or down for a station of the nearest frequency and will stop when a station is found. Each time the button is pressed, the stations will be searched automatically one after another.

To scan all the frequencies: Touch “**SCAN**”. “**SCAN**” will appear on the screen. The radio will find the next station and stay there for 10 seconds if “**All**” or “**HD Only**” is selected, or 5 seconds if “**Analog**” is selected, and then scan again. To stay tuned to a station and stop the scanning, touch “**SCAN**” again. (To set the HD Radio™ system, see page 210.)

RADIO BROADCAST DATA SYSTEM

This audio system is equipped with Radio Broadcast Data Systems (RBDS). RBDS mode allows text messages to be received from radio stations that utilize RBDS transmitters.

When RBDS is on, the radio can

- only select stations of a particular program type,
- display messages from radio stations,
- search for a stronger signal station.

RBDS features are available only when listening to an FM station that broadcasts RBDS information and the “FM info” indicator is on.

4

AUDIO SYSTEM

SELECTING A DESIRED TYPE

1 Touch “**Options**”.



- 2** Touch “**TYPE >**” or “**< TYPE**” to move forward and backward through the program list.



- Once a program type has been set, “TYPE SEEK” will appear on the screen.
- The program list is in the following order:
 - Classical
 - Country
 - EasyLis (Easy Listening)
 - Inform (Information)
 - Jazz
 - News
 - Oldies
 - Other
 - Pop Music
 - Religion
 - Rock
 - R&B (Rhythm and Blues)
 - Sports
 - Talk
 - Traffic (Not available when “HD Radio™ Settings” are set to analog)
 - Alert (Emergency Alert)

- 3** Touch “**TYPE SEEK**” and the system will start to seek for stations in the relevant program type.

INFORMATION

- If no relevant program can be found, “no type” will appear on the screen.

TRAFFIC ANNOUNCEMENT

A station that regularly broadcasts traffic information is automatically located.



“**Traffic**”: Touch to seek a traffic program station. “TRAF SEEK” will appear on the screen.

INFORMATION

- If no traffic program station is found, “No Traffic” will appear on the screen.
- If a traffic program station is found, the name of the traffic program station will be displayed for a while.

USING HD Radio™ TECHNOLOGY

HD Radio™ Technology is the digital evolution of analog AM/FM radio. Your radio product has a special receiver which allows it to receive digital broadcasts (where available) in addition to the analog broadcasts it already receives. Digital broadcasts have better sound quality than analog broadcasts as digital broadcasts provide free, crystal clear audio with no information, and a guide to available radio stations and programming, refer to www.hdradio.com.

- 1 Touch “**HD Radio**” to turn the indicator on.



- As a user works through the analog radio stations, (where applicable) the radio receiver will automatically tune from an analog signal to a digital signal within 5 seconds.
- An orange “HD)” logo indicator will be displayed on the screen when in digital. The “HD)” logo will first appear in a gray color indicating the station is indeed (an analog and) a digital station. Once the digital signal is acquired, the logo will change to a bright orange color.

INFORMATION

- 1 Touch “**Text**”.



- 2 Information such as the artist name, song title, album title and music genre being listened to are displayed on the text screen.



- To display messages from the station, touch “**Additional information**”.

MULTICAST

On the FM radio frequency most digital stations have “multiple” or supplemental programs on the FM station.

- 1 Touch “**Multicast**”.



- Each time “**Multicast**” is touched, the supplemental program changes.
- If “**Multicast**” is touched when tuned to the last of the supplemental programs, the main program will be returned to.

TAG

- 1 Touch **“Tag”** to bookmark the music information.



- 2 Open the cover and connect iPod using an iPod cable.

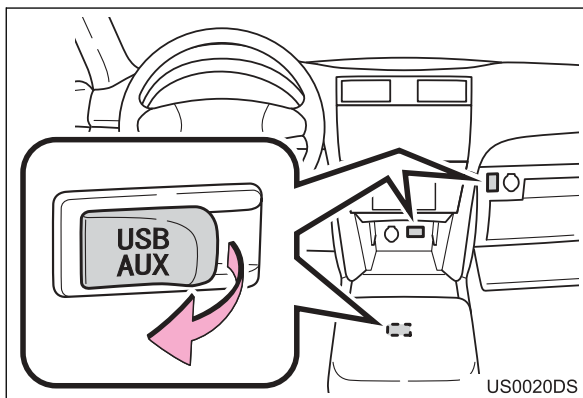

- The USB/AUX port is located on the instrument panel, or in the console box or glove box etc. The location and design are different depending on the vehicle. For details, see the Pictorial index of *“Owner’s Manual”*.
- Turn on the power of the iPod if it is not turned on.
- Once an iPod is connected, the music tag moves from the radio into the iPod.
- When the iPod is connected to iTunes, the “tagged” information of the songs which were tagged while listening to the radio can be viewed. Then a user may decide to purchase the song or CD/Album which has been listened to on their radio.

INFORMATION

- If tagging the music information fails, “Saving the HD Radio tag failed.” will be displayed on the screen. If this occurs, tag the information again.
- HD Radio™ stations can be preset.

TROUBLESHOOTING GUIDE

Experience	Cause	Action
Mismatch of time alignment a users may hear a short period of programming re-played or an echo, stutter or skip.	The radio stations analog and digital volume is not properly aligned or the station is in ballgame mode.	None, radio broadcast issue. A user can contact the radio station.
Sound fades, blending in and out.	Radio is shifting between analog and digital audio.	Reception issue, may clear-up as the vehicle continues to be driven. Touching “ HD Radio ” with the indicator off can force radio in an analog audio.
Audio mute condition when an HD2/HD3 multicast channel has been playing.	The radio does not have access to digital signals at the moment.	This is normal behavior, wait until the digital signal returns. If out of the coverage area, seek a new station.
Audio mute delay when selecting an HD2/HD3 multicast channel preset.	The digital multicast content is not available until HD Radio™ broadcast can be decoded and make the audio available. This takes up to 7 seconds.	This is normal behavior, wait for the audio to become available.
Text information does not match the present song audio.	Data service issue by the radio broadcaster.	Broadcaster should be notified. Complete the form; www.ibequity.com/automotive/report_radio_station_experiences .
No text information shown for the present selected frequency.	Data service issue by the radio broadcaster.	Broadcaster should be notified. Complete the form; www.ibequity.com/automotive/report_radio_station_experiences .



HD Radio Technology manufactured under license from iBiquity Digital Corporation. U.S. and Foreign Patents. HD Radio™ and the HD, HD Radio, and “Arc” logos are proprietary trademarks of iBiquity Digital Corp.

4. RADIO OPERATION (XM[®] Satellite Radio BROADCAST)

HOW TO SUBSCRIBE TO AN XM[®] Satellite Radio

To listen to a satellite radio broadcast in the vehicle, a subscription to the XM[®] Satellite Radio service is necessary.

An XM[®] Satellite Radio is a tuner designed exclusively to receive broadcasts provided under a separate subscription. Availability is limited to the 48 contiguous U.S. states and some Canadian provinces.

HOW TO SUBSCRIBE

It is necessary to enter into a separate service agreement with XM[®] Satellite Radio in order to receive satellite broadcast programming in the vehicle. Additional activation and service subscription fees apply that are not included in the purchase price of the vehicle and digital satellite tuner.

For complete information on subscription rates and terms, or to subscribe to XM[®] Satellite Radio:

- i U.S.A.
Refer to www.siriusxm.com or call 1-800-967-2346.
- i Canada
Refer to www.xmradio.ca or call 1-877-209-0079.

INFORMATION

- XM[®] Satellite Radio is solely responsible for the quality, availability and content of the satellite radio services provided, which are subject to the terms and conditions of the XM[®] Satellite Radio customer service agreement.
- Customers should have their radio ID ready; the radio ID can be found by tuning to “channel 000” on the radio. For details, see “DISPLAYING THE RADIO ID” below.
- All fees and programming are the responsibility of XM[®] Satellite Radio and are subject to change.

SATELLITE TUNER TECHNOLOGY NOTICE

Toyota’s satellite radio tuners are awarded Type Approval Certificates from XM[®] Satellite Radio Inc. as proof of compatibility with the services offered by XM[®] Satellite Radio.

DISPLAYING THE RADIO ID

Each XM[®] tuner is identified with a unique radio ID. The radio ID is required when activating an XM[®] service or when reporting a problem.

- ‘ If “CH 000” is selected using the “**TUNE SCROLL**” knob, the ID code, which is 8 alphanumeric characters, will be displayed. If another channel is selected, the ID code will no longer be displayed. The channel (000) displays the radio ID and the specific radio code.

SWITCHING TO SATELLITE RADIO MODE

- 1 Press the **“AUDIO”** button to display the audio control screen.

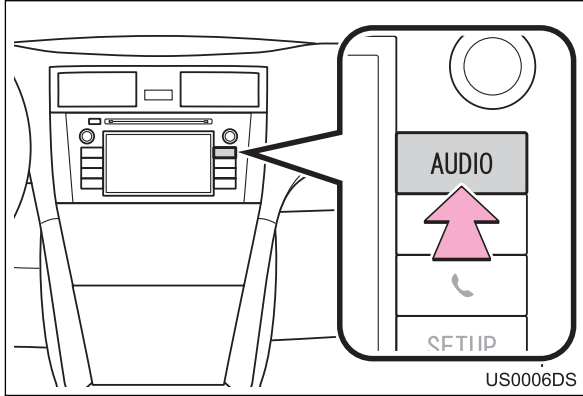

The audio system turns on in the last mode used.

- 2 Touch **“Source”** on the screen.

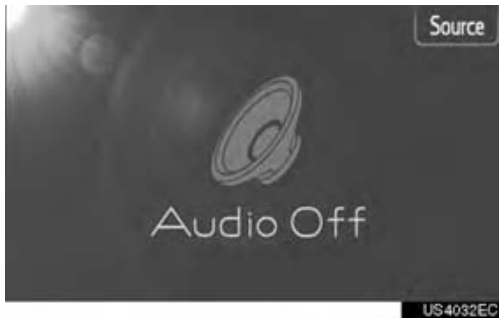

- 3 Touch **“SAT”** on the screen.



CHANNEL CATEGORY

- 1 Touch **“Options”**.



- 2 Touch either **“TYPE >”** or **“< TYPE”** to go to the next or previous category.



4

AUDIO SYSTEM

PRESETTING A CHANNEL

- 1 Tune in the desired channel.
- 2 Touch one of the left side screen buttons **(1-6)** and hold it until a beep is heard. This sets the preset frequency to the screen button. The Channel number will be displayed in the screen button.



To change the preset channel to a different one, follow the same procedure.

SELECTING A CHANNEL

Tune in the desired channel using one of the following methods.

Preset tuning: Touch the channel selector screen button (1-6) to listen to the desired channel. The selected screen button (1-6) is highlighted and its related information appears on the right side of the screen.

Manual tuning: Turn the “TUNE SCROLL” knob to select the next or previous channel. Turning the knob quickly allows rapid scrolling through the channel list.

To select a channel within the current category: Press the “^” or “v” button of “SEEK/TRACK”. The radio will change up or down to a channel within the current channel category.



To scan the currently selected channel category: Touch “SCAN”. “SCAN” appears on the screen. The radio will find the next channel in the same channel category, stay there for a few seconds, and then scan again. To select a channel, touch “SCAN” again.

DISPLAYING THE TITLE AND NAME

- 1 Touching “Text” displays the artist name and song title you are currently listening to.



INFORMATION

- Up to 64 alphanumeric characters can be displayed. (Some information will not be fully displayed.)

IF THE SATELLITE RADIO TUNER MALFUNCTIONS

When problems occur with the XM[®] tuner, a message will appear on the screen. Referring to the table below to identify the problem, take the suggested corrective action.

Message	Explanation
Ck Antenna	The XM [®] antenna is not connected. Check whether the XM [®] antenna cable is attached securely.
	A short circuit occurs in the antenna or the surrounding antenna cable. See a Toyota certified dealer for assistance.
Ch Unauth	You have not subscribed to XM [®] Satellite Radio. The radio is being updated with the latest encryption code. Contact XM [®] Satellite Radio for subscription information. When a contract is canceled, you can choose "CH000" and all free-to-air channels.
	The premium channel you selected is not authorized. Wait for about 2 seconds until the radio returns to the previous channel or "CH001". If it does not change automatically, select another channel. To listen to the premium channel, contact XM [®] Satellite Radio.
No Signal	The XM [®] signal is too weak at the current location. Wait until your vehicle reaches a location with a stronger signal.
Loading	The unit is acquiring audio or program information. Wait until the unit has received the information.
Ch Off Air	The channel you selected is not broadcasting any programming. Select another channel.
-----	There is no song/program title or artist name/feature associated with the channel at that time. No action is required.
Ch Unavail	The channel you selected is no longer available. Wait for about 2 seconds until the radio returns to the previous channel or "CH001". If it does not change automatically, select another channel.

INFORMATION

- Contact the XM[®] Listener Care Center at 1-800-967-2346 (U.S.A.) or 1-877-209-0079 (Canada).

**NOTICE**

- This equipment has been tested and found to comply with the limits for a class B digital device, pursuant to Part 15 of the FCC Rules. These limits are designed to provide reasonable protection against harmful interference in a residential installation. This equipment generates, uses and can radiate radio frequency energy and, if not installed and used in accordance with the instructions, may cause harmful interference to radio communications. However, there is no guarantee that interference will not occur in a particular installation.
- If this equipment does cause harmful interference to radio or television reception, which can be determined by turning the equipment off and on, the user is encouraged to try to correct the interference by one or more of the following measures:
 - Reorient or relocate the receiving antenna.
 - Increase the separation between the equipment and receiver.
 - Connect the equipment into an outlet on a circuit different from that to which the receiver is connected.
 - Consult the dealer or an experienced radio/TV technician for help.
- Information to user
 - Alternation or modifications carried out without appropriate authorization may invalidate the user's right to operate the equipment.

INFORMATION

- This XM[®] tuner supports "Audio Services" (Music and Talk) of only XM[®] Satellite Radio and "Text Information*" linked to the respective "Audio Services".

*: Text Information includes, Station Name, (Artist) Name, (Song) Title and Category Name.

5. CD PLAYER OPERATION

The CD player can play audio CDs, CD text and MP3/WMA discs.

(a) Audio CD, CD text (see page 118)

(b) MP3/WMA disc (see page 120)

For appropriate discs for this player, see "AUDIO SYSTEM OPERATING HINTS" on page 144.

INSERTING OR EJECTING A DISC

INSERTING A DISC

1 Insert a disc with the label side up.

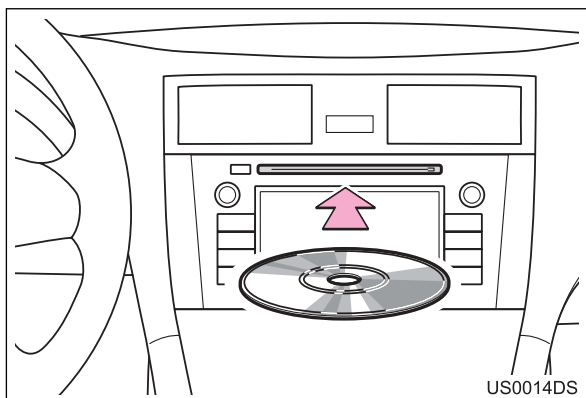

When a disc is correctly inserted into the slot, the CD player will automatically start playing from the first track or the first file of the first folder on a disc.

INFORMATION

- If the label is facing down, "Check DISC" will appear on the screen.
- The player is intended for use with 12 cm (4.7 in.) discs only. To play 8 cm (3 in.) discs, use an adaptor.

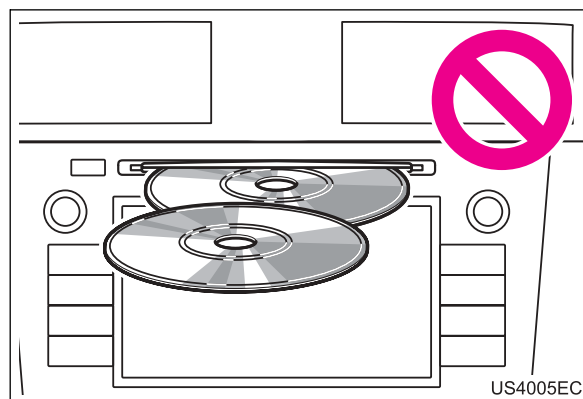

NOTICE

- Do not stack up two discs for insertion, or it will cause damage to the CD player. Insert only one disc into the slot at a time.
- Never try to disassemble or oil any part of the CD player. Do not insert anything other than a disc into the slot.

EJECTING A DISC

1 Press the ▲ button.

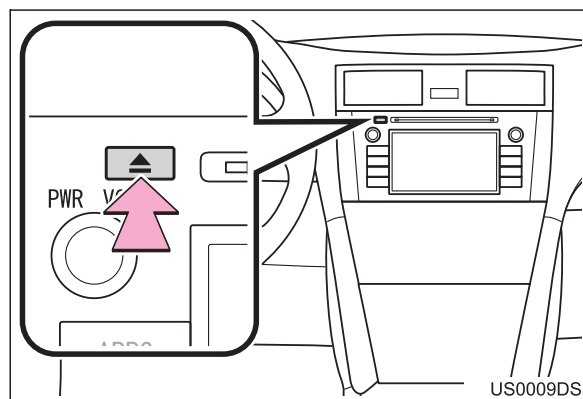

The disc will be ejected.

SWITCHING TO CD MODE

1 Press the **“AUDIO”** button.

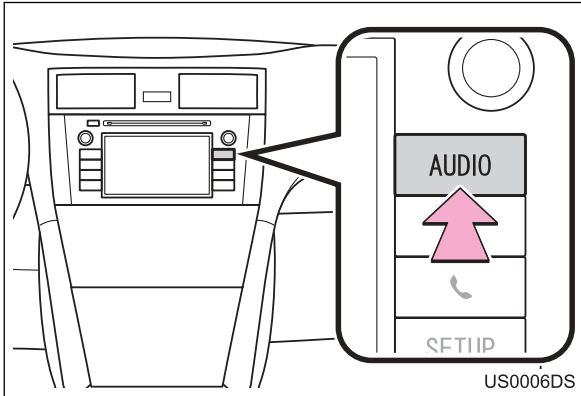

‘ The audio system turns on in the last mode used.

2 Touch **“Source”** on the screen.



3 Touch **“DISC”** on the screen.



INFORMATION

- If no disc is in the slot, **“DISC”** cannot be selected. Insert a disc into the slot.

PLAYING AN AUDIO CD



‘ If a CD-TEXT disc is inserted, the title of the track and disc currently being played will be displayed.

: Touch to pause the track.

: Touch to resume playing the track.

‘ When you touch , you can adjust sound settings. (See pages 104 and 105)

INFORMATION

- The progress bar indicator does not always correspond to the actual elapsed playback position.

FAST FORWARD AND REVERSE

1 Press and hold the **“^”** or **“v”** of the **“SEEK/TRACK”** button to fast forward or reverse. When the button is released, the player will start playing from that position.

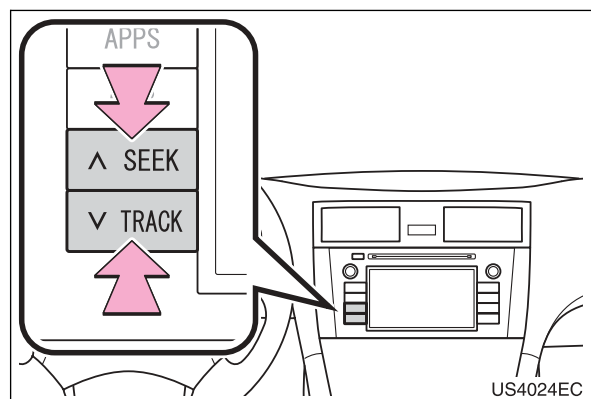

SELECTING A DESIRED TRACK

Select a desired track using one of the following methods.

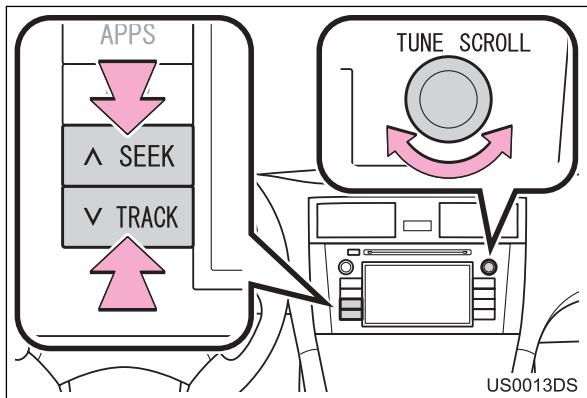

“SEEK/TRACK” button: Press the “^” or “v” of **“SEEK/TRACK”** button to select a desired track.

“TUNE SCROLL” knob: Turn this knob to select a desired track. Also, the knob can be used for selection from the list display.

Track list: A desired track can be selected from a list.



Touch **“Tracks”** on the screen. The list will be displayed.



- Touch a desired track. The player will start playing the selected track from the beginning.
- Touch or to scroll the list.
- If appears to the right of titles, the complete titles are too long for the display. Touch this screen button to scroll to titles.

PLAYING REPEAT AND RANDOM ORDER

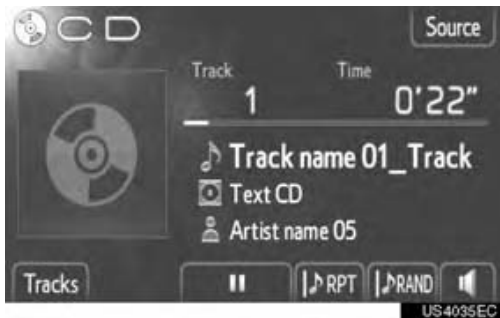

RPT (Repeat mode): Use it to automatically repeat the track you are currently listening to.

- The repeat mode changes as follows each time the screen button is touched.

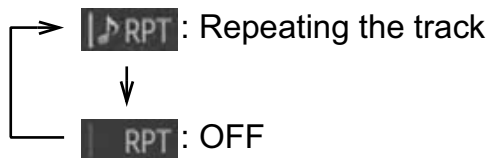

RAND (Random mode): Use it for automatic random selection of the track.

- The random mode changes as follows each time the screen button is touched.

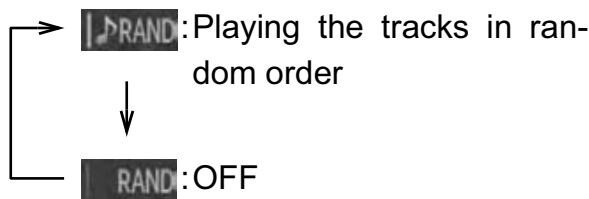

PLAYING A MP3/WMA DISC



- The title of the file and folder currently being played will be displayed.

|| : Touch to pause the file.

▶ : Touch to resume playing the file.

- When you touch , you can adjust sound settings. (See pages 104 and 105)

INFORMATION

- The progress bar indicator does not always correspond to the actual elapsed playback position.

FAST FORWARD AND REVERSE

- Press and hold the “^” or “v” of the “SEEK/TRACK” button to fast forward or reverse. When the button is released, the player will start playing from that position.

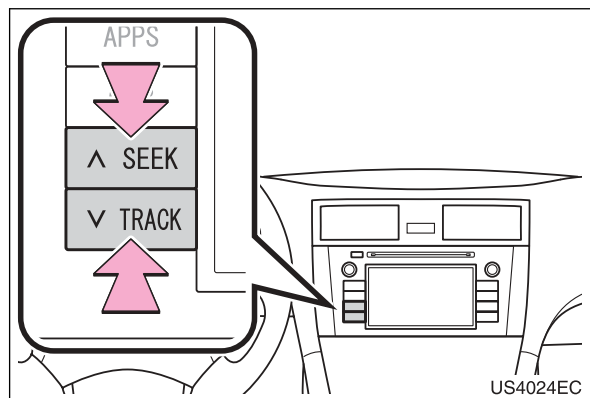

US4024EC

SELECTING A DESIRED FILE

Select a desired file using one of the following methods.

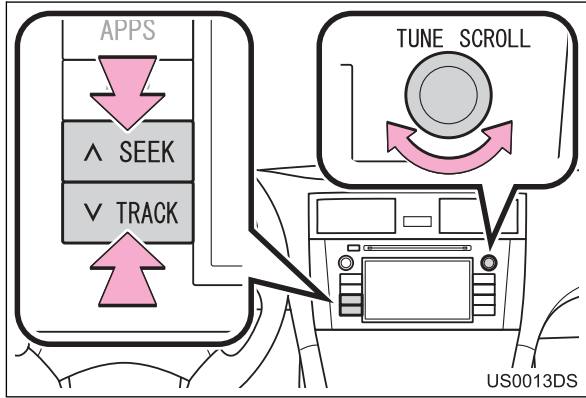

“SEEK/TRACK” button: Press the “^” or “v” of “SEEK/TRACK” button to select a desired file.

“TUNE SCROLL” knob: Turn this knob to select a desired file. Also, the knob can be used for selection from the list display.

File list: A desired file can be selected from a list.



Touch **“Files”** on the screen. The list will be displayed.

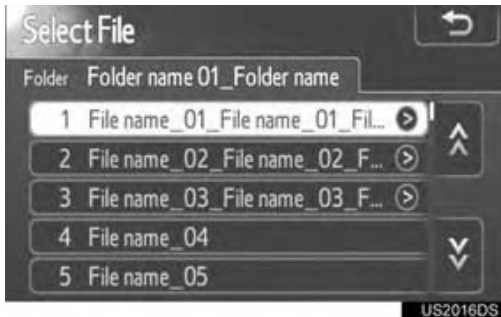

- Touch a desired file. The player will start playing the selected file from the beginning.
- Touch or to scroll the list.
- If appears to the right of titles, the complete titles are too long for the display. Touch this screen button to scroll to titles.

SELECTING A DESIRED FOLDER

- 1 Touch **“Folders”** on the screen. The folder list will be displayed.



- 2 Touch a desired folder from the list. The file list for the folder will be displayed.

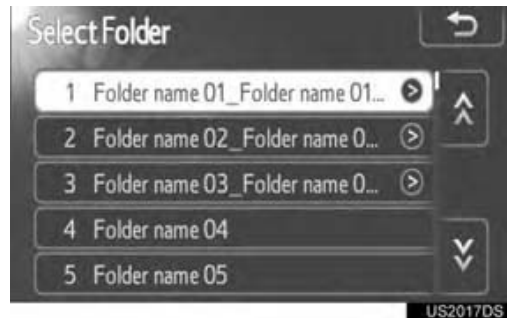

- When a desired file is touched, the player will start playing the file.
- Touch or to scroll the list.
- If appears to the right of titles, the complete titles are too long for the display. Touch this screen button to scroll to titles.

PLAYING REPEAT AND RANDOM ORDER



RPT (Repeat mode): Use it to automatically repeat the file or folder you are currently listening to.

- The repeat mode changes as follows each time the screen button is touched.

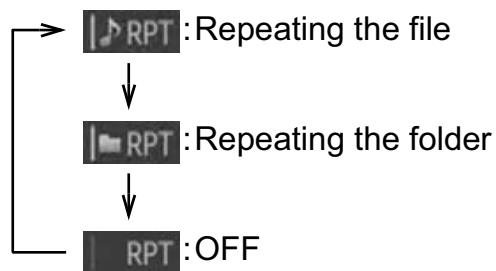

RAND (Random mode): Use it for automatic random selection of the file.

- The random mode changes as follows each time the screen button is touched.

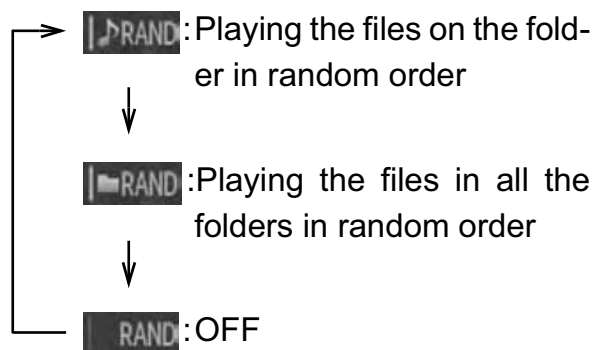

The system enables users to enjoy music played from a USB memory or iPod on the vehicle's speakers.

⚠ CAUTION

- Do not operate the player's controls or connect the USB memory or iPod while driving.

⚠ NOTICE

- Do not leave your portable player in the vehicle. The temperature inside may rise to a level that could damage the portable player.
- Do not press down on or apply unnecessary pressure to the portable player while it is connected as this may damage the portable player or its terminal.
- Do not insert foreign objects into the USB port as this may damage the portable player or its terminal.

INFORMATION

- This system has a charging function for iPods.
- When the battery level of an iPod is very low, the iPod may not operate. If so, charge the iPod before use.
- Depending on the portable player that is connected to the system, certain functions may not be available. If a function is unavailable due to a malfunction, disconnecting your portable player and reconnecting it may resolve the problem.
- When an iPod does not operate, update the software of the iPod to the latest version, and then retry. For supported models and software versions, see page 145.
- This system supports MTP devices.

CONNECTING A USB MEMORY OR iPod

- 1 Open the cover of the USB/AUX port and connect a USB memory or iPod using an iPod cable.

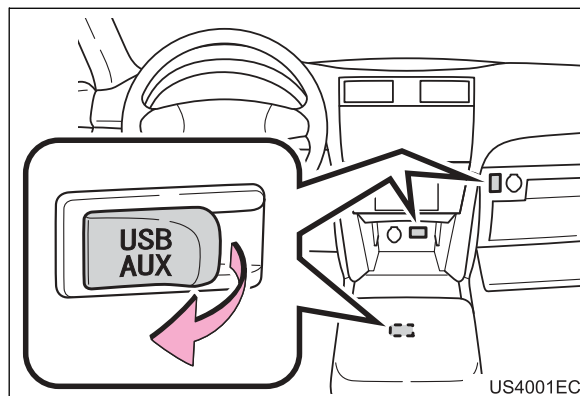

- The USB/AUX port is located on the instrument panel, or in the console box or glove box etc. The location and design are different depending on the vehicle. For details, see the Pictorial index of "Owner's Manual".
- Turn on the power of the USB memory or iPod if it is not turned on.
- If a USB memory or iPod is inserted, it starts playing automatically. As soon as it is ready to play, the audio control screen is shown automatically.

SWITCHING TO USB OR iPod MODE

- 1 Press the **“AUDIO”** button.

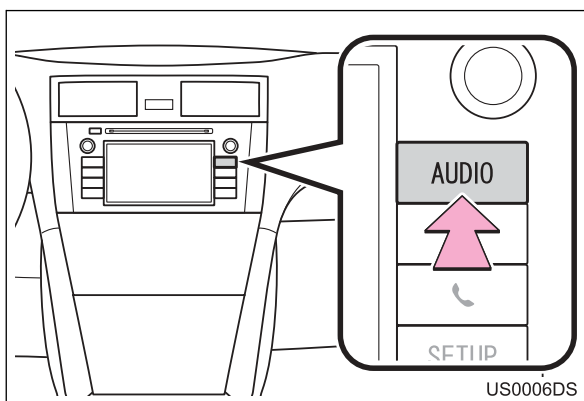

- ‘ The audio system turns on in the last mode used.

- 2 Touch **“Source”**.



- 3 Touch **“USB”** or **“iPod”**.



INFORMATION

- If no USB memory or iPod is connected, **“USB”** or **“iPod”** cannot be selected. Connect a USB memory or iPod to the USB port.

PLAYING A USB MEMORY OR iPod

PLAYING A SONG

The title of the album, song and artist name of the song currently being listened to will be displayed.

PLAY AND PAUSE



- ⏸: Touch to pause the song.
- ▶: Touch to resume playing the song.

‘ When you touch , you can adjust sound settings. (See pages 104 and 105)

INFORMATION

- The progress bar indicator does not always correspond to the actual elapsed playback position.
- USB memory only: If the song's data does not contain an ID3 tag, the file and folder name will be displayed instead of the song and album title. Please note that the file name will not include the file's extension.

FAST FORWARD AND REVERSE

- 1 Press and hold the “^” or “v” of the “**SEEK/TRACK**” button to fast forward or reverse. When the button is released, the player will start playing from that position.

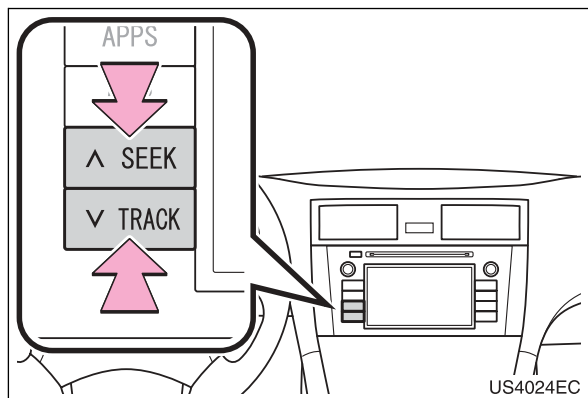

SELECTING A DESIRED SONG

SELECTING A PLAYLIST

Songs can be sorted and selected from various playlists.

- 1 Touch “**Browse**”.



- 2 Touch the desired list.



- Touch the desired item to display its list. Continue to touch the applicable screen button until its song list is displayed.

The selecting playlist screen is can be displayed from the “Options” screen. Touch “**Options**” and then touch “**Browse For Music**” on the next screen.

- 3 Touch the desired song.



INFORMATION

- USB memory only: Files that do not contain song title and/or album information will be displayed as “Unknown” in the “Artist” and/or “Album” list.
- While the media is being synchronized, a pop-up window is displayed. When synchronization is complete, a pop-up window will be displayed and the function will be available. Touch “OK” to return to the previous screen.

SELECTING BY LIST

The desired song can be selected from the current playlist.

- 1 Touch “List”.



- 2 Touch the desired song.



The list is can be displayed from the “Options” screen. Touch “Options” and then touch “Current Playlist” on the next screen.

SELECTING A DESIRED SONG USING “SEEK/TRACK” BUTTON OR “TUNE SCROLL” KNOB

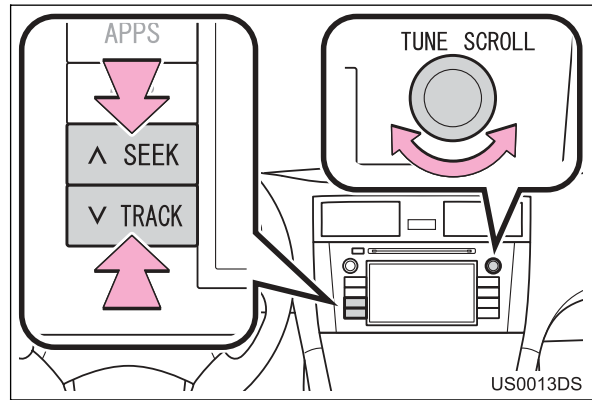

“SEEK/TRACK” button: Press the “^” or “v” of the “SEEK/TRACK” button to select a desired song.

“TUNE SCROLL” knob: Turn to select a desired song.

COVER ART FUNCTION

The album, that the song currently being listened to is from, is called up so that a song from it can be selected.

- 1 Touch the cover art.



- 2 A list of all the songs from the album will be displayed.



- 3 Touch the desired song.

INFORMATION

- If a song other than the one currently being listened to is selected, the current playlist is updated and will include all the songs from the album being listened to.
- It may take time to display iPod cover art. Only iPod cover art that is saved in JPEG format can be displayed.
- When Audio book or Podcast playlists are selected, this function is not available.

PLAYING “PLAY MORE LIKE THIS” FUNCTION

The system creates a new playlist containing songs similar to the one currently being listened to.

- 1 Touch “Play More Like This”.



- A pop-up window is displayed until the playlist is created. If you touch “**Cancel**” on the screen, the creation of the new playlist is cancelled.
- As soon as the new playlist is ready, the first similar song starts playing.

“Play More Like This” SETTING

The size of the playlist of similar songs can be set.

- 1 Touch “Options”.



2 Touch “Play More Like This Settings”.

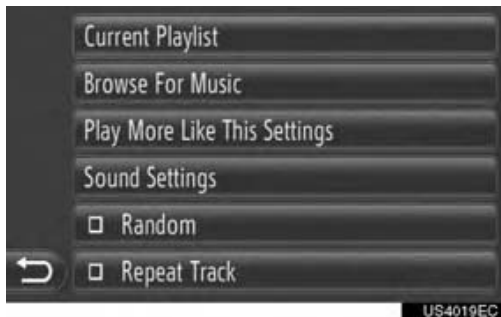

3 Touch the desired size of the playlist.

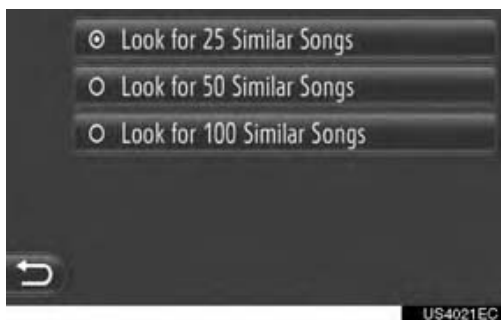

4 Touch .

REPEAT AND RANDOM PLAY FUNCTIONS

Repeat and random play functions are available.

FROM THE AUDIO CONTROL SCREEN

1 Touch  or .



 **(Repeat mode)**: Use it to automatically repeat the song you are currently listening to.

The repeat mode changes as follows each time the screen button is touched.

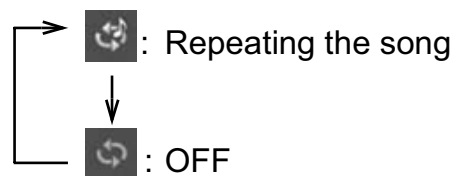

 **(Random mode)**: Use it for automatic random order in the current playlist.

The random mode changes as follows each time the screen button is touched.

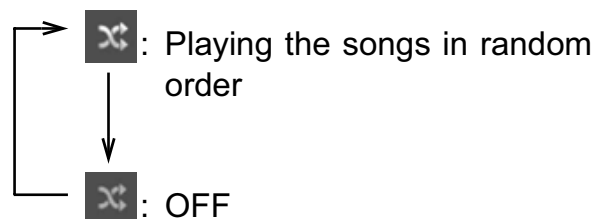

■ FROM THE “Options” SCREEN

1 Touch “Options”.



2 Touch “Random” or “Repeat Track”.

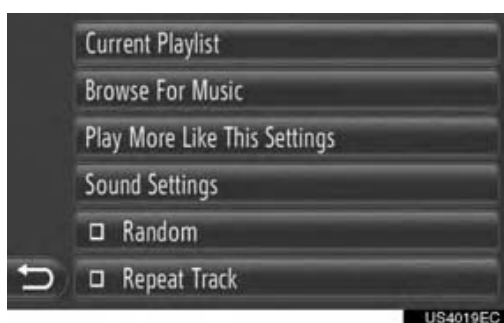

To cancel repeat or random order, touch “Random” or “Repeat Track” again.

INFORMATION

- When “Random” is on, the songs in the current playlist can be played in random order.

7. AUX DEVICE OPERATION

Connecting a portable audio device with the AUX port enables users to enjoy music via the vehicle speakers.

CAUTION

- Do not connect a portable audio device or operate the device controls while driving.

NOTICE

- Do not leave the portable audio device in the car. In particular, high temperatures inside the vehicle may damage the device.
- Do not push down on or apply unnecessary pressure to the portable audio device while it is connected as this may damage the device or its terminal.
- Do not insert foreign objects into the AUX port as this may damage the portable audio device or its terminal.

CONNECTING A PORTABLE AUDIO DEVICE

- 1 Open the cover of the USB/AUX port and connect a portable audio device.

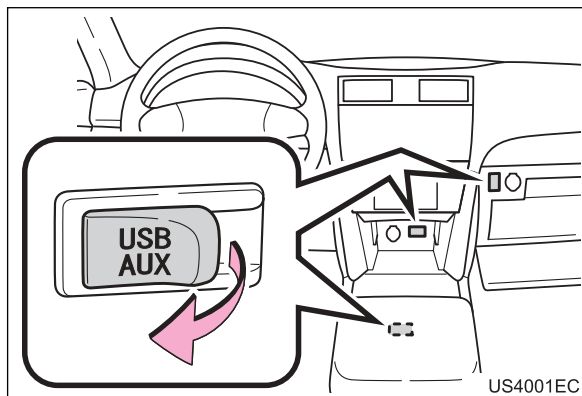

- The USB/AUX port is located on the instrument panel, or in the console box or glove box etc. The location and design are different depending on the vehicle. For details, see the Pictorial index of “*Owner’s Manual*”.

SWITCHING TO AUX MODE

- 1 Press the **“AUDIO”** button.

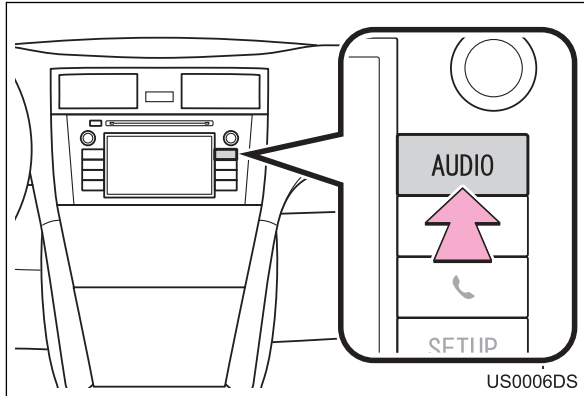

- The audio system turns on in the last mode used.

- 2 Touch **“Source”** on the screen.

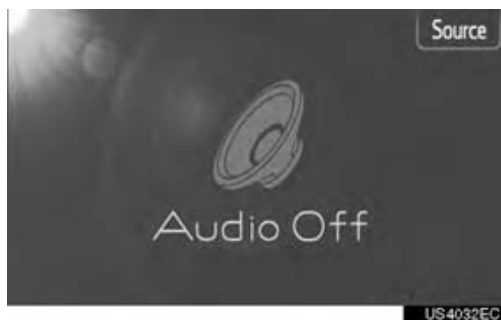

- 3 Touch **“AUX”** on the screen.



INFORMATION

- If no portable audio device is connected, **“AUX”** cannot be selected. Connect the portable audio device to the AUX port.

PLAYING A PORTABLE AUDIO DEVICE



- Only the volume can be adjusted using the audio system controls. The remaining controls need to be operated on the portable audio device itself.

- When you touch , you can adjust sound settings. (See pages 104 and 105)

8. Bluetooth® AUDIO OPERATION

The Bluetooth® audio system enables users to enjoy music played on a portable player from the vehicle speaker via wireless communication.

If your portable player does not support Bluetooth®, the Bluetooth® audio system will not function.



CAUTION

- Do not operate the player's controls or connect to the Bluetooth® audio system while driving.



NOTICE

- Do not leave your portable audio player in the car. In particular, high temperatures inside the vehicle may damage the portable audio player.

INFORMATION

- In the following conditions, the system may not function.
 - The portable audio player is turned off.
 - The portable audio player is not connected.
 - The portable audio player has a low battery.
- Depending on the portable audio player that is connected to the system, certain functions may not be available.
- It may take time, the phone connection is carried out during Bluetooth® audio play.



Bluetooth is a registered trademark of Bluetooth SIG, Inc.

INFORMATION

- Portable audio players must correspond to the following specifications in order to be connected to the Bluetooth® audio system. However, please note that some functions may be limited depending on the type of portable audio player.
 - Bluetooth® Specification
Ver.1.1 or higher
(Recommended: Ver.2.1+EDR or higher)
 - Profile
A2DP (Advanced Audio Distribution Profile)
Ver.1.0 or higher
(Recommended: Ver.1.2 or higher)
AVRCP (Audio/Video Remote Control Profile)
Ver.1.0 or higher
(Recommended: Ver.1.4 or higher)

! CAUTION

- **FCC WARNING:** Changes or modifications not expressly approved by the party responsible for compliance could void the user's authority to operate the equipment.
- **CAUTION: Radio Frequency Radiation Exposure**
This equipment complies with FCC radiation exposure limits set forth for uncontrolled equipment and meets the FCC radio frequency (RF) Exposure Guidelines in Supplement C to OET65 and RSS-102 of the IC radio frequency (RF) Exposure rules. This equipment has very low levels of RF energy that it deemed to comply without maximum permissive exposure evaluation (MPE). But it is desirable that it should be installed and operated with at least 20 cm and more between the radiator and person's body (excluding extremities: hands, wrists, feet and ankles).
- **Co-location:** This transmitter must not be co-located or operated in conjunction with any other antenna or transmitter.

SWITCHING TO Bluetooth® AUDIO MODE

1 Press the **"AUDIO"** button.

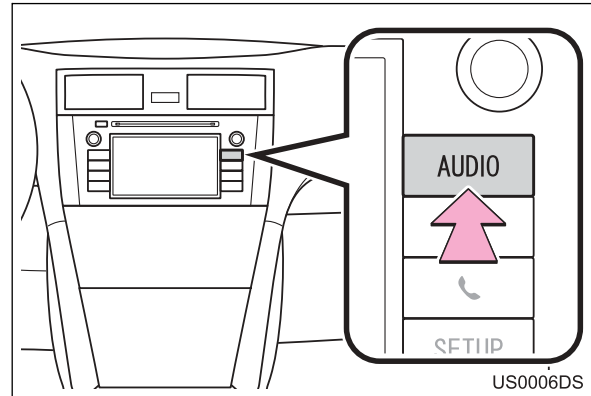

The audio system turns on in the last mode used.

2 Touch **"Source"** on the screen.

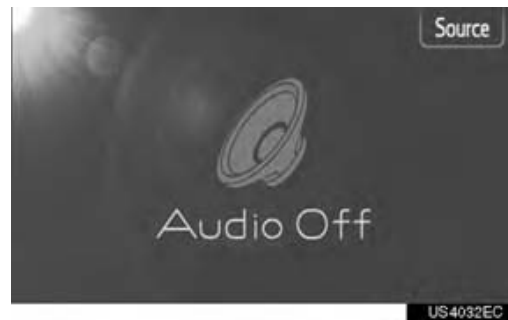

3 Touch **"Bluetooth¹"**.



If a Bluetooth® audio device is not connected, the connecting Bluetooth® audio screen will automatically appear.

¹: Bluetooth is a registered trademark of Bluetooth SIG, Inc.

CONNECTING Bluetooth® AUDIO

In order to use the Bluetooth® audio system, it is necessary to pair a portable player and connect the audio profile (A2DP) with the system. (In this manual, pairing refers to a Bluetooth® device connecting with the system. Connecting refers to the paired device's profile(s) being connected to the system.)

Once you have connected a device with audio profile (A2DP), you can enjoy your music on the vehicle's audio system.

If you have not yet connected a portable player with audio profile (A2DP), you must first pair a portable player with audio profile (A2DP) according to the following procedures. Connect your portable player with audio profile (A2DP) after bringing the vehicle to a complete stop.

See "Bluetooth® SETTINGS" on page 202 of additional registration when registering.

CONNECTING Bluetooth® AUDIO

CONNECTING FROM THE SYSTEM

- 1 Switching to Bluetooth® audio mode. (See page 133.)
- 2 Touch "Search Bluetooth¹ Devices".



- 3 Touch "Search for Bluetooth¹ Devices".



When a Bluetooth® device is currently connected, a pop-up window is displayed. To disconnect it, touch "Yes".

¹: Bluetooth is a registered trademark of Bluetooth SIG, Inc.

- 4 The following screen will be displayed while searching for a Bluetooth® device.



- ‘ To cancel this function, touch “**Cancel**”.

- 5 Touch the device to be paired.



- ‘ Connectable Bluetooth® devices are listed on the display.

- 6 The following screen will be displayed.



- ‘ To cancel this function, touch “**Cancel**”.

- 7 Confirm the PIN.

- i If the device supports SSP (Secure Simple Pairing)

- ‘ Confirm the PIN displayed on the screen, and then touch “**Accept**”.

- i If the device does not supports SSP (Secure Simple Pairing)

- ‘ Input the PIN displayed on the screen into your portable player.

- 8 The following screen will be displayed when pairing is complete.



- 9 The system waits for connection requests coming from the paired device. All requested profiles are connected automatically.

- ‘ If the automatic connection failed, the following screen will be displayed. Touch “**Connect for Music**”.



- ‘ Once a portable player has been connected, it will be automatically connected whenever the engine switch is in the “ACC” or “ON” position.

INFORMATION

- For details on device detection and operation of the portable player, refer to the manual that comes with the portable audio player.

CONNECTING FROM THE DEVICE

1 Switching to Bluetooth® audio mode. (See page 133.)

2 Touch “**Search Bluetooth¹ Devices**”.



3 Touch “**Make Discoverable**”.



‘ When a Bluetooth® device is currently connected, a pop-up window is displayed. To disconnect it, touch “**Yes**”.

4 The following screen will be displayed.



‘ To cancel this function, touch “**Cancel**”.

¹: Bluetooth is a registered trademark of Bluetooth SIG, Inc.

5 Confirm the PIN.

i If the device supports SSP (Secure Simple Pairing)

‘ Confirm the PIN displayed on the screen, and then touch “**Accept**”.

i If the device does not supports SSP (Secure Simple Pairing)

‘ Input the PIN displayed on the screen into your portable player.

RECONNECTING Bluetooth® AUDIO

If a portable player is disconnected due to poor reception from the Bluetooth® network when the engine switch is in the “ACC” or “ON” position, the system will automatically reconnect the portable player.

If the Bluetooth® device is disconnected on purpose, such as it was turned off, this does not happen. Reconnect it manually using either of the following methods:

- Select a portable player again. (See page 206.)
- Connect the audio profile. (See page 203.)

PLAYING Bluetooth® AUDIO

PLAYING A SONG

The title of the song, album and artist name of the song currently being listened to will be displayed.

PLAY AND PAUSE



: Touch to pause the song.

: Touch to resume playing the song.

When you touch , you can adjust sound settings. (See pages 104 and 105)

INFORMATION

- The progress bar indicator does not always correspond to the actual elapsed playback position.
- If the song’s data does not contain an ID3 tag, the file and folder name will be displayed instead of the song and album title. Please note that the file name will not include the file’s extension.
- Bluetooth® audio screen may differ depending on your device.

FAST FORWARD AND REVERSE

- 1 Press and hold the “^” or “v” of the “**SEEK/TRACK**” button to fast forward or reverse. When the button is released, the player will start playing from that position.

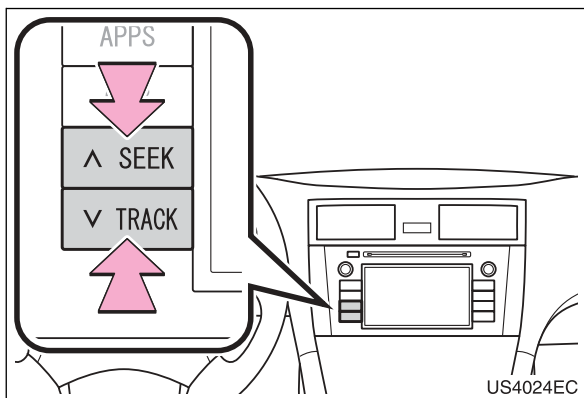

SELECTING A DESIRED SONG

SELECTING A PLAYLIST

Songs can be sorted and selected from various playlists.

- 1 Touch “**Browse**”.



- 2 Touch the desired list.

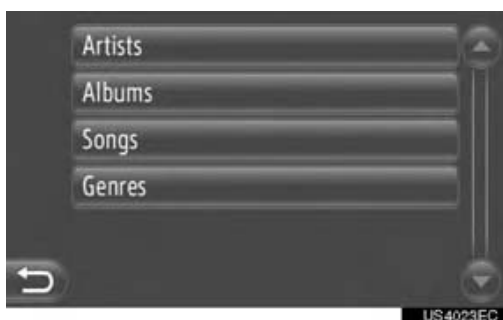

- ‘ Touch the desired item to display its list. Continue to touch the applicable screen button until its song list is displayed.

The selecting playlist screen is can be displayed from the “Options” screen. Touch “**Options**” and then touch “**Browse For Music**” on the next screen.

- 3 Touch the desired song.



INFORMATION

- Files that do not contain song title and/or album information will be displayed as “Unknown” in the “Artist” and/or “Album” list.
- This function may not be available depending on the portable audio player.

■ SELECTING BY LIST

The desired song can be selected from the current playlist.

1 Touch “List”.



2 Touch the desired song.



The list can be displayed from the “Options” screen. Touch “**Options**” and then touch “**Current Playlist**” on the next screen.

INFORMATION

- This function may not be available depending on the portable audio player.

■ SELECTING A DESIRED SONG USING “SEEK/TRACK” BUTTON OR “TUNE SCROLL” KNOB

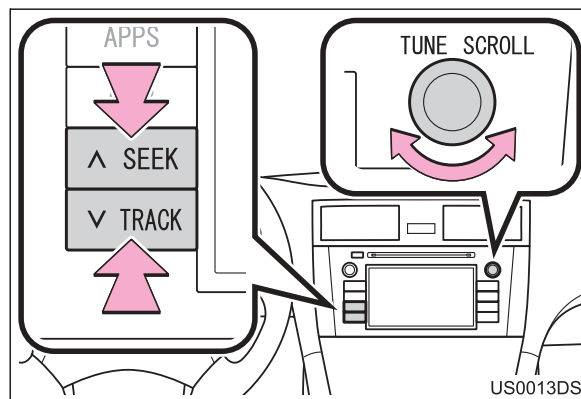

“**SEEK/TRACK**” button: Press the “^” or “v” of the “**SEEK/TRACK**” button to select a desired song.

“**TUNE SCROLL**” knob: Turn to select a desired song.

REPEAT AND RANDOM PLAY FUNCTIONS

Repeat and random play functions are available.

FROM THE AUDIO CONTROL SCREEN

1 Touch  or .



 **(Repeat mode)**: Use it to automatically repeat the song you are currently listening to.

The repeat mode changes as follows each time the screen button is touched.

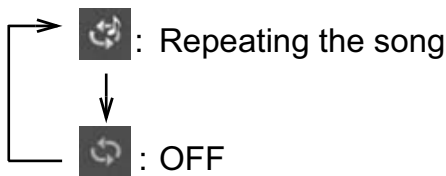

 **(Random mode)**: Use it for automatic random order in the current playlist.

The random mode changes as follows each time the screen button is touched.

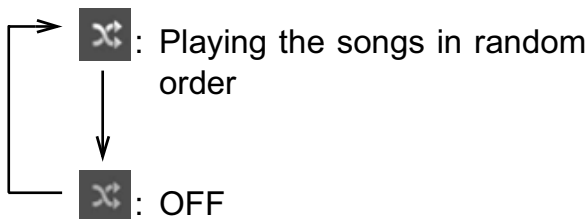

FROM THE “Options” SCREEN

1 Touch “Options”.



2 Touch “Random” or “Repeat Track”.

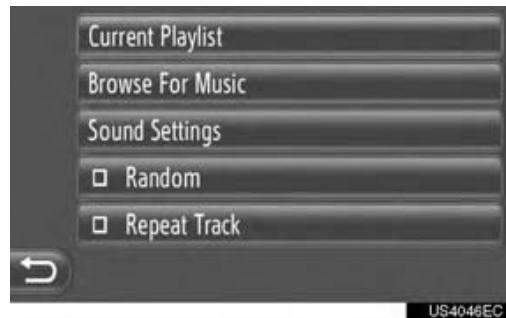

To cancel repeat or random order, touch “Random” or “Repeat Track” again.

INFORMATION

- When “Random” is on, the songs in the current playlist can be played in random order.

9. STEERING SWITCHES

Some parts of the audio system can be adjusted with the switches on the steering wheel.

STEERING SWITCHES (WITH TWO DIRECTION STEERING SWITCH)

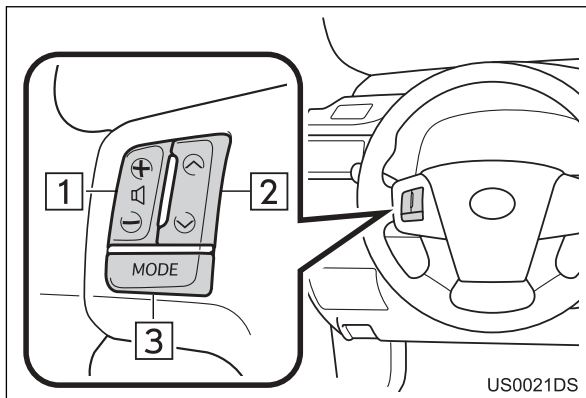

- The design and switch position may differ depending on the vehicle. For details, see the Pictorial index of "Owner's Manual".
- Details of the specific switches, controls, and features are described below.

No.	Switch
1	Volume control switch
2	"Λ" "V" switch
3	"MODE" switch

- 1 Volume control switch
- Press the "+" side to increase the volume. The volume continues to increase while the switch is being pressed.
 - Press the "-" side to decrease the volume. The volume continues to decrease while the switch is being pressed.

2 "Λ" "V" switch

i Radio

To select a preset station: Press the "Λ" or "V" switch.

To seek a radio station: Press and hold the "Λ" or "V" switch until you hear a beep. If you press either the "Λ" or "V" switch in seek mode, the seek mode will be cancelled.

i CD player

To select a desired track or file: Press the "Λ" or "V" switch.

To select a desired folder (MP3/WMA): Press and hold the "Λ" or "V" switch until you hear a beep.

i USB memory/iPod

To select a desired song: Press the "Λ" or "V" switch.

Fast forward and reverse: Press and hold the "Λ" or "V" switch until you hear a beep.

i Bluetooth® audio player

To select a desired song: Press the "Λ" or "V" switch.

Fast forward and reverse: Press and hold the "Λ" or "V" switch until you hear a beep.

3 "MODE" switch

- Press the "MODE" switch to select an audio mode. Each press changes the mode sequentially if the desired mode is ready to use.

- To turn the audio system on, press the "MODE" switch.

- Press and hold the "MODE" switch until you hear a beep and the music will pause or be muted. By the same operation, it is released.

STEERING SWITCHES (WITH FOUR DIRECTION STEERING SWITCH)

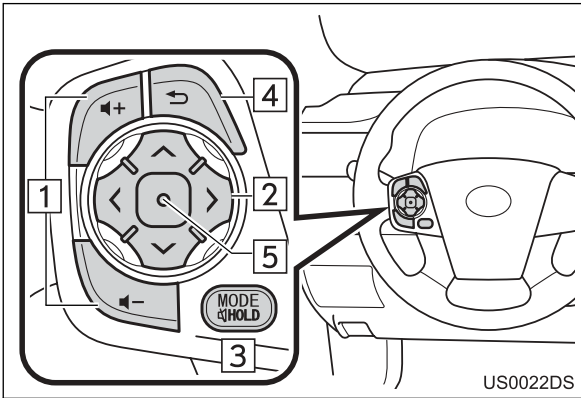

- ‘ The design and switch position may differ depending on the vehicle. For details, see the Pictorial index of “*Owner’s Manual*”.
- ‘ Details of the specific switches, controls, and features are described below.

No.	Switch
1	Volume control switch
2	“^” “v” “>” “<” switch
3	“MODE/HOLD” switch
4	Back switch
5	Enter switch

1 Volume control switch

- ‘ Press the “+” side to increase the volume. The volume continues to increase while the switch is being pressed.
- ‘ Press the “-” side to decrease the volume. The volume continues to decrease while the switch is being pressed.

2 “^” “v” “>” “<” switch

i Radio

To select a preset station: Press the “^” or “v” side of the switch. Repeat this to select the next preset station.

To seek a station: Press and hold the “^” or “v” side of the switch until a beep is heard. Repeat this to find the next station. If either side of the switch is pressed during seek mode, seeking will be canceled.

To change the preset page: The radio’s preset page can be changed by pressing the “>” or “<” side of the switch.

i CD player

To select a desired track or file: Press the “^” or “v” side of the switch until the desired track or file to play is selected. To return to the beginning of the current track or file, press the “v” side of the switch once quickly.

To select a desired folder (MP3/WMA): Press the “>” or “<” switch to change to the next or the previous folder.

i USB memory/iPod

To select a desired song: Press the “^” or “v” switch until the desired song is selected.

Fast forward and reverse: Press and hold the “^” or “v” switch until you hear a beep.

i Bluetooth® audio player

To select a desired song: Press the “^” or “v” side of the switch until the desired song is selected.

Fast forward and reverse: Press and hold the “^” or “v” switch until you hear a beep.

3 “**MODE/HOLD**” switch

- ‘ Press the “**MODE/HOLD**” switch to select an audio mode. Each press changes the mode sequentially if the desired mode is ready to use.
- ‘ To turn the audio system on, press the “**MODE/HOLD**” switch.
- ‘ Press and hold the “**MODE/HOLD**” switch until you hear a beep and the music will pause or be muted. By the same operation, it is released.

4 Back switch

- ‘ Press the back switch to return to the previous screen.

5 Enter switch

- ‘ When in radio mode, pressing the enter switch returns to the preset screen.
- ‘ When in media mode, pressing the enter switch returns to the list screen.

10. AUDIO SYSTEM OPERATING HINTS



NOTICE

- To avoid damaging the audio system:
 - Be careful not to spill beverages over the audio system.
 - Do not put anything other than on appropriate discs into the CD player slot.

INFORMATION

- The use of a cellular phone inside or near the vehicle may cause a noise from the speakers of the audio system which you are listening to. However, this does not indicate a malfunction.

RADIO RECEPTION

Usually, a problem with radio reception does not mean there is a problem with your radio ∞ it is just the normal result of conditions outside the vehicle.

For example, nearby buildings and terrain can interfere with FM reception. Power lines or telephone wires can interfere with AM signals. And of course, radio signals have a limited range, and the farther you are from a station, the weaker its signal will be. In addition, reception conditions change constantly as your vehicle moves.

Here are some common reception problems that probably do not indicate a problem with your radio.

FM

Fading and drifting stations: Generally, the effective range of FM is about 25 miles (40 km). Once outside this range, you may notice fading and drifting, which increase with the distance from the radio transmitter. They are often accompanied by distortion.

Multi-path: FM signals are reflective, making it possible for two signals to reach your antenna at the same time. If this happens, the signals will cancel each other out, causing a momentary flutter or loss of reception.

Static and fluttering: These occur when signals are blocked by buildings, trees, or other large objects. Increasing the bass level may reduce static and fluttering.

Station swapping: If the FM signal you are listening to is interrupted or weakened, and there is another strong station nearby on the FM band, your radio may tune in the second station until the original signal can be picked up again.

AM

Fading: AM broadcasts are reflected by the upper atmosphere ∞ especially at night. These reflected signals can interfere with those received directly from the radio station, causing the radio station to sound alternately strong and weak.

Station interference: When a reflected signal and a signal received directly from a radio station are very nearly the same frequency, they can interfere with each other, making it difficult to hear the broadcast.

Static: AM is easily affected by external sources of electrical noise, such as high tension power lines, lightning, or electrical motors. This results in static.

XM®

- ‘ Cargo loaded on the roof luggage carrier, especially metal objects, may adversely affect the reception of XM® Satellite Radio.
- ‘ Alternation or modifications carried out without appropriate authorization may invalidate the user’s right to operate the equipment.

iPod

ABOUT iPod

- ‘ “Made for iPod” and “Made for iPhone” means that an electronic accessory has been designed to connect specifically to iPod, or iPhone, respectively, and has been certified by the developer to meet Apple performance standards.
- ‘ Apple is not responsible for the operation of this device or its compliance with safety and regulatory standards.
- ‘ iPhone, iPod, iPod classic, iPod nano, iPod shuffle, and iPod touch are trademarks of Apple Inc., registered in the U.S. and other countries.

COMPATIBLE MODELS

Model	Generation	Software Version
iPod	5G	1.3.0
iPod classic	1G	1.1.2
	2G	2.0.1
	2009 (160GB)	2.0.4
iPod nano	1G	1.3.1
	3G	1.1.3
	4G	1.0.4
	5G	1.0.2
	6G	1.0.0
iPod touch	1G	iOS 3.1.3
	2G	iOS 3.1.3 iOS 4.2.1
	2009 (8GB)	
	3G	
	4G	iOS 4.2.1
iPhone	iPhone	iOS 3.1.3
	iPhone 3G	iOS 3.1.3 iOS 4.2.1
	iPhone 3GS	
	iPhone 4	iOS 4.2.1

Depending on differences between models or software versions etc., some models listed above might be incompatible with this system.

iPad is not compatible with this system.

USB MEMORY

- USB memory that can be used for MP3 and WMA playback.
 - USB communication formats: USB 2.0 FS (12 Mbps)
 - File formats: FAT 16/32 (Windows®)
 - Correspondence class: Mass storage class

CARING FOR YOUR CD PLAYER AND DISCS

- Your CD player is intended for use with 4.7 in. (12 cm) discs only. To play 3 in. (8 cm) discs, use an adaptor.
- Extremely high temperatures can keep your CD player from working. On hot days, use air conditioning to cool the vehicle interior before you listen to a disc.
- Bumpy roads or other vibrations may make your CD player skip.
- If moisture gets into your CD player, you may not hear any sound even though your CD player appears to be working. Remove the discs from the CD player and wait until it dries.

CAUTION

- CD player uses an invisible laser beam which could cause hazardous radiation exposure if directed outside the unit. Be sure to operate the CD player correctly.

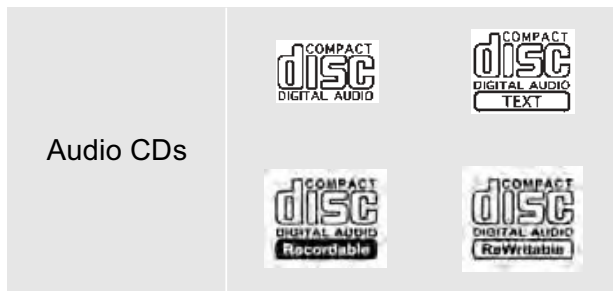

- Use only discs marked as shown above. The following products may not be playable on your CD player.

- SACDs
- dts CDs
- Copy-protected CDs
- Video CDs

i Special shaped discs

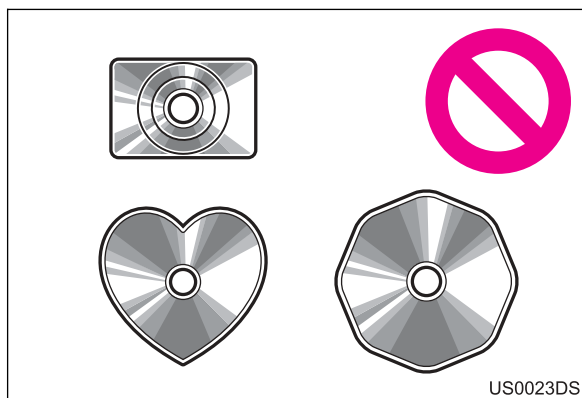

i Transparent/translucent discs

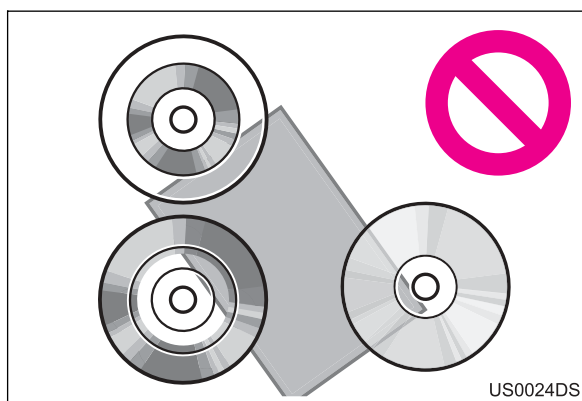

i Low quality discs

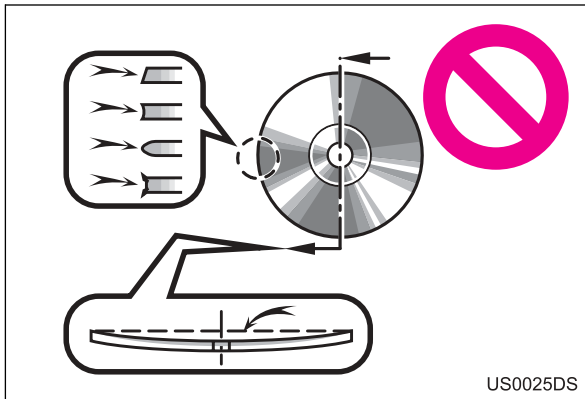

US0025DS

i Labeled discs

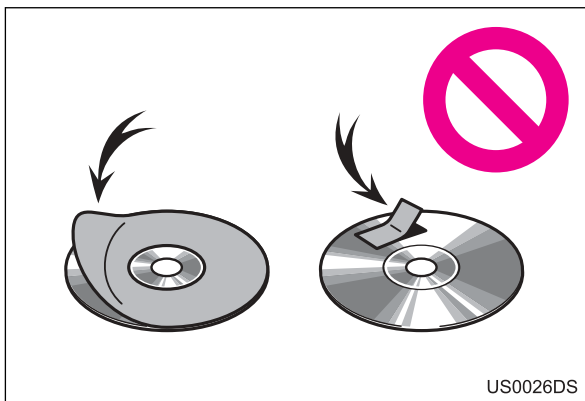

US0026DS

NOTICE

- Do not use special shaped, transparent/translucent, low quality or labeled discs such as those shown in the illustrations. The use of such discs may damage the player, or it may be impossible to eject the disc.
- This system is not designed for use of Dual Disc. Do not use Dual Disc because it may cause damage to the player.

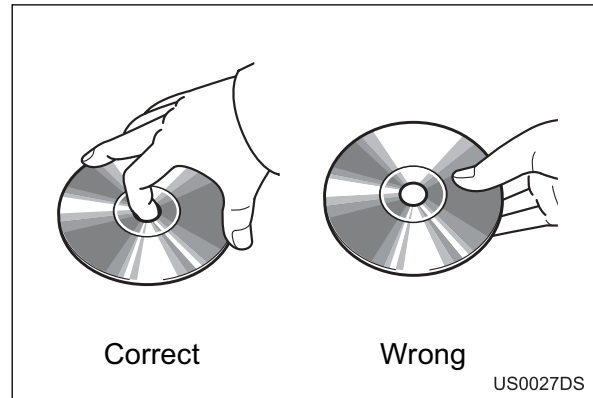

US0027DS

- Handle discs carefully, especially when you are inserting them. Hold them on the edge and do not bend them. Avoid getting fingerprints on them, particularly on the shiny side.
- Dirt, scratches, warping, pin holes, or other disc damage could cause the CD player to skip or to repeat a section of a track. (To see a pin hole, hold the disc up to the light.)
- Remove discs from the CD player when you are not using them. Store them in their plastic cases away from moisture, heat, and direct sunlight.

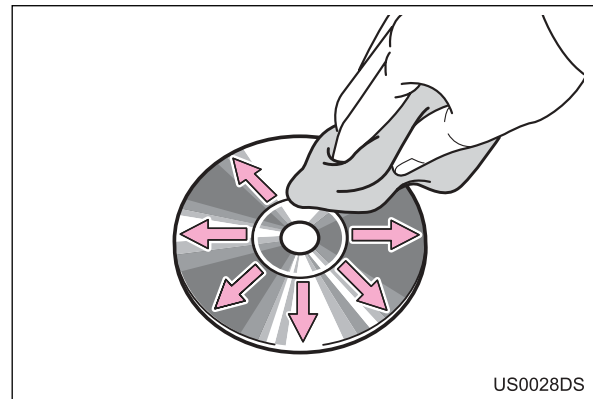

US0028DS

- **To clean a disc:** Wipe it with a soft, lint-free cloth that has been dampened with water. Wipe in a straight line from the center to the edge of the disc (not in a circle). Do not use a conventional record cleaner or anti-static device.

MP3/WMA FILES

- ‘ MP3 (MPEG Audio Layer 3) and WMA (Windows Media Audio) are audio compression standards.
- ‘ The MP3/WMA player can play MP3 and WMA files on CD-ROM, CD-R and CD-RW discs.
The unit can play disc recordings compatible with ISO 9660 level 1,2 (Romeo Joliet) and UDF (2.01 or lower) file system.
- ‘ When naming an MP3 or WMA file, add the appropriate file extension (.mp3 or .wma).
- ‘ The MP3/WMA player plays back files with .mp3 or .wma file extensions as MP3 or WMA files. To prevent noise and playback errors, use the appropriate file extensions.
- ‘ The player can play only the first session using multi-session compatible CDs.
- ‘ MP3 files are compatible with the ID3 Tag Ver. 1.0, Ver. 1.1, Ver. 2.2, and Ver. 2.3 formats. The unit cannot display disc title, track title and artist name in other formats.
- ‘ USB memory: MP3 files are compatible with the ID3 Tag Ver. 1.0, Ver. 1.1, Ver. 2.2, Ver. 2.3 and Ver. 2.4 formats. The unit cannot display track title and artist name in other formats.
- ‘ WMA files can contain a WMA tag that is used in the same way as an ID3 tag. WMA tags carry information such as track title, artist name.
- ‘ The sound quality of MP3/WMA files generally improves with higher bit rates. In order to achieve a reasonable level of sound quality, files recorded with a bit rate of at least 128 kbps are recommended.

SAMPLING FREQUENCY

MP3 files:

MPEG 1 AUDIO LAYER 3 ∞ #2, 44.1, 48 kHz

MPEG2 AUDIO LAYER3 ∞ #16, 22.05, 24 kHz

WMA files for WMA player:

Ver. 7, 8, 9 CBR ∞ 32, 44.1, 48 kHz

WMA files for USB memory:

Ver. 7, 8, 9 ∞ HIGH PROFILE 32, 44.1, 48 kHz

PLAYABLE BIT RATES

MP3 files for MP3 player:

MPEG1 LAYER3 ∞ 32 to 320 kbps

MPEG2 LSF LAYER3 ∞ 8 to 160 kbps

MP3 files for USB memory:

MPEG 1 AUDIO LAYER 2, 3 ∞ 32 to 320 kbps

MPEG 2 AUDIO LAYER 2, 3 ∞ 8 to 160 kbps

WMA files for WMA player:

Ver. 7, 8 CBR ∞ 48 to 192 kbps

Ver. 9 CBR ∞ 48 to 320 kbps

WMA files for USB memory:

Ver. 7, 8, 9 CBR ∞ 48 to 320 kbps

- ‘ M3u playlists are not compatible with the audio player.
- ‘ MP3i (MP3 interactive) and MP3PRO formats are not compatible with the audio player.
- ‘ The player is compatible with VBR (Variable Bit Rate).
- ‘ When playing back files recorded as VBR (Variable Bit Rate) files, the play time will not be correctly displayed if fast-forward or reverse operations are used.
- ‘ It is not possible to check folders that do not include MP3/WMA files.

- MP3/WMA files in folders up to 8 levels deep can be played. However, the start of playback may be delayed when using discs containing numerous levels of folders. For this reason, we recommend creating discs with no more than two levels of folders.
- WMA files Ver. 9 depends on “Windows Media® Audio Standard”.

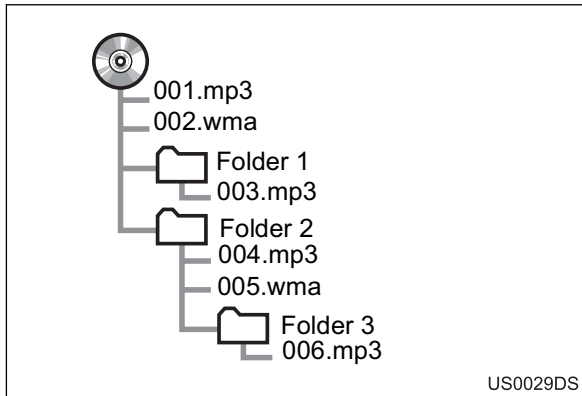

- The play order of the compact disc with the structure shown on the left is as follows:

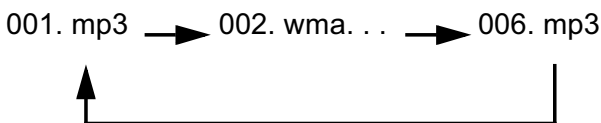

- MP3/WMA player: It is possible to play up to 192 folders or 255 files on one disc.
- USB memory:
 - Maximum number of folder in device: 3000
 - Maximum number of files in one folder: 255
 - Maximum number of files in device: 9999
- The order changes depending on the PC and MP3/WMA encoding software you use.

CD-R AND CD-RW DISCS

- CD-R/CD-RW discs that have not been subject to the “finalizing process” (a process that allows discs to be played on a conventional CD player) cannot be played.
- It may not be possible to play CD-R/CD-RW discs recorded on a music CD recorder or a personal computer because of disc characteristics, scratches or dirt on the disc, or dirt, condensation, etc. on the lens of the unit.
- It may not be possible to play discs recorded on a personal computer depending on the application settings and the environment. Record with the correct format. (For details, contact the appropriate application manufacturers of the applications.)
- CD-R/CD-RW discs may be damaged by direct exposure to sunlight, high temperatures or other storage conditions. The unit may be unable to play some damaged discs.
- If you insert a CD-RW disc into the MP3/WMA player, playback will begin more slowly than with a conventional CD or CD-R disc.
- Recordings on CD-R/CD-RW cannot be played using the DDCD (Double Density CD) system.

TERMS

PACKET WRITE

- ‘ This is a general term that describes the process of writing data on-demand to CD-R, etc., in the same way that data is written to floppy or hard discs.

ID3 TAG

- ‘ This is a method of embedding track-related information in an MP3 file. This embedded information can include the track title, the artist's name, the album title, the music genre, the year of production, comments and other data. The contents can be freely edited using software with ID3 tag editing functions. Although the tags are restricted to the number of characters, the information can be viewed when the track is played back.

WMA TAG

- ‘ WMA files can contain a WMA tag that is used in the same way as an ID3 tag. WMA tags carry information such as track title, artist name.

ISO 9660 FORMAT

- ‘ This is the international standard for the formatting of CD-ROM folders and files. For the ISO 9660 format, there are two levels of regulations.
- ‘ Level 1: The file name is in 8.3 format (8 character file names, with a 3 character file extension. File names must be composed of one-byte capital letters and numbers. The “_” symbol may also be included.)
- ‘ Level 2: The file name can have up to 31 characters (including the separation mark “.” and file extension). Each folder must contain fewer than 8 hierarchies.

m3u

- ‘ Playlists created using “WINAMP” software have a playlist file extension (.m3u).

MP3

- ‘ MP3 is an audio compression standard determined by a working group (MPEG) of the ISO (International Standard Organization). MP3 compresses audio data to about 1/10 the size of that on conventional discs.

WMA

- ‘ WMA (Windows Media Audio) is an audio compression format developed by Microsoft®. It compresses files into a size smaller than that of MP3 files. The decoding formats for WMA files are Ver. 7, 8, and 9.

Gracenote®

Music recognition technology and related data are provided by Gracenote®. Gracenote is the industry standard in music recognition technology and related content delivery. For more information visit www.gracenote.com.

Gracenote® End User License Agreement

This application or device contains software from Gracenote, Inc. of Emeryville, California ("Gracenote"). The software from Gracenote (the "Gracenote Software") enables this application to perform disc and/or file identification and obtain music-related information, including name, artist, track, and title information ("Gracenote Data") from online servers or embedded databases (collectively, "Gracenote Servers") and to perform other functions. You may use Gracenote Data only by means of the intended End-User functions of this application or device.

You agree that you will use Gracenote Data, the Gracenote Software, and Gracenote Servers for your own personal non-commercial use only. You agree not to assign, copy, transfer or transmit the Gracenote Software or any Gracenote Data to any third party. **YOU AGREE NOT TO USE OR EXPLOIT GRACENOTE DATA, THE GRACENOTE SOFTWARE, OR GRACENOTE SERVERS, EXCEPT AS EXPRESSLY PERMITTED HEREIN.**

You agree that your non-exclusive license to use the Gracenote Data, the Gracenote Software, and Gracenote Servers will terminate if you violate these restrictions. If your license terminates, you agree to cease any and all use of the Gracenote Data, the Gracenote Software, and Gracenote Servers. Gracenote reserves all rights in Gracenote Data, the Gracenote Software, and the Gracenote Servers, including all ownership rights. Under no circumstances will Gracenote become liable for any payment to you for any information that you provide. You agree that Gracenote, Inc. may enforce its rights under this Agreement against you directly in its own name.

The Gracenote service uses a unique identifier to track queries for statistical purposes. The purpose of a randomly assigned numeric identifier is to allow the Gracenote service to count queries without knowing anything about who you are. For more information, see the web page for the Gracenote Privacy Policy for the Gracenote service.

The Gracenote Software and each item of Gracenote Data are licensed to you "AS IS." Gracenote makes no representations or warranties, express or implied, regarding the accuracy of any Gracenote Data from in the Gracenote Servers. Gracenote reserves the right to delete data from the Gracenote Servers or to change data categories for any cause that Gracenote deems sufficient. No warranty is made that the Gracenote Software or Gracenote Servers are error-free or that functioning of Gracenote Software or Gracenote Servers will be uninterrupted. Gracenote is not obligated to provide you with new enhanced or additional data types or categories that Gracenote may provide in the future and is free to discontinue its services at any time.

GRACENOTE DISCLAIMS ALL WARRANTIES EXPRESS OR IMPLIED, INCLUDING, BUT NOT LIMITED TO, IMPLIED WARRANTIES OF MERCHANTABILITY, FITNESS FOR A PARTICULAR PURPOSE, TITLE, AND NON-INFRINGEMENT. GRACENOTE DOES NOT WARRANT THE RESULTS THAT WILL BE OBTAINED BY YOUR USE OF THE GRACENOTE SOFTWARE OR ANY GRACENOTE SERVER. IN NO CASE WILL GRACENOTE BE LIABLE FOR ANY CONSEQUENTIAL OR INCIDENTAL DAMAGES OR FOR ANY LOST PROFITS OR LOST REVENUES.

copyright © 2000 to present
Gracenote

Bluetooth® HANDS-FREE SYSTEM

1 BASIC INFORMATION BEFORE OPERATION

- 1. **QUICK REFERENCE**..... 154
- 2. **HANDS-FREE SYSTEM** 157
 - USING THE PHONE SWITCH 158
 - ABOUT THE PHONE BOOK IN THIS SYSTEM 159
 - WHEN YOU RELEASE YOUR CAR ... 159
- 3. **CONNECTING A Bluetooth® PHONE**..... 161
 - CONNECTING A Bluetooth® PHONE 161
- 4. **REGISTERING A ENTRY** 165
 - REGISTERING A NEW ENTRY 165
 - REGISTERING A ENTRY AS “Speed Dials” 167
 - DISPLAYING AND EDITING THE ENTRY INFORMATION..... 168
 - SENDING STORED CONTACTS TO A USB MEMORY 169

2 TELEPHONE OPERATION

- 1. **CALLING ON A Bluetooth® PHONE**..... 170
 - BY DIAL 170
 - BY “Stored” LIST ON THE “Contacts” SCREEN..... 170
 - BY PHONE BOOK..... 171

- BY SPEED DIALS..... 172
- BY CALL HISTORY 173
- CALLING USING A SHORT MESSAGE..... 173
- BY POI* CALL..... 174

- 2. **RECEIVING CALLS ON A Bluetooth® PHONE** 175
- 3. **TALKING ON A Bluetooth® PHONE** 176
 - ADJUSTING THE RECEIVER VOLUME 177
 - SENDING TONES 177
 - DIALING A SECOND NUMBER 177

3 SHORT MESSAGE FUNCTION

- 1. **SHORT MESSAGE FUNCTION** 179
 - RECEIVING A NEW SHORT MESSAGE..... 179
 - CHECKING RECEIVED SHORT MESSAGES 179
 - CHECKING SENT SHORT MESSAGES 180
 - SENDING A NEW SHORT MESSAGES 180

*: Point of Interest

1. BASIC INFORMATION BEFORE OPERATION

1. QUICK REFERENCE

Pressing the  button allows access to the “Phone” menu screen.

When the  button is pressed, the screen that was last displayed is returned

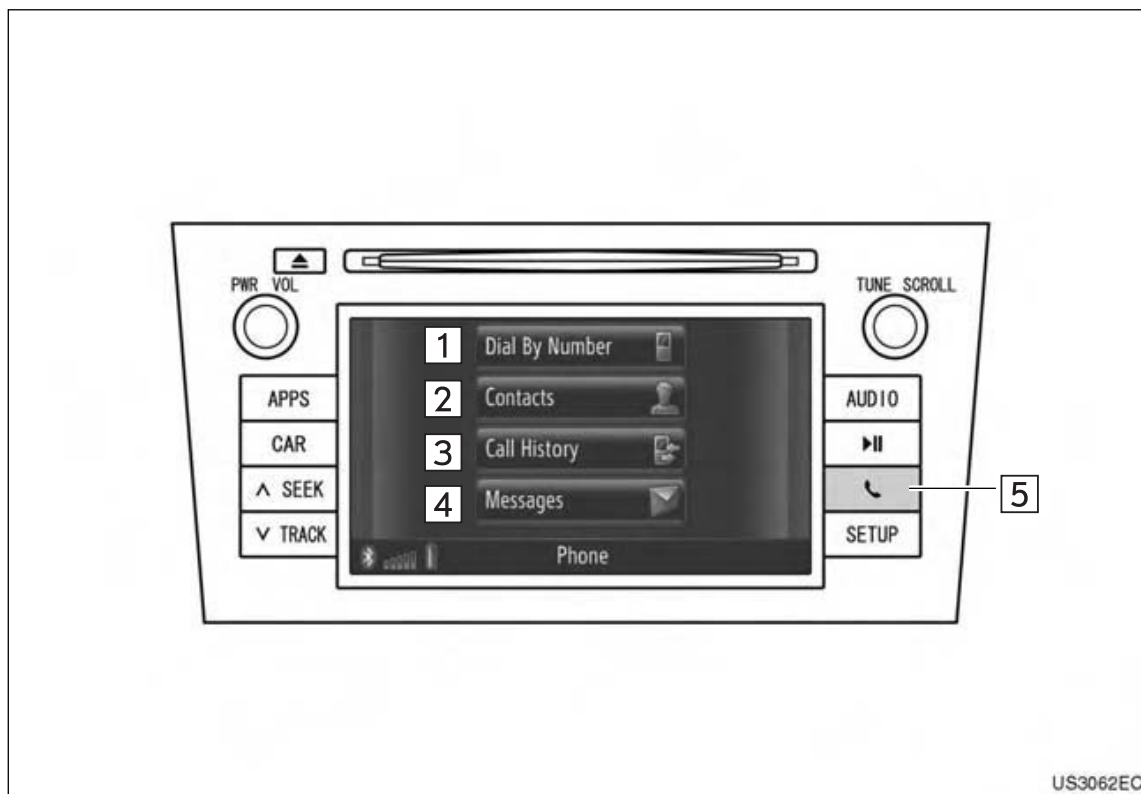

to. Touch  to display the “Phone” menu screen.

i “Phone” menu screen



* The actual design and button position may differ depending on the vehicle. For details, see Section 3 of “Owner’s Manual”.

No.	Function	Page
1	Touch to display the “Dial By Number” screen. A call can be made by dialing the number.	155, 170
2	Touch to display the “Contacts” screen. An entry from the list of contacts in the “Stored” screen, “Phone Book” or “Speed Dials” can be selected and called.	170, 171, 172
3	Touch to display the “Call History” screen. An entry from the missed, received or dial call lists can be selected and called.	173
4	Touch to display the “Messages” screen. A list of received and sent short messages and a menu to create new short messages can be displayed.	179
5	Touch to display the “Phone” menu screen.	∞

To display the “Dial By Number” screen, touch **“Dial By Number”** on the “Phone” menu screen, or touch  on any of the “Phone” screens. The “Dial By Number” screen can also be displayed by pressing the  switch on the steering wheel.

i “Dial By Number” screen

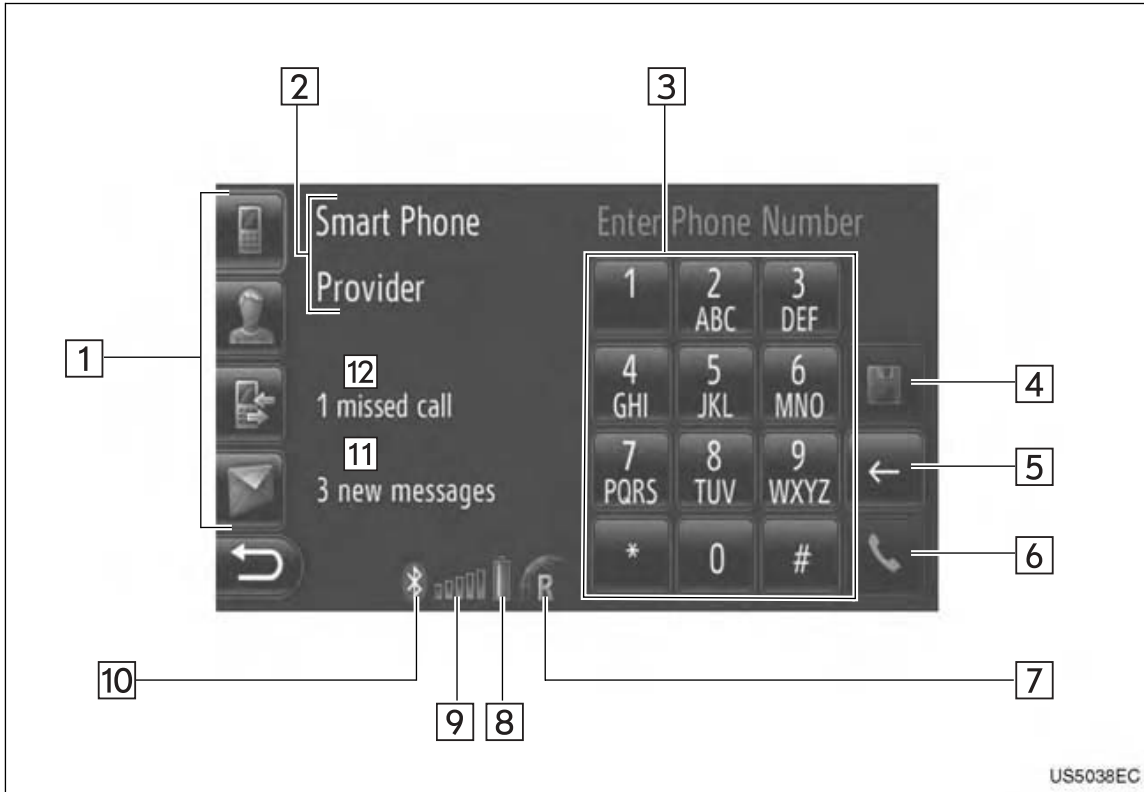

5

Bluetooth® HANDS-FREE SYSTEM

No.	Name	Function
1	Shortcut keys	Touch the corresponding icon to change to the “Dial By Number”, “Contacts”, “Call History” or “Messages” screen.
2	The Name of phone and provider	Displaying name of the phone and provider. These information may not be displayed depending on the phone.
3	Number keys	Touch to input a phone number.
4	Save the number screen button	Touch to register a phone number.
5	Delete screen button	Touch to delete an input phone number.
6	Off hook screen button	Touch to make a phone call.
7	The receiving area	“R” is displayed when receiving in a Roaming area. ≠ The receiving area may not be displayed depending on the phone.

No.	Name	Function
8	The amount of battery charge left	<p>The six bars display the charge level of the phone's battery.</p> <p>⚠ The amount displayed does not always correspond with the amount displayed on the cellular phone. The amount of battery charge left may not be displayed depending on the phone. This system does not have a charging function.</p> <p>⚠ If this information is not available from the connected phone, the icon will be shown with a question mark.</p>
9	The level of reception	<p>The five bars display the level of reception.</p> <p>⚠ The level of reception does not always correspond with the level displayed on the cellular phone.</p> <p>⚠ The level of reception may not be displayed depending on the phone.</p> <p>⚠ If this information is not available from the connected phone, the icon will be shown with a question mark.</p>
10	Bluetooth® connection	The icon indicates an active BT-connection
11	Short messages information	Displays short messages information.
12	Missed calls information	Displays missed calls information.

INFORMATION

- An antenna for the Bluetooth® connection is built into the instrument panel. The system may not function when you use the Bluetooth® phone in the following conditions and places:
 - When the cellular phone is obstructed by certain objects (such as when it is behind the seat or in the glove box and console box).
 - When the cellular phone touches or is covered with metal materials.

2. HANDS-FREE SYSTEM

Bluetooth® hands-free system allows you to make or receive a call without taking your hands off the steering wheel by connecting your cellular phone.

This system supports Bluetooth®. Bluetooth® is a wireless data system by which you can call without your cellular phone being connected with a cable or placed on a cradle.

The operating procedure of the system is explained in this section.

For registering and setting of the phone, see “Bluetooth® SETTINGS” on page 202.



CAUTION

- Use a cellular phone or connect the Bluetooth® phone only when safe and legal to do so.



NOTICE

- Do not leave your cellular phone in the car. The temperature inside may be high and damage the phone.
- If the Bluetooth® phone is too close to the system, quality of the sound may deteriorate and connecting condition may go down.

INFORMATION

- If your cellular phone does not support Bluetooth®, this system will not function.
- Depending on the cellular phone models, some functions may be restricted.
- In the following conditions, the system may not function.
 - The cellular phone is turned off.
 - The current position is outside the communication area.
 - The cellular phone is not connected.
 - The cellular phone has a low battery.
 - When outgoing is controlled, due to heavy traffic on telephone lines, etc.
 - When the cellular phone itself cannot be used
 - When transferring the phone book data from the cellular phone
- When using Bluetooth® audio and hands-free at the same time, the following problems may occur.
 - The Bluetooth® connection may be cut.
 - Noise may be heard on the Bluetooth® audio playback.
- The Bluetooth® phone battery will burn out quickly when it is connected to Bluetooth®.

Bluetooth®

Bluetooth is a registered trademark of Bluetooth SIG, Inc.

INFORMATION

- This system supports the following service.
 - Bluetooth® Specification
Ver.1.1 or higher
(Recommended: Ver.2.1 + EDR or higher)
 - Profiles
HFP (Hands Free Profile)
Ver.1.0 or higher
(Recommended: Ver.1.5 or higher)
DUN (Dial-Up Networking Profile)
Ver.1.1 or higher
PAN (Personal Area Network)
Ver. 1.0
PBAP (Phone Book Access Profile)
Ver.1.0 or higher
SSP (Serial Port Profile)
MAP (Message Access Profile)
 - Application
PIM (Personal Information Manager)
- If your cellular phone does not support HFP, you cannot register the Bluetooth® phone, or use DUN/PAN or PBAP profiles individually.
- If the connected Bluetooth® phone version is older than recommended or incompatible, this function may not be used.

USING THE PHONE SWITCH

The actual design and switch position may differ depending on the vehicle. For details, see the Pictorial index of "Owner's Manual".

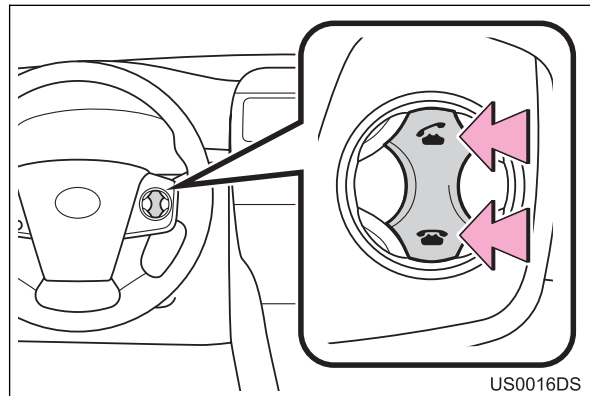

By pressing the phone, you can receive a call or hang up without taking your hands off the steering wheel.

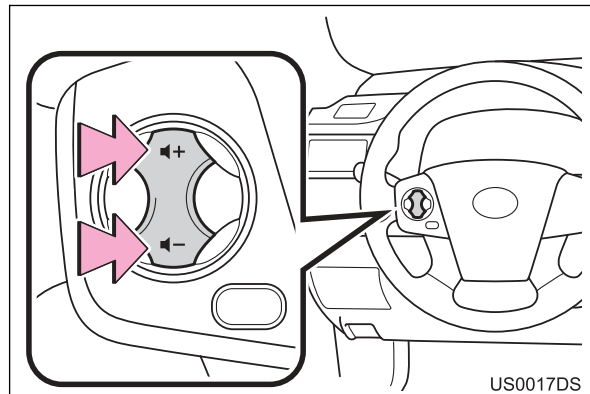

By pressing the volume switch, you can adjust the volume.

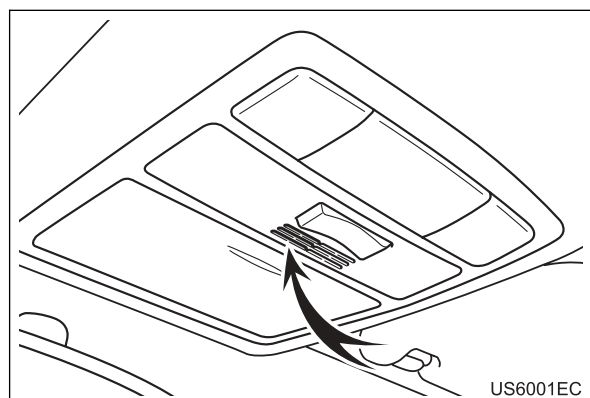

You can use the microphone when talking on the phone.

INFORMATION

- The other party's voice outputs from the front speaker. When the received calls or received voice outputs, the audio from the audio system will be muted.
- Talk alternately with the other party on the phone. If you talk at the same time, your voices may not reach each other. (It is not a malfunction.)
- Keep the volume of receiving voice down. Otherwise, an echo will be heard and receiving voice can be heard outside of the vehicle. When you talk on the phone, speak clearly towards the microphone.
- In the following situations, your voice may not reach the other party.
 - Driving on an unpaved road. (Due to traffic noise.)
 - Driving at high speed.
 - A window is open.
 - Turning the air-conditioning vents towards the microphone.
 - The sound of the air-conditioning fan is loud.
 - There is an effect from the cellular phone network.

ABOUT THE PHONE BOOK IN THIS SYSTEM

- ‘ The following data is stored for every registered phone. When another phone is connecting, you cannot read the registered data.
 - Phone book data
 - Call history data

INFORMATION

- When you delete the phone, the above-mentioned data is also deleted.

WHEN YOU RELEASE YOUR CAR

A lot of personal data is registered when you use the Hands-free system. When you release your car, initialize your data. (See "DELETE PERSONAL DATA" on page 199.)

- ‘ You can initialize the following data in the system.
 - Phone book data
 - Call history data
 - Speed dial data
 - Bluetooth[®] phone data
 - Volume setting
 - Bluetooth[®] setting

INFORMATION

- If you initialize it, the former state will never come back again. Pay attention when initializing the data.



CAUTION

- **FCC WARNING:** Changes or modifications not expressly approved by the party responsible for compliance could void the user's authority to operate the equipment.
- **CAUTION: Radio Frequency Radiation Exposure**
This equipment complies with FCC radiation exposure limits set forth for uncontrolled equipment and meets the FCC radio frequency (RF) Exposure Guidelines in Supplement C to OET65 and RSS-102 of the IC radio frequency (RF) Exposure rules. This equipment has very low levels of RF energy that it deemed to comply without maximum permissive exposure evaluation (MPE). But it is desirable that it should be installed and operated with at least 20 cm and more between the radiator and person's body (excluding extremities: hands, wrists, feet and ankles).
- **Co-location:** This transmitter must not be co-located or operated in conjunction with any other antenna or transmitter.

3. CONNECTING A Bluetooth® PHONE

CONNECTING A Bluetooth® PHONE

In order to use the hands-free system, it is necessary to pair the phone and connect the phone's profile (HFP) with the system. (In this manual, pairing refers to a Bluetooth® device connecting with the system. Connecting refers to the paired device's profile(s) being connected to the system.)

Once the profile has been connected, hands-free calls can be made.

If you have not yet connected any Bluetooth® phones with phone profile (HFP), you must first pair your phone with phone profile (HFP) according to the following procedure. Connect your Bluetooth® phone with phone profile (HFP) after bringing the vehicle to a complete stop.

See "Bluetooth® SETTINGS" on page 202 of additional registration when registering.

CONNECTING A Bluetooth® PHONE

CONNECTING FROM THE SYSTEM

1 Press the  button.

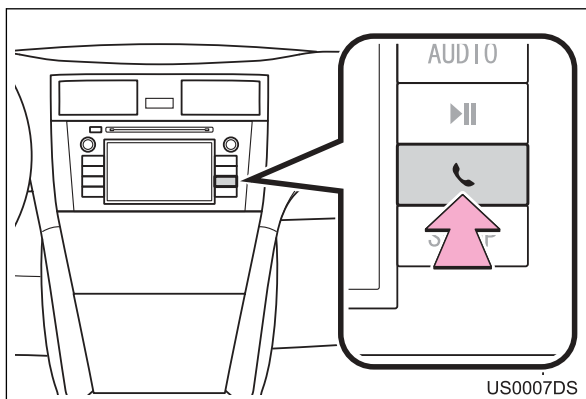

2 Touch "Search Bluetooth¹ devices".



3 Touch "Search for Bluetooth¹ Devices".



When a Bluetooth® device is currently connected, a pop-up window is displayed. To disconnect it, touch "Yes".

4 The following screen will be displayed while searching for a Bluetooth® device.



To cancel this function, touch "Cancel".

1: Bluetooth is a registered trademark of Bluetooth SIG, Inc.

5 Touch the device to be paired.



Connectable Bluetooth® devices will be displayed in the list.

6 The following screen will be displayed.



To cancel this function, touch “**Cancel**”.

7 Confirm the PIN.

i If the device supports SSP (Secure Simple Pairing)

Confirm the PIN displayed on the screen, and then touch “**Accept**”.

i If the device does not supports SSP (Secure Simple Pairing)

Input the PIN displayed on the screen into the phone.

8 The following screen will be displayed when pairing is complete.



9 The system waits for connection requests coming from the paired device. All requested profiles are connected automatically.

If the automatic connection failed, the following screen will be displayed. Touch “**Connect for Phone**”.

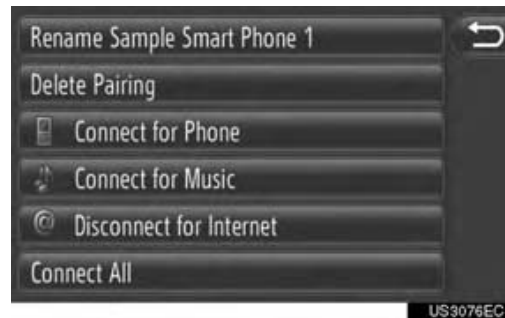

Once the Bluetooth® phone has been connected, it will be automatically connected whenever the engine switch is in the “ACC” or “ON” position.

INFORMATION

● For details on device detection and the operation of your cellular phone, see the manual that comes with the cellular phone.

CONNECTING FROM THE DEVICE

- 1 Press the  button.

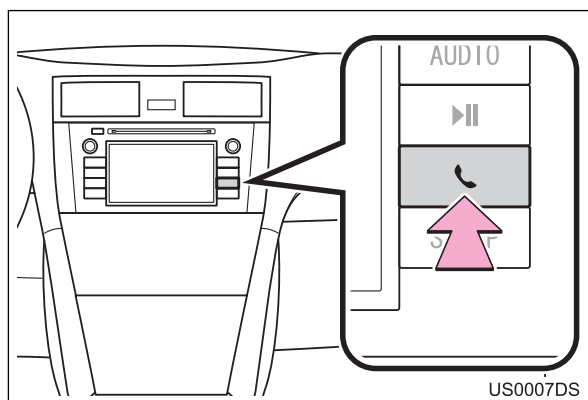

- 2 Touch “**Search Bluetooth¹ devices**”.



- 3 Touch “**Make Discoverable**”.

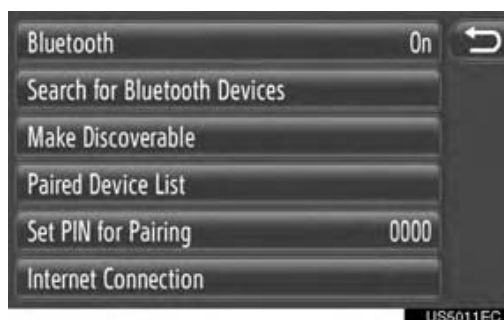

- ‘ When a Bluetooth[®] device is currently connected, a pop-up window is displayed. To disconnect it, touch “**Yes**”.

- ¹: Bluetooth is a registered trademark of Bluetooth SIG, Inc.

- 4 The following screen will be displayed.



- ‘ To cancel this function, touch “**Cancel**”.

- 5 Confirm the PIN.

- i If the device supports SSP (Secure Simple Pairing)

- ‘ Confirm the PIN displayed on the screen, and then touch “**Accept**”.

- i If the device does not supports SSP (Secure Simple Pairing)

- ‘ Input the PIN displayed on the screen into the phone.

5

Bluetooth[®] HANDS-FREE SYSTEM

RECONNECTING THE Bluetooth® PHONE

If a Bluetooth® phone is disconnected due to poor reception from the Bluetooth® network when the engine switch is in the “ACC” or “ON” position, the system will automatically reconnect the Bluetooth® phone.

- ‘ If the Bluetooth® phone is disconnected on purpose, such as it was turned off, this does not happen. Reconnect it manually using either of the following methods:
 - Select the Bluetooth® phone again. (See page 206.)
 - Connect the phone profile. (See page 203.)

4. REGISTERING A ENTRY

REGISTERING A NEW ENTRY

Up to 200 numbers can be registered with this system.

INFORMATION

- This function cannot be operated while driving.

REGISTERING FROM THE “Contacts” SCREEN

1 Touch “Contacts”.



The “Contacts” screen can be displayed by touching  on any of the “Phone” screens.

2 Touch “Stored” on the “Contacts” screen.

3 Touch “Create New Entry”.

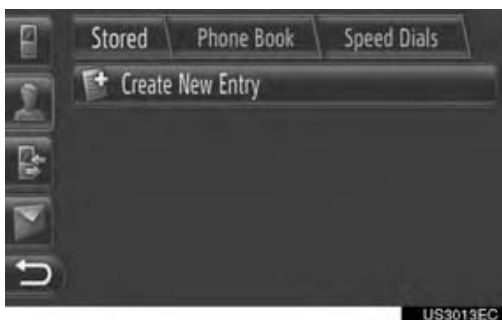

4 Select one of 4 phone types (“Mobile”, “Home”, “Work” or “Other”) and input a number.



: Touch to delete one number. Touch and hold to continue deleting numbers.

You can enter a number for each phone type.

5 Touch .

6 Input the entry name.



7 Touch “OK”.

8 The entry is registered in the “Stored” list.





Touch  to display and edit the entry information. (See page 168.)

5

Bluetooth® HANDS-FREE SYSTEM

REGISTERING FROM THE “Dial By Number” SCREEN

- 1 Touch “Dial By Number” on the “Phone” menu screen.
 - ‘ The “Dial By Number” screen can be displayed by touching  on any of the “Phone” screens.
 - ‘ You can also press the  switch on the steering wheel to display the “Dial By Number” screen.
- 2 Input the numbers.
- 3 Touch .
- 4 Follow the steps “REGISTERING FROM THE “Contacts” SCREEN” from “STEP 6”. (See page 165.)

INFORMATION

- The phone type is registered as “Mobile”.

REGISTERING FROM THE “Phone Book” SCREEN

- 1 Search the entry by “Phone Book”. (See page 171.)
- 2 Touch  for desired item.
- 3 Touch “Add to Stored Phone Numbers”.
- 4 Follow the steps “REGISTERING FROM THE “Contacts” SCREEN” from “STEP 6”. (See page 165.)

INFORMATION

- The phone type is registered as “Mobile”.
- If the contact includes an address and a phone number, they will be stored in the “Stored” list on the “My Destinations” screen and “Contacts” screen. (See pages 52 and 165.)

REGISTERING FROM THE “Call History” SCREEN

- 1 Searching the entry by “Call History”. (See page 173.)
- 2 Touch  next to the desired item.
- 3 Follow the steps “REGISTERING FROM THE “Contacts” SCREEN” from “STEP 6”. (See page 165.)

INFORMATION

- The phone type is registered as “Mobile”.

REGISTERING FROM AN EXTERNAL DEVICE

“vCard” formatted data can be transferred from a USB memory to this system. Transferred addresses and numbers will be stored in the “Stored” list on the “My Destinations” screen and “Contacts” screen. (See pages 52 and 165.)

REGISTERING A ENTRY AS “Speed Dials”

Phone numbers from the list in the “Stored” screen and “Phone Book” can be registered as speed dials. Up to 15 speed dials can be registered.

- 1 Touch “**Contacts**”.



- The “Contacts” screen can be displayed by touching  on any of the “Phone” screens.

- 2 Touch “**Speed Dials**” on the “Contacts” screen.
- 3 Touch the desired speed dial screen button the phone number is to be registered to.

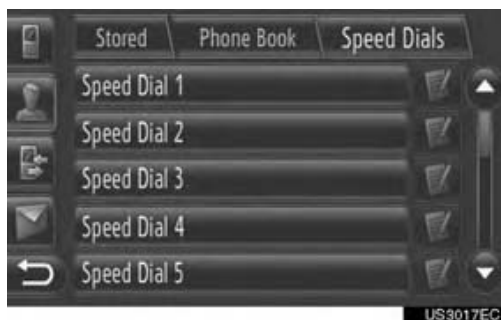

- 4 Touch “**Yes**”.

- 5 Touch the desired list to select the entry.

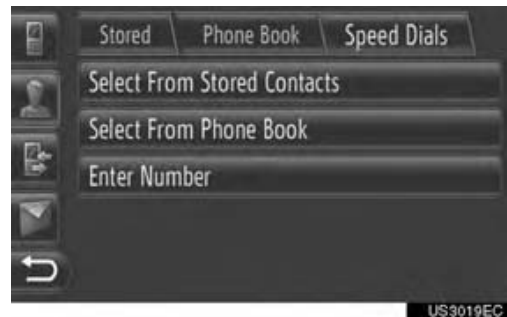

- 6 Touch the desired entry to register.

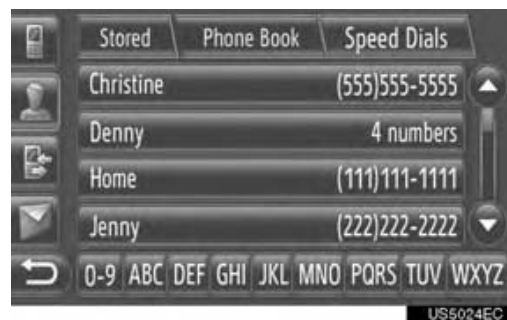

- If there are 2 or more phone numbers, touch the desired number in the list.



- 7 The entry is registered as “Speed Dials”.

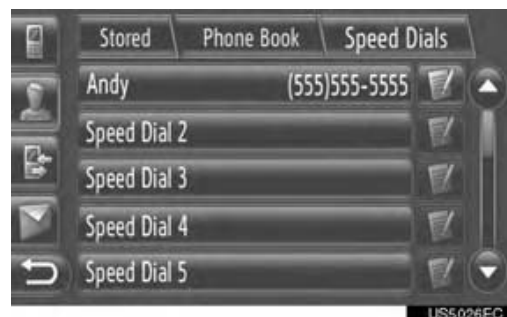

- Touch  to display and edit the entry information. (See page 168.)

DISPLAYING AND EDITING THE ENTRY INFORMATION

Detailed information of entries in the list can be displayed or edited.

- 1 Touch  next to the desired entry on the “Contacts” screen.



- i Entry options screen of the “Stored” and “Speed Dials” list

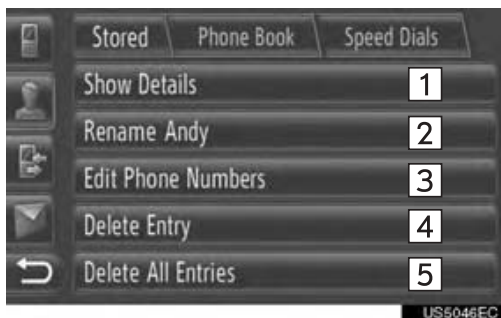

- i Entry options screen of the “Phone Book” list



- On this screen, the following functions can be operated.

No.	Function
1	Touch to display the details of the entry information. ✳ Touch the desired entry to call it.
2	Touch to change the entry name. (See page 168.)
3	Touch to edit phone numbers. (See page 169.)
4	Touch to delete the entry.
5	Touch to delete all entries.
6	Touch to register the entry in the “Stored” list on the “My Destinations” screen and “Contacts” screen. (See page 166.)

INFORMATION

- “Rename XX” and “Edit Phone Numbers” cannot be operated while driving.

CHANGING THE ENTRY NAME

- 1 Touch “Rename XX” on the entry options screen.
- 2 Input the entry name.



- 3 Touch “OK”.

EDITING PHONE NUMBERS

- 1 Touch **“Edit Phone Numbers”** on the entry options screen.
- 2 Select one of 4 phone types and input a number.



: Touch to delete one number. Touch and hold to continue deleting numbers.

You can edit a number for each phone type.

- 3 Touch .

INFORMATION

- If an entry that is transferred from a cellular phone is edited, the change will affect the entry in the “Stored” list on the “My Destinations” screen and “Contacts” screen. (See pages 52 and 165.)

SENDING STORED CONTACTS TO A USB MEMORY

The entries stored in the “Stored” list on the “My Destinations” screen and “Contacts” screen can be transferred to a USB memory. (See page 60.)

2. TELEPHONE OPERATION

1. CALLING ON A Bluetooth® PHONE

After a Bluetooth® phone has been connected, a call can be made using the hands-free system. There are several methods by which a call can be made. These are described below.

BY DIAL

You can call by inputting the phone number.

- 1 Press the  switch on the steering wheel.



- The "Dial By Number" screen can be displayed by touching "**Dial By Number**" on the "Phone" menu screen or  on any of the "Phone" screens.

- 2 Touch the desired key to input the phone number.



: Touch to delete one number. Touch and hold to continue deleting numbers.

• When  is touched, the number is registered in the "Stored" list on the "Contacts" screen. (See page 166.)

- 3 Touch .

- 4 The connecting screen will be displayed.

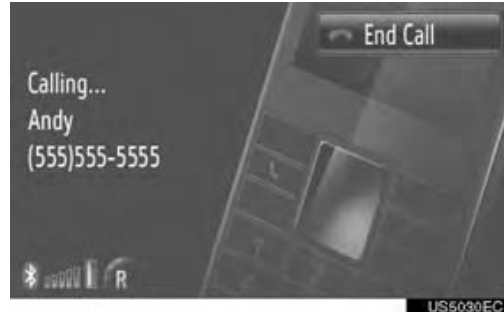

- To cancel the call, touch "**End Call**".

INFORMATION

- This function cannot be operated while driving.

BY "Stored" LIST ON THE "Contacts" SCREEN

Calls can be made using the "Stored" list on the "Contacts" screen. To use this function, it is necessary to register the entry. (See page 165.)

- 1 Touch "**Contacts**".



- The "Contacts" screen can be displayed by touching  on any of the "Phone" screens.

- 2 Touch "**Stored**" on the "Contacts" screen.

3 Touch the desired entry.



Touch  to display and edit the entry information. (See page 168.)

If there are 2 or more phone numbers, touch the desired number in the list.



4 The connecting screen will be displayed.

To cancel the call, touch **“End Call”**.

BY PHONE BOOK

Calls can be made using the phone book data of the connected cellular phone. The phone book changes depending on the phone connected.

If a contact does not have phone number stored, the entry will be dimmed.

You can update the Phone's book list. (See page 209.)

1 Touch **“Contacts”**.



The **“Contacts”** screen can be displayed by touching  on any of the **“Phone”** screens.

2 Touch **“Phone Book”** on the **“Contacts”** screen.

3 Touch the desired entry.



If there are 2 or more phone numbers, touch the desired number in the list.

- Touch **“Search Contact”** to search by the contact’s name. This function cannot be operated while driving.
- Touch  to display and edit the entry information. (See page 168.)

- The connecting screen will be displayed.
- To cancel the call, touch **“End Call”**.

INFORMATION

- When a phone is connected for the first time, its phone book must be downloaded. If the phone book can not be downloaded, a pop-up window will be displayed.

BY SPEED DIALS

You can call by “Speed Dial” number list. Registering number in the “Speed Dial” number list is to see page 167.

- Touch **“Contacts”**.



- The “Contacts” screen can be displayed by touching  on any of the “Phone” screens.

- Touch **“Speed Dials”** on the “Contacts” screen.
- Touch the desired entry.

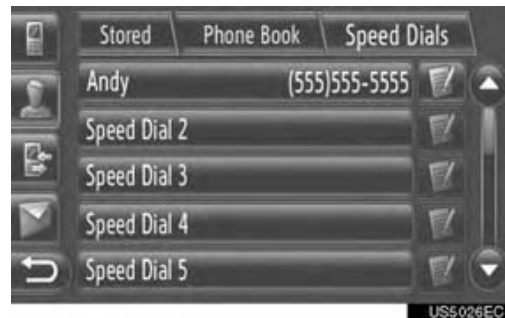

- Touch  to display and edit the entry information. (See page 168.)

- The connecting screen will be displayed.
- To cancel the call, touch **“End Call”**.

BY CALL HISTORY

Calls can be made using one of the 4 call lists functions.

1 Touch “Call History”.



The “Call History” screen can be displayed by touching  on any of the “Phone” screens.

2 Touch the desired list.



“**All**”: Touch to display all numbers (missed, received and dialed).

“**Missed**”: Touch to display missed calls.

“**Received**”: Touch to display received calls.

“**Dialed**”: Touch to display dialed numbers.

The state of a call is shown by the following icons.

 : Missed

 : Received

 : Dialed

When  is touched, the entry is registered in the “Stored” list on the “Contacts” screen. (See page 166.)

3 Touch the desired entry.

4 The connecting screen will be displayed.

To cancel the call, touch “**End Call**”.

CALLING USING A SHORT MESSAGE

Calls can be made to a short message sender’s phone number. (See page 179.)

1 Touch “Call Sender”.

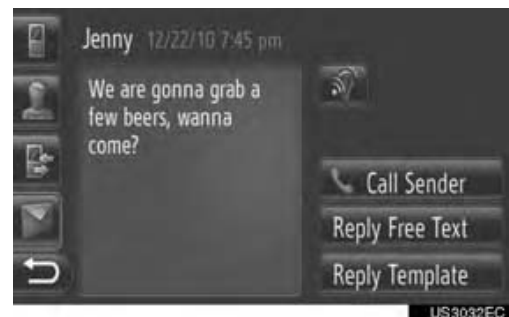

2 The connecting screen will be displayed.

To cancel the call, touch “**End Call**”.

BY POI CALL

Calls can be made to a POI when its details are displayed on the screen. (See pages 32 and 36.)

- 1 Touch .

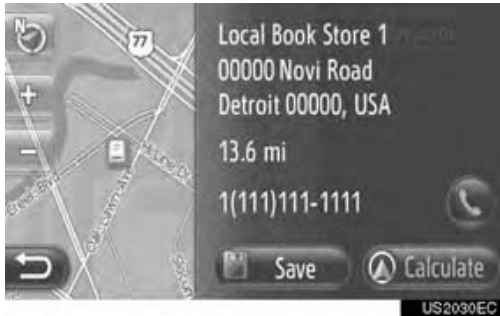

- 2 The connecting screen will be displayed.

‘ To cancel the call, touch “**End Call**”.

2. RECEIVING CALLS ON A Bluetooth® PHONE

When a call is received, this screen is displayed and a sound is heard.

- 1 Press the  switch on the steering wheel.



“**Accept**”: Touch to talk on the phone.

“**Reject**”: Touch to reject the call.

- The layout of the incoming call screen may differ depending on the information available from the connected phone.

• Ringtone and ringtone volume can be set. (See pages 197 and 209.)

- i Single call

- 2 The ongoing screen is displayed. (See page 176.)

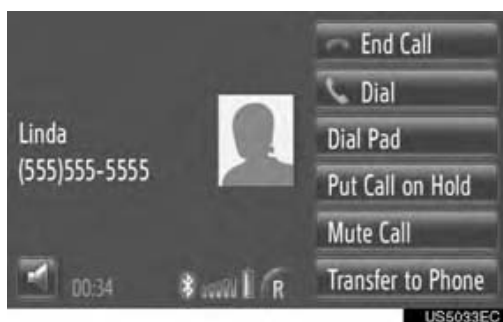

- i Call waiting

- 2 The ongoing screen is displayed. (See page 176.)

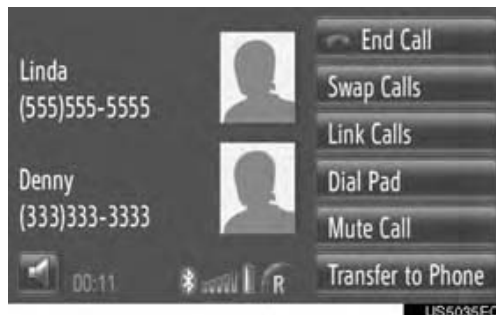

- The first call is put on hold.
- The second call’s information is displayed below the first call information.

INFORMATION

- During international phone calls, the other party’s name may not be displayed correctly depending on the cellular phone which you have.

2. TELEPHONE OPERATION

3. TALKING ON A Bluetooth® PHONE

While you are talking on a Bluetooth® phone, the ongoing screen is displayed. The operations outlined below can be performed on this screen.

i Single call

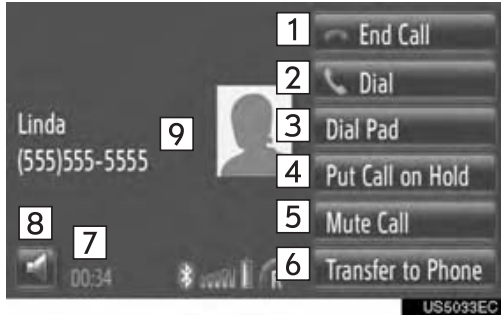

i Call waiting

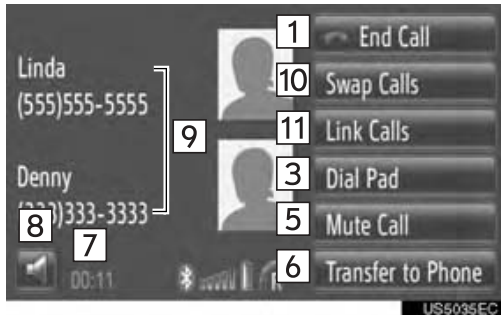

On this screen, the following functions can be operated.

NO.	Function
1	Touch to hang up the phone. ≠ The  switch on the steering wheel can also be pressed to hang up the phone.
2	Touch to dial a second number. (See page 177.)
3	Touch to send a tone. (See page 177.)
4	Touch to put a call on hold. To cancel this function, touch “Active call” .
5	Touch to mute your voice. To cancel muting your voice, touch “Unmute call” .

NO.	Function
6	Touch to transfer the call. Touch “Transfer to Phone” to change from Hands-free call to cellular phone call. Touch “Handsfree mode” to change from cellular phone call to Hands-free call.
7	Displays a call duration.
8	Touch to adjust the volume of the other party’s voice. (See page 177.)
9	Displays the name, number and picture of the other party. The information shown here may differ depending on the information available from your phone.
10	Touch to change parties.
11	Touch to change to a conference call.

INFORMATION

- When you change from cellular phone call to Hands-free call, the Hands-free screen will be displayed and the call can be operated on the screen.
- Transferring methods will be different depending on the type of cellular phone which you have.
- For the operation of the phone, see the manual that comes with your cellular phone.

ADJUSTING THE RECEIVER VOLUME

- 1 Touch .

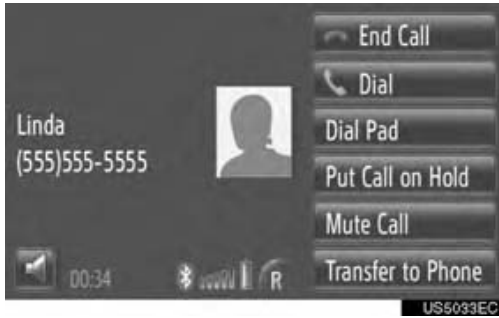

- 2 Touch “-” or “+” to adjust the volume of the other party’s voice.

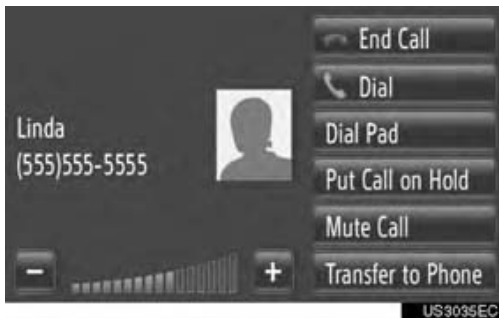

The receiver volume can also be adjusted using the switch on the steering wheel.

SENDING TONES

- 1 Touch “Dial Pad”.
- 2 Inputting the numbers.



- Input numbers are sent immediately as tones.
- Touch “Quit” to return the previous screen.

DIALING A SECOND NUMBER

- 1 Touch “Dial”.
- 2 Touch the desired method to call.



- If “Dial Number” is selected

- 3 Input the number and then touch .



- If “Dial From Contacts” is selected

- 3 Touch the desired method and then touch the desired entry.



5

i If **“Dial From Call History”** is selected

3 Touch the desired list and then touch the desired entry.



4 The connecting screen will be displayed.

‘ To cancel the call, touch **“End Call”**.

5 When a new call has been established, the following screen will be displayed.

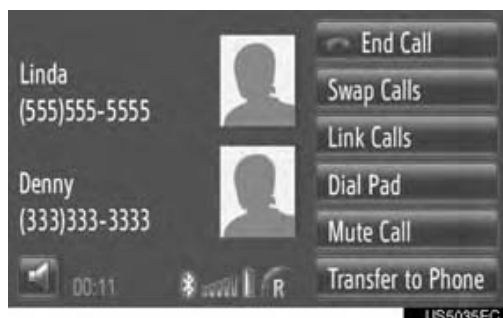

‘ The first call is put on hold.

‘ The second call’s information is displayed below the first call information.

INFORMATION

- **“Dial Number”** cannot be operated while driving.

CHANGING PARTIES

1 Touch **“Swap Calls”**.

‘ Every time **“Swap Calls”** is touched, the party who is on hold will be switched.

CHANGING TO A CONFERENCE CALL

1 Touch **“Link Calls”**.

INFORMATION

- If your cellular phone is not HFP Ver. 1.5 compatible, this function can not be used.
- Dialing a second number operation may differ depending on your phone company and cellular phone.

1. SHORT MESSAGE FUNCTION

Received messages can be forwarded from the connected Bluetooth® phone, enabling checking and replying using this system.

RECEIVING A NEW SHORT MESSAGE

When a new short message is received, a pop-up window is displayed on the screen.



This function can be set to “On” or “Off”. (See page 209.)

CHECKING RECEIVED SHORT MESSAGES

1 Touch “Messages”.



The “Messages” screen can be displayed by touching  on any of the “Phone” screens.

2 Touch “Inbox” on the “Messages” screen.

3 Touch the desired short message.



The state of a message is shown by the following icons.

 : New message



 : Read message

 : Unread message

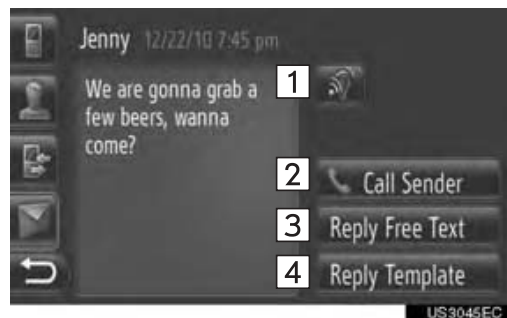
4 The short message will be displayed.



On this screen, the following functions can be operated.

No.	Function
1	Touch  to have the short message read out. To cancel this function, touch  .
2	Touch to call the sender.
3	Touch to reply to the short message by free text.
4	Touch to reply to the short message by template.

REPLYING THE SHORT MESSAGE

- 1 Touch **“Reply Free Text”** or **“Reply Template”**.
- 2 Input the short message.
- 3 Touch **“OK”**.
- 4 The short message will be sent.

INFORMATION

- **“Reply Free Text”** cannot be selected while driving.



CHECKING SENT SHORT MESSAGES

- 1 Touch **“Messages”** on the **“Phone”** menu screen.
 - ‘ The **“Messages”** screen can be displayed by touching  on any of the **“Phone”** screens.
- 2 Touch **“Sent”** on the **“Messages”** screen.
- 3 Touch the desired short message.

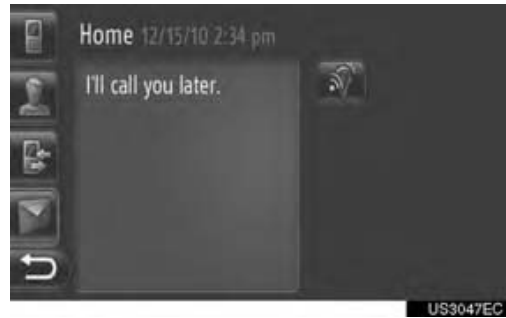

- 4 The short message will be displayed.



- : Touch to have the short message read out. To cancel this function, touch .

SENDING A NEW SHORT MESSAGE

- 1 Touch **“Messages”** on the **“Phone”** menu screen.
 - ‘ The **“Messages”** screen can be displayed by touching  on any of the **“Phone”** screens.
- 2 Touch **“Create New”** on the **“Messages”** screen.
- 3 Touch **“Create Message”** or **“Use Template”**.

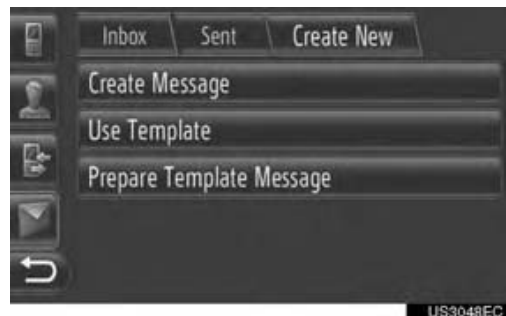

- 4 Input the short message. (See page 182.)



- 5 Touch "OK".
- 6 Select the desired number/contact to whom the short message should be sent.



- "Enter Number", "Select Contact" and a list of former recipients will be displayed.

- i If "Enter Number" is selected

- 7 Enter the number.



- 8 Touch "OK".
- 9 The short message will be sent.

- i If "Select Contact" is selected

- 7 Touch the desired list.

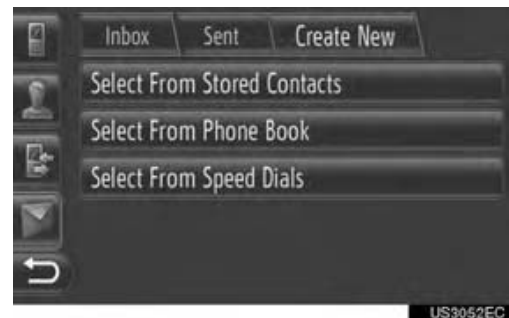

- 8 Touch the desired contact.
- 9 The short message will be sent.

- i If a recipient is selected

- 7 The short message will be sent immediately.

INFORMATION

- "Create Message" cannot be selected while driving.

CREATE A NEW SHORT MESSAGE

FROM THE “Create Message” SCREEN

1 Input the short message.



2 Touch “OK”.

FROM THE “Use Template” SCREEN

1 Touch the desired template.



: Touch to delete the template.

10 messages have already been registered to the message template screen.



2 Edit the short message.



This screen is not displayed while driving. When a template is touched, the screen will be changed to the recipient selection screen.

3 Touch “OK”.

INFORMATION

- The cursor's position can be moved by touching the desired location in the input screen. Touch  or  to scroll the input screen up or down.
- The short messages can contain up to 160 characters. If the entered text exceeds the characters available for one short message, a new short message will begin automatically. This is indicated by a separation line and an icon in the input field, which is shown as soon as there are only 10 characters left for the short message.



- The number of characters left for the short message is displayed.
- A maximum of 6 short messages can be written in series.

REGISTER NEW TEMPLATES

New templates can be created. Up to 15 templates can be registered.

- 1 Touch **“Prepare Template Message”**.

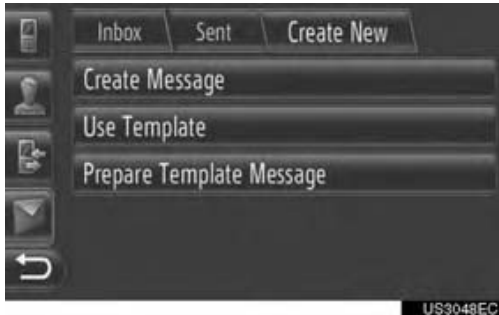

- 2 Input the short message.
- 3 Touch **“OK”**.
- 4 The message is registered in the template list on the **“Use Template”** screen.

INFORMATION

- This function is unavailable while driving.

6

VOICE COMMAND SYSTEM

1

VOICE COMMAND SYSTEM OPERATION

1. VOICE COMMAND SYSTEM.....	186
USING THE VOICE COMMAND SYSTEM.....	186
VOICE COMMAND SYSTEM OPERATION	187

1

2

3

4

6

7

8

9

1. VOICE COMMAND SYSTEM

The voice command system enables the navigation, audio and hands-free systems to be operated using voice commands.

INFORMATION

- Voice recognition language can be changed. (See "SELECTING A LANGUAGE" on page 198)

USING THE VOICE COMMAND SYSTEM

The actual design and switch position may differ depending on the vehicle. For details, see the Pictorial index of "Owner's Manual".

STEERING SWITCHES FOR THE VOICE COMMAND SYSTEM

- i Type A (Two direction steering switch)

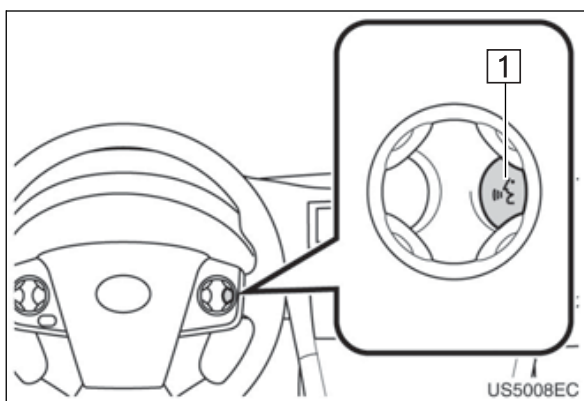

- i Type B (Four direction steering switch)

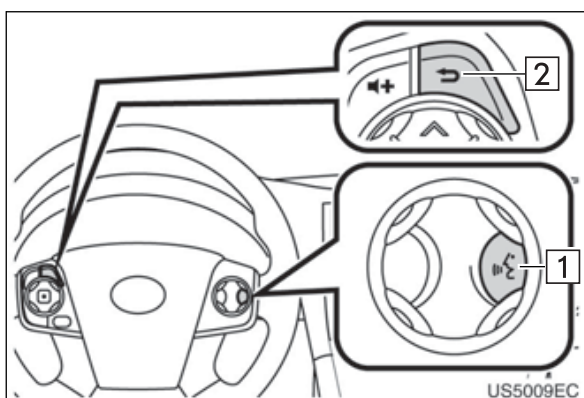

- 1 Talk switch

- ‘ Press the talk switch to start the voice command system.
- ‘ Press and hold the talk switch to cancel the voice command system.

- 2 Back switch

- ‘ Press the back switch to return to the previous screen.

MICROPHONE

It is unnecessary to speak directly into the microphone when giving a command.

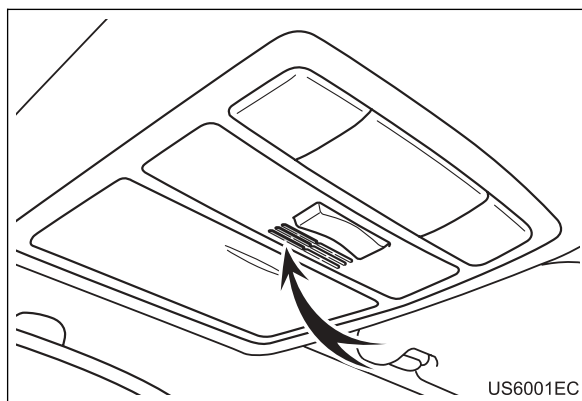

INFORMATION

- Wait for the confirmation beep before speaking a command.
- Voice commands may not be recognized if:
 - Spoken too quickly.
 - Spoken at a low or high volume.
 - The windows are open.
 - Passengers are talking while voice commands are spoken.
 - The air conditioning speed is set high.
 - The air conditioning vents are turned towards the microphone.
- In the following conditions, the system may not recognize the command properly and using voice commands may not be possible:
 - The command is incorrect or unclear. Note that certain words, accents or speech patterns may be difficult for the system to recognize.
 - There is excessive background noise, such as wind noise.

VOICE COMMAND SYSTEM OPERATION**1** Press the talk switch.

- ‘ The voice command system is activated, press the talk switch to skip the current dialog state.
- ‘ In case of an activated speech recognizer waiting for input, press the talk switch to restart the speech recognizer.

2 After a beep sounds, say the desired command or touch the desired command.

: The icon will be displayed if the user can speak a command.

: Touch to adjust the volume of the voice guidance volume.

■ DISPLAYING THE COMMAND LIST SCREEN

- 1 Say “**More commands**” or touching “**More commands**” on the voice command main menu screen.
- 2 Say the desired command or touch the desired command.



- 3 Say the desired command or touch the desired command.

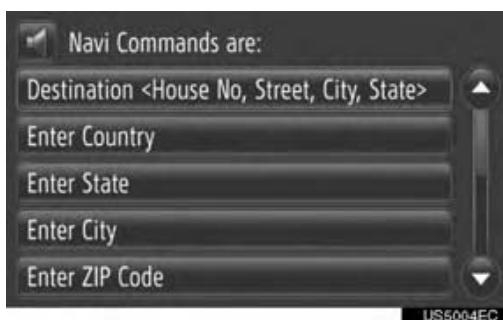

- ‘ The command list is read out and the corresponding command is highlighted. To cancel this function, press the talk switch.

VEHICLE INFORMATION

1	VEHICLE INFORMATION	
1.	QUICK REFERENCE	190
2.	FUEL CONSUMPTION.....	191
	FUEL CONSUMPTION (VEHICLES WITH HYBRID SYSTEM)	191
	FUEL CONSUMPTION (VEHICLES WITH GASOLINE ENGINE)	191
3.	TIRE PRESSURE WARNING SYSTEM	193
	SHOWING THE TIRE PRESSURE SCREEN	193

1

2

3

4

5

6

7

8

9

1. QUICK REFERENCE

Fuel consumption information and tire pressure value can be displayed. To access the vehicle information system, press the “**CAR**” button.

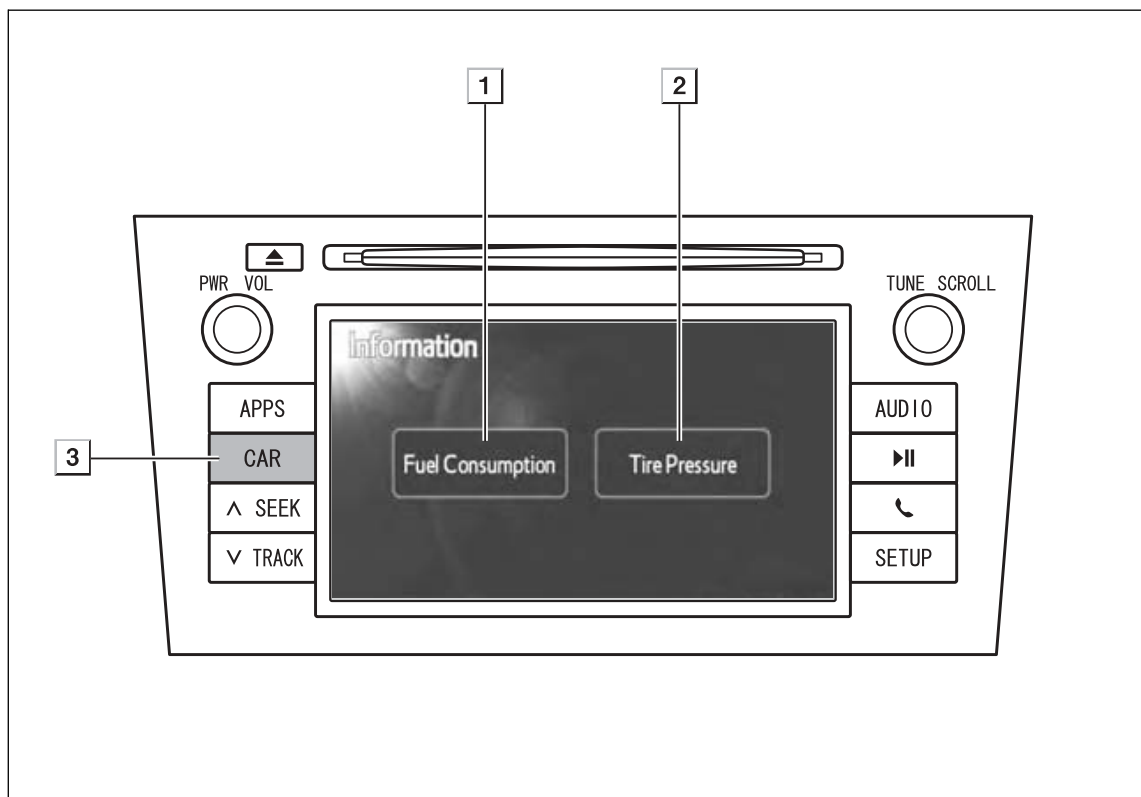

- The actual design and button position may differ depending on the vehicle. For details, see Section 3 of “*Owner’s Manual*”.
- The “Information” screen shown above is displayed if the vehicle is equipped with both a fuel consumption and a tire pressure warning system.

No.	Name	Function	Page
1	“Fuel Consumption”*	Displays the “Trip Information”, “History” and “Energy Monitor” screen.	191
2	“Tire Pressure”*	Displays the “Tire Pressure” screen.	193
3	“CAR” button*	Press this button to access the vehicle information system.	∞

*: If equipped

1. VEHICLE INFORMATION

2. FUEL CONSUMPTION¹

FUEL CONSUMPTION (VEHICLES WITH HYBRID SYSTEM)

Fuel consumption such as shown below can be displayed on the screen. For details see Section 1-1 of “Owner’s Manual”.

- Energy monitor
- Trip consumption
- History

FUEL CONSUMPTION (VEHICLES WITH GASOLINE ENGINE)

1 Press the “CAR” button.

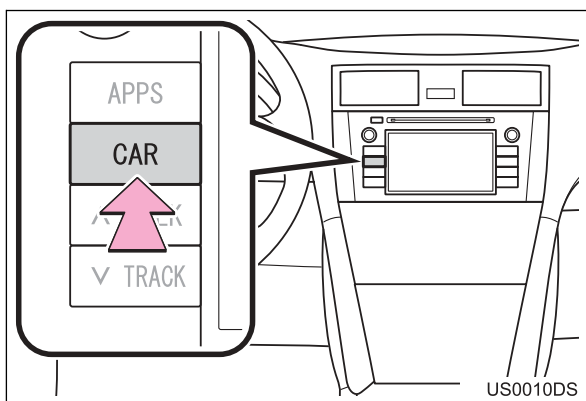

2 Touch “Fuel Consumption”.



- “Trip Information” or “History” screen will be displayed.
- The “Information” screen is not displayed if the vehicles not equipped with a tire pressure warning system.

TRIP INFORMATION



- If the “Trip Information” screen is not displayed, touch “Trip Information”.

No.	Name
1	Average speed
2	Elapsed time
3	Cruising range
4	Previous fuel consumption per minute
5	Current fuel consumption per minute

“Clear”: Trip information data can be delete by touching this screen button.

“History”: “History” screen can be displayed by touching this screen button.

INFORMATION

- The trip information display indicates general driving conditions. Accuracy varies with driving habits and road conditions.

7

VEHICLE INFORMATION

¹: If equipped

HISTORY

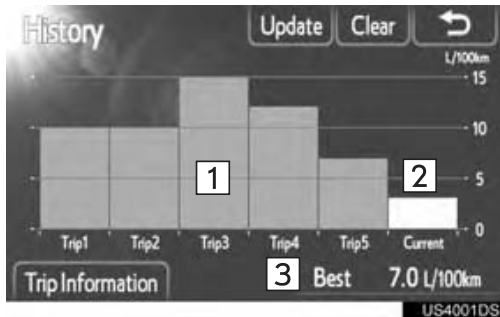

‘ If the “History” screen is not displayed, touch “**History**”.

No.	Name
1	Previous fuel economy record
2	Current fuel economy
3	Best recorded fuel economy

‘ The average fuel consumption history is divided by color into past averages and the average fuel consumption since the last reset.

“**Clear**”:
Past record data can be delete by touching this screen button.

“**Update**”:
Reset the average fuel consumption to measure the current fuel consumption again.

i Vehicle with multi-information display

When you touch “**Update**”, the average fuel consumption displayed in the multi-information display will be reset at the same time.

“**Trip Information**”:
“Trip Information” screen can be displayed by touching this screen button.

3. TIRE PRESSURE WARNING SYSTEM¹

Vehicles equipped with a tire pressure warning system will display a warning screen in addition to a warning indication on the meter if tire pressure becomes low. For information on the tire pressure warning system, refer to “Owner’s Manual”.



To confirm tire pressure values, touch “Yes”. To cancel and return to the previous screen, touch “No”. (This screen will not be shown if the tire pressure screen is already being displayed.)

SHOWING THE TIRE PRESSURE SCREEN

The tire pressure value of each tire can be confirmed using the tire pressure screen.

1 Press the “CAR” button.

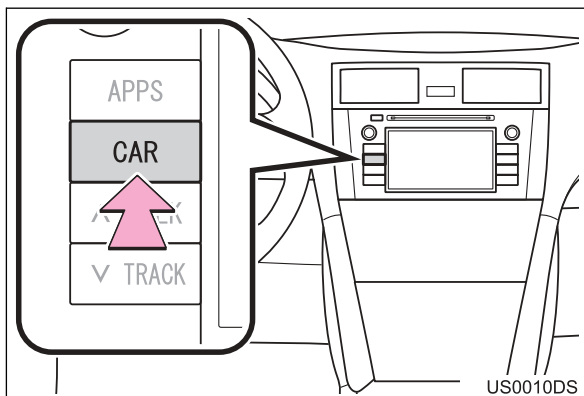

2 Touch “Tire Pressure”.



3 The tire pressure value of each tire will be displayed.

i Type A



i Type B



Low tire pressure values will be displayed in orange.

The display pattern varies depending on the vehicle. Some vehicles do not show the spare tire pressure.

¹: If equipped

SETUP

1 SETUP OPERATION

- | | | |
|--|------------|---|
| 1. QUICK REFERENCE | 196 | 1 |
| 2. GENERAL SETTINGS | 197 | 2 |
| SCREENS FOR GENERAL
SETTINGS | 197 | 3 |
| 3. DISPLAY SETTINGS | 200 | 4 |
| TURN OFF DISPLAY | 200 | 5 |
| CHANGING BETWEEN DAY AND
NIGHT MODE | 201 | 6 |
| ADJUST CONTRAST/
BRIGHTNESS | 201 | 7 |
| 4. Bluetooth® SETTINGS | 202 | 8 |
| Bluetooth® FUNCTION ON/OFF | 202 | 9 |
| PAIRING A Bluetooth® DEVICE | 203 | |
| DISPLAYING THE PAIRED
DEVICE LIST | 206 | |
| SETTING PIN | 207 | |
| SETTING THE INTERNET
CONNECTION | 208 | |
| 5. PHONE SETTINGS | 209 | |
| SCREEN FOR PHONE SETTINGS..... | 209 | |
| 6. AUDIO SETTINGS | 210 | |
| 7. VEHICLE SETTINGS | 211 | |

1. QUICK REFERENCE

To customize the function settings, press the “**SETUP**” button.

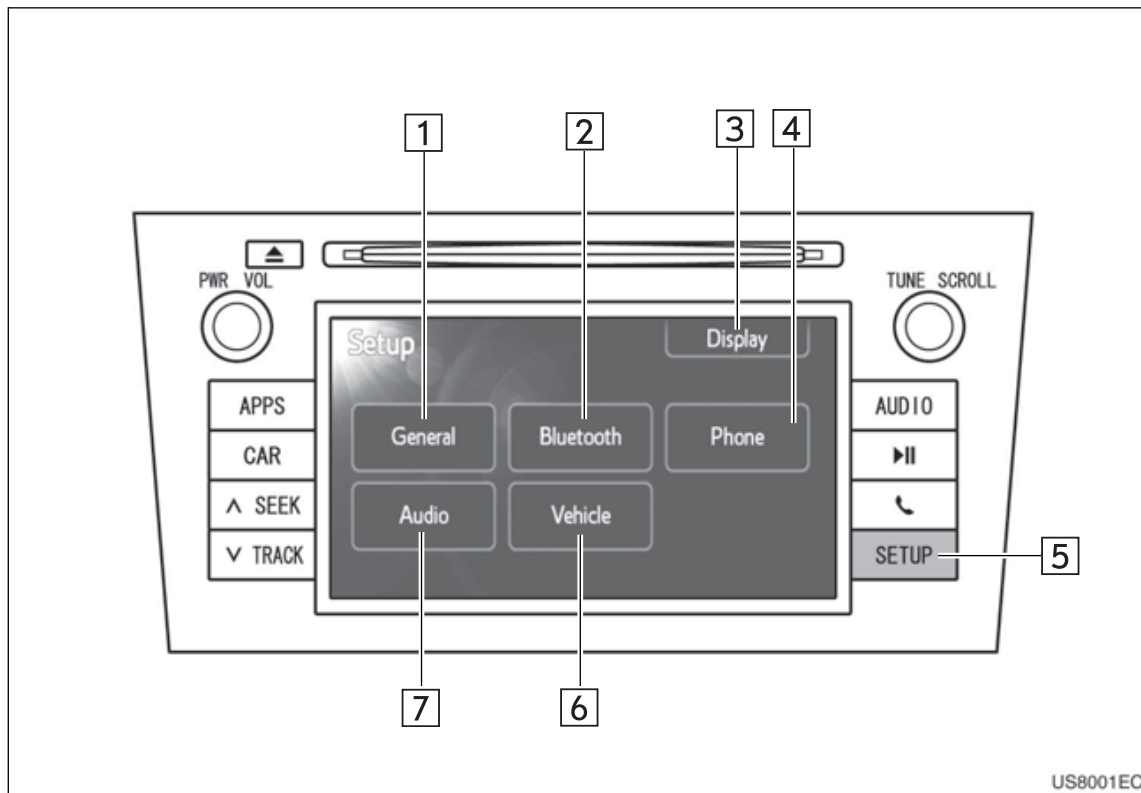

The actual design and button position may differ depending on the vehicle. For details, see Section 3 of “*Owner’s Manual*”.

No.	Name	Function	Page
1	“General”	Settings are available for language selection, operation sounds, etc.	197
2	“Bluetooth*”	Registering, removing, connecting and disconnecting Bluetooth® devices and settings are available for Bluetooth®.	202
3	“Display”	Settings are available for contrast and brightness of the screen.	200
4	“Phone”	Settings are available for phone sound, phone book, etc.	209
5	“SETUP” button	Press this button to display the “Setup” screen.	197, 200, 202, 209, 210, 211
6	“Vehicle”	Settings are available for vehicle customization.	211
7	“Audio”	Settings are available for HD Radio™ system.	210

*: Bluetooth is a registered trademark of Bluetooth SIG, Inc.

1. SETUP OPERATION

2. GENERAL SETTINGS

Settings are available for language selection, operation sounds, etc.

1 Press the “**SETUP**” button.

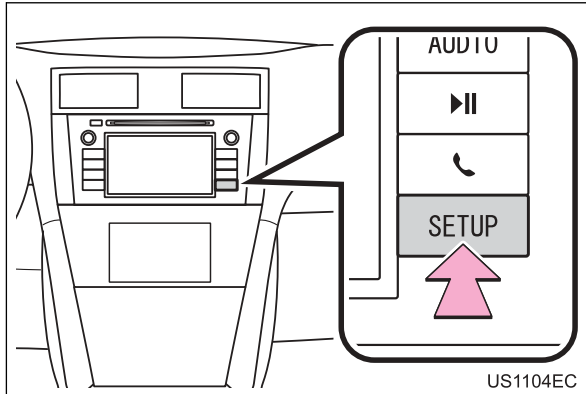

2 Touch “**General**”.

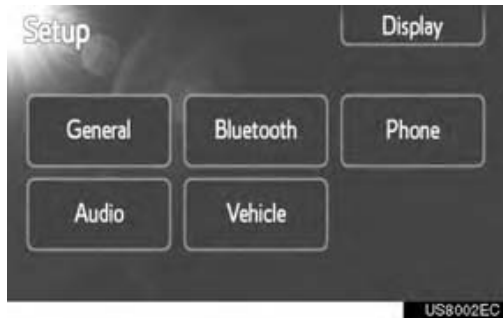

3 Touch the items to be set.

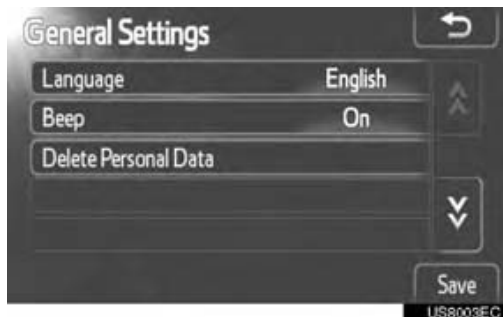

4 Touch “**Save**”.

SCREENS FOR GENERAL SETTINGS

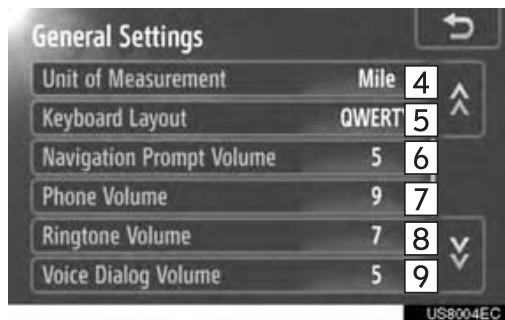
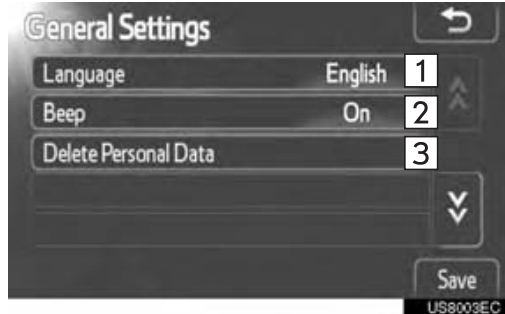

On this screen, the following functions are operational.

No.	Function
1	You can change the language. (See “SELECTING A LANGUAGE” on page 198.)
2	“On” or “Off” can be selected to sound beeps.
3	The personal data can be deleted. (See “DELETE PERSONAL DATA” on page 199.)
4	Touch to set the distance unit to “Kilometer” or “Mile”.

No.	Function
5	Touch to change a keyboard layout. (See “SELECTING A KEYBOARD LAYOUT” on page 199.)
6	Touch to set the navigation prompt volume.
7	Touch to set the phone volume.
8	Touch to set the ringtone volume.
9	Touch to set the voice dialog volume.
10	The entries stored in the “Stored” list on the “My Destinations” screen and “Contacts” screen (See pages 52 and 165.) can be transferred to a USB memory. (See “SENDING STORED CONTACTS TO A USB MEMORY” on page 60.)
11	“vCard” formatted data can be transferred from a USB memory to this system. Transferred addresses and numbers will be stored in the “Stored” list on the “My Destinations” screen and “Contacts” screen. (See “LOADING ADDRESSES VIA A USB MEMORY” on page 56.)
12	Touch to select on or off for daylight saving time.
13	Touch to display the system information.

SELECTING A LANGUAGE

The desired language can be selected.

- 1 Press the “**SETUP**” button.
- 2 Touch “**General**” on the “Setup” screen.
- 3 Touch “**Language**”.

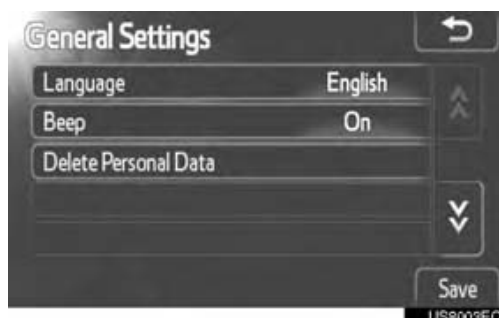

- 4 Touch the desired screen button.



- ‘ The previous screen will be displayed.
- ‘ The selectable languages may differ depending on the model or region.

- 5 Touch “**Save**”.

DELETE PERSONAL DATA

- 1 Press the “**SETUP**” button.
- 2 Touch “**General**” on the “Setup” screen.
- 3 Touch “**Delete Personal Data**”.

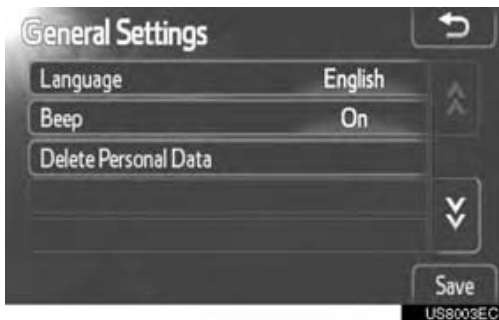

- 4 Touch “**Delete**”.



INFORMATION

- The following personal data can be deleted or returned to their default settings:
 - Phone book data
 - Call history data
 - Speed dial data
 - Bluetooth® devices data
 - Phone sound setting
 - Bluetooth® setting
 - Sound setting

SELECTING A KEYBOARD LAYOUT

- 1 Press the “**SETUP**” button.
- 2 Touch “**General**” on the “Setup” screen
- 3 Touch “**Keyboard Layout**”.

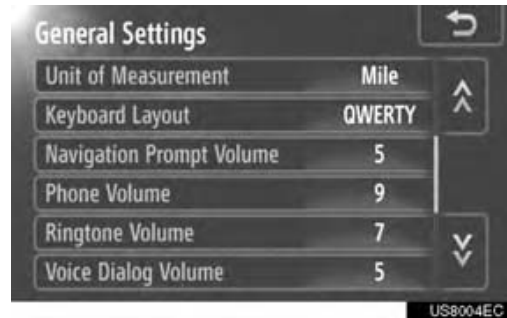

- 4 Touch the desired keyboard layout.



“**QWERTY**”: Latin characters, “QWERTY”-Layout

“**ABC**”: Latin characters, “ABC”-Layout

1. SETUP OPERATION

3. DISPLAY SETTINGS

You can adjust the contrast and brightness of the screen. You can also turn the display off.

- 1 Press the **“SETUP”** button.

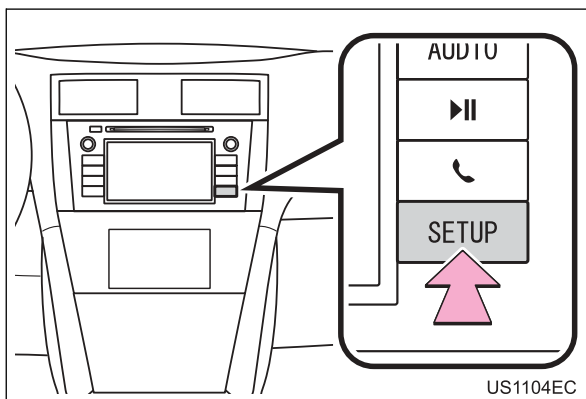

- 2 Touch **“Display”**.

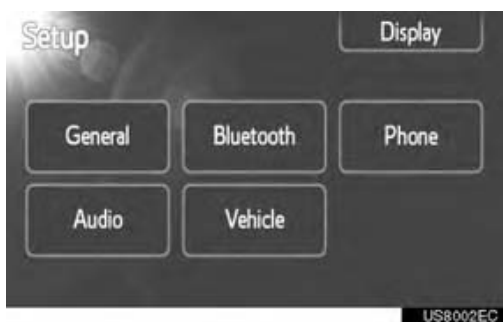

- 3 Touch the items to be set.



Please refer to the following pages for each setting.

TURN OFF DISPLAY

- 1 Press the **“SETUP”** button.
- 2 Touch **“Display”** on the **“Setup”** screen.
- 3 Touch **“Screen Off”**.



The display screen will be turned off. To turn it on, press the **“AUDIO”**, **“CAR”** or **“SETUP”** button.

CHANGING BETWEEN DAY AND NIGHT MODE

Depending on the position of the headlight switch, the screen changes to day or night mode.

- 1 To display the screen in day mode even with the headlight switch on, touch **“Day Mode”** on the adjustment screen for brightness and contrast control.



INFORMATION

- If the screen is set in day mode with the headlight switch turned on, this condition is memorized even with the engine turned off.

ADJUST CONTRAST/ BRIGHTNESS

- 1 Press the **“SETUP”** button.
- 2 Touch **“Display”** on the “Setup” screen.
- 3 Touch **“General”** or **“Camera”**, in which you want to make an adjustment.



- 4 Select **“Contrast”** or **“Brightness”** using the **<<** or **>>**.



- 5 Adjust the contrast or brightness using the **“+”** or **“-”**.

Screen button	Function
“Contrast” “+”	Strengthens the contrast of the screen
“Contrast” “-”	Weakens the contrast of the screen
“Brightness” “+”	Brightens the screen
“Brightness” “-”	Darkens the screen

- 6 After adjusting the screen, touch **“OK”**.

1. SETUP OPERATION

4. Bluetooth[®] SETTINGS

To set up a Bluetooth[®] device.

- 1 Press the “**SETUP**” button.

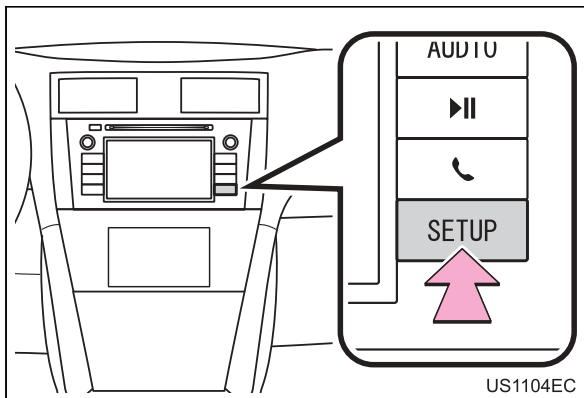

- 2 Touch “**Bluetooth**¹”.

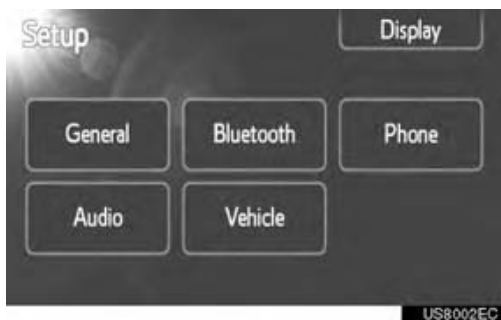

- 3 The following screen will be displayed.



Please refer to the following pages for a description of each setting.

Bluetooth[®] FUNCTION ON/ OFF

The Bluetooth[®] function can be switched on or off.

- 1 Touch “**Bluetooth**¹”.



- 2 Touch “**On**” or “**Off**”.

INFORMATION

- When Bluetooth[®] function is off, “**Search for Bluetooth¹ Devices**”, “**Make Discoverable**”, “**Paired Device List**”, “**Set PIN for Pairing**” and “**Internet Connection**” will be dimmed.

¹: Bluetooth is a registered trademark of Bluetooth SIG, Inc.

PAIRING A Bluetooth® DEVICE

Up to 4 Bluetooth® devices can be paired. A paired device can be connected to any of its supported profiles such as phone, music and/or internet.

CONNECTING FROM THE SYSTEM

- 1 Touch “**Search for Bluetooth¹ Devices**”.



- When a Bluetooth® device is currently connected, a pop-up window is displayed. To disconnect it, touch “**Yes**”.

- 2 The following screen will be displayed while searching for a Bluetooth® device.



- To cancel this function, touch “**Cancel**”.

- 1: Bluetooth is a registered trademark of Bluetooth SIG, Inc.

- 3 Touch the device to be paired.



- Connectable Bluetooth® devices will be displayed in the list.

- 4 The following screen will be displayed.



- To cancel this function, touch “**Cancel**”.

- 5 Confirm the PIN.

- If the device supports SSP (Secure Simple Pairing)

- Confirm the PIN displayed on the screen, and then touch “**Accept**”.

- If the device does not supports SSP (Secure Simple Pairing)

- Input the PIN displayed on the screen into the device.

- 6 The following screen will be displayed when pairing is complete.



7 The system waits for connection requests coming from the paired device. All requested profiles are connected automatically.

- ‘ Internet profile is not connected automatically. For details on connecting internet profile, see “LOGIN PROCESS INTERNET PROFILE” on page 205.
- ‘ If the automatic connection failed, the following screen will be displayed. Touch the desired profile to be connected.

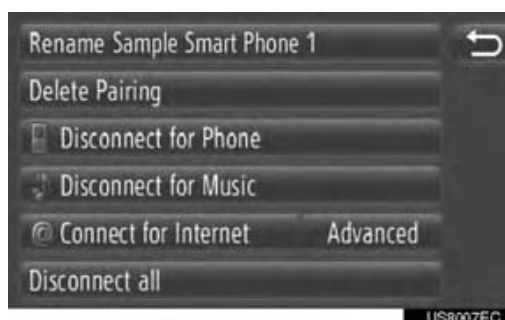

“Connect for Phone”: Touch to connect the phone profile.

“Connect for Music”: Touch to connect the music profile.

“Connect for Internet”, “Advanced”: Touch to connect the internet profile. The screen will be changed to the login process. (See page 205.)

“Connect All”: Touch to connect all supported profiles.

- ‘ Once you have connected the Bluetooth® device, it is automatically connected whenever the engine switch is in the “ACC” or “ON” position.

INFORMATION

- For details on device detection and the operation of your Bluetooth® device, see the manual that comes with the Bluetooth® device.
- The music profiles the paired device supports can be connected individually as desired. Some devices do not allow individual profiles to be connected. In that case, a pop-up window is displayed.

CONNECTING FROM THE DEVICE

- 1 Touch **“Make Discoverable”**.



- ‘ When a Bluetooth® device is currently connected, a pop-up window is displayed. To disconnect it, touch **“Yes”**.

- 2 The following screen will be displayed.



- ‘ To cancel this function, touch **“Cancel”**.

- 3 Confirm the PIN.

- i If the device supports SSP (Secure Simple Pairing)
 - ‘ Confirm the PIN displayed on the screen, and then touch **“Accept”**.
- i If the device does not supports SSP (Secure Simple Pairing)
 - ‘ Input the PIN displayed on the screen into the device.

LOGIN PROCESS INTERNET PROFILE

- i If **“Connect for Internet”** is selected

- 1 Touch **“Connect for Internet”**.

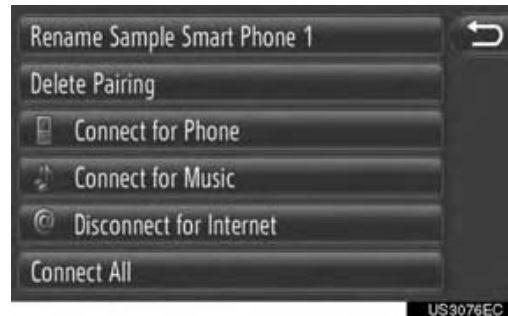

- 2 Touch the desired provider.

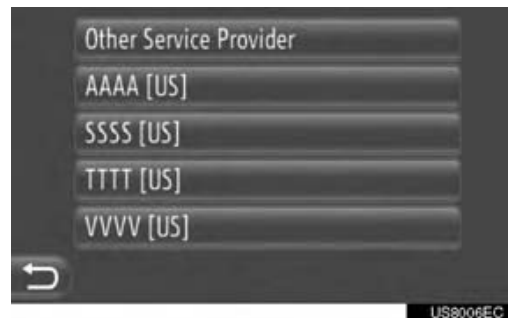

- ‘ This screen is displayed only when making the first connection.

- i If **“Advanced”** is selected.

- 1 Touch **“Advanced”**.

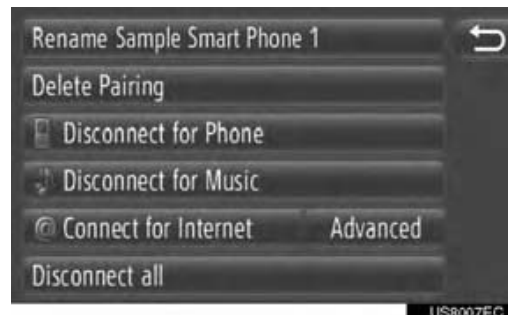

2 Touch “Confirm Provider Information”.

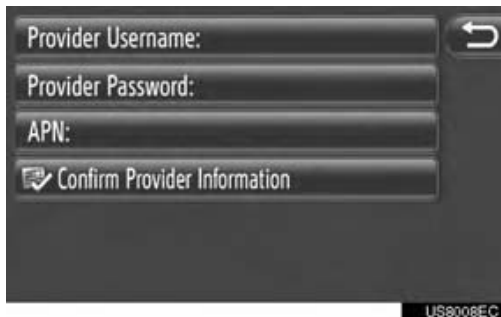

- User login information can be changed on this screen.

INFORMATION

- When making the first connection, “Advanced” is not displayed.
- When “Remember User Login Information” function is on, the entered user login information will be remembered for every login. (See page 208.)

DISPLAYING THE PAIRED DEVICE LIST

Devices can be disconnected and each profile connection status can be changed using the list.

Up to 4 devices can be paired at the same time.

1 Touch “Paired Device List”.



2 Touch the desired device.



- The tone of the icons show which profiles the device supports. (Dimmed icons are not available.)
- The device’s currently connected profiles are highlighted.

3 The following screen will be displayed.

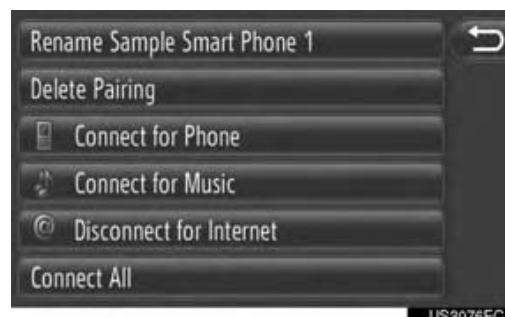

- On this screen, the following functions can be operated.

CHANGING THE DEVICE NAME

- 1 Touch **“Rename XX”**.
- 2 Input the device name.
- 3 Touch **“OK”**.

DELETING A PAIRED DEVICE

- 1 Touch **“Delete Pairing”**.
- 2 Touch **“Yes”**.

CONNECTING OR DISCONNECTING PROFILES

- 1 Touch the desired profile to be connected or disconnected.



“Connect All”: Touch to connect all supported profiles.

“Disconnect All”: Touch to disconnect all supported profiles.

SETTING PIN

To change the PIN.

- 1 Touch **“Set PIN for Pairing”**.



- 2 Input the desired number.



* A 4 to 8-digit PIN can be selected.

- 3 Touch **“OK”**.

SETTING THE INTERNET CONNECTION

To change the internet settings.

1 Touch “Internet Connection”.



2 Touch the desired items to be set.

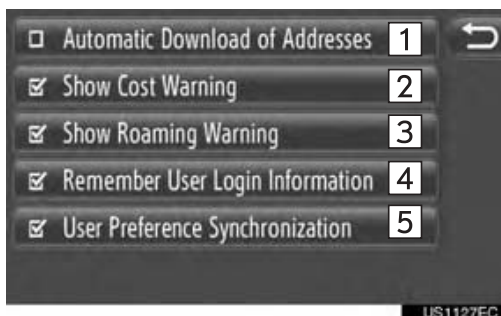

On this screen, the following functions can be set.

No.	Function
1	Touch to turn the automatic download of addresses function on or off.
2	Touch to turn the show cost warning function on or off. When this function is activated, a pop-up window will be displayed before using Entune service.
3	Touch to turn the show roaming warning function on or off. When this function is activated, a pop-up window will be displayed before using Entune service.
4	Touch to turn the remember user login information function on or off. When this function is activated, the entered user login information will be remembered for every user login.
5	Touch to turn the automatic synchronization function on or off.

INFORMATION

- If “Automatic Download of Addresses” is activated, “Show Cost Warning” and “Show Roaming Warning” will be dimmed.

5. PHONE SETTINGS

Settings are available for ringtone selection, announce incoming short message and email, and “Stored” lists.

1 Press the “**SETUP**” button.

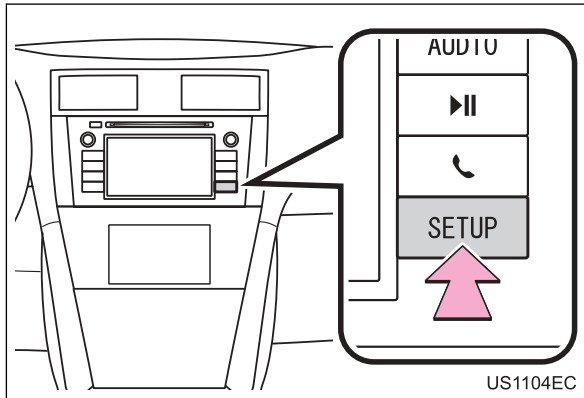

2 Touch “**Phone**”.

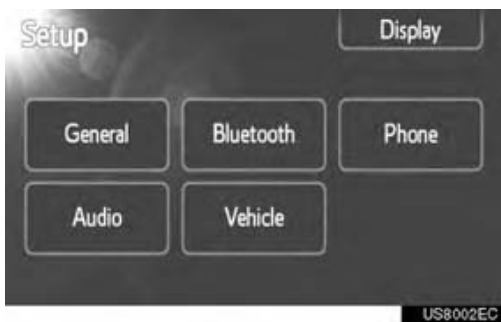

3 Touch the desired items to be set.



SCREEN FOR PHONE SETTINGS



On this screen, the following functions can be set.

No.	Function
1	Touch to select a ringtone. No ringtone, the phone’s ringtone and the system’s 4 ringtones are available for selection.
2	Touch to turn the incoming short message announcement function “ On ” or “ Off ”.
3	Touch to turn the incoming Email announcement function “ On ” or “ Off ”.
4	Touch to update the phone book of the connected phone. The updated list refers to the “Stored” list on the “My Destinations” screen and “Contacts” screen. (See pages 52 and 165.)

6. AUDIO SETTINGS

HD Radio™ system can be set using the following procedure:

1 Press the “**SETUP**” button.

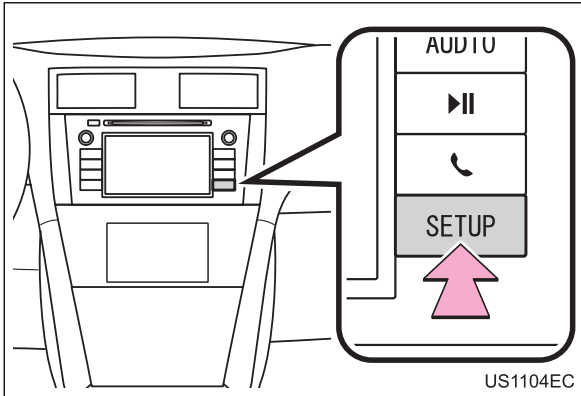

2 Touch “**Audio**”.



3 Touch “**HD Radio Settings**”.

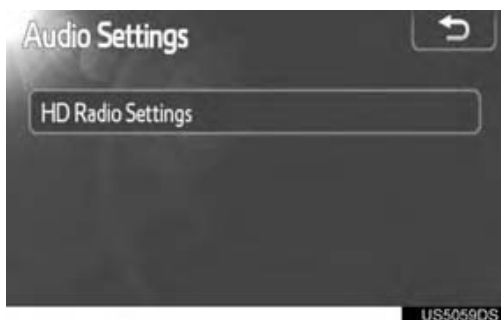

4 Select the desired setting from “**HD Radio/Analog Setting**”.

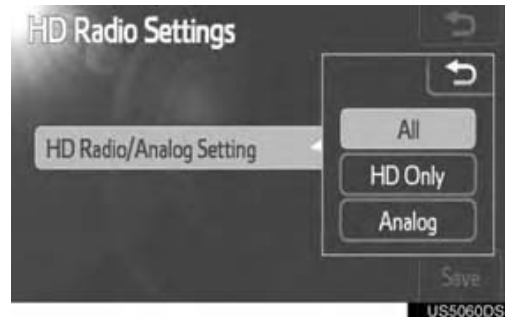

Screen button	Function
“All”	Touch to receive both analog and digital broadcasts.
“HD Only”	Touch to receive only digital broadcasts.
“Analog”	Touch to receive only analog broadcasts.

5 Touch “**Save**”.

7. VEHICLE SETTINGS¹

Vehicle customization settings can be changed.

1 Press the “**SETUP**” button.

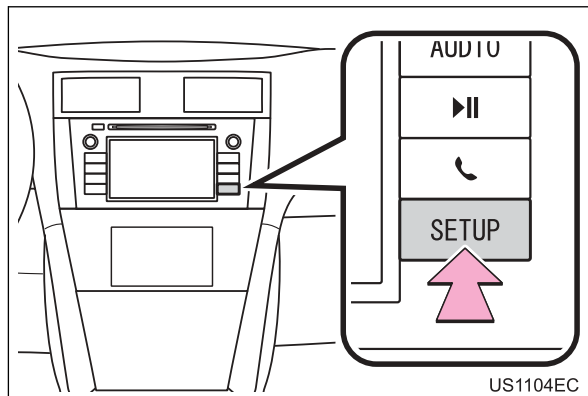

2 Touch “**Vehicle**”.

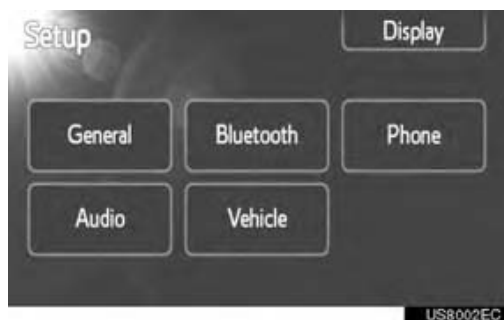

3 Touch the desired items to be set.

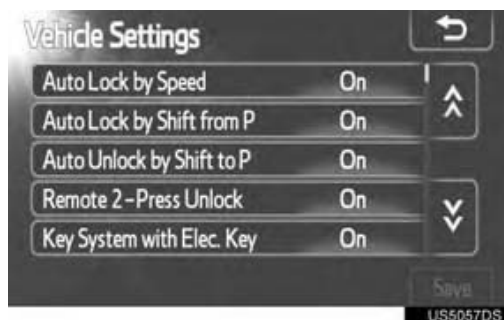

For a list of the settings that can be changed, see “*Owner’s Manual*”.

4 After changing the settings, touch “**Save**”.

A message indicating that the settings are being saved will appear. Do not perform any other operations while this message is displayed.

¹: If equipped

REAR VIEW MONITOR SYSTEM

1 REAR VIEW MONITOR SYSTEM

- | | |
|---|------------|
| 1. REAR VIEW MONITOR SYSTEM OPERATION..... | 214 |
| REAR VIEW MONITOR GUIDE LINES | 215 |
| AREA DISPLAYED ON SCREEN..... | 216 |
| THE REAR VIEW MONITOR SYSTEM CAMERA | 216 |
| 2. DRIVING PRECAUTIONS (WITH REAR VIEW MONITOR GUIDE LINES)..... | 218 |

1

2

3

4

5

6

7

8

9

1. REAR VIEW MONITOR SYSTEM OPERATION

The rear view monitor system assists the driver by displaying an image of the view behind the vehicle while backing up.

The image is displayed in reverse on the screen. This allows the image to appear in the same manner as that of the rear view mirror.

- 1 To display the rear view image on the screen, the shift lever is in the “R” position when the engine switch is in the “ON” position.
- If you move the shift lever out of the “R” position, the screen returns to the previous screen.



CAUTION

- Never depend on the rear view monitor system entirely when backing up. Always make sure your intended path is clear.
Use caution, just as you would when backing up any vehicle.
- Never back up while looking only at the screen. The image on the screen is different from actual conditions. Depicted distances between objects and flat surfaces will differ from the actual distances. If you back up while looking only at the screen, you may hit a vehicle, a person or an object. When backing up, be sure to check behind and all around the vehicle visually and with mirrors before proceeding.
- Do not use the system when the back door, trunk or tailgate is not completely closed.
- Use your own eyes to confirm the vehicle’s surroundings, as the displayed image may become faint or dark, and moving images will be distorted, or not entirely visible when the outside temperature is low. When backing up, be sure to check behind and all around the vehicle visually and with mirror before proceeding.
- Do not use the system in the following cases:
 - On icy or slick road surfaces, or in snow.
 - When using tire chains or emergency tires.
 - On an uneven road, such as a slope.
- i With rear view monitor guide lines (If equipped)
 - Always check the vehicle surrounding area, because the guide lines are ancillary lines.
 - The guide lines are ancillary lines and do not change even if the steering wheel is turned.

**NOTICE**

- If the back of the vehicle is hit, the position and mounting angle of the camera may change. Be sure to have the camera's position and mounting angle checked at your Toyota dealer.
- As the camera has a water proof construction, do not detach, disassemble or modify it. This may cause incorrect operation.
- If the temperature changes rapidly, such as when hot water is poured on the vehicle in cold weather, the system may not operate normally.
- Do not strongly rub the camera lens. If the camera lens is scratched, it can not transmit a clear image.
- Do not allow organic solvent, car wax, window cleaner or glass coat to adhere to the camera. If this happens, wipe it off as soon as possible.
- If the tire size is changed, the area displayed on the screen may change.
- When washing the vehicle, do not apply intensive bursts of water to the camera or camera area. Doing so may result in the camera malfunctioning.

INFORMATION

- If the camera lens becomes dirty, it cannot transmit a clear image. If water droplets, snow, or mud adhere to the lens, rinse with water and wipe with a soft cloth. If the lens is extremely dirty, wash it with a mild cleanser and rinse.

REAR VIEW MONITOR GUIDE LINES (IF EQUIPPED)

Guide lines are displayed on the screen.

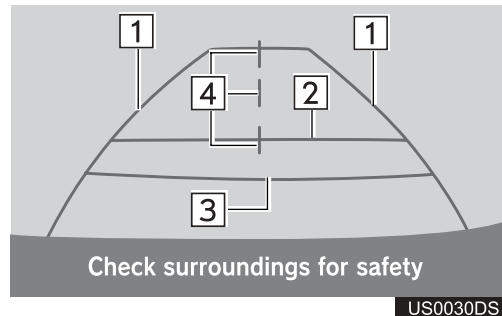

- ‘ Guidelines shown differ from those shown on the actual screen.

1 Vehicle width extension guide lines (blue)

- ‘ These lines indicate the estimated vehicle width extension.

2 Distance guide line (blue)

- ‘ This line indicates a position on the ground about 3 ft. (1 m) behind on the ground of the rear bumper of the vehicle.

3 Distance guide line (red)

- ‘ This line indicates a position on the ground about 1.5 ft. (0.5 m) behind on the ground of the rear bumper of the vehicle.

4 Vehicle center guide lines (blue)

- ‘ These lines indicate the estimated vehicle center on the ground.

AREA DISPLAYED ON SCREEN

Image is displayed approximately level on screen.

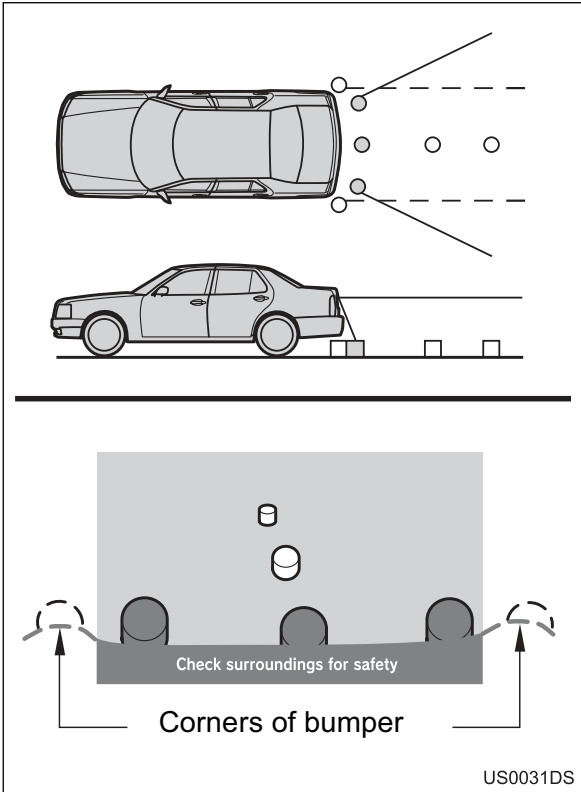

INFORMATION

- The area detected by the camera is limited. The camera does not detect objects which are close to either corner of the bumper or under the bumper.

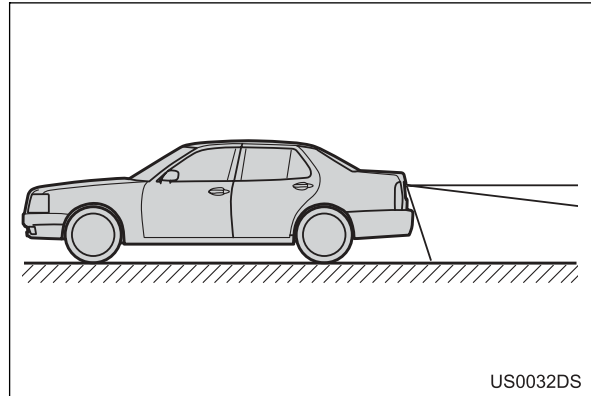

INFORMATION

- The area displayed on the screen may vary according to vehicle orientation or road conditions.

THE REAR VIEW MONITOR SYSTEM CAMERA

The rear view monitor system camera is located as shown in the illustration.

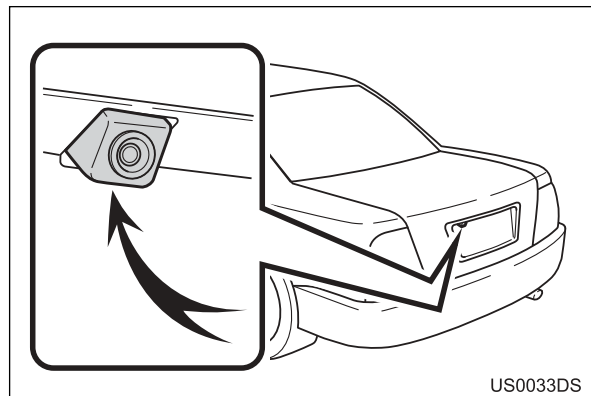

- The actual camera location may differ depending on the vehicle. For details, see the Pictorial index of "Owner's Manual".

INFORMATION

- The camera uses a special lens. The distance of the image that appears on the screen differs from the actual distance.
- In the following cases, it may become difficult to see the images on the screen, even when the system is functioning.
 - In the dark (for example, at night)
 - When the temperature near the lens is high or low
 - When water droplets are adhering to the camera, or when humidity is high (for example, when it rains)
 - When foreign matter (for example, snow or mud) is adhering to the camera
 - When the camera has scratches or dirt on it
 - When the sun or the beam of headlights is shining directly into the camera lens
- When the camera is used under fluorescent lights, sodium lights, or mercury lights etc., the lights and the illuminated areas may appear to flicker.

i On some models



If a bright light (for example, sunlight reflected off the vehicle body) is picked up by the camera, the smear effect* peculiar to the camera may occur.

*: Smear effect ∞ A phenomenon that occurs when a bright light (for example, sunlight reflected off the vehicle body) is picked up by the camera; when transmitted by the camera, the light source appears to have a vertical streak above and below it.

1. REAR VIEW MONITOR SYSTEM

2. DRIVING PRECAUTIONS (WITH REAR VIEW MONITOR GUIDE LINES)

In any of the following situations, there is a margin of error between the guide lines on the screen and the actual distance/course on the road.

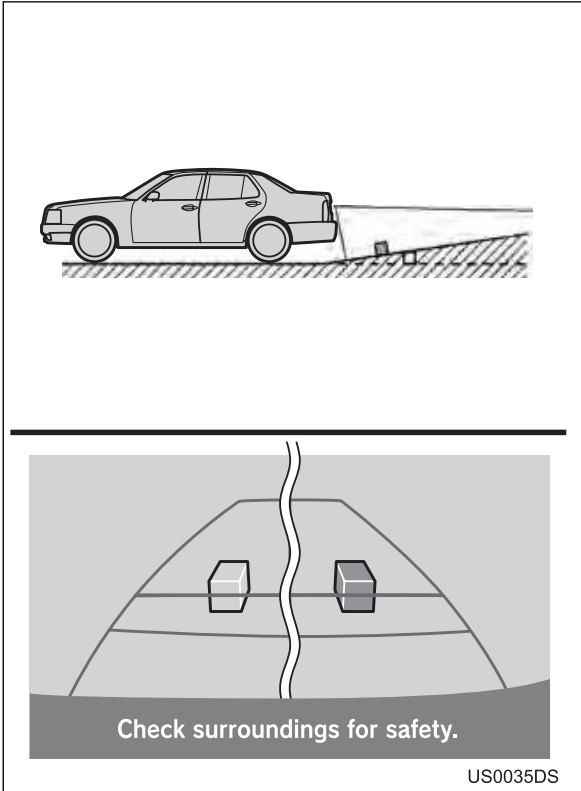

- When the grade behind the vehicle slopes up sharply, objects appear to be farther away than they actually are.

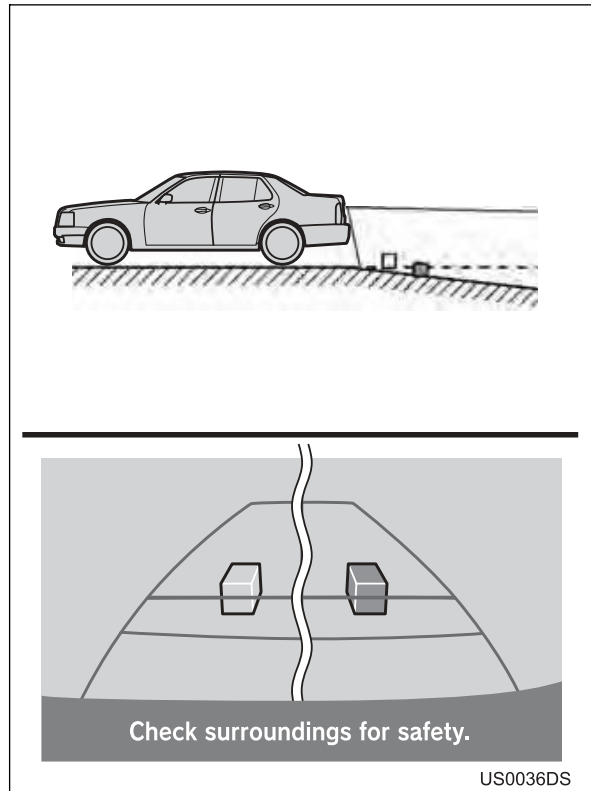

- When the grade behind the vehicle slopes down sharply, objects appear to be closer than they actually are.

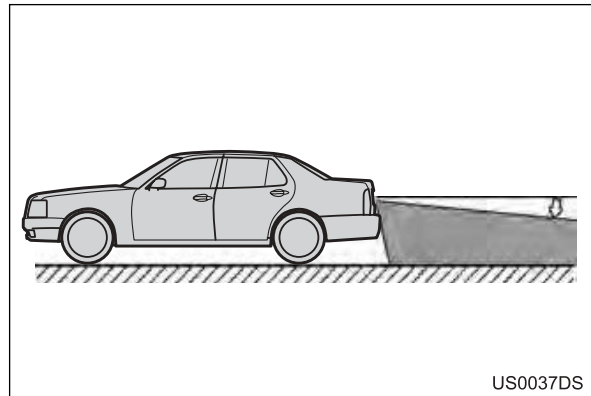

- When any part of the vehicle sags due to the number of passengers or the distribution of the load, there is a margin of error between the guide lines on the screen and the actual distance/course on the road.

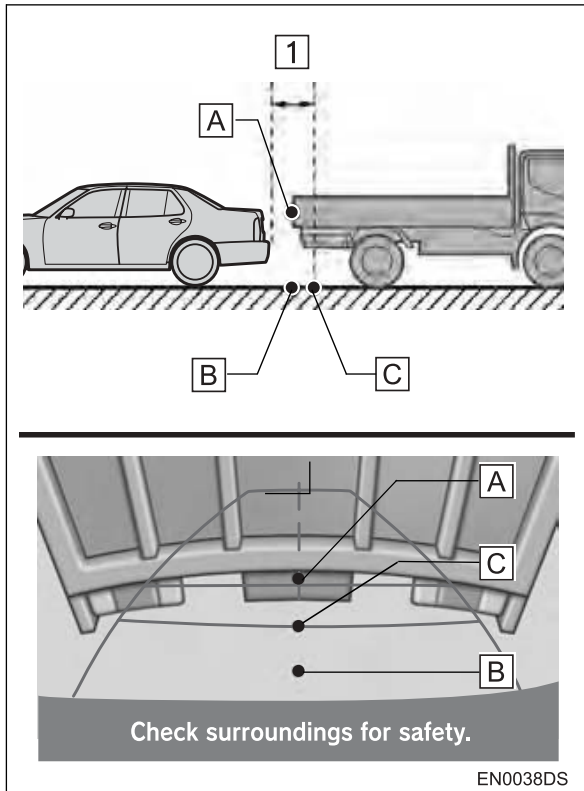

1 Approx. 1.5 ft. (0.5 m)

The distance that appears on the screen between three-dimensional objects (such as vehicles) and flat surfaces (such as the road) and the actual distance differ as follows.

- In reality, $A = B < C$ (A and B are equally far away; C is farther than A and B). However, on the screen, the situation appears to be $B < C < A$.
- On the screen, it appears that a truck is parking approximately 1.5 ft. (0.5 m) away. However, in reality if you back up to point B , you will hit the truck.

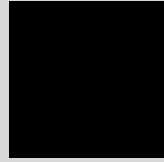

INDEX

1

2

3

4

5

6

7

8

9



ALPHABETICAL INDEX

A

Adding destinations.....	49
“Address”	35
Adjust contrast/brightness.....	201
“Advanced”	40
“AM”	106
Application operation	93
Apps.....	93
APPS button	20, 74
“Audio”	100
Audio remote controls (steering switches)	141
Audio system	99
Audio system operating hints.....	144
Caring for your CD player and discs.....	146
CD-R and CD-RW discs.....	149
iPod	145
MP3/WMA files.....	148
Radio reception	144
Terms	150
USB memory.....	146

B

“Beep”	197
Bluetooth®	132, 153, 202
Bluetooth® audio	132
Connecting Bluetooth® audio	134
Playing Bluetooth® audio player.....	137
Sound setting.....	104, 105
Switching to Bluetooth® audio mode	133
Bluetooth® hands-free system	153
Bluetooth® settings	202
Bluetooth® function ON/OFF	202
Displaying the paired device list.....	206
Pairing a Bluetooth® device.....	203
Setting pin.....	207

C

“Calendar”	79
“Call History”	173
Calling on a Bluetooth® phone.....	170
By call history	173
By dial.....	170

By phone book	171
By POI call	174
By speed dials	172
By “Stored” list on the “Contacts” screen	170
Calling using a short message	173
CAR button	190
CD	117
Cellular phone	153
Channel category	113
Checking calendar	79
Connecting a Bluetooth® phone	161
Connecting Bluetooth® audio	134
Controls using the “TUNE SCROLL” knob	103

D

“Day / Night Mode”	61
“Delete Personal Data”	197
Destination search	33
On the “Enter Destination” screen	35
On the “My Destinations” screen	33
Detour the segment on the route	51, 88
Dial	170

Displaying and editing the entry information	58, 168
Displaying the radio ID	112
Displaying the title and name	114
Download application	93
Operating application	93
DSP control	104
Automatic sound levelizer (ASL)	104
Surround function	104

E

Eject button	117
Email	77
Checking “Email”	77
Receiving a new email	77
“Enter Destination”	35

F

“FM”	106
Fuel consumption	191
History	192
Trip information	191
Function index	12

ALPHABETICAL INDEX

G

- “General” 197
- General settings 197

H

- HD Radio™ 106
- HD Radio™ broadcasting 106
- Home 52
- How to subscribe to an XM®
 - Satellite Radio 112
 - How to subscribe 112
 - Satellite tuner technology notice 112

I

- If the satellite radio tuner malfunctions ... 115
- “Information” screen 190
- Input screen 14
- Inserting or ejecting a disc 117
 - Ejecting a disc 117
 - Inserting a disc 117
- iPod 123
 - About iPod 145
 - Compatible models 145
- iPod cover art 127

L

- “Language” 197
- Limitations of the navigation system 66
- List screen 16

M

- “Map” 19
- Map icons 29
 - POI icons 29
 - Traffic messages 86
- Map information 68
- Map layout 28
- Map screen 25
- Map settings 61
- MP3 117
- MP3/WMA files 117
 - Playable bit rates 148
 - Sampling frequency 148
- Multicasting (only when listening to an HD Radio™ channel) 109
- “My Destinations” 33, 52

N	
“Navigation” menu screen.....	21
Navigation operation.....	20
Navigation setting	61
Navigation system	19

O	
“Options” button	46
Overview buttons and “Applications” menu screen.....	20, 74
Overview guidance screen	22

P	
“Phone”	154
Phone book.....	171
Phone book data.....	159
Phone settings	209
Picture slideshow	75
Displaying the pictures	75
Playing picture slideshows	76

“Pictures”	75
Play/Pause button.....	100
Playing a MP3/WMA disc.....	120
Playing repeat and random order	122
Selecting a desired file	121
Selecting a desired folder.....	121
Playing a USB memory/iPod.....	124
Repeat and random play functions.....	128
Selecting a desired song	125
Playing an audio CD	118
Playing repeat and random order	120
Selecting a desired track	119
Playing Bluetooth® audio	137
Repeat and random play functions.....	140
Selecting a desired song	138
“POI”	29
POI call	174
POI icon	29
Presetting a channel	113
Presetting a station	106
PWR VOL knob.....	102

ALPHABETICAL INDEX

Q

Quick guide 9

R

Radio broadcast data system 107

Radio reception 144

 AM 144

 FM 144

 XM® 145

Rear view monitor system 213

Recalculating the route by the
 traffic messages 89

Receiving on a Bluetooth® phone 175

Reconnecting the Bluetooth® phone 164

Registering a entry 52, 165

 Displaying and editing the entry
 information 58, 168

 Registering a entry
 as “Speed Dials” 167

 Registering a new entry 52, 165

 Sending stored contacts to a
 USB memory 60

Registering “Home” 52

Route guidance 44

Route guidance screen 44

“Route Options” 64

Route preferences 43, 64

Route settings 64

S

Satellite radio (SAT) 112

Screens for general settings 197

 Delete personal data 199

 Selecting a language 198

“SEEK/TRACK” button 100

Selecting a channel 114

Selecting a station 107

Setting “Home” as the destination 33

Setting the route 43

Setup 195

SETUP button 196

“Setup” screen 196

Short message function 179

 Checking received short messages 179

 Checking sent short messages 180

 Sending a new short messages 180

Showing the tire pressure screen	193
SMS message	179
“Speed Dials”	167, 172
Starting route guidance screen.....	42
Steering switches.....	141
Switching audio source.....	103
Switching to AUX mode	131
Switching to Bluetooth® audio mode	133
Switching to CD mode	118
Switching to radio mode	106
Switching to satellite radio mode	113
Switching to USB or iPod mode.....	124

T

Talking on the Bluetooth® phone.....	176
Adjusting the receiver volume.....	177
Dialing a second number	177
Incoming call waiting	175
Sending tones	177
Telephone.....	153
Telephone (hands-free system for cellular phone).....	153
About the phonebook in this system.....	159
Using the phone switch	158
When you sell or dispose of the vehicle	159

Terms.....	150
ID3 tag.....	150
ISO 9660 format.....	150
m3u	150
MP3.....	150
Packet write.....	150
WMA.....	150
WMA tag.....	150
To display map screen.....	25
Tone and balance	105
Balance	105
Tone	105
Traffic announcement	108
Traffic message setting.....	90
“Traffic Messages”	86
“TUNE SCROLL” knob.....	103
Turn off display	200
Turning the audio system on or off	102

U

USB memory.....	146
USB memory/iPod	123
Connecting a USB memory or iPod ...	123
Playing a USB memory or iPod.....	124
Sound setting	104, 105
Switching to USB or iPod mode	124
Using the phone switch.....	158

ALPHABETICAL INDEX

V

Vehicle information	189
Voice command system.....	185
Voice guidance	45
Volume adjustment	45, 177, 197

W

“Waypoint”	49
When you release your car	159
WMA	120, 148

Z

Zoom in button	27
Zoom out button.....	27