

## HAC T-Coil Signal Test Report

<b>Test report no.:</b>	T-Coil_RM-927_02	<b>Date of report:</b>	2013-09-10
<b>Template version:</b>	9.0	<b>Number of pages:</b>	26
<b>Testing laboratory:</b>	TCC Nokia Salo Laboratory P.O.Box 86 Joensuunkatu 7H / Kiila 1B FIN-24101 SALO, FINLAND Tel. +358 (0) 7180 08000 Fax. +358 (0) 7180 45220	<b>Client:</b>	Nokia Corporation 16620 West Bernardo Drive SAN DIEGO CA. 92127 USA Tel. +1 858 831 5000 Fax. +1 858 831 6500
<b>Responsible test engineer:</b>	Janne Hirsimäki	<b>Product contact person:</b>	Victoria Abadilla
<b>Measurements made by:</b>	Janne Hirsimäki, Sami Savela		
<b>Tested devices:</b>	RM-927 (Hearing aid mode active)		
<b>FCC ID:</b>	QMND	<b>IC:</b>	661X-D
<b>Supplement reports:</b>	RF_RM-927_01, HAC_Photo_RM-927_03, 101237626LEX-001, 101237626LEX-002		
<b>Testing has been carried out in accordance with:</b>	<b>ANSI C63.19-2011</b> American National Standard for Methods of Measurement of Compatibility between Wireless Communications Devices and Hearing Aids		
<b>Documentation:</b>	The documentation of the testing performed on the tested devices is archived for 15 years at TCC Nokia.		
<b>Test results:</b>	<b>The tested device complies with the requirements in respect of all parameters subject to the test.</b> The test results and statements relate only to the items tested. The test report shall not be reproduced except in full, without written approval of the laboratory.		
<b>Date and signatures:</b>			
For the contents:			

**CONTENTS**

**1. SUMMARY OF HAC T-COIL SIGNAL TEST REPORT ..... 3**

1.1 TEST DETAILS..... 3

1.2 SUMMARY OF T-COIL TEST RESULTS ..... 3

    1.2.1 *T-Coil Coupling Field Intensity*..... 3

    1.2.2 *Frequency Response at Axial Measurement Point*..... 3

    1.2.3 *Signal Quality*..... 4

    1.2.4 *Overall HAC rating of the tested device*..... 4

**2. DESCRIPTION OF THE DEVICE UNDER TEST (DUT) ..... 5**

2.1 PICTURE OF THE DEVICE..... 6

**3. TEST CONDITIONS ..... 6**

3.1 TEMPERATURE AND HUMIDITY..... 6

3.2 DEVICE CONTROL AND PARAMETERS ..... 6

**4. DESCRIPTION OF THE TEST EQUIPMENT ..... 7**

4.1 MEASUREMENT SYSTEM AND COMPONENTS ..... 7

    4.1.1 *Audio Magnetic Probe AM1DV3*..... 8

    4.1.2 *Audio Magnetic Measurement Instrument AMMI*..... 8

    4.1.3 *Audio Magnetic Calibration Coil AMCC* ..... 8

    4.1.4 *Device Holder*..... 8

4.2 VERIFICATION OF THE SYSTEM ..... 8

**5. DESCRIPTION OF THE TEST PROCEDURE ..... 9**

5.1 TEST ARCH AND DEVICE HOLDER ..... 9

5.2 TEST POSITIONS..... 9

5.3 T-COIL SCAN PROCEDURES AND USED TEST SIGNALS ..... 10

5.4 T-COIL REQUIREMENTS AND CATEGORY LIMITS..... 11

**6. MEASUREMENT UNCERTAINTY ..... 12**

**7. RESULTS ..... 13**

**APPENDIX A: MEASUREMENT SCANS ..... 15**

**APPENDIX B: AUDIO MAGNETIC PROBE AM1DV3 CALIBRATION DOCUMENT ..... 26**

## 1. SUMMARY OF HAC T-COIL SIGNAL TEST REPORT

### 1.1 Test Details

Period of test	2013-08-14 to 2013-08-15
SN, HW, SW and DUT numbers of tested device	SN: 355906/05/001259/9, HW: 0106, SW: 1028.0305.1329.2000, DUT: 17615
Batteries used in testing	-
State of sample	Prototype unit
Notes	-

### 1.2 Summary of T-Coil Test Results

#### 1.2.1 T-Coil Coupling Field Intensity

##### 1.2.1.1 Axial Field Intensity (z)

Mode	Minimum limit [dB (A/m)]	Result [dB (A/m)]	Verdict
GSM850	-18	6.68	Pass
WCDMA850	-18	6.03	Pass
GSM1900	-18	5.65	Pass
WCDMA1900	-18	5.97	Pass

##### 1.2.1.3 Transversal Field Intensity (y)

Mode	Minimum limit [dB (A/m)]	Result [dB (A/m)]	Verdict
GSM850	-18	2.83	Pass
WCDMA850	-18	3.81	Pass
GSM1900	-18	1.62	Pass
WCDMA1900	-18	3.72	Pass

#### 1.2.2 Frequency Response at Axial Measurement Point

Mode	Verdict
GSM850	Pass
WCDMA850	Pass
GSM1900	Pass
WCDMA1900	Pass

### 1.2.3 Signal Quality

Mode	Minimum limit [dB]				Minimum result [dB]	Category assessment
	T1	T2	T3	T4		
GSM850	0	10	20	30	47.28	T4
WCDMA850	0	10	20	30	50.05	T4
GSM1900	0	10	20	30	47.77	T4
WCDMA1900	0	10	20	30	49.99	T4

### 1.2.4 Overall HAC rating of the tested device

Mode	RF emissions category at T-coil axial measurement point (E-field)*	Category assessment, T-Coil signal quality	Combined HAC category of the tested device
GSM850	M4	T4	M4/T4
WCDMA850	M4	T4	
GSM1900	M4	T4	
WCDMA1900	M4	T4	

\*See separate HAC RF report

## 2. DESCRIPTION OF THE DEVICE UNDER TEST (DUT)

Air-interface	Band (MHz)	Type	C63.19/ tested	Simultaneous Transmissions	Reduced power	Voice Over Digital Transport OTT Capability	HAC report number
GSM	850	VO	Yes	Yes BT, WLAN	N/A	NA	T-Coil_RM-927_02
	1900				N/A	NA	T-Coil_RM-927_02
	GPRS/EDGE	DT	NA	Yes BT, WLAN	N/A	YES*	-
CDMA	800 1900	V/D	Yes	Yes BT, LTE, WLAN	N/A	YES	101237626LEX-002
WCDMA	850 1900	V/D	Yes	Yes BT, WLAN	N/A	YES	T-Coil_RM-927_02
LTE	750 1700/2100	DT	NA	Yes CDMA, BT, WLAN	N/A	YES*	-
BT	2450	DT	NA	Yes GSM, GPRS/EDGE, CDMA, WCDMA, LTE	N/A	YES*	-
WLAN	2450 5000	DT	NA	Yes GSM, GPRS/EDGE, CDMA, WCDMA, LTE	N/A	YES*	-

VO Voice CMRS/PSTN Service Only

V/D Voice CMRS/PSTN and Data Service

DT Digital Transport

\*supports only non CMRS voice (OTT).

HAC rating was evaluated for voice mode only in GSM and WCDMA air interfaces in this report.  
HAC rating for CDMA was evaluated in separate test report 101237626LEX-002.

Outside of USA the transmitter of the device is capable of operating also in 900MHz, 1800MHz and 2100MHz bands, which are not part of this filing.

---

## 2.1 Picture Of The Device

See separate report HAC\_Photo\_RM-927\_03.

## 3. TEST CONDITIONS

### 3.1 Temperature and Humidity

Ambient temperature (°C):	21.0 to 23.0
Ambient humidity (RH %):	40 to 60

### 3.2 Device Control and Parameters

The transmitter of the device was put into operation by using a call tester. Communications between the device and the call tester were established by air link. Speech coding was processed with EFR speech codec for GSM and with AMR 12.2 kbps for WCDMA.

The device output power was set to maximum power level for all tests; a fully charged battery was used for every test sequence.

T-Coil mode was switched on from the device user interface, volume setting was set to maximum and microphone was muted.

In all operating bands the measurements were performed on middle channel.

#### 4. DESCRIPTION OF THE TEST EQUIPMENT

##### 4.1 Measurement System and Components

The measurements were performed using an automated near-field scanning system, DASYS2 version 52.6, manufactured by Schmid & Partner Engineering AG (SPEAG) in Switzerland.

Components and signal paths of used measurement system are pictured below:

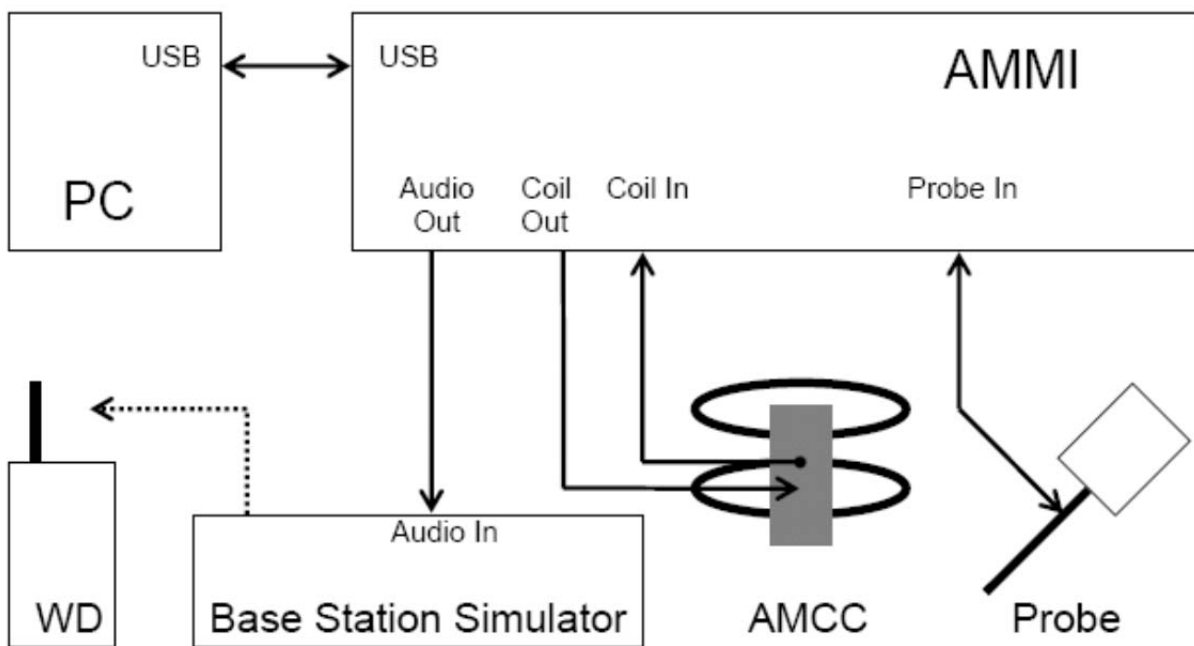

The following table lists calibration dates of measurement equipment:

Test Equipment	Serial Number	Calibration interval	Calibration expiry
R&S CMU200 Radio Communication Test Set	835734/097	-	-
AM1DV3 Audio Magnetic Probe	3079	12 months	2014-06
AMMI Audio Magnetic Measurement Instrument	1014	-	-
AMCC Helmholtz Audio Magnetic Calibration Coil	1030	-	-

---

#### 4.1.1 Audio Magnetic Probe AM1DV3

<b>Construction</b>	Fully RF shielded metal construction (RF sensitivity < -100dB)
<b>System calibration</b>	Calibrated using Helmholtz coil according to manufacturers instructions
<b>Frequency range</b>	0.1 – 20 kHz (HOX! test signal is limited to required BW of 300 to 3000 Hz, ANSI C63.19)
<b>Sensitivity</b>	< -50 dB A/m
<b>Dimensions</b>	Overall length: 290 mm; Tip diameter: 6 mm

#### 4.1.2 Audio Magnetic Measurement Instrument AMMI

<b>Sampling Rate</b>	48 kHz / 24 bit
<b>Dynamic Range</b>	85 dB
<b>Test Signal Generation</b>	User selectable and predefined (via PC)
<b>System calibration</b>	Auto-calibration / full system calibration using AMCC with monitor output

#### 4.1.3 Audio Magnetic Calibration Coil AMCC

<b>Dimensions</b>	370 x 370 x 196 mm (ANSI-C63.19 compliant)
-------------------	--

#### 4.1.4 Device Holder

The device holder and Test Arch are manufactured by Speag ([www.speag.com](http://www.speag.com)). Test arch is used for all tests i.e. for both validation testing and device testing. The holder and test arch conforms to the requirements of ANSI C63.19.

The SPEAG device holder (see Section 5.1) was used to position the test device in all tests.

### 4.2 Verification of the System

Audio Magnetic Probe AM1D is calibrated in AMCC Helmholtz Audio Magnetic Calibration Coil before each measurement procedure using calibration and reference signals.

R&S CMU200 audio codec and SPEAG AMMI audio paths (gain) were calibrated according to manufacturer's instructions.



## 5. DESCRIPTION OF THE TEST PROCEDURE

### 5.1 Test Arch and Device Holder

The test device was placed in the Device Holder (illustrated below) that is supplied by SPEAG. Using this positioner the tested device is positioner under Test Arch.

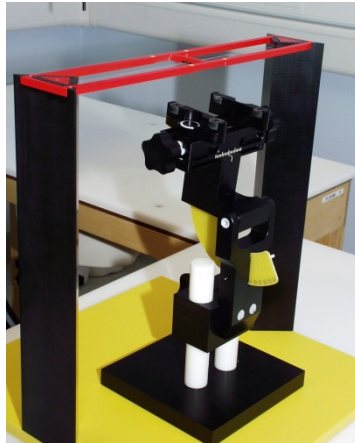

Device holder and Test Arch supplied by SPEAG

### 5.2 Test Positions

The device was positioned such that Device Reference Plane was touching the bottom of the Test Arch. The acoustic output is aligned with the intersection of the Test Arch's middle bar and dielectric wire. The WD is positioned always this way to ensure repeatability of the measurements. Coordinate system depicted below is used to define exact locations of measurement points relative to the center of the acoustic output.

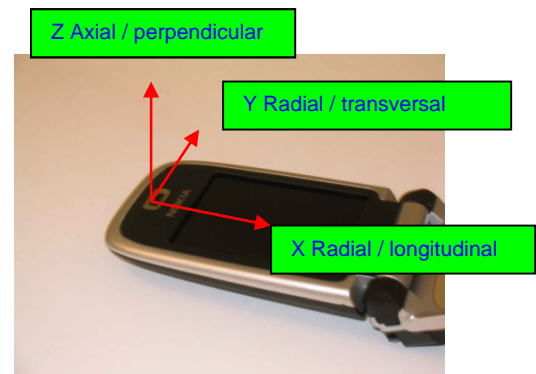

Photo of the device positioned under Test Arch and coordinate system (The EUT in picture is generic phone sample and does not represent the actual equipment under test)

---

### 5.3 T-Coil Scan Procedures and Used Test Signals

Manufacturer can either define measurement locations for WD categorization or optimum locations can be found using following procedure: First, large scans in all measurement orientations with dense grid step size are made to find locations of optimum signal. Point scans are made in these locations.

During measurements signal is fed to WD via communication tester. Proper gain setting is used in software to ensure correct signal level fed to communication tester speech input. Measurement software compares fed signal and signal from measurement probe and applies proper filtering and integration procedures.

Broadband voice-like signal (300...3000Hz) is used during scans and frequency response measurement to ensure proper operation of WD vocoder and audio enhancement algorithms.

In final measurement sine signal is used to determine signal strength @ 1 kHz. Both signal (ABM1) and undesired audio noise (ABM2) are measured consequently to enable determination of signal to noise ratio (SNR).

## 5.4 T-Coil Requirements and Category Limits

### RF Emissions

Wireless device has to fulfill RF emission requirements at the axial measurement location.

### Axial, Longitudinal and Transversal Field Intensity

T-Coil signal magnetic field shall be  $\geq -18\text{dB(A/m)}$  at 1 kHz, in 1/3 octave band filter for all orientations.

### Signal Quality

The worst result of two T-Coil signal measurements is used to determine the T-Coil mode category:

Category	T1	T2	T3	T4
Limits for Signal Quality	0	10	20	30

### Frequency Response

Frequency response of the axial component must be between the limits pointed by frequency curves below:

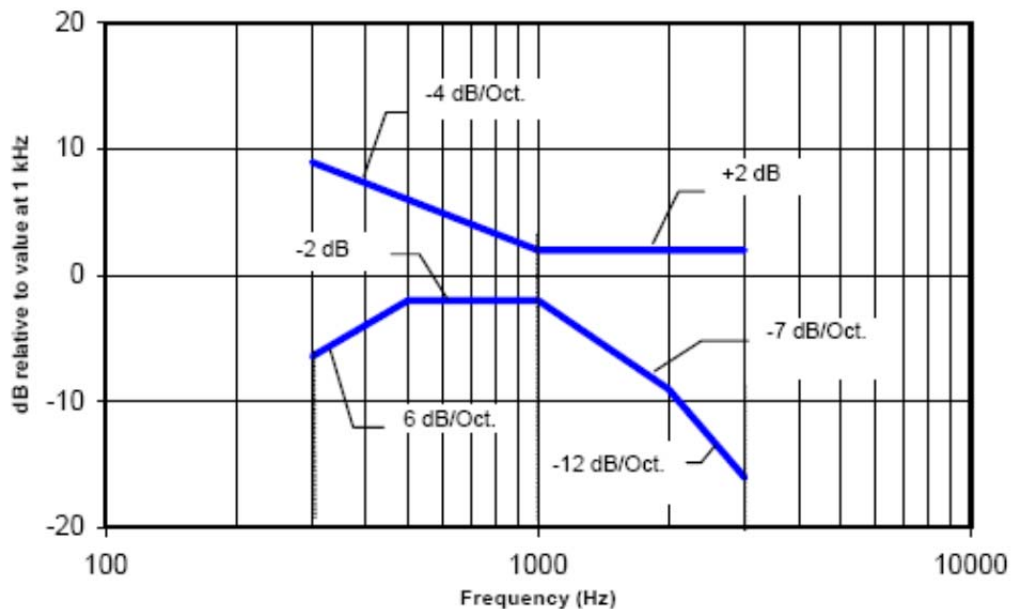

Magnetic field frequency response for devices with a field that exceeds  $-15\text{dB (A/m)}$  @ 1kHz.

## 6. MEASUREMENT UNCERTAINTY

Source of Uncertainty	Tolerance ±%	Probability Distribution	Div.	c ABM1	c ABM2	Standard Uncertainty ±%, ABM1	Standard Uncertainty ±%, ABM2
<b>PROBE SENSITIVITY</b>							
Reference level	3.0	N	1.0	1	1	3.0	3.0
AMCC geometry	0.4	R	√3	1	1	0.2	0.2
AMCC current	0.6	R	√3	1	1	0.4	0.4
Probe positioning during calibration	0.1	R	√3	1	1	0.1	0.1
Noise contribution	0.7	R	√3	0.0143	1	0.0	0.4
Frequency slope	5.9	R	√3	0.1	1.0	0.3	3.5
<b>PROBE SYSTEM</b>							
Repeatability / Drift	1.0	R	√3	1	1	0.6	0.6
Linearity / Dynamic range	0.6	R	√3	1	1	0.4	0.4
Acoustic noise	1.0	R	√3	0.1	1	0.1	0.6
Probe angle	2.3	R	√3	1	1	1.4	1.4
Spectral processing	0.9	R	√3	1	1	0.5	0.5
Integration time	0.6	N	1.0	1	5	0.6	3.0
Field disturbance	0.2	R	√3	1	1	0.1	0.1
<b>TEST SIGNAL</b>							
Reference signal spectral response	0.6	R	√3	0	1	0.0	0.4
<b>POSITIONING</b>							
Probe positioning	1.9	R	√3	1	1	1.1	1.1
Phantom thickness	0.9	R	√3	1	1	0.5	0.5
EUT Positioning	1.9	R	√3	1	1	1.1	1.1
<b>EXTERNAL CONTRIBUTIONS</b>							
RF interference	0.0	R	√3	1	1	0.0	0.0
Test signal variation	2.0	R	√3	1	1	1.2	1.2
<b>COMBINED UNCERTAINTY</b>							
Combined Standard Uncertainty (ABM field)						4.1	6.1
<b>Expanded Standard Uncertainty [%]</b>						<b>8.1</b>	<b>12.3</b>

## 7. RESULTS

Measurement location coordinates are defined as deviation from earpiece center in millimeters. Coordinate system is defined in chapter 4.2

Axial measurement location was defined by the manufacturer of the device as the center of the earpiece. Maximum values for axial field are listed for informative purposes although results at earpiece center were used in evaluating T-category of the device.

### GSM850 results

	Transversal (y)		Axial (z)			
			Max signal		Earpiece	
	x	y	x	y	x	y
Measurement location (x,y) [mm]	-4.4	3.8	-4.1	-5.6	0.0	0.0
Signal strength [dB A/m]	2.83		11.38		6.68	
ABM2 [dB A/m]	-44.45		-43.9		-44.52	
Signal quality [dB]	<b>47.28</b>		55.28		51.20	
Ambient background noise at point (0,0) ABM [dB A/m]	-46.68		-46.67		-46.67	

### WCDMA850 results

	Transversal (y)		Axial (z)			
			Max signal		Earpiece	
	x	y	x	y	x	y
Measurement location (x,y) [mm]	-5.5	5.7	-4.8	-5.3	0.0	0.0
Signal strength [dB A/m]	3.81		13.33		6.03	
ABM2 [dB A/m]	-46.24		-44.38		-46.03	
Signal quality [dB]	<b>50.05</b>		57.71		52.06	
Ambient background noise at point (0,0) ABM [dB A/m]	-46.68		-46.67		-46.67	

**GSM1900 results**

	Transversal (y)		Axial (z)			
			Max signal		Earpiece	
	x	y	x	y	x	y
Measurement location (x,y) [mm]	-10.2	-17.8	-5.3	-5.3	0.0	0.0
Signal strength [dB A/m]	1.62		14.93		5.65	
ABM2 [dB A/m]	-46.15		-43.73		-45.15	
Signal quality [dB]	<b>47.77</b>		58.66		50.80	
Ambient background noise at point (0,0) ABM [dB A/m]	-46.68		-46.67		-46.67	

**WCDMA1900 results**

	Transversal (y)		Axial (z)			
			Max signal		Earpiece	
	x	y	x	y	x	y
Measurement location (x,y) [mm]	-4.9	-14.8	-4.8	-5.4	0.0	0.0
Signal strength [dB A/m]	3.72		13.20		5.97	
ABM2 [dB A/m]	-46.27		-44.43		-45.95	
Signal quality [dB]	<b>49.99</b>		57.63		51.92	
Ambient background noise at point (0,0) ABM [dB A/m]	-46.68		-46.67		-46.67	

Plots of the measurement scans are presented in Appendix A.

---

**APPENDIX A: MEASUREMENT SCANS**

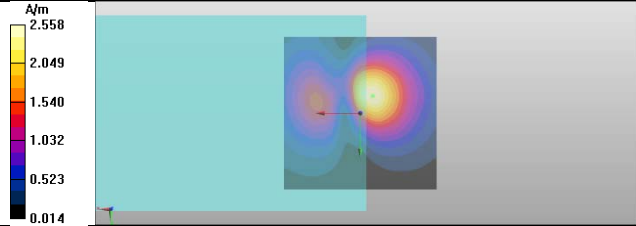
<b>Axial Measurements, GSM850</b>	
<p>Date/Time: 2013-08-14 10:52:25            Test Laboratory: TCC Nokia  <b>Type: RM-927; Serial: 355906/05/001259/9</b>            Communication System: GSM850            Frequency: 836.6 MHz; Duty Cycle: 1:8.30042            Medium: Air; Medium Notes: -            Medium parameters used: <math>\sigma = 0</math> S/m, <math>\epsilon_r = 1</math>; <math>\rho = 1</math> kg/m<sup>3</sup>            Phantom section: TCoil Section</p>	<p>DASY Configuration:            - Probe: AM1DV3 - 3079            - ; Calibrated: 2013-06-14            - Sensor-Surface: 0mm (Fix Surface)            - Electronics: DAE4 Sn1213; Calibrated: 2013-01-11            - Phantom: HAC Test Arch with AMCC; Type: SD HAC P01 BA; Serial: -            - Measurement SW: DASY52, Version 52.8 (6); SEMCAD X Version 14.6.10 (7164)</p>
<p><b>T-Coil GSM850/General Scans/z (axial) coarse scan/ABM Interpolated Signal(x,y,z) (101x101x1):</b>            Interpolated grid: dx=1.000 mm, dy=1.000 mm            Signal Type: Audio File (.wav) 48k_voice_300-3000_2s.wav            Output Gain: 54.9            Device Reference Point: 0, 0, -6.3 mm            ABM1 = 8.16 dBA/m</p>	
<p><b>T-Coil GSM850/General Scans/point scan at best SNR(z)/ABM SNR(x,y,z) (1x1x1): Measurement grid: dx=10mm, dy=10mm</b>            Signal Type: 1kHz Sine            Output Gain: 8.58            Device Reference Point: 0, 0, -6.3 mm            ABM1/ABM2 = 55.28 dB            ABM1 comp = 11.38 dBA/m            Location: -4.1, -5.6, 3.7 mm</p>	
<p><b>T-Coil GSM850/General Scans/point scan at ACOUSTIC OUTPUT location/ABM SNR(x,y,z) (1x1x1): Measurement grid: dx=10mm, dy=10mm</b>            Signal Type: 1kHz Sine            Output Gain: 8.58            Device Reference Point: 0, 0, -6.3 mm            ABM1/ABM2 = 51.20 dB            ABM1 comp = 6.68 dBA/m            Location: 0, 0, 3.7 mm</p>	
	
<p><b>T-Coil/Background Noise/z (axial) noise/ABM Noise(x,y,z) (1x1x1):</b>            Measurement grid: dx=10mm, dy=10mm            Signal Type: Off            Output Gain: 0            Device Reference Point: 0, 0, -6.3 mm            ABM2 = -46.67 dBA/m            Location: 0, 0, 13 mm</p>	

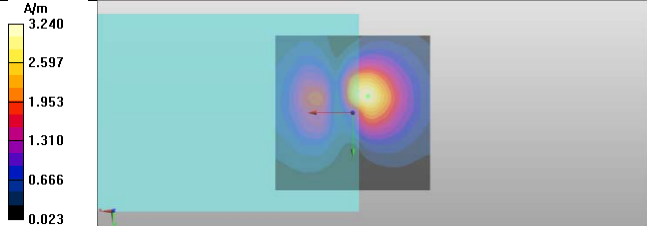

<b>Axial Measurements, WCDMA850</b>	
<p>Date/Time: 2013-08-15 10:23:36            Test Laboratory: TCC Nokia  <b>Type: RM-927; Serial: 355906/05/001259/9</b>            Communication System: WCDMA850 (Band 5)            Frequency: 835 MHz; Duty Cycle: 1:1            Medium: Air; Medium Notes: -            Medium parameters used: <math>\sigma = 0</math> S/m, <math>\epsilon_r = 1</math>; <math>\rho = 1</math> kg/m<sup>3</sup>            Phantom section: TCoil Section</p>	<p>DASY Configuration:            - Probe: AM1DV3 - 3079            - ; Calibrated: 2013-06-14            - Sensor-Surface: 0mm (Fix Surface)            - Electronics: DAE4 Sn1213; Calibrated: 2013-01-11            - Phantom: HAC Test Arch with AMCC; Type: SD HAC P01 BA; Serial:-            - Measurement SW: DASY52, Version 52.8 (6); SEMCAD X Version 14.6.10 (7164)</p>
<p><b>T-Coil WCDMA850/General Scans/z (axial) coarse scan/ABM Interpolated Signal(x,y,z) (101x101x1):</b>            Interpolated grid: dx=1.000 mm, dy=1.000 mm            Signal Type: Audio File (.wav) 48k_voice_300-3000_2s.wav            Output Gain: 54.9            Device Reference Point: 0, 0, -6.3 mm            ABM1 = 10.21 dBA/m</p>	
<p><b>T-Coil WCDMA850/General Scans/point scan at best SNR(z)/ABM SNR(x,y,z) (1x1x1):</b>            Measurement grid: dx=10mm, dy=10mm            Signal Type: 1kHz Sine            Output Gain: 8.58            Device Reference Point: 0, 0, -6.3 mm            ABM1/ABM2 = 57.71 dB            ABM1 comp = 13.33 dBA/m            Location: -4.8, -5.3, 3.7 mm</p> <p><b>T-Coil WCDMA850/General Scans/point scan at ACOUSTIC OUTPUT location/ABM SNR(x,y,z) (1x1x1):</b>            Measurement grid: dx=10mm, dy=10mm            Signal Type: 1kHz Sine            Output Gain: 8.58            Device Reference Point: 0, 0, -6.3 mm            ABM1/ABM2 = 52.06 dB            ABM1 comp = 6.03 dBA/m            Location: 0, 0, 3.7 mm</p>	
	
<p><b>T-Coil/Background Noise/z (axial) noise/ABM Noise(x,y,z) (1x1x1):</b>            Measurement grid: dx=10mm, dy=10mm            Signal Type: Off            Output Gain: 0            Device Reference Point: 0, 0, -6.3 mm            ABM2 = -46.67 dBA/m            Location: 0, 0, 13 mm</p>	

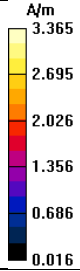
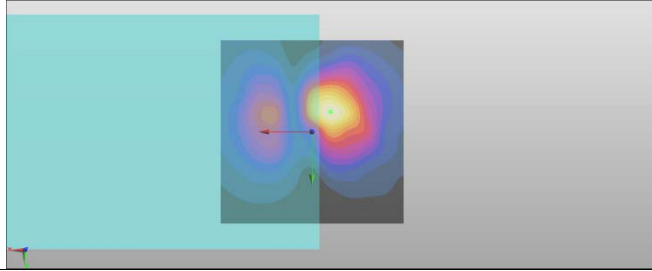
<b>Axial Measurements, GSM1900</b>	
<p>Date/Time: 2013-08-15 13:17:53            Test Laboratory: TCC Nokia  <b>Type: RM-927; Serial: 355906/05/001259/9</b>            Communication System: GSM1900            Frequency: 1880 MHz; Duty Cycle: 1:8.30042            Medium: Air; Medium Notes: -            Medium parameters used: <math>\sigma = 0</math> S/m, <math>\epsilon_r = 1</math>; <math>\rho = 1</math> kg/m<sup>3</sup>            Phantom section: TCoil Section</p>	<p>DASY Configuration:            - Probe: AM1DV3 - 3079            - ; Calibrated: 2013-06-14            - Sensor-Surface: 0mm (Fix Surface)            - Electronics: DAE4 Sn1213; Calibrated: 2013-01-11            - Phantom: HAC Test Arch with AMCC; Type: SD HAC P01 BA; Serial:-            - Measurement SW: DASY52, Version 52.8 (6); SEMCAD X Version 14.6.10 (7164)</p>
<p><b>T-Coil GSM1900/General Scans/z (axial) coarse scan/ABM Interpolated Signal(x,y,z) (101x101x1):</b>            Interpolated grid: dx=1.000 mm, dy=1.000 mm            Signal Type: Audio File (.wav) 48k_voice_300-3000_2s.wav            Output Gain: 54.9            Device Reference Point: 0, 0, -6.3 mm            ABM1 = 10.54 dBA/m</p>	
<p><b>T-Coil GSM1900/General Scans/point scan at best SNR(z)/ABM SNR(x,y,z) (1x1x1):</b>            Measurement grid: dx=10mm, dy=10mm            Signal Type: 1kHz Sine            Output Gain: 8.58            Device Reference Point: 0, 0, -6.3 mm            ABM1/ABM2 = 58.66 dB            ABM1 comp = 14.93 dBA/m            Location: -5.3, -5.3, 3.7 mm</p> <p><b>T-Coil GSM1900/General Scans/point scan at ACOUSTIC OUTPUT location/ABM SNR(x,y,z) (1x1x1):</b>            Measurement grid: dx=10mm, dy=10mm            Signal Type: 1kHz Sine            Output Gain: 8.58            Device Reference Point: 0, 0, -6.3 mm            ABM1/ABM2 = 50.80 dB            ABM1 comp = 5.65 dBA/m            Location: 0, 0, 3.7 mm</p>	
	
<p><b>T-Coil/Background Noise/z (axial) noise/ABM Noise(x,y,z) (1x1x1):</b>            Measurement grid: dx=10mm, dy=10mm            Signal Type: Off            Output Gain: 0            Device Reference Point: 0, 0, -6.3 mm            ABM2 = -46.67 dBA/m            Location: 0, 0, 13 mm</p>	

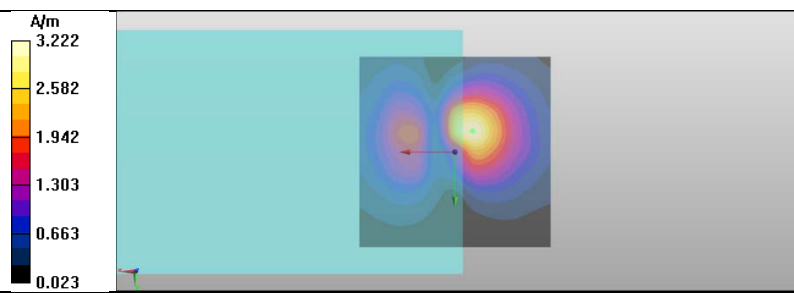
<b>Axial Measurements, WCDMA1900</b>	
<p>Date/Time: 2013-08-15 09:36:25            Test Laboratory: TCC Nokia  <b>Type: RM-927; Serial: 355906/05/001259/9</b>            Communication System: WCDMA1900 (Band 2)            Frequency: 1880 MHz; Duty Cycle: 1:1            Medium: Air; Medium Notes: -            Medium parameters used: <math>\sigma = 0</math> S/m, <math>\epsilon_r = 1</math>; <math>\rho = 1</math> kg/m<sup>3</sup>            Phantom section: TCoil Section</p>	<p>DASY Configuration:            - Probe: AM1DV3 - 3079            - ; Calibrated: 2013-06-14            - Sensor-Surface: 0mm (Fix Surface)            - Electronics: DAE4 Sn1213; Calibrated: 2013-01-11            - Phantom: HAC Test Arch with AMCC; Type: SD HAC P01 BA; Serial:-            - Measurement SW: DASY52, Version 52.8 (6); SEMCAD X Version 14.6.10 (7164)</p>
<p><b>T-Coil WCDMA1900/General Scans/z (axial) coarse scan/ABM Interpolated Signal(x,y,z) (101x101x1):</b>            Interpolated grid: dx=1.000 mm, dy=1.000 mm            Signal Type: Audio File (.wav) 48k_voice_300-3000_2s.wav            Output Gain: 54.9            Device Reference Point: 0, 0, -6.3 mm            ABM1 = 10.16 dBA/m</p>	
<p><b>T-Coil WCDMA1900/General Scans/point scan at best SNR(z)/ABM SNR(x,y,z) (1x1x1):</b>            Measurement grid: dx=10mm, dy=10mm            Signal Type: 1kHz Sine            Output Gain: 8.58            Device Reference Point: 0, 0, -6.3 mm            ABM1/ABM2 = 57.63 dB            ABM1 comp = 13.20 dBA/m            Location: -4.8, -5.4, 3.7 mm</p> <p><b>T-Coil WCDMA1900/General Scans/point scan at ACOUSTIC OUTPUT location/ABM SNR(x,y,z) (1x1x1):</b>            Measurement grid: dx=10mm, dy=10mm            Signal Type: 1kHz Sine            Output Gain: 8.58            Device Reference Point: 0, 0, -6.3 mm            ABM1/ABM2 = 51.92 dB            ABM1 comp = 5.97 dBA/m            Location: 0, 0, 3.7 mm</p>	
	
<p><b>T-Coil/Background Noise/z (axial) noise/ABM Noise(x,y,z) (1x1x1):</b>            Measurement grid: dx=10mm, dy=10mm            Signal Type: Off            Output Gain: 0            Device Reference Point: 0, 0, -6.3 mm            ABM2 = -46.67 dBA/m            Location: 0, 0, 13 mm</p>	

**Frequency response in the point of maximum signal strength (axial)**

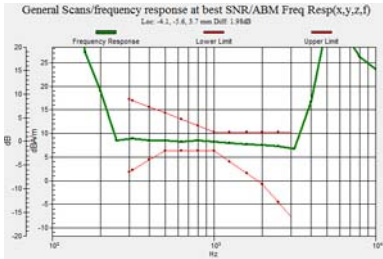

**GSM850**

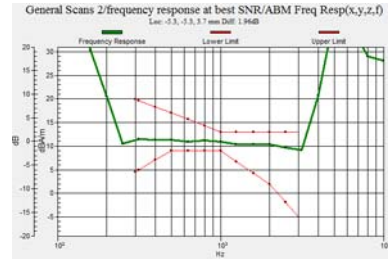

**GSM1900**

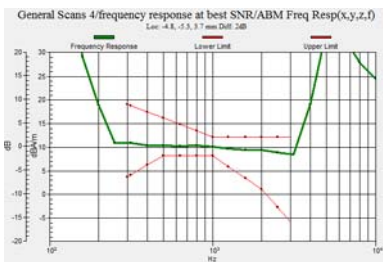

**WCDMA850**

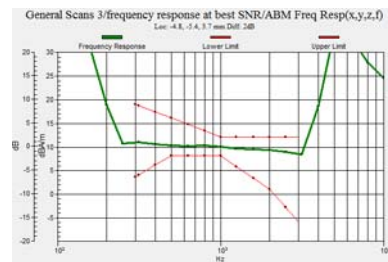

**WCDMA1900**

**Frequency response over earpiece, point 0,0 (axial)**

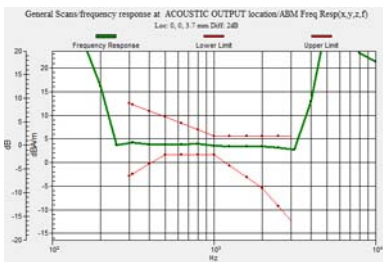

**GSM850**

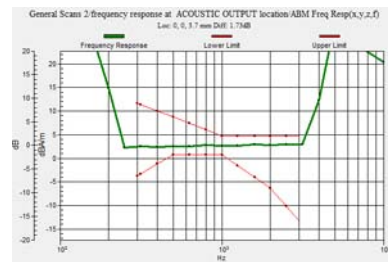

**GSM1900**

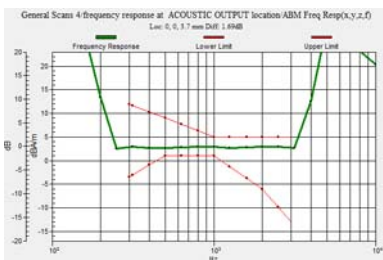

**WCDMA850**

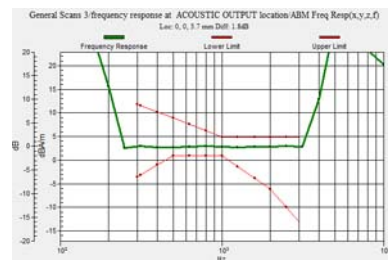

**WCDMA1900**

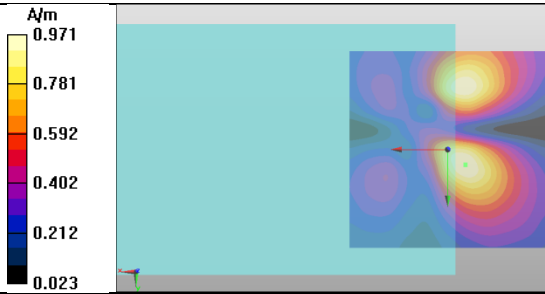
<b>Transversal Measurements, GSM850</b>	
<p>Date/Time: 2013-08-14 11:09:52            Test Laboratory: TCC Nokia  <b>Type: RM-927; Serial: 355906/05/001259/9</b>            Communication System: GSM850            Frequency: 836.6 MHz; Duty Cycle: 1:8.30042            Medium: Air; Medium Notes: -            Medium parameters used: <math>\sigma = 0</math> S/m, <math>\epsilon_r = 1</math>; <math>\rho = 1</math> kg/m<sup>3</sup>            Phantom section: TCoil Section</p>	<p>DASY Configuration:            - Probe: AM1DV3 - 3079            - ; Calibrated: 2013-06-14            - Sensor-Surface: 0mm (Fix Surface)            - Electronics: DAE4 Sn1213; Calibrated: 2013-01-11            - Phantom: HAC Test Arch with AMCC; Type: SD HAC P01 BA; Serial: -            - Measurement SW: DASY52, Version 52.8 (6); SEMCAD X Version 14.6.10 (7164)</p>
<p><b>T-Coil GSM850/General Scans/y (transversal) coarse scan/ABM Interpolated Signal(x,y,z) (101x101x1):</b>            Interpolated grid: dx=1.000 mm, dy=1.000 mm            Signal Type: Audio File (.wav) 48k_voice_300-3000_2s.wav            Output Gain: 54.9            Device Reference Point: 0, 0, -6.3 mm            ABM1 = -0.26 dBA/m</p>	
<p><b>T-Coil GSM850/General Scans/point scan (y)/ABM SNR(x,y,z) (1x1x1):</b>            Measurement grid: dx=10mm, dy=10mm            Signal Type: 1kHz Sine            Output Gain: 8.58            Device Reference Point: 0, 0, -6.3 mm            ABM1/ABM2 = 47.28 dB            ABM1 comp = 2.83 dBA/m            Location: -4.4, 3.8, 3.7 mm</p>	
	
<p><b>T-Coil/Background Noise/y (transversal) noise/ABM Noise(x,y,z) (1x1x1):</b>            Measurement grid: dx=10mm, dy=10mm            Signal Type: Off            Output Gain: 0            Device Reference Point: 0, 0, -6.3 mm            ABM2 = -46.68 dBA/m            Location: 0, 0, 13 mm</p>	

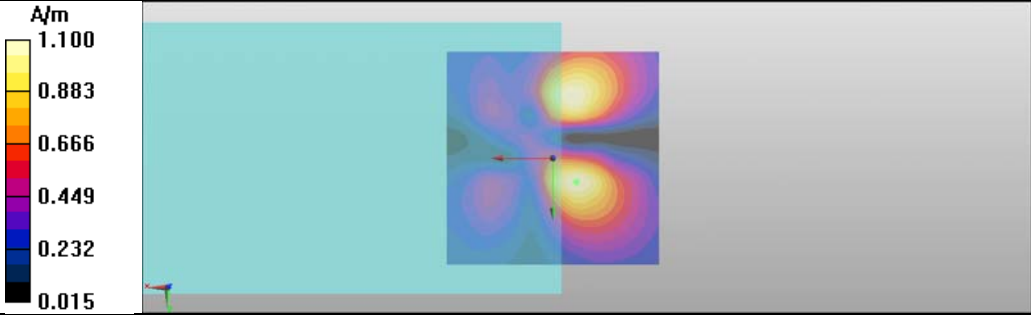
<b>Transversal Measurements, WCDMA850</b>	
<p>Date/Time: 2013-08-15 10:41:02            Test Laboratory: TCC Nokia  <b>Type: RM-927; Serial: 355906/05/001259/9</b>            Communication System: WCDMA850 (Band 5)            Frequency: 835 MHz; Duty Cycle: 1:1            Medium: Air; Medium Notes: -            Medium parameters used: <math>\sigma = 0</math> S/m, <math>\epsilon_r = 1</math>; <math>\rho = 1</math> kg/m<sup>3</sup>            Phantom section: TCoil Section</p>	<p>DASY Configuration:            - Probe: AM1DV3 - 3079            - ; Calibrated: 2013-06-14            - Sensor-Surface: 0mm (Fix Surface)            - Electronics: DAE4 Sn1213; Calibrated: 2013-01-11            - Phantom: HAC Test Arch with AMCC; Type: SD HAC P01 BA; Serial:-            - Measurement SW: DASY52, Version 52.8 (6); SEMCAD X Version 14.6.10 (7164)</p>
<p><b>T-Coil WCDMA850/General Scans/y (transversal) coarse scan/ABM Interpolated Signal(x,y,z) (101x101x1):</b>            Interpolated grid: dx=1.000 mm, dy=1.000 mm            Signal Type: Audio File (.wav) 48k_voice_300-3000_2s.wav            Output Gain: 54.9            Device Reference Point: 0, 0, -6.3 mm            ABM1 = 0.83 dBA/m</p>	
<p><b>T-Coil WCDMA850/General Scans/point scan (y)/ABM SNR(x,y,z) (1x1x1):</b>            Measurement grid: dx=10mm, dy=10mm            Signal Type: 1kHz Sine            Output Gain: 8.58            Device Reference Point: 0, 0, -6.3 mm            ABM1/ABM2 = 50.05 dB            ABM1 comp = 3.81 dBA/m            Location: -5.5, 5.7, 3.7 mm</p>	
	
<p><b>T-Coil/Background Noise/y (transversal) noise/ABM Noise(x,y,z) (1x1x1):</b>            Measurement grid: dx=10mm, dy=10mm            Signal Type: Off            Output Gain: 0            Device Reference Point: 0, 0, -6.3 mm            ABM2 = -46.68 dBA/m            Location: 0, 0, 13 mm</p>	

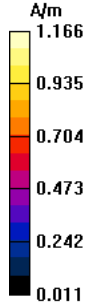
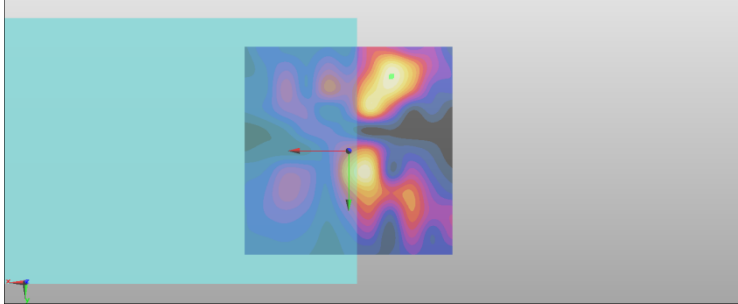
<b>Transversal Measurements, GSM1900</b>	
<p>Date/Time: 2013-08-15 13:35:22            Test Laboratory: TCC Nokia  <b>Type: RM-927; Serial: 355906/05/001259/9</b>            Communication System: GSM1900            Frequency: 1880 MHz; Duty Cycle: 1:8.30042            Medium: Air; Medium Notes: -            Medium parameters used: <math>\sigma = 0</math> S/m, <math>\epsilon_r = 1</math>; <math>\rho = 1</math> kg/m<sup>3</sup>            Phantom section: TCoil Section</p>	<p>DASY Configuration:            - Probe: AM1DV3 - 3079            - ; Calibrated: 2013-06-14            - Sensor-Surface: 0mm (Fix Surface)            - Electronics: DAE4 Sn1213; Calibrated: 2013-01-11            - Phantom: HAC Test Arch with AMCC; Type: SD HAC P01 BA; Serial:-            - Measurement SW: DASY52, Version 52.8 (6); SEMCAD X Version 14.6.10 (7164)</p>
<p><b>T-Coil GSM1900/General Scans/y (transversal) coarse scan/ABM Interpolated Signal(x,y,z) (101x101x1):</b>            Interpolated grid: dx=1.000 mm, dy=1.000 mm            Signal Type: Audio File (.wav) 48k_voice_300-3000_2s.wav            Output Gain: 54.9            Device Reference Point: 0, 0, -6.3 mm            ABM1 = 1.33 dBA/m</p>	
<p><b>T-Coil GSM1900/General Scans/point scan (y)/ABM SNR(x,y,z) (1x1x1):</b>            Measurement grid: dx=10mm, dy=10mm            Signal Type: 1kHz Sine            Output Gain: 8.58            Device Reference Point: 0, 0, -6.3 mm            ABM1/ABM2 = 47.77 dB            ABM1 comp = 1.62 dBA/m            Location: -10.2, -17.8, 3.7 mm</p>	
 <p>A/m 1.166 0.935 0.704 0.473 0.242 0.011</p>	
<p><b>T-Coil/Background Noise/y (transversal) noise/ABM Noise(x,y,z) (1x1x1):</b>            Measurement grid: dx=10mm, dy=10mm            Signal Type: Off            Output Gain: 0            Device Reference Point: 0, 0, -6.3 mm            ABM2 = -46.68 dBA/m            Location: 0, 0, 13 mm</p>	

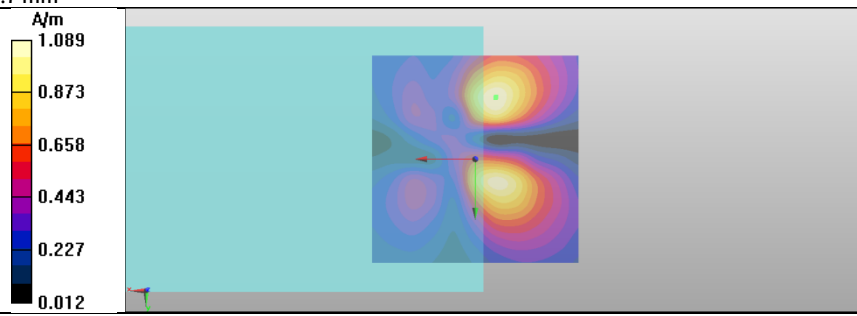

<b>Transversal Measurements, WCDMA1900</b>	
<p>Date/Time: 2013-08-15 09:53:49            Test Laboratory: TCC Nokia  <b>Type: RM-927; Serial: 355906/05/001259/9</b>            Communication System: WCDMA1900 (Band 2)            Frequency: 1880 MHz; Duty Cycle: 1:1            Medium: Air; Medium Notes: -            Medium parameters used: <math>\sigma = 0</math> S/m, <math>\epsilon_r = 1</math>; <math>\rho = 1</math> kg/m<sup>3</sup>            Phantom section: TCoil Section</p>	<p>DASY Configuration:            - Probe: AM1DV3 - 3079            - ; Calibrated: 2013-06-14            - Sensor-Surface: 0mm (Fix Surface)            - Electronics: DAE4 Sn1213; Calibrated: 2013-01-11            - Phantom: HAC Test Arch with AMCC; Type: SD HAC P01 BA; Serial:-            - Measurement SW: DASY52, Version 52.8 (6); SEMCAD X Version 14.6.10 (7164)</p>
<p><b>T-Coil WCDMA1900/General Scans/y (transversal) coarse scan/ABM Interpolated Signal(x,y,z) (101x101x1):</b>            Interpolated grid: dx=1.000 mm, dy=1.000 mm            Signal Type: Audio File (.wav) 48k_voice_300-3000_2s.wav            Output Gain: 54.9            Device Reference Point: 0, 0, -6.3 mm            ABM1 = 0.74 dBA/m</p>	
<p><b>T-Coil WCDMA1900/General Scans/point scan (y)/ABM SNR(x,y,z) (1x1x1):</b>            Measurement grid: dx=10mm, dy=10mm            Signal Type: 1kHz Sine            Output Gain: 8.58            Device Reference Point: 0, 0, -6.3 mm            ABM1/ABM2 = 49.99 dB            ABM1 comp = 3.72 dBA/m            Location: -4.9, -14.8, 3.7 mm</p>	
	
<p><b>T-Coil/Background Noise/y (transversal) noise/ABM Noise(x,y,z) (1x1x1):</b>            Measurement grid: dx=10mm, dy=10mm            Signal Type: Off            Output Gain: 0            Device Reference Point: 0, 0, -6.3 mm            ABM2 = -46.68 dBA/m            Location: 0, 0, 13 mm</p>	

---

**APPENDIX B: AUDIO MAGNETIC PROBE AM1DV3 CALIBRATION DOCUMENT**



Accredited by the Swiss Accreditation Service (SAS)  
The Swiss Accreditation Service is one of the signatories to the EA  
Multilateral Agreement for the recognition of calibration certificates

Accreditation No.: **SCS 108**

Client **Nokia Salo TCC**

Certificate No: **AM1DV3-3079\_Jun13**

## CALIBRATION CERTIFICATE

Object **AM1DV3 - SN: 3079**

Calibration procedure(s) **QA CAL-24.v3**  
**Calibration procedure for AM1D magnetic field probes and TMFS in the audio range**

Calibration date: **June 14, 2013**

This calibration certificate documents the traceability to national standards, which realize the physical units of measurements (SI).  
The measurements and the uncertainties with confidence probability are given on the following pages and are part of the certificate.

All calibrations have been conducted in the closed laboratory facility: environment temperature ( $22 \pm 3$ )°C and humidity < 70%.

Calibration Equipment used (M&TE critical for calibration)

Primary Standards	ID #	Cal Date (Certificate No.)	Scheduled Calibration
Keithley Multimeter Type 2001	SN: 0810278	02-Oct-12 (No:12728)	Oct-13
Reference Probe AM1DV2	SN: 1008	10-Jan-13 (No. AM1D-1008_Jan13)	Jan-14
DAE4	SN: 781	03-Jun-13 (No. DAE4-781_Jun13)	Jun-14

Secondary Standards	ID #	Check Date (in house)	Scheduled Check
AMCC	1050	12-Oct-11 (in house check Oct-11)	Oct-13
AMMI Audio Measuring Instrument	1062	26-Sep-12 (in house check Sep-12)	Sep-14

Calibrated by: **Name** Claudio Leubler **Function** Laboratory Technician

Approved by: **Name** Katja Pokovic **Function** Technical Manager

Signature

Issued: June 17, 2013

This calibration certificate shall not be reproduced except in full without written approval of the laboratory.

## References

- [1] ANSI C63.19-2007  
American National Standard for Methods of Measurement of Compatibility between Wireless Communications Devices and Hearing Aids.
- [2] DASY5 manual, Chapter: Hearing Aid Compatibility (HAC) T-Coil Extension

## Description of the AM1D probe

The AM1D Audio Magnetic Field Probe is a fully shielded magnetic field probe for the frequency range from 100 Hz to 20 kHz. The pickup coil is compliant with the dimensional requirements of [1]. The probe includes a symmetric low noise amplifier for the signal available at the shielded 3 pin connector at the side. Power is supplied via the same connector (phantom power supply) and monitored via the LED near the connector. The 7 pin connector at the end of the probe does not carry any signals, but determines the angle of the sensor when mounted on the DAE. The probe supports mechanical detection of the surface.

The single sensor in the probe is arranged in a tilt angle allowing measurement of 3 orthogonal field components when rotating the probe by 120° around its axis. It is aligned with the perpendicular component of the field, if the probe axis is tilted nominally 35.3° above the measurement plane, using the connector rotation and sensor angle stated below.

The probe is fully RF shielded when operated with the matching signal cable (shielded) and allows measurement of audio magnetic fields in the close vicinity of RF emitting wireless devices according to [1] without additional shielding.

## Handling of the item

The probe is manufactured from stainless steel. In order to maintain the performance and calibration of the probe, it must not be opened. The probe is designed for operation in air and shall not be exposed to humidity or liquids. For proper operation of the surface detection and emergency stop functions in a DASY system, the probe must be operated with the special probe cup provided (larger diameter).

## Methods Applied and Interpretation of Parameters

- *Coordinate System:* The AM1D probe is mounted in the DASY system for operation with a HAC Test Arch phantom with AMCC Helmholtz calibration coil according to [2], with the tip pointing to “southwest” orientation.
- *Functional Test:* The functional test preceding calibration includes test of Noise level  
RF immunity (1kHz AM modulated signal). The shield of the probe cable must be well connected.  
Frequency response verification from 100 Hz to 10 kHz.
- *Connector Rotation:* The connector at the end of the probe does not carry any signals and is used for fixation to the DAE only. The probe is operated in the center of the AMCC Helmholtz coil using a 1 kHz magnetic field signal. Its angle is determined from the two minima at nominally +120° and –120° rotation, so the sensor in the tip of the probe is aligned to the vertical plane in z-direction, corresponding to the field maximum in the AMCC Helmholtz calibration coil.
- *Sensor Angle:* The sensor tilting in the vertical plane from the ideal vertical direction is determined from the two minima at nominally +120° and –120°. DASY system uses this angle to align the sensor for radial measurements to the x and y axis in the horizontal plane.
- *Sensitivity:* With the probe sensor aligned to the z-field in the AMCC, the output of the probe is compared to the magnetic field in the AMCC at 1 kHz. The field in the AMCC Helmholtz coil is given by the geometry and the current through the coil, which is monitored on the precision shunt resistor of the coil.

## AM1D probe identification and configuration data

Item	<b>AM1DV3</b> Audio Magnetic 1D Field Probe
Type No	SP AM1 001 BA
Serial No	<b>3079</b>

Overall length	296 mm
Tip diameter	6.0 mm (at the tip)
Sensor offset	3.0 mm (centre of sensor from tip)
Internal Amplifier	20 dB

Manufacturer / Origin	Schmid & Partner Engineering AG, Zürich, Switzerland
Manufacturing date	March 31, 2010
Last calibration date	November 29, 2010

## Calibration data

Connector rotation angle	(in DASY system)	<b>141.1 °</b>	+/- 3.6 ° (k=2)
Sensor angle	(in DASY system)	<b>0.50 °</b>	+/- 0.5 ° (k=2)
Sensitivity at 1 kHz	(in DASY system)	<b>0.00739 V / (A/m)</b>	+/- 2.2 % (k=2)

The reported uncertainty of measurement is stated as the standard uncertainty of measurement multiplied by the coverage factor k=2, which for a normal distribution corresponds to a coverage probability of approximately 95%.