

**A1600BT BUN; A1600BT; A1600E-BT
USER' S MANUAL**

IC Warning

CS03:

This product meets the applicable Industry Canada technical specifications. / Le présent matériel est conforme aux spécifications techniques applicables d'Industrie Canada.

RSS(Category I Equipment):

This device complies with Industry Canada licence-exempt RSS standard(s). Operation is subject to the following two conditions:

- (1) this device may not cause interference, and
- (2) this device must accept any interference, including interference that may cause undesired operation of the device.

Radio Apparatus Containing Digital Circuits (ICES-003)

Radio apparatus containing digital circuitry which can function separately from the operation of a transmitter or an associated transmitter, shall comply with ICES-003. In such cases, the labelling requirements of the applicable RSS apply, rather than the labelling requirements in ICES-003.

Warning:

This Class B digital apparatus complies with Canadian ICES-003.

Cet appareil numérique de la classe B est conforme □ la norme NMB-003 du Canada.

Under Industry Canada regulations, this radio transmitter may only operate using an antenna of a type and maximum (or lesser) gain approved for the transmitter by Industry Canada. To reduce potential radio interference to other users, the antenna type and its gain should be so chosen that the equivalent isotropically radiated power (e.i.r.p.) is not more than that necessary for successful communication.

7. Connection to party line service is subject to state tariffs. Contact the state public utility commission, public service commission or corporation commission for information.
8. If your home has specially wired alarm equipment connected to the telephone line, ensure the installation of this [US: 6NYW400BA1600BT] does not disable your alarm equipment. If you have questions about what will disable alarm equipment, consult your telephone company or a qualified installer.
9. If the telephone company requests information on what equipment is connected to their lines, inform them of:
 - a) The ringer equivalence number [0.0B]
 - b) The USOC jack required [RJ11C]
 - c) Facility Interface Codes ("FIC") [02LS2]
 - d) Service Order Codes ("SOC") [9.0Y]
 - e) The FCC Registration Number [US: 6NYW400BA1600BT]
10. The REN is used to determine the number of devices that may be connected to a telephone line. Excessive RENs on a telephone line may result in the devices not ringing in response to an incoming call. In most but not all areas, the sum of RENs should not exceed five (5.0). To be certain of the number of devices that may be connected to a line, as determined by the total RENs, contact the local telephone company. The REN for this product is part of the product identifier that has the format US:AAAEQ##TXXXX. The digits represented by ## are the REN without a decimal point. For this product the FCC Registration number is [US: 6NYW400BA1600BT] indicates the REN would be 00.
11. If this product is equipped with a corded or cordless handset, it is hearing aid compatible.

FCC Caution:

Any Changes or modifications not expressly approved by the party responsible for compliance could void the user's authority to operate the equipment.

This device complies with part 15 of the FCC Rules. Operation is subject to the following two conditions: (1) This device may not cause harmful interference, and (2) this device must accept any interference received, including interference that may cause undesired operation.

IMPORTANT NOTE:

FCC Radiation Exposure Statement:

This equipment complies with FCC radiation exposure limits set forth for an uncontrolled environment .This equipment should be installed and operated with minimum distance 20cm between the radiator& your body.

This transmitter must not be co-located or operating in conjunction with any other antenna or transmitter.

Note: This equipment has been tested and found to comply with the limits for a Class B digital device, pursuant to part 15 of the FCC Rules. These limits are designed to provide reasonable protection against harmful interference in a residential installation. This equipment generates, uses and can radiate radio frequency energy and, if not installed and used in accordance with the instructions, may cause harmful interference to radio communications. However, there is no guarantee that interference will not occur in a particular installation. If this equipment does cause harmful interference to radio or television reception, which can be determined by turning the equipment off and on, the user is encouraged to try to correct the interference by one or more of the following measures:

Reorient or relocate the receiving antenna.

Increase the separation between the equipment and receiver.

Connect the equipment into an outlet on a circuit different from that to which the receiver is connected.

Consult the dealer or an experienced radio/TV technician for help.

Privacy of communications may not be ensured when using this telephone!

Customer Information

1. This equipment complies with Part 68 of the FCC rules and the requirements adopted by the ACTA. On the bottom of this equipment is a label that contains, among other information, a product identifier in the format US:AAAEQ##TXXXX. If requested, this number must be provided to the telephone company.
2. A plug and jack used to connect this equipment to the premises wiring and telephone network must comply with the applicable FCC Part 68 rules and requirements adopted by the ACTA. A compliant telephone cord and modular plug is provided with this product. It is designed to be connected to a compatible modular jack that is also compliant. See installation instructions for details.
3. If this equipment [US: 6NYW400BA1600BT] causes harm to the telephone network, the telephone company will notify you in advance that temporary discontinuance of service may be required. But if advance notice isn't practical, the telephone company will notify the customer as soon as possible. Also, you will be advised of your right to file a complaint with the FCC if you believe it is necessary.
4. The telephone company may make changes in its facilities, equipment, operations or procedures that could affect the operation of the equipment. If this happens the telephone company will provide advance notice in order for you to make necessary modifications to maintain uninterrupted service.
5. If trouble is experienced with this equipment [US: 6NYW400BA1600BT], for repair or warranty information, Service can be facilitated through our office at:
U.S. Agent Company name: ClearSounds Communications, Inc.
Address: 1743 Quincy Avenue #155 Naperville, IL 60540 U.S.A
Tel: +630-654-9200
Fax: +630-654-9219
If the equipment is causing harm to the telephone network, the telephone company may request that you disconnect the equipment until the problem is resolved.
6. Please follow instructions for repairing if any (e.g. battery replacement section); otherwise do not alternate or repair any parts of device except specified. For repair procedures, follow the instructions outlined under the limited warranty.

Contents

Prior To Use	1	Connecting your Cellphone	22
Congratulations	1	Disconnecting your Cellphone	24
Safety Precautions	1	Removing a Paired Cellphone	25
Unpacking	3	Basic Functions	26
Phone Layout and Keys Function	4	Making a Call	26
Keys Description	8	Receiving a Call	28
LCD Description	12	Muting the Microphone	30
Connecting Lines	14	Amplification Function	30
Installing Batteries	15	Using your Phone with hearing aids	32
Charging Handset	16	Using Audio and Headset Jacks	32
Using Headset	16	Handsfree	33
Using Handset Carry Clip	17	Ringer Setting	34
Wall Mounting	18	Last Number Redial	36
Turning Handset On/Off	19	Call List	39
Key Lock	20	Selecting a Language	43
Bluetooth	21	Paging	44
Pairing with your Cellphone	21	Flash Signal	44
		One-touch Memories	45

Contents

Handset Operations	47	Date and Time	76
Menu Navigation	47	Set Talk	77
Menu Map	48	TAM Setup	79
Phone Book	49		
Base Settings	53	Caller ID on Call waiting	86
Handset Settings	54		
Registration	59	Feature List	87
Default	60		
TAM Functions	61	Troubleshooting	90
Base Operations	68	Answering System Solutions	91
Menu Navigation	68		
Menu Map	69	Technical Specifications	92
Phone Book	70		
Display Settings	73		
Phone Settings	75		



If you subscribe to a DSL service

Please attach a noise filter (contact your DSL provider) to the telephone line between the base unit and the telephone line jack in the event of the following:

- Noise is heard during conversations.
- Caller ID features do not function properly.

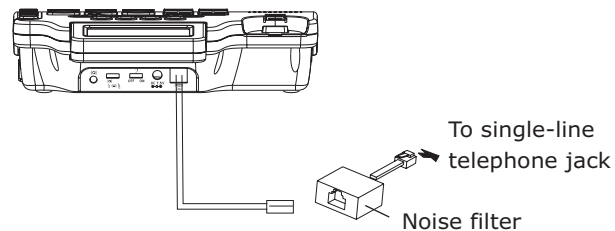

Technical Specifications

Frequency Range	1.92~1.93GHz
Channels	60 Duplex channels
Carrier Power	<100mW
Modulation	GFSK
Frequency Stability	< \pm 50 KHz
Charging time	15 hours
Ambient temperature	Normal: 15°C ~ 35°C, Extreme: 0°C ~ 40°C
Humidity	0%~90%
Dimensions (mm)	Base: 243 x 241.5 x 94; Handset: 187 x 60 x 39
Power Supply	Base input: 7.5V, 1000mA; Handset input: Ni-MH 1.2V x 3, 800mAh

 **Design and specifications are subject to change without notice.**

Prior To Use

Congratulations

on purchasing our high quality product. Please read the manual carefully to find out all features and how your telephone works, so you can get the best out of your new phone.

Safety Precautions

To reduce the risk of electrical shock and injury, please follow these basic safety precautions before using the phone.

1. Carefully read and observe the instructions in this manual.
2. Follow all warnings marked on the unit.
3. When cleaning, unplug the phone first, then use a damp cloth to wipe. Do not use liquid or aerosol cleaners.
4. Do not place objects on the line cord that may cause damage.
5. Do not use this phone in wet surroundings or environments where there is a risk of explosion.
6. Avoid spilling of any liquid on the phone.

7. Unplug this phone from the wall outlet and refer servicing to qualified service personnel only.
8. Pay attention to the polarity of the batteries, insert the rechargeable batteries in accordance with polarity symbols (this instruction is found in the installing batteries section.)
9. Use only **the batteries indicated in the User's Manual**. Never use other ordinary batteries or conventional alkaline batteries. Otherwise this may not only cause personal injuries but also damage to the unit.
10. Do not mix exhausted batteries with full batteries. Exhausted batteries shall not be disposed of with the usual household waste or in a fire.
11. If the handset will not be used for a long period of time, remove the batteries to prevent possible leakage.
12. Use only **the power supply indicated in the User's Manual**.
13. Keep the phone out of the reach of children.
14. Use the phone only in the described manner.
15. Stop using the phone if it becomes damaged.

Answering System Solutions

Cannot hear messages, beep, etc.

- **Adjust announce volume.**
-

The system always plays Announce2.

- **Answering system memory may be full. Erase some messages.**
-

Incoming messages are incomplete.

- **Answering system memory is full. Erase some messages.**

Troubleshooting

Symptom	Check & Remedy
No operation	<ul style="list-style-type: none"> • Check that the power adapter is properly connected. • Check that the telephone line cord is properly connected. • Check that the handset batteries in full power. • Check that the handset batteries are installed properly.
No dial tone	<ul style="list-style-type: none"> • Check that the telephone line cord is properly connected. • Check that the power adapter is properly connected.
Nothing appears on the display	<ul style="list-style-type: none"> • Check that the handset batteries are installed properly. • Check that the handset batteries in full power. • Check that the handset is on.
Handset seems to have very short battery life	<ul style="list-style-type: none"> • Check the charge contacts. • Consistently short battery life may indicate that replacement of the batteries is necessary. • Make sure the right batteries be used.
Caller's number is not displayed	<ul style="list-style-type: none"> • Make sure you have subscribed to a Caller ID service via your network provider. • The caller may have withheld their details. • Let the phone ring a couple of times as there may be a delay in receiving the Caller ID information.

■ Unpacking

Once you have unpacked your phone, make sure that all the parts shown below are available. If any pieces are missing or broken, please promptly call your dealer.



Base



2 Handsets



Charger



User's manual



10 AAA Ni-MH batteries



2 Adapters*



Line cord*



2 Carrying clips

*The shape of the plugs can vary according to each country's specification.

Phone Layout and Keys Function

Handset

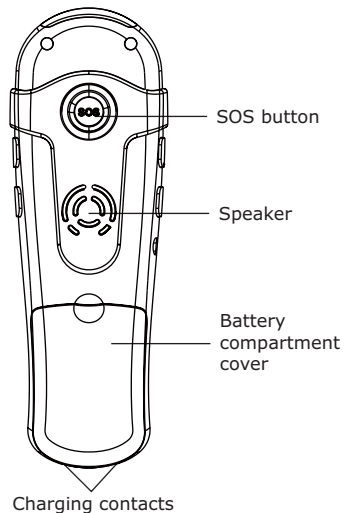
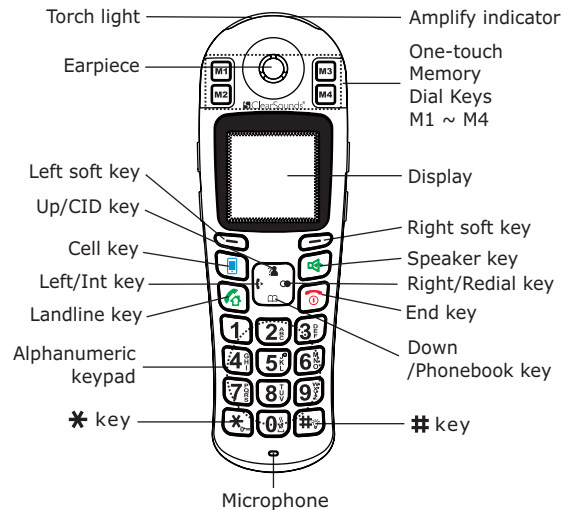

Feature List (continued)

TAM Functions

- Digital Answering System
- Memo recording
- Maximum 15 Minutes of Recording Time which includes Incoming Messages
- Ring delay selectable
- Digital Volume Control
- Toll Saver Function
- ICM slow play
- Multiple Languages
- Remote control
- Answer on/off selection

Feature List (continued)

Base Phone:

- Large LCD display (128 x 64 dots matrix display)
- Bluetooth connection
- Receives and makes landline and cellphone calls
- Call switch between DECT phone and your cellphone
- Up to 5 handsets for optional for one base
- Up to 4 bases for optional for one handset
- LCD contrast adjustable
- Phonebook with up to 30 entries
- Amplification **up to +40dB**
- Adjustable volume control
- Adjustable extra-loud ringer
- Big Keypad buttons
- **2.5mm** amplified Headset jack
- **3.5mm** Bed Shaker jack
- Redial book with up to 10 entries
- Multiple melody ringer and volume selectable

- Wall mounting function
- 8 photo memory speed dial buttons
- Full handsfree speakerphone
- Redial, Flash, Mute, Hold
- Visual ringer
- Real time clock (set time)
- Backlit LCD screen and keypad

Caller ID

- FSK and DTMF dual system Caller ID
- Caller ID / Call Waiting
- Caller ID list with up to 20 entries
- Incoming calls can be called back/added to phonebook/deleted
- **Message indicator**

Phone Layout and Keys Function (continued)

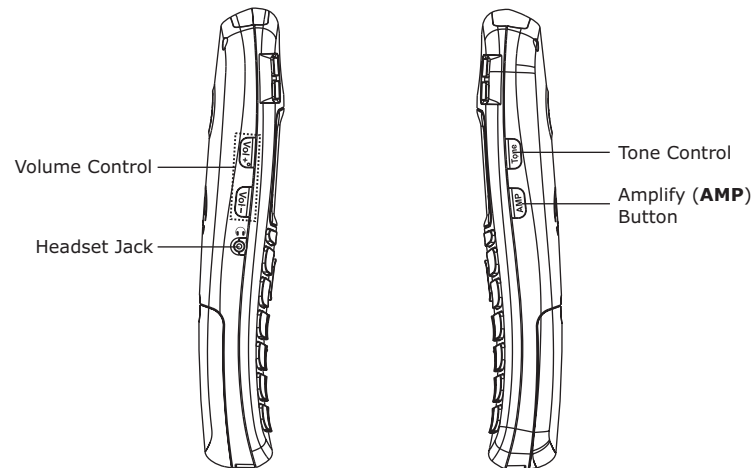

Phone Layout and Keys Function (continued)

Base

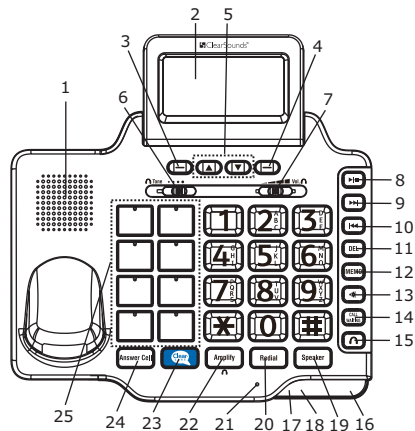

- | | |
|--------------------------------|--|
| 1. Speaker | 13. Page Key |
| 2. Large LCD Screen | 14. Call waiting Key |
| 3. Left Soft Key | 15. Headset Key |
| 4. Right Soft Key | 16. Message waiting LED |
| 5. Up/Down Scroll | 17. In use LED |
| 6. Tone reception Adjustment | 18. Bluetooth LED |
| 7. Volume reception Adjustment | 19. Speaker Key |
| 8. Play/Stop Key | 20. Redial/Pause Key |
| 9. Next Key | 21. Microphone |
| 10. Previous Key | 22. Additional amplifier key/indicator |
| 11. DEL Key | 23. Speed dial Key |
| 12. MEMO Key | 24. Answer cell Key |
| | 25. Photo Memory Dial Keys |

Feature List

Cordless Handset:

- 1.9G DECT technology
- Large 2.0" LCD (128 x 64 dots matrix display)
- **Bluetooth setting**
- Receives and makes landline and cellphone calls
- Call switch between DECT phone and your cellphone
- Up to 5 handsets for optional for one base
- Up to 4 bases for optional for one handset
- LCD contrast adjustable
- Phonebook with up to 50 entries
- Amplification up to +40dB
- Amplified Headset jack
- HAC compatible
- 9 VIP ring tones setting for phonebook entries
- Redial book with up to 10 entries
- 10 melody ringer and volume selectable
- Vibrating loud ring signaler
- 4 one-touch memory speed dial buttons
- **1 SOS button**
- Full handsfree speakerphone
- Receiver/Speaker volume adjustable
- Predialing
- Redial, Flash, Pause, Mute
- Real time clock (set time)
- Call duration display
- Keypad lock
- Multiple languages selectable
- Auto answer ON/OFF selectable
- Alarm clock include snooze option
- Handset Name setting
- Backlit LCD screen and keypad

Caller ID

- FSK and DTMF dual system Caller ID
- Caller ID / Call Waiting
- Caller ID list with up to 20 entries
- Incoming calls can be called back/added to phonebook/deleted
- New call indicator
- Message waiting

Caller ID on Call waiting

When you subscribe to Call Waiting service from your local telephone company, the telephone will display the name and number of the second caller while you are having a conversation.

Caller ID info displayed

Caller 1
4361234

Caller two's information is displayed

Caller 1
4
Caller 2
2915678

1. When you are on the line, the telephone will automatically display the name and number of the second caller.
2. Press the **Flash** soft key (**CALL WAITING** key on the base) to answer the second caller.
3. When you have finished, press the **Flash** soft key (**CALL WAITING** key on the base) to continue with your conversation with the first caller.

Note:

- If you have transferred an external call to another handset, you cannot use the call waiting function via the second handset.

Phone Layout and Keys Function (continued)

1. Optional Bed Shaker jack
2. Shaker/Strobe Ringer select
3. Amplification Reset Override switch (ON/OFF)
4. Power jack
5. Phone line cord jack
6. Audio neckloop jack (3.5mm)
7. Headset jack (2.5mm)
8. New call indicator switch
9. Volume controls

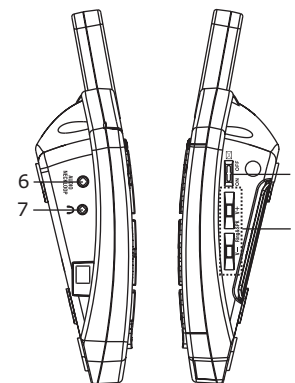
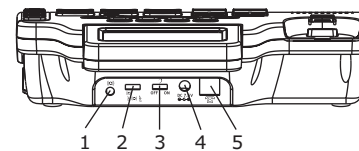

Charging cradle (for DECT)

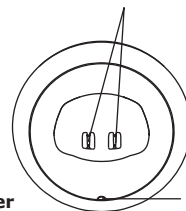

Charger

Charging indicator

■ Keys Description

Handset



Landline key

Make/Answer landline calls.



Cell key

Make/Answer cellphone calls.



Speaker key

Activates the speakerphone if pressed during a call, as described in page 33.



End key

End a call.

Long press to activate power on/off, as described in page 19.

Navigation key:



Up/CID key

Scroll up through lists and menu options.

Increase the earpiece/speakerphone volume during a call.

Enter the Call list, as described in page 39.



Down/Phonebook key

Scroll down through lists and menu options.

Decrease the earpiece/speakerphone volume during a call.

Enter the Phonebook, as described in page 50.

Remote Control

You can access many features of your answering machine remotely from any touch tone telephone. A four-digit security ID is required to access the system and the factory default one is *0000. To enter remote access:

1. Dial your telephone number from any touch tone telephone.
2. When the OGM starts to play, you can enter the remote access mode by inputting the security ID.
3. After you input the security ID, the system will play the menu of commands. You can then follow the voice prompt to operate.

Remote access commands

Button

Function

2

Play messages

2X **2**

Stop playing messages

0

Erase the current messages

1

Review

3

Skip

4

Switch the answering machine on/off

7

Repeat menu again

Security ID

To operate your answering machine remotely from another phone you need to enter the remote code. For security reasons you had better change this code (the default one is 0000). For more details please refer to par. **Remote Control**.

1. Press **Menu** soft key to display the main menu list.
2. Press **▲** or **▼** key repeatedly to move to **TAM setup**, press **Select** soft key.
3. Press **▲** or **▼** key to choose **Security ID**, press **Select** soft key.
4. The display shows the current security ID. Enter the new one you want to use, press **Save** soft key.

ICM Voice Slow

You can slow down the playback speed of Incoming Messages (ICM). To change this setting:

1. Press **Menu** soft key to display the main menu list.
2. Press **▲** or **▼** key repeatedly to move to **TAM setup**, press **Select** soft key.
3. Press **▲** or **▼** key to choose **ICM Voice Slow**, press **Select** soft key.
4. Press **▲** or **▼** key to choose **ON** or **OFF**, press **Select** soft key.

Keys Description (continued)



Redial key

Enter the redial book, as described in page 36. Insert a pause when pre-dialing a number.

Left/Right soft key

Perform the functions indicated by the text immediately over it (on the bottom line of the display) which changes time by time.

One-touch memories

Store up to 5 numbers for one-touch memory dialing.

*** key**

Press and hold to turn on/off keypad lock function.

key

Press and hold to turn on/off torch function.

Base



Play/Stop key

Press to start or stop the Message or Memo playing.

■ Keys Description (continued)



Up/Down key

Highlight or scroll through the menu options.
Enter the Call list, as described in page 41.



MEMO key

Press and hold this key to record a memo.



Del key

When playing an ICM (incoming message), press this key to delete the current message.
During the ICM playing press and hold this key to delete all the messages.



Back key

Press once to play the current message. Press twice to play the previous message.



Skip key

Press to play the next message.



Volume up/down key

Use them to adjust the volume of ringer, dialing talking and CID talking.





One-touch memories

Store up to 8 numbers in One-touch memory dial keys (Photo memory keys).

Record the Memo

You can use your phone to record memo messages (each can be up to 3 minutes) for another user of your phone. The memo can be played as an incoming message.

To record the memo, press and hold the  key in standby mode. The display will show **Memo** and the recording will start. Please note that the  key should be pressed and held during the whole process. Release the  key to end the recording.

Set the Ring Number



The ring number is the number of rings after the answering machine takes an incoming call and plays your OGM. You can select from rings **2, 3, 4, 5, 6** or toll saver mode. If you select **toll saver**, when there are new messages to be played, the answering machine will respond after rings 2, otherwise it will respond after rings 6.





1. Press **Menu** soft key to display the main menu list.
2. Press **▲** or **▼** key repeatedly to move to **TAM setup**, press **Select** soft key.
3. Press **▲** or **▼** key to choose **Set Ring**, press **Select** soft key.
4. Press **▲** or **▼** key to choose the answer rings (**Rings 2, 3, 4, 5, 6** or **toll saver**), press **Select** soft key.

Incoming Message (ICM)

The feature allows the caller to leave a message to the owner who is not at home. When a call is received in TAM on mode, the machine will play the OGM, and then performs message recording. The process is as follows:

After N times ringing, the phone enters answer-record mode automatically and starts to play OGM. The caller can start to record message after a tone. Each ICM can be up to 3 minutes.

To play messages via the speaker, press the  key in on-hook state. You can also play messages via the receiver by pressing the  key after lifting the handset. Notice that you should insert the telephone line cord in advance. The phone will announce "**You have N new message(s)**" or "**You have N old message(s)**". The relevant messages will be played one by one. During the process you can do the following steps:

- Press the  key to delete the current message.
- Press the  key once to re-play the current message.
- Press the  key twice to play the previous message.
- Press the  key to play the next message.
- **Press the  key to stop the playing and exit.**
- To adjust the announce volume, use the Volume Controls **V-** or **V+** on the right side of the phone. You can also press the **Amplify** key to further enhance the volume.

Keys Description (continued)



Page key

You can use this key to locate the registered handset or register a new handset.



Speaker key

Make/Answer/End a call.

Activates the speakerphone if pressed during a call, as described in page 33.



Answer Cell key

Make/Answer cellphone calls.



Clear Care key

One-touch memory dial key.



Amplify key

Press this button to turn the extra amplification ON or OFF.



Redial key

Last number redial, as described in page 37.

Insert a pause when pre-dialing a number.

LCD Description

Cordless Handset:



New Call

Indicates you have missed one or more calls.



MSG Waiting

Indicates you have one or more voice messages.



Off Hook

Indicates the line is engaged.



Hands-free

Indicates the handsfree function is enabled.



Battery Icon

Indicates battery charge level.



Keypad Lock

This icon appears when the keypad is locked.



Signal Icon

Indicates whether the current signal exists or not. If the handset is too far from the base, this icon will blink on the LCD.



Alarm Icon

This icon appears when you set an alarm to ring at a specified time.



ICM Icon

This icon appears when you have new message(s).

Restore OGM:

You can delete the recorded OGM and restore it to the default one.

1. Press **Menu** soft key.
2. Press **▲** or **▼** key repeatedly to move to **TAM setup**, press **Select** soft key.
3. Press the **▼** key to choose **Outgoing Msg**, press **Select** soft key.
4. Press **▲** or **▼** key to choose **Erase OGM**, press **Select** soft key.
5. After a confirm tone, the recorded OGM is now deleted and the original default message returns.

Note:

- *The default outgoing message cannot be deleted.*

- The display will show **Recording**.
- You can record your OGM after a tone. You can also confirm and end the recording by pressing **End** soft key.

Play OGM:

You can play the current OGM.

- Press **Menu** soft key.
- Press **▲** or **▼** key repeatedly to move to **TAM setup**, press **Select** soft key.
- Press the **▼** key to choose **Outgoing Msg**, press **Select** soft key.
- Press **Select** soft key to choose **Play OGM**.
- The current OGM will be played. During the process the display will show **Playing**. You can press **End** soft key to stop it.

Change OGM:

You can select to use the default OGM or the recorded one.

- Press **Menu** soft key.
- Press **▲** or **▼** key repeatedly to move to **TAM setup**, press **Select** soft key.
- Press the **▼** key to choose **Outgoing Msg**, press **Select** soft key.
- Press the **▲** or **▼** key to choose **Change OGM**, press **Select** soft key.
- Press **▲** or **▼** key to choose **Default OGM** or **Recorded OGM**, press **Select** soft key.

LCD Description (continued)

Base Phone:

In standby mode, the large LCD display will show as below:

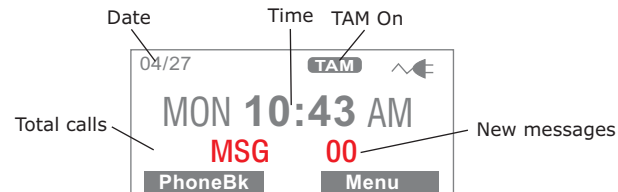

If you forget to connect the phone line cord, "No line" will show on the screen.



When a new call comes in, the screen will display the caller's phone number and/or name.



Shows the total number of new messages. In the example, there are 2 new messages and the display will show **MSG 02**.



If the caller has exercised the option to prevent his name and number from being sent, "**Private**" will show on the display.

This message will display when someone calls from another country, an area where the telephone company is not offering the caller identification services or is not yet providing number delivery to your area.



■ Connecting Lines

1. Connect one end of the phone line cord to the phone line jack of the base phone, and the other end to a standard phone wall outlet.
2. Connect the modular end of the AC power adapters to the power jack of the base phone and the charger, then plug the other end into standard AC wall outlet.

You can also install four rechargeable Ni-MH batteries (AAA size, 1.2V, 800mAh) for base LCD display.

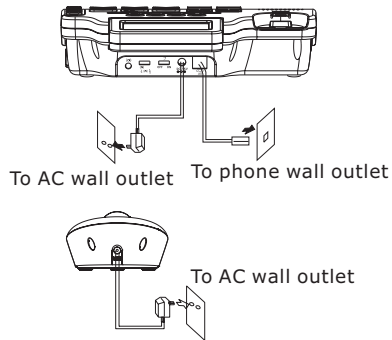

■ TAM Setup

TAM ON/OFF

You can switch the answering machine on or off.

1. Press **Menu** soft key to display the main menu list.
2. Press **▲** or **▼** key repeatedly to move to **TAM setup**, press **Select** soft key.
3. Press **Select** soft key to choose **TAM ON/OFF**.
4. Press **▲** or **▼** key to choose **ON** or **OFF**, press **Select** soft key.

Outgoing Message (OGM)

It is necessary to record the outgoing message which requests the caller to leave a message when nobody is at home. The OGM can be up to 1 minutes.

Record OGM:

The default OGM is "**Please leave your message after the tone**". If you want to change the OGM, do the following steps:

1. Press **Menu** soft key to display the main menu list.
2. Press **▲** or **▼** key repeatedly to move to **TAM setup**, press **Select** soft key.
3. Press the **▼** key to choose **Outgoing Msg**, press **Select** soft key.
4. Press the **▼** key to choose **Record OGM**, press **Select** soft key.

Review Talking

The system can announce the number that stored in phone book when you are reviewing the phone book, so the feature allows you to check these numbers when you use ▲ or ▼ key to scroll through the phone book entries. Note that if you have recorded the corresponding name, the system will announce the name associates with this number. To activate this feature, do the following steps:

1. Press **Menu** soft key.
2. Press ▲ or ▼ key repeatedly to move to **Set Talk**, press **Select** soft key.
3. Press ▲ or ▼ key repeatedly to move to **REVIEW TALKING**, press **Select** soft key.
4. Use ▲ or ▼ key to select **ON/OFF** to activate /deactivate the CID talking function, press **Select** soft key to confirm.

Note:

- You can use **V-** and **V+** button to adjust the talking volume, and in the same time, the memo announcement volume will be adjusted accordingly.

Voice Prompt

You are able to select the language used to play the voice prompt messages.

1. Press **Menu** soft key.
2. Press ▲ or ▼ key repeatedly to move to **Set Talk**, press **Select** soft key.
3. Press ▲ or ▼ key repeatedly to move to **Voice Prompt**, press **Select** soft key.
4. Use ▲ or ▼ key to scroll through the options. Each language will be displayed in its own native translation.
5. Press the **Select** soft key to choose the required language.

Installing Batteries

The three rechargeable Ni-MH batteries (AAA size, 1.2V, 800mAh) come with the handset. Install the batteries before use. The batteries need to be replaced if they do not recover their full storage capacities after recharging.

1. Slide the battery cover in the direction of the arrow and pull it out.
2. Insert new batteries as indicated, matching correct polarity (+,-).
3. To replace the battery cover, slide the cover up until it snaps in place.

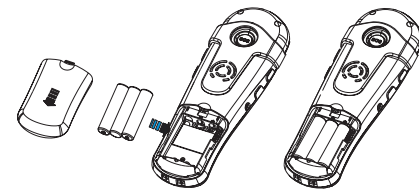

Notes:

- Reversing the orientation may damage the handset.
- When replacing the batteries, always use good quality Ni-MH AAA re-chargeable batteries. Never use other battery.



■ Charging Handset

! Important Note: Before initial operation, **YOU SHOULD FULLY CHARGE THE HANDSET** for about **15 hours**.

To charge the handset, place it on the base or charger.

Result: When you place the handset on the base or charger, the handset automatically turns on.

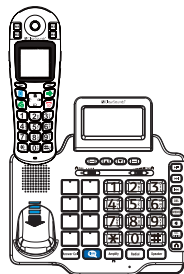

■ Using Headset (optional)

The headset jack is located in the left side of the handset and is 2.5mm standard plug. Simply plug the headset into this jack and the headset will be activated.

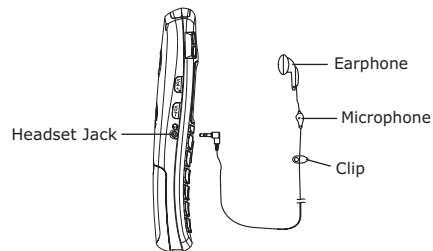

Note:

- When the headset is plugged into the headset jack the microphone on the handset will be deactivated.

■ Set Talk

Dialing Talking

This feature allows you to check the number you have entered in standby mode without looking at the display.

1. Press **Menu** soft key.
2. Press **▲** or **▼** key repeatedly to move to **Set Talk**, press **Select** soft key.
3. Press **Select** soft key to access **DIALING TALKING**.
4. Use **▲** or **▼** key to select **ON/OFF** to activate /deactivate the dialing talking function, press **Select** soft key to confirm.

CID Talking

The talking CID can announce the number that comes in unless the caller blocks the number, so this feature allows you to check the caller ID number or caller's name when a new call is receiving without looking at the display. Note that if you have stored a number in phone book and recorded the corresponding name, when an incoming call with this number comes in, the system will announce the name associates with this number.

1. Press **Menu** soft key.
2. Press **▲** or **▼** key repeatedly to move to **Set Talk**, press **Select** soft key.
3. Press the **▼** key to move to **CID TALKING**, press **Select** soft key.
4. Use **▲** or **▼** key to select **ON/OFF** to activate /deactivate the CID talking function, press **Select** soft key to confirm.

■ Date and Time

In standby mode, the phone displays the current date and time to help you keep track of your appointments. You need to set the date and time so that when you receive calls they will appear with the correct date and time.

1. Press **Menu** soft key.
2. Press ▲ or ▼ key repeatedly to move to **Set Time/Date**, press **Select** soft key. The current settings are displayed.
3. Enter the current time using the numeric keypad and use the * or # key to select **AM/PM** and then press the **Save** soft key.
4. Enter the current date using the numeric keypad, press **Save** soft key.
5. Use the same method to enter the current year, press **Save** soft key.

Notes:

- You can select the hour format. Please refer to par. **Hour Format Setting**.
- If you select **12 hour clock**, **AM/PM** will appear at the right of the time in standby mode.

■ Using Handset Carrying Clip

The supplied handset carrying clip allows you to conveniently carry the handset with you. It clips easily to your belt, waist band, or shirt pocket.

If you want to remove the carrying clip:

Insert a screw driver along the edge of one of its arms and release the clip. Then lift it off.

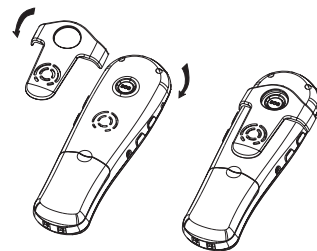

■ Wall Mounting

1. Slide the handset hanger tab out and reverse its position (rotate it 180 degrees). Slide it back into place so that the hook points up (see diagram 1). This will keep the handset from falling out of the cradle when it is mounted on the wall.
2. Install two self-tapping screws (not supplied) at a distance of 167.5 mm from each other and located on a horizontal line.
3. Place the phone onto the screw-heads and slide down to secure (see diagram 2).

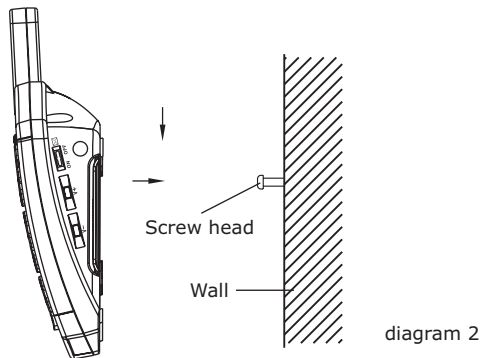
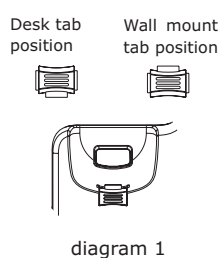

■ Phone Settings

Keypad Tones

Every time you press a key, your handset acknowledges it with a key tone. You can disable the key tones for a silent use. In certain error conditions, a warning tone will sound when an incorrect key is pressed.

1. Press the **Menu** soft key.
2. Press the **▼** key to move to **Set Phone** and then press **Select** soft key.
3. Press **Select** soft key to access **Set Ring**.
4. Press the **▲** or **▼** key to choose **Keypad Tones**, then press **Select** soft key.
5. You can use **▲** or **▼** key to choose **ON** or **OFF** to enable or disable the function.
6. Press the **Select** soft key.

Note:

- For normal use, we recommend you leave the key tone enabled. This makes the phone easier to use.

Hour Format Setting

1. Press **Menu** soft key.
2. Press **Select** soft key to access **Set Display**.
3. Press ▲ or ▼ key repeatedly to move to **Hour Format**, press **Select** soft key.
4. Press ▲ or ▼ key repeatedly to choose **12 hour clock** or **24 hour clock** and then press **Select** soft key.

Note:

- If you select **12 hour clock**, AM/PM will appear on the right of the time in standby mode.

Turning Handset On/Off

If the handset is in power off mode, when you place the handset on the base, it automatically turns on. To turn the handset on or off in standby mode, follow these steps:

1. To turn on the handset when it's off, press and hold the  key until you switch the display on. On power up, the handset will enter subscription mode and search for a registered base. A message as shown below will be displayed to the user, and the signal icon will flash.

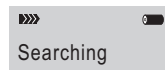

2. To turn off the handset, keep the  key pressed until the display disappears.



If the handset is successful in finding a base, the handset will enter the standby mode, the display will show handset number and the handset name (if you have one saved as described on page 56), signal icon, battery icon and current time. If the handset is unsuccessful in finding a base, the handset will behave according to the Out of Range condition.



Note:



- Nothing will appear on the LCD when battery power is very low. **YOU SHOULD FULLY CHARGE THE HANDSET BEFORE USING.**

■ Key Lock

Cordless Handset only:

If you turn on this feature, all keys will be locked. You can answer calls by using the  or  key. But when you hang up, the phone returns to the locked mode. This feature is useful to avoid pressing keys by mistake.

To lock the keys, in the standby mode just keep the  key pressed till the display shows the  icon.

To unlock the keys, keep the  key pressed again till the key lock icon  disappears from the display.

Note:

- In locked mode, if you press any key, the phone will generate a warning tone.

■ Display Settings

LCD Contrast Setting

The adjustment allows you to optimize the visibility of the display by changing its contrast according to the environment conditions.

1. Press **Menu** soft key to display the main menu list.
2. Press **Select** soft key to access **Set Display**.
3. Press the **▼** key to move to **Set Contrast**, press **Select** soft key.
4. Press **▲** or **▼** key repeatedly to choose among the 8 available contrast levels (1~8) and then press **Select** soft key.

Switch to smaller font

If you select **ON**, when you pre-dial a number and the number exceeds 8 digits, the font will be switched to a smaller size automatically.

1. Press **Menu** soft key.
2. Press **Select** soft key to access **Set Display**.
3. Press **▲** or **▼** key repeatedly to move to **Dim:X--->x**, press **Select** soft key.
4. Press **▲** or **▼** key repeatedly to choose **ON** or **OFF** and then press **Select** soft key.

Play Voice: allows you to play the voice prompt of this entry. If you have recorded the name for this entry, the system will announce the name, otherwise it can only announce the number.

Record Voice: allows you to record the name for the selected entry.

Erase Voice: allows you to delete the name you have recorded for the selected entry.

Edit: allows you to edit the selected entry.

Erase: allows you to delete the selected entry.

Note:



- If you record a voice prompt for an entry, an icon  will appear with the entry.

Bluetooth

All descriptions in this part take iPhone for instance. Check your cellphone's manual if you are using other cellphone.

■ Pairing with your Cellphone

Using the Handset:

1. Turn on the Bluetooth feature of the cellphone, then it searches for available devices.
2. Press the **Menu** soft key.
3. Press  or  key to choose **Bluetooth** menu, then press the **Select** soft key.
4. Press the **Select** soft key to choose **Add Device**. The LCD shows **Please wait**, and the Bluetooth LED flashes.
5. When the iPhone finds **A1600BT**, click **Not Paired** to connect it with the base. When the iPhone is successfully connected, **Connected** appears.

Using the Base Phone:





1. Turn on the Bluetooth feature of the iPhone, then it searches for available devices.
2. Press **Menu** soft key.
3. Press **▲** or **▼** key repeatedly to move to **Bluetooth**, press **Select** soft key.
4. Press the **Select** soft key to choose **Add device**. The LCD shows **Please wait..**, and the Bluetooth LED flashes.
5. When the iPhone finds **A1600BT**, click **Not Paired** to connect it with the base. When the iPhone is successfully connected, **Connected** appears.

■ Connecting your Cellphone

Using the iPhone:

1. Turn on the Bluetooth feature of the iPhone, then it searches for available devices.
2. Click **Not Connected** to the right of **A1600BT** to connect the iPhone to the DECT phone. When the connection is successful, **Connected** appears.

Using the Handset:

1. Press the **Menu** soft key.
2. Press  or  key to choose **Bluetooth** menu, then press the **Select** soft key.
3. Press the  key to choose **Device List**, press the **Select** soft key.
4. The display shows all devices that have been paired before. Press  or  key to choose the desired one, press the **Select** soft key.
5. Press **Select** soft key to choose **Connect**. When the connection is successful, the Bluetooth LED on the base lights on.

Using the Base Phone:

1. Press **Menu** soft key.
2. Press **▲** or **▼** key repeatedly to move to **Bluetooth**, press **Select** soft key.
3. Press the **▼** key to choose **Device list**, press the **Select** soft key.
4. The display shows all devices that have been paired before. Press **▲** or **▼** key to choose the desired one, press the **Select** soft key.
5. Press **Select** soft key to choose **Connect**. When the connection is successful, the Bluetooth indicator on the base lights on.

Quick Connection:

1. When no device is connected with the DECT phone, press  key on the handset.

Adding the Phonebook Entries

1. Enter a phone number (up to 24 digits) while in standby mode and then press **Save** soft key.
2. The display shows "**Number:**". Edit the number if necessary, then press **Save** soft key to confirm.
3. The display shows "**Name:**". Enter the name you want to use, then press **Save** soft key to confirm.
4. Press **▲** or **▼** key to select the ring you like to associate with the number, press the **Select** soft key.

Note:

- If you make a mistake while entering a number, use the **Clear** soft key to correct it. Each time you press the key, the last digit is deleted.

Viewing the Phonebook Entries

1. Press the **PhoneBk** soft key in standby mode to enter the phonebook.
2. Press **▲** or **▼** key repeatedly until the desired entry is displayed.
3. Press **Speaker** to dial out this number.

Note:

- If you have activated the Review Talking feature in advance, every time you press **▲** or **▼** key, the system will announce the number or name of the highlighted entry.

Using the Phonebook Options

1. Press the **PhoneBk** soft key in standby mode to enter the phonebook.
2. Press **▲** or **▼** key repeatedly until the desired entry is highlighted, press **Options** soft key to choose the desired option:



Phone Book

The phonebook built in your base phone allows you to store frequently used numbers so that you can easily make a call without having to remember or enter the phone number.

Character Map

To enter a specific alphanumeric character, press one or more times the relevant key for the required character according to the following table: once for the first character, twice for the second and so on.

Key	Characters in the displayed order
0	0
1	(spc) _ * , 1
2	Aa Bb Cc (2
3	Dd Ee Ff) 3
4	Gg Hh Ii # 4
5	Jj Kk Ll / 5
6	Mm Nn Oo ' 6
7	Pp Qq Rr Ss 7
8	Tt Uu Vv ? 8
9	Ww Xx Yy Zz 9

- The display shows all devices that have been paired before. Press  or  key to choose the desired device, press **Select** key to complete the connection.

Notes:

- If you switch off the Bluetooth function on the cellphone then switch on, you must connect it again.*
- To ensure your calling quality, you are recommended to use the cellphone within a distance of 3 meters with the base.*





Reminder

Some of Instant Messenger, such as Viber, Skype, Fring, Im+, Nettek..... may not well support Bluetooth protocol, please check with relevant providers and update the software to use A1600BT properly.

Thanks!

■ Disconnecting your Cellphone

Using the Handset:

1. Press the **Menu** soft key.
2. Press  or  key to choose **Bluetooth** menu, then press the **Select** soft key.
3. Press the  key to choose **Device List**, press the **Select** soft key.
4. The display shows all devices that have been paired before. Press  or  key to choose the desired one, press the **Select** soft key.
5. Press **Select** soft key to choose **Disconnect**. Then a prompt tone occurs and the Bluetooth LED goes out.

Using the Base Phone:

1. Press the **Menu** soft key.
2. Press **▲** or **▼** key to choose **Bluetooth** menu, then press the **Select** soft key.
3. Press the **▼** key to choose **Device list**, press the **Select** soft key.
4. The display shows all devices that have been paired before. Press **▲** or **▼** key to choose the desired one, press the **Select** soft key.
5. Press **Select** soft key to choose **Disconnect**. Then a prompt tone occurs and the Bluetooth LED goes out.

■ Menu Map

Base Phone:

1. Set Display

Set Language (*see page 43*)
Set Contrast (*see page 73*)
Dim: X--->x (*see page 73*)
Hour Format (*see page 74*)

2. Set Phone

Set Ring (*see page 35, 75*)

3. Set Time/Date (*see page 76*)

4. Set Talk

DIALING TALKING (*see page 77*)
CID TALKING (*see page 77*)
REVIEW TALKING (*see page 78*)
Voice Prompt (*see page 78*)

5. TAM setup

TAM ON/OFF (*see page 79*)
Outgoing Msg (*see page 79*)
Set Ring (*see page 83*)
Security ID (*see page 84*)
ICM Voice Slow (*see page 84*)

6. Bluetooth

Add device (*see page 21*)
Device list (*see page 22*)

Base Operations

Menu Navigation

To access a menu option:

1. To display menu items, press the **Menu** soft key.
2. To scroll through menu options, press the **▲** or **▼** key repeatedly.
3. To select a menu, press the **Select** soft key when the desired menu appears on the LCD.
4. Repeat if necessary.

To return to previous screen from menu:

If you press the **Back** soft key or the **Exit** soft key, the base phone returns to the previous screen.







To access the Phonebook:

1. Press the **PhoneBk** soft key in standby mode.
2. To scroll through phonebook entries, press the **▲** or **▼** key repeatedly.
3. Press the **Options** soft key to display the sub-menus.
4. Press the **▲** or **▼** key repeatedly to choose a desired one, press the **Select** soft key to confirm.



Removing a Paired Cellphone

Using the Handset:

1. Press the **Menu** soft key.
2. Press  or  key to choose **Bluetooth** menu, then press the **Select** soft key.
3. Press the  key to choose **Device List**, press the **Select** soft key.
4. The display shows all devices that have been paired before. Press  or  key to choose the one you want to remove, press the **Select** soft key.
5. Press the  key to choose **Remove**, then press the **Select** key to delete the cellphone.

In your cellphone, delete the Bluetooth information. For more details, check your cellphone's manual.

Using the Base Phone:

1. Press the **Menu** soft key.
2. Press **▲** or **▼** key to choose **Bluetooth** menu, then press the **Select** soft key.
3. Press the **▼** key to choose **Device list**, press the **Select** soft key.
4. The display shows all devices that have been paired before. Press **▲** or **▼** key to choose the one you want to remove, press the **Select** soft key.
5. Press the **▼** key to choose **Remove**, then press the **Select** key to delete the cellphone.

In your cellphone, delete the Bluetooth information. For more details, check your cellphone's manual.

Basic Functions

All descriptions in this manual assume that the telephone is in standby mode. Set the cordless handset to standby mode by pressing the  key and set the base phone to standby mode by pressing the Right soft key repeatedly.

Making a Call

Cordless Handset:

1. Pick up the handset and press the  key.

Base Phone:

1. Press the **Speaker** key.

Result: The **In use** indicator flashes and the  icon appears on the base LCD.

2. Dial a telephone number.

Cordless Handset:

3. To end the call, either press the  key or replace the handset on the base.



Base Phone:

3. To end the call, press the **Speaker** key.

You can enter the desired phone number in standby mode, which allows you to make corrections before dialing. Follow these steps:

1. Enter a telephone number (up to 32 digits). Check it. You can also use the **Erase** soft key (**Clear** soft key on the base) to delete the last digit or  key to insert a pause if necessary.

Cordless Handset:

2. When the number appears correctly, press  to dial it out through a landline or press  to dial through your cellphone.

Base Phone:

2. When the number appears correctly, press **Speaker** key to dial it out through a landline or press **Answer Cell** key to dial through your cellphone.

Remote Control





You can access many features of your answering machine remotely from any touch tone telephone. A four-digit security code (remote code) is required to access the system and the factory default one is 0000. To enter remote access:





1. Dial your telephone number from any touch tone telephone.
2. When the Announce1/Announce2 starts to play, you may enter the remote access mode by inputting the remote code.
3. After you enter the remote code, the system will play the menu of commands. You can then follow the commands to operate.



Note:

- If you enter the remote code incorrectly the answering machine will generate a warning tone. You are then given two more attempts to enter the correct remote code before the line is disconnected.

Remote access commands

Button	Function
	Play the main menu
	Play the new messages
	Play the saved messages
	Delete all the messages
	Switch the answering machine on/off

When you press  or  key to play back the messages, press  to replay current message, press  to stop, press  to delete current message.







After you record the Announce1/Announce2, press the  key or the  key to finish. The system will play the announcement you have recorded.

Note:

- You had better stop playing message before hanging up.





Record Time

You are able to select the record time. If you select **Unlimited**, the messages can be recorded until the memory is full.

1. Press the **TAM** soft key in standby mode.
2. Press  or  key repeatedly to choose **TAM Setting**, use the **Select** key to confirm.
3. Press  or  key repeatedly to choose **Record Time**, press the **Select** key.
4. Use  or  key to select between **60S**, **120S**, **180S** and **Unlimited**.
5. Press the **Select** key to confirm.



Remote Code

To operate your answering machine remotely from another phone you need to enter the remote code. For security reasons you had better change this code (the default one is 0000). For more details please refer to par. **Remote Control**.

1. Press the **TAM** soft key in standby mode.
2. Press  or  key repeatedly to choose **TAM Setting**, use the **Select** key to confirm.
3. Press  or  key repeatedly to choose the **Change PIN**, press the **Select** key.
4. Enter the current remote code, press the **OK** key.
5. Enter the new code you want to set, press the **OK** key. Enter the new code again to confirm, press the **OK** key.

Call Switching

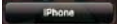
During a call, you can switch between your DECT phone and your cellphone. Take iPhone for instance:

1. During a cell line call using the DECT phone, click  on the iPhone display, then click . The call switches to the iPhone.
2. To switch back, click  on the iPhone. The call switches back to the DECT phone.

Notes:



- The DECT phone must be first paired and connected to the cellphone via Bluetooth. For more details please refer to Bluetooth section.
- Check the manual of your cellphone if you are using other cellphone.

■ Receiving a Call

Cordless Handset:







When a call is received, the **New Call** information will appear on the LCD. **When a cell call comes in, C appears.**

If the caller can be identified, the caller's phone number is displayed. If the caller cannot be identified, only the **New Call** information displays. If you have a voice message, the **"MSG WTG ON"** and  icon will be shown on the LCD.

1. Press  to answer a landline call or press  to answer a cell line call when your cellphone is charging. If you have activated the Auto Answer function, when the handset is on the base, simply lift it up to answer.
2. To end the call, either press the  key or replace the handset on the base.

Result: After you hang up, the LCD displays the call duration.







Notes:

- You can select the ringer volume by using the  or  key when the phone rings with an incoming call.
- If you want to deactivate the  icon, press the  key in standby mode, then press and hold the  key. After that, press the  key to return to standby mode. (The handset must be registered to the base.)
- If the polyphonic ring tone (Melody 6~10) is set, the ring tone may continue for 4 seconds after the caller's hang-up or after the parallel phone had answered the call.

TAM Settings







Voice Prompt Language

You are able to select the language used to play the voice prompt messages.

1. Press the **TAM** soft key in standby mode.
2. Press  or  key repeatedly to choose **TAM Setting**, use the **Select** key to confirm.
3. Press  or  key repeatedly to choose **TAM Language**, press the **Select** key.
4. The languages will be displayed. Use  or  key to scroll through the options. Each language will be displayed in its own native translation.
5. Press the **Select** key to choose the required language and you will hear a confirm beep.



Set the ring delay

You can select from 2 to 8 rings. In addition, the Toll Saver setting is also available for pre-remote access free of charge. The toll-saving pre-remote access feature can be used to check whether new messages have been received on your answering machine from a distant telephone. If a new message has been recorded on your answering machine, your call is taken after 2 rings at the latest. If no new messages has been recorded on your answering machine, your call is taken after 6 rings. End the call before the 6th ring. This means that no charges ensue.

1. Press the **TAM** soft key in standby mode.
2. Press  or  key repeatedly to choose **TAM Setting**, use the **Select** key to confirm.
3. Press  or  key repeatedly to choose **Set Ring**, press the **Select** key.
4. Use  or  key to choose the answer rings (**2 Rings~6 Rings** or **Toll Saver**), press the **Select** key.





Record the memo

You can use your the handset to record memo messages (each can be up to 3 minutes) for another user of your phone. The memo can be played back as a message.

1. Press the **TAM** soft key in standby mode.
2. Press the **Select** soft key to choose **Message**.
3. Press  or  key repeatedly to choose **Memo**, press the **Select** key.
4. You can then record a memo. Recording will stop automatically after 3 minutes. You can also confirm and end the recording by pressing the **OK** soft key. During recording the LCD shows "**Recording**".

TAM On/Off

You are able to switch the answering machine on or off.

1. Press the **TAM** soft key in standby mode.
2. Press  or  key repeatedly to choose **TAM Setting**, press the **Select** key.
3. Press **Select** key to choose **TAM On/Off**.
4. Use  or  key to choose **On** or **Off**, press the **Select** key.

■ Receiving a Call (continued)



Base Phone:

When a new call is received the base phone will ring and the Visual ring indicator will flash. If the caller can be identified, the caller's phone number is displayed. If you have a voice message, **New voice mail** will be show on the base LCD.

1. Press **Speaker** to answer a landline call or press **Answer Cell** to answer a cell line call when your cellphone is charging.
2. Adjust your volume & tone settings if needed (see page 31).
3. To end the call, press **Speaker** again.

Result: During the conversation, the base LCD displays the call duration.

Note:

- If you want to delete the New voice mail, press the  key in standby mode, then press and hold the  key.

Hold Function

During a call, you can press the **Hold** soft key to put a call on hold and the LCD will display "**Call on hold**". Hanging up the handset will not disconnect the call.

To continue the conversation, simply pick up the handset or press **Unhold**.

Muting the Microphone

During a conversation, you can temporarily switch your phone's microphone off, so that the other party cannot hear you.

Example: You want to say something to another person in the room but do not want the other party to hear you.

To mute your microphone, press the **Mute** soft key during the conversation. The "**Muted**" ("**Mute**" on the base phone) appears on the LCD.

To unmute the microphone, press the **Mute** soft key on the cordless handset (**Unmute** soft key on the base phone). You will restore the normal condition.

Amplification Function

Cordless Handset:

Your phone is equipped with a specialized amplification function designed to fit your needs. During a conversation you can adjust the **Vol+** or **Vol-** control on the left side of the handset and use the **AMP** key on the right side. You can also adjust the **Tone** control to fit the levels to your hearing requirements. The selected volume will be displayed on the LCD.

When you press the **AMP** key in receiver mode during a conversation, the red Amplify indicator on the handset lights on. If you press the **AMP** key again, the indicator will go out.

CAUTION: This telephone can produce very high (loud) sound levels. Repeated incremental exposure to amplification levels greater than 18 dB may be harmful to people without hearing loss.

Message

This feature allows the caller to leave a message to the owner who is not at home. When a call is received in answer-record mode, the machine will play announcement, and then performs message recording. The process is as follows:



After N times ringing, the phone enters answer-record mode automatically and starts to play announcement. The caller can start to record after a tone.

Play New/Old Messages

1. Press the **TAM** soft key in standby mode.
2. Press the **Select** soft key to choose **Message**.
3. Press the **Select** soft key to choose **MSG Playback**.
4. The phone will announce "**You have N new message(s)**" or "**You have N old message(s)**". The relevant messages will be played one by one. You can use the **0** key to delete the current message or the **Back** soft

key to stop the playing and exit.

Note:

- During the playing, you can use  or  key to adjust the volume.

Delete all the messages

1. Press the **TAM** soft key in standby mode.
2. Press the **Select** soft key to choose **Message**.
3. Press the  key to choose **Delete All**, use the **Select** key to confirm.
4. The LCD will show **Confirm**. Press the **OK** key to delete all the messages or press the **Back** key to cancel and exit.

Note:

- Up to 15 minutes messages can be recorded.

Play the Announcement

1. Press the **TAM** soft key in standby mode.
2. Press the  key to choose **Announce**, press the **Select** soft key.
3. Press the **Select** soft key to choose **Playback**.
4. The current announcement will be played. During the process the LCD shows **Playing OGM**, you can use the **Back** soft key to stop and exit.

Note:

- During the playing, you can use **Vol+** or **Vol-** key to adjust the volume.

Amplification Function (continued)

Base Phone:



Your phone is equipped with a specialized amplification function designed to fit your needs. During a conversation you can adjust the controls on the front panel of the phone (see diagram 3) and use the **Amplify** key. Adjust the **Vol.** control and **Tone** control to fit the levels to your hearing requirements.

When you press the **Amplify** key, the handset receiver volume adjustment is 15-30dB. The **Tone** control allows you to either boost low or high frequency range. If you press the **Amplify** key again, the receiver volume adjustment is 0-15dB. The **Tone** control cannot be used.



CAUTION: This telephone can produce very high (loud) sound levels. Repeated incremental exposure to amplification levels greater than 18 dB may be harmful to people without hearing loss. Always adjust the volume control to the minimum setting after using the phone.

Volume reset override switch

In standard mode when the  switch is set to "OFF", the phone will reset to normal sound levels when you hang up. This allows people who do not require the level of amplification offered on the phone to use it. If you would like to override the reset, simply turn the override switch  on the rear of the phone to "ON".

Important Note: When the  switch is set to "ON", you do not need to press the **Amplify** key. Your amplification setting will remain as set.

■ Using your Phone with hearing aids

Your base phone can be used with hearing aids equipped with a telecoil (T-coil). Adjust your hearing aid "T-switch" to the "T" position. Make sure to hold the handset close to your hearing aid.

■ Using Audio and Headset Jacks

Your base phone is equipped with both an Audio and Headset jack, providing total flexibility and multi-functionality. Both the two jacks are amplified, allowing you to adjust both the tone and volume.

Audio Neckloop Jack

Using this jack allows you to listen through your Neckloop while speaking into the handset or speakerphone.

Headset Jack

This jack can accommodate many hands-free headsets. Using this jack you can listen and speak through your hands-free headset.

■ TAM Functions

Announcement

It is necessary to record the announcement which requests the caller to leave a message when nobody is at home. The answer and record message can be up to 1 minutes.

Record your Announcement

Auto-answer OGM is a conventional message requesting you to leave a message. If you have not record an OGM before, the unit will play the default one "**Please leave your message after the tone**".

If you want to change Announce1, do the following steps to update it:

1. Press the **TAM** soft key in standby mode.
2. Press the  key to choose **Announce**, press the **Select** soft key.



3. Press the  key to choose the **Record MESS**, press the **Select** soft key.
4. You can then record your announcement. Recording will stop automatically after 1 minutes. You can also confirm and end the recording by pressing the **Select** soft key. During recording the LCD shows "**Recording**".

Notes:

- When recording the announcement, speak towards the microphone on the handset. To get the best recording result, you had better keep your mouth 20cm away from the microphone.

■ Default

If you reset the handset, all the features will be restored to the factory initial settings.



1. Press the **Menu** soft key.
2. Press  or  key to choose **Default**, then press the **Select** soft key.
3. Enter the PIN code (the default one is 0000), then press the **Select** soft key. If the PIN code is correct the display will show **Confirm**, otherwise the phone will return to the previous menu. Press the **Select** soft key to confirm, press the **Back** soft key to cancel and exit.



Result: After the resetting, all the settings will be restored to the factory default.

■ Handsfree

During a call, you may turn on the speakerphone built in the handset or the base. In this mode you can enjoy the comfort of the handsfree conversation.

Cordless Handset:

To turn the feature on, press the  key during a call (line engaged). The  icon appears on the LCD.

To turn the feature off, and keep on talking in normal mode, press the  key again. The  icon will disappear.

Base Phone:

To turn the feature on, just press **Speaker**. The  icon appears on the LCD.

To turn the feature off and end the call, just press **Speaker** again. The  icon disappears.





Notes:

- Before putting the cordless handset near your ears, be sure you have turned the speakerphone off.
- To adjust the speakerphone volume, see page 30.

■ Ringer Setting

Cordless Handset:

You can select your own external (from the telephone Network) or internal (from other handsets registered to the same base) ring tone and adjust the volume.

1. Press the **Menu** soft key.
2. Press  or  key to choose **HS Settings** menu, then press the **Select** soft key.
3. Press  or  key to choose **Ring Setup**, press the **Select** soft key.
4. Press the **Select** soft key to choose **INT Ring** or press the  key to choose **EXT Ring**, press the **Select** soft key.

Result: You can select the ring tone from Melody 1 to 10. When you adjust the ring tone, the phone sounds the selected melody.



5. Press the **Select** soft key to confirm.

At step 4, if you select **Volume**, and press the **Select** soft key, you can adjust the ringer volume from Volume 1 to Volume 5, or Volume Off to turn off the ringer. Press the **Select** soft key to confirm.

■ Registration

The supplied handsets are already registered with the number 1 and 2. You can register to your base additional handsets (up to 5 in total) in order to share the same line with other people.







Before registering a handset to the base, you should press and hold the  key located on the front panel of the base until a prompt tone is heard.

1. Press the **Menu** soft key.
2. Press  or  key repeatedly to choose the **Registration**, then press the **Select** soft key.
3. If the base is found, the Registration tone will sound and then the base assigns a number to the handset, otherwise a warning tone will sound, and then the handset returns to the previous registration state.

4. If the base is not found, the handset will behave according to the Out of Range condition.



Talk Keypad







This feature allows you to pre-dial the number you wish to call and you will hear the number announced as you dial as well as display the numbers on the LCD.

1. Press the **Menu** soft key.
2. Press  or  key to choose **HS Settings**, then press the **Select** soft key.
3. Press  or  key to choose the **Talk Keypad** menu, press the **Select** soft key.
4. You can use  or  key to choose **On** or **Off** to enable or disable the function.
5. Press the **Save** soft key.



Setting Date & Time

1. Date & Time Format

1. Press the **Menu** soft key.
2. Press  or  key to choose **HS Settings**, then press the **Select** soft key.

3. Press  or  key to choose **Date & Time** menu, press the **Select** soft key.
4. Use  or  key to choose **Date Format** or **Time Format**, press the **Select** soft key.
5. You can use  or  key to choose the Date Format (**DD-MM-YY/MM-DD-YY**) or the Time Format (**12 - Hour/24 - Hour**), press the **Save** soft key to save.

2. Setting date & time

1. Perform steps 1 to 3 of previous paragraph.
2. Press  or  key to choose **Set Date** or **Set Time** menu, press the **Select** soft key.
3. Enter the current date/time by numeric keypad and press the **Save** soft key to save and exit.





Notes:





- If you select **12 - Hour**, **AM/PM** will appear on the right of the time in standby mode.
- At step 3 you need to enter the time in 24-Hour format.

Ringer Setting (continued)

Base Phone:

You can select your own base ringer tone and adjust the ringer volume. You can also adjust the volume to "**Ringer OFF**" in order to turn off the ringer.

1. Press the **Menu** soft key.
2. Press  key to move to **Set Phone** and then press **Select** soft key.
3. Press **Select** soft key to choose **Set Ring**. Press **Select** soft key again to choose **Ringer volume**. You can choose among **Ringer OFF**, **volume 1~5**. Every time you press the  or  key to adjust the volume, the base plays the selected loudness.
4. Press the **Select** soft key to confirm.
5. Press  key to set the **Ringer tone**, press the **Select** soft key.

6. Press the  or  key repeatedly to select the desired ringer tone. Each time you press the  or  key to adjust the melody, the base plays the selected melody.

7. Press **Select** soft key to confirm and return to the previous menu.

In standby mode You can also adjust the ringer volume by using the Volume Controls **V-** or **V+** on the right side of the base phone. The display will show the current level. For example: **volume 1**.

WARNING: RING VOLUME IS VERY LOUD AND CAN DAMAGE YOUR HEARING. NEVER PUT YOUR EAR CLOSE TO THE RINGER.

Last Number Redial

Cordless Handset:





1. Press the  key in standby mode.

Result: The LCD displays the last number you dialed.

2. Press the  key to dial out the number.

Both your cordless handset and base phone allow you to retrieve the last 10 numbers you have dialed and recall them quickly.

Search for and dial a number in Redial Book



1. Press the  key in standby mode.
2. If you want to scroll through the memory, press  or  key repeatedly until you find out the number you want to dial.
3. Press the  key to dial out the number.

Notes:

- If no numbers are found, "Empty" is displayed.
- When the redial book is full, each time you dial a new number, the oldest number stored in the redial book is automatically erased.







Use Redial Book options

Using the redial book options, you can add a number to phone book or delete a number in the redial book.

1. Press the  key.
2. Scroll to the desired number by using the  or  key.
3. When the number appears on the display, press the **More** soft key to choose the desired option:







Auto Answer

With this feature, you can answer a call by just picking up the handset from the base without pressing any key.

1. Press the **Menu** soft key.
2. Press  or  key repeatedly to choose **HS Settings**, press the **Select** key.
3. Use  or  key to choose **Auto Answer**, then press the **Select** soft key.
4. Use the  or  key to choose **On/Off** to enable/disable the function, then press the **Select** soft key, you will hear a confirm beep.





Amplified

When the amplification feature is set to **On**, the amplify function will be on every time a call starts. You will no longer need to press the **AMP** key with every phone conversation.

1. Press the **Menu** soft key.
2. Press  or  key to choose **HS Settings**, then press the **Select** soft key.
3. Press  or  key to choose the **Amplified** menu, press the **Select** soft key.
4. You can use  or  key to choose **On** or **Off** to enable or disable the function.
5. Press the **Save** soft key.







HS Name

Using this feature, you can define a name of the handset in order to easily recognize your handset if you have more than one registered to the same base. But when you reset the handset, the handset name will be deleted.

1. Press the **Menu** soft key.
2. Press  or  key repeatedly to choose **HS Settings**, press the **Select** soft key.
3. Use  or  key to choose **HS Name**, then press the **Select** soft key.
4. You can enter the handset name (up to 12 characters) by using the alphanumeric keys (use the **Erase** soft key to delete the incorrect characters), then press the **Save** soft key to confirm and exit. The handset name will be displayed above your handset number in standby mode.

LCD Contrast Setting

The adjustment allows you to optimize the visibility of the display by changing its contrast according to the environment conditions.

1. Press the **Menu** soft key.
2. Press  or  key to choose **HS Settings**, then press the **Select** soft key.
3. Press  or  key repeatedly to choose **LCD Contrast**, then press the **Select** soft key.
4. Use  or  key repeatedly to choose among the 17 available contrast levels (0~16), then press the **Save** soft key.

- **Add to PB:** allows you to add the number to the phone book. Complete storing the entry by starting from step 4 described in par."Adding the Phone Book Entries" (obviously, you will find the number already entered in the appropriate field).
 - **Delete:** allows you to delete the selected number.
 - **Delete All:** allows you to delete the whole redial book.
4. To exit, press the **Back** soft key.

Note:

- *At step 3, when you select **Delete All** options, a message "Repeat" will further ask you to confirm the deletion. To confirm press the **Select** soft key, to cancel press the **Back** soft key.*

Base Phone:

1. Press **Speaker** key to get a dial tone.
2. Press **Redial** key. The phone will redial up to 32 digits automatically.

Dialing a Number from the Redial List

1. Press **Redial** key in standby mode.
2. Press **▲** or **▼** key repeatedly until you find out the number you want to dial.
3. Press **Speaker** key to dial out the number.

Use Redial Book options

Using the redial book options, you can add a number to phone book or delete a number in the redial book.

1. Press **Redial** key in standby mode.
2. Scroll to the desired number by using the **▲** or **▼** key.







3. When the number appears on the display, press the **Options** soft key to choose the desired option:

- **Erase:** allows you to delete the selected number.
- **Erase all:** allows you to delete the whole redial book.
- **Store:** allows you to add the number to the phone book. Enter a name you want to use with this number, then press the **Save** soft key.

4. To exit, press the **Back** soft key.

Key Tone

Every time you press a key, your handset acknowledges it with a key tone. You can disable the key tones for a silent use. In certain error conditions, a warning tone will sound when an incorrect key is pressed.







1. Press the **Menu** soft key.
2. Press  or  key to choose **HS Settings**, then press the **Select** soft key.
3. Press  or  key to choose **Tone Setup** menu, press the **Select** soft key.
4. Press the **Select** soft key again to choose **Key Tone**.
5. You can use  or  key to choose **On** or **Off** to enable or disable the function.
6. Press the **Select** soft key.

Note:

- *For normal use, we recommend you leave the key tone enabled. This makes the phone easier to use.*

Range Alarm





A beep will sound when the handset is out of range of the Base **during a call**. You are able to select to enable/disable this audible warning.



1. Press the **Menu** soft key.
2. Press  or  key repeatedly to choose **HS Settings**, press the **Select** soft key.
3. Use  or  key to choose **Tone Setup**, then press the **Select** soft key.
4. Press the  key to choose **Range Alarm**, then press the **Select** soft key.
5. Use  or  key to choose **On/Off** to enable /disable this audible warning, then press the **Select** soft key, you will hear a confirm beep.

■ Handset Settings

Setting Alarm

You are able to set the alarm on the handset and adjust the alarm settings.

1. Press the **Menu** soft key.
2. Press  or  key to choose **HS Settings**, then press the **Select** soft key.
3. Press the **Select** soft key to choose **Alarm** menu.
4. The display shows the current set. Use the  or  key to select **On/Off**, press the **Select** soft key.
5. If you select **On**, the display indicates you to enter the time in **HH:MM** format. Use the numeric keypad to enter.



6. Press the **Select** soft key, the display shows **Snooze**, press the **Select** soft key. Then you can press  or  key to choose **On** or **Off** and press the **Select** soft key.
7. When the alarm sounds, press any key to stop the alarm sound.

Notes:

- *At step 5 you need to enter the time in 24-Hour format.*
- *If you press any key at the right time the alarm to ring, the alarm will be silent.*
- *If you choose **Snooze On**, the alarm will ring at regular intervals of 11 minutes. If you press the  key when the alarm sounds, the option will be switched to **Snooze Off**.*

■ Call List





Cordless Handset:

When you receive a call, if the caller's information is transmitted from the network on which the call was made (and the caller doesn't hide it), the caller's phone number is displayed. Moreover, if you missed one or more calls, the  icon will appear on the LCD. If the CID memory is full, the  icon will flash on the LCD.



Out Of Area - This message will display when someone calls from an area where the telephone company is not offering the caller identification services or is not yet providing number delivery to your area.

Private - If the caller has exercised the option to prevent his name and number from being sent, the message will show on the LCD.



View and dial any of the CID numbers

1. Press the **Menu** soft key.
2. Use the **Select** soft key to choose the **CID Book**, and if available, the numbers are displayed. (You can also access the CID book directly by pressing the  key in standby mode.)
3. Use  or  key to view the numbers, you can make a call by pressing . You can also add the entry to the phonebook.





Note:

- *Each item of the incoming list is marked with the  icon if the call has been reviewed or with the  icon if the call hasn't been reviewed yet.*

Add CID Number to Phone Book

1. Press the **Menu** soft key.
2. Press the **Select** soft key to choose **CID Book**.
3. Use  or  key to view the numbers, when the desired number displays on the LCD, press the **More** soft key to enter **Add to PB** menu.
4. Press the **Select** soft key, you are prompted to enter the name.
5. Enter the name and press the **Save** soft key, then you can modify the number you want to store.
6. Press the **Save** soft key, you are able to select the ring tone, press the **Select** soft key to confirm and exit, you will hear a confirm beep.





Delete the CID Numbers

1. Press the **Menu** soft key.
2. Press the **Select** soft key to choose **CID Book**.
3. Scroll to the number you want to delete by using  or  key.
4. When the desired number appears on the display, press the **More** soft key.
5. Use  or  key to choose **Delete**, press the **Select** soft key to confirm. You will hear a beep and the LCD shows the next number.
6. At step 5, if you choose **Delete All** menu and press the **Select** soft key, the display will show **"Repeat"**. You can press the **Select** soft key to delete all the entries or press the **Back** key to cancel and exit.

■ Base Settings



Delete HS

This function allows you to delete a handset registration from the base.

1. Press the **Menu** soft key.
2. Press  or  key to choose **BS Settings**, then press the **Select** soft key.
3. Press the **Select** soft key to choose **Delete HS** menu. The display shows **"PIN?"** to prompt you to enter the PIN Code (The default PIN Code is "0000"). Then press the **Select** soft key.
4. Use  or  key to select a handset, press the **Select** soft key. If you select the current handset you are using or if you select a non-existent handset, a warning tone will be heard.
5. After that, the selected handset will behave according to the unregistered condition.

PB Status

The PB Status shows the number of phone book entries already stored.

1. Press the **Menu** soft key.
2. Press  key to choose **Phonebook**, press the **Select** soft key.
3. Press the **Select** soft key, the display shows **Add**, press  or  key to choose **PB Status**, press the **Select** soft key to confirm.
4. The display shows the current phonebook status, for example, **07/50 Used**. It means the phonebook can be up to 50 entries, and 7 ones have been stored.

■ Call List (continued)

Base Phone:

This telephone automatically displays an incoming caller's number/name along with the date and time of the call. It will record up to 20 calls of up to 16 digits and store the data into memory.

IMPORTANT: You must subscribe to Caller ID Service from your local telephone company to utilize this feature.

Out Of Area - This message will display when someone calls from an area where the telephone company is not offering the caller identification services or is not yet providing number delivery to your area.

Private - If the caller has exercised the option to prevent his name and number from being sent, the message will show on the LCD.

Viewing the Call List

Use ▲ or ▼ key to scroll through entries. Records will be listed in the order they were received.

Dialing a Number from the Call List

Use ▲ or ▼ key to scroll to the desired number, then press the **Speaker** key to dial it out.

Using the Call List Options







1. Press the ▲ or ▼ key in standby mode.
2. Scroll to the desired number by using the ▲ or ▼ key.
3. When the number appears on the display, press the **Options** soft key to choose the desired option:

- **Erase:** allows you to delete the selected number.
 - **Erase all:** allows you to delete the whole redial book.
 - **Store:** allows you to add the number to the phone book. Enter a name you want to use with this number, then press the **Save** soft key.
4. To exit, press the **Back** soft key.





Note:

- If you select **Erase all**, a message "**Erase all?**" will ask you to confirm or not. Press **Yes** to confirm or **No** to cancel.



Editing the Phone book Entries

1. Press the **Menu** soft key.
2. Press  key to choose **Phonebook**, press the **Select** soft key.
3. Press  or  key repeatedly until the entry you want to edit displays, press the **Select** soft key to confirm.
4. The display shows **New**, use the  or  key to move on to **Edit**, press **Select** soft key to choose it.
5. If necessary, press the **Erase** soft key to clear the digit(s) then enter the desired name and number, press the **Save** soft key.
6. Use  or  key to select the ring you like to associate with the number, press the **Select** soft key to confirm.

Deleting the Phone book Entries

1. Press the **Menu** soft key.
2. Press  key to choose **Phonebook**, press the **Select** soft key.
3. Press  or  key repeatedly until the name you want to delete displays, then press the **Select** soft key.
4. Press  or  key to choose **Delete**, press the **Select** soft key to confirm. Then the display shows the next entry.
5. At step 3, if you choose **Delete All** menu and press the **Select** soft key, the display will show "**Confirm**". You can press the **Select** soft key to delete all the entries or press the **Back** soft key to cancel and exit.

Adding the Phone book Entries



1. Press the **Menu** soft key.
2. Press  key to choose **Phonebook**, press the **Select** soft key.
3. The display shows **Empty** or phonebook entries you have stored, press the **Select** soft key, press **Select** soft key again to choose **New**.
4. The display shows "**Name ?**". Enter the name you want to use, then press the **Save** soft key to confirm. The display shows "**Number?**". Enter the desired number (up to 24 digits), press the **Save** soft key.
- 5.*Use  or  key to select the ring you like to associate with the number, press the **Select** soft key.
6. Repeat if necessary.

* If you want to set a VIP number, you should select a special ring tone for it. The ring tone should be different from the external ring you have set. You can set up to 9 VIP ring tones on the cordless handset associate with 9 VIP numbers/groups.

Note:

- *If you make a mistake while entering a number, use the **Erase** soft key to correct it. Each time you press the key, the last digit is deleted.*

Viewing the Phone book Entries

1. In the standby mode, press the  key.
2. Press  or  key repeatedly until the desired entry is displayed.







Dialing a Number from Phone book

Find out the number you want to dial. Refer to "Viewing the Phone book Entries". Then press the  key or **Dial** soft key.

Selecting a Language

Cordless Handset:

The handset supports up to 7 predefined languages: English, German, French, Italian, Turkish, Spanish and Portuguese. You can change the language used to display the menu messages.

1. Press the **Menu** soft key.
2. Press  or  key repeatedly to choose **HS Settings**, press the **Select** soft key.
3. Use  or  key to choose **Language**, then press the **Select** soft key.
4. The languages will be displayed. Use the  or  key to scroll through the options. Each language will be displayed in its own native translation.
5. Press **Select** soft key to select the required language and you will hear a confirm beep.

Base Phone:

The base phone supports up to 4 predefined languages: English, Spanish, French and German. You can change the language used to display the menu messages.

1. Press **Menu** soft key.
2. Press **Select** soft key to access **Set Display**.
3. Press **Select** soft key to select **Set Language**.
4. Press **▲** or **▼** key repeatedly to scroll through the options. Each language will be displayed in its own native translation.
5. Press **Select** soft key to select the required language.

Paging

You can page the handset from the base phone making it ring with a special tone. It's useful to locate a lost handset.

Press the  key on the base phone (less than 5 seconds), all the handsets registered to the base will ring for about 60 seconds.

Flash Signal

When the line is engaged, pressing the **Flash** soft key (**CALL WAITING** key on the base) sends the Flash signal. This key is used in conjunction with special services (e.g. call waiting) which can be available in your phone network. For further details please contact your network telephone company.

To stop paging, press the  key on the base again or the **Back** soft key on the handset.

Note:

- On a long  key press, more than or equal to 5 seconds, the base will enter **registration mode**. For details, see page 60.

To use the said special services, just press the **Flash** soft key (**CALL WAITING** key on the base) while the line is engaged: the display will show **R**.

Phone Book

The phonebook built in your cordless handset allows you to store frequently used numbers so that you can easily make a call without having to remember or enter the phone number.

Character Map

To enter a specific alphanumeric character, press one or more times the relevant key for the required character according to the following table: once for the first character, twice for the second and so on.

Key	Characters in the displayed order								
0	(spc)	0	?	&	/	.	,	!	
1	1	@	_	+	-	"	()	%
2	A	B	C	a	b	c	2		
3	D	E	F	d	e	f	3		
4	G	H	I	g	h	i	4		
5	J	K	L	j	k	l	5		
6	M	N	O	m	n	o	6		
7	P	Q	R	S	p	q	r	s	7
8	T	U	V	t	u	v	8		
9	W	X	Y	Z	w	x	y	z	9

Menu Map

1. CID Book (see page 39)

2. Phonebook

New (see page 50)
View (see page 50)
Edit (see page 51)
Delete (see page 51)
Delete All (see page 51)
PB Status (see page 52)

3. BS Settings

Delete HS (see page 53)

4. HS Settings

Alarm (see page 54)
Ring Setup (see page 34)
Tone Setup (see page 55)
Language (see page 43)
HS Name (see page 56)
LCD Contrast (see page 56)
Auto Answer (see page 57)
Amplified (see page 57)

Talk Keypad (see page 58)
Date & Time (see page 58)

5. Bluetooth

Add Device (see page 21)
Device List (see page 22)

6. Registration (see page 59)

7. Default (see page 60)

8. ANS. Machine



Message (see page 63)
Announce (see page 61)
TAM Setting (see page 64)

One-touch Memories



Cordless Handset:

You can store up to 3 numbers in direct memories. All the numbers will be stored in the phone book.

Storing Memory Numbers

1. Press the memory key (**M1~M4, SOS**) in the standby mode.
2. The display shows "**Number ?**". Enter the desired number (up to 24 digits), press the **Save** soft key.
3. Use  or  key to select the ring you like to associate with the number, press the **Select** soft key to confirm.

Viewing Memory Numbers

1. In the standby mode, press the  key.
2. Press  or  key repeatedly until the desired number is displayed.

Dialing from One-touch Memories

In the standby mode, press one of the memory keys (**M1~M4, SOS**) to dial out the corresponding number.

Editing Memory Numbers

Perform the steps of the "Editing the Phone book Entries" paragraph. Please refer to page 51.

Note:

- The memory default names are M1~M4 and SOS, you can add a name after them but cannot delete the default name. e.g. you can modify M1 to M1: home.

Deleting Memory Numbers

Perform the steps of the "Deleting the Phone book Entries" paragraph. Please refer to page 51.

■ One-touch Memories (continued)

Base Phone:

Your phone allows you to program 8 frequently dialed numbers (photo dials). Each memory key can store up to 24 digits.

Storing Memory Numbers

1. Use the keypad to enter the number you want to store. You can use the **Clear** soft key to edit the number.
2. Press and hold one of the Memory dial keys, then press the **Save** soft key. The display shows **Name:**.
3. Enter the name you want to use with the number. You can use the **Clear** soft key to edit it. Press the **Save** soft key to confirm.
4. Press the ▲ or ▼ key repeatedly to select the desired ringer tone to use with the number.
5. Press **Save** soft key to confirm.

Note:

- Entering a new number in the same location will automatically erase the previous number.

Viewing and Dialling Memory Numbers

In standby mode press one of the photo dial keys, the display will show the corresponding number. Press **Speaker** key to dial it out.

Using the Options

1. In standby mode press one of the photo dial keys or Speed dial keys.
2. Press **Options** soft key to choose the desired option:

Play Voice: allows you to play the voice prompt of this entry. If you have recorded the name for this entry, the system will announce the name, otherwise it can only announce the number.

Record Voice: allows you to record the name for the selected entry.

Erase Voice: allows you to delete the name you have recorded for the selected entry.



Edit: allows you to edit the selected entry.

Erase: allows you to delete the selected entry.

Handset Operations

■ Menu Navigation

To access a menu option:



1. To display menu items, press the **Menu** soft key.
2. To scroll through menu options, press the  or  key repeatedly.
3. To select a menu, press the **Select** soft key when the desired menu appears on the LCD.
4. Repeat if necessary.

To return to previous screen from menu:

If you press the **Back** soft key, the handset returns to the previous screen.

To return to standby mode, press the  key.

To set the answering machine:

1. Press the **TAM** soft key in standby mode.
2. To scroll through TAM options, press the  or  key repeatedly.
3. Press the **Select** soft key to confirm.