

<b>Prüfbericht-Nr.:</b> <i>Test Report No.:</i>	<b>50172874 001</b>	<b>Auftrags-Nr.:</b> <i>Order No.:</i>	114076041	Seite 1 von 35 <i>Page 1 of 35</i>
<b>Kunden-Referenz-Nr.:</b> <i>Client Reference No.:</i>	N/A	<b>Auftragsdatum:</b> <i>Order date:</i>	31-Mar-2018	
<b>Auftraggeber:</b> <i>Client:</i>	REYAX TECHNOLOGY CO.,LTD. 7F., No.584, Ruiguang Rd., Neihu Dist., Taipei City, Taiwan			
<b>Prüfgegenstand:</b> <i>Test item:</i>	RYLR896 Lora Antenna Transceiver Module			
<b>Bezeichnung / Typ-Nr.:</b> <i>Identification / Type No.:</i>	RYLR896			
<b>Auftrags-Inhalt:</b> <i>Order content:</i>	FCC Part 15C Test report (LoRa)			
<b>Prüfgrundlage:</b> <i>Test specification:</i>	FCC 47CFR Part 15: Subpart C Section 15.247(DTS)			
<b>Wareneingangsdatum:</b> <i>Date of receipt:</i>	02-May-2018			
<b>Prüfmuster-Nr.:</b> <i>Test sample No.:</i>	A000775076-001 A000775076-002			
<b>Prüfzeitraum:</b> <i>Testing period:</i>	13-Jul-2018 – 13-Aug-2018			
<b>Ort der Prüfung:</b> <i>Place of testing:</i>	EMC/RF Laboratory Taipei			
<b>Prüflaboratorium:</b> <i>Testing laboratory:</i>	TUV Rheinland Taiwan Ltd.			
<b>Prüfergebnis*:</b> <i>Test result*:</i>	Pass			
<b>Report date / tested by:</b>		<b>kontrolliert von / reviewed by:</b>		
31-Aug-2018 Jack Chang/Project Manager		31-Aug-2018 Arvin Ho/Vice General Manager		
<b>Datum</b> <i>Date</i>	<b>Name / Stellung</b> <i>Name / Position</i>	<b>Unterschrift</b> <i>Signature</i>	<b>Datum</b> <i>Date</i>	<b>Name / Stellung</b> <i>Name / Position</i>
				<b>Unterschrift</b> <i>Signature</i>
<b>Sonstiges / Other:</b>				
<b>Zustand des Prüfgegenstandes bei Anlieferung:</b> <i>Condition of the test item at delivery:</i>		Prüfmuster vollständig und unbeschädigt <i>Test item complete and undamaged</i>		
* Legende: 1 = sehr gut 2 = gut 3 = befriedigend 4 = ausreichend 5 = mangelhaft P(ass) = entspricht o.g. Prüfgrundlage(n) F(ail) = entspricht nicht o.g. Prüfgrundlage(n) N/A = nicht anwendbar N/T = nicht getestet Legend: 1 = very good 2 = good 3 = satisfactory 4 = sufficient 5 = poor P(ass) = passed a.m. test specification(s) F(ail) = failed a.m. test specification(s) N/A = not applicable N/T = not tested				
<b>Dieser Prüfbericht bezieht sich nur auf das o.g. Prüfmuster und darf ohne Genehmigung der Prüfstelle nicht auszugsweise vervielfältigt werden. Dieser Bericht berechtigt nicht zur Verwendung eines Prüfzeichens.</b> <i>This test report only relates to the a. m. test sample. Without permission of the test center this test report is not permitted to be duplicated in extracts. This test report does not entitle to carry any test mark.</i>				

## TEST SUMMARY

### 5.1.1 ANTENNA REQUIREMENT

RESULT: *Passed*

### 5.1.2 PEAK OUTPUT POWER

RESULT: *Passed*

### 5.1.3 6dB BANDWIDTH AND 99% BANDWIDTH

RESULT: *Passed*

### 5.1.4 POWER DENSITY

RESULT: *Passed*

### 5.1.5 CONDUCTED SPURIOUS EMISSIONS AND FREQUENCY BAND EDGE MEASURED IN 100KHZ BANDWIDTH

RESULT: *Passed*

### 5.1.6 SPURIOUS EMISSION

RESULT: *Passed*

### 5.1.7 MAINS CONDUCTED EMISSIONS

RESULT: *Passed*

### 6.1.1 ELECTROMAGNETIC FIELDS

RESULT: *Passed*

## Contents

<b>1.</b>	<b>GENERAL REMARKS .....</b>	<b>5</b>
<b>1.1</b>	<b>COMPLEMENTARY MATERIALS.....</b>	<b>5</b>
<b>2.</b>	<b>TEST SITES .....</b>	<b>6</b>
<b>2.1</b>	<b>TEST LABORATORY .....</b>	<b>6</b>
<b>2.2</b>	<b>TEST FACILITY.....</b>	<b>6</b>
<b>2.3</b>	<b>LIST OF TEST AND MEASUREMENT INSTRUMENTS.....</b>	<b>7</b>
<b>2.4</b>	<b>TRACEABILITY .....</b>	<b>8</b>
<b>2.5</b>	<b>CALIBRATION .....</b>	<b>8</b>
<b>2.6</b>	<b>MEASUREMENT UNCERTAINTY .....</b>	<b>8</b>
<b>3.</b>	<b>GENERAL PRODUCT INFORMATION.....</b>	<b>9</b>
<b>3.1</b>	<b>PRODUCT FUNCTION AND INTENDED USE .....</b>	<b>9</b>
<b>3.2</b>	<b>SYSTEM DETAILS AND RATINGS.....</b>	<b>9</b>
<b>3.3</b>	<b>INDEPENDENT OPERATION MODES.....</b>	<b>10</b>
<b>3.4</b>	<b>NOISE GENERATING AND NOISE SUPPRESSING PARTS .....</b>	<b>10</b>
<b>3.5</b>	<b>SUBMITTED DOCUMENTS.....</b>	<b>10</b>
<b>4.</b>	<b>TEST SET-UP AND OPERATION MODES.....</b>	<b>11</b>
<b>4.1</b>	<b>PRINCIPLE OF CONFIGURATION SELECTION .....</b>	<b>11</b>
<b>4.2</b>	<b>TEST OPERATION AND TEST SOFTWARE.....</b>	<b>11</b>
<b>4.3</b>	<b>SPECIAL ACCESSORIES AND AUXILIARY EQUIPMENT .....</b>	<b>11</b>
<b>4.4</b>	<b>COUNTERMEASURES TO ACHIEVE EMC COMPLIANCE.....</b>	<b>12</b>
<b>4.5</b>	<b>TEST SETUP DIAGRAM .....</b>	<b>12</b>
<b>5.</b>	<b>TEST RESULTS .....</b>	<b>14</b>
<b>5.1</b>	<b>TRANSMITTER REQUIREMENT &amp; TEST SUITES.....</b>	<b>14</b>
<b>5.1.1</b>	<i>Antenna Requirement .....</i>	<i>14</i>
<b>5.1.2</b>	<i>Peak Output Power .....</i>	<i>15</i>
<b>5.1.3</b>	<i>6dB Bandwidth and 99% Bandwidth.....</i>	<i>16</i>
<b>5.1.4</b>	<i>Power Density .....</i>	<i>19</i>
<b>5.1.5</b>	<i>Conducted spurious emissions and Frequency Band Edge measured in 100kHz Bandwidth.....</i>	<i>22</i>
<b>5.1.6</b>	<i>Spurious Emission .....</i>	<i>26</i>
<b>5.1.7</b>	<i>Mains Conducted Emissions.....</i>	<i>27</i>
<b>6.</b>	<b>SAFETY HUMAN EXPOSURE .....</b>	<b>28</b>
<b>6.1</b>	<b>RADIO FREQUENCY EXPOSURE COMPLIANCE .....</b>	<b>28</b>
<b>6.1.1</b>	<i>Electromagnetic Fields.....</i>	<i>28</i>

<b>7.</b>	<b>PHOTOGRAPHS OF THE TEST SET-UP.....</b>	<b>29</b>
<b>8.</b>	<b>LIST OF TABLES .....</b>	<b>35</b>
<b>9.</b>	<b>LIST OF PHOTOGRAPHS.....</b>	<b>35</b>

## 1. General Remarks

### 1.1 Complementary Materials

The following attachments are integral parts of this test report:

**Appendix P: Photo Documentation internal view**  
(File Name: 50172874 001 APPENDIXP)

**Appendix D: Test Result of Radiated Emissions**  
(File Name: 50172874 001 APPENDIXD)

Test Specifications

The following standards were applied.

**Table 1: Applied Standard and Test Levels**

<b>Radio</b>
FCC 47CFR Part 15: Subpart C Section 15.247 FCC 47CFR Part 2: Subpart J Section 2.1091 RSS-247 Issue 2 (Feb 2017) RSS-102 Issue 5 RSS-Gen, Issue 5, April 2018 ANSI C63.10:2013 KDB558074 D01 DTS Meas Guidance v03r05 KDB447498 D01 General RF Exposure Guidance v06

## 2. Test Sites

### 2.1 Test Laboratory

TUV Rheinland Taiwan Ltd.  
Taichung Branch Office

No.9, Lane 36, Minsheng Rd., Sec. 3, Daya District,  
Taichung City 428  
Taiwan (R.O.C.)

### 2.2 Test Facility

TUV Rheinland Taiwan Ltd.  
Taipei Office

11F. No.758, Sec. 4, Bade Rd., Songshan Dist.  
Taipei City 105  
Taiwan (R.O.C.)

FCC RegistrationNo.: 340738  
IC Canada Registration No.: 9465A-1  
TAF Accredited NCC Test Lab. No.:0759  
TAF ISO17025 Certification effective period: 2016-Jul-1st to 2019-Jun-30th



**Testing Laboratory**  
**0759**

## 2.3 List of Test and Measurement Instruments

**Table 2: List of Test and Measurement Equipment**

Kind of Equipment	Manu-facturer	Type	S/N	Last Calibration	Next Calibration
Test Software	Farad	EZ_EMC	Ver. TUV3A1	N/A	N/A
EMI Test Receiver	R&S	ESR 7	101062	2017/09/25	2018/09/25
Spectrum Analyzer	R&S	FSV 40	100921	2018/05/02	2019/05/02
Spectrum Analyzer	Agilent	N9010A	MY52221334	2018/02/05	2019/02/05
Preamplifier (30MHz -1GHz)	HP	8447F	2805A03335	2017/08/14	2018/08/14
Preamplifier (18 GHz -40 GHz)	COM-POWER	PAM-840	461257	2018/01/18	2019/01/18
Pre-Amplifier (1GHz~18GHz)	EM Electronics	EM01G18G	060649	2017/11/21	2018/11/21
Bilog Antenna	TESEQ	CBL6111D	29802	2017/08/10	2018/08/31
Horn Antenna	ETS-Lindgren	3117	00138160	2018/06/01	2019/06/01
Horn Antenna (18GHz~40GHz)	COM-POWER	AH-840	101029	2017/11/28	2018/11/28
Loop Antenna	Schwarzbeck	FMZB 1513	1513-076	2018/06/21	2019/06/21
Temp. & Humid. Chamber	Giant Force	GCT-099-40-S	MAF0103-007	2017/03/09	2019/03/09
LISN (1 phase)	R&S	ENV216	101243	2018/06/18	2019/06/18
LISN	R&S	ENV216	101262	2018/06/22	2019/06/21

## 2.4 Traceability

All measurement equipment calibrations are traceable to NML(Taiwan)/NIST(USA) or where calibration is performed outside Taiwan, to equivalent nationally recognized standards organizations.

## 2.5 Calibration

Equipment requiring calibration is calibrated periodically in a suitably accredited Calibration Lab. Additionally all equipment is verified for proper performance on a regular schedule using in house standards or comparisons.

## 2.6 Measurement Uncertainty

The estimated combined standard uncertainty for radiated emissions and conducted emissions measurements .

**Table 3: Emission Measurement Uncertainty**

Parameter	Uncertainty
Radio Frequency	$\pm 1 \times 10^{-7}$
RF power, conducted	$\pm 1.5$ dB
RF power density, conducted	$\pm 3$ dB
spurious emissions, conducted	$\pm 3$ dB
all emissions, radiated	$\pm 6$ dB
Temperature	$\pm 1$ °C
Humidity	$\pm 5$ %
DC and low frequency voltages	$\pm 3$ %



## 3. General Product Information

### 3.1 Product Function and Intended Use

The EUT is a RYLR896 Lora Antenna Transceiver Module. The Module has RF Shield and u.FL connector for External Antenna(s).

For details refer to the User Guide, Data Sheet and Circuit Diagram.

### 3.2 System Details and Ratings

**Table 4: Basic Information of EUT**

Item	EUT information
Kind of Equipment/Test Item	RYLR896 Lora Antenna Transceiver Module
Type Designation	RYLR896
FCC ID	QLYRYLR896

**Table 5: Technical Specification of EUT**

Technical Specification	Value
Operating Frequency Range	903MHz to 927.5MHz
Channel number	16
Operation Voltage	DC 2.8V~3.6V (Typical 3.3V)
Modulation	LoRa
Antenna gain	2dBi

### 3.3 Independent Operation Modes

Basic operation modes are:

- A. Transmitting
  - 1. Low channel
  - 2. Middle channel
  - 3. High channel
- B. Receiving
- C. Standby
- D. Off

### 3.4 Noise Generating and Noise Suppressing Parts

Refer to the Circuit Diagram.

### 3.5 Submitted Documents

- Circuit Diagram
- Blocking Diagram
- Rating Label
- Technical Description

## 4. Test Set-up and Operation Modes

### 4.1 Principle of Configuration Selection

The equipment under test (EUT) was configured to measure its maximum power level. The test modes were adapted accordingly in reference to the instructions for use.

### 4.2 Test Operation and Test Software

Setup for testing: Test samples are provided with a UART-USB interface which makes it possible to control them through the test software installed on a notebook computer.

This software was running on the laptop computer connected to the EUT. It was used to enable the operation modes listed in section 3.3 as appropriate.

The samples were used as follows:

Conducted: A000775076-001

Radiation: A000775076-002

Full test was applied on all test modes, but only worst case was shown

### 4.3 Special Accessories and Auxiliary Equipment

The product has been tested together with the following additional accessories:

Description	Manufacturer	Model No.	Serial No.
Notebook(EMC-06)	Lenovo	TP00048A	PB-0F8B2
Test tool	SUDT	AccessPort	1.37

## 4.4 Countermeasures to achieve EMC Compliance

The test sample which has been tested contained the noise suppression parts as described in the Constructional Data Form or the Technical Construction File. No additional measures were employed to achieve compliance.

## 4.5 Test Setup Diagram

**Diagram of Measurement Configuration for Radiation Test**

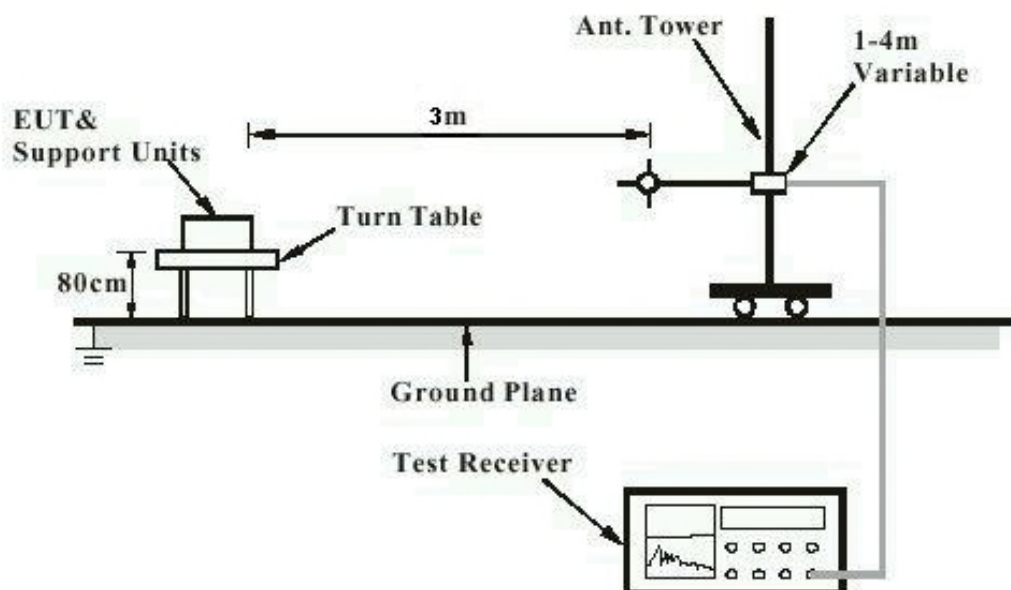

Note: Measurements above 1 GHz are done with a table height of 1.5m

**Diagram of Measurement Equipment Configuration for Mains Conduction Measurement (if applicable)**

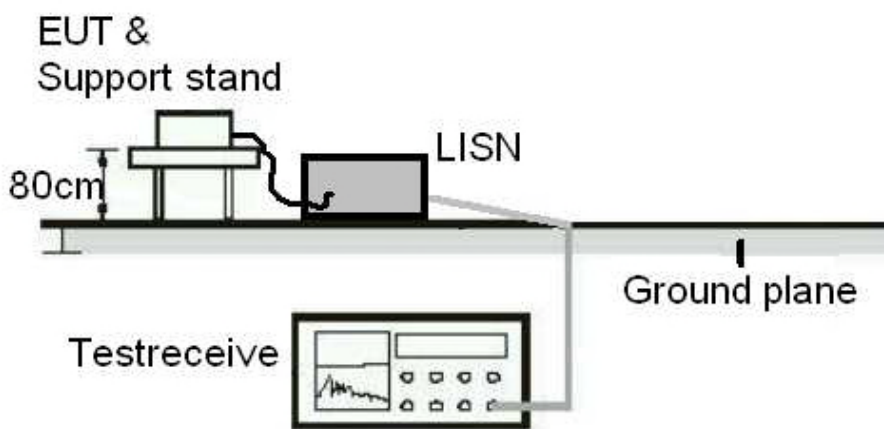

**Diagram of Measurement Equipment Configuration for Conducted Transmitter Measurement**

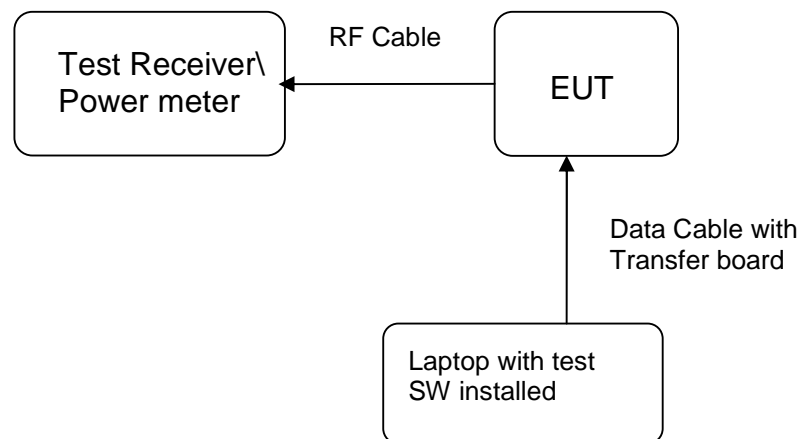

## 5. Test Results

### 5.1 Transmitter Requirement & Test Suites

#### 5.1.1 Antenna Requirement

**RESULT:** **Passed**

Test standard	:	LP0002(2016): 2.2, 3.10.1, (3) FCC Part 15.247(b)(4), Part 15.203 and RSS- Gen 8.3
Requirement	:	use of approved antennas only with directional gains that do not exceed 6 dBi

According to the manufacturer declaration, the EUT has an antenna with Max directional gain of 2dBi. The antenna a Helical Antenna with no possibility of replacement with a non-approved antenna by the end-user. Therefore, the EUT is considered to comply with this provision.

Refer to EUT photo for details.

### 5.1.2 Peak Output Power

**RESULT:**
**Passed**

Test standard : LP0002(2016): 3.10.1, (2)  
 FCC Part 15.247(b)(3), RSS-247 5.4(4)  
 Basic standard : ANSI C63.10:2013, KDB558074  
 Limit : 1 Watt  
 Kind of test site : Shielded room

**Test setup**

Test Channel : Low/ Middle/ High  
 Operation Mode : A  
 Ambient temperature : 20-24 °C  
 Relative humidity : 50-65 %  
 Atmospheric pressure : 100-103 kPa

**Table 6: Test result of Peak Output Power**

Channel	Channel Frequency (MHz)	Output Power		Limit
		(dBm)	(W)	(W)
Low Channel	903	10.02	0.01005	1
Middle Channel	914.2	9.91	0.00979	1
High Channel	927.5	9.70	0.00933	1

Pmax: 10.02dBm, 10.05mW

### 5.1.3 6dB Bandwidth and 99% Bandwidth

**RESULT:**
**Passed**

Test standard : LP0002(2016): 3.10.1, (5)  
 FCC Part 15.247(a)(2), RSS-247 5.2(1)  
 RSS-Gen (Issue 5)  
 Basic standard : ANSI C63.10:2013, KDB558074  
 Kind of test site : Shielded room

**Test setup**

Test Channel : Low/ Middle/ High  
 Operation Mode : A  
 Ambient temperature : 20-24°C  
 Relative humidity : 50-65%  
 Atmospheric pressure : 100-103 kPa

**Table 7: Test result of 6dB Bandwidth**

Channel	Channel Frequency (MHz)	6dB Bandwidth (kHz)	Limit (kHz)	Result
Low Channel	903	776.7	>500	Pass
Mid Channel	914.2	766.0	>500	Pass
High Channel	927.5	762.6	>500	Pass



## Test Plot of 6dB Bandwidth

### Low Channel

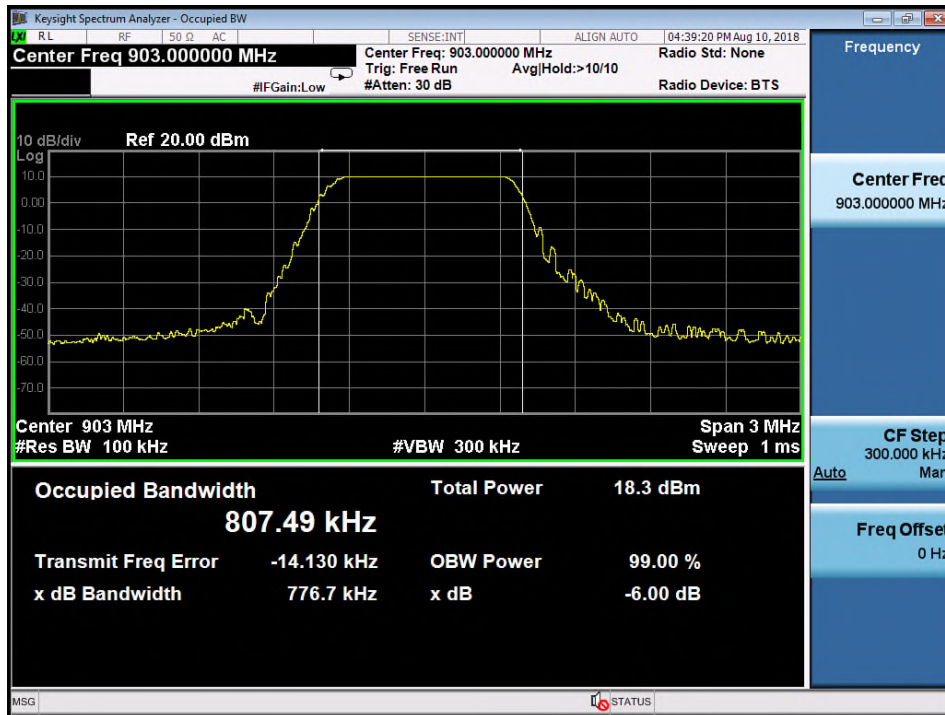

### Middle Channel

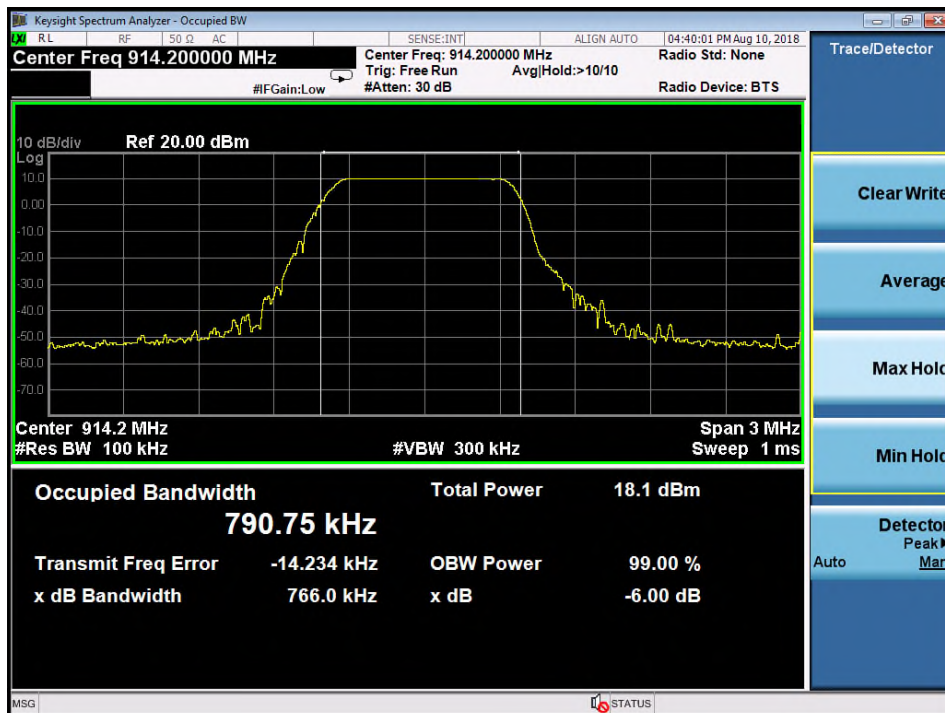

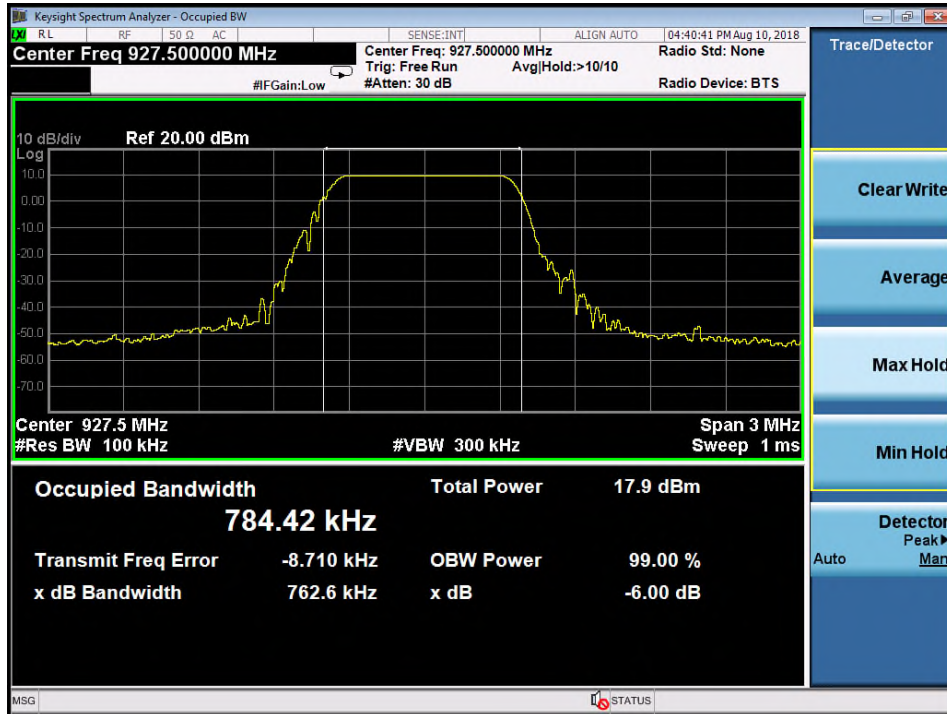
**High Channel**

### 5.1.4 Power Density

**RESULT:**
**Passed**

Test standard : LP0002(2016): 3.10.1, (6.2.2)  
 FCC Part 15.247(e) , RSS-247 5.2(2)  
 Basic standard : ANSI C63.10:2013, KDB558074  
 Kind of test site : Shielded room

**Test setup**

Test Channel : Low/ Middle/ High  
 Operation Mode : A  
 Ambient temperature : 20-24°C  
 Relative humidity : 50-65%  
 Atmospheric pressure : 100-103 kPa

**Table 8: Test result of Power Density**

Channel	Channel Frequency (MHz)	Power Density	Limit
		(dBm)	(dBm)
Low Channel	903	6.63	8
Middle Channel	914.2	6.61	8
High Channel	927.5	6.18	8

## Test Plot of Power Density

### Low Channel

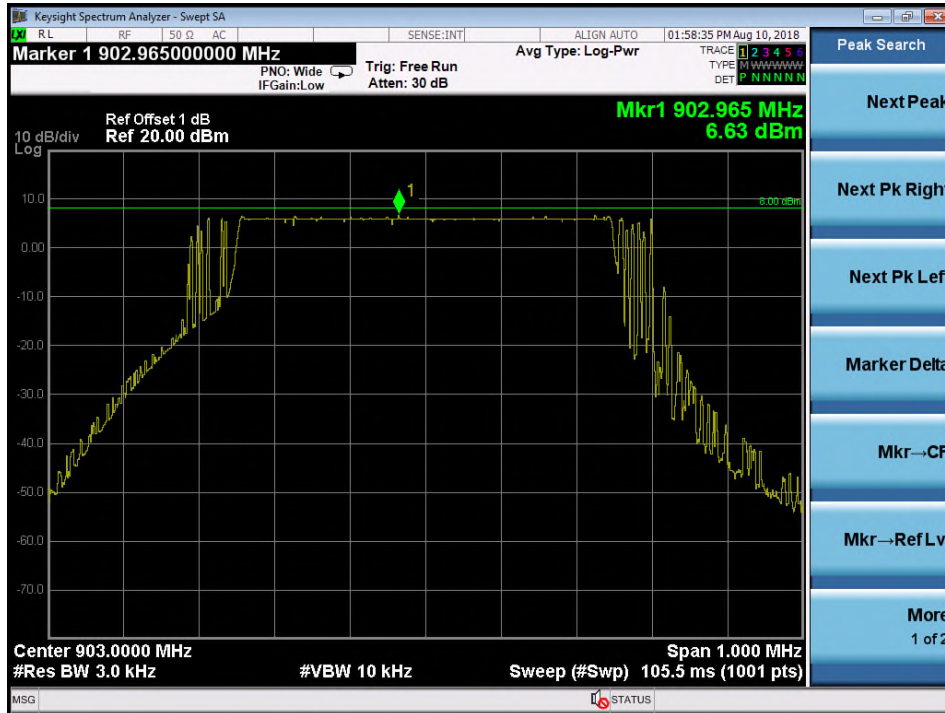

### Middle Channel

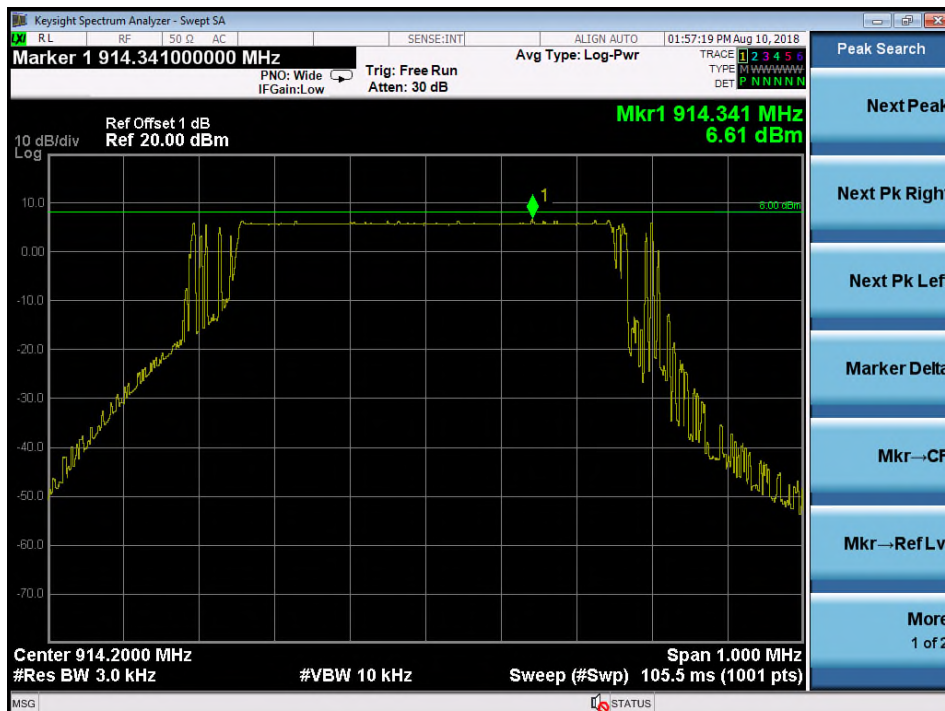

**High Channel**

### 5.1.5 Conducted spurious emissions and Frequency Band Edge measured in 100kHz Bandwidth

**RESULT:** **Passed**

Test standard	:	LP0002(2016): 3.10.1, (5) FCC part 15.247(d), RSS-247 5.5
Basic standard	:	ANSI C63.10:2013, KDB558074
Limit	:	20dB (below that in the 100kHz bandwidth within the band that contains the highest level of the desired power)
Kind of test site	:	Shielded room

#### Test setup

Test Channel	:	Low/ Mid/ High for spurious, Low/ High for Band Edge
Operation mode	:	A
Ambient temperature	:	20-24°C
Relative humidity	:	50-65%
Atmospheric pressure	:	100-103 kPa

All emissions are more than 20dB below fundamental, details refer to following test plot, and compliance is achieved as well.

Due to the small size of the product and that there are no inductive components of significant size, 9kHz to 30MHz frequency range is not tested based on technical judgment.



## Test Plot 100kHz Conducted Emissions

### Low Channel

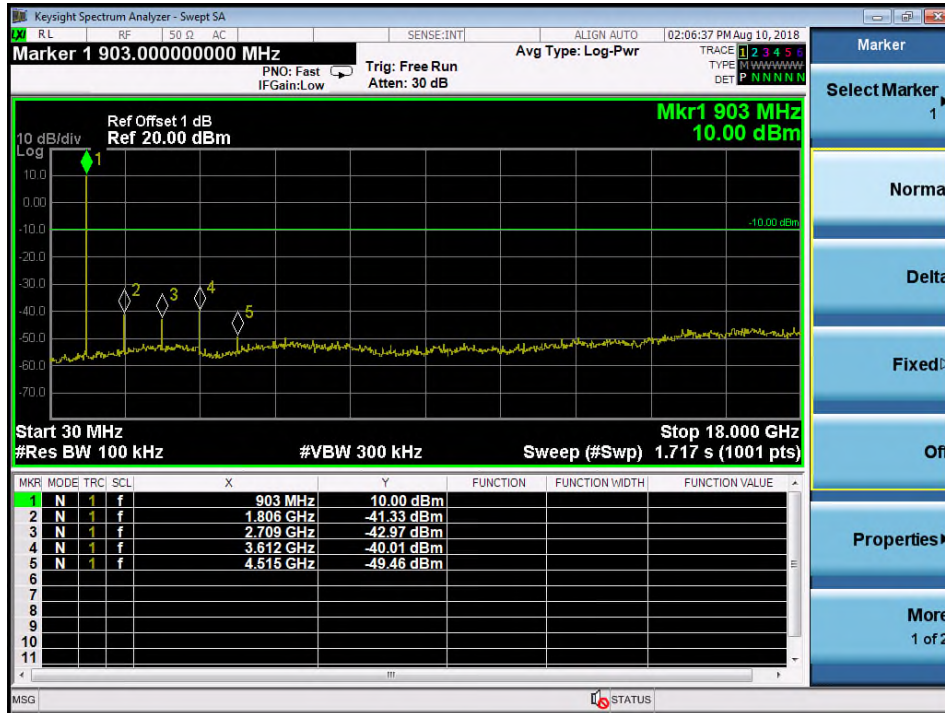

### Middle Channel

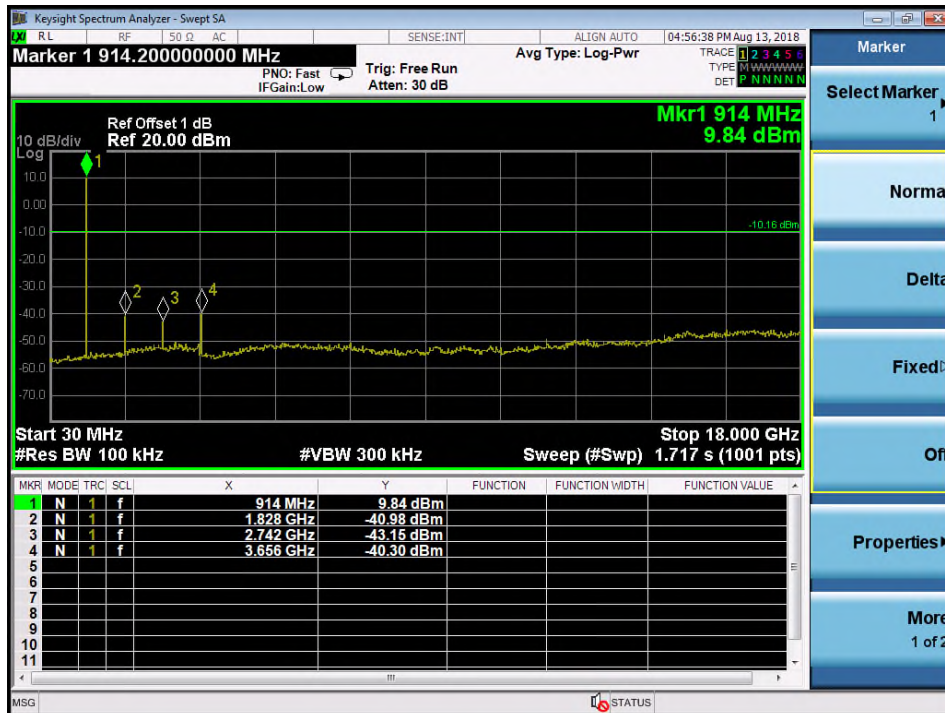





## Test Plot 100kHz RBW of Band Edge

### Low Channel

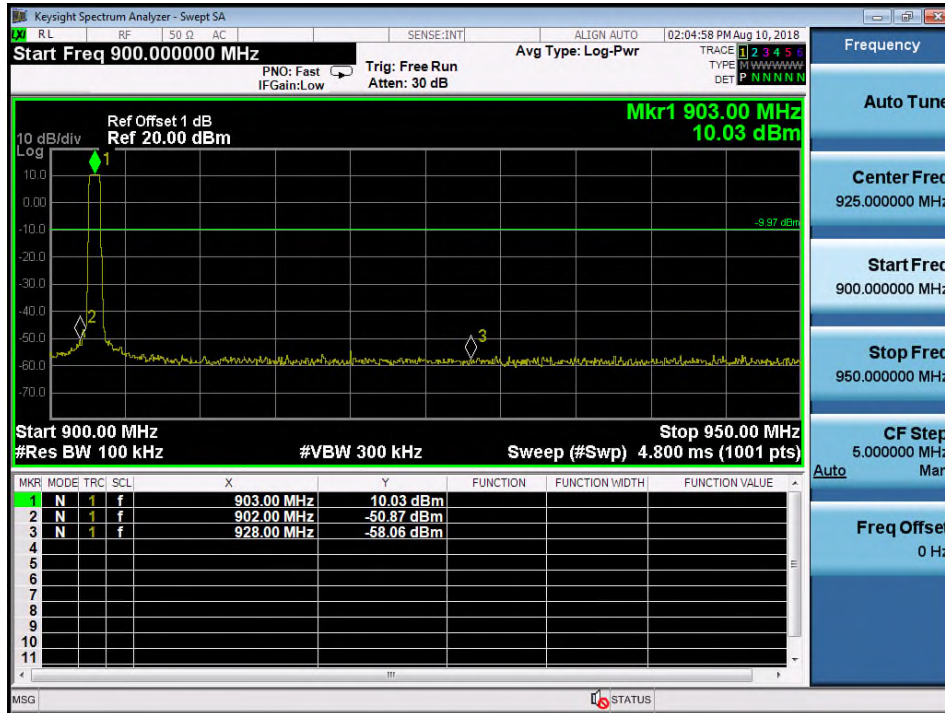

### High Channel

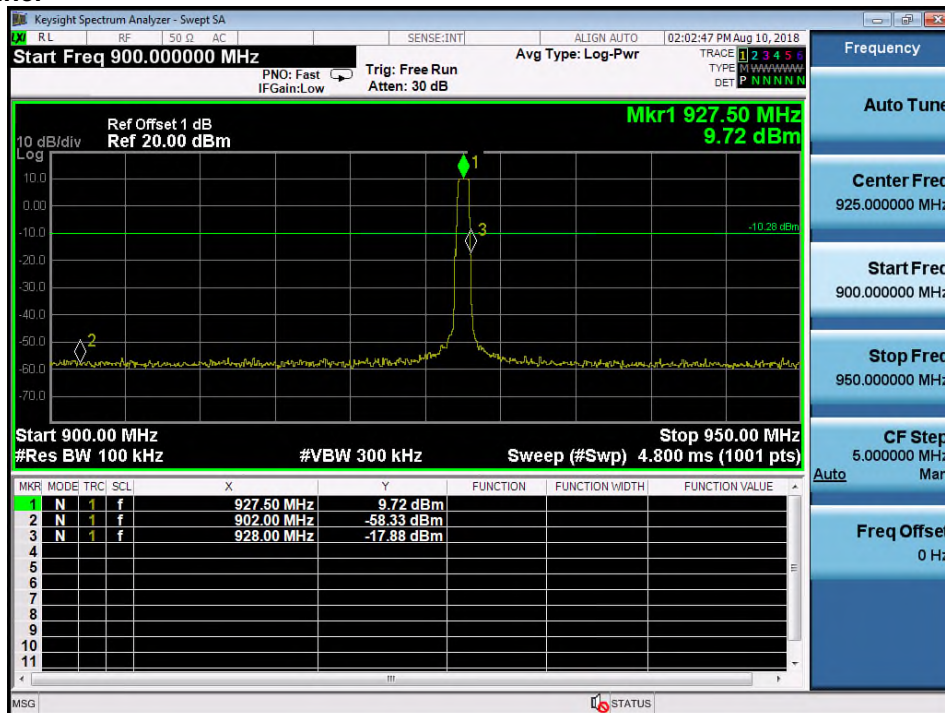

## 5.1.6 Spurious Emission

**RESULT:****Passed**

Test standard	:	FCC part 15.247(d), FCC 15.205, FCC 15.209, RSS-247 5.5 and RSS-Gen 8.9 LP0002(2016): 3.10.1, (5)
Basic standard	:	ANSI C63.10: 2013
Limits	:	Radiated emissions which fall in the restricted bands, as defined in FCC 15.205(a) and RSS-Gen i5, 8.10 (Table 7), must comply with the radiated emission limits specified in FCC 15.209(a) and RSS-Gen i5, 8.9 (Table 5 and 6). Radiated emissions which fall in the restricted bands, as defined in LP0002(2016): 2.7 , must comply with the radiated emission limits specified in LP0002(2016): 2.8 Emission radiated outside the specified frequency bands must comply with the radiated emission limits specified in FCC 15.209(a) and FCC 15.249(a), RSS-Gen i5, 8.9 (Table 5 and 6). Emission radiated outside the specified frequency bands must comply with the radiated emission limits specified in LP0002(2016): 2.8
Kind of test site	:	3m Semi-Anechoic Chamber

**Test setup**

Test Channel	:	Low/ Middle/ High
Operation mode	:	A, B

For details refer to Appendix D.

The Radiated Emissions testing was performed in the X, Y and Z axis orientation. The worst-case Axis orientation is recorded in this test report.

Mains Emissions

### 5.1.7 Mains Conducted Emissions

**RESULT:****Passed**

Test standard : FCC Part 15.207  
FCC Part 15.107  
RSS-Gen 8.8  
LP0002: 2.3

Limits : Mains Conducted emissions as defined in  
above test standards must comply with the  
mains conducted emission limits specified

Kind of test site : Shielded Room

**Test setup**

Test Channel : Middle  
Operation mode : A

Remark: For details refer to Appendix D.

## 6. Safety Human exposure

### 6.1 Radio Frequency Exposure Compliance

#### 6.1.1 Electromagnetic Fields

**RESULT:****Passed**

Test standard : FCC KDB Publication 447498 D01 v06  
47CFR 1.1310  
47CFR 2.1091  
RSS-102 issue 5

FCC:

Therefore the maximum output power of the transmitter is  $10.05\text{mW} < 15\text{mW}$  (Distance: 5 mm), hence the EUT is excluded from SAR evaluation according to FCC KDB publication 447498 D01: Mobile Portable RF Exposure.

**---End---**

## 7. Photographs of the Test Set-Up

Photograph 1: Set-up for Spurious Emissions (Front View 1)



Photograph 2: Set-up for Spurious Emissions (Front View 2)

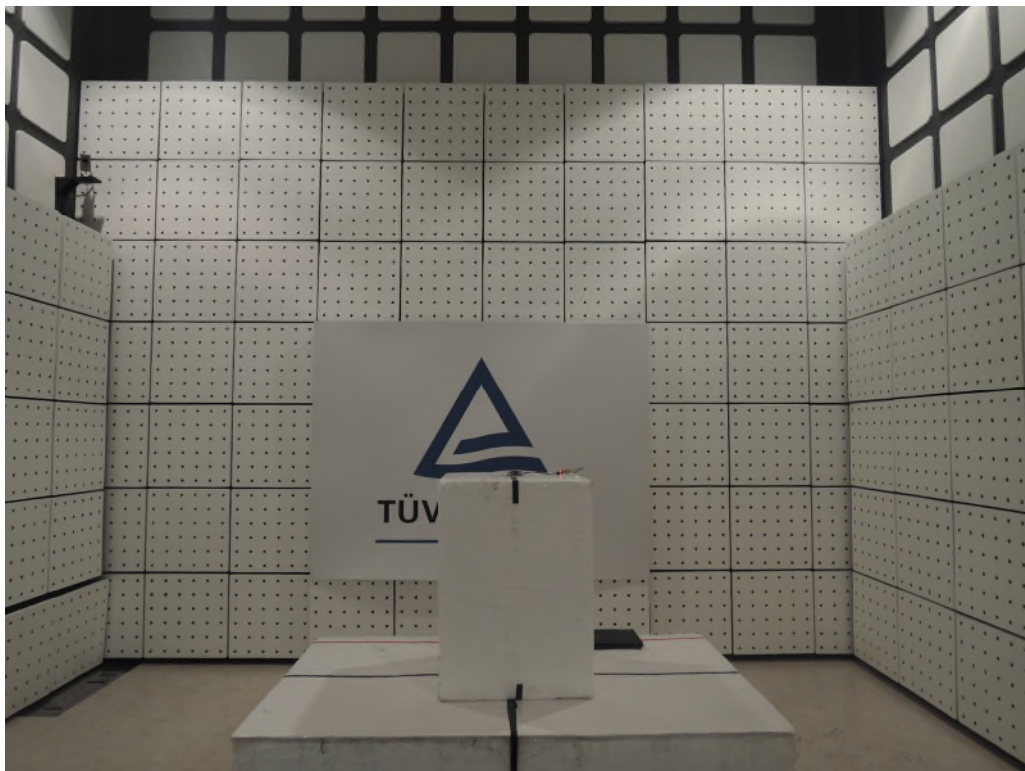



**Photograph 3: Set-up for Spurious Emissions (Back View 1)**

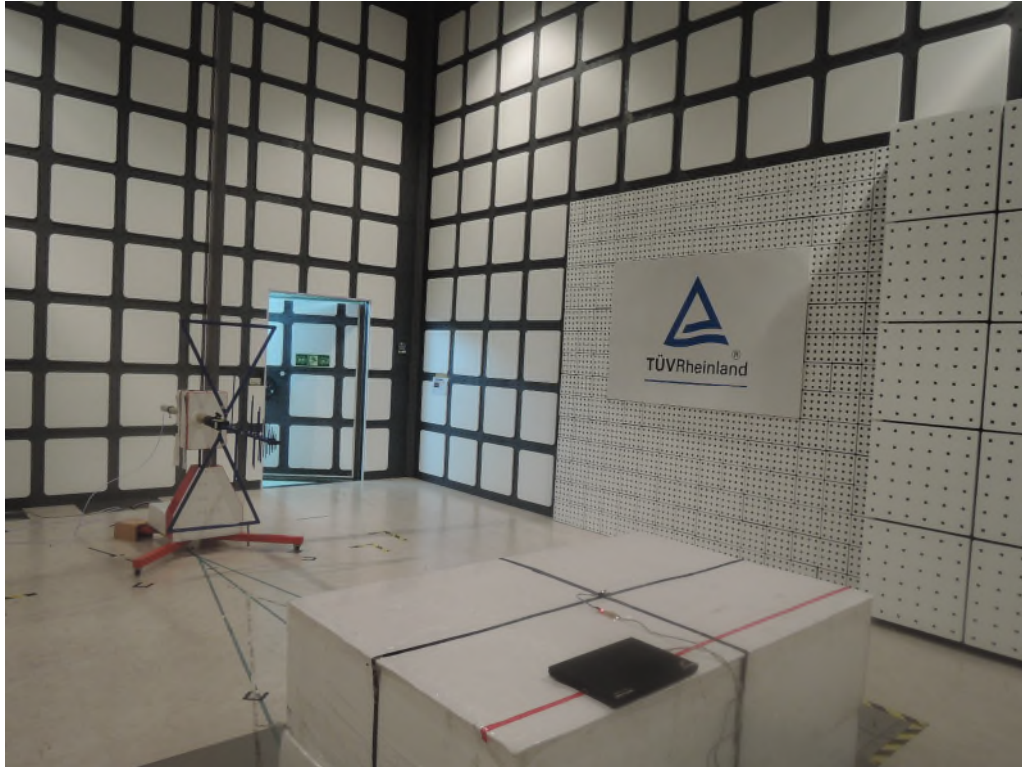

**Photograph 4: Set-up for Spurious Emissions (Back View 2)**

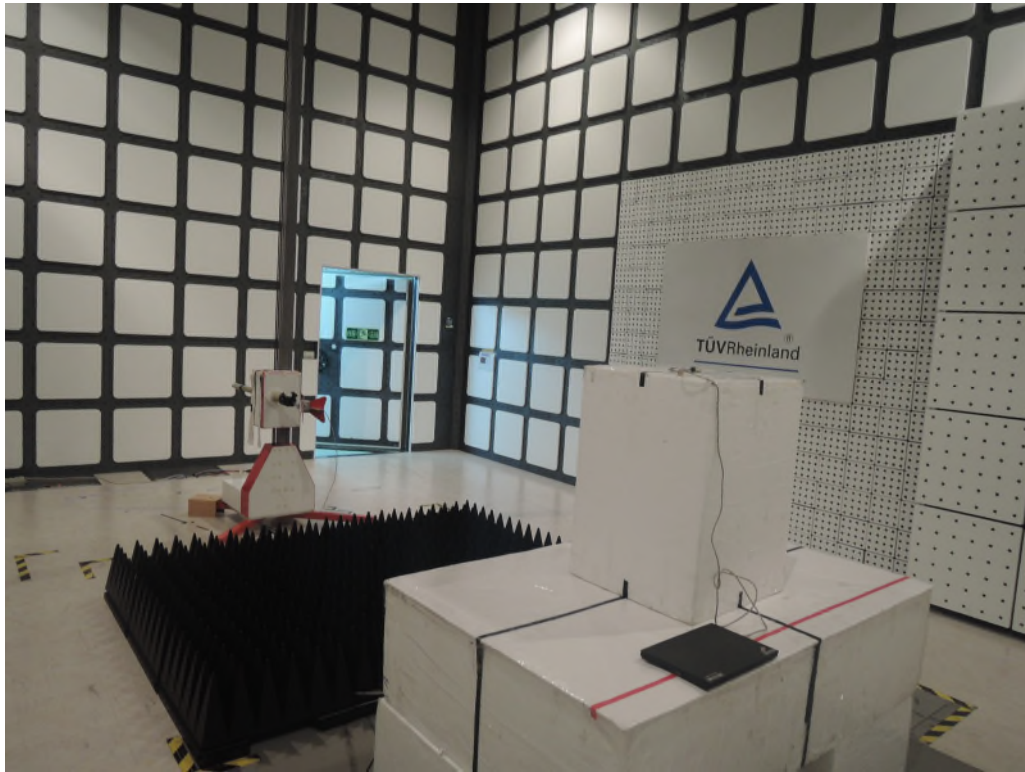

**Photograph 5: Set-up for Spurious Emissions (Back View 3)**





**Photograph 6: Set-up for Spurious Emissions (Back View 4)**

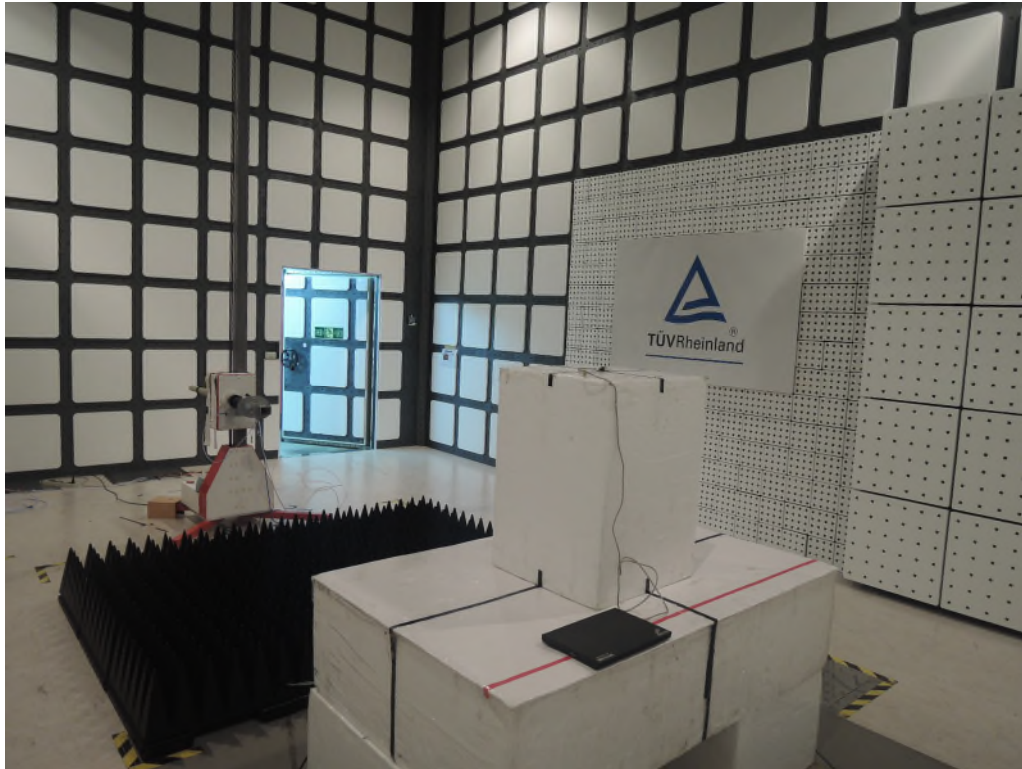

**Photograph 7: Set-up for Conducted testing**





**Photograph 8: Set-up for Conducted testing**

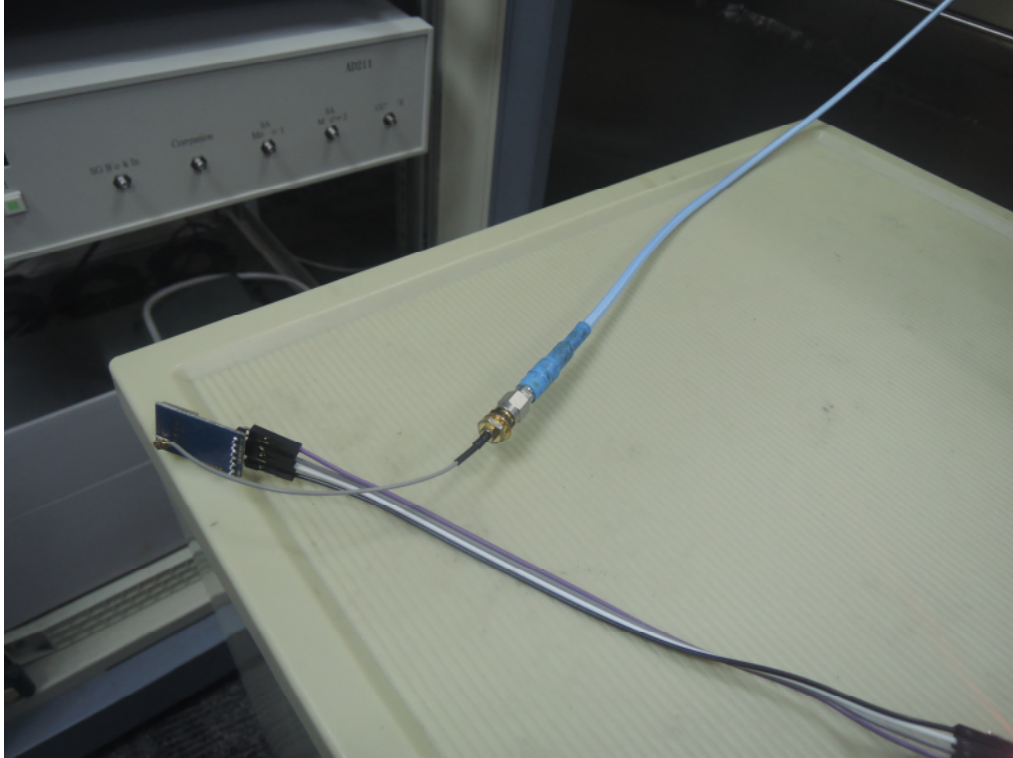

**Photograph 9: Set-up for Conducted testing**



**Photograph 10: Set-up for Mains Conducted testing Front**



**Photograph 11: Set-up for Mains Conducted testing Back**

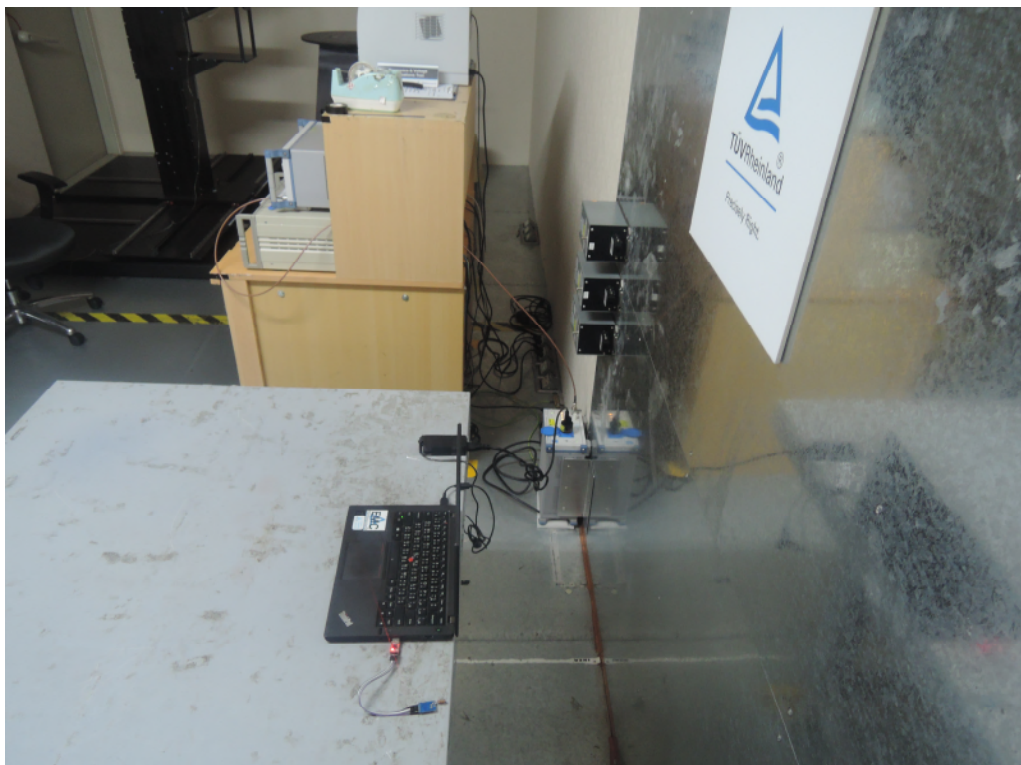

## 8. List of Tables

Table 1: Applied Standard and Test Levels .....	5
Table 2: List of Test and Measurement Equipment .....	7
Table 3: Emission Measurement Uncertainty.....	8
Table 4: Basic Information of EUT .....	9
Table 5: Technical Specification of EUT .....	9
Table 6: Test result of Peak Output Power .....	15
Table 7: Test result of 6dB Bandwidth .....	16
Table 8: Test result of Power Density .....	19

## 9. List of Photographs

Photograph 1: Set-up for Spurious Emissions (Front View 1).....	29
Photograph 2: Set-up for Spurious Emissions (Front View 2).....	29
Photograph 3: Set-up for Spurious Emissions (Back View 1) .....	30
Photograph 4: Set-up for Spurious Emissions (Back View 2).....	31
Photograph 5: Set-up for Spurious Emissions (Back View 3).....	31
Photograph 6: Set-up for Spurious Emissions (Back View 4).....	32
Photograph 7: Set-up for Conducted testing .....	32
Photograph 8: Set-up for Conducted testing .....	33
Photograph 9: Set-up for Conducted testing .....	33
Photograph 10: Set-up for Mains Conducted testing Front.....	34
Photograph 11: Set-up for Mains Conducted testing Back .....	34