

Prüfbericht-Nr.: <i>Test Report No.:</i>	50213901 001	Auftrags-Nr.: <i>Order No.:</i>	114083792	Seite 1 von 33 Page 1 of 33
Kunden-Referenz-Nr.: <i>Client Reference No.:</i>	N/A	Auftragsdatum: <i>Order date:</i>	November 9, 2018	
Auftraggeber: <i>Client:</i>	REYAX TECHNOLOGY CO.,LTD., 7F., No.584, Ruiguang Rd., Neihu Dist., Taipei City Taiwan			
Prüfgegenstand: <i>Test item:</i>	Bluetooth Module			
Bezeichnung / Typ-Nr.: <i>Identification / Type No.:</i>	RYB0801			
Auftrags-Inhalt: <i>Order content:</i>	FCC Part 15C Test report			
Prüfgrundlage: <i>Test specification:</i>	FCC 47CFR Part 15: Subpart C Section 15.247(DTS)			
Wareneingangsdatum: <i>Date of receipt:</i>	11/28/2018			
Prüfmuster-Nr.: <i>Test sample No.:</i>	A000835206-001 A000835206-002			
Prüfzeitraum: <i>Testing period:</i>	28-Nov-2018 - 3-Jan-2019			
Ort der Prüfung: <i>Place of testing:</i>	EMC/RF Laboratory Taipei			
Prüflaboratorium: <i>Testing laboratory:</i>	TUV Rheinland Taiwan Ltd.			
Prüfergebnis*: <i>Test result*:</i>	Pass			
geprüft von / tested by:		kontrolliert von / reviewed by:		
2019-01-19 Mars Y.J. Lin/Project Engineer		2019-01-19 Ryan W. T. Chen / Project Manager		
Datum <i>Date</i>	Name / Stellung <i>Name / Position</i>	Unterschrift <i>Signature</i>	Datum <i>Date</i>	Name / Stellung <i>Name / Position</i>
				Unterschrift <i>Signature</i>
Sonstiges / Other:				
Zustand des Prüfgegenstandes bei Anlieferung: <i>Condition of the test item at delivery:</i>		Prüfmuster vollständig und unbeschädigt <i>Test item complete and undamaged</i>		
* Legende: 1 = sehr gut 2 = gut 3 = befriedigend 4 = ausreichend 5 = mangelhaft P(ass) = entspricht o.g. Prüfgrundlage(n) F(ail) = entspricht nicht o.g. Prüfgrundlage(n) N/A = nicht anwendbar N/T = nicht getestet				
Legend: 1 = very good 2 = good 3 = satisfactory 4 = sufficient 5 = poor P(ass) = passed a.m. test specification(s) F(ail) = failed a.m. test specification(s) N/A = not applicable N/T = not tested				
<p>Dieser Prüfbericht bezieht sich nur auf das o.g. Prüfmuster und darf ohne Genehmigung der Prüfstelle nicht auszugsweise vervielfältigt werden. Dieser Bericht berechtigt nicht zur Verwendung eines Prüfzeichens.</p> <p><i>This test report only relates to the a. m. test sample. Without permission of the test center this test report is not permitted to be duplicated in extracts. This test report does not entitle to carry any test mark.</i></p>				

TEST SUMMARY

5.1.1 ANTENNA REQUIREMENT*RESULT: Passed***5.1.2 PEAK OUTPUT POWER***RESULT: Passed***5.1.3 6dB BANDWIDTH AND 99% BANDWIDTH***RESULT: Passed***5.1.4 POWER DENSITY***RESULT: Passed***5.1.5 CONDUCTED SPURIOUS EMISSIONS AND FREQUENCY BAND EDGE MEASURED IN 100kHz BANDWIDTH***RESULT: Passed***5.1.6 SPURIOUS EMISSION***RESULT: Passed***5.2.1 MAINS CONDUCTED EMISSIONS***RESULT: Passed***6.1.1 ELECTROMAGNETIC FIELDS***RESULT: Passed*

Contents

1.	GENERAL REMARKS	5
1.1	COMPLEMENTARY MATERIALS.....	5
2.	TEST SITES	6
2.1	TEST LABORATORY	6
2.2	TEST FACILITY.....	6
2.3	LIST OF TEST AND MEASUREMENT INSTRUMENTS.....	7
2.4	TRACEABILITY	8
2.5	CALIBRATION	8
2.6	MEASUREMENT UNCERTAINTY	8
3.	GENERAL PRODUCT INFORMATION.....	9
3.1	PRODUCT FUNCTION AND INTENDED USE	9
3.2	SYSTEM DETAILS AND RATINGS.....	9
3.3	INDEPENDENT OPERATION MODES.....	10
3.4	NOISE GENERATING AND NOISE SUPPRESSING PARTS	10
3.5	SUBMITTED DOCUMENTS.....	10
4.	TEST SET-UP AND OPERATION MODES.....	11
4.1	PRINCIPLE OF CONFIGURATION SELECTION	11
4.2	TEST OPERATION AND TEST SOFTWARE.....	11
4.3	SPECIAL ACCESSORIES AND AUXILIARY EQUIPMENT	11
4.4	COUNTERMEASURES TO ACHIEVE EMC COMPLIANCE.....	12
4.5	TEST SETUP DIAGRAM	12
5.	TEST RESULTS	14
5.1	TRANSMITTER REQUIREMENT & TEST SUITES	14
	<i>5.1.1 Antenna Requirement</i>	<i>14</i>
	<i>5.1.2 Peak Output Power.....</i>	<i>15</i>
	<i>5.1.3 6dB Bandwidth and 99% Bandwidth.....</i>	<i>16</i>
	<i>5.1.4 Power Density.....</i>	<i>19</i>
	<i>5.1.5 Conducted spurious emissions and Frequency Band Edge measured in 100kHz Bandwidth.....</i>	<i>22</i>
	<i>5.1.6 Spurious Emission</i>	<i>26</i>
5.2	MAINS EMISSIONS.....	27
	<i>5.2.1 Mains Conducted Emissions.....</i>	<i>27</i>
6.	SAFETY HUMAN EXPOSURE	28

6.1	RADIO FREQUENCY EXPOSURE COMPLIANCE	28
6.1.1	<i>Electromagnetic Fields.....</i>	<i>28</i>
7.	PHOTOGRAPHS OF THE TEST SET-UP.....	29
8.	LIST OF TABLES	33
9.	LIST OF PHOTOGRAPHS.....	33

1. General Remarks

1.1 Complementary Materials

The following attachments are integral parts of this test report:

Appendix P: Photo Documentation internal view
(File Name: 50213901APPENDIX P)

Appendix D: Test Result of Radiated Emissions
(File Name: 50213901APPENDIX D)

Test Specifications

The following standards were applied.

Table 1: Applied Standard and Test Levels

Radio
FCC CFR47 Part 15: Subpart C Section 15.247
ANSI C63.10:2013
KDB558074 D01 DTS Meas Guidance v05

2. Test Sites

2.1 Test Laboratory

TUV Rheinland Taiwan Ltd.
Taichung Branch Office

No.9, Lane 36, Minsheng Rd., Sec. 3, Daya District,
Taichung City 428
Taiwan (R.O.C.)

2.2 Test Facility

TUV Rheinland Taiwan Ltd.
Taipei Office

11F. No.758, Sec. 4, Bade Rd., Songshan Dist.
Taipei City 105
Taiwan (R.O.C.)

FCC RegistrationNo.: 340738
IC Canada Registration No.: 9465A-1
TAF Accredited NCC Test Lab. No.:0759
TAF ISO17025 Certification effective period: 2016-Jul-1st to 2019-Jun-30th



Testing Laboratory
0759

2.3 List of Test and Measurement Instruments

Table 2: List of Test and Measurement Equipment

Kind of Equipment	Manu-facturer	Type	S/N	Last Calibration	Next Calibration
Test Software	Farad	EZ EMC	Ver. TUV3A1	N/A	N/A
EMI Test Receiver	R&S	ESR 7	101549	2018/11/12	2019/11/10
Spectrum Analyzer	R&S	FSV 40	100921	2018/05/02	2019/05/02
EXA Signal Analyzer	KEYSIGHT	N9010A	MY52221334	2018/02/05	2019/02/04
Preamplifier (30MHz -1GHz)	Hewlett Packard	8447D	2944A06641	2018/08/31	2019/08/31
Preamplifier (18 GHz -40 GHz)	COM-POWER	PAM-840	461257	2018/01/18	2019/01/17
Pre-Amplifier (1GHz~18GHz)	EM Electronics	EM01G18G	60649	2018/08/24	2019/08/24
Bilog Antenna	TESEQ	CBL6111D	29804	2018/07/02	2019/07/02
Horn Antenna	ETS-Lindgren	3117	138160	2018/06/01	2019/06/01
Horn Antenna (18GHz~40GHz)	COM-POWER	AH-840	101031	2018/01/16	2019/01/16
Loop Antenna	Schwarzbeck	FMZB 1513	1513-076	2018/06/14	2019/06/13
EMI Test Receiver	R&S	ESR 7	101549	2018/11/12	2019/11/10
Temp. & Humid. Chamber	Giant Force	GCT-099-40-S	MAF0103-007	2017/03/09	2019/03/09
LISN (1 phase)	R&S	ENV216	101243	2018/06/18	2019/06/17
LISN	R&S	ENV216	101262	2018/06/22	2019/06/21
Spectrum Analyzer	Agilent	N9010A	MY53470241	2018/06/04	2019/06/03

2.4 Traceability

All measurement equipment calibrations are traceable to NML(Taiwan)/NIST(USA) or where calibration is performed outside Taiwan, to equivalent nationally recognized standards organizations.

2.5 Calibration

Equipment requiring calibration is calibrated periodically in a suitably accredited Calibration Lab. Additionally all equipment is verified for proper performance on a regular schedule using in house standards or comparisons.

2.6 Measurement Uncertainty

The estimated combined standard uncertainty for radiated emissions and conducted emissions measurements .

Table 3: Emission Measurement Uncertainty

Parameter	Uncertainty
Radio Frequency	± 0.1 ppm
RF power, conducted	± 1.5 dB
RF power density, conducted	± 3 dB
spurious emissions, conducted	± 3 dB
all emissions, radiated	± 6 dB
Temperature	± 1 °C
Humidity	± 5 %
DC and low frequency voltages	±3 %

3. General Product Information

3.1 Product Function and Intended Use

The EUT is a Bluetooth Module. It contains a Bluetooth 5.0 compatible module enabling the user to communicate data through a Wireless interface.
For details refer to the User Guide, Data Sheet and Circuit Diagram.

3.2 System Details and Ratings

Table 4: Basic Information of EUT

Item	EUT information
Kind of Equipment/Test Item	Bluetooth Module
Type Identification	RYB080I
Brand Name	REYAX
FCC ID	QLY-RYB080I

Table 5: Technical Specification of EUT

Technical Specification	Value
Operating Frequencies	2402~2480 MHz
Channel Spacing	2 MHz
Channel number	40
Operation Voltage	3.3 Vdc
Modulation	GFSK
Antenna gain	0.5 dBi

3.3 Independent Operation Modes

Basic operation modes are:

- A. Transmitting
 - 1. Low channel
 - 2. Middle channel
 - 3. High channel
- B. Receiving
- C. Standby
- D. Off

3.4 Noise Generating and Noise Suppressing Parts

Refer to the Circuit Diagram.

3.5 Submitted Documents

- Circuit Diagram
- Instruction Manual
- Rating Label
- Technical Description

4. Test Set-up and Operation Modes

4.1 Principle of Configuration Selection

The equipment under test (EUT) was configured to measure its maximum power level. The test modes were adapted accordingly in reference to the instructions for use.

4.2 Test Operation and Test Software

Setup for testing: Test samples are provided with a USB SPI interface which makes it possible to control them through a test software installed on a notebook computer.

This software was running on the laptop computer connected to the EUT. It was used to enable the operation modes listed in section 3.3 as appropriate.

The samples were used as follows:

Conducted: A000835206-002

Radiation: A000835206-001

Full test was applied on all test modes, but only worst case was shown

Test Software	QCOM_V1.6
---------------	-----------

4.3 Special Accessories and Auxiliary Equipment

The product has been tested together with the following additional accessories:

Description	Manufacturer	Model No.	Serial No.
Notebook(EMC-06)	Lenovo	TP00048A	PB-0F8B2

4.4 Countermeasures to achieve EMC Compliance

The test sample which has been tested contained the noise suppression parts as described in the Constructional Data Form or the Technical Construction File. No additional measures were employed to achieve compliance.

4.5 Test Setup Diagram

Diagram of Measurement Configuration for Radiation Test

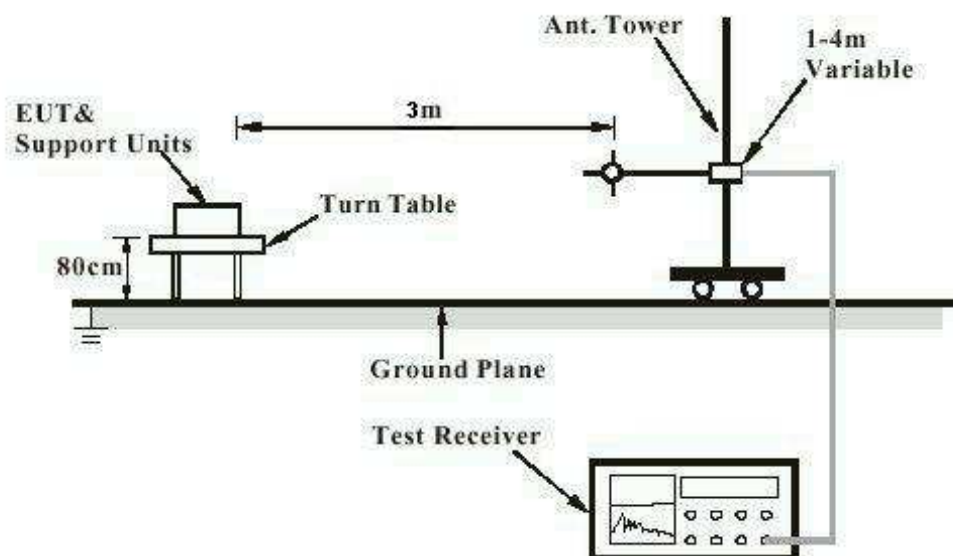

Note: Measurements above 1 GHz are done with a table height of 1.5m

Diagram of Measurement Equipment Configuration for Mains Conduction Measurement (if applicable)

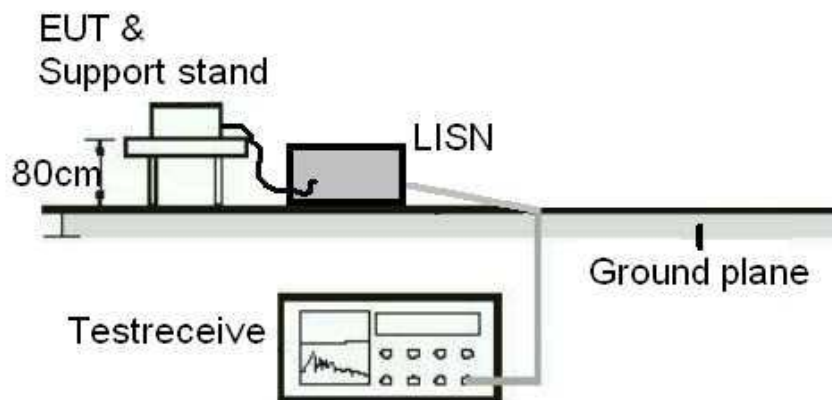
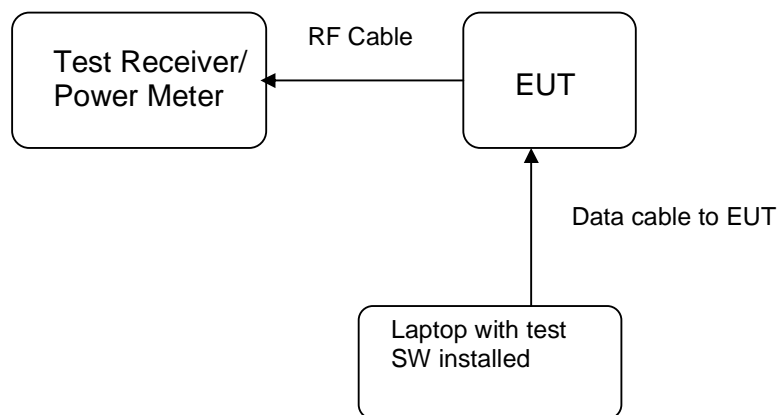

Diagram of Measurement Equipment Configuration for Conducted Transmitter Measurement



5. Test Results

5.1 Transmitter Requirement & Test Suites

5.1.1 Antenna Requirement

RESULT: **Passed**

Test standard	:	LP0002(2018): 2.2, 3.10.1, (3) FCC Part 15.247(b)(4), Part 15.203 and RSS- Gen 8.3
Requirement	:	use of approved antennas only with directional gains that do not exceed 6 dBi

According to the manufacturer declaration, the EUT has an antenna with a directional gain of 0.5 dBi. The antenna is a Chip Antenna soldered to the PCB with no possibility of replacement with a non-approved antenna by the end-user. Therefore, the EUT is considered to comply with this provision.

Refer to EUT photo for details.

5.1.2 Peak Output Power

RESULT:
Passed

Test standard : LP0002(2018): 3.10.1, (2)
 FCC Part 15.247(b)(3), RSS-247 5.4(4)
 Basic standard : ANSI C63.10:2013, KDB558074
 Limit : 1 Watt
 Kind of test site : Shielded room

Test setup

Test Channel : Low/ Middle/ High
 Operation Mode : A

 Ambient temperature : 20-24 °C
 Relative humidity : 50-65 %
 Atmospheric pressure : 100-103 kPa

Table 6: Test result of Peak Output Power

Channel	Channel Frequency (MHz)	Output Power		Limit
		(dBm)	(W)	(W)
Low Channel	2402	4.03	0.00253	1
Middle Channel	2440	3.70	0.00234	1
High Channel	2480	3.60	0.00229	1

Pmax: 2.5293 mW

5.1.3 6dB Bandwidth and 99% Bandwidth

RESULT:
Passed

Test standard : LP0002(2018): 3.10.1, (5)
 FCC Part 15.247(a)(2), RSS-247 5.2(1)
 RSS-Gen (Issue 4)
 Basic standard : ANSI C63.10:2013, KDB558074
 Kind of test site : Shielded room

Test setup

Test Channel : Low/ Middle/ High
 Operation Mode : A

 Ambient temperature : 20-24°C
 Relative humidity : 50-65%
 Atmospheric pressure : 100-103 kPa

Table 7: Test result of 6dB Bandwidth

Channel	Channel Frequency (MHz)	6dB Bandwidth (kHz)	Limit (kHz)	Result
Low Channel	2402	713.2	>500	Pass
Mid Channel	2440	717.6	>500	Pass
High Channel	2480	730.9	>500	Pass

Table 8: Test result of 99% Bandwidth,

Channel	Channel Frequency (MHz)	99% Bandwidth (kHz)
Mid Channel	2440	1070.2

Test Plot of 6dB Bandwidth

Low Channel

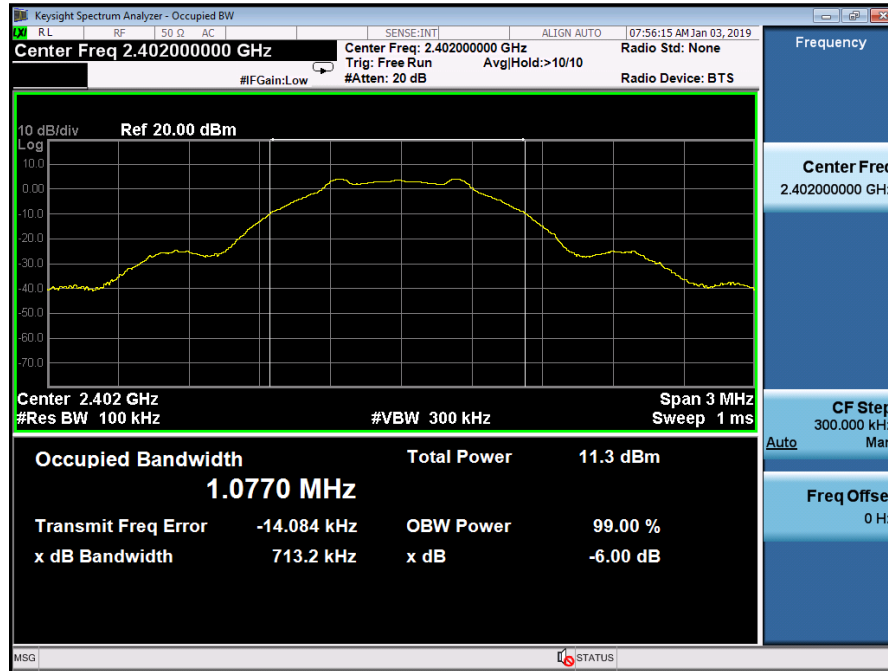

Middle Channel

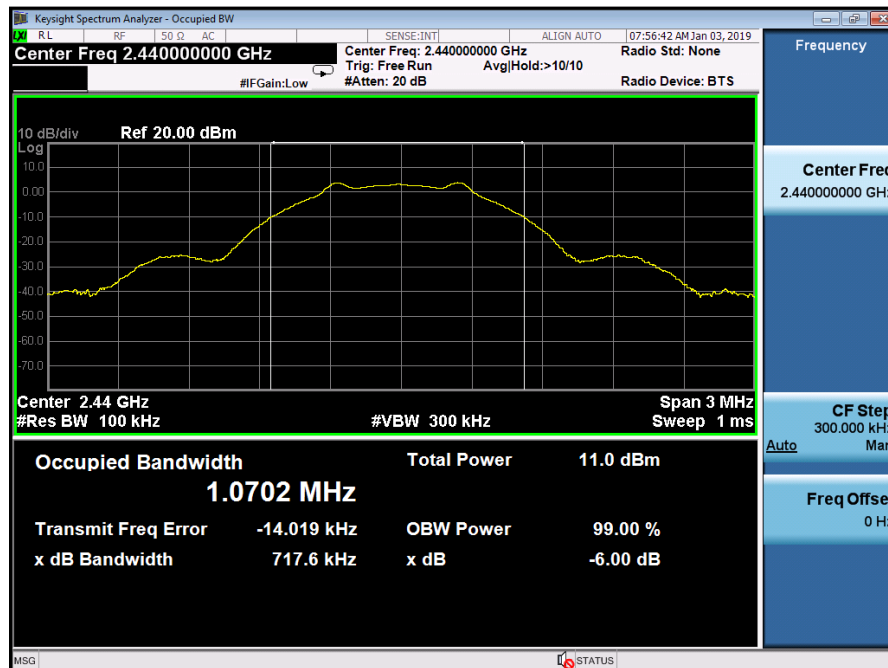

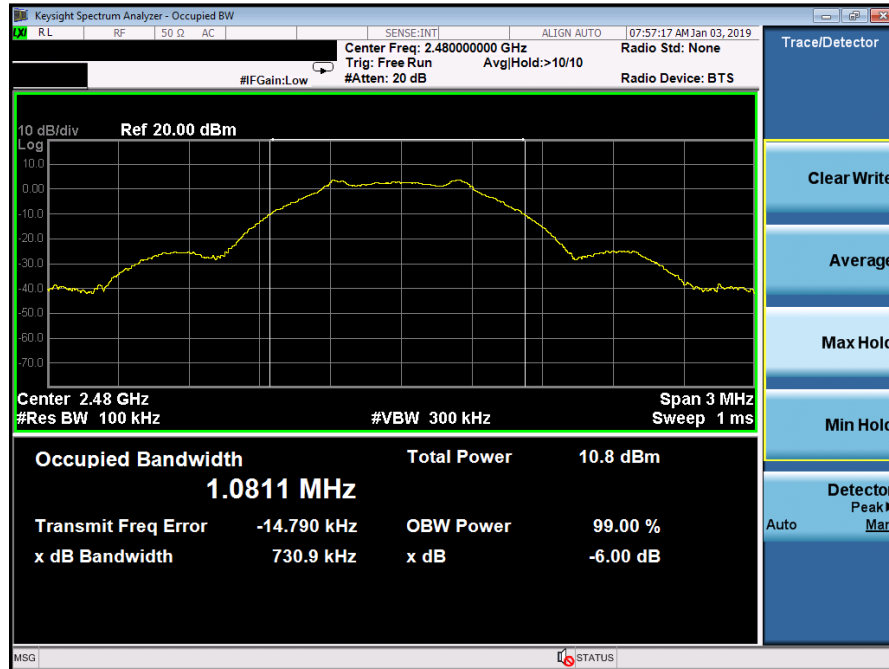
High Channel

5.1.4 Power Density

RESULT:**Passed**

Test standard : LP0002(2018): 3.10.1, (6.2.2)
FCC Part 15.247(e) , RSS-247 5.2(2)
Basic standard : ANSI C63.10:2013, KDB558074
Kind of test site : Shielded room

Test setup

Test Channel : Low/ Middle/ High
Operation Mode : A
Ambient temperature : 20-24°C
Relative humidity : 50-65%
Atmospheric pressure : 100-103 kPa

Table 9: Test result of Power Density

Channel	Channel Frequency (MHz)	Power Density	Limit
		(dBm)	(dBm)
Low Channel	2402	-6.959	8
Middle Channel	2440	-7.518	8
High Channel	2480	-7.67	8

Test Plot of Power Density

Low Channel

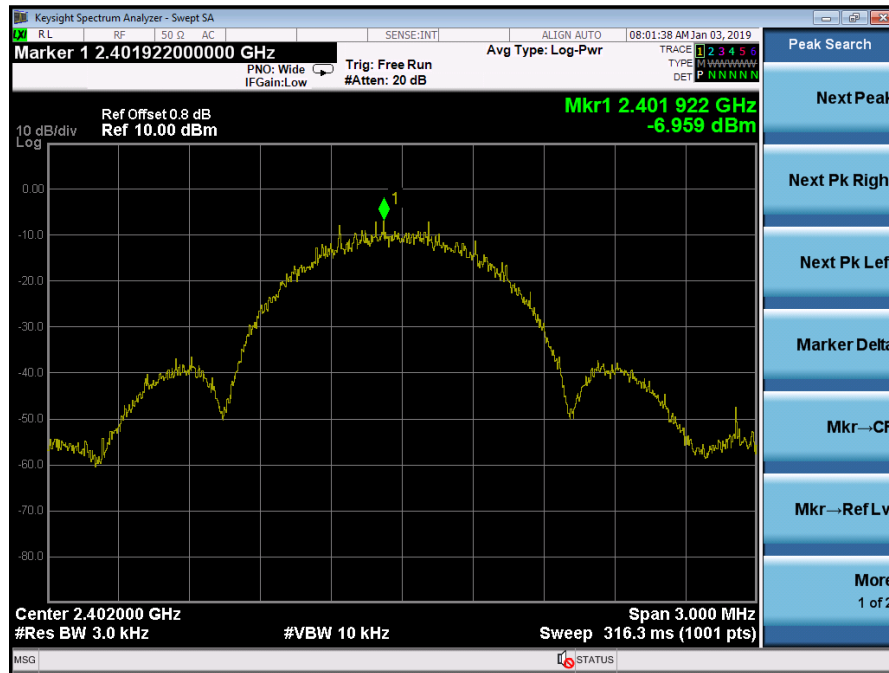

Middle Channel

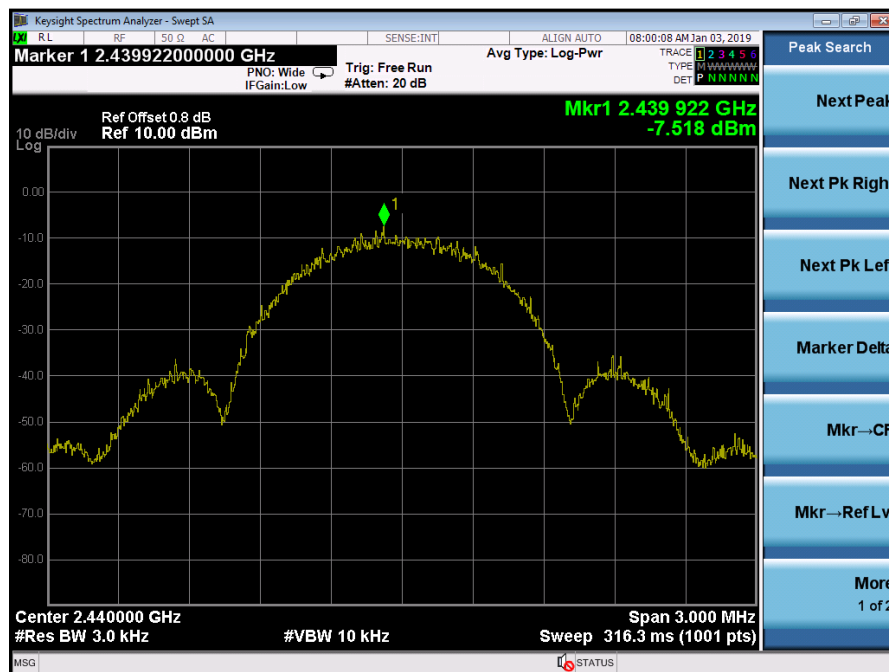

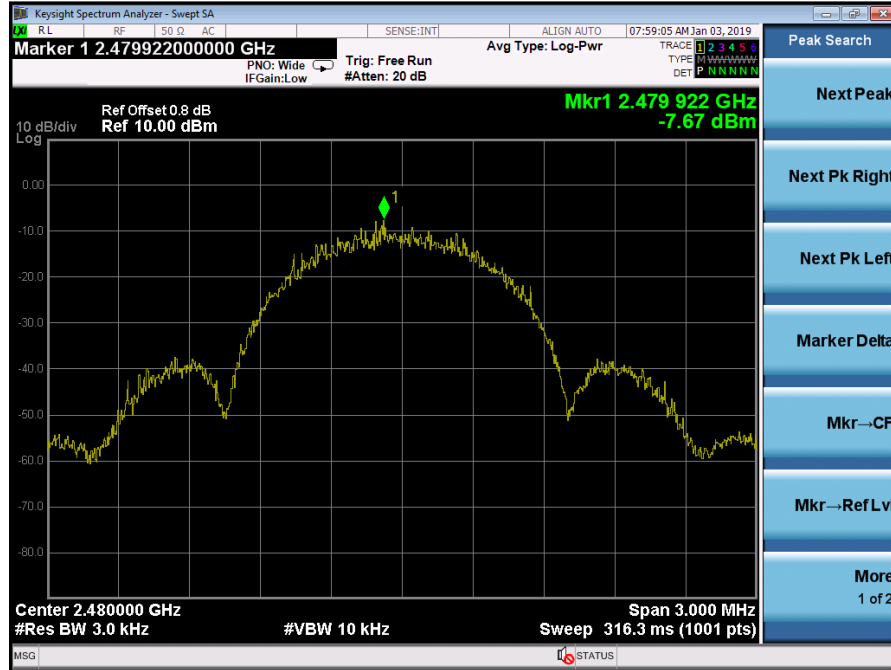
High Channel

5.1.5 Conducted spurious emissions and Frequency Band Edge measured in 100kHz Bandwidth

RESULT:**Passed**

Test standard	:	LP0002(2018): 3.10.1, (5) FCC part 15.247(d), RSS-247 5.5
Basic standard	:	ANSI C63.10:2013, KDB558074
Limit	:	20dB (below that in the 100kHz bandwidth within the band that contains the highest level of the desired power)
Kind of test site	:	Shielded room

Test setup

Test Channel	:	Low/ Middle/ High for Conducted Spurious Emissions Low/ High for Frequency Band Edge
Operation Mode	:	A
Ambient temperature	:	20-24°C
Relative humidity	:	50-65%
Atmospheric pressure	:	100-103 kPa

All emissions are more than 20dB below fundamental, details refer to following test plot, and compliance is achieved as well.

Due to the small size of the product and that there are no inductive components of significant size, 9kHz to 30MHz frequency range is not tested based on technical judgment.

Test Plot 100kHz RBW of Band Edge

Low Channel

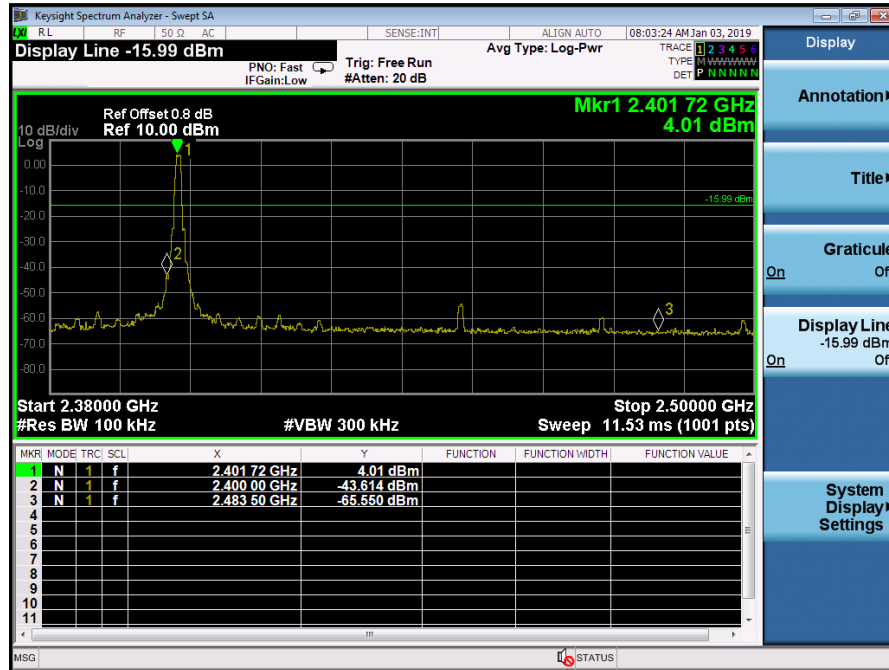

High Channel

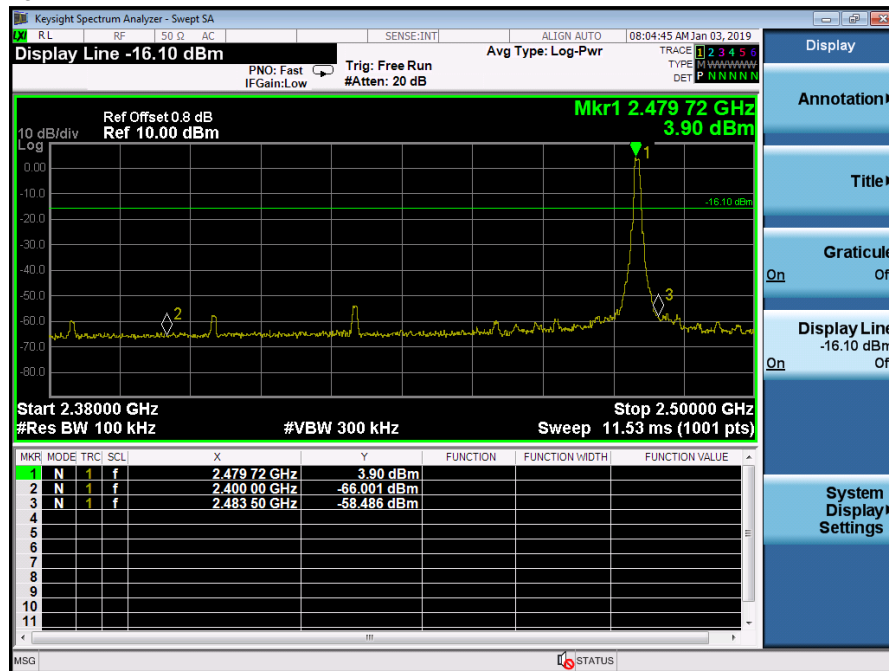

5.1.6 Spurious Emission

RESULT:**Passed**

Test standard	:	FCC part 15.247(d), FCC 15.205, FCC 15.209 and RSS-Gen 8.9
Basic standard	:	LP0002(2018): 3.10.1, (5)
Limits	:	ANSI C63.10: 2013
	:	Radiated emissions which fall in the restricted bands, as defined in FCC 15.205(a) and RSS-Gen i5, 8.10 (Table 7), must comply with the radiated emission limits specified in FCC 15.209(a) and RSS-Gen 5, 8.9 (Table 5 and 6). Radiated emissions which fall in the restricted bands, as defined in LP0002(2018): 2.7, must comply with the radiated emission limits specified in LP0002(2018): 2.8
	:	Emission radiated outside the restricted and authorized frequency bands must either comply with the radiated emission limits specified for the restricted bands or in FCC15.247(d) and RSS-247 i2, 5.5
	:	Emission radiated outside the specified frequency bands must comply with the radiated emission limits specified in LP0002(2018): 2.8
Kind of test site	:	3m Semi-Anechoic Chamber

Test setup

Test Channel	:	Low/ Middle/ High
Operation mode	:	A, B
Ambient temperature	:	20-24 °C
Relative humidity	:	50-65 %
Atmospheric pressure	:	100-103 kPa

Remark: Testing was carried out within frequency range 30MHz to the tenth harmonic.

For details refer to Appendix D.

Testing was carried out within frequency range 30MHz to the tenth harmonic. For details refer to Appendix D. The Radiated Emissions testing was performed in the X, Y and Z axis orientation. The worst-case Axis orientation is recorded in this test report. Due to the small size of the product and that there are no inductive components of significant size, 9kHz to 30MHz frequency range is not tested based on technical judgment.

5.2 Mains Emissions

5.2.1 Mains Conducted Emissions

RESULT: **Passed**

Test standard	:	FCC Part 15.207 FCC Part 15.107 RSS-Gen 8.8 LP0002: 2.3
Limits	:	Mains Conducted emissions as defined in above test standards must comply with the mains conducted emission limits specified
Kind of test site	:	Shielded Room

Test setup

Test Channel	:	Normal link
Operation mode	:	Normal link
Ambient temperature	:	20-24 °C
Relative humidity	:	50-65 %
Atmospheric pressure	:	100-103 kPa

Remark: For details refer to Appendix D.

6. Safety Human exposure

6.1 Radio Frequency Exposure Compliance

6.1.1 Electromagnetic Fields

RESULT:**Passed**

Test standard : FCC KDB Publication 447498 D01
RSS-102 issue 5, Table 1

FCC:

Since maximum peak output power of the transmitter is 2.5293 mW < 10mW, hence the EUT is excluded from SAR evaluation according to FCC KDB publication 447498: Mobile Portable RF Exposure

7. Photographs of the Test Set-Up

Photograph 1: Set-up for Spurious Emissions (Front View)

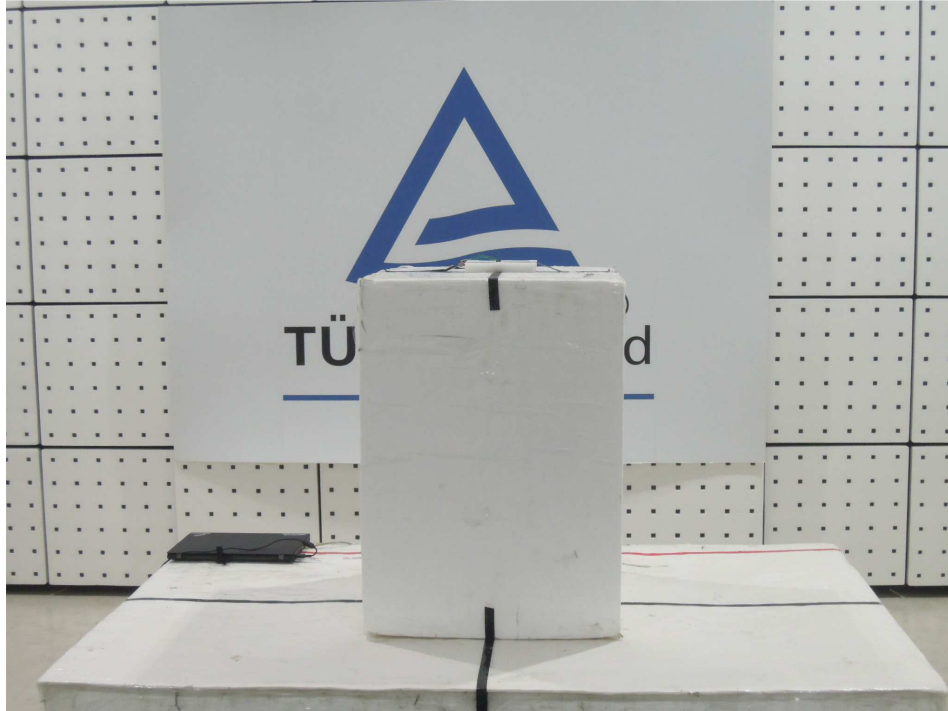

Photograph 2: Set-up for Spurious Emissions (Back View 1)

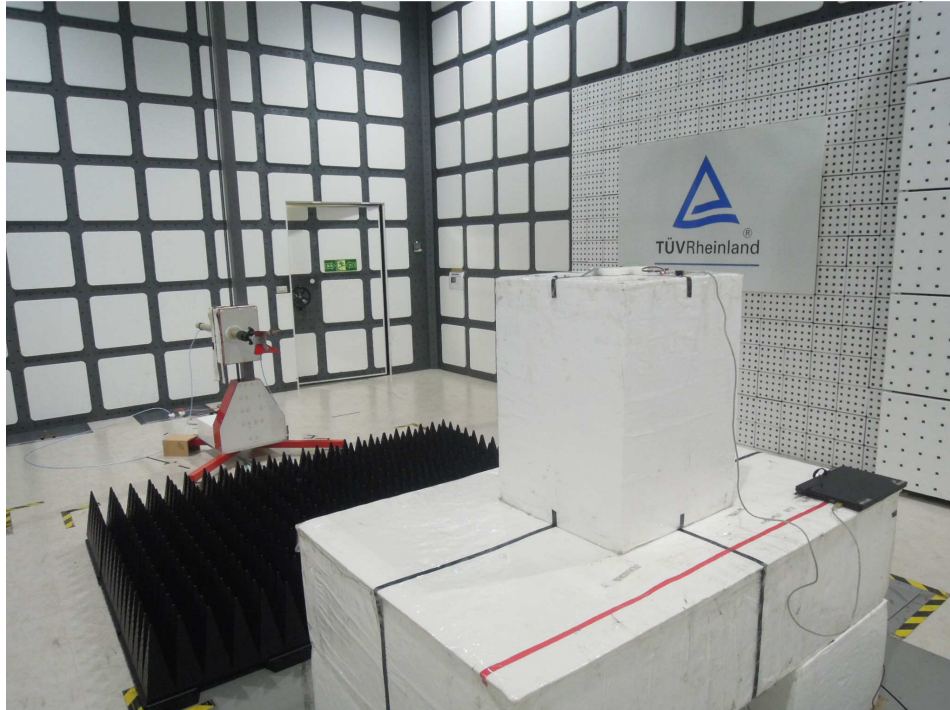

Photograph 3: Set-up for Spurious Emissions (Back View 2)

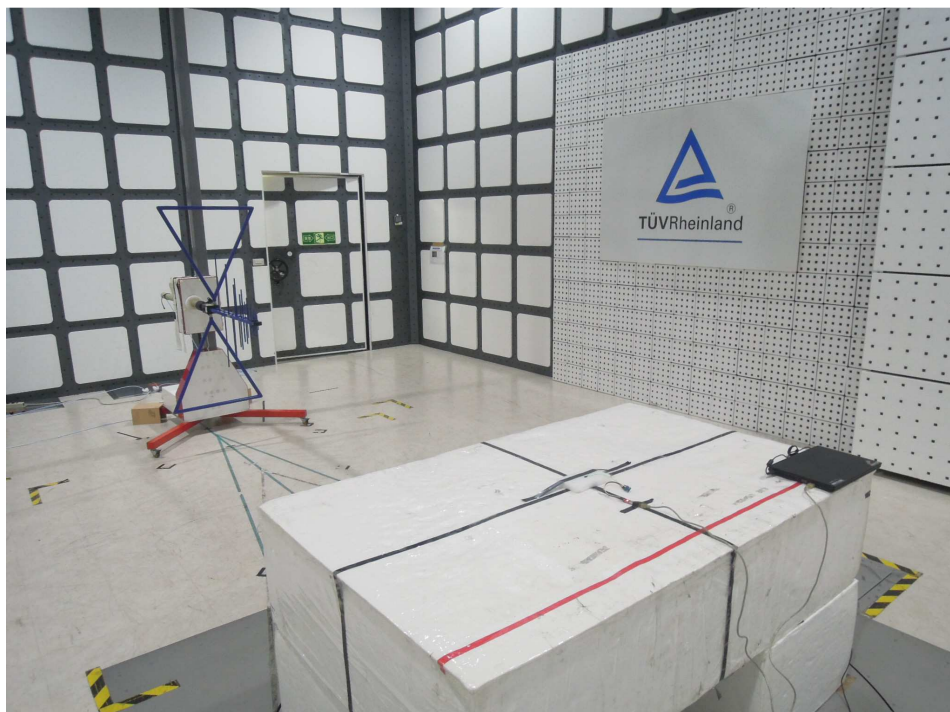

Photograph 4: Set-up for Conducted testing

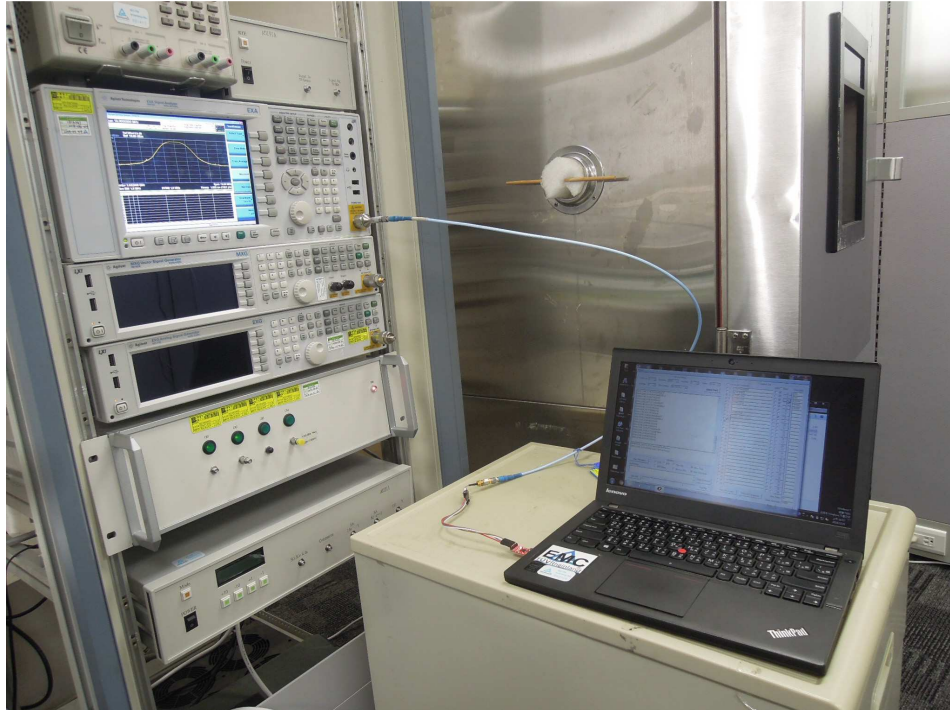

Photograph 5: Set-up for for Mains Conducted testing Back

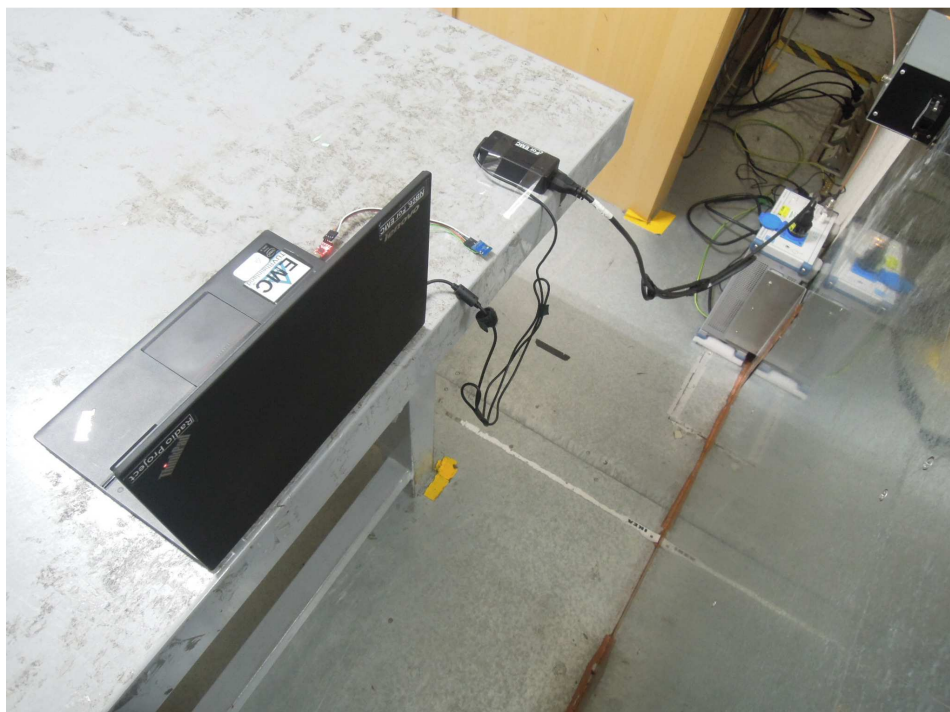

Photograph 6: Set-up for for Mains Conducted testing Front



8. List of Tables

Table 1: Applied Standard and Test Levels	5
Table 2: List of Test and Measurement Equipment	7
Table 3: Emission Measurement Uncertainty.....	8
Table 4: Basic Information of EUT	9
Table 5: Technical Specification of EUT	9
Table 6: Test result of Peak Output Power	15
Table 7: Test result of 6dB Bandwidth	16
Table 8: Test result of 99% Bandwidth,.....	16
Table 9: Test result of Power Density	19

9. List of Photographs

Photograph 1: Set-up for Spurious Emissions (Front View).....	29
Photograph 2: Set-up for Spurious Emissions (Back View 1)	30
Photograph 3: Set-up for Spurious Emissions (Back View 2)	30
Photograph 4: Set-up for Conducted testing	31
Photograph 5: Set-up for for Mains Conducted testing Back	31
Photograph 6: Set-up for for Mains Conducted testing Front.....	32