



**FCC 47 CFR PART 15 SUBPART C AND ANSI C63.10:2009  
TEST REPORT**

**For**

**2.4GHz Multimedia Keyboard with Laser Trackball and Scroll Wheel**

**Model : GKM561RB**

**Trade Name : IOGEAR**

**Issued for**

**ATEN Technology, Inc., dba IOGEAR**

**19641 Da Vinci, Foothill Ranch, CA 92610, United States**

**Issued by**

**Compliance Certification Services Inc.  
Hsinchu Lab.**

**NO. 989-1 Wen Shan Rd., Shang Shan Village,  
Qionglin Shiang Hsinchu County 30741, Taiwan, R.O.C**

**TEL: +886-3-5921698**

**FAX: +886-3-5921108**

**<http://www.ccsrf.com>**

**E-Mail : [service@ccsrf.com](mailto:service@ccsrf.com)**

**Issued Date: September 12, 2014**



**Note:** *This report shall not be reproduced except in full, without the written approval of Compliance Certification Services Inc. This document may be altered or revised by Compliance Certification Services Inc. personnel only, and shall be noted in the revision section of the document. The client should not use it to claim product endorsement by TAF or any government agencies. The test results of this report relate only to the tested sample identified in this report.*



### Revision History

Rev.	Issue Date	Revisions	Effect Page	Revised By
00	09/12/2014	Initial Issue	All Page 30	Gloria Chang



**TABLE OF CONTENTS**

<b>TITLE</b>	<b>PAGE NO.</b>
<b>1. TEST REPORT CERTIFICATION .....</b>	<b>4</b>
<b>2. EUT DESCRIPTION .....</b>	<b>5</b>
<b>3. DESCRIPTION OF TEST MODES .....</b>	<b>6</b>
<b>4. TEST METHODOLOGY .....</b>	<b>7</b>
<b>5. FACILITIES AND ACCREDITATION .....</b>	<b>7</b>
5.1 FACILITIES .....	7
5.2 ACCREDITATIONS.....	7
5.3 MEASUREMENT UNCERTAINTY .....	8
<b>6. SETUP OF EQUIPMENT UNDER TEST.....</b>	<b>9</b>
<b>7. FCC PART 15.249 REQUIREMENTS .....</b>	<b>10</b>
7.1 20 dB BANDWIDTH .....	10
7.2 RADIATED EMISSION.....	14
7.3 CONDUCTED EMISSION.....	27
<b>APPENDIX SETUP PHOTOS .....</b>	<b>30</b>



# 1. TEST REPORT CERTIFICATION

**Applicant** : ATEN Technology, Inc., dba IOGEAR  
**Address** : 19641 Da Vinci, Foothill Ranch, CA 92610, United States  
**Equipment Under Test** : 2.4GHz Multimedia Keyboard with Laser Trackball and Scroll Wheel  
**Model** : GKM561RB  
**Trade Name** : IOGEAR  
**Tested Date** : June 25 ~ August 14, 2014

APPLICABLE STANDARD	
Standard	Test Result
FCC Part 15 Subpart C AND ANSI C63.10:2009	PASS

WE HEREBY CERTIFY THAT: The above equipment has been tested by Compliance Certification Services Inc., and found compliance with the requirements set forth in the technical standards mentioned above. The results of testing in this report apply only to the product/system, which was tested. Other similar equipment will not necessarily produce the same results due to production tolerance and measurement uncertainties.

**Approved by:**

Sb. Lu  
Sr. Engineer

**Reviewed by:**

Gundam Lin  
Sr. Engineer



## 2. EUT DESCRIPTION

<b>Product Name</b>	2.4GHz Multimedia Keyboard with Laser Trackball and Scroll Wheel
<b>Model Number</b>	GKM561RB
<b>Identify Number</b>	T140825D15
<b>Received Date</b>	June 25, 2014
<b>Frequency Range</b>	2408MHz ~ 2474MHz
<b>Transmit Power</b>	98.17 dBuV/m
<b>Channel Spacing</b>	2 MHz
<b>Channel Number</b>	34 Channels
<b>Type of Modulation</b>	GFSK
<b>Antenna Type</b>	Printed Antenna, Antenna Gain : 0.78802 dBi
<b>Power Rating</b>	3Vdc
<b>Test Voltage</b>	3Vdc

**Remark :**

1. The sample selected for test was engineering sample that approximated to production product and was provided by manufacturer.
2. For more details, please refer to the User's manual of the EUT.
3. This submittal(s) (test report) is intended for FCC ID: QLEKMGKM561RB filing to comply with Section 15.207, 15.209 and 15.249 of the FCC Part 15, Subpart C Rules.
4. This report is transferred from T140625D02-RP1.



### 3. DESCRIPTION OF TEST MODES

The EUT (GKM561RB) had been tested under operating condition.

There are three channels have been tested as following :

Channel	Frequency (MHz)
Low	2408
Middle	2440
High	2474

#### Radiated Emission (Below 1 GHz) and Conducted Emission Test:

1. The following test modes were scanned during the preliminary test:

No.	Pre-Test Mode
1	TX Mode

2. After the preliminary scan, the following test mode was found to produce the highest emission level.

Final Test Mode		
Emission	Radiated Emission	TX Mode
	Conducted Emission	N/A

**Remark :** Then, the above highest emission mode of the configuration of the EUT and cable was chosen for all final test items.

#### Radiated Emission Test (Above 1 GHz):

Pre-Scan has been conducted to determine the worst-case mode from all possible combinations between available modulations, data rates and antenna ports (if EUT with antenna diversity architecture).

Following channel(s) was (were) selected for the final test as listed below.

Channel	Frequency (MHz)
Low	2408
Middle	2440
High	2474

#### Bandedge Measurement :

Pre-Scan has been conducted to determine the worst-case mode from all possible combinations between available modulations, data rates and antenna ports (if EUT with antenna diversity architecture).

Following channel(s) was (were) selected for the final test as listed below.

Channel	Frequency (MHz)
Low	2408
High	2474



## 4. TEST METHODOLOGY

The tests documented in this report were performed in accordance with ANSI C63.10: 2009 and FCC CFR 47, 15.207, 15.209 and 15.249.

## 5. FACILITIES AND ACCREDITATION

### 5.1 FACILITIES

All measurement facilities used to collect the measurement data are located at

NO. 989-1 Wen Shan Rd., Shang Shan Village,  
Qionglin Shiang Hsinchu County 30741, Taiwan, R.O.C

The sites are constructed in conformance with the requirements of ANSI C63.10:2009 and CISPR 22. All receiving equipment conforms to CISPR 16-1-1, CISPR 16-1-2, CISPR 16-1-3, CISPR 16-1-4, CISPR 16-1-5.

### 5.2 ACCREDITATIONS

Our laboratories are accredited and approved by the following approval agencies according to ISO/IEC 17025.

<b>Taiwan</b>	TAF
---------------	-----

The measuring facility of laboratories has been authorized or registered by the following approval agencies.

<b>Canada</b>	INDUSTRY CANADA
<b>Japan</b>	VCCI
<b>Taiwan</b>	BSMI
<b>USA</b>	FCC MRA

Copies of granted accreditation certificates are available for downloading from our web site, <http://www.ccsrf.com>

**Remark:** FCC Designation Number TW1027.



### 5.3 MEASUREMENT UNCERTAINTY

The following table is for the measurement uncertainty, which is calculated as per the document CISPR 16-4-2.

PARAMETER	UNCERTAINTY
Semi Anechoic Chamber (966 Chamber_B) / Radiated Emission, 30 to 1000 MHz	+/- 3.97
Semi Anechoic Chamber (966 Chamber_B) / Radiated Emission, 1 to 18GHz	+/- 3.58
Semi Anechoic Chamber (966 Chamber_B) / Radiated Emission, 18 to 26 GHz	+/- 3.59
Semi Anechoic Chamber (966 Chamber_B) / Radiated Emission, 26 to 40 GHz	+/- 3.81
Conducted Emission (Mains Terminals), 9kHz to 30MHz	+/- 2.48

This uncertainty represents an expanded uncertainty expressed at approximately the 95% confidence level using a coverage factor of k=2.

Consistent with industry standard (e.g. CISPR 22, clause 11, Measurement Uncertainty) determining compliance with the limits shall be base on the results of the compliance measurement. Consequently the measure emissions being less than the maximum allowed emission result in this be a compliant test or passing test.

The acceptable measurement uncertainty value without requiring revision of the compliance statement is base on conducted and radiated emissions being less than  $U_{CISPR}$  which is 3.6dB and 5.2dB respectively. CCS values (called  $U_{Lab}$  in CISPR 16-4-2) is less than  $U_{CISPR}$  as shown in the table above. Therefore, MU need not be considered for compliance.





## **6. SETUP OF EQUIPMENT UNDER TEST**

### **SUPPORT EQUIPMENT**

N/A

### **SETUP DIAGRAM FOR TESTS**

EUT & peripherals setup diagram is shown in appendix setup photos.

### **EUT OPERATING CONDITION**

1. EUT & peripherals setup diagram is shown in appendix setup photos.
2. Power on all equipments.  
TX Mode: Frequency:2408MHz、 2440MHz、 2474MHz
3. All of the functions are under run.
4. Start test.



## 7. FCC PART 15.249 REQUIREMENTS

### 7.1 20 dB BANDWIDTH

#### LIMITS

None; for reporting purposes only.

#### TEST EQUIPMENT

##### 966Chamber\_B

Name of Equipment	Manufacture	Model	Serial Number	Calibration Due
Spectrum Analyzer	Agilent	E4446A	MY46180323	04/15/2015
EMI Test Receiver	ROHDE & SCHWARZ	ESCS 30	835418/008	10/16/2014
Bi-log Antenna	SCHWARZBECK	VULB 9168	9168-250	09/12/2014
Double-Ridged Waveguide Horn	ETS-LINDGREN	3117	00078733	12/05/2014
Horn Antenna	COM-POWER	AH-840	03077	12/18/2014
Pre-Amplifier	Agilent	8447D	2944A10052	07/15/2015
Pre-Amplifier	Agilent	8449B	3008A01916	07/15/2015
LOOP Antenna	EMCO	6502	8905-2356	08/20/2014
Notch Filters Band Reject	Micro-Tronics	BRM05702-01	026	N.C.R

**Remark:** 1. Each piece of equipment is scheduled for calibration once a year.

2. N.C.R = No Calibration Request.



**TEST SETUP**

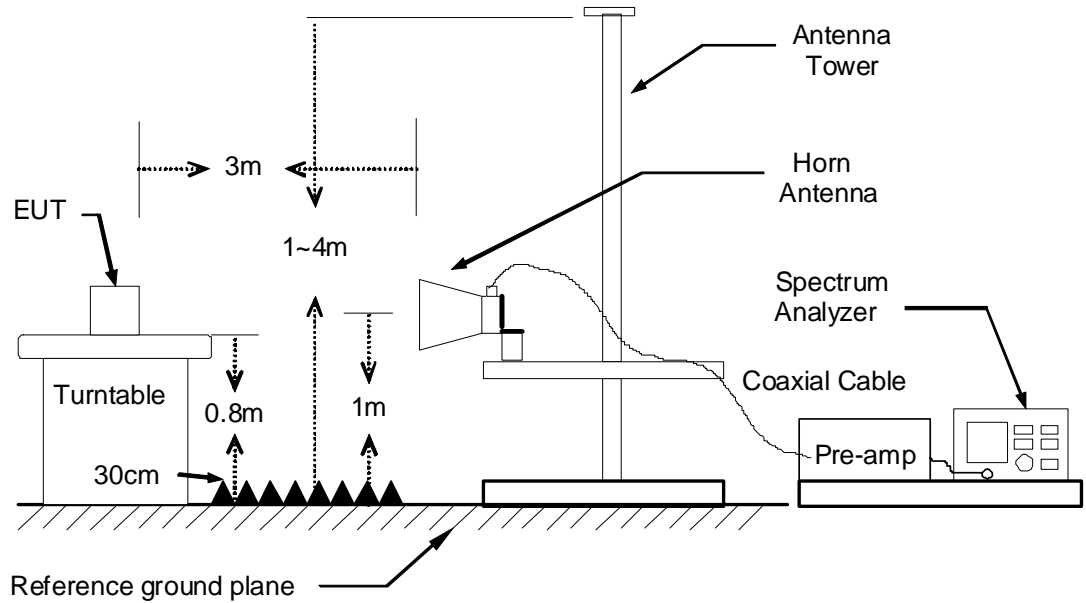

**TEST PROCEDURE**

The 20dB band width was measured with a spectrum analyzer connected to RF antenna connector (conducted measurement) while EUT was operating in transmit mode at the appropriate center frequency. The analyzer center frequency was set to the EUT carrier frequency, using the analyzer. Display Line and Marker Delta functions, the 20dB band width of the emission was determined.

**TEST RESULTS**

Channel Frequency (MHz)	20dB Bandwidth (kHz)
2408	0.394
2440	0.394
2474	0.396



**20dB BANDWIDTH**

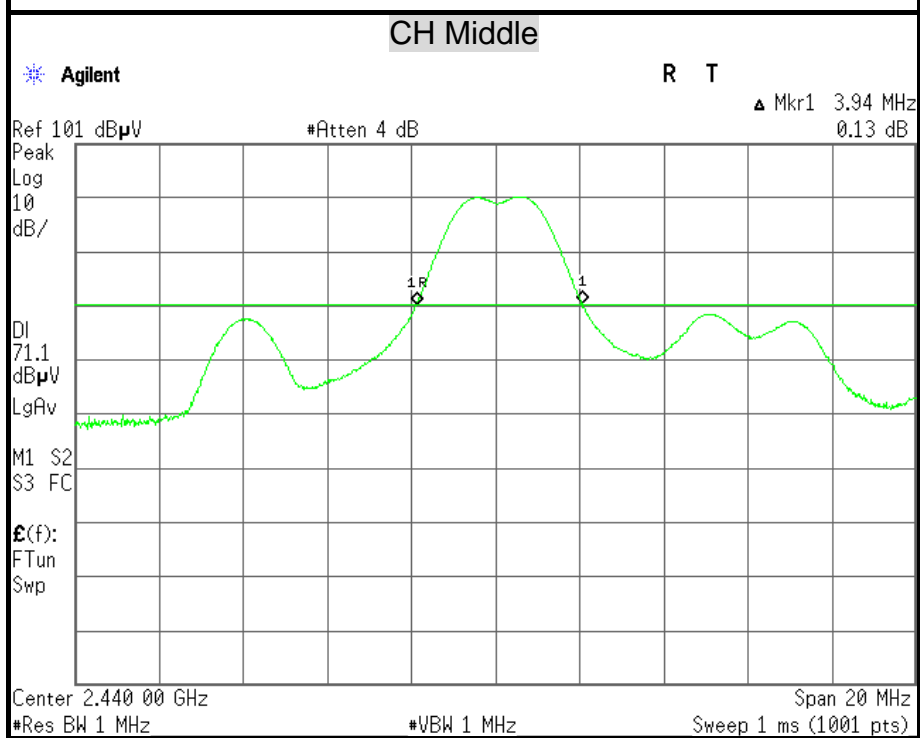
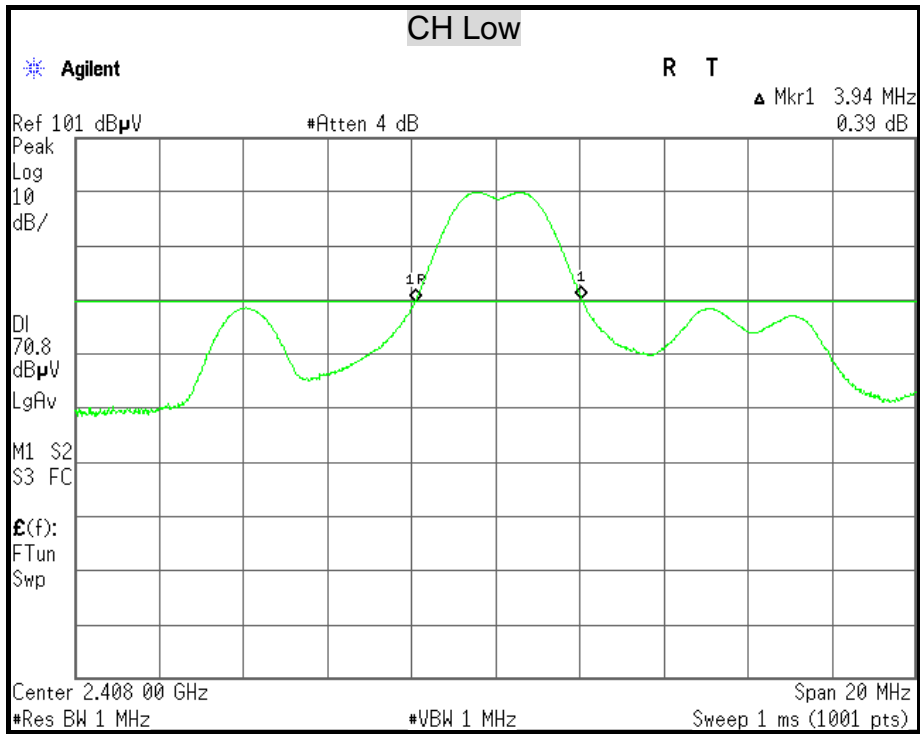

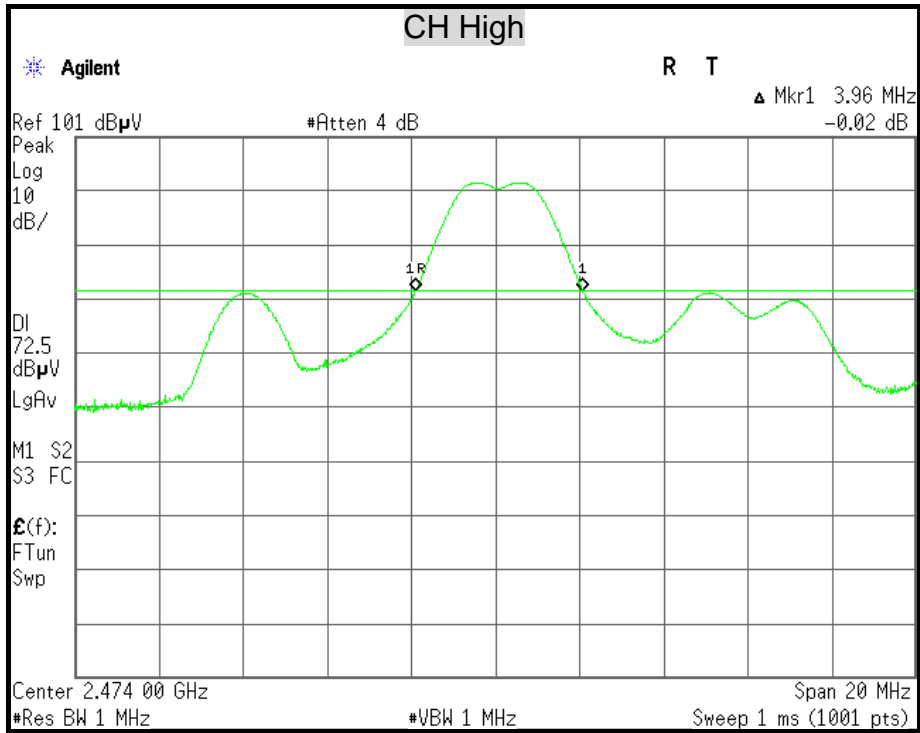



### 7.2 RADIATED EMISSION

#### LIMITS

(1) According to § 15.205 (a) Except as shown in paragraph (d) of this section, only spurious emissions are permitted in any of the frequency bands listed below:

MHz	MHz	MHz	GHz
0.090 - 0.110	16.42 - 16.423	399.9 - 410	4.5 - 5.15
<sup>1</sup> 0.495 - 0.505	16.69475 - 16.69525	608 - 614	5.35 - 5.46
2.1735 - 2.1905	16.80425 - 16.80475	960 - 1240	7.25 - 7.75
4.125 - 4.128	25.5 - 25.67	1300 - 1427	8.025 - 8.5
4.17725 - 4.17775	37.5 - 38.25	1435 - 1626.5	9.0 - 9.2
4.20725 - 4.20775	73 - 74.6	1645.5 - 1646.5	9.3 - 9.5
6.215 - 6.218	74.8 - 75.2	1660 - 1710	10.6 - 12.7
6.26775 - 6.26825	108 - 121.94	1718.8 - 1722.2	13.25 - 13.4
6.31175 - 6.31225	123 - 138	2200 - 2300	14.47 - 14.5
8.291 - 8.294	149.9 - 150.05	2310 - 2390	15.35 - 16.2
8.362 - 8.366	156.52475 - 156.52525	2483.5 - 2500	17.7 - 21.4
8.37625 - 8.38675	156.7 - 156.9	2655 - 2900	22.01 - 23.12
8.41425 - 8.41475	162.0125 - 167.17	3260 - 3267	23.6 - 24.0
12.29 - 12.293	167.72 - 173.2	3332 - 3339	31.2 - 31.8
12.51975 - 12.52025	240 - 285	3345.8 - 3338	36.43 - 36.5
12.57675 - 12.57725	322 - 335.4	3600 - 4400	( <sup>2</sup> )
13.36 - 13.41			

**Remark:**

- 1. <sup>1</sup> Until February 1, 1999, this restricted band shall be 0.490-0.510 MHz.
- 2. <sup>2</sup> Above 38.6

(2) According to § 15.205 (b) Except as provided in paragraphs (d) and (e), the field strength of emissions appearing within these frequency bands shall not exceed the limits shown in Section 15.209. At frequencies equal to or less than 1000 MHz, compliance with the limits in Section 15.209 shall be demonstrated using measurement instrumentation employing a CISPR quasi-peak detector. Above 1000 MHz, compliance with the emission limits in Section 15.209 shall be demonstrated based on the average value of the measured emissions. The provisions in Section 15.35 apply to these measurements.



(3) According to § 15.209 (a) Except as provided elsewhere in this Subpart, the emissions from an intentional radiator shall not exceed the field strength levels specified in the following table :

Frequency (MHz)	Field Strength (microvolts/meter)	Measurement Distance (meters)
0.009 - 0.490	2400/F(KHz)	300
0.490 - 1.705	24000/F(KHz)	30
1.705 - 30.0	30	30
30 - 88	100 **	3
88 - 216	150 **	3
216 - 960	200 **	3
Above 960	500	3

**Remark:** \*\*Except as provided in paragraph (g), fundamental emissions from intentional radiators operating under this Section shall not be located in the frequency bands 54-72 MHz, 76-88 MHz, 174-216 MHz or 470-806 MHz. However, operation within these frequency bands is permitted under other sections of this Part, e.g., Sections 15.231 and 15.241.

(4) According to § 15.209 (b) In the emission table above, the tighter limit applies at the band edges.

(5) According to § 15.249 (a) Except as provided in paragraph (b) of this section, the field strength of emission from intentional radiators operated within these frequency bands shall comply with the following:

Fundamental Frequency (MHz)	Field Strength of Fundamental (millivolts/meter)	Measurement Distance of Harmonics (microvolts/meter)
902 - 928	50	500
2400 - 2483.5	50	500
5725 - 5875	50	500
24000 - 24250	250	2500



**TEST EQUIPMENT**

**966Chamber\_B**

Name of Equipment	Manufacture	Model	Serial Number	Calibration Due
Spectrum Analyzer	Agilent	E4446A	MY46180323	04/15/2015
EMI Test Receiver	ROHDE & SCHWARZ	ESCS 30	835418/008	10/16/2014
Bi-log Antenna	SCHWARZBECK	VULB 9168	9168-250	09/12/2014
Double-Ridged Waveguide Horn	ETS-LINDGREN	3117	00078733	12/05/2014
Horn Antenna	COM-POWER	AH-840	03077	12/18/2014
Pre-Amplifier	Agilent	8447D	2944A10052	07/15/2015
Pre-Amplifier	Agilent	8449B	3008A01916	07/15/2015
LOOP Antenna	EMCO	6502	8905-2356	08/20/2014
Notch Filters Band Reject	Micro-Tronics	BRM05702-01	026	N.C.R

**Remark:** 1. Each piece of equipment is scheduled for calibration once a year.  
 2. N.C.R = No Calibration Request.

**TEST SETUP**

The diagram below shows the test setup that is utilized to make the measurements for emission from below 1GHz.

**9kHz ~ 30MHz**

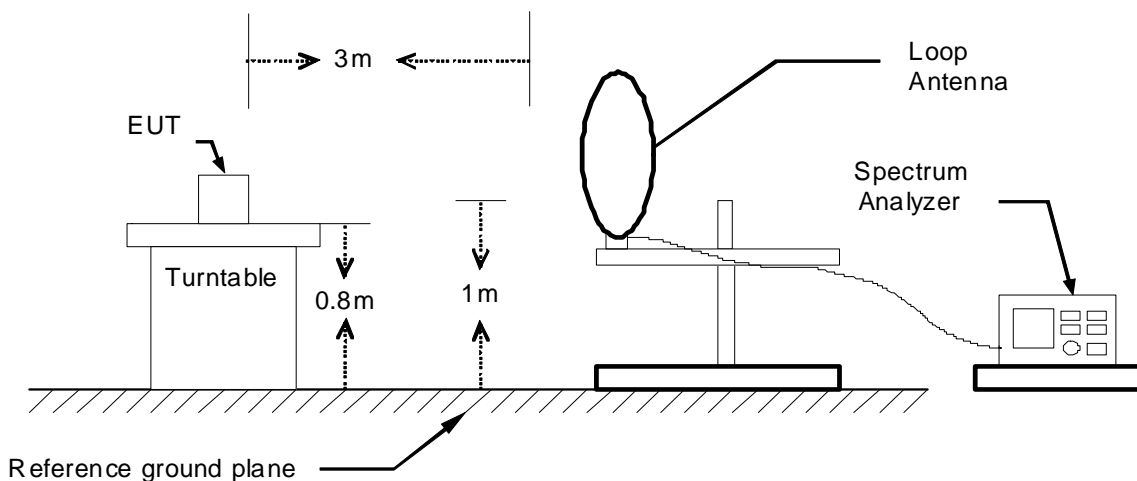





30MHz ~ 1GHz

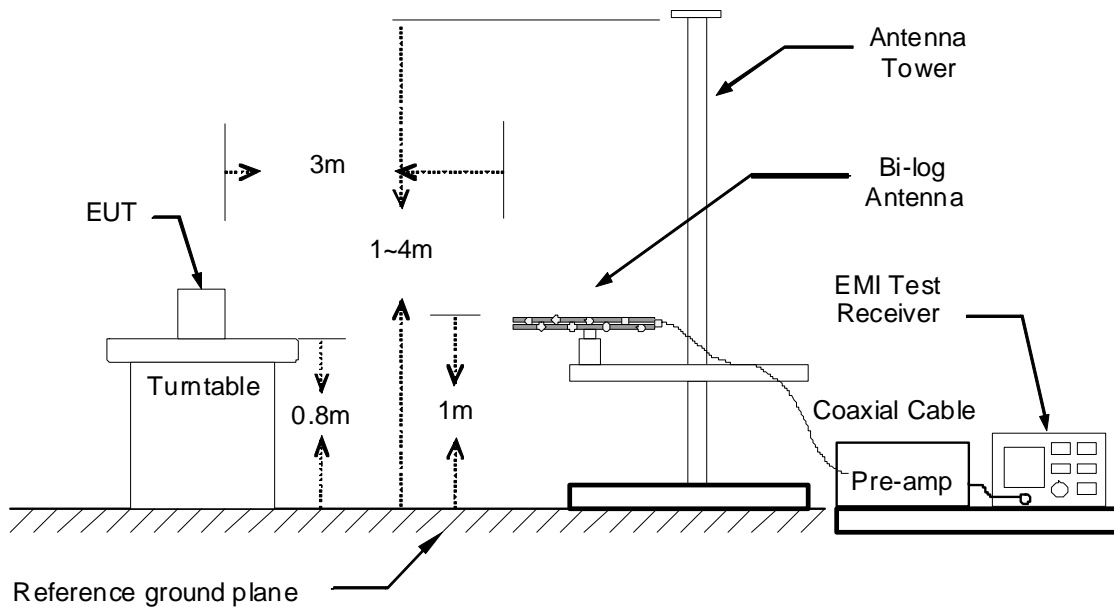

The diagram below shows the test setup that is utilized to make the measurements for emission above 1GHz.

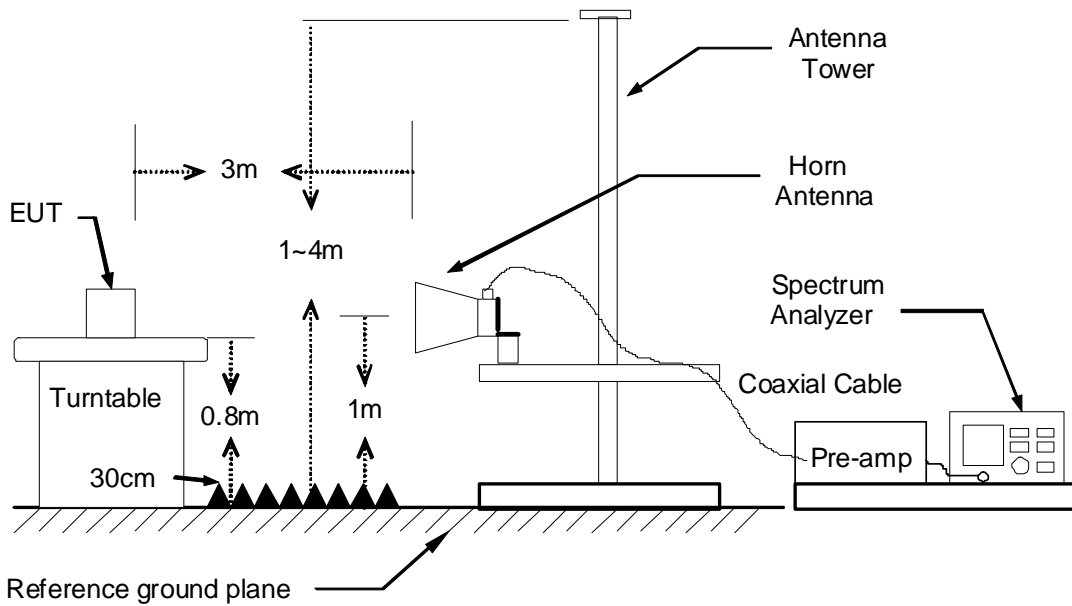



**TEST PROCEDURE**

1. The EUT was placed on the top of a rotating table 0.8 meters above the ground. The table was rotated 360 degrees to determine the position of the highest radiation.
2. While measuring the radiated emission below 1GHz, the EUT was set 3 meters away from the interference-receiving antenna, which was mounted on the top of a variable-height antenna tower. While measuring the radiated emission above 1GHz, the EUT was set 3 meters away from the interference-receiving antenna.
3. The antenna is a broadband antenna, and its height is varied from one meter to four meters above the ground to determine the maximum value of the field strength. Both horizontal and vertical polarization of the antenna are set to make the measurement.
4. For each suspected emission, the EUT was arranged to its worst case and then the antenna was tuned to heights from 1 meter to 4 meters and the table was turned from 0 degrees to 360 degrees to find the maximum reading.
5. The test-receiver system was set to Peak Detect Function and Specified Bandwidth with Maximum Hold Mode.
6. If the emission level of the EUT in peak mode was 10 dB lower than the limit specified, then testing could be stopped and the peak values of the EUT would be reported. Otherwise the emissions that did not have 10 dB margin would be re-tested one by one using peak, quasi-peak or average method as specified and then reported in a data sheet.

**Remark :**

1. *The resolution bandwidth and video bandwidth of test receiver/spectrum analyzer is 120 KHz for Peak detection (PK) and Quasi-peak detection (QP) at frequency below 1GHz.*
2. *The resolution bandwidth and video bandwidth of test receiver/spectrum analyzer is 1 MHz for Peak detection and frequency above 1GHz.*
3. *The resolution bandwidth of test receiver/spectrum analyzer is 1 MHz and the video bandwidth is 10 Hz for Average detection (AV) at frequency above 1GHz.*



**TEST RESULTS**

**Below 1 GHz (9kHz ~ 30MHz)**

No emission found between lowest internal used/generated frequency to 30MHz.

**Below 1 GHz (30MHz ~ 1GHz)**

<b>Product Name</b>	2.4GHz Multimedia Keyboard with Laser Trackball and Scroll Wheel	<b>Test By</b>	Rueyyan Lin
<b>Test Model</b>	GKM561RB	<b>Test Date</b>	2014/08/12
<b>Test Mode</b>	TX Mode	<b>Temp. &amp; Humidity</b>	30°C, 45%

966 Chamber_B at 3Meter / Horizontal						
Frequency (MHz)	Reading (dBµV)	Correction Factor (dB/m)	Result (dBµV/m)	Limit (dBµV/m)	Margin (dB)	Remark
30.97	38.17	-15.38	22.80	40.00	-17.20	Peak
167.74	49.23	-13.89	35.34	43.50	-8.16	Peak
299.66	47.81	-11.92	35.89	46.00	-10.11	Peak
384.05	43.93	-10.24	33.70	46.00	-12.30	Peak
755.56	44.92	-3.52	41.40	46.00	-4.60	Peak
779.81	44.74	-3.28	41.45	46.00	-4.55	Peak

966 Chamber_B at 3Meter / Vertical						
Frequency (MHz)	Reading (dBµV)	Correction Factor (dB/m)	Result (dBµV/m)	Limit (dBµV/m)	Margin (dB)	Remark
33.88	41.29	-15.16	26.14	40.00	-13.86	Peak
102.75	49.83	-18.28	31.55	43.50	-11.95	Peak
295.78	44.37	-12.00	32.37	46.00	-13.63	Peak
400.54	39.55	-9.92	29.63	46.00	-16.37	Peak
755.56	37.74	-3.52	34.23	46.00	-11.77	Peak
954.41	36.39	-0.51	35.88	46.00	-10.12	Peak

**Remark:**

1. Quasi-peak test would be performed if the peak result were greater than the quasi-peak limit.
2. Data of measurement within this frequency range shown " --- " in the table above means the reading of emissions are attenuated more than 20dB below the permissible limits or the field strength is too small to be measured.
3. Correction Factor (dB/m) = Antenna Factor (dB/m) + Cable Loss (dB) – PreAmp.Gain (dB)
4. Result (dBµV/m) = Reading (dBµV) + Correction Factor (dB/m)
5. Margin (dB) = Remark result (dBµV/m) - Quasi-peak limit (dBµV/m).



TX Above 1 GHz

<b>Product Name</b>	2.4GHz Multimedia Keyboard with Laser Trackball and Scroll Wheel	<b>Test By</b>	Rueyyan Lin
<b>Test Model</b>	GKM561RB	<b>Test Date</b>	2014/06/28
<b>Test Mode</b>	GFSK TX / CH Low	<b>Temp. &amp; Humidity</b>	30°C, 58%

966 Chamber_B at 3Meter / Horizontal									
Frequency (MHz)	Reading-PK (dBuV)	Reading-AV (dBuV)	Correction Factor (dB/m)	Result-PK (dBuV/m)	Result-AV (dBuV/m)	Limit-PK (dBuV/m)	Limit-AV (dBuV/m)	Margin (dB)	Remark
1176.00	44.89	---	-2.89	42.01	---	74.00	54.00	-11.99	Peak
1274.00	45.02	---	-2.89	42.13	---	74.00	54.00	-11.87	Peak
2408.00	90.16	87.82	2.63	92.79	90.45	114.00	94.00	-3.55	AVG
2558.00	46.01	---	2.96	48.97	---	74.00	54.00	-5.03	Peak
2708.00	43.37	---	3.34	46.71	---	74.00	54.00	-7.29	Peak
3435.00	42.50	---	4.44	46.94	---	74.00	54.00	-7.06	Peak
4815.00	43.31	---	8.06	51.36	---	74.00	54.00	-2.64	Peak
7230.00	42.03	31.67	12.84	54.87	44.51	74.00	54.00	-9.49	AVG

966 Chamber_B at 3Meter / Vertical									
Frequency (MHz)	Reading-PK (dBuV)	Reading-AV (dBuV)	Correction Factor (dB/m)	Result-PK (dBuV/m)	Result-AV (dBuV/m)	Limit-PK (dBuV/m)	Limit-AV (dBuV/m)	Margin (dB)	Remark
1048.00	45.31	---	-2.88	42.43	---	74.00	54.00	-11.57	Peak
1268.00	45.47	---	-2.89	42.58	---	74.00	54.00	-11.42	Peak
2408.00	92.10	86.61	2.63	94.73	89.24	114.00	94.00	-4.76	AVG
2558.00	47.98	---	2.96	50.93	---	74.00	54.00	-3.07	Peak
2708.00	45.43	---	3.34	48.77	---	74.00	54.00	-5.23	Peak
3570.00	41.97	---	4.68	46.65	---	74.00	54.00	-7.35	Peak
4140.00	40.72	---	6.29	47.01	---	74.00	54.00	-6.99	Peak
4815.00	41.82	---	8.06	49.88	---	74.00	54.00	-4.12	Peak
7230.00	41.80	35.45	12.84	54.64	48.29	74.00	54.00	-5.71	AVG

Remark:

1. Measuring frequencies from 1 GHz to the 10th harmonic of highest fundamental frequency.
2. Average test would be performed if the peak result were greater than the average limit.
3. Data of measurement within this frequency range shown " --- " in the table above means the reading of emissions are attenuated more than 20dB below the permissible limits or the field strength is too small to be measured.
4. Measurements above show only up to 6 maximum emissions noted, or would be lesser, with " N/A " remark, if no specific emissions from the EUT are recorded (ie: margin>20dB from the applicable limit) and considered that's already beyond the background noise floor.
5. Result = Reading + Correction Factor  
 Margin = Result - Limit  
 Remark Peak = Result(PK) - Limit(AV)  
 Remark AVG = Result(AV) - Limit(AV)



<b>Product Name</b>	2.4GHz Multimedia Keyboard with Laser Trackball and Scroll Wheel	<b>Test By</b>	Rueyyan Lin
<b>Test Model</b>	GKM561RB	<b>Test Date</b>	2014/06/28
<b>Test Mode</b>	GFSK TX / CH Middle	<b>Temp. &amp; Humidity</b>	30°C, 58%

966 Chamber_B at 3Meter / Horizontal									
Frequency (MHz)	Reading-PK (dBuV)	Reading-AV (dBuV)	Correction Factor (dB/m)	Result-PK (dBuV/m)	Result-AV (dBuV/m)	Limit-PK (dBuV/m)	Limit-AV (dBuV/m)	Margin (dB)	Remark
1082.00	45.03	---	-2.88	42.14	---	74.00	54.00	-11.86	Peak
1332.00	45.11	---	-2.89	42.21	---	74.00	54.00	-11.79	Peak
2440.00	91.29	89.18	2.69	93.98	91.87	114.00	94.00	-2.13	AVG
2590.00	46.10	---	3.04	49.14	---	74.00	54.00	-4.86	Peak
3525.00	41.42	---	4.56	45.98	---	74.00	54.00	-8.02	Peak
4125.00	40.83	---	6.25	47.08	---	74.00	54.00	-6.92	Peak
4875.00	42.59	---	8.18	50.77	---	74.00	54.00	-3.23	Peak
7320.00	42.95	32.11	13.12	56.07	45.23	74.00	54.00	-8.77	AVG

966 Chamber_B at 3Meter / Vertical									
Frequency (MHz)	Reading-PK (dBuV)	Reading-AV (dBuV)	Correction Factor (dB/m)	Result-PK (dBuV/m)	Result-AV (dBuV/m)	Limit-PK (dBuV/m)	Limit-AV (dBuV/m)	Margin (dB)	Remark
1204.00	45.18	---	-2.89	42.29	---	74.00	54.00	-11.71	Peak
2440.00	91.17	89.10	2.69	93.86	91.79	114.00	94.00	-2.21	AVG
2590.00	47.91	41.13	3.04	50.95	44.17	74.00	54.00	-3.05	AVG
2740.00	44.61	---	3.42	48.03	---	74.00	54.00	-5.97	Peak
3360.00	41.53	---	4.38	45.91	---	74.00	54.00	-8.09	Peak
4020.00	40.93	---	5.92	46.85	---	74.00	54.00	-7.15	Peak
4875.00	46.35	36.40	8.18	54.53	44.58	74.00	54.00	-9.42	AVG
7320.00	43.51	32.89	13.12	56.63	46.01	74.00	54.00	-7.99	AVG

**Remark:**

1. Measuring frequencies from 1 GHz to the 10th harmonic of highest fundamental frequency.
2. Average test would be performed if the peak result were greater than the average limit.
3. Data of measurement within this frequency range shown " --- " in the table above means the reading of emissions are attenuated more than 20dB below the permissible limits or the field strength is too small to be measured.
4. Measurements above show only up to 6 maximum emissions noted, or would be lesser, with " N/A " remark, if no specific emissions from the EUT are recorded (ie: margin>20dB from the applicable limit) and considered that's already beyond the background noise floor.
5. Result = Reading + Correction Factor  
Margin = Result - Limit  
Remark Peak = Result(PK) - Limit(AV)  
Remark AVG = Result(AV) - Limit(AV)



<b>Product Name</b>	2.4GHz Multimedia Keyboard with Laser Trackball and Scroll Wheel	<b>Test By</b>	Rueyyan Lin
<b>Test Model</b>	GKM561RB	<b>Test Date</b>	2014/06/28
<b>Test Mode</b>	GFSK TX / CH High	<b>Temp. &amp; Humidity</b>	30°C, 58%

966 Chamber_B at 3Meter / Horizontal									
Frequency (MHz)	Reading-PK (dBuV)	Reading-AV (dBuV)	Correction Factor (dB/m)	Result-PK (dBuV/m)	Result-AV (dBuV/m)	Limit-PK (dBuV/m)	Limit-AV (dBuV/m)	Margin (dB)	Remark
1062.00	45.34	---	-2.88	42.46	---	74.00	54.00	-11.54	Peak
1254.00	45.25	---	-2.89	42.36	---	74.00	54.00	-11.64	Peak
2474.00	94.08	86.54	2.76	96.84	89.30	114.00	94.00	-4.70	AVG
2624.00	46.78	---	3.12	49.90	---	74.00	54.00	-4.10	Peak
3585.00	41.17	---	4.72	45.89	---	74.00	54.00	-8.11	Peak
4245.00	41.29	---	6.62	47.91	---	74.00	54.00	-6.09	Peak
4950.00	41.84	---	8.34	50.18	---	74.00	54.00	-3.82	Peak
5655.00	38.82	---	9.77	48.59	---	74.00	54.00	-5.41	Peak

966 Chamber_B at 3Meter / Vertical									
Frequency (MHz)	Reading-PK (dBuV)	Reading-AV (dBuV)	Correction Factor (dB/m)	Result-PK (dBuV/m)	Result-AV (dBuV/m)	Limit-PK (dBuV/m)	Limit-AV (dBuV/m)	Margin (dB)	Remark
1110.00	45.37	---	-2.88	42.48	---	74.00	54.00	-11.52	Peak
1290.00	45.24	---	-2.89	42.35	---	74.00	54.00	-11.65	Peak
2474.00	95.41	91.53	2.76	98.17	93.25	114.00	94.00	-0.75	AVG
2624.00	47.33	40.56	3.12	50.45	43.68	74.00	54.00	-3.55	AVG
3645.00	41.74	---	4.89	46.62	---	74.00	54.00	-7.38	Peak
4260.00	40.71	---	6.67	47.37	---	74.00	54.00	-6.63	Peak
4950.00	46.89	37.04	8.34	55.23	45.38	74.00	54.00	-8.62	AVG
7425.00	41.70	30.03	13.45	55.15	43.48	74.00	54.00	-10.52	AVG

**Remark:**

1. Measuring frequencies from 1 GHz to the 10th harmonic of highest fundamental frequency.
2. Average test would be performed if the peak result were greater than the average limit.
3. Data of measurement within this frequency range shown " --- " in the table above means the reading of emissions are attenuated more than 20dB below the permissible limits or the field strength is too small to be measured.
4. Measurements above show only up to 6 maximum emissions noted, or would be lesser, with " N/A " remark, if no specific emissions from the EUT are recorded (ie: margin>20dB from the applicable limit) and considered that's already beyond the background noise floor.
5. Result = Reading + Correction Factor  
Margin = Result - Limit  
Remark Peak = Result(PK) - Limit(AV)  
Remark AVG = Result(AV) - Limit(AV)



Restricted Band Edges

Detector Mode : Peak

Polarity : Horizontal

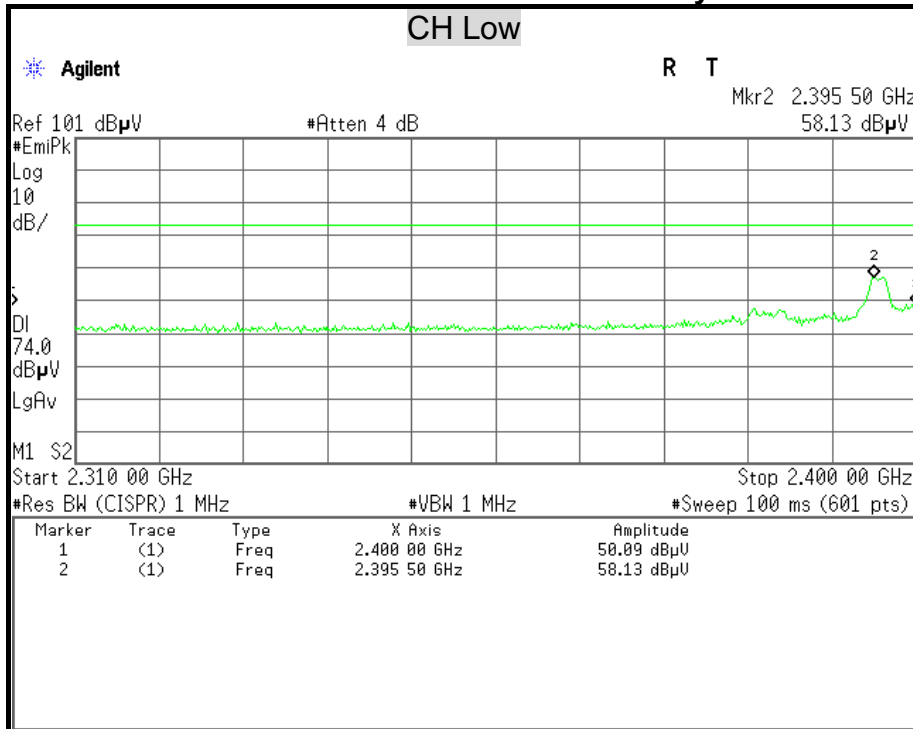

Detector Mode : Average

Polarity : Horizontal

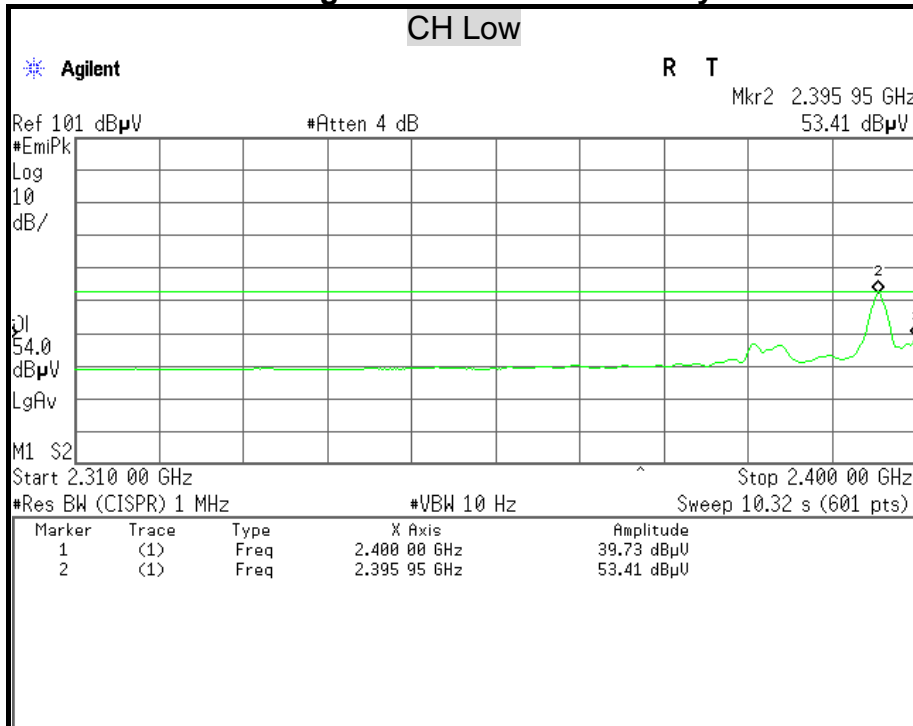



Detector Mode : Peak

Polarity : Vertical

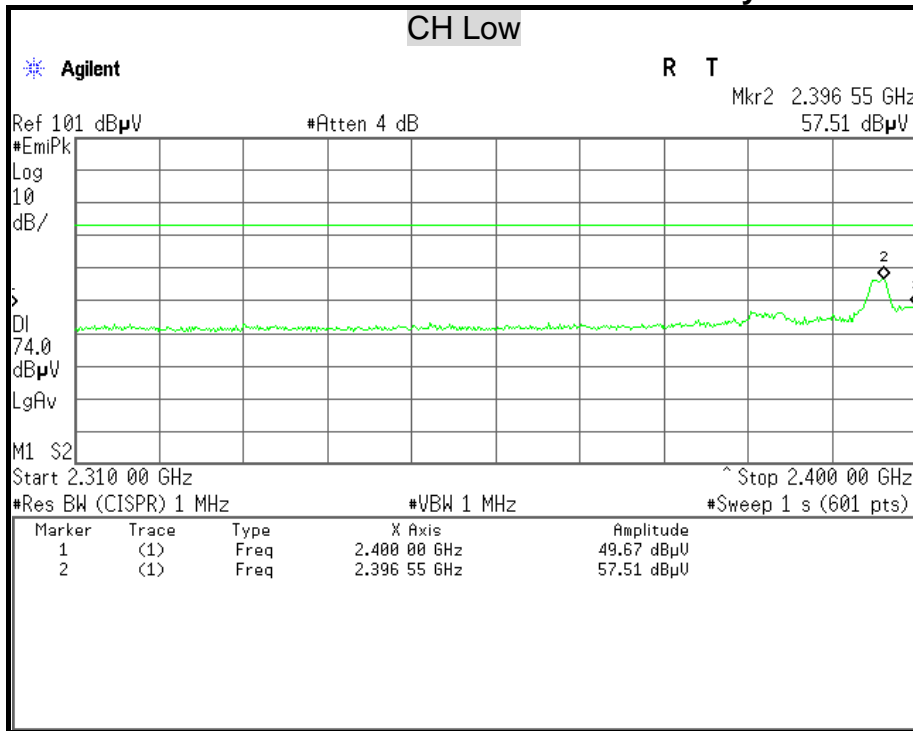

Detector Mode : Average

Polarity : Vertical

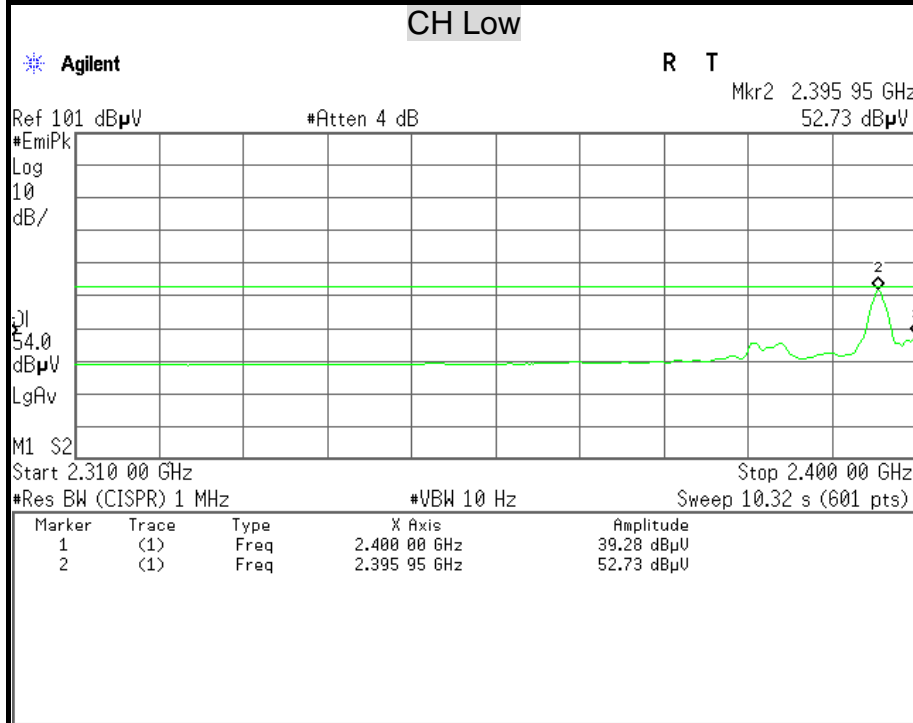





Detector Mode : Peak

Polarity : Horizontal

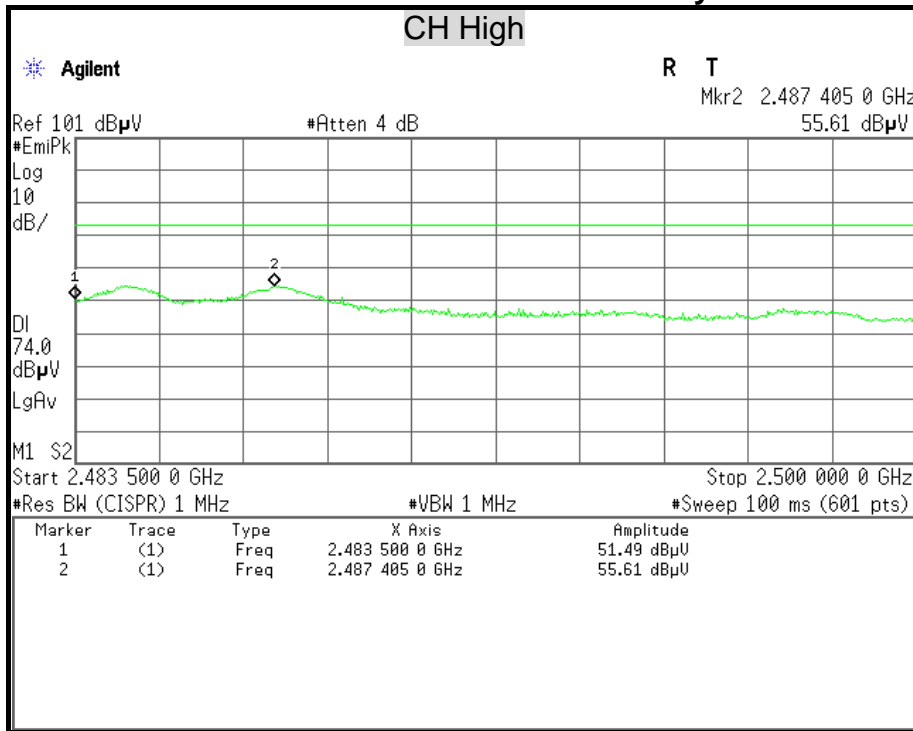

Detector Mode : Average

Polarity : Horizontal

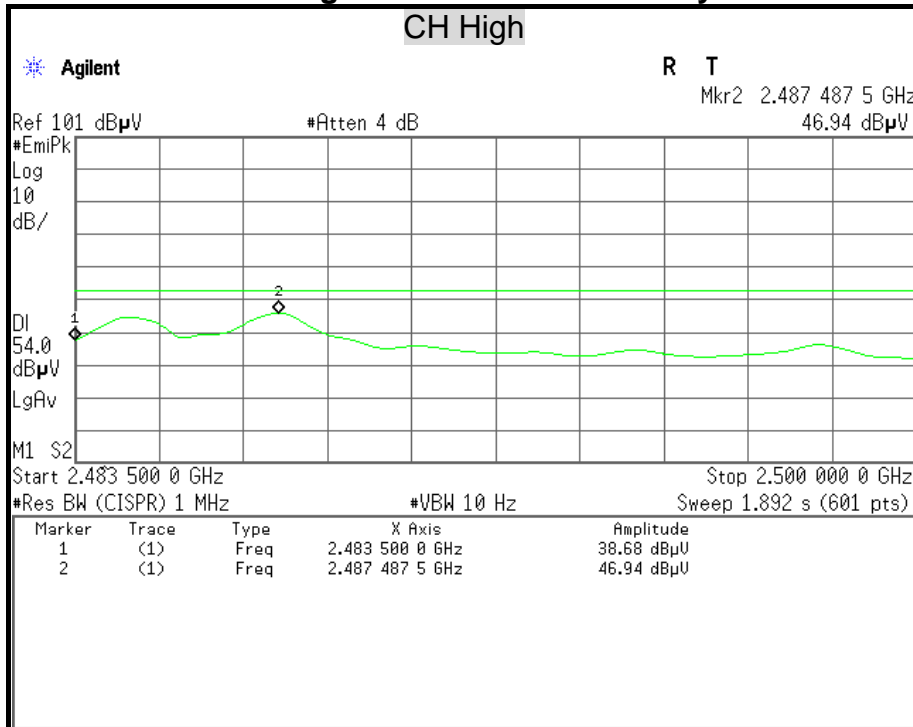



Detector Mode : Peak

Polarity : Vertical

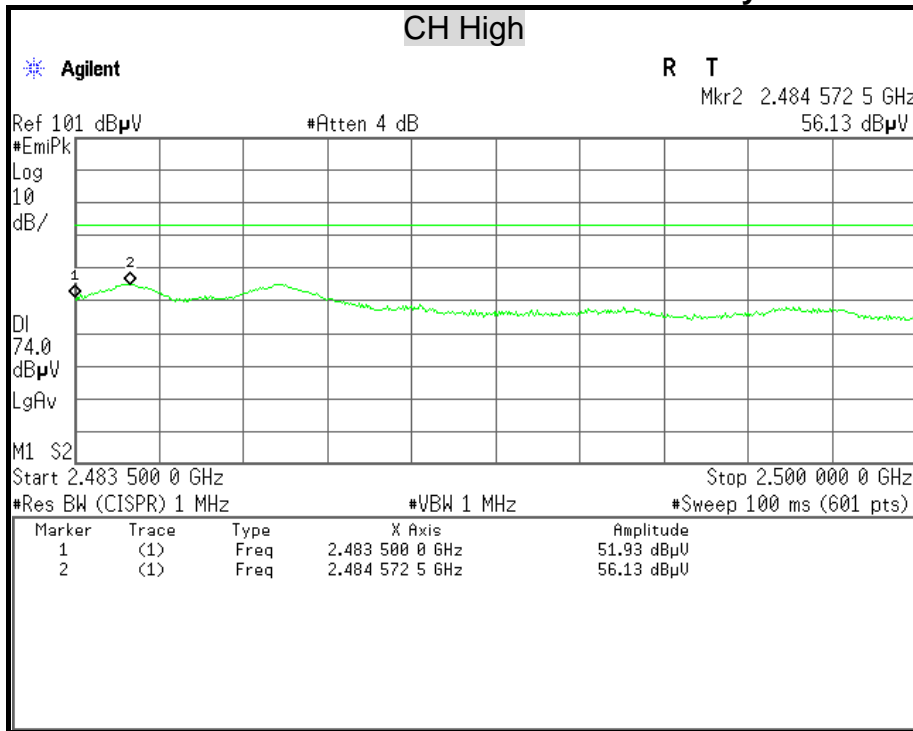

Detector Mode : Average

Polarity : Vertical

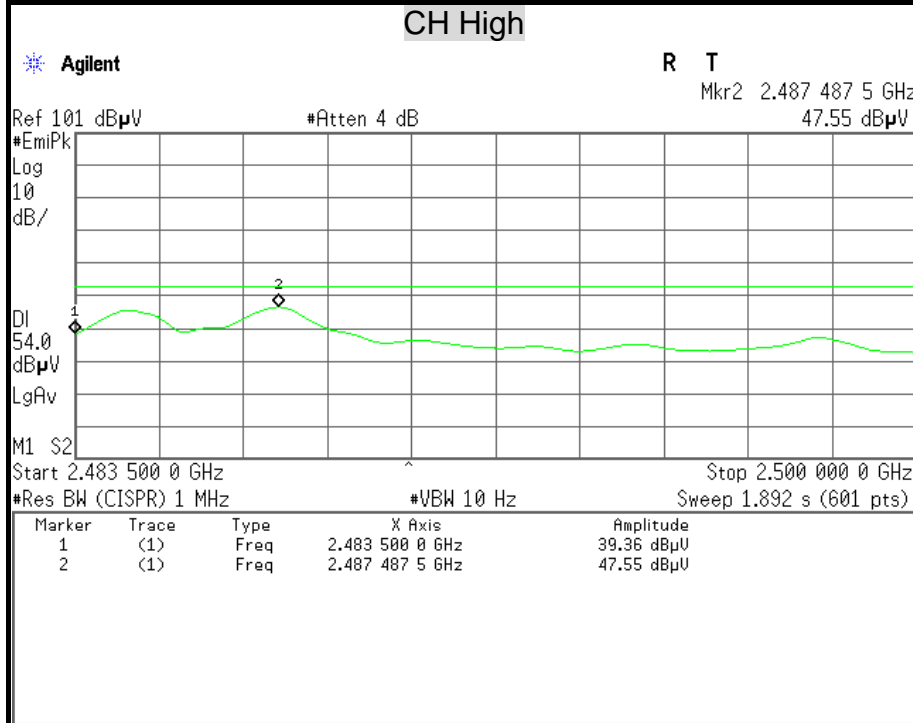



### 7.3 CONDUCTED EMISSION

#### LIMITS

§ 15.207 (a) Except as shown in paragraph (b) and (c) this section, for an intentional radiator that is designed to be connected to the public utility (AC) power line, the radio frequency voltage that is conducted back onto the AC power line on any frequency or frequencies within the band 150 kHz to 30 MHz shall not exceed the limits in the following table, as measured using a 50 µH/50 ohms line impedance stabilization network (LISN). Compliance with the provisions of this paragraph shall be based on the measurement of the radio frequency voltage between each power line and ground at the power terminal. The lower limit applies at the boundary between the frequency ranges.

Frequency Range (MHz)	Conducted Limit (dBµv)	
	Quasi-peak	Average
0.15 - 0.50	66 to 56	56 to 46
0.50 - 5.00	56	46
5.00 - 30.0	60	50

#### TEST EQUIPMENT

Name of Equipment	Manufacturer	Model	Serial Number	Calibration Due
L.I.S.N	SCHWARZBECK	NSLK 8127	8127-465	08/06/2015
L.I.S.N	SCHWARZBECK	NSLK 8127	8127-473	03/10/2015
EMI Test Receiver	ROHDE & SCHWARZ	ESHS 30	838550/003	11/07/2014
Pulse Limiter	ROHDE & SCHWARZ	ESH3-Z2	100111	06/30/2015

**Remark:** Each piece of equipment is scheduled for calibration once a year.



**TEST SETUP**

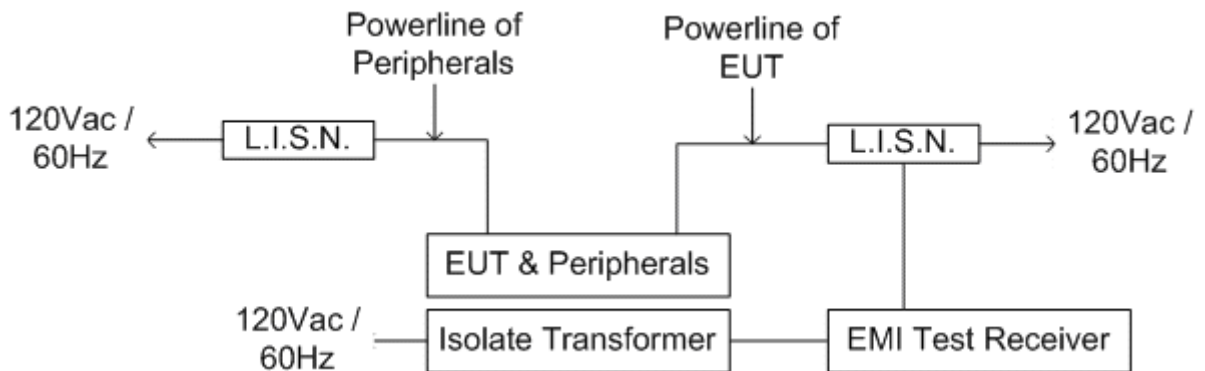
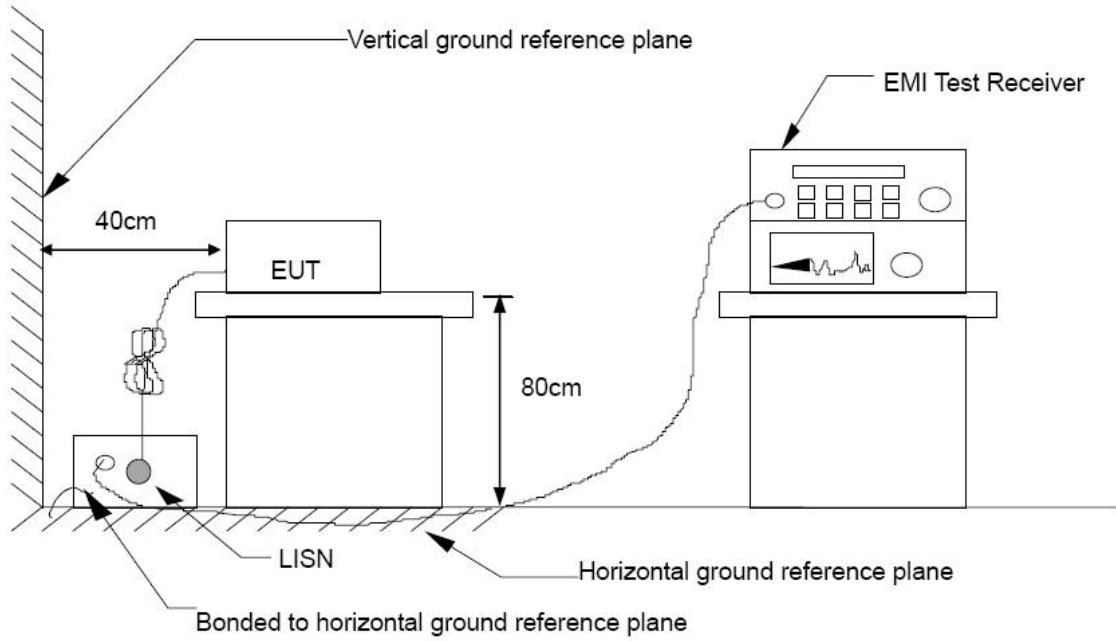



## **TEST PROCEDURE**

The basic test procedure was in accordance with ANSI C63.10:2009.

The test procedure is performed in a 4m × 3m × 2.4m (L×W×H) shielded room.

The EUT along with its peripherals were placed on a 1.0m (W) × 1.5m (L) and 0.8m in height wooden table and the EUT was adjusted to maintain a 0.4 meter space from a vertical reference plane.

The EUT was connected to power mains through a line impedance stabilization network (LISN) which provides 50 ohm coupling impedance for measuring instrument and the chassis ground was bounded to the horizontal ground plane of shielded room. All peripherals were connected to the second LISN and the chassis ground also bounded to the horizontal ground plane of shielded room.

The EUT was located so that the distance between the boundary of the EUT and the closest surface of the LISN is 0.8 m. Where a mains flexible cord was provided by the manufacturer shall be 1 m long, or if in excess of 1 m, the excess cable was folded back and forth as far as possible so as to form a bundle not exceeding 0.4 m in length.

## **TEST RESULTS**

Since the EUT is powered by battery powered, this test item is not applicable.