



## FCC 47 CFR PART 15 Subpart C

### TEST REPORT

For

**Long Range Media Center Desktop Combo**

**Model Number: GKM551R**

**Trade Name: IOGEAR**

*Issued to*

**IOGEAR, INC.**

**23 Hubble Irvine California 92618 United States**

*Issued by*

**Compliance Certification Services Inc.**

**No. 81-1, Lane 210, Bade Rd. 2, Luchu Hsiang,**

**Taoyuan Hsien, (338) Taiwan, R.O.C.**

**<http://www.ccsemc.com.tw>**

**[service@tw.ccsemc.com](mailto:service@tw.ccsemc.com)**



---

*Note: This report shall not be reproduced except in full, without the written approval of Compliance Certification Services Inc. This document may be altered or revised by Compliance Certification Services Inc. personnel only, and shall be noted in the revision section of the document.*



# TABLE OF CONTENTS

- 1. TEST RESULT CERTIFICATION..... 3
- 2. EUT DESCRIPTION ..... 4
- 3. TEST METHODOLOGY ..... 5
  - 3.1 EUT CONFIGURATION.....5
  - 3.2 EUT EXERCISE .....5
  - 3.3 GENERAL TEST PROCEDURES .....5
  - 3.4 FCC PART 15.205 RESTRICTED BANDS OF OPERATIONS.....6
  - 3.5 DESCRIPTION OF TEST MODES .....6
- 4. INSTRUMENT CALIBRATION ..... 7
  - 4.1 MEASURING INSTRUMENT CALIBRATION.....7
  - 4.2 MEASUREMENT EQUIPMENT USED.....7
- 5. FACILITIES AND ACCREDITATIONS ..... 8
  - 5.1 FACILITIES8
  - 5.2 EQUIPMENT .....8
  - 5.3 TABLE OF ACCREDITATIONS AND LISTINGS.....9
- 6. SETUP OF EQUIPMENT UNDER TEST ..... 10
  - 6.1 SETUP CONFIGURATION OF EUT..... 10
  - 6.2 SUPPORT EQUIPMENT ..... 10
- 7. FCC PART 15.249 REQUIREMENTS ..... 11
  - 7.1 20 DB BANDWIDTH..... 11
  - 7.2 BAND EDGES MEASUREMENT ..... 14
  - 7.3 SPURIOUS EMISSION ..... 19
  - 7.4 POWERLINE CONDUCTED EMISSIONS ..... 26
- APPENDIX I PHOTOGRAPHS OF TEST SETUP ..... 27



# 1. TEST RESULT CERTIFICATION

**Applicant:** IOGEAR, INC.  
 23 Hubble Irvine California 92618 United States

**Equipment Under Test:** Long Range Media Center Desktop Combo

**Trade Name:** IOGEAR

**Model Number:** GKM551R

**Date of Test:** June 12 ~ December 5, 2007

APPLICABLE STANDARDS	
STANDARD	TEST RESULT
FCC 47 CFR Part 15 Subpart C	No non-compliance noted

## We hereby certify that:

The above equipment was tested by Compliance Certification Services Inc. The test data, data evaluation, test procedures, and equipment configurations shown in this report were made in accordance with the procedures given in ANSI C63.4: 2003 and the energy emitted by the sample EUT tested as described in this report is in compliance with the requirements emission limits of FCC Rules Part 15.107, 15.109, 15.207, 15.209 and 15.249.

The test results of this report relate only to the tested sample identified in this report.

Approved by:

Reviewed by:

---

Rex Lai  
 Section Manager  
 Compliance Certification Services Inc.

---

Amanda Wu  
 Section Manager  
 Compliance Certification Services Inc.



## 2. EUT DESCRIPTION

<b>Product</b>	Long Range Media Center Desktop Combo
<b>Trade Name</b>	IOGEAR
<b>Model Number</b>	GKM551R
<b>Model Discrepancy</b>	N/A
<b>Power Supply</b>	Powered by AAA batteries × 2 (Rating: 2 × 1.5Vdc)
<b>Frequency Range</b>	2402 ~ 2479 MHz
<b>Modulation Technique</b>	DSSS+GFSK
<b>Antenna Gain</b>	0 dBi
<b>Antenna Designation</b>	Printed Antenna

**Remark:**

1. *The sample selected for test was production product and was provided by manufacturer.*
2. *This submittal(s) (test report) is intended for FCC ID: **QLEKBGKM551R** filing to comply with Section 15.107 & 15.109 and Section 15.207, 15.209, 15.249.*



### **3. TEST METHODOLOGY**

The tests documented in this report were performed in accordance with ANSI C63.4 and FCC CFR 47 2.1046, 2.1047, 2.1049, 2.1051, 2.1053, 2.1055, 2.1057, 15.207, 15.209 and 15.249.

#### **3.1 EUT CONFIGURATION**

The EUT configuration for testing is installed on RF field strength measurement to meet the Commissions requirement and operating in a manner that intends to maximize its emission characteristics in a continuous normal application.

#### **3.2 EUT EXERCISE**

The EUT was operated in the engineering mode to fix the TX frequency that was for the purpose of the measurements.

According to its specifications, the EUT must comply with the requirements of the Section 15.107 and 15.109 under the FCC Rules Part 15 Subpart B and Section 15.207, 15.209, 15.249 under the FCC Rules Part 15 Subpart C.

#### **3.3 GENERAL TEST PROCEDURES**

##### **Conducted Emissions**

The EUT is placed on the turntable, which is 0.8 m above ground plane. According to the requirements in Section 13.1.4.1 of ANSI C63.4 Conducted emissions from the EUT measured in the frequency range between 0.15 MHz and 30MHz using CISPR Quasi-peak and average detector modes.

##### **Radiated Emissions**

The EUT is placed on a turn table, which is 0.8 m above ground plane. The turntable shall rotate 360 degrees to determine the position of maximum emission level. EUT is set 3m away from the receiving antenna, which varied from 1m to 4m to find out the highest emission. And also, each emission was to be maximized by changing the polarization of receiving antenna both horizontal and vertical. In order to find out the maximum emissions, exploratory radiated emission measurements were made according to the requirements in Section 13.1.4.1 of ANSI C63.4.



### 3.4 FCC PART 15.205 RESTRICTED BANDS OF OPERATIONS

(a) Except as shown in paragraph (d) of this section, only spurious emissions are permitted in any of the frequency bands listed below:

MHz	MHz	MHz	GHz
0.090 - 0.110	16.42 - 16.423	399.9 - 410	4.5 - 5.15
<sup>1</sup> 0.495 - 0.505	16.69475 - 16.69525	608 - 614	5.35 - 5.46
2.1735 - 2.1905	16.80425 - 16.80475	960 - 1240	7.25 - 7.75
4.125 - 4.128	25.5 - 25.67	1300 - 1427	8.025 - 8.5
4.17725 - 4.17775	37.5 - 38.25	1435 - 1626.5	9.0 - 9.2
4.20725 - 4.20775	73 - 74.6	1645.5 - 1646.5	9.3 - 9.5
6.215 - 6.218	74.8 - 75.2	1660 - 1710	10.6 - 12.7
6.26775 - 6.26825	108 - 121.94	1718.8 - 1722.2	13.25 - 13.4
6.31175 - 6.31225	123 - 138	2200 - 2300	14.47 - 14.5
8.291 - 8.294	149.9 - 150.05	2310 - 2390	15.35 - 16.2
8.362 - 8.366	156.52475 -	2483.5 - 2500	17.7 - 21.4
8.37625 - 8.38675	156.52525	2655 - 2900	22.01 - 23.12
8.41425 - 8.41475	156.7 - 156.9	3260 - 3267	23.6 - 24.0
12.29 - 12.293	162.0125 - 167.17	3332 - 3339	31.2 - 31.8
12.51975 - 12.52025	167.72 - 173.2	3345.8 - 3358	36.43 - 36.5
12.57675 - 12.57725	240 - 285	3600 - 4400	( <sup>2</sup> )
13.36 - 13.41	322 - 335.4		

<sup>1</sup> Until February 1, 1999, this restricted band shall be 0.490-0.510 MHz.

<sup>2</sup> Above 38.6

(b) Except as provided in paragraphs (d) and (e), the field strength of emissions appearing within these frequency bands shall not exceed the limits shown in Section 15.209. At frequencies equal to or less than 1000 MHz, compliance with the limits in Section 15.209 shall be demonstrated using measurement instrumentation employing a CISPR quasi-peak detector. Above 1000 MHz, compliance with the emission limits in Section 15.209 shall be demonstrated based on the average value of the measured emissions. The provisions in Section 15.35 apply to these measurements.

### 3.5 DESCRIPTION OF TEST MODES

The EUT (model: GKM551R) had been tested under operating condition.

After verification, all tests were carried out with the worst case test modes as shown below except radiated spurious emission below 1GHz, which worst case was in normal link mode only.

Channel Low(2402MHz), Channel Mid(2441MHz) and Channel High(2479MHz) were chosen for the final testing.



## 4. INSTRUMENT CALIBRATION

### 4.1 MEASURING INSTRUMENT CALIBRATION

The measuring equipment, which was utilized in performing the tests documented herein, has been calibrated in accordance with the manufacturer's recommendations for utilizing calibration equipment, which is traceable to recognized national standards.

### 4.2 MEASUREMENT EQUIPMENT USED

#### Equipment Used for Emissions Measurement

*Remark: Each piece of equipment is scheduled for calibration once a year.*

3M Semi Anechoic Chamber				
Name of Equipment	Manufacturer	Model	Serial Number	Calibration Due
Spectrum Analyzer	Agilent	E4446A	US42510252	08/01/2008
Test Receiver	Rohde&Schwarz	ESCI	100064	11/12/2008
Switch Controller	TRC	Switch Controller	SC94050010	05/03/2009
4 Port Switch	TRC	4 Port Switch	SC94050020	05/03/2009
Horn-Antenna	TRC	HA-0502	06	06/05/2008
Horn-Antenna	TRC	HA-0801	04	05/03/2009
Horn-Antenna	TRC	HA-1201A	01	07/09/2008
Horn-Antenna	TRC	HA-1301A	01	07/17/2008
Bilog- Antenna	Sunol Sciences	JB3	A030205	03/07/2009
Turn Table	Max-Full	MFT-120S	T120S940302	N.C.R.
Antenna Tower	Max-Full	MFA-430	A440940302	N.C.R.
Controller	Max-Full	MF-CM886	CC-C-1F-13	N.C.R.
Site NSA	CCS	N/A	FCC: 965860 IC: IC 6106	09/25/2008
Test S/W	LABVIEW (V 6.1)			

*Remark: The measurement uncertainty is less than +/-2.0065dB (30MHz ~ 1GHz), +/-3.0958dB (Above 1GHz) which is evaluated as per the NAMAS NIS 81 and CISPR/A/291/CDV.*



## 5. FACILITIES AND ACCREDITATIONS

### 5.1 FACILITIES

All measurement facilities used to collect the measurement data are located at

- No. 199, Chungsen Road, Hsintien City, Taipei Hsien, Taiwan, R.O.C.  
Tel: 886-2-2217-0894 / Fax: 886-2-2217-1029
- No.11, Wugong 6th Rd., Wugu Industrial Park, Taipei Hsien 248, Taiwan  
Tel: 886-2-2299-9720 / Fax: 886-2-2298-4045
- No.81-1, Lane 210, Bade 2nd Rd., Luchu Hsiang, Taoyuan Hsien 338, Taiwan  
Tel: 886-3-324-0332 / Fax: 886-3-324-5235

The sites are constructed in conformance with the requirements of ANSI C63.7, ANSI C63.4 and CISPR Publication 22.

### 5.2 EQUIPMENT

Radiated emissions are measured with one or more of the following types of linearly polarized antennas: tuned dipole, biconical, log periodic, bi-log, and/or ridged waveguide, horn. Spectrum analyzers with pre-selectors and quasi-peak detectors are used to perform radiated measurements.

Conducted emissions are measured with Line Impedance Stabilization Networks and EMI Test Receivers.







Calibrated wideband preamplifiers, coaxial cables, and coaxial attenuators are also used for making measurements.

All receiving equipment conforms to CISPR Publication 16-1, "Radio Interference Measuring Apparatus and Measurement Methods."





### 5.3 TABLE OF ACCREDITATIONS AND LISTINGS

Country	Agency	Scope of Accreditation	Logo
USA	A2LA	EN 55011, EN 55014-1/2, CISPR 11, CISPR 14-1/2, EN 55022, EN 55015, CISPR 22, CISPR 15, AS/NZS 3548, VCCI V3 (2001), CFR 47, FCC Part 15/18, CNS 13783-1, CNS 13439, CNS 13438, CNS 13803, CNS 14115, EN 55024, IEC 801-2, IEC 801-3, IEC 801-4, IEC/EN 61000-3-2, IEC/EN 61000-3-3, IEC/EN 61000-4-2/3/4/5/6/8/11, EN 50081-1/ EN 61000-6-3, EN 50081-2/EN 61000-6-4, EN 50081-2/EN 61000-6-1: 2001	
USA	FCC	3/10 meter Open Area Test Sites (93105, 90471) / 3M Semi Anechoic Chamber (965860) to perform FCC Part 15/18 measurements	 93105, 90471 965860
Japan	VCCI	3/10 meter Open Area Test Sites to perform conducted/radiated measurements	 R-393/1066/725/879 C-402/747/912
Norway	NEMKO	EN 50081-1/2, EN 50082-1/2, IEC 61000-6-1/2, EN 50091-2, EN 50130-4, EN 55011, EN 55013, EN 55014-1/2, EN 55015, EN 55022, EN 55024, EN 61000-3-2/3, EN 61326-1, IEC 61000-4-2/3/4/5/6/8/11, EN 60601-1-2, EN 300 328, EN 300 422-2, EN 301 419-1, EN 301 489-01/03/07/08/09/17, EN 301 419-2/3, EN 300 454-2, EN 301 357-2	 ELA 124a ELA 124b ELA 124c
Taiwan	TAF	EN 300 328, EN 300 220-1, EN 300 220-2, EN 300 220-3, 47 CFR FCC Part 15 Subpart C, EN 61000-3-2, EN 61000-3-3, CNS 13439, CNS 13783-1, CNS 14115, CNS 13438, AS/NZS CISPR 22, CNS 13022-1, IEC 61000-4-2/3/4/5/6/8/11, CNS 13022-2/3	
Taiwan	BSMI	CNS 13438, CNS 13783-1, CNS 13439, CNS 14115	 SL2-IS-E-0014 SL2-IN-E-0014 SL2-A1-E-0014 SL2-R1-E-0014 SL2-R2-E-0014 SL2-L1-E-0014
Canada	Industry Canada	3/10 meter Open Area Test Sites (IC 2324C-3, IC 2324C-5) / 3M Semi Anechoic Chamber (IC 6106)	 IC 2324C-3 IC 2324C-5 IC 6106

\* No part of this report may be used to claim or imply product endorsement by A2LA or any agency of the US Government.



## 6. SETUP OF EQUIPMENT UNDER TEST

### 6.1 SETUP CONFIGURATION OF EUT

See test photographs attached in Appendix I for the actual connections between EUT and support equipment.

### 6.2 SUPPORT EQUIPMENT

No.	Device Type	Brand	Model	Series No.	FCC ID	Data Cable	Power Cord
	N/A	N/A	N/A	N/A	N/A	N/A	N/A

**Remark:**

1. *All the equipment/cables were placed in the worst-case configuration to maximize the emission during the test.*
2. *Grounding was established in accordance with the manufacturer's requirements and conditions for the intended use.*



## 7. FCC PART 15.249 REQUIREMENTS

### 7.120 DB BANDWIDTH

#### LIMIT

None; for reporting purposes only.

#### Test Configuration

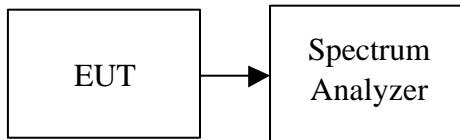

#### TEST PROCEDURE

1. Place the EUT on the table and set it in the transmitting mode.
2. Remove the antenna from the EUT and then connect a low loss RF cable from the antenna port to the spectrum analyzer.
3. Set the spectrum analyzer as RBW=100kHz, VBW = RBW, Span = 2MHz, Sweep = auto.
4. Mark the peak frequency and 20dB (upper and lower) frequency.
5. Repeat until all the rest channels are investigated.

#### TEST RESULTS

*No non-compliance noted*



Test Plot

(CH Low)

Agilent 15:10:33 Dec 5, 2007

R T

Δ Mkr2 723 kHz  
-0.09 dB

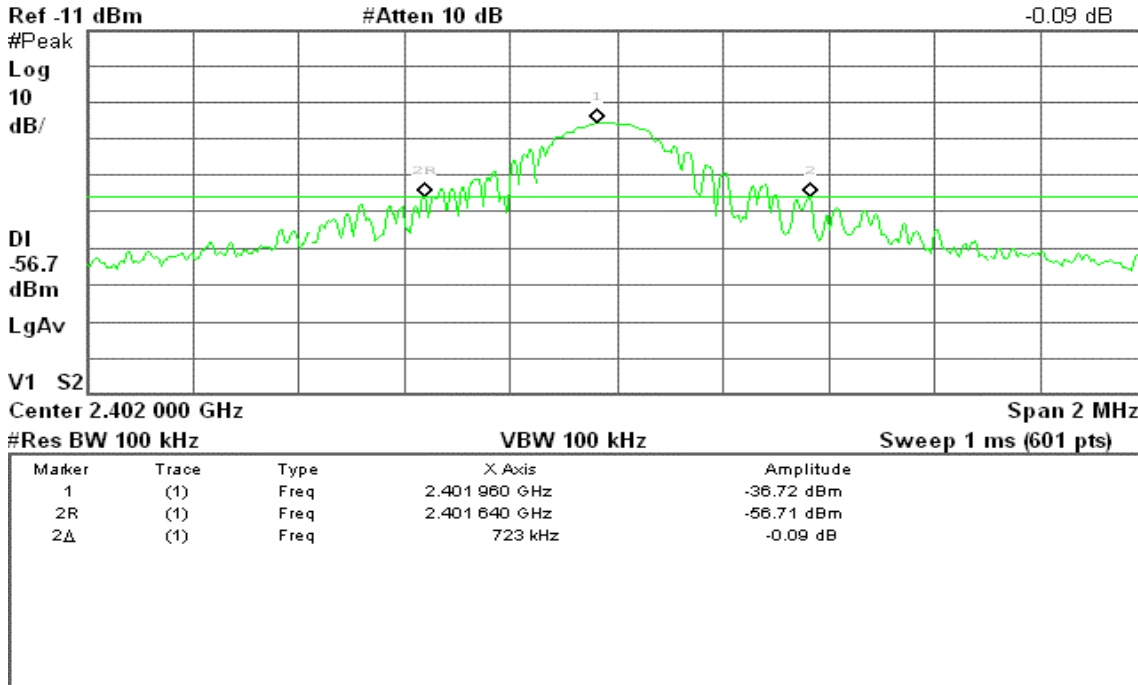

(CH Mid)

Agilent 15:11:35 Dec 5, 2007

R T

Δ Mkr2 667 kHz  
0.55 dB

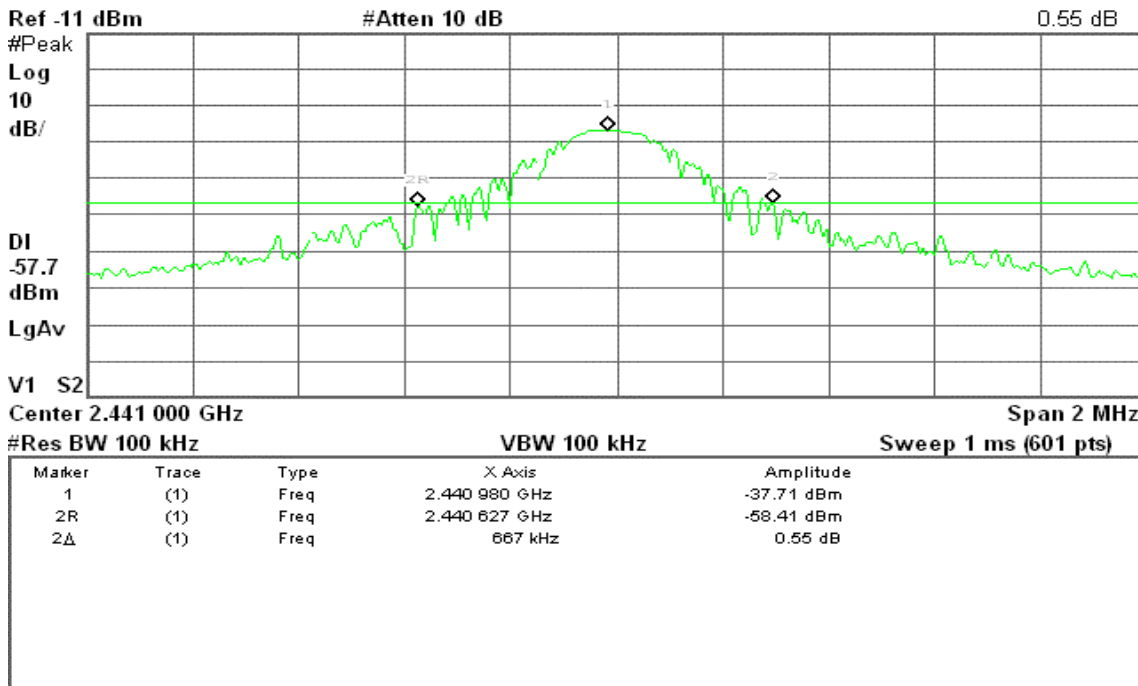



(CH High)

Agilent 15:13:17 Dec 5, 2007

R T

Δ Mkr2 710 kHz

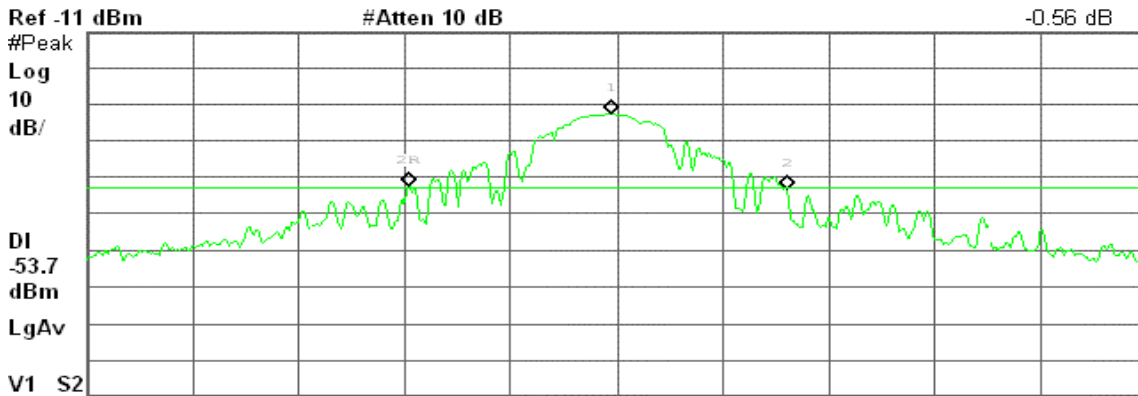

Center 2.479 000 GHz

Span 2 MHz

#Res BW 100 kHz

VBW 100 kHz

Sweep 1 ms (601 pts)

Marker	Trace	Type	X Axis	Amplitude
1	(1)	Freq	2.478 987 GHz	-33.65 dBm
2R	(1)	Freq	2.478 610 GHz	-53.53 dBm
2Δ	(1)	Freq	710 kHz	-0.56 dB

## 7.2 BAND EDGES MEASUREMENT

### LIMIT

1. In the above emission table, the tighter limit applies at the band edges.

Frequency (MHz)	Field Strength ( $\mu\text{V/m}$ at 3-meter)	Field Strength (dB $\mu\text{V/m}$ at 3-meter)
30-88	100	40
88-216	150	43.5
216-960	200	46
Above 960	500	54

2. As shown in Section 15.35(b), for frequencies above 1000 MHz, the above field strength limits in paragraphs (a) and (b) of this section are based on average limits. However, the peak field strength of any emission shall not exceed the maximum permitted average limits specified above by more than 20 dB under any condition of modulation. For point-to-point operation under paragraph (b) of this section, the peak field strength shall not exceed 2500 millivolts/meter at 3 meters along the antenna azimuth.

### Test Configuration

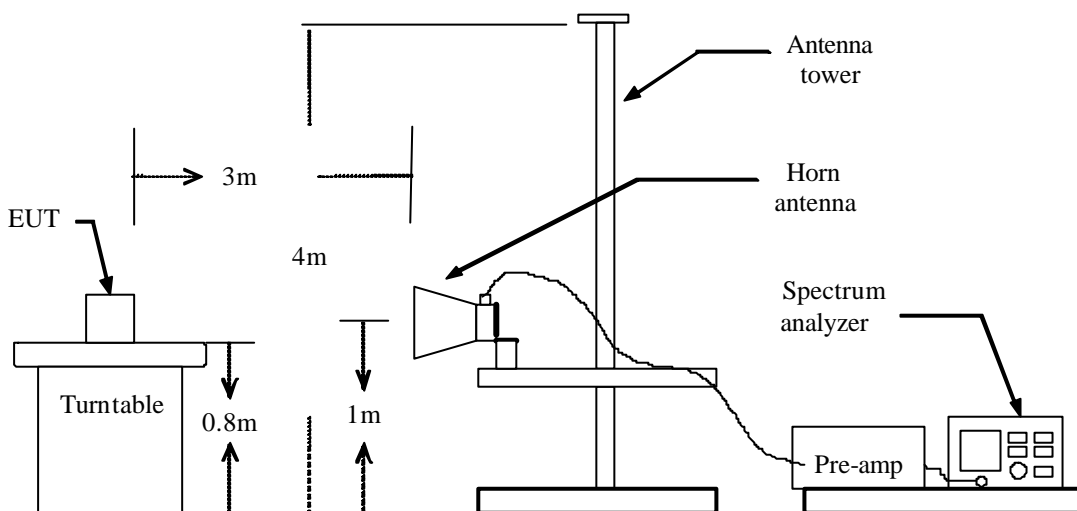

### TEST PROCEDURE

1. The EUT is placed on a turntable, which is 0.8m above the ground plane.
2. The turntable shall be rotated for 360 degrees to determine the position of maximum emission level.
3. EUT is set 3m away from the receiving antenna, which is varied from 1m to 4m to find out the highest emission.
4. Set the spectrum analyzer in the following setting in order to capture the lower and upper band-edges of the emission:
  - (a) PEAK: RBW=VBW=1MHz / Sweep=AUTO
  - (b) AVERAGE: RBW=1MHz / VBW=10Hz / Sweep=AUTO
5. Repeat the procedures until all the PEAK and AVERAGE versus POLARIZATION are measured.

### TEST RESULTS

Refer to attach spectrum analyzer data chart.



### Band Edges (CH Low)

Detector mode: Peak

Polarity: Vertical

Agilent 19:37:18 Jun 12, 2007

R T

Mkr1 2.390 00 GHz  
53.60 dB $\mu$ V

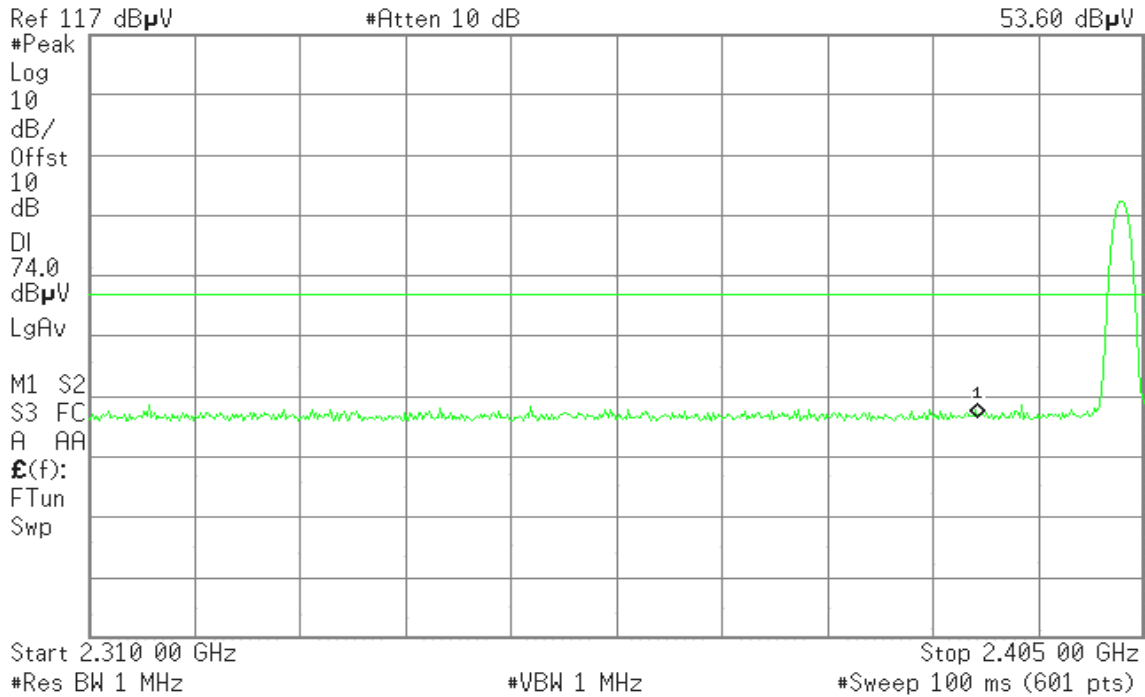

Detector mode: Average

Polarity: Vertical

Agilent 19:38:13 Jun 12, 2007

R T

Mkr1 2.390 00 GHz  
41.24 dB $\mu$ V

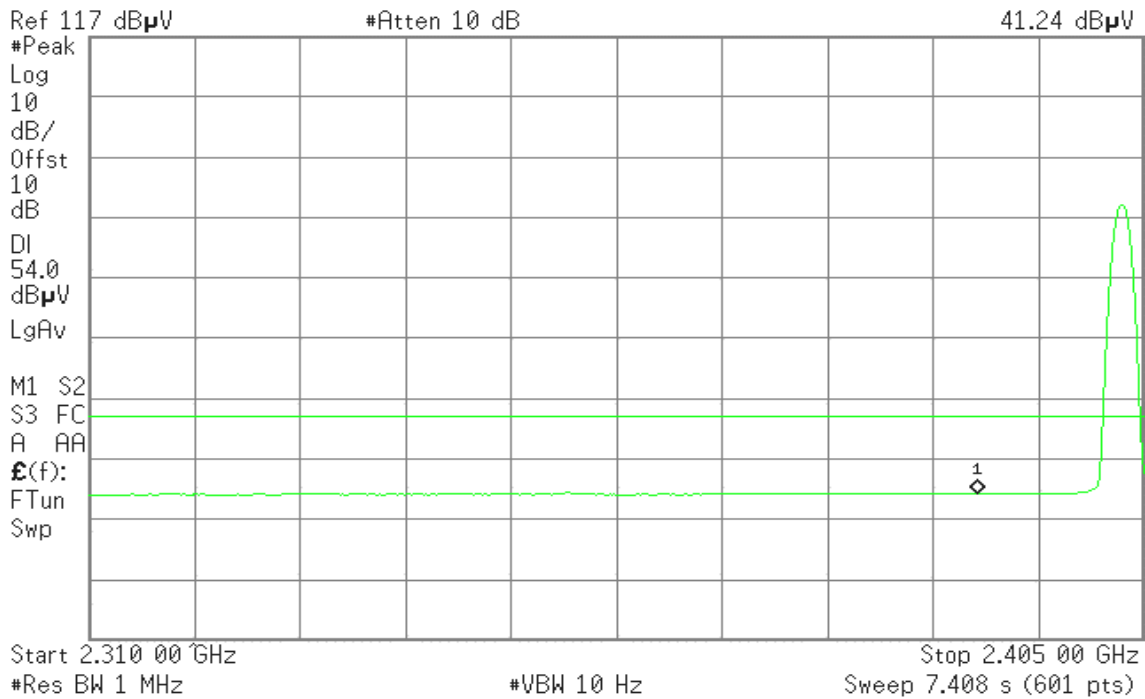



**Detector mode: Peak**

**Polarity: Horizontal**

Agilent 19:42:59 Jun 12, 2007

R T

Mkr1 2.390 00 GHz  
53.58 dBμV

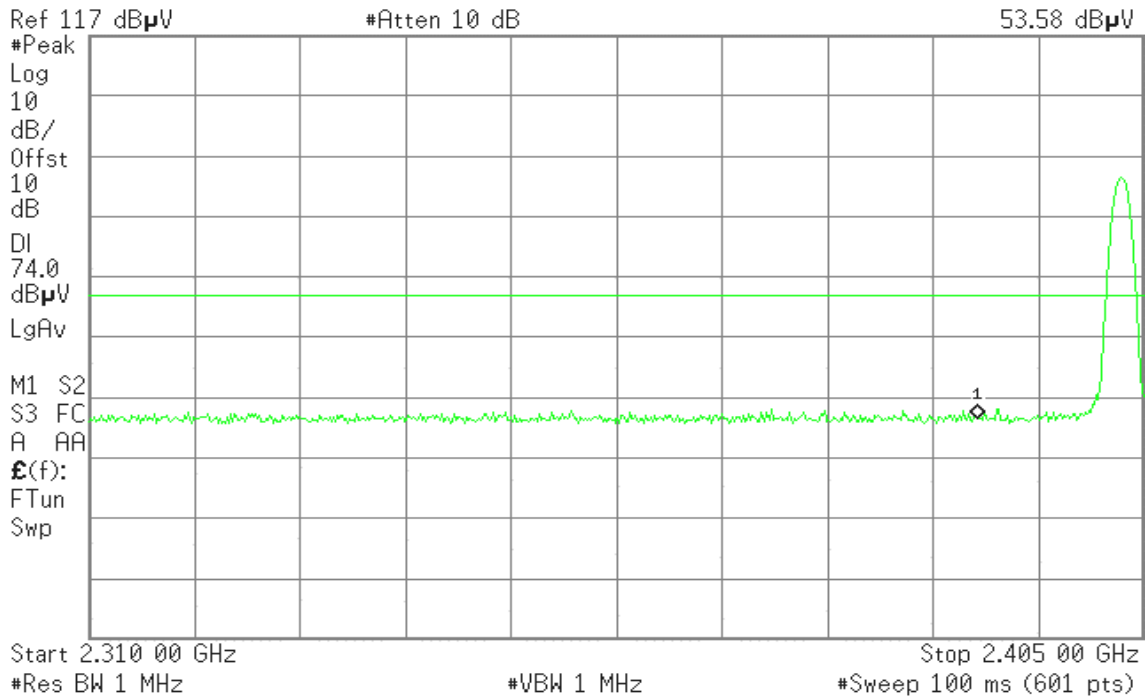

**Detector mode: Average**

**Polarity: Horizontal**

Agilent 19:43:39 Jun 12, 2007

R T

Mkr1 2.390 00 GHz  
41.23 dBμV

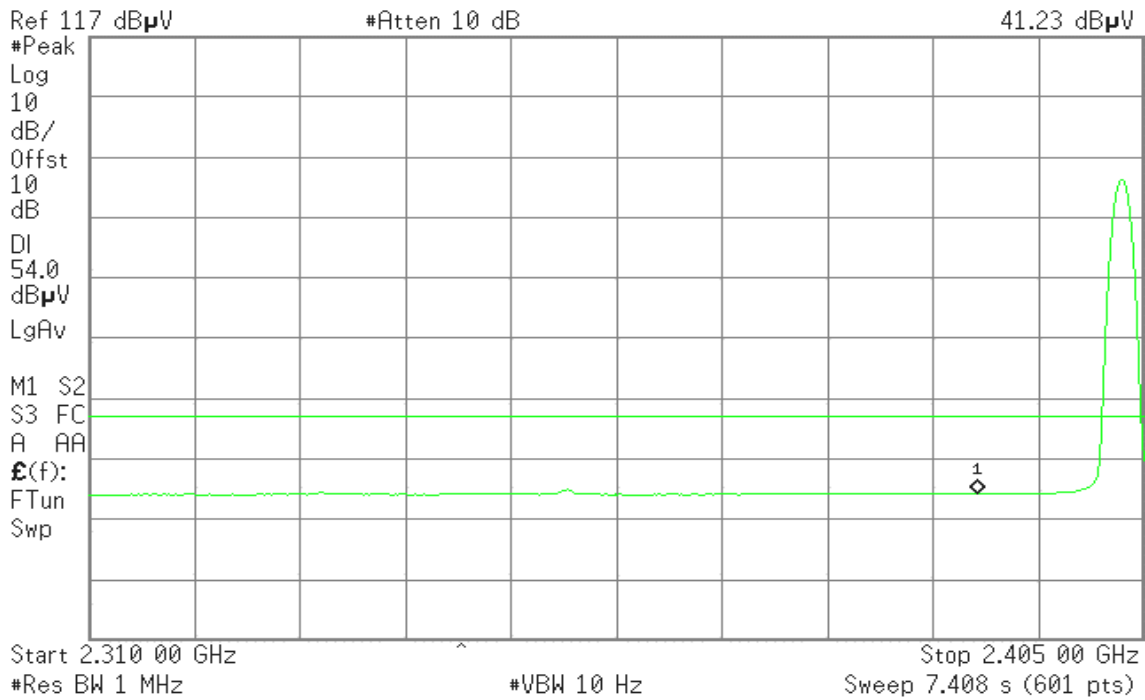





### Band Edges (CH High)

Detector mode: Peak

Polarity: Vertical

Agilent 20:01:43 Jun 12, 2007

R T

Mkr1 2.483 50 GHz  
54.34 dB $\mu$ V

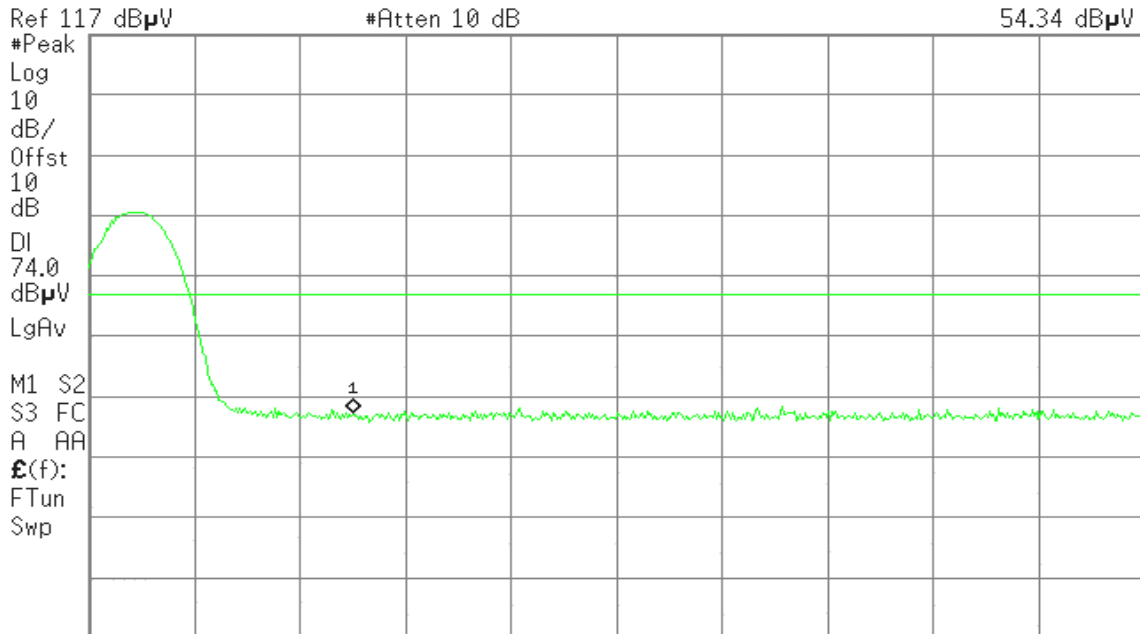

Detector mode: Average

Polarity: Vertical

Agilent 20:02:32 Jun 12, 2007

R T

Mkr1 2.483 50 GHz  
41.50 dB $\mu$ V

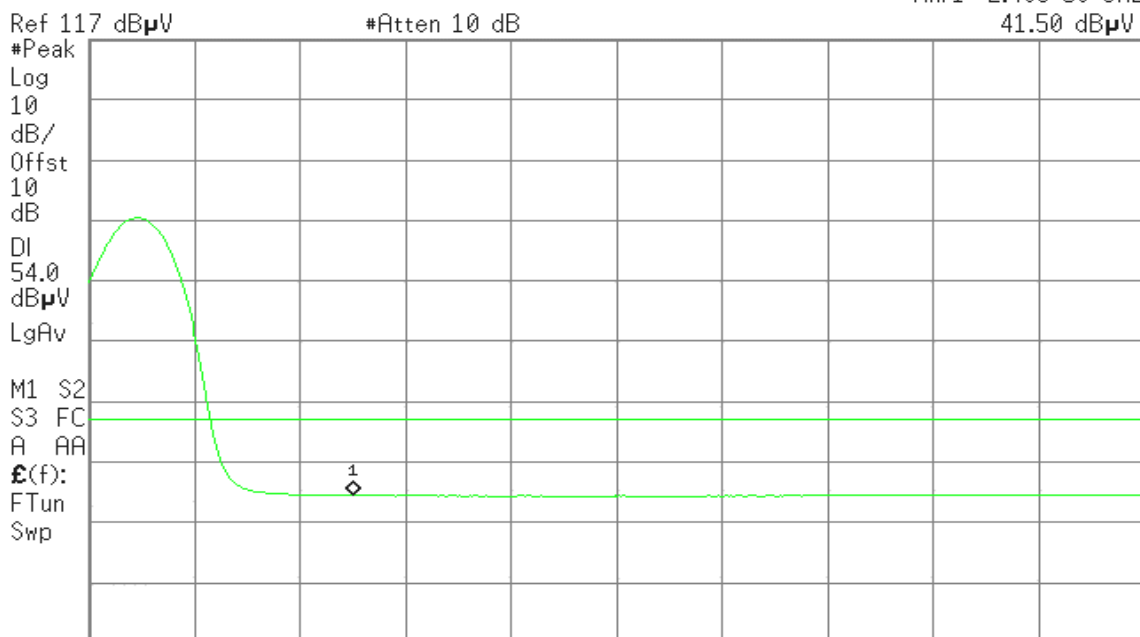



**Detector mode: Peak**

**Polarity: Horizontal**

Agilent 20:09:03 Jun 12, 2007

R T

Mkr1 2.483 50 GHz  
54.45 dBμV

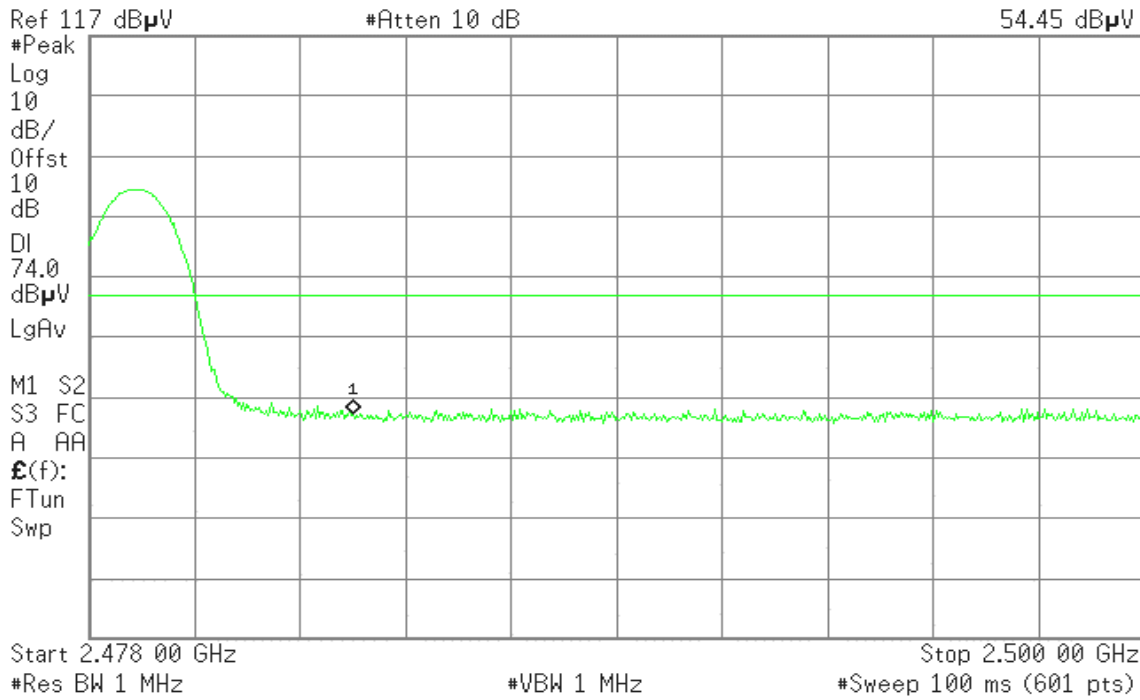

**Detector mode: Average**

**Polarity: Horizontal**

Agilent 20:09:43 Jun 12, 2007

R T

Mkr1 2.483 50 GHz  
41.65 dBμV

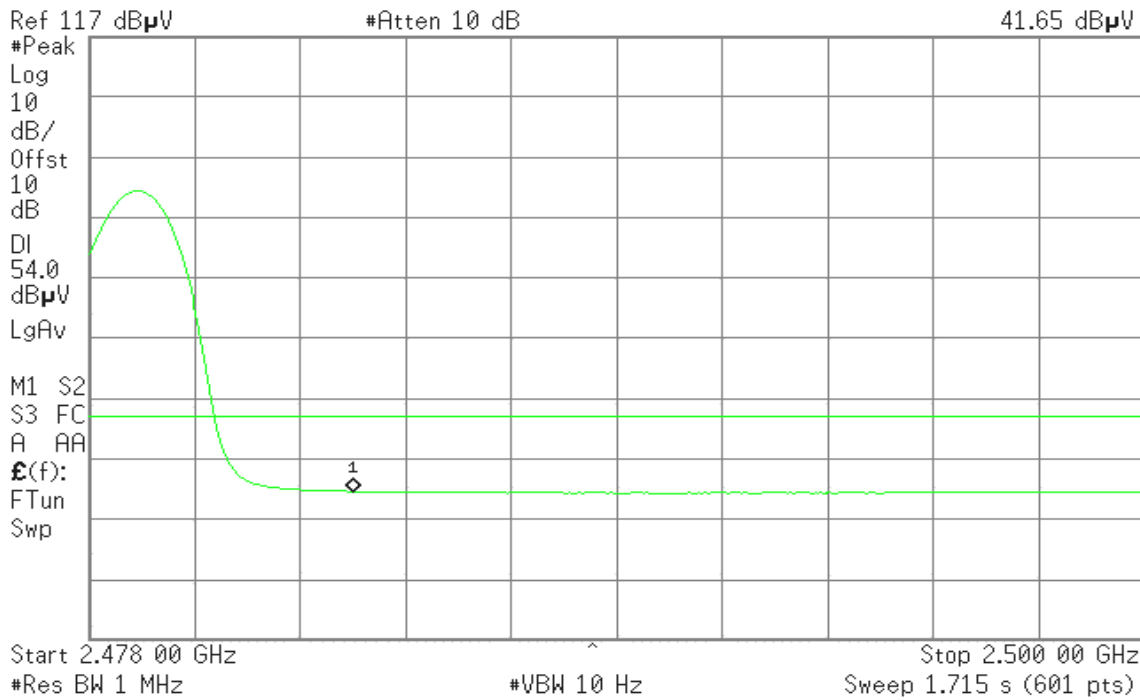



## 7.3 SPURIOUS EMISSION

### LIMIT

1. In the section 15.249(a):

Except as provided in paragraph (b) of this section, the field strength of emissions from intentional radiators operated within these frequency bands shall comply with the following:

Fundamental Frequency (MHz)	Field Strength of Fundamental Field Strength (mV/m)	Field Strength of Harmonics ( $\mu$ V/m)
902-928 MHz	50	500
2400 - 2483.5 MHz	50	500
5725 - 5875 MHz	50	500
24.0 - 24.25 GHz	250	2500

2. Except as provided elsewhere in this Subpart, the emissions from an intentional radiator shall not exceed the field strength levels specified in the following table:

Frequency (MHz)	Field Strength ( $\mu$ V/m)	Measurement Distance (m)
30-88	100*	3
88-216	150*	3
216-960	200*	3
Above 960	500	3

**Remark:** Except as provided in paragraph (g), fundamental emissions from intentional radiators operating under this Section shall not be located in the frequency bands 54-72 MHz, 76-88 MHz, 174-216 MHz or 470-806 MHz. However, operation within these frequency bands is permitted under other sections of this Part, e.g., Sections 15.231 and 15.241.

3. In the above emission table, the tighter limit applies at the band edges.

Frequency (MHz)	Field Strength ( $\mu$ V/m at 3-meter)	Field Strength (dB $\mu$ V/m at 3-meter)
30-88	100	40
88-216	150	43.5
216-960	200	46
Above 960	500	54

### Test Configuration

#### **Below 1 GHz**

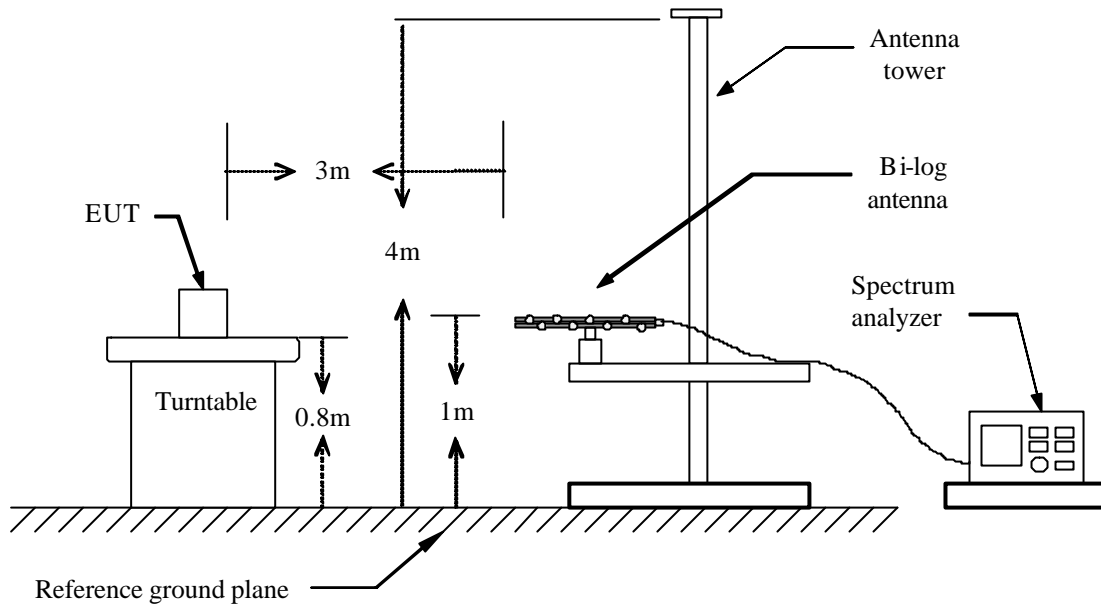

#### **Above 1 GHz**

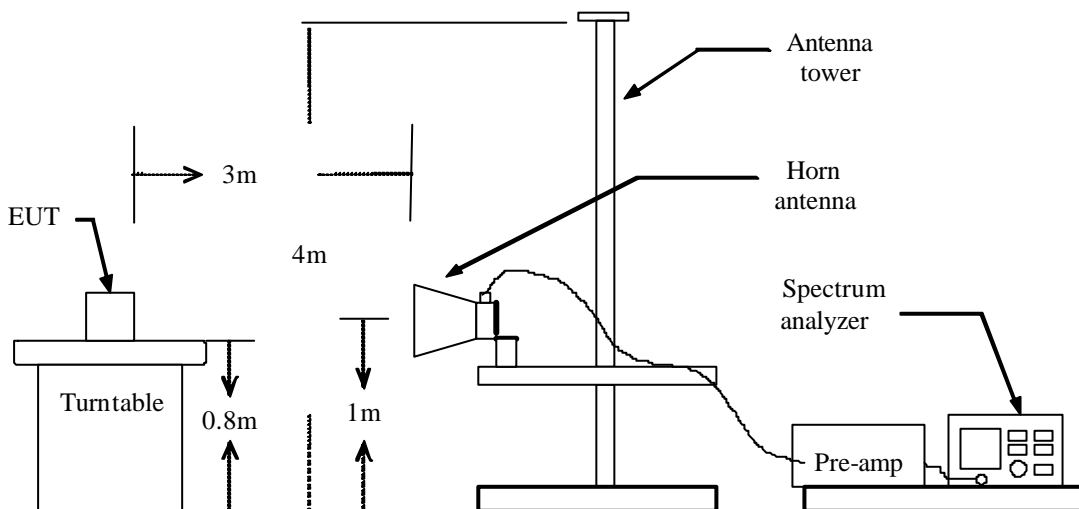



## **TEST PROCEDURE**

1. The EUT is placed on a turntable, which is 0.8m above ground plane.
2. The turntable shall be rotated for 360 degrees to determine the position of maximum emission level.
3. EUT is set 3m away from the receiving antenna, which is varied from 1m to 4m to find out the highest emissions.
4. Maximum procedure was performed on the six highest emissions to ensure EUT compliance.
5. And also, each emission was to be maximized by changing the polarization of receiving antenna both horizontal and vertical.
6. Set the spectrum analyzer in the following setting as:  
Below 1GHz:  
RBW=100kHz / VBW=300kHz / Sweep=AUTO  
Above 1GHz:  
(a) PEAK: RBW=VBW=1MHz / Sweep=AUTO  
(b) AVERAGE: RBW=1MHz / VBW=10Hz / Sweep=AUTO
7. Repeat above procedures until the measurements for all frequencies are complete.

**TEST RESULTS***No non-compliance noted***Below 1 GHz****Operation Mode:** Normal Link**Test Date:** June 20, 2007**Temperature:** 25°C**Tested by:** Wolf Huang**Humidity:** 50% RH**Polarity:** Ver. / Hor.

Frequency (MHz)	Ant.Pol. (H/V)	Reading (dBuV)	Correction Factor (dB/m)	Result (dBuV/m)	Limit (dBuV/m)	Margin (dB)	Remark
42.93	V	44.95	-14.72	30.23	40.00	-9.77	Peak
283.82	V	46.12	-12.68	33.44	46.00	-12.56	Peak
330.70	V	36.55	-11.27	25.29	46.00	-20.71	Peak
500.45	V	37.90	-7.86	30.05	46.00	-15.95	Peak
579.67	V	38.23	-6.20	32.03	46.00	-13.97	Peak
856.12	V	30.04	-2.62	27.42	46.00	-18.58	Peak
133.47	H	41.12	-13.41	27.71	43.50	-15.79	Peak
277.35	H	49.02	-12.71	36.31	46.00	-9.69	Peak
332.32	H	40.53	-11.24	29.29	46.00	-16.71	Peak
413.15	H	41.02	-9.53	31.49	46.00	-14.51	Peak
582.90	H	36.00	-6.20	29.79	46.00	-16.21	Peak
862.58	H	33.12	-2.53	30.60	46.00	-15.40	Peak

**Remark:**

1. *Measuring frequencies from 30 MHz to the 1GHz.*
2. *Radiated emissions measured in frequency range from 30 MHz to 1000MHz were made with an instrument using peak/quasi-peak detector mode.*
3. *Quasi-peak test would be performed if the peak result were greater than the quasi-peak limit or as required by the applicant.*
4. *Measurements above show only up to 6 maximum emissions noted, or would be lesser, with " N/A " remark, if no specific emissions from the EUT are recorded (ie: margin>20dB from the applicable limit) and considered that's already beyond the background noise floor.*
5. *Margin (dB) = Remark result (dBuV/m) – Quasi-peak limit (dBuV/m).*

**Above 1 GHz****Operation Mode:** Tx / CH Low**Test Date:** June 12, 2007**Temperature:** 25°C**Tested by:** Wolf Huang**Humidity:** 50% RH**Polarity:** Ver. / Hor.

Freq. (MHz)	Ant. Pol H/V	Peak Reading (dBuV)	AV Reading (dBuV)	Ant. / CL CF (dB)	Result		Peak Limit (dBuV/m)	AV Limit (dBuV/m)	Margin (dB)	Remark
					Peak (dBuV/m)	AV (dBuV/m)				
2402.00	V	87.60	---	-4.00	83.60	---	114.00	94.00	-30.40	Peak
1600.00	V	48.20	---	-8.98	39.22	---	74.00	54.00	-14.78	Peak
4800.00	V	55.65	52.03	0.53	56.18	52.56	74.00	54.00	-1.44	AVG
7208.33	V	47.83	---	3.60	51.43	---	74.00	54.00	-2.57	Peak
N/A										
2402.00	H	93.19	---	-4.00	89.20	---	114.00	94.00	-24.80	Peak
1600.00	H	53.28	---	-8.98	44.30	---	74.00	54.00	-9.70	Peak
3200.00	H	47.50	---	-2.19	45.31	---	74.00	54.00	-8.69	Peak
4000.00	H	50.55	---	-0.62	49.94	---	74.00	54.00	-4.06	Peak
4808.33	H	55.93	52.08	0.54	56.47	52.62	74.00	54.00	-1.38	AVG
7208.33	H	54.86	50.21	3.60	58.46	53.81	74.00	54.00	-0.19	AVG
N/A										

**Remark:**

1. Measuring frequencies from 1 GHz to the 10th harmonic of highest fundamental frequency.
2. Radiated emissions measured in frequency above 1000MHz were made with an instrument using peak/average detector mode.
3. Average test would be performed if the peak result were greater than the average limit or as required by the applicant.
4. Data of measurement within this frequency range shown " --- " in the table above means the reading of emissions are attenuated more than 20dB below the permissible limits or the field strength is too small to be measured.
5. Measurements above show only up to 6 maximum emissions noted, or would be lesser, with " N/A " remark, if no specific emissions from the EUT are recorded (ie: margin > 20dB from the applicable limit) and considered that's already beyond the background noise floor.
6. Margin (dB) = Remark result (dBuV/m) – Average limit (dBuV/m).

**Operation Mode:** Tx / CH Mid**Test Date:** June 12, 2007**Temperature:** 25°C**Tested by:** Wolf Huang**Humidity:** 50% RH**Polarity:** Ver. / Hor.

Freq. (MHz)	Ant. Pol H/V	Peak Reading (dBuV)	AV Reading (dBuV)	Ant. / CL CF (dB)	Result		Peak Limit (dBuV/m)	AV Limit (dBuV/m)	Margin (dB)	Remark
					Peak (dBuV/m)	AV (dBuV/m)				
2441.00	V	89.52	---	-3.90	85.62	---	114.00	94.00	-28.38	Peak
1626.67	V	46.15	---	-8.72	37.43	---	74.00	54.00	-16.57	Peak
3258.33	V	44.91	---	-2.12	42.79	---	74.00	54.00	-11.21	Peak
4066.67	V	46.76	---	-0.50	46.25	---	74.00	54.00	-7.75	Peak
4883.33	V	56.45	52.37	0.61	57.06	52.98	74.00	54.00	-1.02	AVG
5700.00	V	45.56	---	1.68	47.24	---	74.00	54.00	-6.76	Peak
7325.00	V	47.22	---	3.38	50.60	---	74.00	54.00	-3.40	Peak
2441.00	H	94.14	---	-3.90	90.25	---	114.00	94.00	-23.75	Peak
1626.67	H	50.70	---	-8.72	41.99	---	74.00	54.00	-12.01	Peak
3258.33	H	48.73	---	-2.12	46.61	---	74.00	54.00	-7.39	Peak
4066.67	H	48.61	---	-0.50	48.11	---	74.00	54.00	-5.89	Peak
4883.33	H	57.43	53.12	0.61	58.04	53.73	74.00	54.00	-0.27	AVG
7325.00	H	47.36	---	3.38	50.74	---	74.00	54.00	-3.26	Peak
N/A										

**Remark:**

1. Measuring frequencies from 1 GHz to the 10th harmonic of highest fundamental frequency.
2. Radiated emissions measured in frequency above 1000MHz were made with an instrument using peak/average detector mode.
3. Average test would be performed if the peak result were greater than the average limit or as required by the applicant.
4. Data of measurement within this frequency range shown " --- " in the table above means the reading of emissions are attenuated more than 20dB below the permissible limits or the field strength is too small to be measured.
5. Measurements above show only up to 6 maximum emissions noted, or would be lesser, with " N/A " remark, if no specific emissions from the EUT are recorded (ie: margin > 20dB from the applicable limit) and considered that's already beyond the background noise floor.
6. Margin (dB) = Remark result (dBuV/m) – Average limit (dBuV/m). Peak detector mode and average detector mode of the emission shown in Result column.



**Operation Mode:** Tx / CH High**Test Date:** June 12, 2007**Temperature:** 25°C**Tested by:** Wolf Huang**Humidity:** 50% RH**Polarity:** Ver. / Hor.

Freq. (MHz)	Ant. Pol H/V	Peak Reading (dBuV)	AV Reading (dBuV)	Ant. / CL CF (dB)	Result		Peak Limit (dBuV/m)	AV Limit (dBuV/m)	Margin (dB)	Remark
					Peak (dBuV/m)	AV (dBuV/m)				
2479.00	V	89.14	---	-3.80	85.33	---	114.00	94.00	-28.67	Peak
1653.33	V	46.30	---	-8.45	37.85	---	74.00	54.00	-16.15	Peak
4133.33	V	46.05	---	-0.39	45.66	---	74.00	54.00	-8.34	Peak
4958.33	V	53.15	---	0.68	53.84	---	74.00	54.00	-0.16	Peak
7433.33	V	46.35	---	3.17	49.52	---	74.00	54.00	-4.48	Peak
N/A										
2479.00	H	92.74	---	-3.80	88.94	---	114.00	94.00	-25.06	Peak
1653.33	H	50.02	---	-8.45	41.57	---	74.00	54.00	-12.43	Peak
3308.33	H	49.56	---	-2.06	47.50	---	74.00	54.00	-6.50	Peak
4133.33	H	47.30	---	-0.39	46.92	---	74.00	54.00	-7.08	Peak
4958.33	H	56.73	53.16	0.68	57.41	53.84	74.00	54.00	-0.16	AVG
7433.33	H	46.98	---	3.17	50.15	---	74.00	54.00	-3.85	Peak
N/A										

**Remark:**

1. Measuring frequencies from 1 GHz to the 10th harmonic of highest fundamental frequency.
2. Radiated emissions measured in frequency above 1000MHz were made with an instrument using peak//average detector mode.
3. Average test would be performed if the peak result were greater than the average limit or as required by the applicant.
4. Data of measurement within this frequency range shown " --- " in the table above means the reading of emissions are attenuated more than 20dB below the permissible limits or the field strength is too small to be measured.
5. Measurements above show only up to 6 maximum emissions noted, or would be lesser, with " N/A " remark, if no specific emissions from the EUT are recorded (ie: margin>20dB from the applicable limit) and considered that's already beyond the background noise floor.
6. Margin (dB) = Remark result (dBuV/m) – Average limit (dBuV/m). Peak detector mode and average detector mode of the emission shown in Result column.



## 7.4 POWERLINE CONDUCTED EMISSIONS

### LIMIT

According to §15.207(a), except as shown in paragraphs (b) and (c) of this section, for an intentional radiator that is designed to be connected to the public utility (AC) power line, the radio frequency voltage that is conducted back onto the AC power line on any frequency or frequencies within the band 150 kHz to 30 MHz shall not exceed the limits in the following table, as measured using a 50  $\mu$ H/50 ohms line impedance stabilization network (LISN). Compliance with the provisions of this paragraph shall be based on the measurement of the radio frequency voltage between each power line and ground at the power terminal. The lower limit applies at the boundary between the frequency ranges.

Frequency Range (MHz)	Limits (dB $\mu$ V)	
	Quasi-peak	Average
0.15 to 0.50	66 to 56*	56 to 46*
0.50 to 5	56	46
5 to 30	60	50

\* Decreases with the logarithm of the frequency.

### Test Configuration

See test photographs attached in Appendix 1 for the actual connections between EUT and support equipment.

### TEST PROCEDURE

1. The EUT was placed on a table, which is 0.8m above ground plane.
2. Maximum procedure was performed on the six highest emissions to ensure EUT compliance.
3. Repeat above procedures until all frequency measured were complete.

### TEST RESULTS

*Not Applicable, since this EUT is battery powered, this test item is not applicable.*