



FCC 47 CFR PART 15 SUBPART E

TEST REPORT

For

Wireless AC1200 Dual Band USB Adapter

Model: GWU735

Trade Name: IOGEAR

Issued to

**ATEN Technology, Inc., dba IOGEAR
19641 Da Vinci Foothill Ranch California United States 92610**

Issued by

**Compliance Certification Services Inc.
No.11, Wugong 6th Rd., Wugu Dist.,
New Taipei City 24891, Taiwan. (R.O.C.)
<http://www.ccsrf.com>
service@ccsrf.com
Issued Date: September 3, 2014**



Note: This report shall not be reproduced except in full, without the written approval of Compliance Certification Services Inc. This document may be altered or revised by Compliance Certification Services Inc. personnel only, and shall be noted in the revision section of the document.



Revision History

Rev.	Issue Date	Revisions	Effect Page	Revised By
00	September 3, 2014	Initial Issue	ALL	Kelly Cheng



TABLE OF CONTENTS

1. TEST RESULT CERTIFICATION.....	4
2. EUT DESCRIPTION	5
3. TEST METHODOLOGY	7
3.1 EUT CONFIGURATION	7
3.2 EUT EXERCISE	7
3.3 GENERAL TEST PROCEDURES.....	7
3.4 FCC PART 15.205 RESTRICTED BANDS OF OPERATIONS.....	8
3.5 DESCRIPTION OF TEST MODES.....	9
4. INSTRUMENT CALIBRATION.....	10
4.1 MEASURING INSTRUMENT CALIBRATION	10
4.2 MEASUREMENT EQUIPMENT USED.....	10
4.3 MEASUREMENT UNCERTAINTY.....	11
5. FACILITIES AND ACCREDITATIONS	12
5.1 FACILITIES	12
5.2 EQUIPMENT	12
5.3 TABLE OF ACCREDITATIONS AND LISTINGS	13
6. SETUP OF EQUIPMENT UNDER TEST	14
6.1 SETUP CONFIGURATION OF EUT	14
6.2 SUPPORT EQUIPMENT	14
7. FCC PART 15 REQUIREMENTS.....	15
7.1 26 DB EMISSION BANDWIDTH	15
7.2 PEAK POWER	33
7.3 AVERAGE POWER.....	37
7.4 BAND EDGES MEASUREMENT	40
7.5 PEAK POWER SPECTRAL DENSITY	49
7.6 RADIATED UNDESIRABLE EMISSION.....	67
7.7 POWERLINE CONDUCTED EMISSIONS	90
7.8 FREQUENCY STABILITY	93
APPENDIX I PHOTOGRAPHS OF TEST SETUP	103



1. TEST RESULT CERTIFICATION

Applicant: ATEN Technology, Inc., dba IOGEAR
8F, No.150, Jian Yi Rd, Zhonghe District, New Taipei City,
235, Taiwan

Equipment Under Test: Wireless AC1200 Dual Band USB Adapter

Trade Name: IOGEAR

Model: GWU735

Date of Test: May 26 ~ June 4, 2014

APPLICABLE STANDARDS	
STANDARD	TEST RESULT
FCC 47 CFR Part 15 Subpart E	No non-compliance noted

We hereby certify that:

Compliance Certification Services Inc. tested the above equipment. The test data, data evaluation, test procedures, and equipment configurations shown in this report were made in accordance with the procedures given in ANSI C63.4: 2009 and the energy emitted by the sample EUT tested as described in this report is in compliance with conducted and radiated emission limits of FCC Rules Part 15.407.

The test results of this report relate only to the tested sample identified in this report.

Approved by:

Reviewed by:

Miller Lee
Section Manager
Compliance Certification Services Inc.

Angel Cheng
Section Manager
Compliance Certification Services Inc.



2. EUT DESCRIPTION

Product	Wireless AC1200 Dual Band USB Adapter			
Trade Name	IOGEAR			
Model Number	GWU735			
Model Discrepancy	N/A			
Received Date	July 9, 2014			
Power Supply	Powered from host device			
Operating Frequency Range & Number of Channels	UNII Band I	Mode	Frequency Range (MHz)	Number of Channels
		IEEE 802.11a	5180 – 5240	4 Channels
		IEEE 802.11n HT 20 mode	5180 – 5240	4 Channels
		IEEE 802.11n HT 40 mode	5190 – 5230	2 Channels
	UNII Band IV	IEEE 802.11n HT 80 mode	5210	1 Channels
		IEEE 802.11a	5745 – 5825	5 Channels
		IEEE 802.11n HT 20 mode	5745 – 5825	5 Channels
		IEEE 802.11n HT 40 mode	5755 – 5795	2 Channels
IEEE 802.11n HT 80 mode	5775	1 Channels		
Transmit Power	IEEE 802.11a mode / 5180 ~ 5240MHz: 17.81dBm IEEE 802.11n HT 20 mode / 5180 ~ 5240MHz: 18.69dBm IEEE 802.11n HT 40 mode / 5190 ~ 5230MHz: 16.87dBm IEEE 802.11n HT 80 mode / 5210MHz: 16.85dBm IEEE 802.11a mode / 5745 ~ 5825MHz: 17.43dBm IEEE 802.11n HT 20 mode / 5745 ~ 5825MHz: 18.39dBm IEEE 802.11n HT 40 mode / 5755 ~ 5795MHz: 16.83dBm IEEE 802.11n HT 80 mode / 5775MHz: 16.70dBm			
Modulation Technique	OFDM (QPSK, BPSK, 16-QAM, 64-QAM)			
Transmit Data Rate	IEEE 802.11a mode: 54, 48, 36, 24, 18, 12, 9, 6 Mbps IEEE 802.11n HT 20 mode: OFDM (6.50, 13.00, 19.50, 26.00, 39.00, 52.00, 58.50, 65.00, 78.00, 104.0, 117.0, 130.0, 156.0, 175.5, 195.0Mbps) IEEE 802.11n HT 40 mode: OFDM (13.50, 27.00, 40.50, 54.00, 81.00, 108.0, 121.5, 135.0, 162.0, 216.0, 243.0, 270.0, 324.0, 364.5, 405.0Mbps) IEEE 802.11n HT 80 mode: OFDM (29.3, 58.5, 87.8, 117, 175.5, 234, 263.3, 292.5, 351, 390, 468, 526.5, 585, 702, 780 Mbps)			
Antenna Specification	Gain: 5.9dBi			
Antenna Designation	Model name: 10G032500-0D Manufacture: REALTEK Printed PIFA Antenna MIMO: Total ANT=5.9+10*LOG(2)=8.9 dBi			



Operation Frequency

UNLICENSED NATIONAL INFORMATION INFRASTRUCTURE (U-NII)	
CHANNEL	MHz
36	5180
38	5190
40	5200
46	5230
48	5240
52	5260
54	5270
62	5310
64	5350
149	5745
153	5765
157	5785
161	5805
165	5825

Remark:

1. *The sample selected for test was engineering sample that approximated to production product and was provided by manufacturer.*
2. *This submittal(s) (test report) is intended for FCC ID: **QLEGWU735** filing to comply with Section 15.407 of the FCC Part 15, Subpart E Rules.*



3. TEST METHODOLOGY

Both conducted and radiated testing was performed according to the procedures in ANSI C63.4. Radiated testing was performed at an antenna to EUT distance 3 meters.

3.1 EUT CONFIGURATION

The EUT configuration for testing is installed for RF field strength measurement to meet the Commissions requirement, and is operated in a manner intended to generate the maximum emission in a continuous normal application.

3.2 EUT EXERCISE

The EUT is operated in the engineering mode to fix the Tx frequency for the purposes of measurement.

According to its specifications, the EUT must comply with the requirements of Section 15.407 under the FCC Rules Part 15 Subpart E.

3.3 GENERAL TEST PROCEDURES

Conducted Emissions

The EUT is placed on the turntable, which is positioned at 0.8 m above the ground plane. According to the requirements in Section 13.1.4.1 of ANSI C63.4, the conducted emission from the EUT is measured in the frequency range between 0.15 MHz and 30MHz, using the CISPR Quasi-Peak detector mode.

Radiated Emissions

The EUT is placed on the turntable, which is 0.8 m above the ground plane. The turntable is then rotated for 360 degrees to determine the proper orientation for the maximum emission level. The EUT is set 3m away from the receiving antenna, which is varied from 1m to 4m to find out the highest emission level. And, each emission is to be maximized by changing the horizontal and vertical polarization of the receiving antenna. In order to find out the maximum emissions, exploratory radiated emission measurements were made according to the requirements in Section 13.1.4.1 of ANSI C63.4.



3.4 FCC PART 15.205 RESTRICTED BANDS OF OPERATIONS

(a) Except as shown in paragraph (d) of this section, only spurious emissions are permitted in any of the frequency bands listed below:

MHz	MHz	MHz	GHz
0.090 - 0.110	16.42 - 16.423	399.9 - 410	4.5 - 5.15
¹ 0.495 - 0.505	16.69475 - 16.69525	608 - 614	5.35 - 5.46
2.1735 - 2.1905	16.80425 - 16.80475	960 - 1240	7.25 - 7.75
4.125 - 4.128	25.5 - 25.67	1300 - 1427	8.025 - 8.5
4.17725 - 4.17775	37.5 - 38.25	1435 - 1626.5	9.0 - 9.2
4.20725 - 4.20775	73 - 74.6	1645.5 - 1646.5	9.3 - 9.5
6.215 - 6.218	74.8 - 75.2	1660 - 1710	10.6 - 12.7
6.26775 - 6.26825	108 - 121.94	1718.8 - 1722.2	13.25 - 13.4
6.31175 - 6.31225	123 - 138	2200 - 2300	14.47 - 14.5
8.291 - 8.294	149.9 - 150.05	2310 - 2390	15.35 - 16.2
8.362 - 8.366	156.52475 -	2483.5 - 2500	17.7 - 21.4
8.37625 - 8.38675	156.52525	2655 - 2900	22.01 - 23.12
8.41425 - 8.41475	156.7 - 156.9	3260 - 3267	23.6 - 24.0
12.29 - 12.293	162.0125 - 167.17	3332 - 3339	31.2 - 31.8
12.51975 - 12.52025	167.72 - 173.2	3345.8 - 3358	36.43 - 36.5
12.57675 - 12.57725	240 - 285	3600 - 4400	(²)
13.36 - 13.41	322 - 335.4		

¹ Until February 1, 1999, this restricted band shall be 0.490-0.510 MHz.

² Above 38.6

(b) Except as provided in paragraphs (d) and (e), the field strength of emissions appearing within these frequency bands shall not exceed the limits shown in Section 15.209. At frequencies equal to or less than 1000 MHz, compliance with the limits in Section 15.209 shall be demonstrated using measurement instrumentation employing a CISPR quasi-peak detector. Above 1000 MHz, compliance with the emission limits in Section 15.209 shall be demonstrated based on the average value of the measured emissions. The provisions in Section 15.35 apply to these measurements.



3.5 DESCRIPTION OF TEST MODES

The EUT (model: GWU735) had been tested under operating condition.

The EUT is a 2x2 configuration spatial MIMO (2Tx & 2Rx) without beam forming function that operate in double TX chains and double RX chains. The 2x2 configuration is implemented with two outside TX & RX chains (Chain 0 and 1).

Software used to control the EUT for staying in continuous transmitting mode was programmed.

After verification, all tests were carried out with the worst case test modes as shown below except radiated spurious emission below 1GHz and power line conducted emissions below 30MHz, which worst case was in normal link mode only.

UNII Band I:

IEEE 802.11a mode / 5180 ~ 5240MHz:

Channel Low (5180MHz), Channel Mid (5220MHz) and Channel High (5240MHz) with 6Mbps data rate were chosen for full testing.

IEEE 802.11n HT 20 mode / 5180 ~ 5240MHz:

Channel Low (5180MHz), Channel Mid (5220MHz) and Channel High (5240MHz) with 6Mbps data rate were chosen for full testing.

IEEE 802.11n HT 40 mode / 5190 ~ 5230MHz:

Channel Low (5190MHz) and Channel High (5230MHz) with 13.5Mbps data rate were chosen for full testing.

IEEE 802.11n HT 80 MHz Channel for 5210MHz:

Channel Low(5210MHz) with 29.3Mbps data rate were chosen for full testing.

UNII Band VI:

IEEE 802.11a mode:

Channel Low (5745MHz), Channel Mid (5785MHz) and Channel High (5825MHz) with 6Mbps data rate were chosen for full testing.

IEEE 802.11n HT 20 mode:

Channel Low(5745MHz), Channel Mid(5785MHz) and Channel High(5825MHz) with 6.5Mbps data rate were chosen for full testing.

IEEE 802.11n HT 40 mode:

Channel Low(5755MHz) and Channel High(5795MHz) with 13.5Mbps data rate were chosen for full testing.

IEEE 802.11n HT 80 mode:

Channel Low(5775MHz) with 29.3Mbps data rate were chosen for full testing.



4. INSTRUMENT CALIBRATION

4.1 MEASURING INSTRUMENT CALIBRATION

The measuring equipment, which was utilized in performing the tests documented herein, has been calibrated in accordance with the manufacturer's recommendations for utilizing calibration equipment, which is traceable to recognized national standards.

4.2 MEASUREMENT EQUIPMENT USED

Equipment Used for Emissions Measurement

Remark: Each piece of equipment is scheduled for calibration once a year and Loop Antenna is scheduled for calibration once three years.

Conducted Emissions Test Site				
Name of Equipment	Manufacturer	Model	Serial Number	Calibration Due
Spectrum Analyzer	Agilent	E4446A	MY43360131	03/26/2015
Power Meter	Anritsu	ML2495A	1012009	06/03/2015
Power Sensor	Anritsu	MA2411A	0917072	06/03/2015

3M Chamber Test Site				
Name of Equipment	Manufacturer	Model	Serial Number	Calibration Due
Spectrum Analyzer	Agilent	E4446A	US42510268	11/05/2014
EMI Test Receiver	R&S	ESCI	100064	02/16/2015
Pre-Amplifier	Mini-Circuits	ZFL-1000LN	SF350700823	01/11/2015
Pre-Amplifier	MITEQ	AFS44-00102650-42-10P-44	1415367	11/18/2014
Bilog Antenna	Sunol Sciences	JB3	A030105	10/01/2014
Horn Antenna	EMCO	3117	00055165	02/16/2015
Horn Antenna	EMCO	3116	2487	10/09/2014
Loop Antenna	EMCO	6502	8905/2356	06/11/2015
Turn Table	CCS	CC-T-1F	N/A	N.C.R
Antenna Tower	CCS	CC-A-1F	N/A	N.C.R
Controller	CCS	CC-C-1F	N/A	N.C.R
Site NSA	CCS	N/A	N/A	12/21/2014
Test S/W	EZ-EMC (CCS-3A1RE)			

Conducted Emission room # A				
Name of Equipment	Manufacturer	Model	Serial Number	Calibration Due
EMI Test Receiver	R&S	ESI	101203	09/12/2014
LISN	R&S	ESH3-Z5	848773/014	12/05/2014
Coaxial Cable	Commate	CFD300-NL	NA	12/05/2014
Test S/W	CCS-3A1-CE			



4.3 MEASUREMENT UNCERTAINTY

PARAMETER	UNCERTAINTY
Powerline Conducted Emission	+/- 1.2159
3M Semi Anechoic Chamber / <200M	+/- 4.0138
3M Semi Anechoic Chamber / 200M~1000M	+/- 3.9483
3M Semi Anechoic Chamber / 1G~8G	+/- 2.5975
3M Semi Anechoic Chamber / 8G~18G	+/- 2.6112
3M Semi Anechoic Chamber / 18G~26G	+/- 2.7389
3M Semi Anechoic Chamber / 26G~40G	+/- 2.9683

Remark: This uncertainty represents an expanded uncertainty expressed at approximately the 95% confidence level using a coverage factor of $k=2$.



5. FACILITIES AND ACCREDITATIONS

5.1 FACILITIES

All measurement facilities used to collect the measurement data are located at

No.199, Chunghsen Road, Hsintien City, Taipei Hsien, Taiwan, R.O.C.

Tel: 886-2-2217-0894 / Fax: 886-2-2217-1029

No.11, Wugong 6th Rd., Wugu Dist., New Taipei City 24891, Taiwan. (R.O.C.)

Tel: 886-2-2299-9720 / Fax: 886-2-2298-4045

No.81-1, Lane 210, Bade 2nd Rd., Lujhu Township, Taoyuan County 33841, TAIWAN, R.O.C.

Tel: 886-3-324-0332 / Fax: 886-3-324-5235

The sites are constructed in conformance with the requirements of ANSI C63.7, ANSI C63.4 and CISPR Publication 22.

5.2 EQUIPMENT

Radiated emissions are measured with one or more of the following types of linearly polarized antennas: tuned dipole, biconical, log periodic, bi-log, and/or ridged waveguide, horn. Spectrum analyzers with pre-selectors and quasi-peak detectors are used to perform radiated measurements.



Conducted emissions are measured with Line Impedance Stabilization Networks and EMI Test Receivers.

Calibrated wideband preamplifiers, coaxial cables, and coaxial attenuators are also used for making measurements.

All receiving equipment conforms to CISPR Publication 16-1, "Radio Interference Measuring Apparatus and Measurement Methods."



5.3 TABLE OF ACCREDITATIONS AND LISTINGS

Country	Agency	Scope of Accreditation	Logo
USA	FCC	3M Semi Anechoic Chamber (FCC MRA: TW1039) to perform FCC Part 15 measurements	 FCC MRA: TW1039
Taiwan	TAF	LP0002, RTTE01, FCC Method-47 CFR Part 15 Subpart C, D, E, RSS-210, RSS-310 IDA TS SRD, AS/NZS 4268, AS/NZS 4771, TS 12.1 & 12.2, ETSI EN 300 440-1, ETSI EN 300 440-2, ETSI EN 300 328, ETSI EN 300 220-1, ETSI EN 300 220-2, ETSI EN 301 893, ETSI EN 301 489-1/3/7/17 FCC OET Bulletin 65 + Supplement C, EN 50360, EN 50361, EN 50371, RSS 102, EN 50383, EN 50385, EN 50392, IEC 62209, CNS 14958-1, CNS 14959 FCC Method -47 CFR Part 15 Subpart B IEC / EN 61000-3-2, IEC / EN 61000-3-3, IEC / EN 61000-4-2/3/4/5/6/8/11	
Canada	Industry Canada	3M Semi Anechoic Chamber (IC 2324G-1 / IC 2324G-2) to perform	

* No part of this report may be used to claim or imply product endorsement by A2LA or any agency of the US Government.



6. SETUP OF EQUIPMENT UNDER TEST

6.1 SETUP CONFIGURATION OF EUT

See test photographs attached in Appendix II for the actual connections between EUT and support equipment.

6.2 SUPPORT EQUIPMENT

No	Equipment	Brand	Model	Series No.	FCC ID	Data Cable	Power Cord
1	Notebook PC	TOSHIBA	Satellite M840	N/A	PPD-AR5B225	N/A	AC I/P: Unshielded, 1.8m DC O/P: Unshielded, 1.8m with a core
2	Notebook PC	IBM	7663 (T61)	L3E9812	N/A	N/A	AC I/P: Unshielded, 1.8m DC O/P: Unshielded, 1.8m with a core

Remark:

1. All the equipment/cables were placed in the worst-case configuration to maximize the emission during the test.
2. Grounding was established in accordance with the manufacturer's requirements and conditions for the intended use.



7. FCC PART 15 REQUIREMENTS

7.1 26 DB EMISSION BANDWIDTH

LIMIT

According to §15.303(c), for purposes of this subpart the emission bandwidth shall be determined by measuring the width of the signal between two points, one below the carrier center frequency and one above the carrier center frequency, that are 26 dB down relative to the maximum level of the modulated carrier. Compliance with the emissions limits is based on the use of measurement instrumentation employing a peak detector function with an instrument resolutions bandwidth approximately equal to 1.0 percent of the emission bandwidth of the device under measurement.

Test Configuration

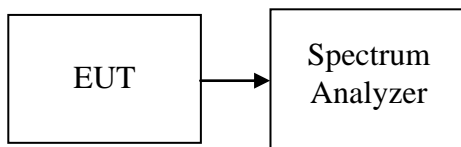

TEST PROCEDURE

1. Place the EUT on the table and set it in the transmitting mode.
2. Remove the antenna from the EUT and then connect a low-loss RF cable from the antenna port to the spectrum analyzer.
3. Set the spectrum analyzer as $RBW = 1\%EBW$, $VBW = RBW$, $Span = 50MHz$, and $Sweep = auto$.
Or Set the spectrum analyzer as $RBW > 1\%EBW$, $VBW > RBW$, $Span > 26dB$ bandwidth, and $Sweep = auto$.
4. Mark the peak frequency and $-26dB$ (upper and lower) frequency.
5. Repeat until all the rest channels were investigated.



TEST RESULTS

No non-compliance noted

Test Data

Test mode: IEEE 802.11a mode / 5180 ~ 5240MHz

Channel	Frequency (MHz)	Bandwidth (MHz)
Low	5180	23.521
Mid	5220	21.534
High	5240	23.432

Test mode: IEEE 802.11n HT 20 mode / 5180 ~ 5240MHz / Chain 0

Channel	Frequency (MHz)	Bandwidth (MHz)
Low	5180	21.965
Mid	5220	21.758
High	5240	21.866

Test mode: IEEE 802.11n HT 20 mode / 5180 ~ 5240MHz / Chain 1

Channel	Frequency (MHz)	Bandwidth (MHz)
Low	5180	21.357
Mid	5220	21.391
High	5240	21.280

Test mode: IEEE 802.11n HT 40 mode / 5190 ~ 5230MHz / Chain 0

Channel	Frequency (MHz)	Bandwidth (MHz)
Low	5190	43.849
High	5230	43.874

Test mode: IEEE 802.11n HT 40 mode / 5190 ~ 5230MHz / Chain 1

Channel	Frequency (MHz)	Bandwidth (MHz)
Low	5190	43.658
High	5230	43.078

Test mode: IEEE 802.11n HT 80 mode / 5210MHz / Chain 0

Channel	Frequency (MHz)	Bandwidth (B) (MHz)
Mid	5210	84.391

Test mode: IEEE 802.11n HT 80 mode / 5210MHz / Chain 1

Channel	Frequency (MHz)	Bandwidth (B) (MHz)
Mid	5210	83.886



Test mode: IEEE 802.11a mode / 5745 ~ 5825MHz

Channel	Frequency (MHz)	Bandwidth (MHz)
Low	5745	16.586
Mid	5785	16.501
High	5825	16.521

Test mode: IEEE 802.11n HT 20 mode / 5745 ~ 5825MHz / Chain 0

Channel	Frequency (MHz)	Bandwidth (MHz)
Low	5745	17.717
Mid	5785	17.713
High	5825	17.753

Test mode: IEEE 802.11n HT 20 mode / 5745 ~ 5825MHz / Chain 1

Channel	Frequency (MHz)	Bandwidth (MHz)
Low	5745	17.691
Mid	5785	17.654
High	5825	17.671

Test mode: IEEE 802.11n HT 40 mode / 5755 ~ 5795MHz / Chain 0

Channel	Frequency (MHz)	Bandwidth (MHz)
Low	5755	36.211
High	5795	36.451

Test mode: IEEE 802.11n HT 40 mode / 5755 ~ 5795MHz / Chain 1

Channel	Frequency (MHz)	Bandwidth (MHz)
Low	5755	36.104
High	5795	36.329

Test mode: IEEE 802.11n HT 80 mode / 5775MHz / Chain 0

Channel	Frequency (MHz)	Bandwidth (B) (MHz)
Mid	5290	76.596

Test mode: IEEE 802.11n HT 80 mode / 5775MHz / Chain 1

Channel	Frequency (MHz)	Bandwidth (B) (MHz)
Mid	5290	76.322



Test Plot

IEEE 802.11a mode / 5180 ~ 5240MHz

CH Low

Agilent

R T

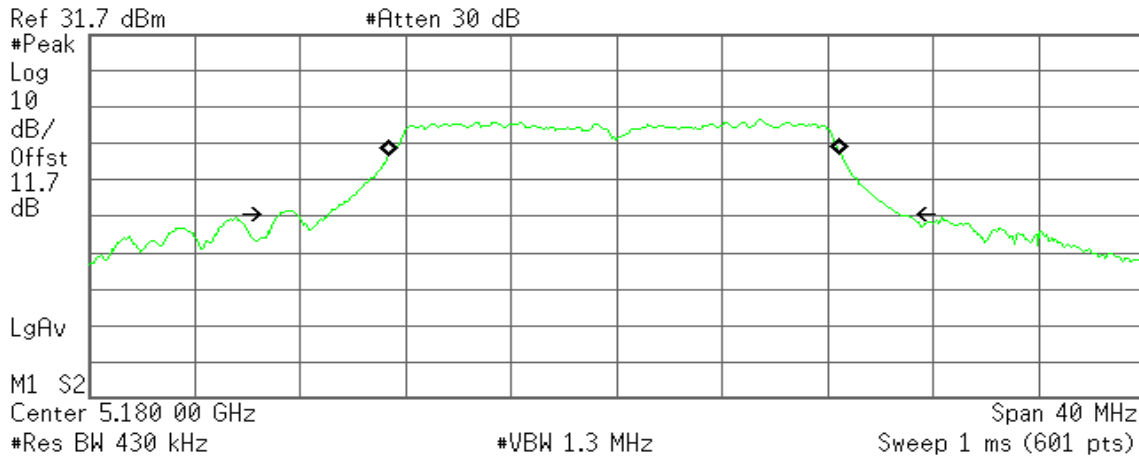

Occupied Bandwidth

17.1594 MHz

Occ BW % Pwr 99.00 %
x dB -26.00 dB

Transmit Freq Error -94.296 kHz
x dB Bandwidth 23.521 MHz

CH Mid

Agilent

R T

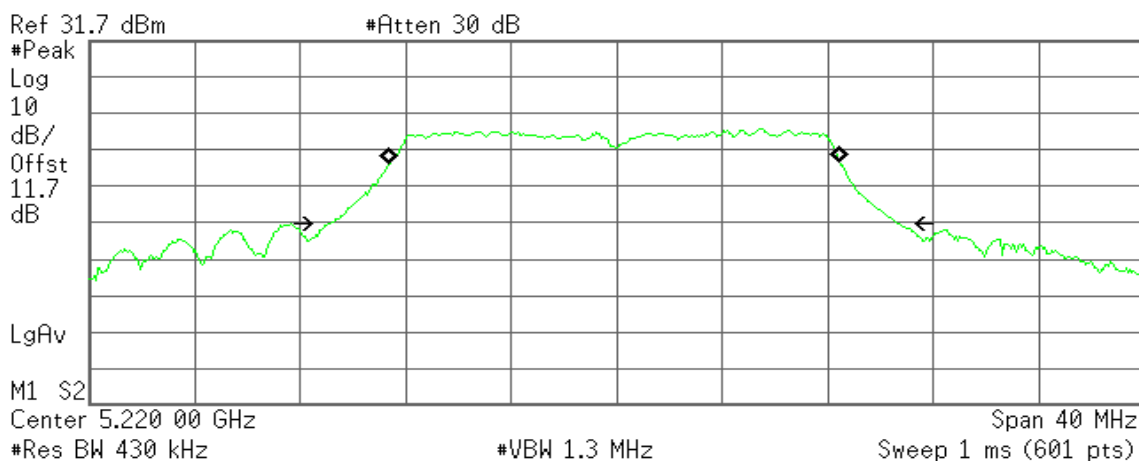

Occupied Bandwidth

17.1089 MHz

Occ BW % Pwr 99.00 %
x dB -26.00 dB

Transmit Freq Error -95.523 kHz
x dB Bandwidth 21.534 MHz



CH High

Agilent

R T

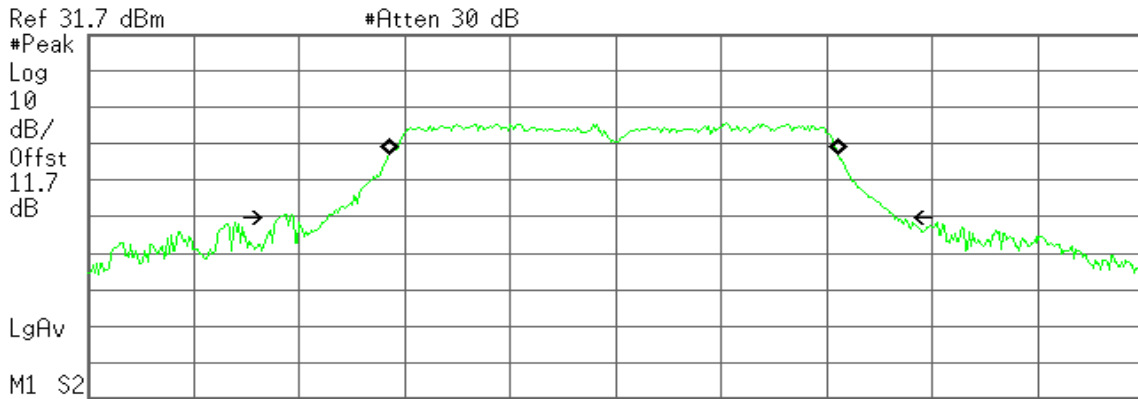

Occupied Bandwidth
17.0799 MHz

Occ BW % Pwr 99.00 %
x dB -26.00 dB

Transmit Freq Error -84.336 kHz
x dB Bandwidth 23.432 MHz

IEEE 802.11n HT 20 mode / 5180 ~ 5240MHz / Chain 0

CH Low

Agilent

R T

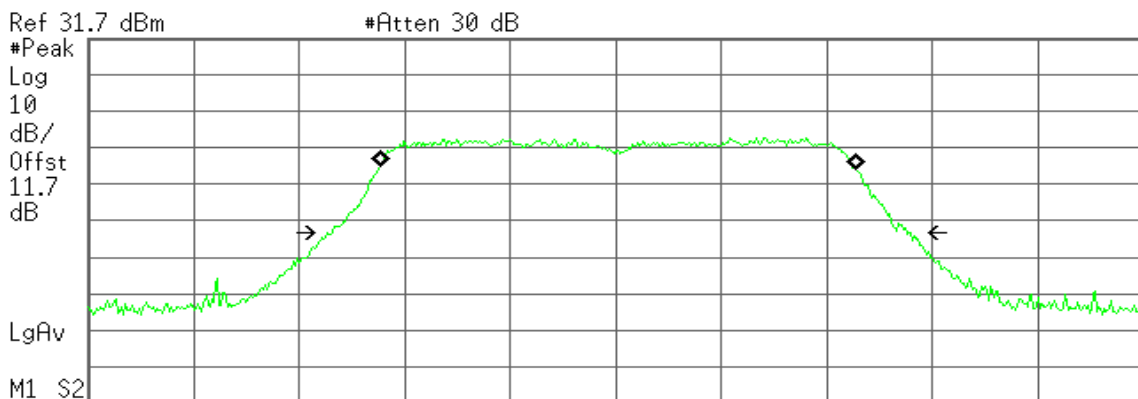

Occupied Bandwidth
18.0423 MHz

Occ BW % Pwr 99.00 %
x dB -26.00 dB

Transmit Freq Error 79.455 kHz
x dB Bandwidth 21.965 MHz



CH Mid

Agilent

R T

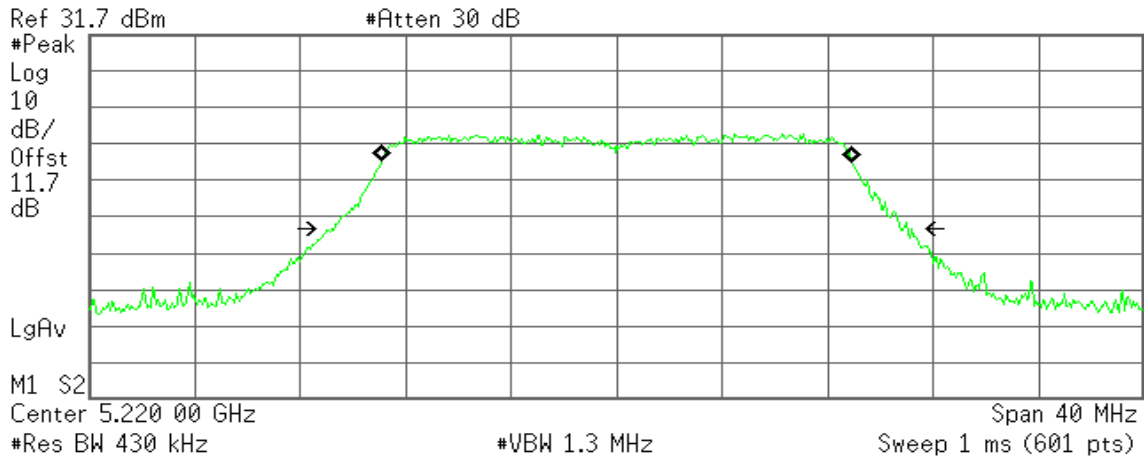

Occupied Bandwidth
17.8732 MHz

Occ BW % Pwr 99.00 %
x dB -26.00 dB

Transmit Freq Error 23.009 kHz
x dB Bandwidth 21.758 MHz

CH High

Agilent

R T

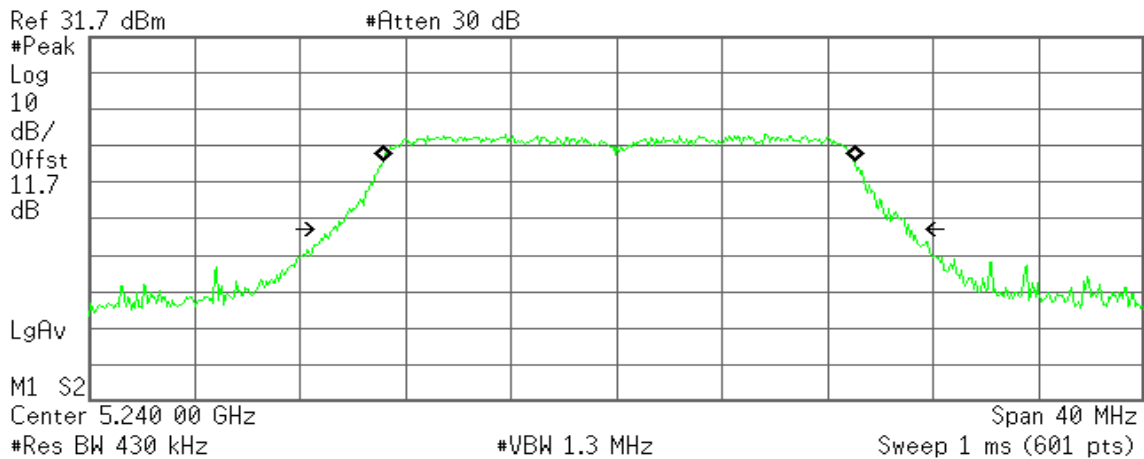

Occupied Bandwidth
17.9105 MHz

Occ BW % Pwr 99.00 %
x dB -26.00 dB

Transmit Freq Error 78.218 kHz
x dB Bandwidth 21.866 MHz



IEEE 802.11n HT 20 mode / 5180 ~ 5240MHz / Chain 1

CH Low

Agilent

R T

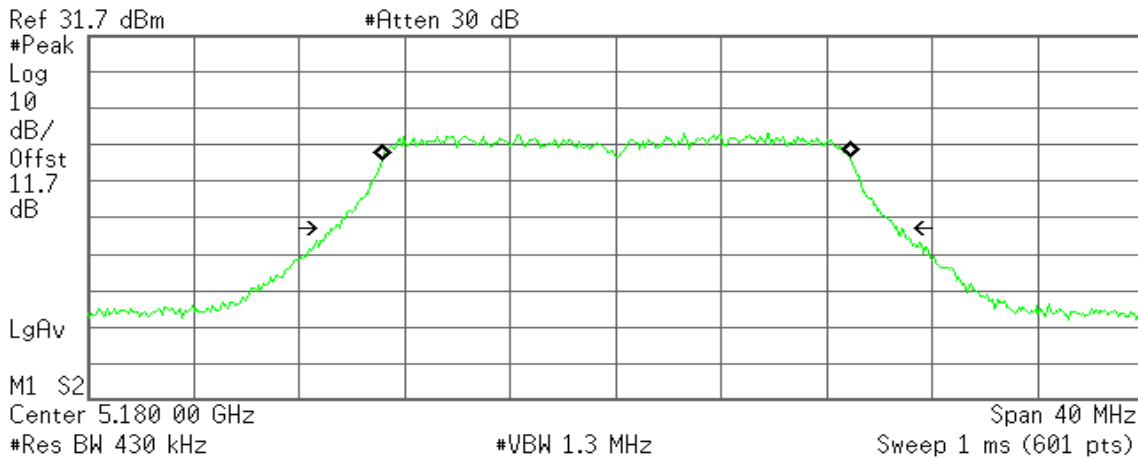

Occupied Bandwidth

17.8140 MHz

Occ BW % Pwr 99.00 %
x dB -26.00 dB

Transmit Freq Error 34.834 kHz
x dB Bandwidth 21.357 MHz

CH Mid

Agilent

R T

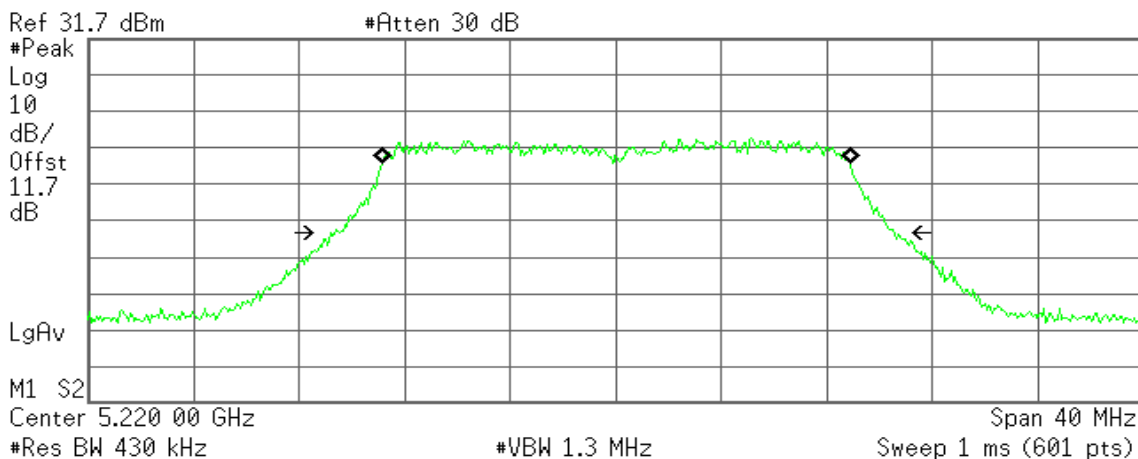

Occupied Bandwidth

17.8094 MHz

Occ BW % Pwr 99.00 %
x dB -26.00 dB

Transmit Freq Error 23.336 kHz
x dB Bandwidth 21.391 MHz



CH High

Agilent

R T

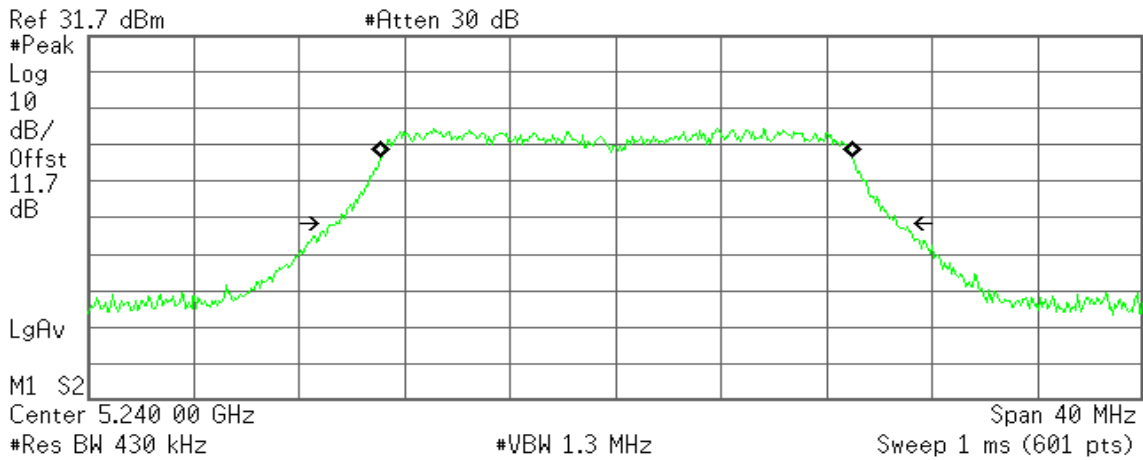

Occupied Bandwidth
17.8785 MHz

Occ BW % Pwr 99.00 %
x dB -26.00 dB

Transmit Freq Error 31.241 kHz
x dB Bandwidth 21.280 MHz

IEEE 802.11n HT 40 mode / 5190 ~ 5230MHz / Chain 0

CH Low

Agilent

R T

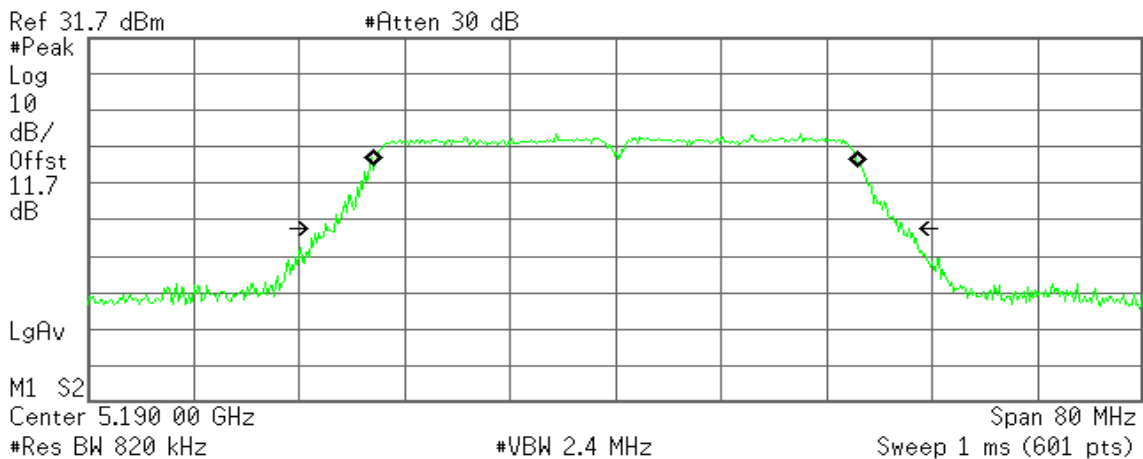

Occupied Bandwidth
36.8449 MHz

Occ BW % Pwr 99.00 %
x dB -26.00 dB

Transmit Freq Error -31.633 kHz
x dB Bandwidth 43.849 MHz



CH High

Agilent

R T

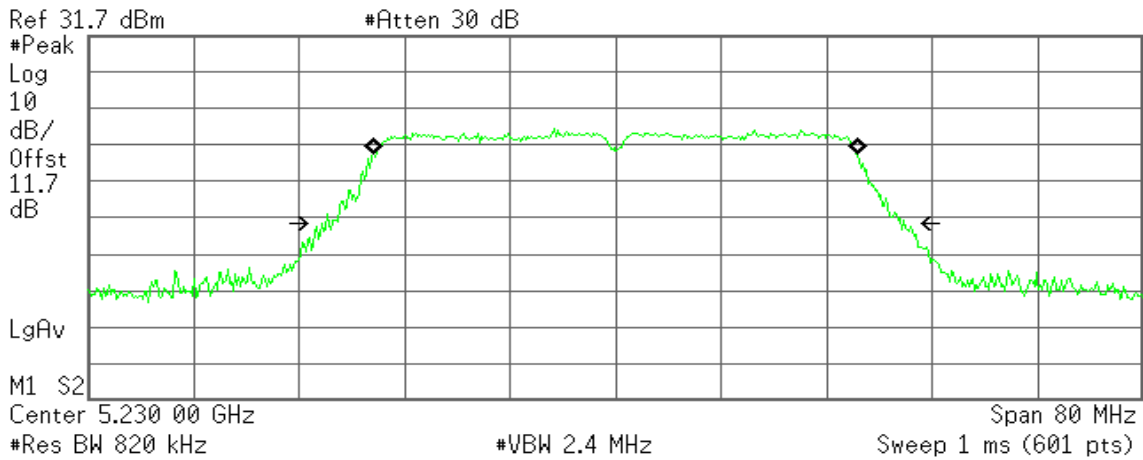

Occupied Bandwidth
36.8129 MHz

Occ BW % Pwr 99.00 %
x dB -26.00 dB

Transmit Freq Error -35.020 kHz
x dB Bandwidth 43.874 MHz

IEEE 802.11n HT 40 mode / 5190 ~ 5230MHz / Chain 1

CH Low

Agilent

R T

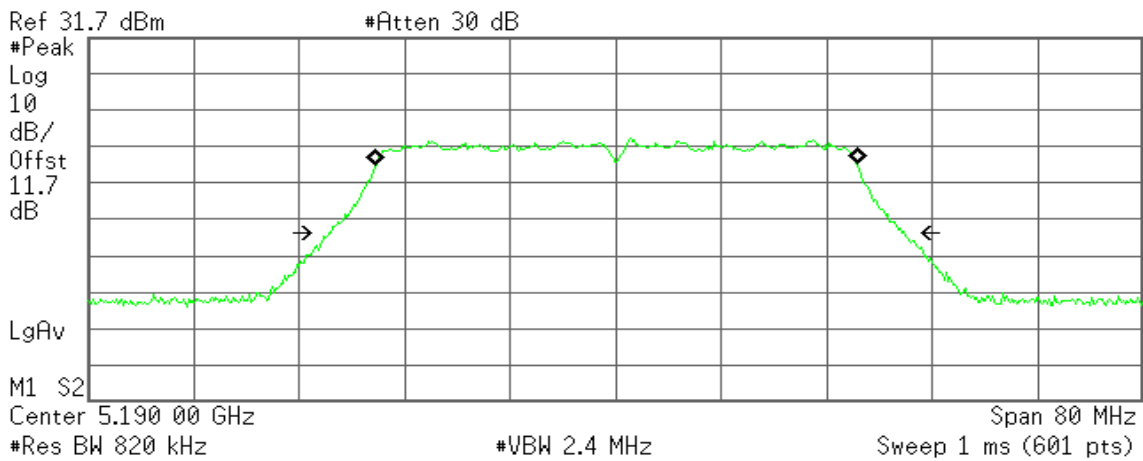

Occupied Bandwidth
36.5628 MHz

Occ BW % Pwr 99.00 %
x dB -26.00 dB

Transmit Freq Error 74.580 kHz
x dB Bandwidth 43.658 MHz



CH High

Agilent

R T

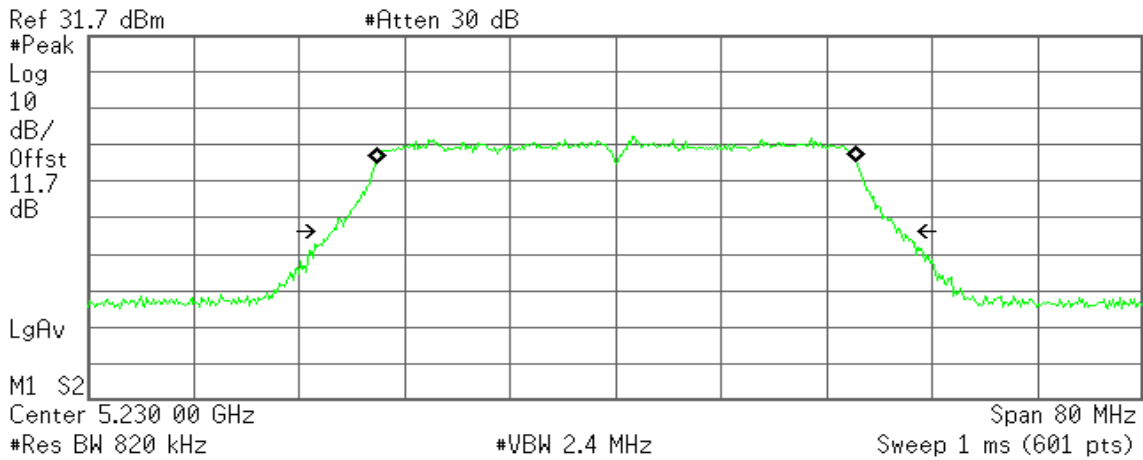

Occupied Bandwidth
36.4957 MHz

Occ BW % Pwr 99.00 %
x dB -26.00 dB

Transmit Freq Error 64.129 kHz
x dB Bandwidth 43.078 MHz

IEEE 802.11n HT 80 mode / 5210MHz / Chain 0

Agilent

R T

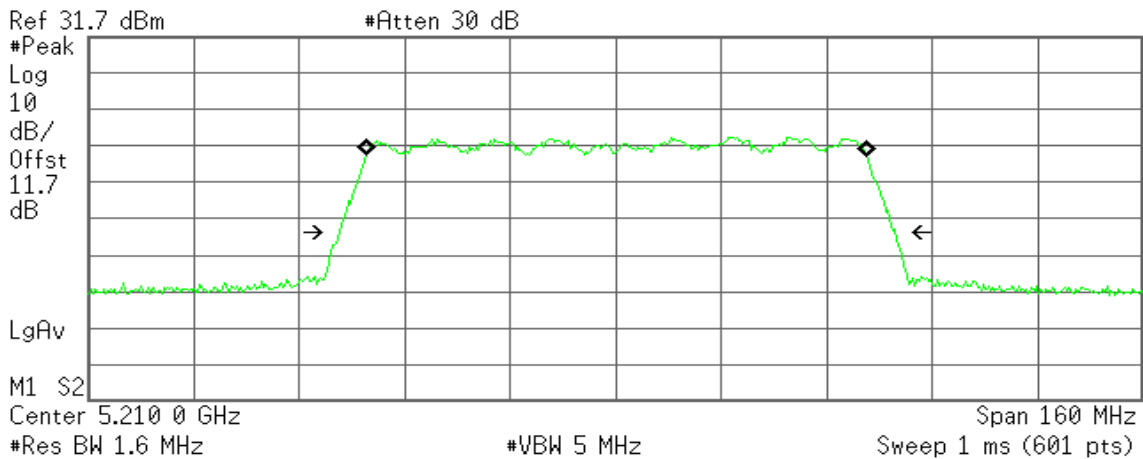

Occupied Bandwidth
76.0658 MHz

Occ BW % Pwr 99.00 %
x dB -26.00 dB

Transmit Freq Error 112.740 kHz
x dB Bandwidth 84.391 MHz



IEEE 802.11n HT 80 mode / 5210MHz / Chain 1

Agilent

R T

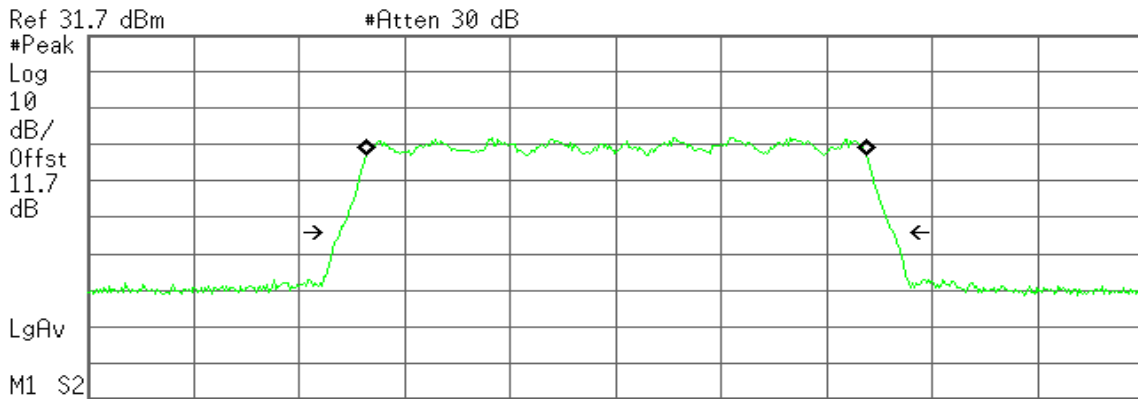

Ref 31.7 dBm #Atten 30 dB
 #Peak Log 10 dB/Offst 11.7 dB
 LgAv
 M1 S2
 Center 5.210 0 GHz Span 160 MHz
 #Res BW 1.6 MHz #VBW 5 MHz Sweep 1 ms (601 pts)

Occupied Bandwidth
75.9999 MHz

Occ BW % Pwr 99.00 %
x dB -26.00 dB

Transmit Freq Error 108.100 kHz
x dB Bandwidth 83.886 MHz

IEEE 802.11a mode / 5745 ~ 5825MHz

CH Low

Agilent

R T

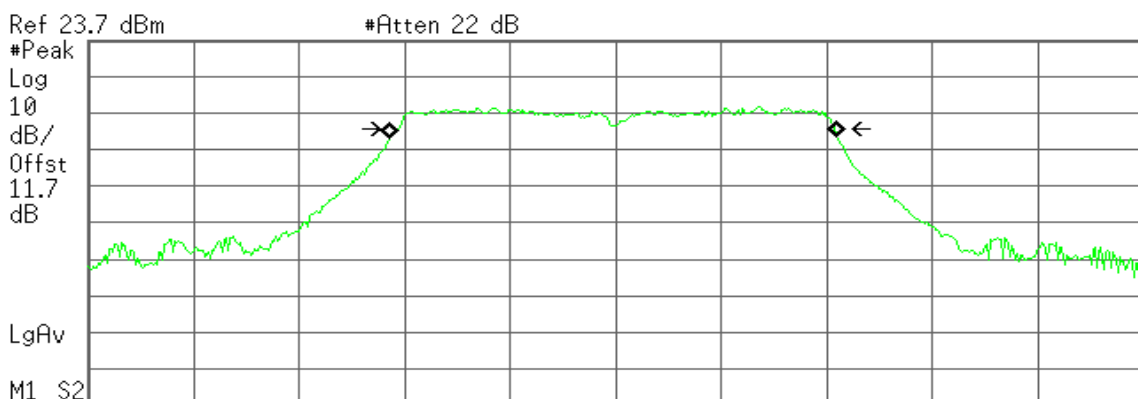

Ref 23.7 dBm #Atten 22 dB
 #Peak Log 10 dB/Offst 11.7 dB
 LgAv
 M1 S2
 Center 5.745 00 GHz Span 40 MHz
 #Res BW 430 kHz #VBW 1.3 MHz Sweep 1 ms (601 pts)

Occupied Bandwidth
17.0349 MHz

Occ BW % Pwr 99.00 %
x dB -6.00 dB

Transmit Freq Error -96.536 kHz
x dB Bandwidth 16.586 MHz



CH Mid

Agilent

R T

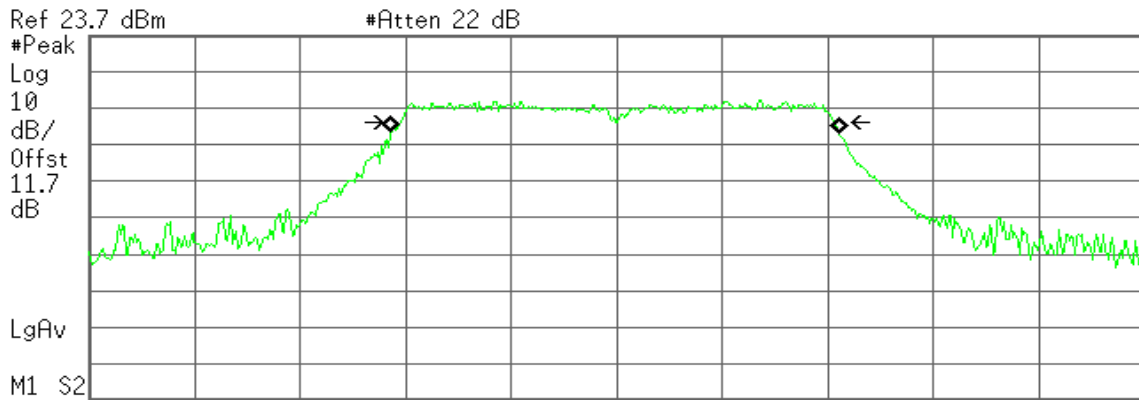

Occupied Bandwidth
17.0268 MHz

Occ BW % Pwr 99.00 %
x dB -6.00 dB

Transmit Freq Error -62.570 kHz
x dB Bandwidth 16.501 MHz

CH High

Agilent

R T

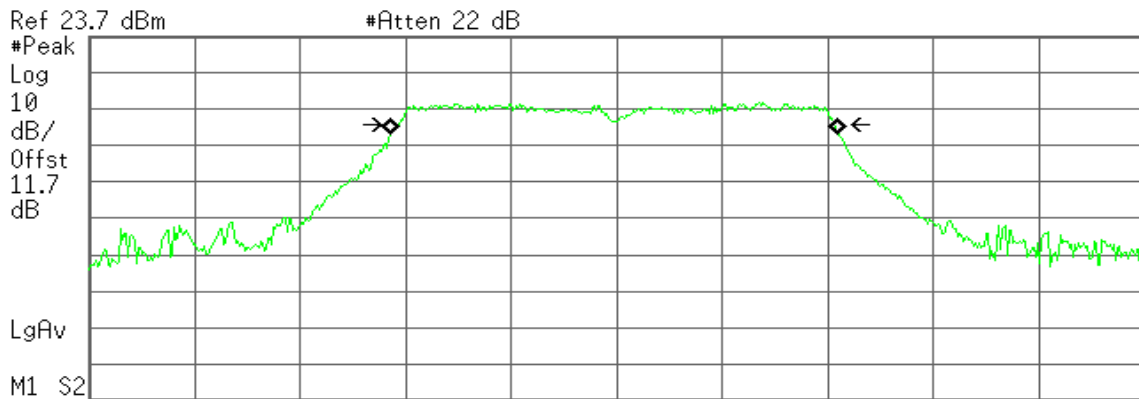

Occupied Bandwidth
17.0290 MHz

Occ BW % Pwr 99.00 %
x dB -6.00 dB

Transmit Freq Error -85.355 kHz
x dB Bandwidth 16.521 MHz



IEEE 802.11n HT 20 mode / 5745 ~ 5825MHz / Chain 0

CH Low

Agilent

R T

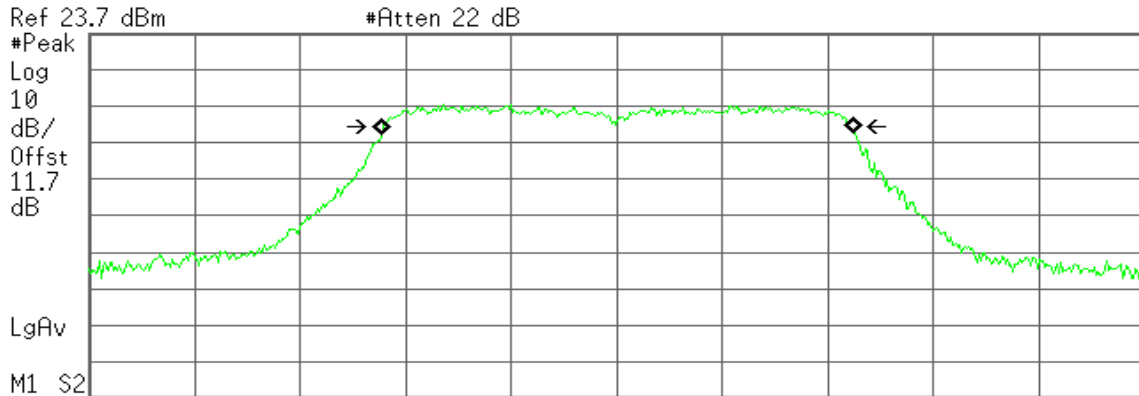

Center 5.745 00 GHz Span 40 MHz
 #Res BW 430 kHz #VBW 1.3 MHz Sweep 1 ms (601 pts)

Occupied Bandwidth
17.9418 MHz

Occ BW % Pwr 99.00 %
x dB -6.00 dB

Transmit Freq Error 42.673 kHz
x dB Bandwidth 17.717 MHz

CH Mid

Agilent

R T

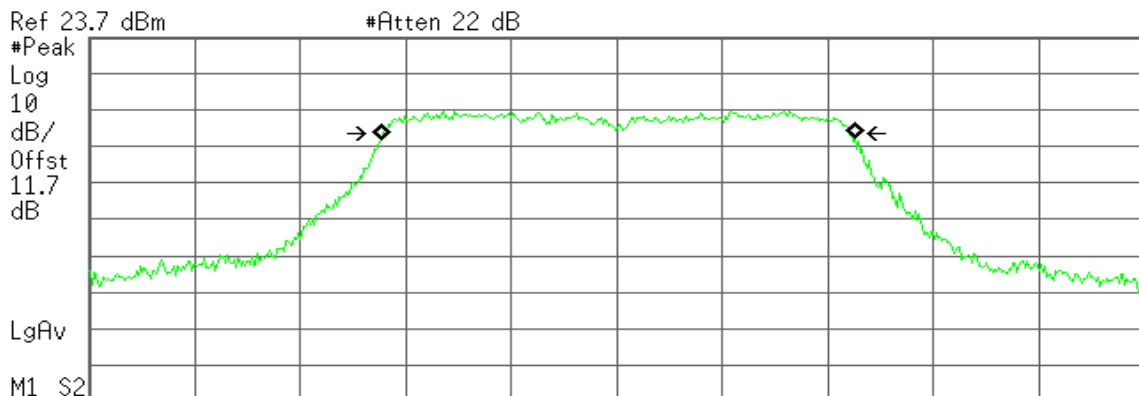

Center 5.785 00 GHz Span 40 MHz
 #Res BW 430 kHz #VBW 1.3 MHz Sweep 1 ms (601 pts)

Occupied Bandwidth
17.9792 MHz

Occ BW % Pwr 99.00 %
x dB -6.00 dB

Transmit Freq Error 53.509 kHz
x dB Bandwidth 17.713 MHz



CH High

Agilent

R T

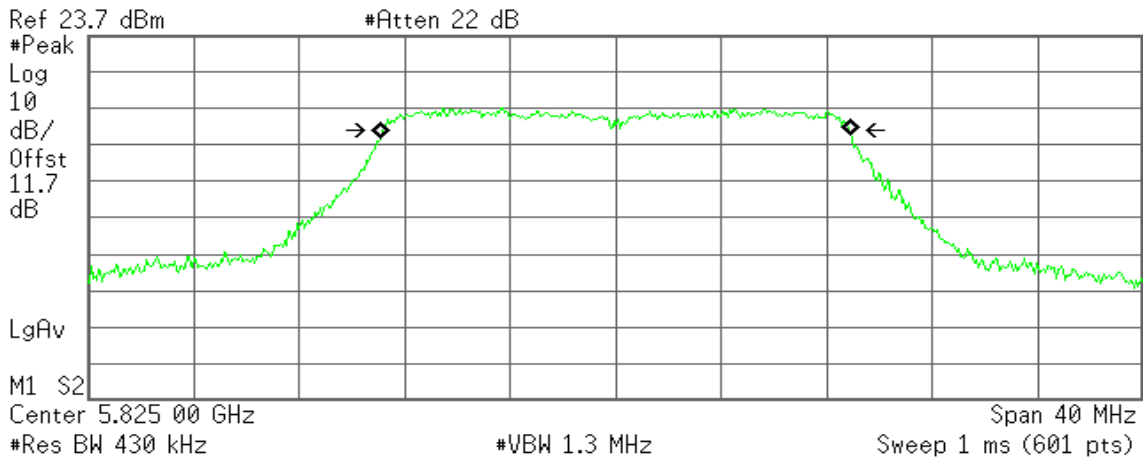

Occupied Bandwidth
17.8835 MHz

Occ BW % Pwr 99.00 %
x dB -6.00 dB

Transmit Freq Error 22.822 kHz
x dB Bandwidth 17.753 MHz

IEEE 802.11n HT 20 mode / 5745 ~ 5825MHz / Chain 1

CH Low

Agilent

R T

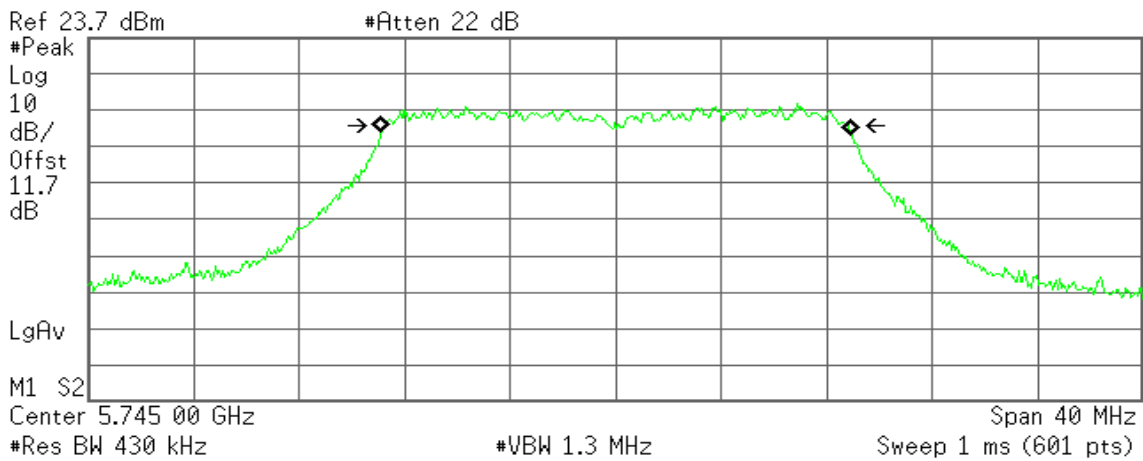

Occupied Bandwidth
17.8489 MHz

Occ BW % Pwr 99.00 %
x dB -6.00 dB

Transmit Freq Error 23.670 kHz
x dB Bandwidth 17.691 MHz



CH Mid

Agilent

R T

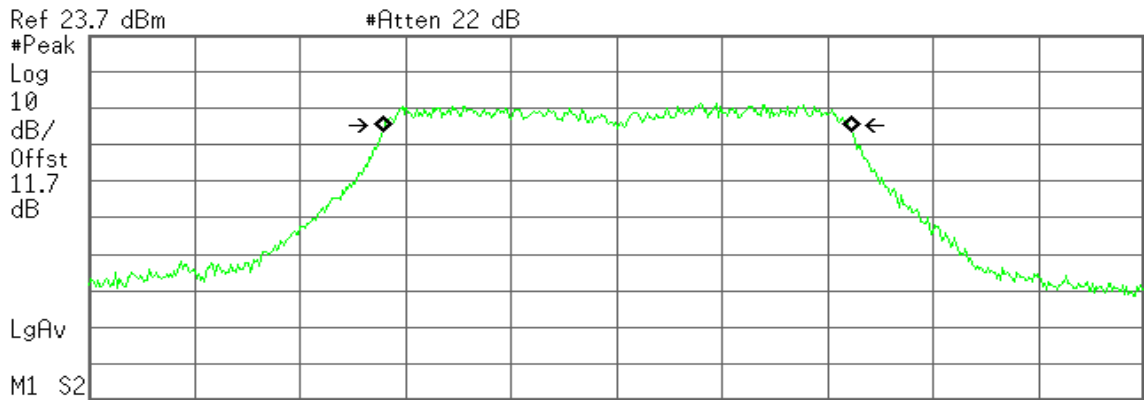

Occupied Bandwidth
17.8399 MHz

Occ BW % Pwr 99.00 %
x dB -6.00 dB

Transmit Freq Error 28.862 kHz
x dB Bandwidth 17.654 MHz

CH High

Agilent

R T

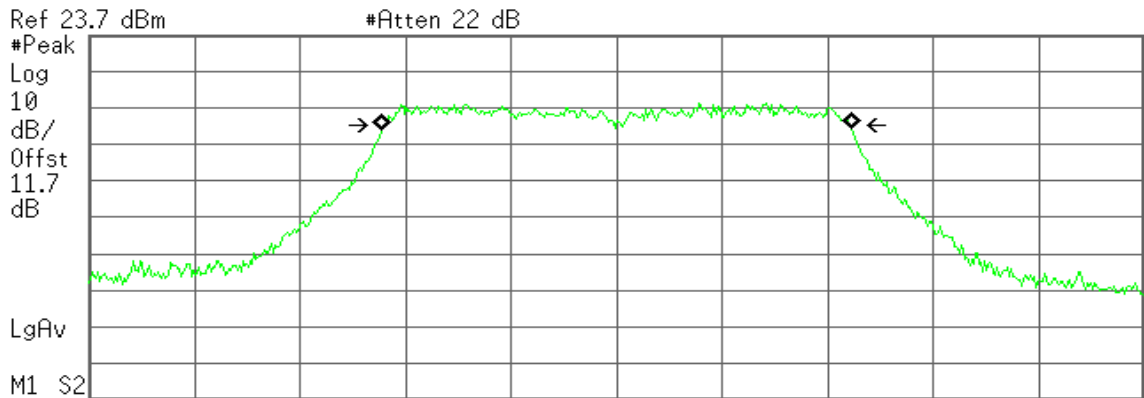

Occupied Bandwidth
17.8687 MHz

Occ BW % Pwr 99.00 %
x dB -6.00 dB

Transmit Freq Error 6.727 kHz
x dB Bandwidth 17.671 MHz



IEEE 802.11n HT 40 mode / 5755 ~ 5795MHz / Chain 0

CH Low

Agilent

R T

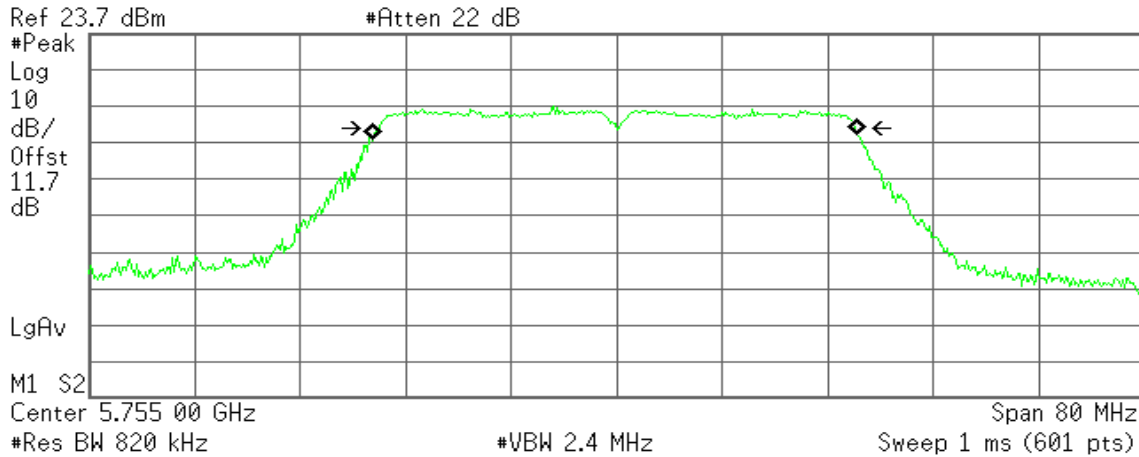

Occupied Bandwidth

36.8803 MHz

Occ BW % Pwr 99.00 %
x dB -6.00 dB

Transmit Freq Error -119.986 kHz
x dB Bandwidth 36.211 MHz

CH High

Agilent

R T

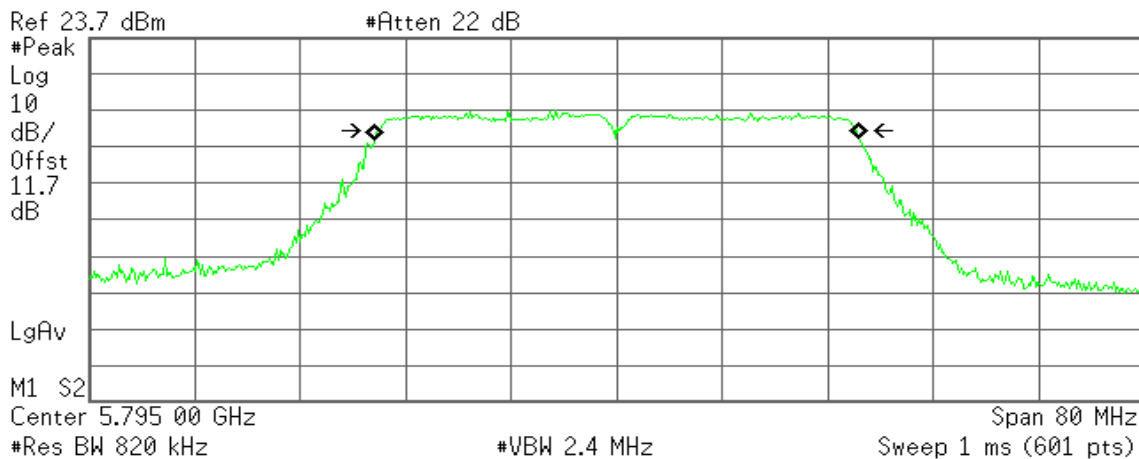

Occupied Bandwidth

36.7788 MHz

Occ BW % Pwr 99.00 %
x dB -6.00 dB

Transmit Freq Error 13.655 kHz
x dB Bandwidth 36.451 MHz



IEEE 802.11n HT 40 mode / 5755 ~ 5795MHz / Chain 1

CH Low

Agilent

R T

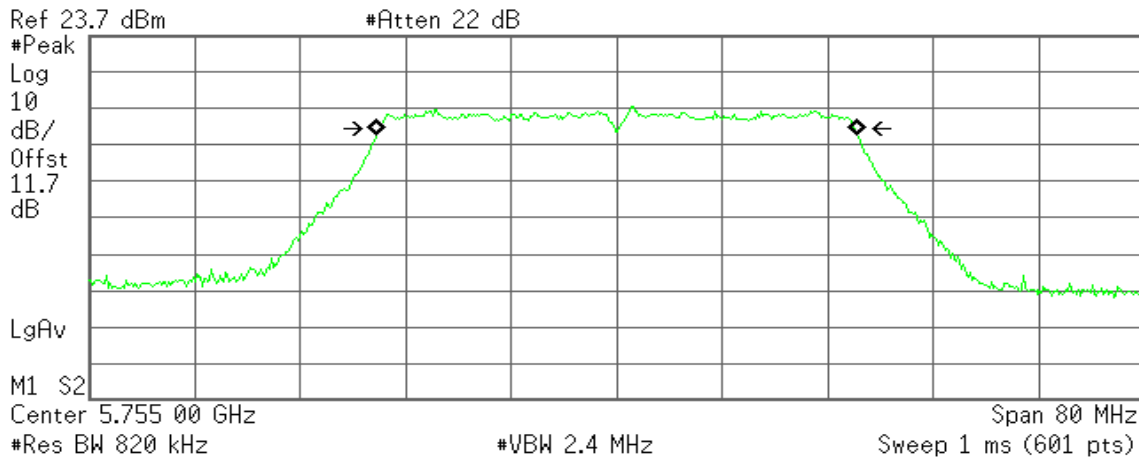

Occupied Bandwidth
36.5264 MHz

Occ BW % Pwr 99.00 %
x dB -6.00 dB

Transmit Freq Error 39.909 kHz
x dB Bandwidth 36.104 MHz

CH High

Agilent

R T

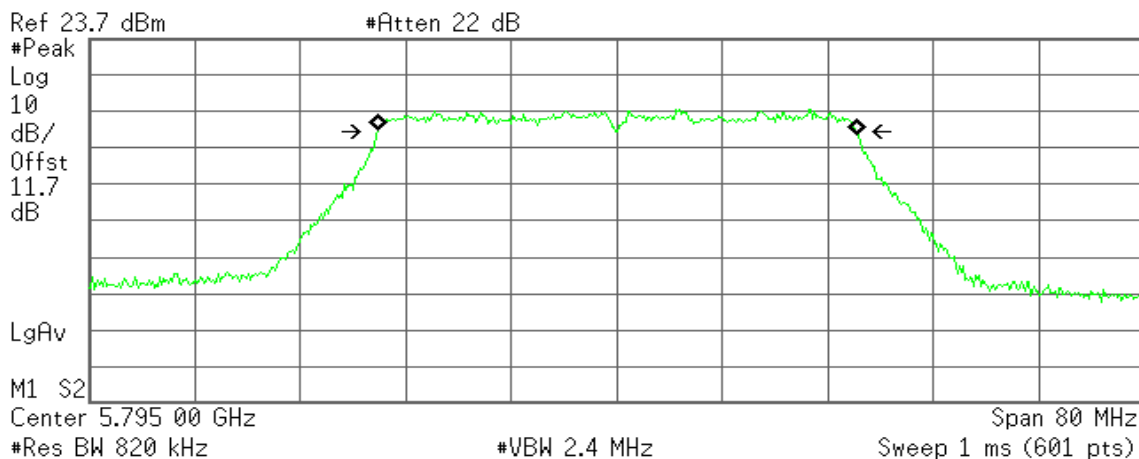

Occupied Bandwidth
36.4808 MHz

Occ BW % Pwr 99.00 %
x dB -6.00 dB

Transmit Freq Error 76.430 kHz
x dB Bandwidth 36.329 MHz



IEEE 802.11n HT 80 mode / 5775MHz / Chain 0

Agilent

R T

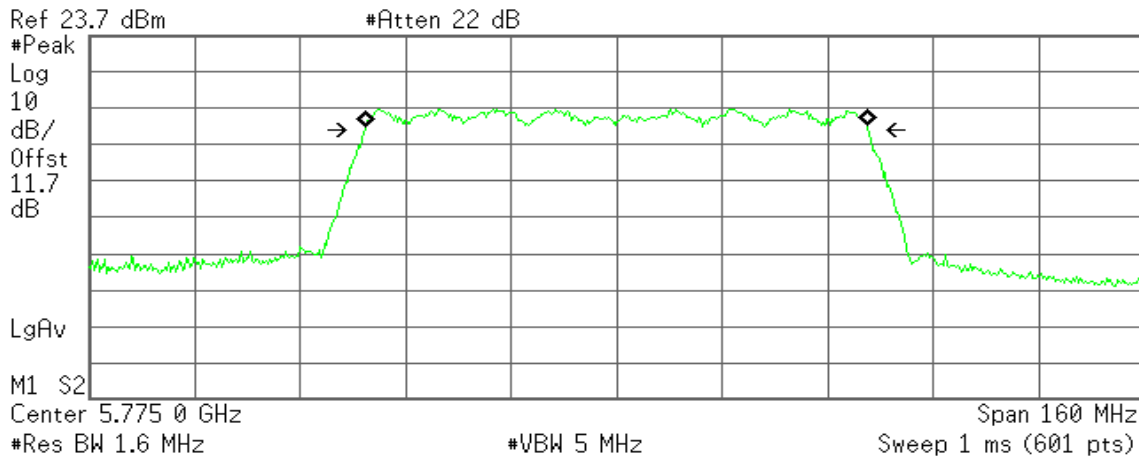

Occupied Bandwidth
76.1757 MHz

Occ BW % Pwr 99.00 %
x dB -6.00 dB

Transmit Freq Error -35.039 kHz
x dB Bandwidth 76.596 MHz

IEEE 802.11n HT 80 mode / 5775MHz / Chain 1

Agilent

R T

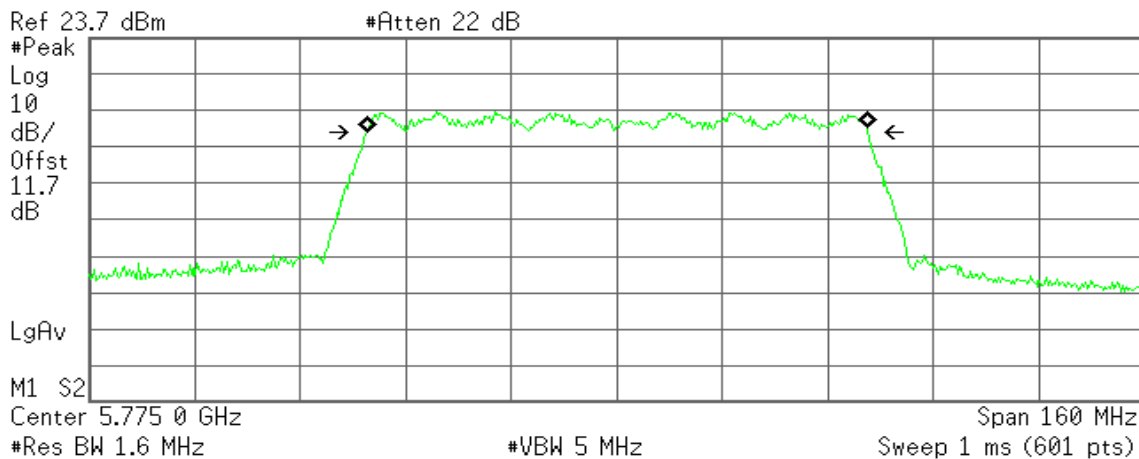

Occupied Bandwidth
76.0234 MHz

Occ BW % Pwr 99.00 %
x dB -6.00 dB

Transmit Freq Error 24.006 kHz
x dB Bandwidth 76.322 MHz



7.2 PEAK POWER

LIMIT

(1) According to §15.407(1)(iv),

For mobile and portable client devices in the 5.15 – 5.25 GHz band, the maximum conducted output power over the frequency band of operation shall not exceed 250 mW provided the maximum antenna gain does not exceed 6 dBi.

(2) According to §15.407(2),

For the 5.25-5.35 GHz and 5.47-5.725 GHz bands, the maximum conducted output power over the frequency bands of operation shall not exceed the lesser of 250 mW or $11 \text{ dBm} + 10 \log B$, where B is the 26 dB emission bandwidth in megahertz.

(3) According to §15.407(3),

For the band 5.725-5.85 GHz, the maximum conducted output power over the frequency band of operation shall not exceed 1 W.

If transmitting antennas of directional gain greater than 6dBi are used, both the peak transmit power and the peak power spectral density shall be reduced by the amount in dB that the directional gain of the antenna exceeds 6dBi.



Test Configuration

The EUT was connected to a spectrum analyzer through a 50 Ω RF cable.

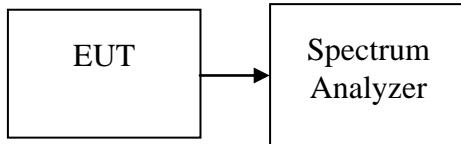

TEST PROCEDURE

Set span to encompass the entire emission bandwidth (EBW) of the signal.

Set RBW = 1 MHz / Set VBW = 3 MHz.

Use sample detector mode if bin width (i.e., span/number of points in spectrum display) < 0.5 RBW. Otherwise use peak detector mode. Use a video trigger with the trigger level set to enable triggering only on full power pulses. Transmitter must operate at full control power for entire sweep of every sweep. If the device transmits continuously, with no off intervals or reduced power intervals, the trigger may be set to “free run”. Trace average 100 traces in power averaging mode. Compute power by integrating the spectrum across the 26 dB EBW of the signal. The integration can be performed using the spectrum analyzer’s band power measurement function with band limits set equal to the EBW band edges or by summing power levels in each 1 MHz band in linear power terms. The 1 MHz band power levels to be summed can be obtained by averaging, in linear power terms, power levels in each frequency bin across the 1 MHz.

TEST RESULTS

No non-compliance noted

**Test Data****Test mode: IEEE 802.11a mode / 5180 ~ 5240MHz**

Channel	Frequency (MHz)	Maximum Conducted Output Power (dBm)	Limit (dBm)
Low	5180	*17.81	24.00
Mid	5220	17.66	24.00
High	5240	17.66	24.00

Test mode: IEEE 802.11n HT 20 mode / 5180 ~ 5240MHz

Channel	Frequency (MHz)	Chain 0 Output Power (dBm)	Chain 1 Output Power (dBm)	Total Maximum Conducted Output Power (dBm)	Limit (dBm)
Low	5180	13.96	16.81	18.63	21.1
Mid	5220	13.66	16.67	18.43	
High	5240	13.86	16.96	*18.69	

Test mode: IEEE 802.11n HT 40 mode / 5190 ~ 5230MHz

Channel	Frequency (MHz)	Chain 0 Output Power (dBm)	Chain 1 Output Power (dBm)	Total Maximum Conducted Output Power (dBm)	Limit (dBm)
Low	5190	13.81	13.75	16.79	21.1
High	5230	13.75	13.96	*16.87	

Test mode: IEEE 802.11n HT 80 MHz mode / 5210MHz

Channel	Frequency (MHz)	Chain 0 Output Power (dBm)	Chain 1 Output Power (dBm)	Total Maximum Conducted Output Power (dBm)	Limit (dBm)
Mid	5210	13.76	13.92	*16.85	21.1

Remark: 1. Total PPSD (dBm) = $10 * \text{LOG}(10^{(\text{Chain 0 PPSD} / 10)} + 10^{(\text{Chain 1 PPSD} / 10)})$

2. The maximum antenna gain is 8.9dBi; therefore the reduction due to antenna gain is 2.9dBi, so the limit is 21.1dBm.

**Test mode: IEEE 802.11a mode / 5745 ~ 5825MHz**

Channel	Frequency (MHz)	Maximum Conducted Output Power (dBm)	Limit (dBm)
Low	5745	*17.43	30.00
Mid	5785	17.34	
High	5825	17.02	

Test mode: IEEE 802.11n HT 20 mode / 5745 ~ 5825MHz

Channel	Frequency (MHz)	Chain 0 Output Power (dBm)	Chain 1 Output Power (dBm)	Total Maximum Conducted Output Power (dBm)	Limit (dBm)
Low	5745	13.72	16.43	18.29	27.1
Mid	5785	13.88	16.31	18.27	
High	5825	13.78	16.55	*18.39	

Test mode: IEEE 802.11n HT 40 mode / 5755 ~ 5795MHz

Channel	Frequency (MHz)	Chain 0 Output Power (dBm)	Chain 1 Output Power (dBm)	Total Maximum Conducted Output Power (dBm)	Limit (dBm)
Low	5755	13.82	13.82	*16.83	27.1
High	5795	13.62	13.46	16.55	

Test mode: IEEE 802.11n HT 80 MHz mode / 5775MHz

Channel	Frequency (MHz)	Chain 0 Output Power (dBm)	Chain 1 Output Power (dBm)	Total Maximum Conducted Output Power (dBm)	Limit (dBm)
Mid	5755	13.52	13.86	*16.70	27.1

Remark: 1. Total PPSD (dBm) = $10 * \text{LOG}(10^{(\text{Chain 0 PPSD} / 10)} + 10^{(\text{Chain 1 PPSD} / 10)})$

2. The maximum antenna gain is 8.9dBi; therefore the reduction due to antenna gain is 2.9dBi, so the limit is 27.1dBm.



7.3 AVERAGE POWER

LIMIT

None; for reporting purposes only.

Test Configuration

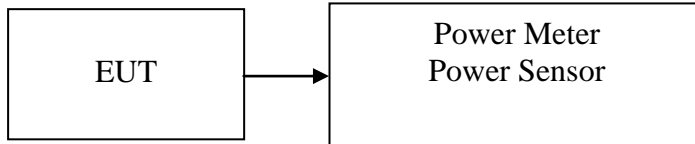

TEST PROCEDURE

The transmitter output is connected to the Power Meter. The Power Meter is set to the avg power detection.

TEST RESULTS

No non-compliance noted.

**Test Data****Test mode: IEEE 802.11a mode / 5180 ~ 5240MHz**

Channel	Frequency (MHz)	Maximum Conducted Output Power (dBm)	Limit (dBm)
Low	5180	7.88	24.00
Mid	5220	7.71	24.00
High	5240	7.74	24.00

Test mode: IEEE 802.11n HT 20 mode / 5180 ~ 5240MHz

Channel	Frequency (MHz)	Chain 0 Output Power (dBm)	Chain 1 Output Power (dBm)	Total Maximum Conducted Output Power (dBm)	Limit (dBm)
Low	5180	4.42	4.72	7.58	24.00
Mid	5220	4.22	4.56	7.40	
High	5240	4.31	4.82	7.58	

Test mode: IEEE 802.11n HT 40 mode / 5190 ~ 5230MHz

Channel	Frequency (MHz)	Chain 0 Output Power (dBm)	Chain 1 Output Power (dBm)	Total Maximum Conducted Output Power (dBm)	Limit (dBm)
Low	5190	4.83	4.86	7.86	24.00
High	5230	4.52	4.76	7.65	

Test mode: IEEE 802.11n HT 80 MHz mode / 5210MHz

Channel	Frequency (MHz)	Chain 0 Output Power (dBm)	Chain 1 Output Power (dBm)	Total Maximum Conducted Output Power (dBm)	Limit (dBm)
Mid	5210	4.92	4.73	7.84	24.00

Remark: 1. Total PPSD (dBm) = $10 * \text{LOG}(10^{(\text{Chain 0 PPSD} / 10)} + 10^{(\text{Chain 1 PPSD} / 10)})$

2. The maximum antenna gain is 8.9dBi; therefore the reduction due to antenna gain is 2.9dBi, so the limit is 14.1dBm.

**Test mode: IEEE 802.11a mode / 5745 ~ 5825MHz**

Channel	Frequency (MHz)	Maximum Conducted Output Power (dBm)	Limit (dBm)
Low	5745	7.34	30.00
Mid	5785	7.13	
High	5825	7.25	

Test mode: IEEE 802.11n HT 20 mode / 5745 ~ 5825MHz

Channel	Frequency (MHz)	Chain 0 Output Power (dBm)	Chain 1 Output Power (dBm)	Total Maximum Conducted Output Power (dBm)	Limit (dBm)
Low	5745	4.22	4.63	7.44	30.00
Mid	5785	4.53	4.52	7.54	
High	5825	4.31	4.84	7.59	

Test mode: IEEE 802.11n HT 40 mode / 5755 ~ 5795MHz

Channel	Frequency (MHz)	Chain 0 Output Power (dBm)	Chain 1 Output Power (dBm)	Total Maximum Conducted Output Power (dBm)	Limit (dBm)
Low	5755	4.81	4.54	7.69	30.00
High	5795	4.84	4.32	7.60	

Test mode: IEEE 802.11n HT 80 MHz mode / 5775MHz

Channel	Frequency (MHz)	Chain 0 Output Power (dBm)	Chain 1 Output Power (dBm)	Total Maximum Conducted Output Power (dBm)	Limit (dBm)
Mid	5775	4.44	4.46	7.46	30.00

Remark: 1. Total PPSD (dBm) = $10 * \text{LOG}(10^{(\text{Chain 0 PPSD} / 10)} + 10^{(\text{Chain 1 PPSD} / 10)})$

2. The maximum antenna gain is 8.9dBi; therefore the reduction due to antenna gain is 2.9dBi, so the limit is 21.1dBm.



7.4 BAND EDGES MEASUREMENT

LIMIT

According to §15.407(b),

- (1) The provisions of Section 15.205 of this part apply to intentional radiators operating under this section.
- (2) When measuring the emission limits, the nominal carrier frequency shall be adjusted as close to the upper and lower frequency block edges as the design of the equipment permits.

Test Configuration

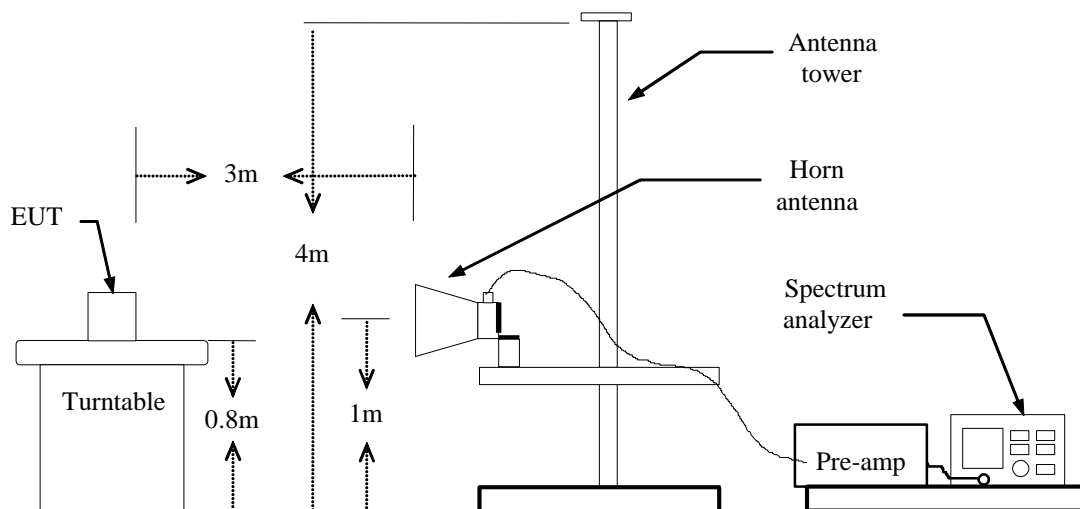

TEST PROCEDURE

1. The EUT is placed on a turntable, which is 0.8m above the ground plane.
2. The turntable shall be rotated for 360 degrees to determine the position of maximum emission level.
3. EUT is set 3m away from the receiving antenna, which is varied from 1m to 4m to find out the highest emission.
4. Set the spectrum analyzer in the following setting in order to capture the lower and upper band-edges of the emission:
 - (a) PEAK: RBW=VBW=1MHz / Sweep=AUTO
 - (b) AVERAGE: RBW=1MHz / VBW=300Hz / Sweep=AUTO
5. Repeat the procedures until all the PEAK and AVERAGE versus POLARIZATION are measured.

TEST RESULTS

Refer to attach spectrum analyzer data chart.



Band Edges (IEEE 802.11a mode / 5180 MHz)

Detector mode: Peak

Polarity: Vertical

Agilent

R T

Mkr1 4.887 4 GHz

55.17 dB μ V/m

Ref 119 dB μ V/m

#Atten 16 dB

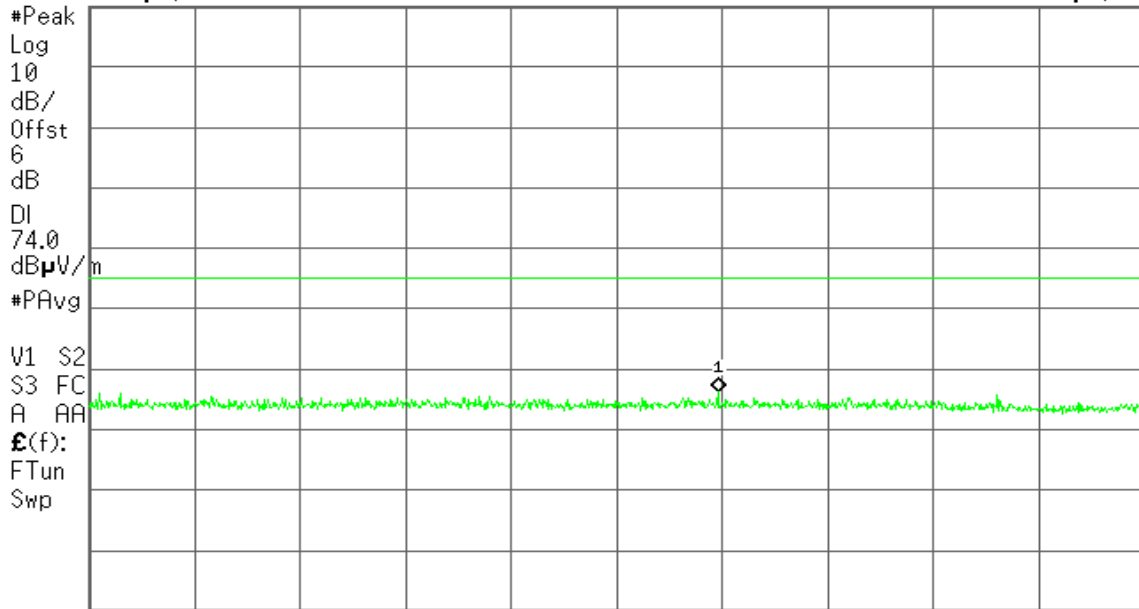

Start 4.500 0 GHz

Stop 5.150 0 GHz

#Res BW 1 MHz

#VBW 3 MHz

#Sweep 100 ms (1001 pts)

Detector mode: Average

Polarity: Vertical

Agilent

R T

Mkr1 4.876 4 GHz

43.42 dB μ V/m

Ref 119 dB μ V/m

#Atten 16 dB

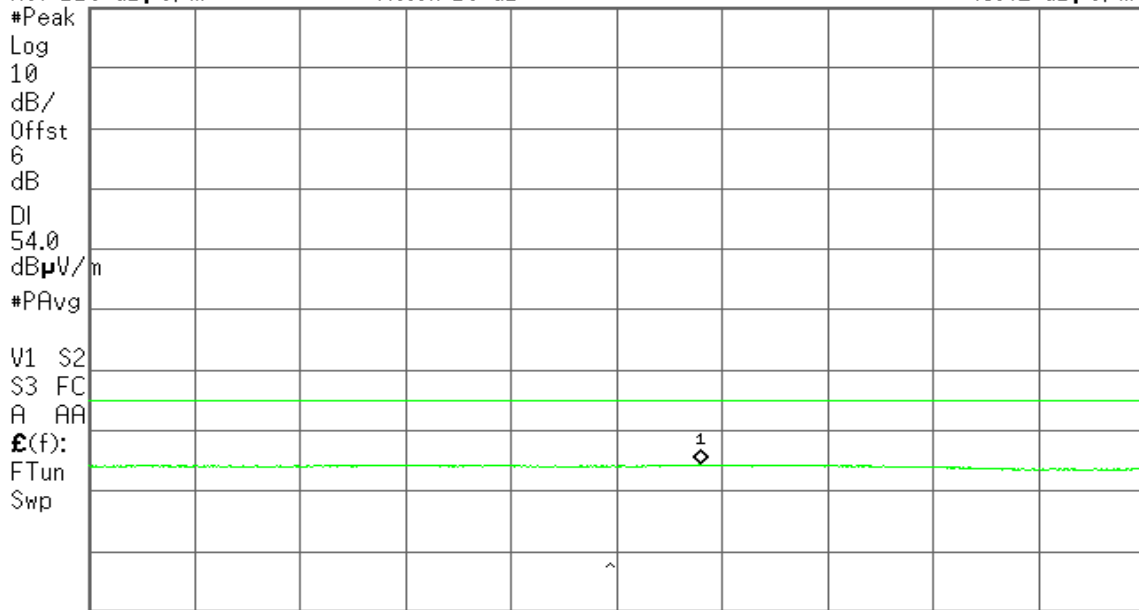

Start 4.500 0 GHz

Stop 5.150 0 GHz

#Res BW 1 MHz

#VBW 300 Hz

Sweep 1.689 s (1001 pts)



Detector mode: Peak

Polarity: Horizontal

Agilent

R T

Mkr1 5.048 6 GHz
55.18 dB μ V/m

Ref 119 dB μ V/m

#Atten 16 dB

#Peak

Log

10

dB/

Offst

6

dB

DI

74.0

dB μ V/m

#PAvg

V1 S2

S3 FC

A AA

$\mathcal{E}(f)$:

FTun

Swp

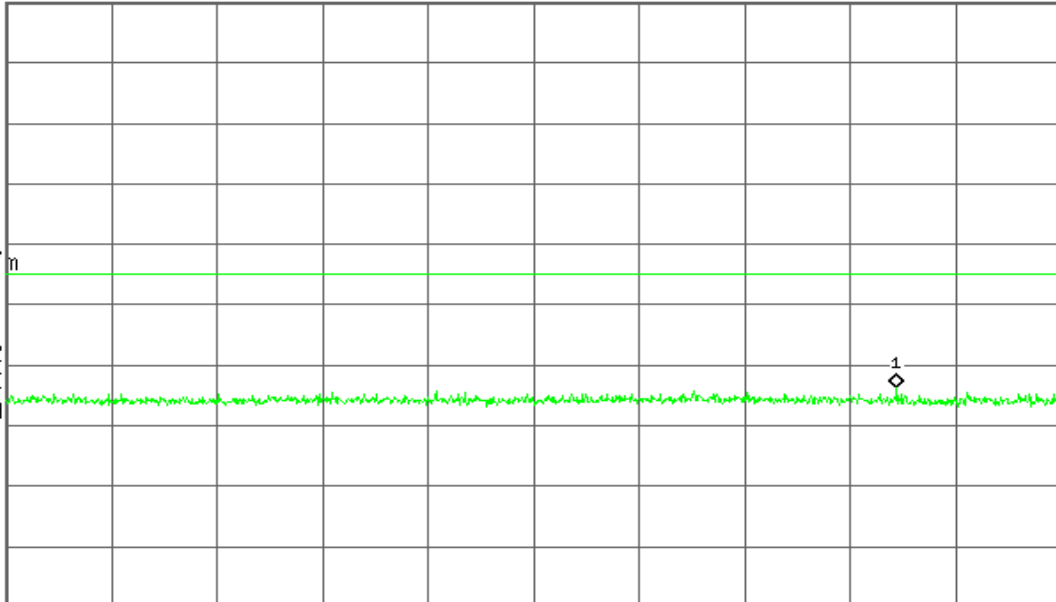

Start 4.500 0 GHz

Stop 5.150 0 GHz

#Res BW 1 MHz

#VBW 3 MHz

#Sweep 100 ms (1001 pts)

Detector mode: Average

Polarity: Horizontal

Agilent

R T

Mkr1 4.960 2 GHz
43.66 dB μ V/m

Ref 119 dB μ V/m

#Atten 16 dB

#Peak

Log

10

dB/

Offst

6

dB

DI

54.0

dB μ V/m

#PAvg

V1 S2

S3 FC

A AA

$\mathcal{E}(f)$:

FTun

Swp

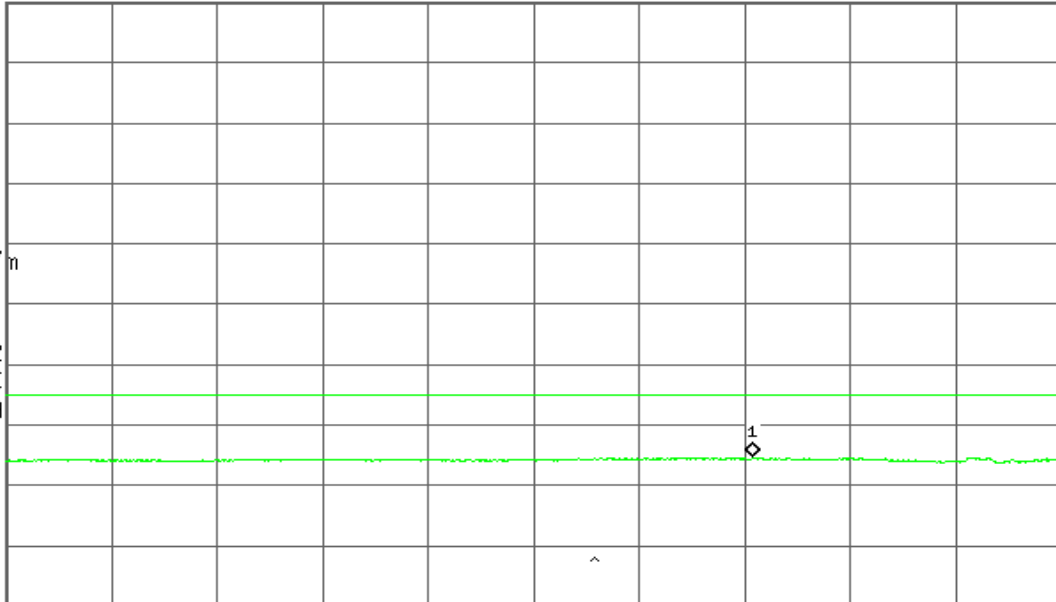

Start 4.500 0 GHz

Stop 5.150 0 GHz

#Res BW 1 MHz

#VBW 300 Hz

Sweep 1.689 s (1001 pts)



Band Edges (IEEE 802.11n HT 20 mode / 5180 MHz)

Detector mode: Peak

Polarity: Vertical

Agilent

R T

Mkr1 4.518 8 GHz
54.78 dBμV/m

Ref 119 dBμV/m

#Atten 16 dB

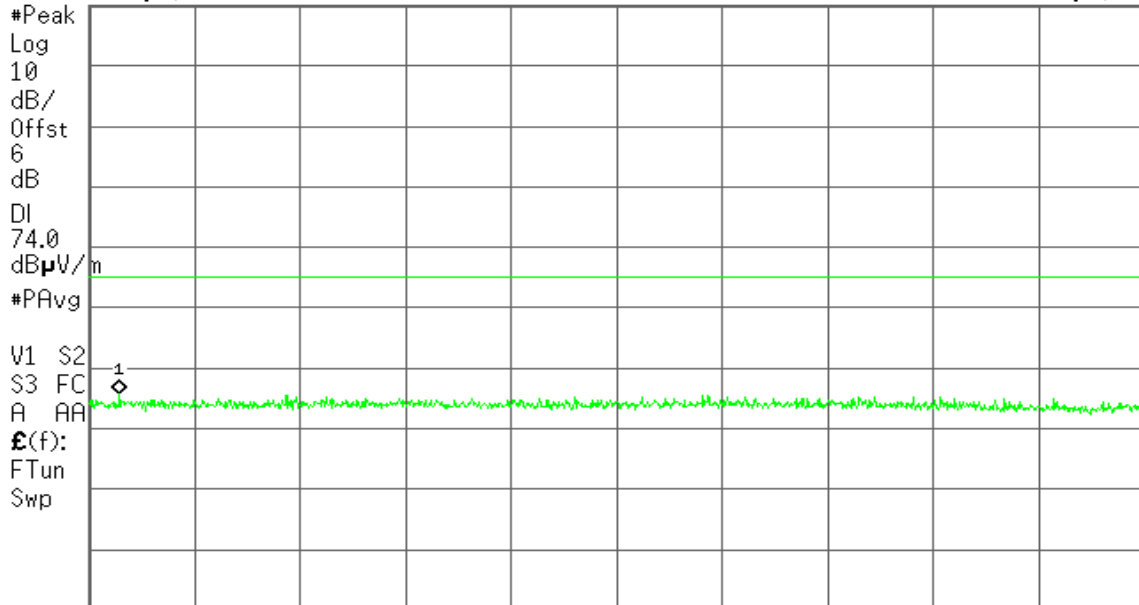

Start 4.500 0 GHz

#Res BW 1 MHz

#VBW 3 MHz

Stop 5.150 0 GHz
#Sweep 100 ms (1001 pts)

Detector mode: Average

Polarity: Vertical

Agilent

R T

Mkr1 4.695 6 GHz
43.45 dBμV/m

Ref 119 dBμV/m

#Atten 16 dB

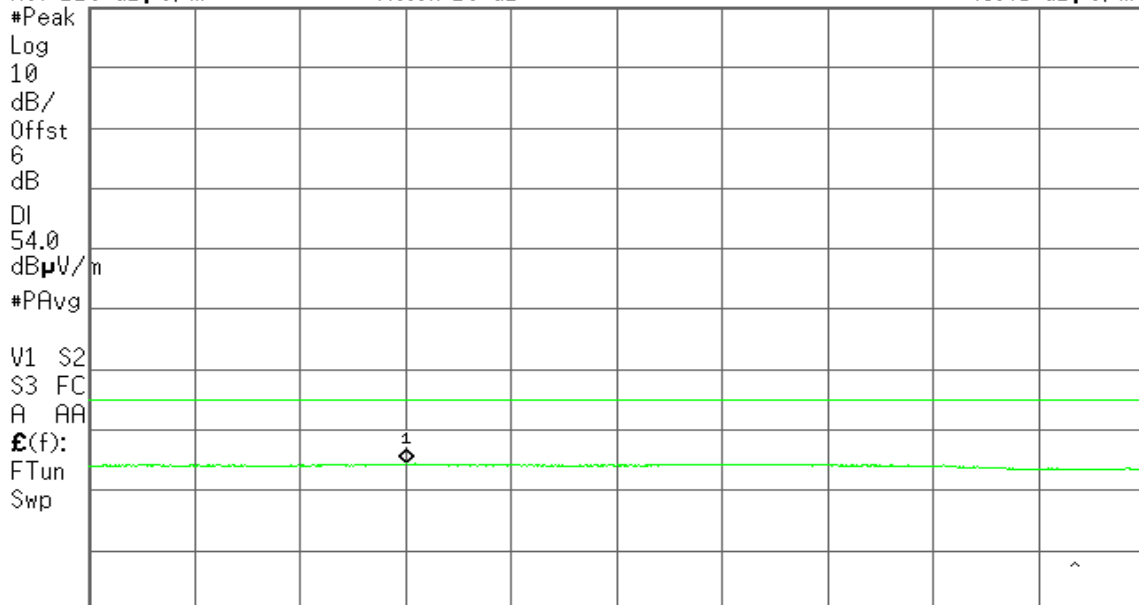

Start 4.500 0 GHz

#Res BW 1 MHz

#VBW 300 Hz

Stop 5.150 0 GHz
Sweep 1.689 s (1001 pts)



Detector mode: Peak

Polarity: Horizontal

Agilent

R T

Mkr1 4.817 2 GHz
55.15 dBµV/m

Ref 119 dBµV/m

#Atten 16 dB

#Peak

Log

10

dB/

Offst

6

dB

DI

74.0

dBµV/m

#PAvg

V1 S2

S3 FC

A AA

£(f):

FTun

Swp

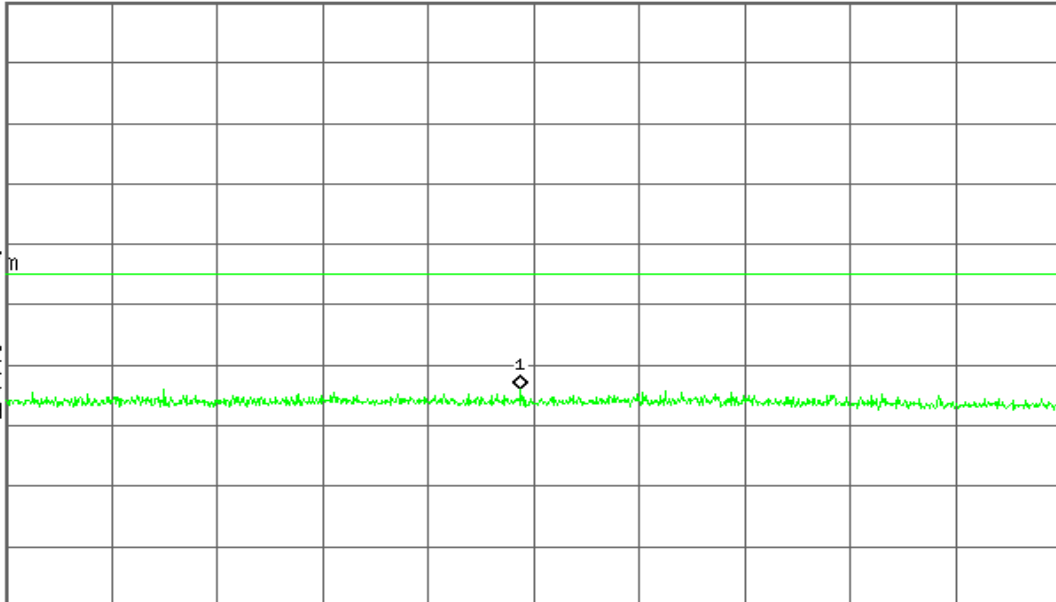

Start 4.500 0 GHz

Stop 5.150 0 GHz

#Res BW 1 MHz

#VBW 3 MHz

#Sweep 100 ms (1001 pts)

Detector mode: Average

Polarity: Horizontal

Agilent

R T

Mkr1 4.927 0 GHz
43.44 dBµV/m

Ref 119 dBµV/m

#Atten 16 dB

#Peak

Log

10

dB/

Offst

6

dB

DI

54.0

dBµV/m

#PAvg

V1 S2

S3 FC

A AA

£(f):

FTun

Swp

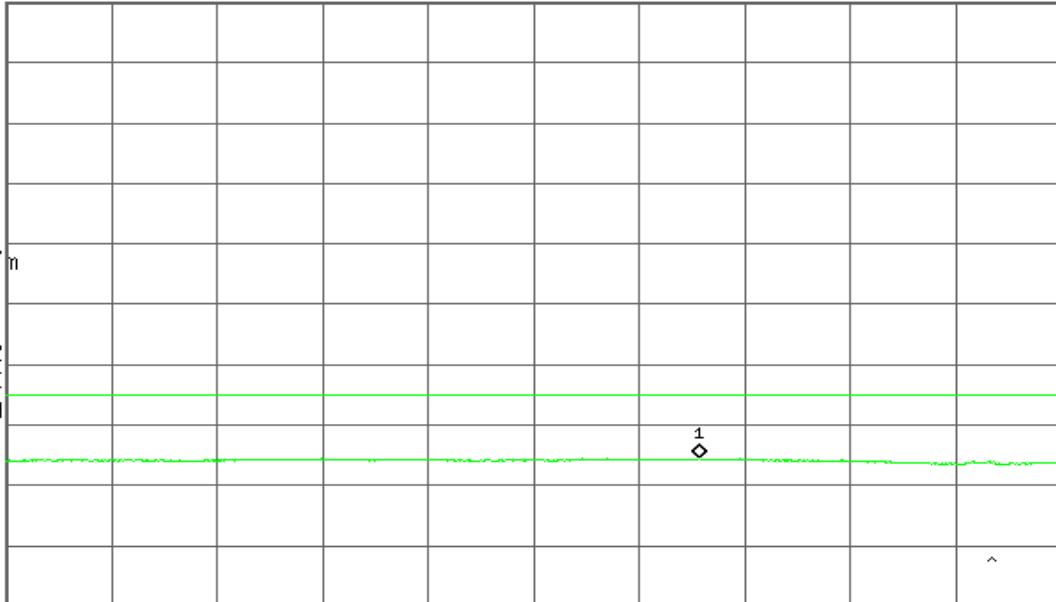

Start 4.500 0 GHz

Stop 5.150 0 GHz

#Res BW 1 MHz

#VBW 300 Hz

Sweep 1.689 s (1001 pts)



Band Edges (IEEE 802.11n HT 40 mode / 5190 MHz)

Detector mode: Peak

Polarity: Vertical

Agilent

R T

Mkr1 4.686 6 GHz
54.50 dBµV/m

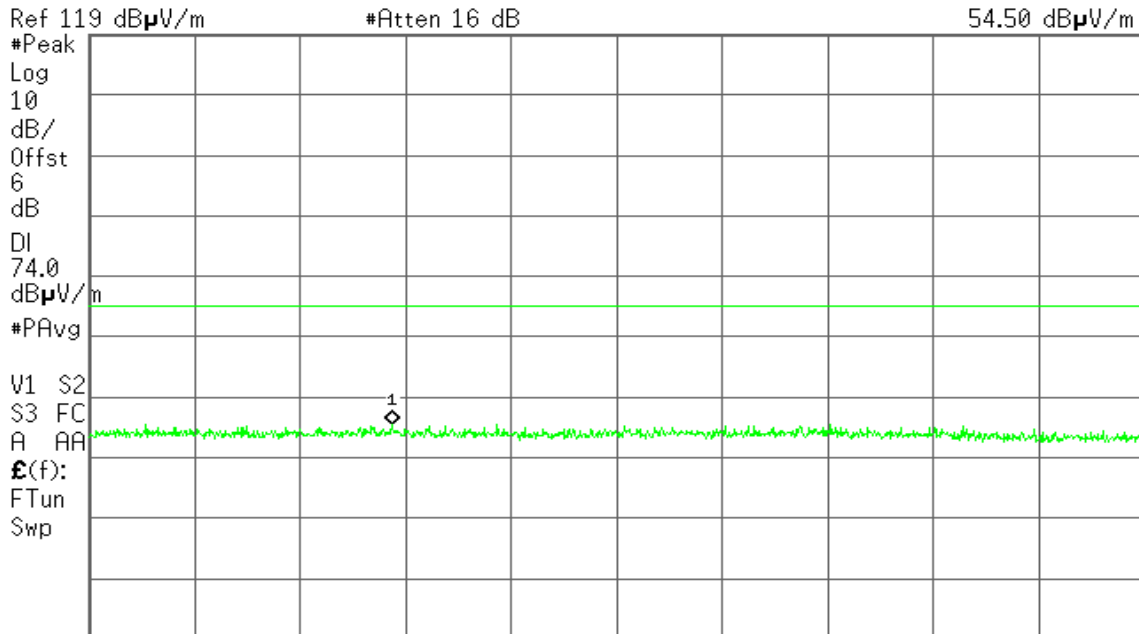

Start 4.500 0 GHz #Res BW 1 MHz #VBW 3 MHz Stop 5.150 0 GHz #Sweep 100 ms (1001 pts)

Detector mode: Average

Polarity: Vertical

Agilent

R T

Mkr1 4.690 4 GHz
43.45 dBµV/m

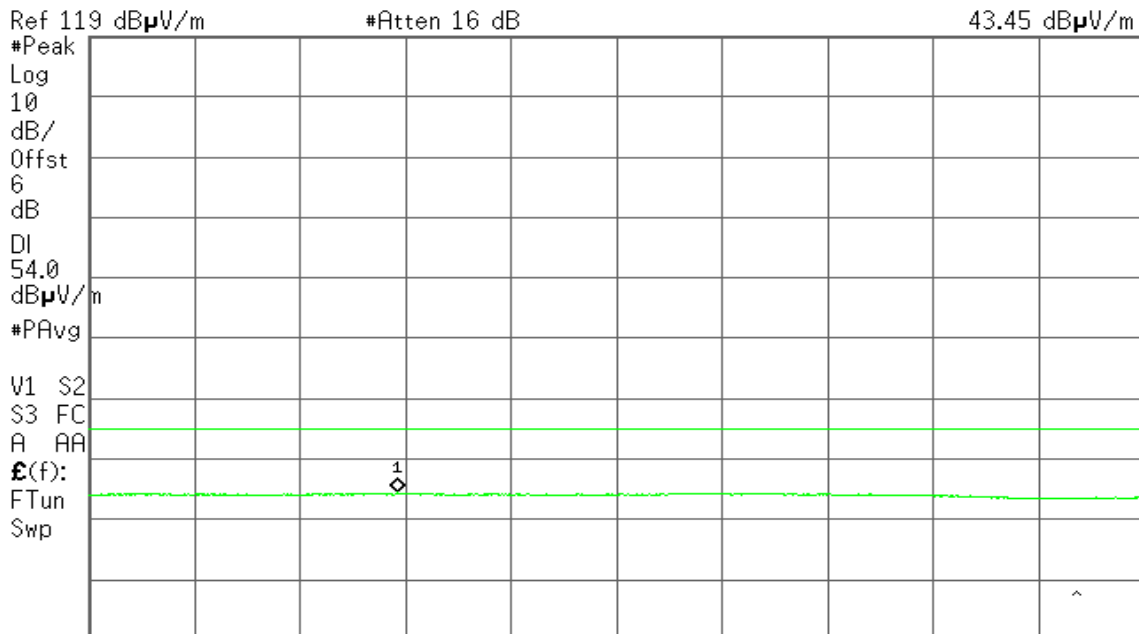

Start 4.500 0 GHz #Res BW 1 MHz #VBW 300 Hz Stop 5.150 0 GHz Sweep 1.689 s (1001 pts)



Detector mode: Peak

Polarity: Horizontal

Agilent

R T

Mkr1 5.127 9 GHz
54.60 dB μ V/m

Ref 119 dB μ V/m

#Atten 16 dB

#Peak

Log

10

dB/

Offst

6

dB

DI

74.0

dB μ V/m

#PAvg

V1 S2

S3 FC

A AA

$\mathcal{E}(f)$:

FTun

Swp

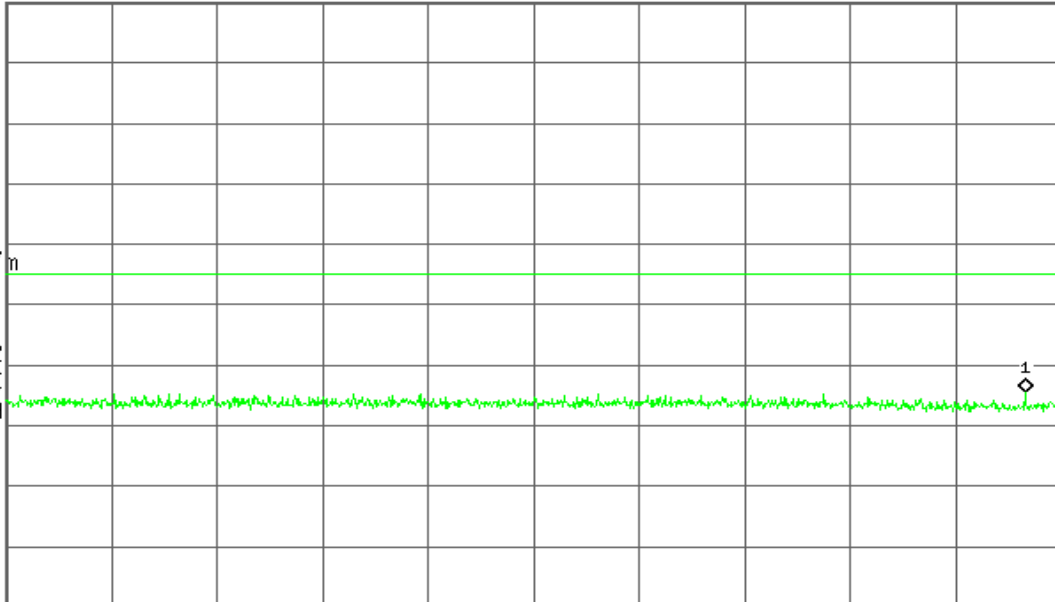

Start 4.500 0 GHz

Stop 5.150 0 GHz

#Res BW 1 MHz

#VBW 3 MHz

#Sweep 100 ms (1001 pts)

Detector mode: Average

Polarity: Horizontal

Agilent

R T

Mkr1 4.679 4 GHz
43.36 dB μ V/m

Ref 119 dB μ V/m

#Atten 16 dB

#Peak

Log

10

dB/

Offst

6

dB

DI

54.0

dB μ V/m

#PAvg

V1 S2

S3 FC

A AA

$\mathcal{E}(f)$:

FTun

Swp

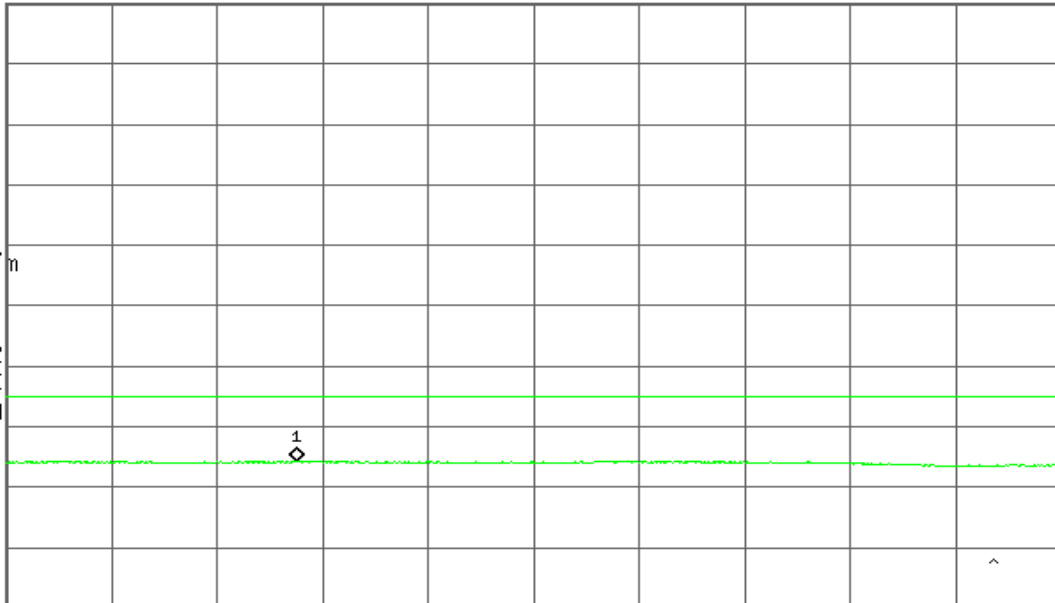

Start 4.500 0 GHz

Stop 5.150 0 GHz

#Res BW 1 MHz

#VBW 300 Hz

Sweep 1.689 s (1001 pts)



Band Edges (IEEE 802.11n HT 80 MHz mode / CH 5210 MHz)

Detector mode: Peak

Polarity: Vertical

Agilent

R T

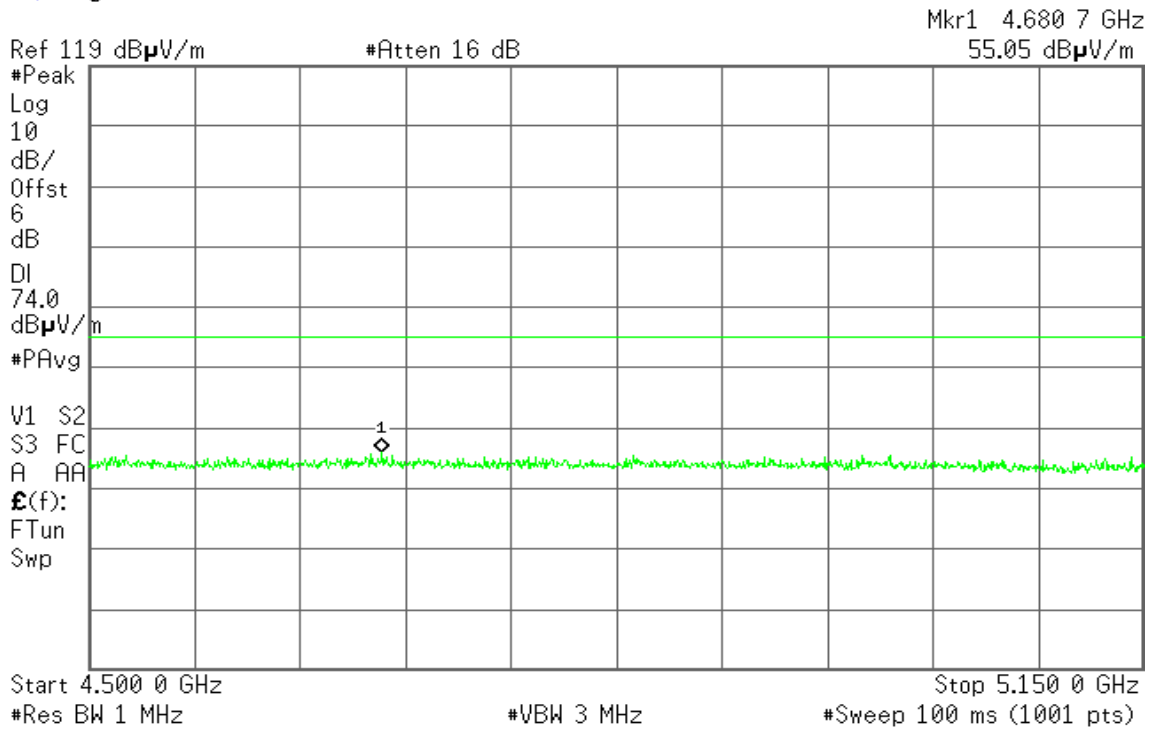

Detector mode: Average

Polarity: Vertical

Agilent

R T

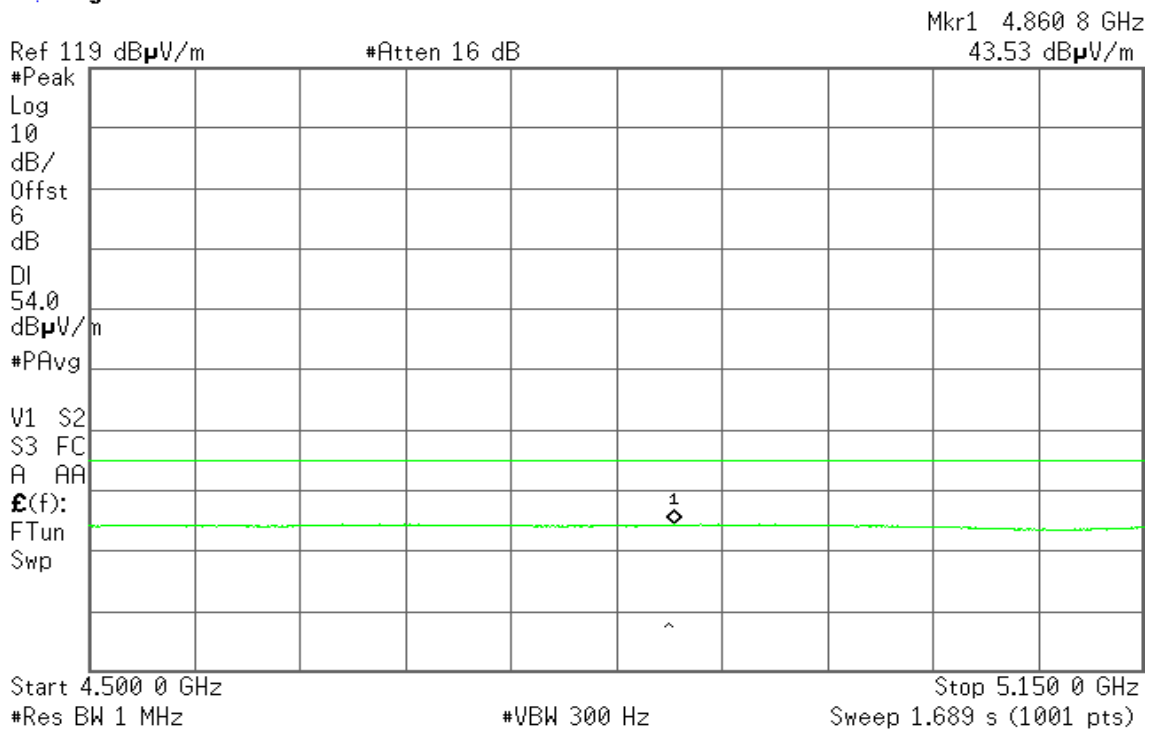



Detector mode: Peak

Polarity: Horizontal

Agilent

R T

Mkr1 5.371 7 GHz
55.03 dB μ V/m

Ref 119 dB μ V/m

#Atten 16 dB

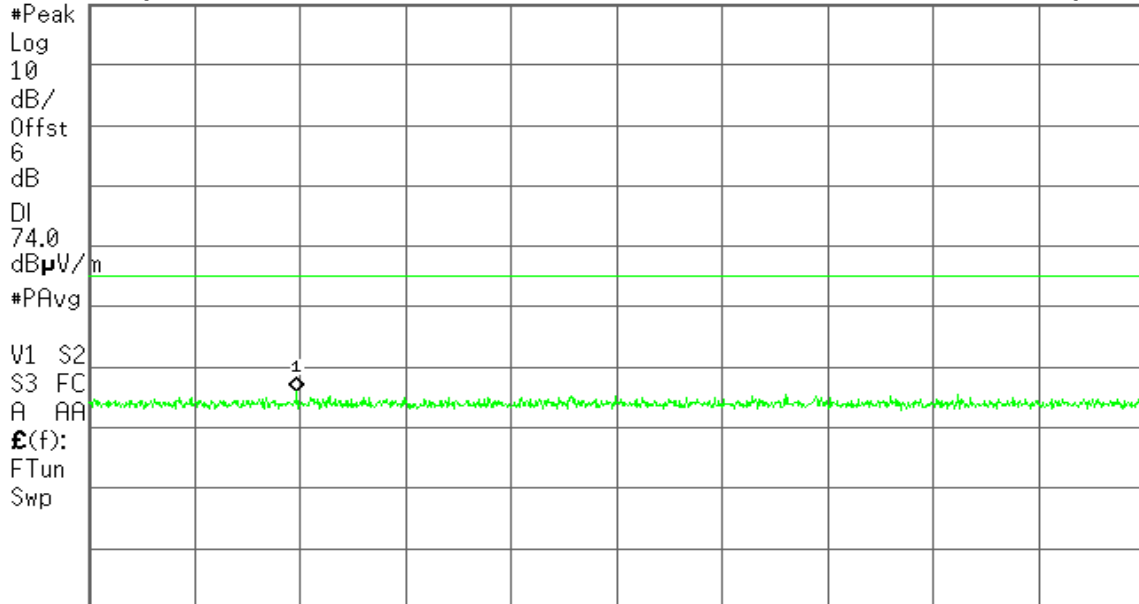

Start 5.350 0 GHz

Stop 5.460 0 GHz

#Res BW 1 MHz

#VBW 3 MHz

#Sweep 100 ms (1001 pts)

Detector mode: Average

Polarity: Horizontal

Agilent

R T

Mkr1 5.370 7 GHz
43.59 dB μ V/m

Ref 119 dB μ V/m

#Atten 16 dB

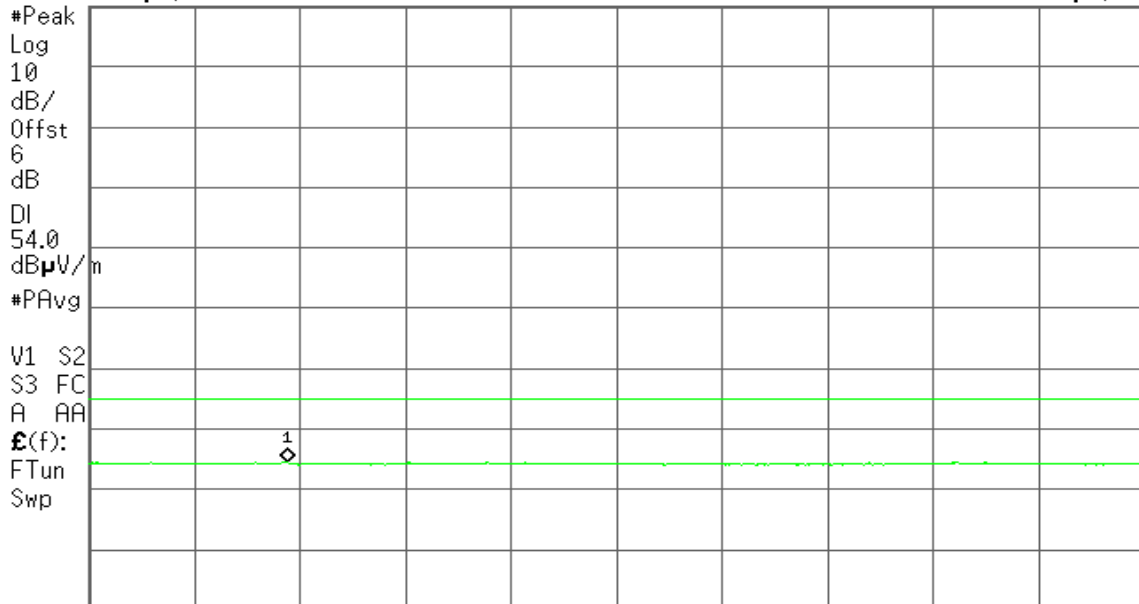

Start 5.350 0 GHz

Stop 5.460 0 GHz

#Res BW 1 MHz

#VBW 300 Hz

Sweep 285.9 ms (1001 pts)



7.5 PEAK POWER SPECTRAL DENSITY

LIMIT

According to §15.407(a),

- (1) For the band 5.15-5.25 GHz, the peak power spectral density shall not exceed 4dBm in any 1MHz band.
- (2) For the band 5.25-5.35 GHz, the peak power spectral density shall not exceed 11dBm in any 1MHz band.

If transmitting antennas of directional gain greater than 6dBi are used, both the peak transmit power and the peak power spectral density shall be reduced by the amount in dB that the directional gain of the antenna exceeds 6dBi.

Test Configuration

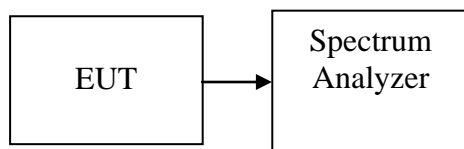

TEST PROCEDURE

1. Place the EUT on the table and set it in transmitting mode.
Remove the antenna from the EUT and then connect a low loss RF cable from the antenna port to the spectrum analyzer.
2. Set the spectrum analyzer as RBW = 1MHz, VBW = 3MHz, Span = 50MHz, Sweep=1ms
3. Record the max. reading.
4. Repeat the above procedure until the measurements for all frequencies are completed

TEST RESULTS

No non-compliance noted



Test Data

Test mode: IEEE 802.11a mode / 5180 ~ 5240MHz

Channel	Frequency (MHz)	PPSD (dBm)	Limit (dBm)	Result
Low	5180	3.71	11.00	PASS
Mid	5220	3.37		PASS
High	5240	3.76		PASS

Test mode: IEEE 802.11n HT 20 mode / 5180 ~ 5240MHz

Channel	Frequency (MHz)	Chain 0 PPSD (dBm)	Chain 1 PPSD (dBm)	PPSD (dBm)	Limit (dBm)	Result
Low	5180	-0.66	0.08	2.74	8.1	PASS
Mid	5220	-0.06	-0.72	2.63		PASS
High	5240	0.95	1.21	4.09		PASS

Test mode: IEEE 802.11n HT 40 mode / 5190 ~ 5230MHz

Channel	Frequency (MHz)	Chain 0 PPSD (dBm)	Chain 1 PPSD (dBm)	PPSD (dBm)	Limit (dBm)	Result
Low	5190	-3.19	-2.79	0.02	8.1	PASS
High	5230	-3.36	-3.61	-0.47		PASS

Test mode: IEEE 802.11n HT 80 MHz mode / 5210MHz

Channel	Frequency (MHz)	Chain 0 PPSD (dBm)	Chain 1 PPSD (dBm)	PPSD (dBm)	Limit (dBm)	Result
Mid	5210	-5.66	-6.86	-3.21	8.1	PASS

Remark: 1. Total PPSD (dBm) = 10*LOG(10^(Chain 0 PPSD / 10)+10^(Chain 1 PPSD / 10))

2. The maximum antenna gain is 8.9dBi; therefore the reduction due to antenna gain is 2.9dBi, so the limit is 8.1dBm.

**Test mode: IEEE 802.11a mode/ 5745 ~ 5825MHz**

Channel	Frequency (MHz)	PPSD (dBm)	Limit (dBm)	Result
Low	5745	-1.41	30.00	PASS
Mid	5785	-0.81		PASS
High	5825	-1.17		PASS

Test mode: IEEE 802.11n HT 20 mode / 5745 ~ 5825MHz

Channel	Frequency (MHz)	Chain 0 PPSD (dBm)	Chain 1 PPSD (dBm)	PPSD (dBm)	Limit (dBm)	Result
Low	5745	-3.49	-5.24	-1.27	27.1	PASS
Mid	5785	-3.60	-4.22	-0.89		PASS
High	5825	-3.12	-3.88	-0.47		PASS

Test mode: IEEE 802.11n HT 40 mode / 5755 ~ 5795MHz

Channel	Frequency (MHz)	Chain 0 PPSD (dBm)	Chain 1 PPSD (dBm)	PPSD (dBm)	Limit (dBm)	Result
Low	5755	-6.67	-8.05	-4.30	27.1	PASS
High	5795	-7.14	-7.53	-4.32		PASS

Test mode: IEEE 802.11n HT 80 MHz mode / 5775MHz

Channel	Frequency (MHz)	Chain 0 PPSD (dBm)	Chain 1 PPSD (dBm)	PPSD (dBm)	Limit (dBm)	Result
Mid	5775	-10.20	-10.96	-7.55	27.1	PASS

Remark: 1. Total PPSD (dBm) = $10 * \text{LOG}(10^{(\text{Chain 0 PPSD} / 10)} + 10^{(\text{Chain 1 PPSD} / 10)})$

2. The maximum antenna gain is 8.9dBi; therefore the reduction due to antenna gain is 2.9dBi, so the limit is 27.1dBm.



Test Plot

IEEE 802.11a mode / 5180 ~ 5240MHz

CH Low

Agilent

R T

Mkr1 5.186 30 GHz
3.71 dBm

Ref 21.7 dBm

#Atten 20 dB

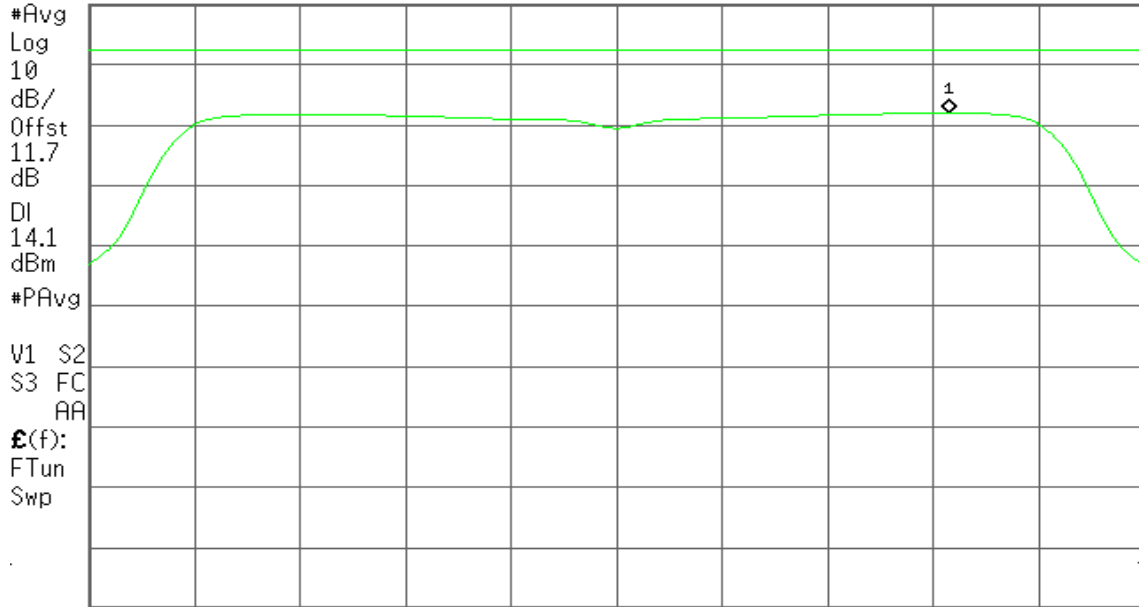

Center 5.180 00 GHz

Span 20 MHz

#Res BW 1 MHz

#VBW 3 MHz

#Sweep 6 s (601 pts)

CH Mid

Agilent

R T

Mkr1 5.226 20 GHz
3.37 dBm

Ref 21.7 dBm

#Atten 20 dB

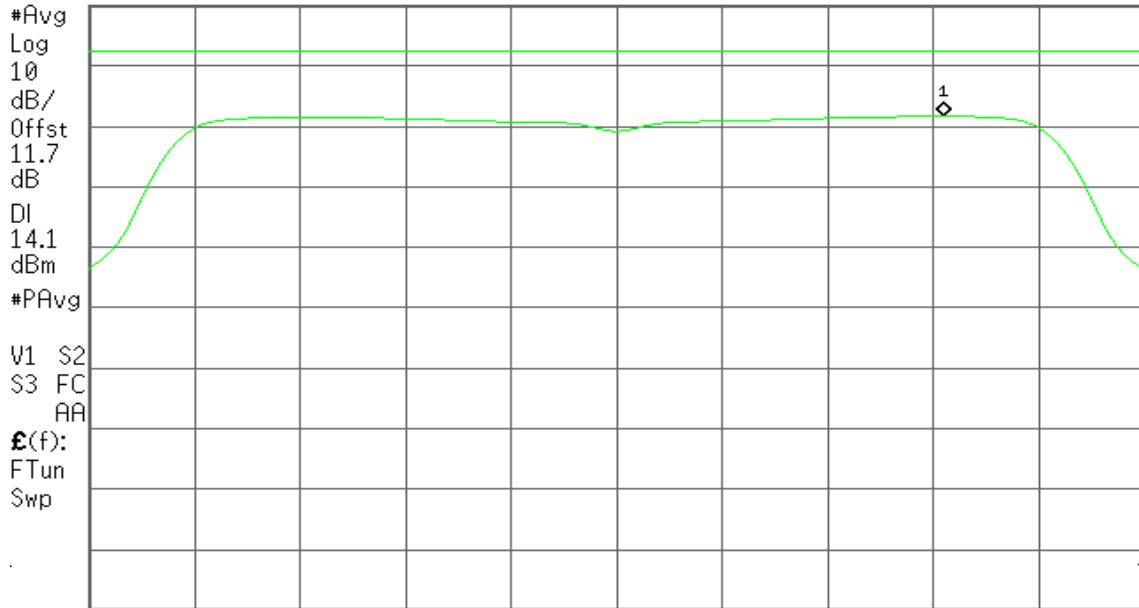

Center 5.220 00 GHz

Span 20 MHz

#Res BW 1 MHz

#VBW 3 MHz

#Sweep 6 s (601 pts)



CH High

Agilent

R T

Mkr1 5.246 27 GHz
3.76 dBm

Ref 21.7 dBm

#Atten 20 dB

#Avg
Log
10
dB/
Offst
11.7
dB
DI
14.1
dBm
#PAvg
V1 S2
S3 FC
AA
£(f):
FTun
Swp

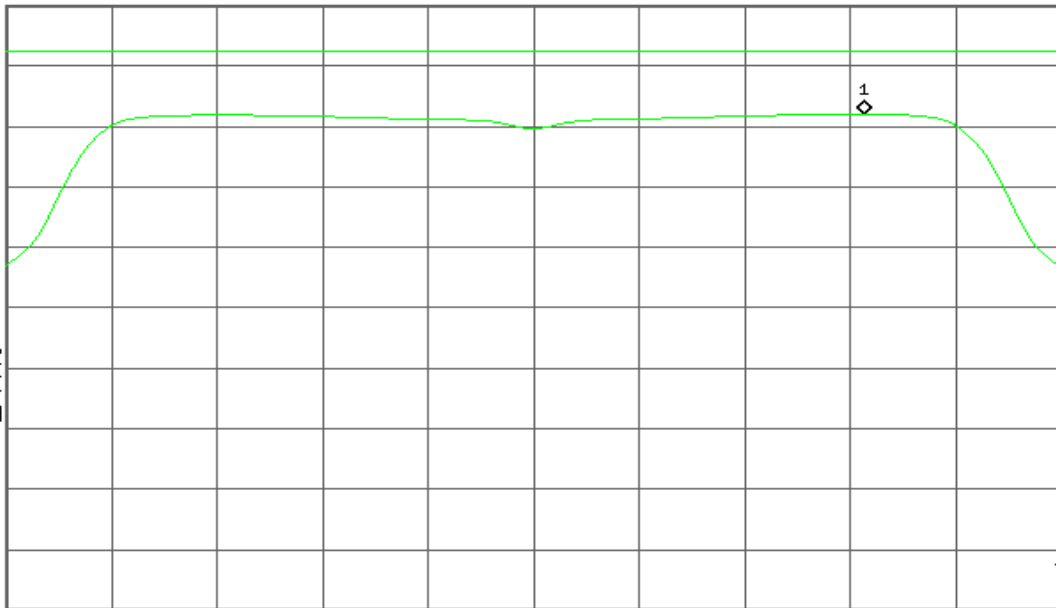

Center 5.240 00 GHz

Span 20 MHz

#Res BW 1 MHz

#VBW 3 MHz

#Sweep 6 s (601 pts)

IEEE 802.11n HT 20 mode / 5180 ~ 5240MHz / Chain 0

CH Low

Agilent

R T

Mkr1 5.186 17 GHz
-0.66 dBm

Ref 21.7 dBm

#Atten 20 dB

#Avg
Log
10
dB/
Offst
11.7
dB
DI
14.1
dBm
#PAvg
V1 S2
S3 FC
AA
£(f):
FTun
Swp

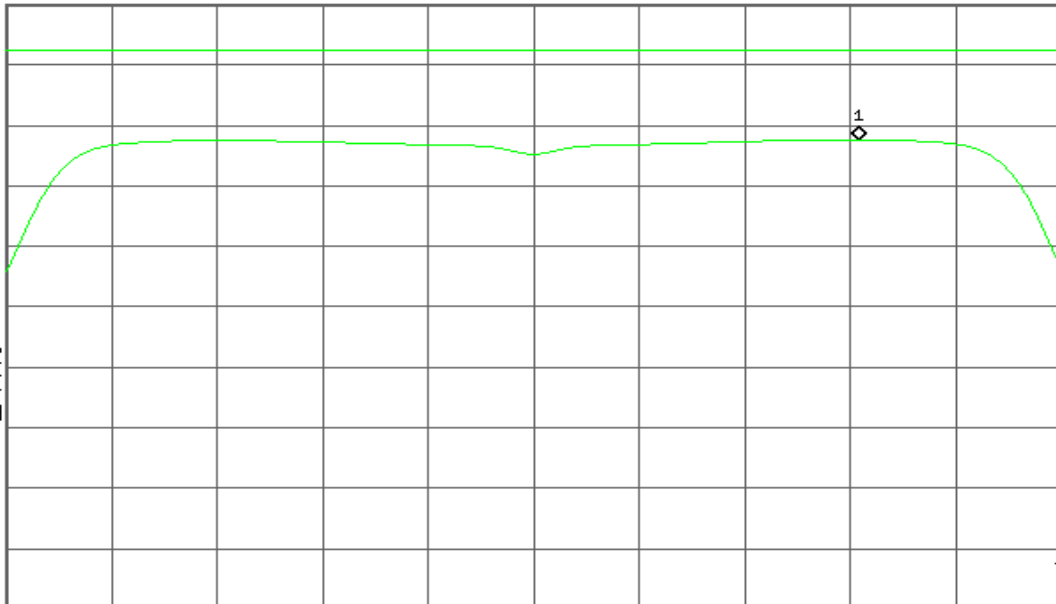

Center 5.180 00 GHz

Span 20 MHz

#Res BW 1 MHz

#VBW 3 MHz

#Sweep 6 s (601 pts)



CH Mid

Agilent

R T

Mkr1 5.225 83 GHz
-0.06 dBm



Center 5.220 00 GHz Span 20 MHz
#Res BW 1 MHz #VBW 3 MHz #Sweep 6 s (601 pts)

CH High

Agilent

R T

Mkr1 5.245 80 GHz
0.95 dBm

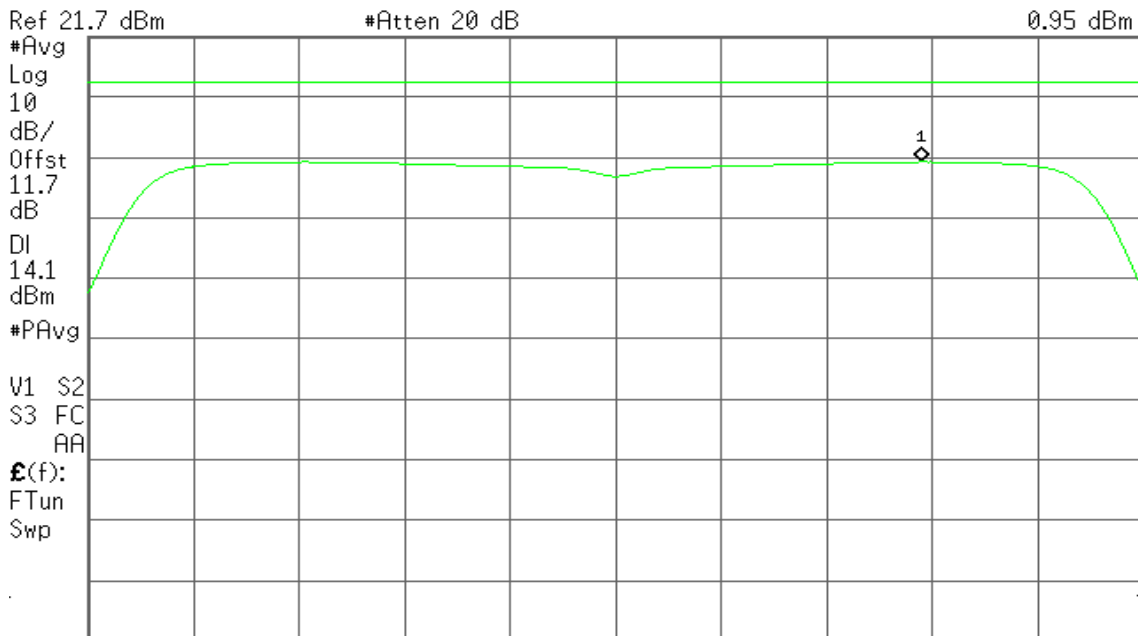

Center 5.240 00 GHz Span 20 MHz
#Res BW 1 MHz #VBW 3 MHz #Sweep 6 s (601 pts)



IEEE 802.11n HT 20 mode / 5180 ~ 5240MHz / Chain 1

CH Low

Agilent

R T

Mkr1 5.174 17 GHz
0.08 dBm

Ref 21.7 dBm

#Atten 20 dB

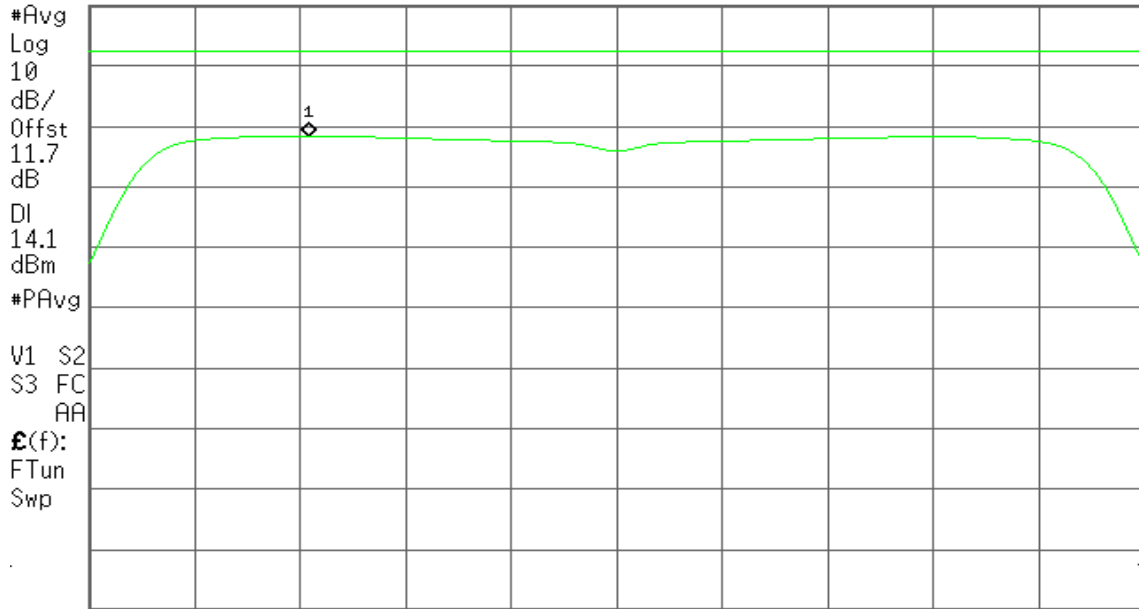

Center 5.180 00 GHz

Span 20 MHz

#Res BW 1 MHz

#VBW 3 MHz

#Sweep 6 s (601 pts)

CH Mid

Agilent

R T

Mkr1 5.214 17 GHz
-0.72 dBm

Ref 21.7 dBm

#Atten 20 dB

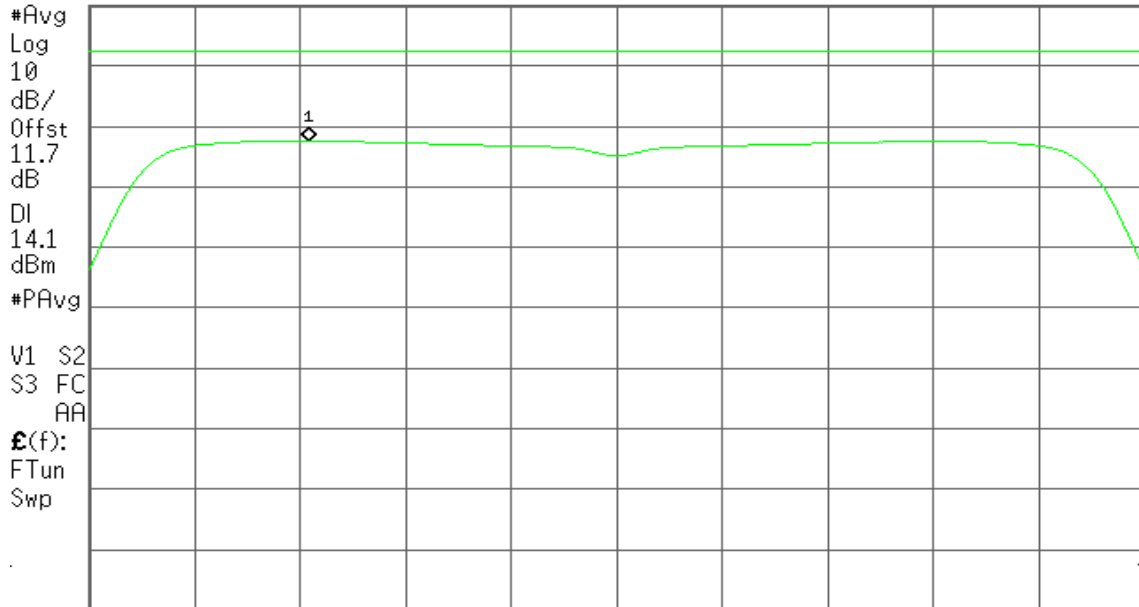

Center 5.220 00 GHz

Span 20 MHz

#Res BW 1 MHz

#VBW 3 MHz

#Sweep 6 s (601 pts)



CH High

Agilent

R T

Mkr1 5.246 27 GHz
1.21 dBm

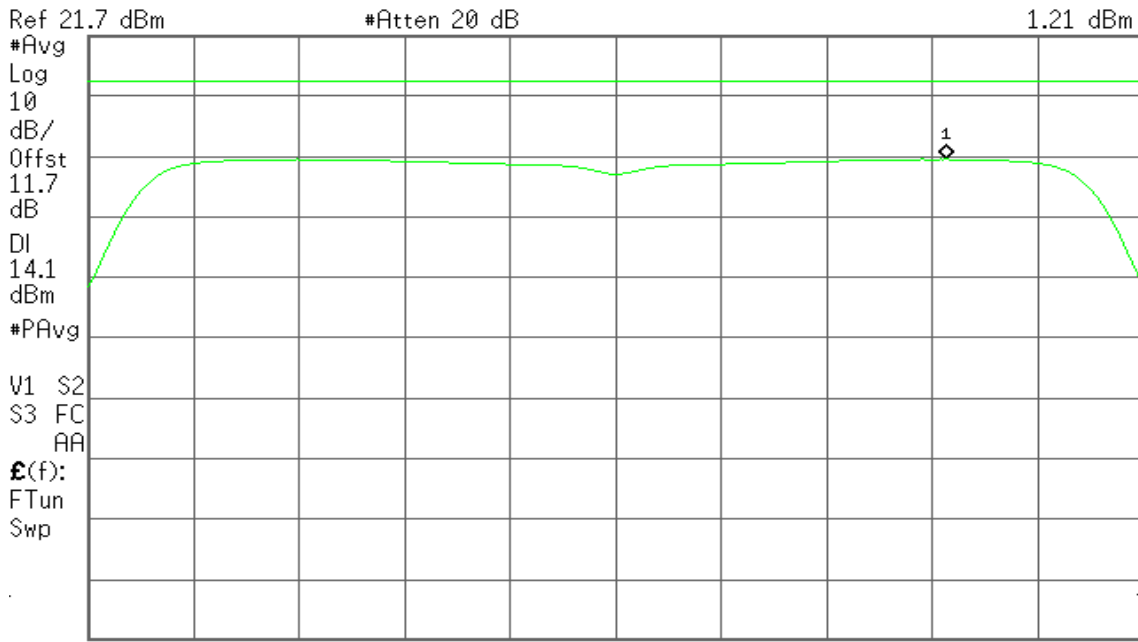

IEEE 802.11n HT 40 mode / 5190 ~ 5230MHz / Chain 0

CH Low

Agilent

R T

Mkr1 5.191 53 GHz
-3.19 dBm

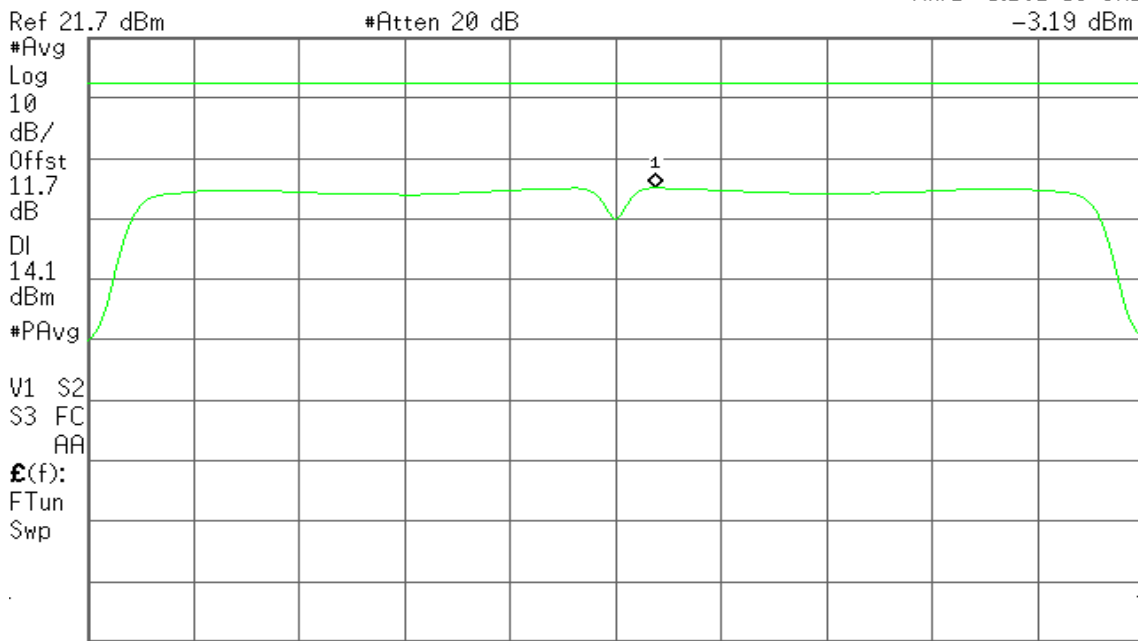



CH High

Agilent

R T

Mkr1 5.231 53 GHz
-3.36 dBm

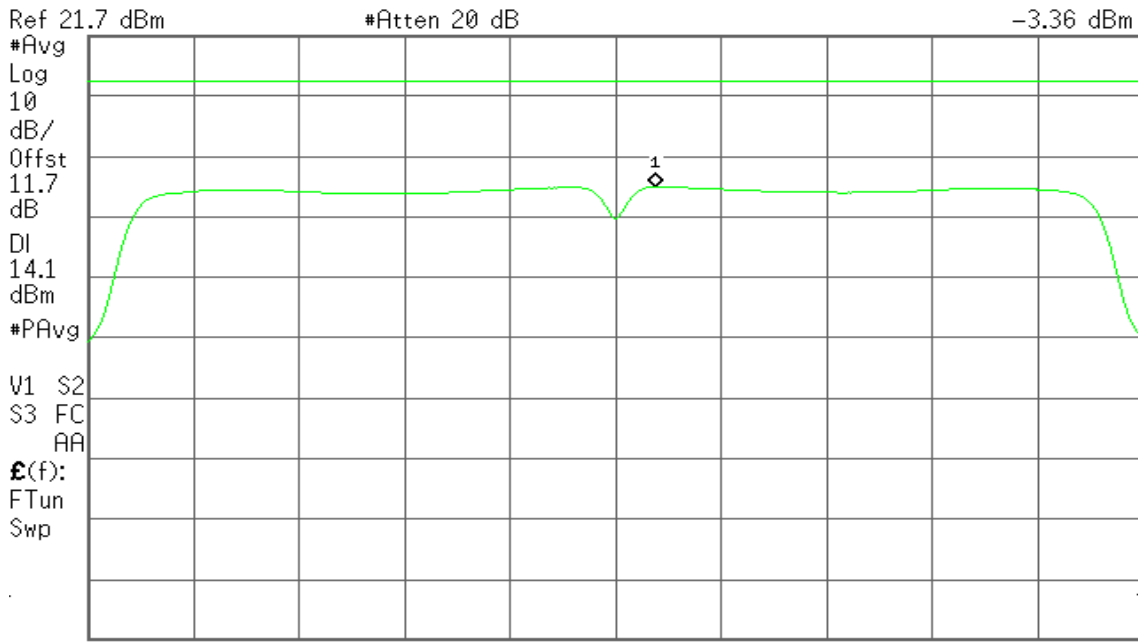

Center 5.230 00 GHz Span 40 MHz
#Res BW 1 MHz #VBW 3 MHz #Sweep 6 s (601 pts)

IEEE 802.11n HT 40 mode / 5190 ~ 5230MHz / Chain 1

CH Low

Agilent

R T

Mkr1 5.191 53 GHz
-2.79 dBm

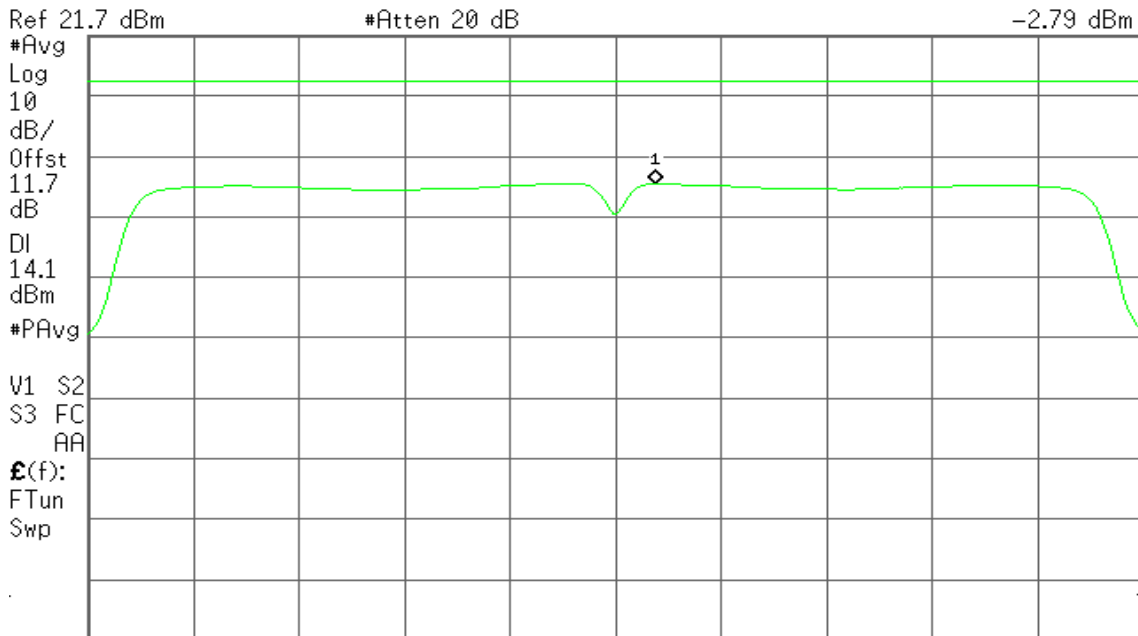

Center 5.190 00 GHz Span 40 MHz
#Res BW 1 MHz #VBW 3 MHz #Sweep 6 s (601 pts)



CH High

Agilent

R T

Mkr1 5.231 60 GHz
-3.61 dBm

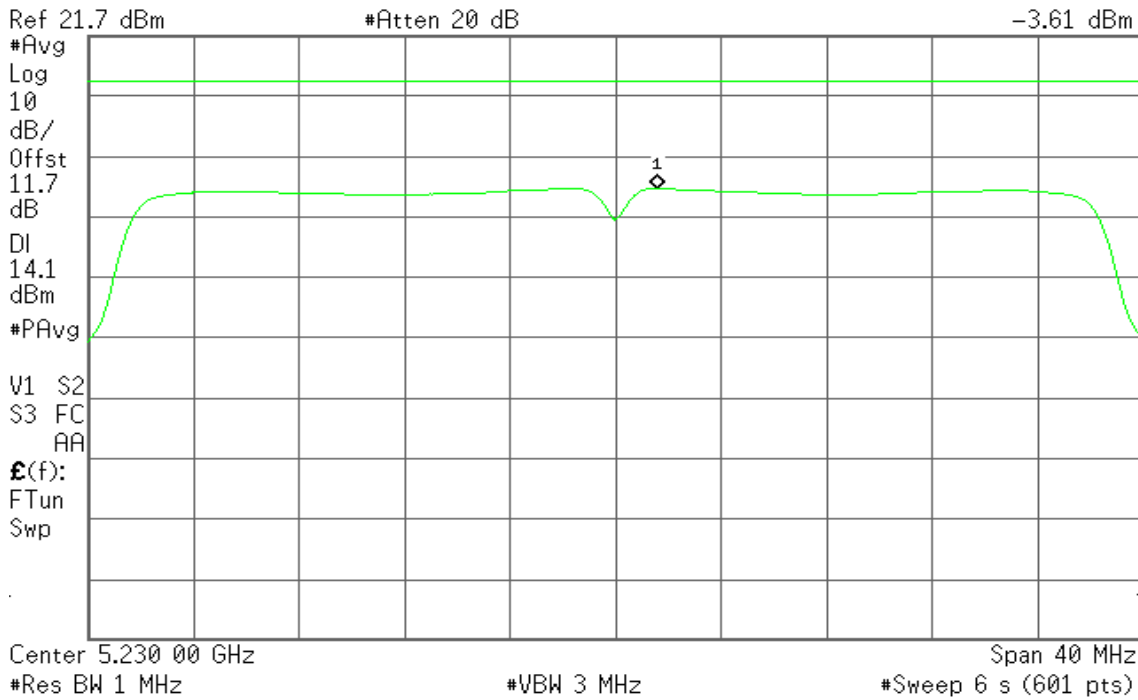

IEEE 802.11n HT 80 MHz mode / 5210MHz / Chain 0

CH Mid

Agilent

R T

Mkr1 5.236 93 GHz
-5.66 dBm

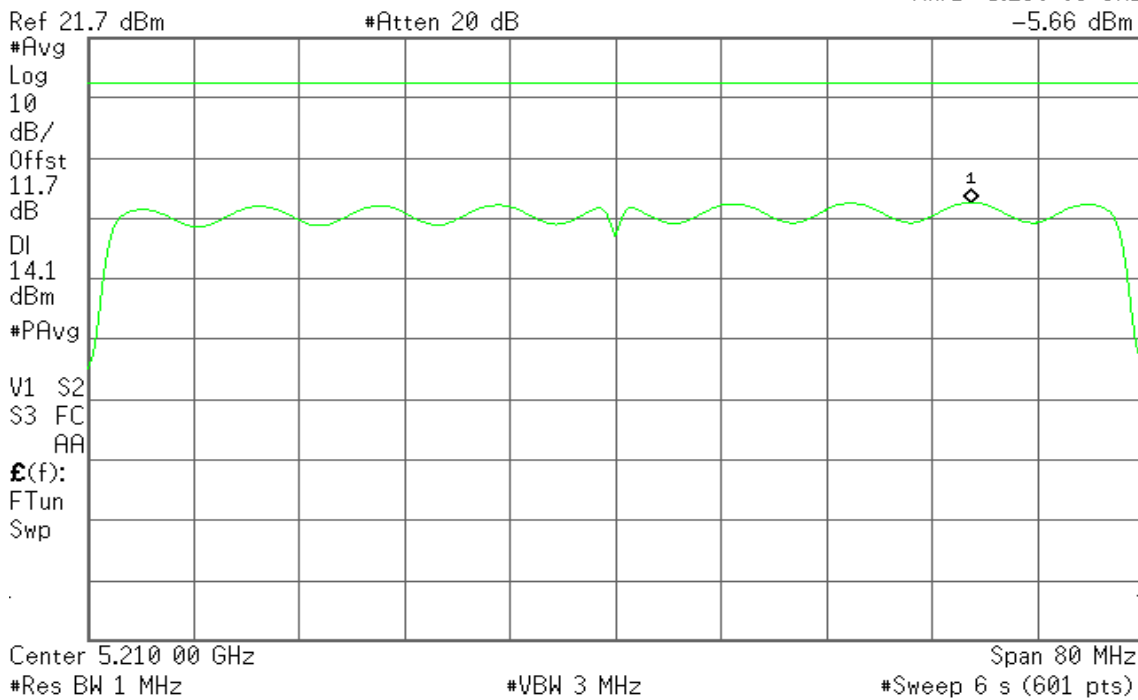



IEEE 802.11n HT 80 MHz mode / 5210MHz / Chain 1

CH Mid

Agilent

R T

Mkr1 5.236 93 GHz
-6.86 dBm

Ref 21.7 dBm

#Atten 20 dB

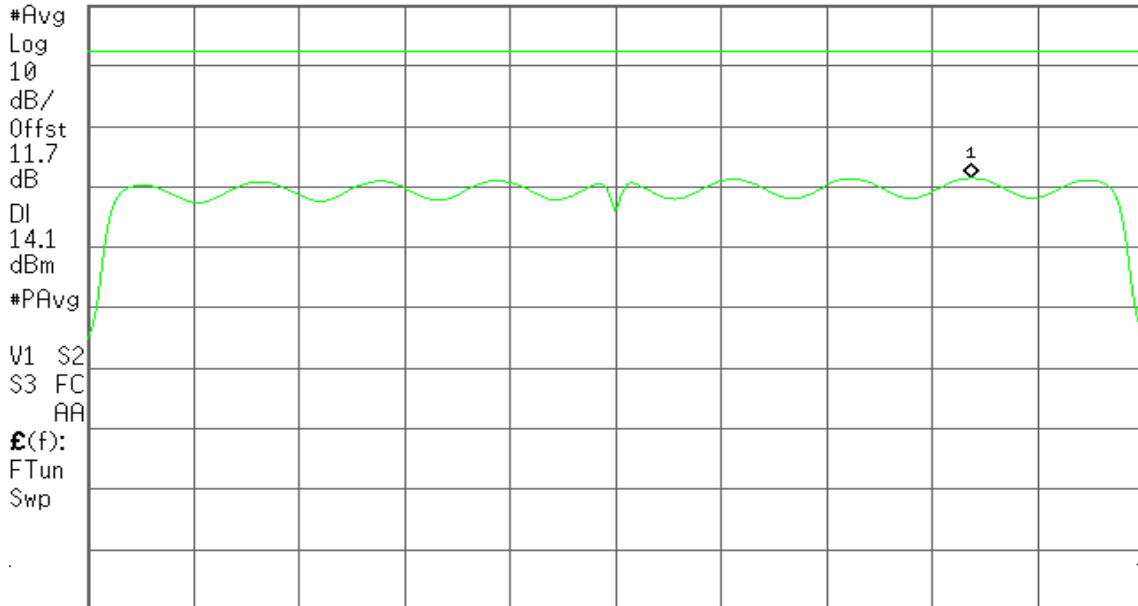

Center 5.210 00 GHz

#Res BW 1 MHz

#VBW 3 MHz

Span 80 MHz

#Sweep 6 s (601 pts)

IEEE 802.11a mode / 5745 ~ 5825MHz

CH Low

Agilent

R T

Mkr1 5.751 33 GHz
-1.41 dBm

Ref 31.7 dBm

#Atten 30 dB

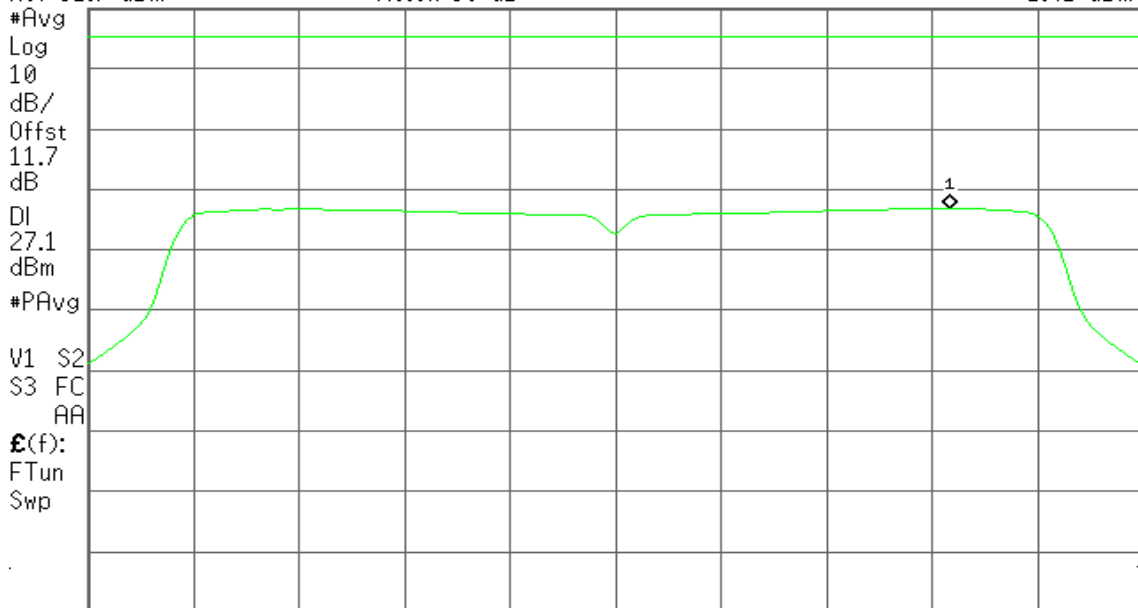

Center 5.745 00 GHz

#Res BW 510 kHz

#VBW 1.6 MHz

Span 20 MHz

#Sweep 6 s (601 pts)



CH Mid

Agilent

R T

Mkr1 5.791 37 GHz
-0.81 dBm

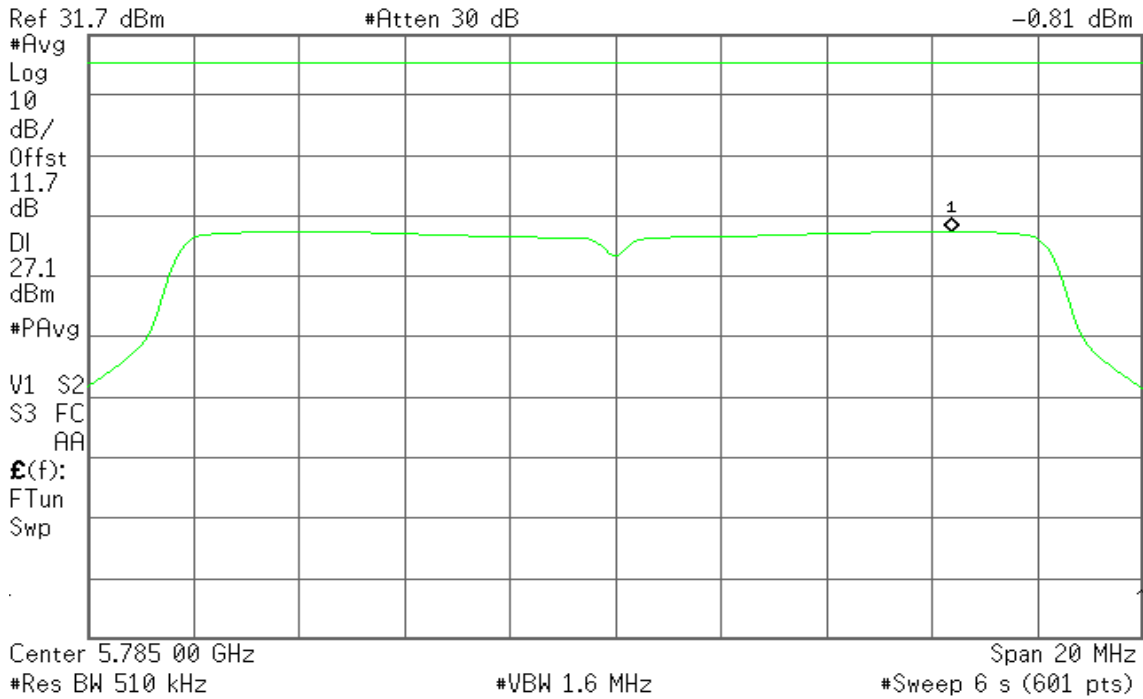

CH High

Agilent

R T

Mkr1 5.831 33 GHz
-1.17 dBm

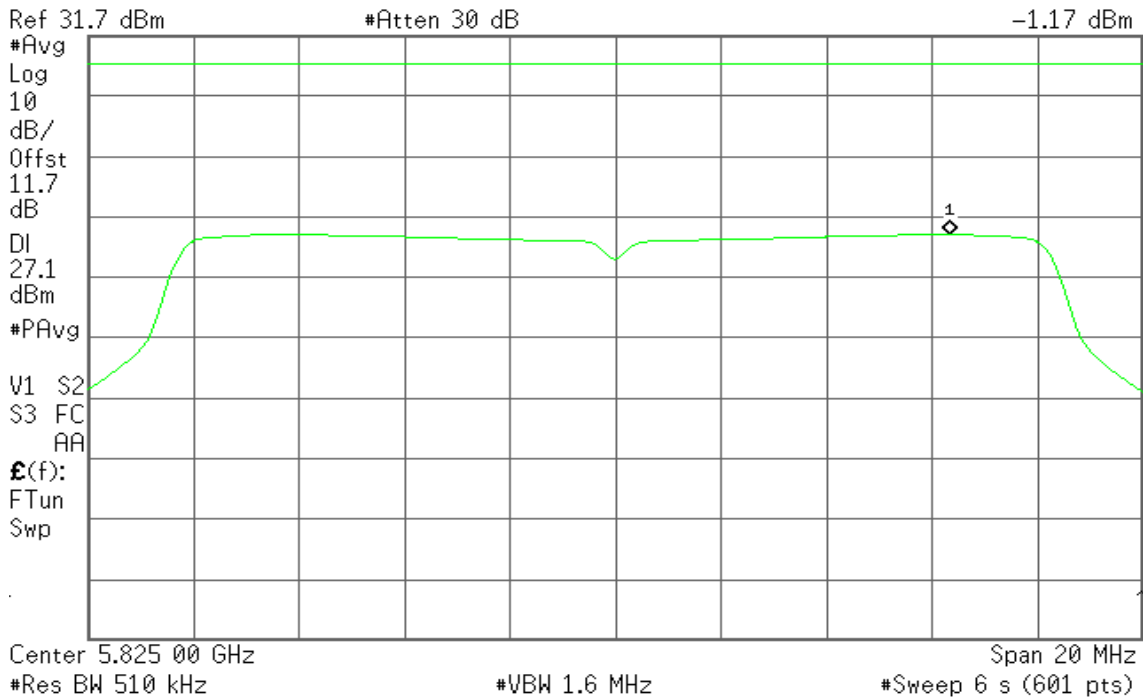



IEEE 802.11n HT 20 mode / 5745 ~ 5825MHz / Chain 0

CH Low

Agilent

R T

Mkr1 5.739 27 GHz
-3.49 dBm

Ref 31.7 dBm

#Atten 30 dB

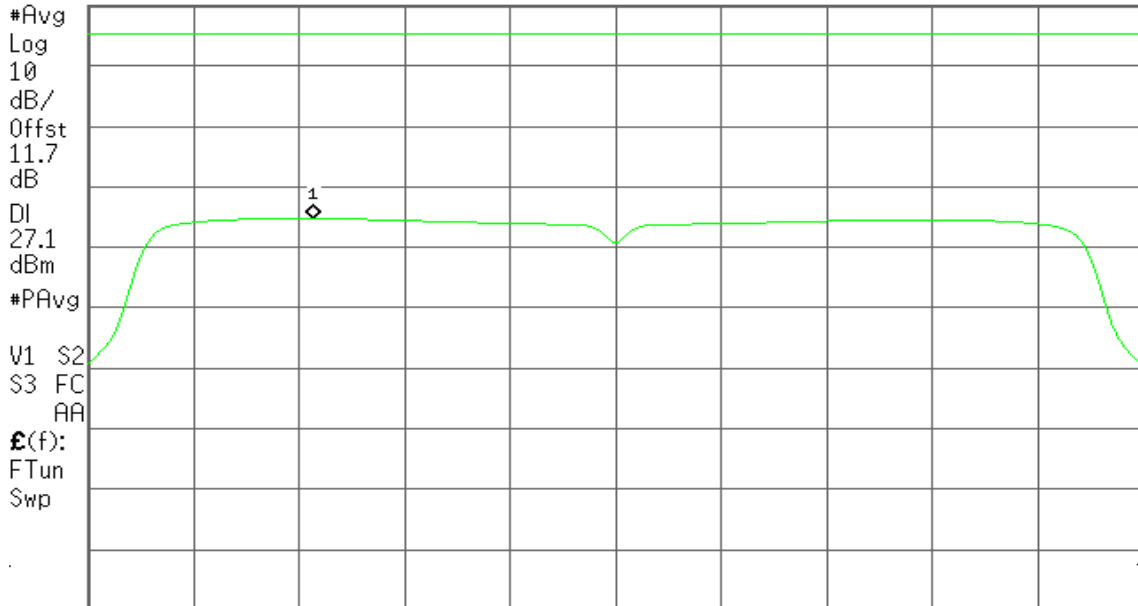

Center 5.745 00 GHz

Span 20 MHz

#Res BW 510 kHz

#VBW 1.6 MHz

#Sweep 6 s (601 pts)

CH Mid

Agilent

R T

Mkr1 5.778 77 GHz
-3.60 dBm

Ref 31.7 dBm

#Atten 30 dB

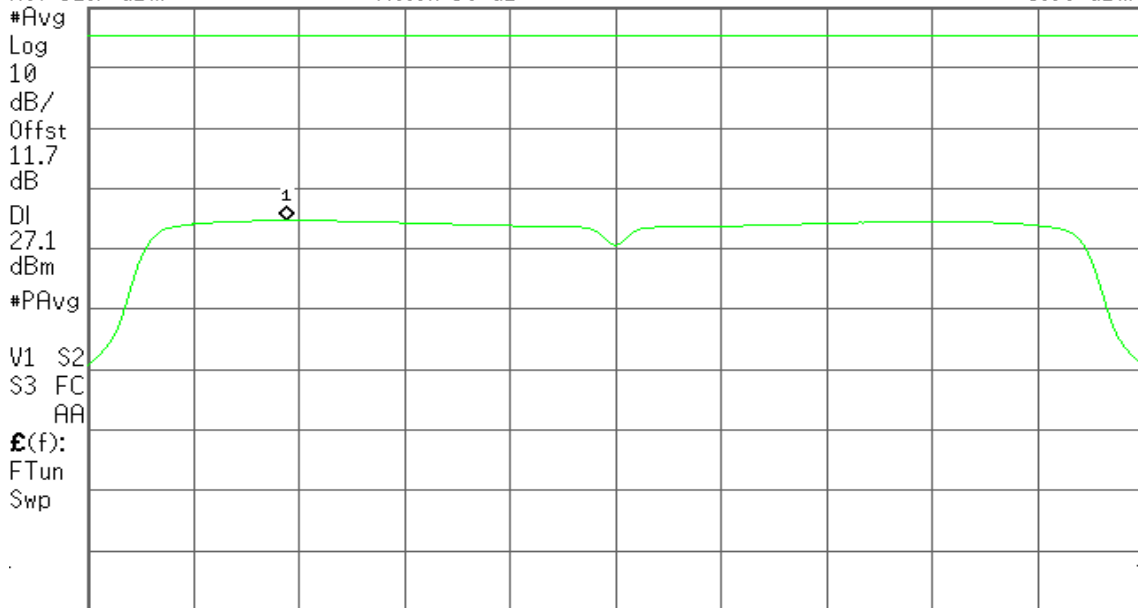

Center 5.785 00 GHz

Span 20 MHz

#Res BW 510 kHz

#VBW 1.6 MHz

#Sweep 6 s (601 pts)



CH High

Agilent

R T

Mkr1 5.818 73 GHz
-3.12 dBm

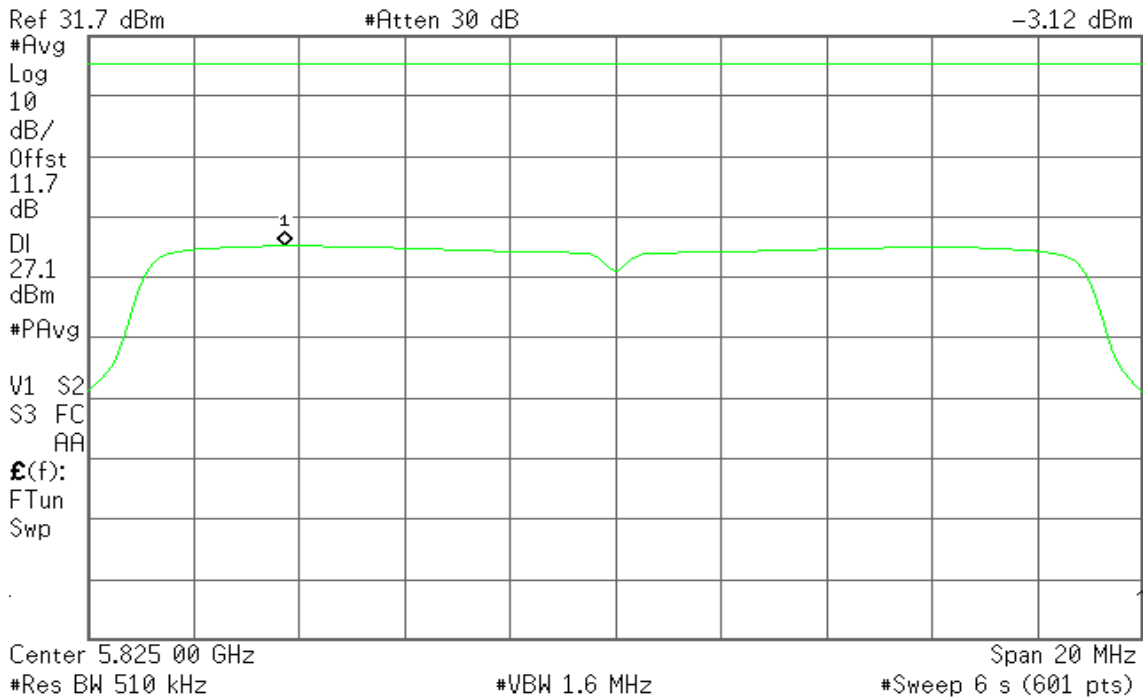

IEEE 802.11n HT 20 mode / 5745 ~ 5825MHz / Chain 1

CH Low

Agilent

R T

Mkr1 5.750 93 GHz
-5.24 dBm

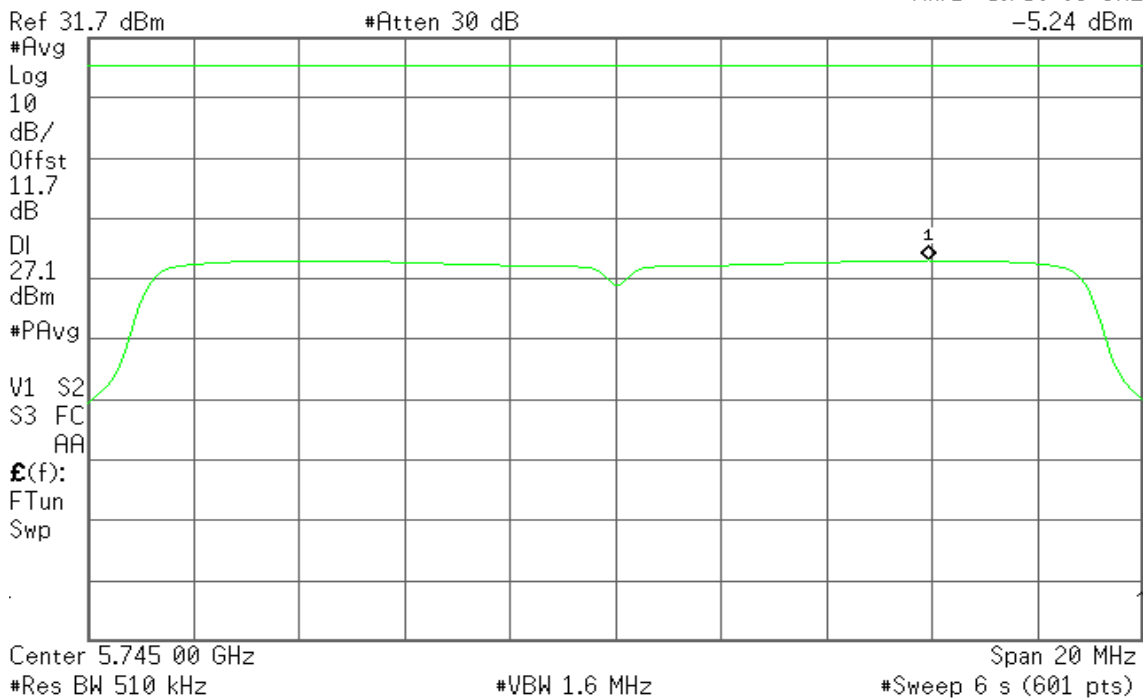



CH Mid

Agilent

R T

Mkr1 5.778 37 GHz
-4.22 dBm

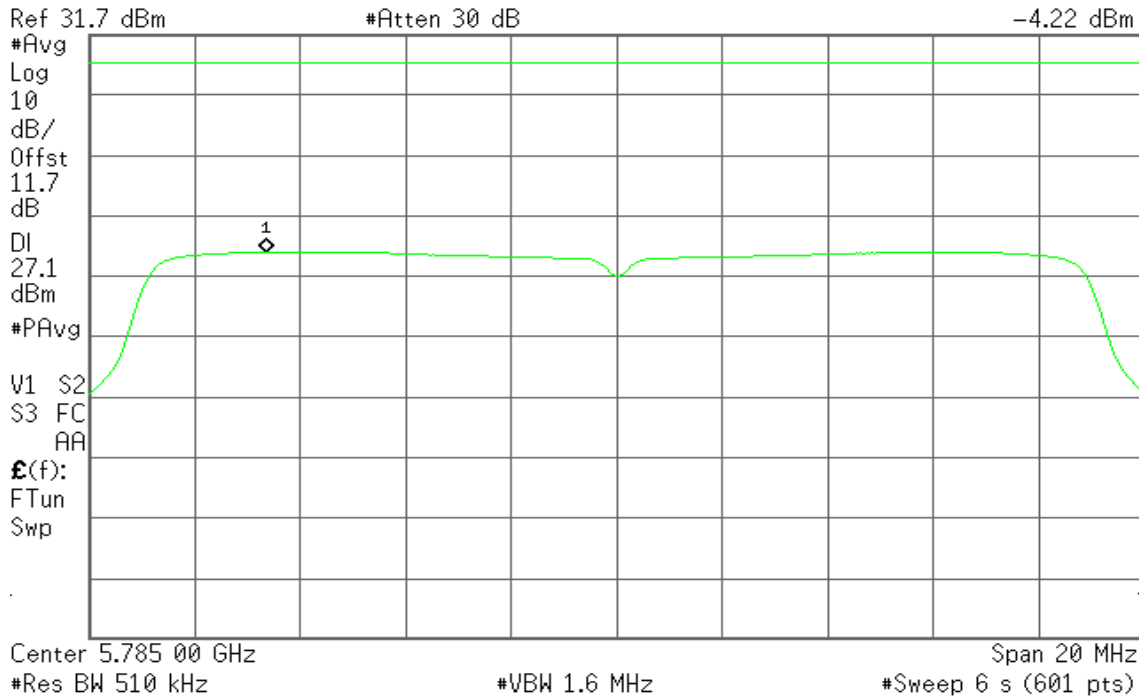

CH High

Agilent

R T

Mkr1 5.819 23 GHz
-3.88 dBm

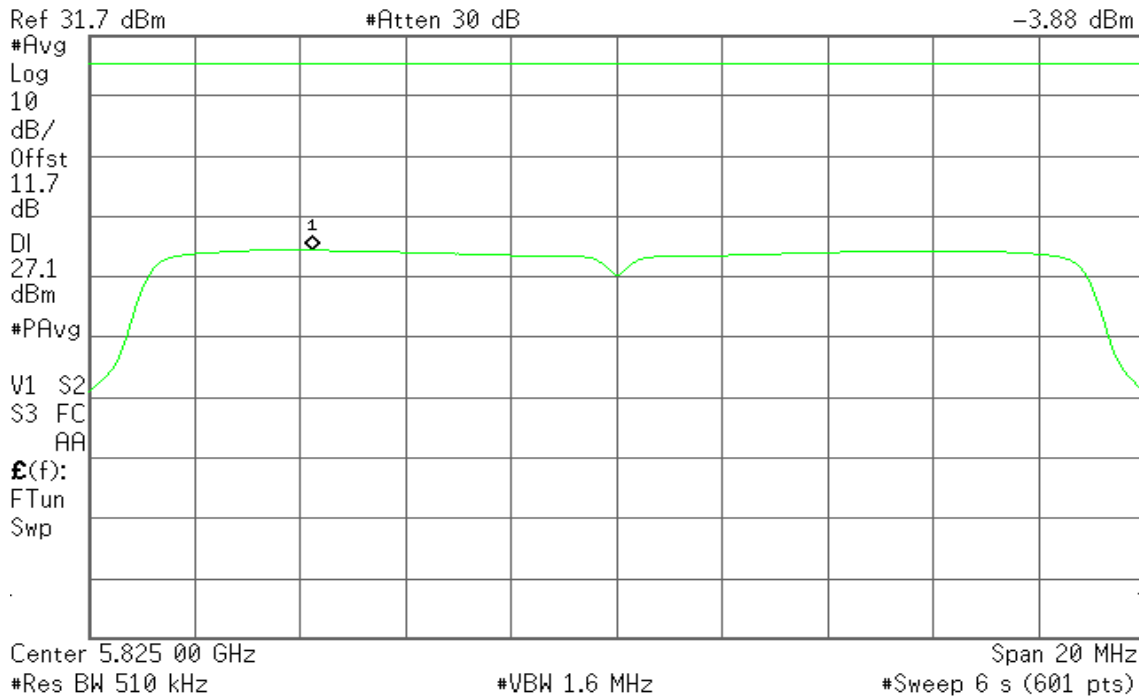



IEEE 802.11n HT 40 mode / 5755 ~ 5795MHz / Chain 0

CH Low

Agilent

R T

Mkr1 5.753 47 GHz
-6.67 dBm

Ref 31.7 dBm

#Atten 30 dB

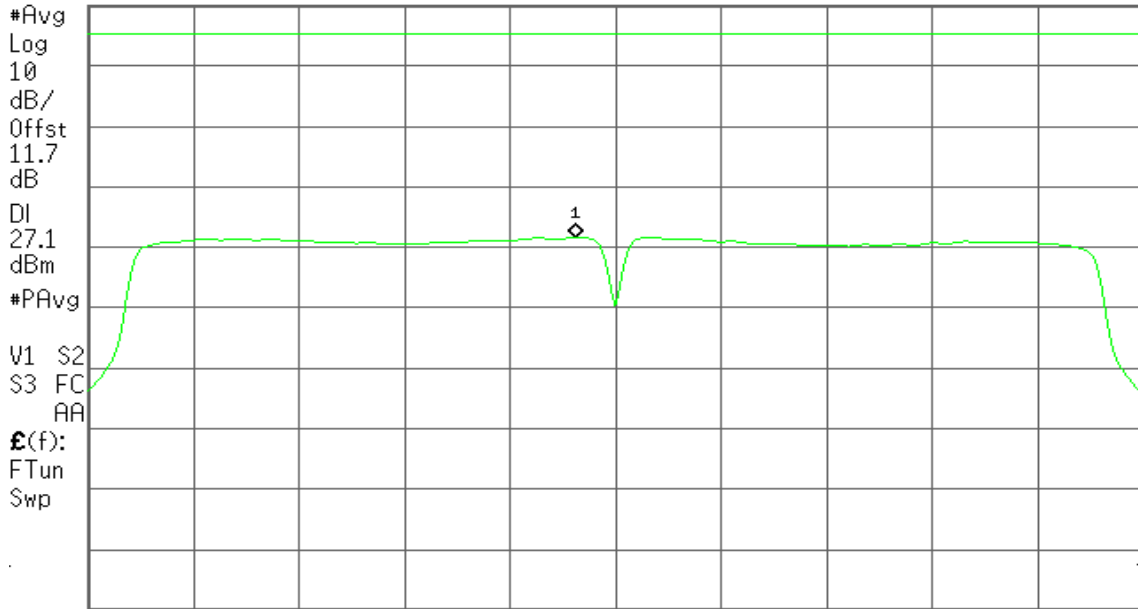

Center 5.755 00 GHz

#Res BW 510 kHz

#VBW 1.6 MHz

Span 40 MHz

#Sweep 6 s (601 pts)

CH High

Agilent

R T

Mkr1 5.793 60 GHz
-7.14 dBm

Ref 31.7 dBm

#Atten 30 dB

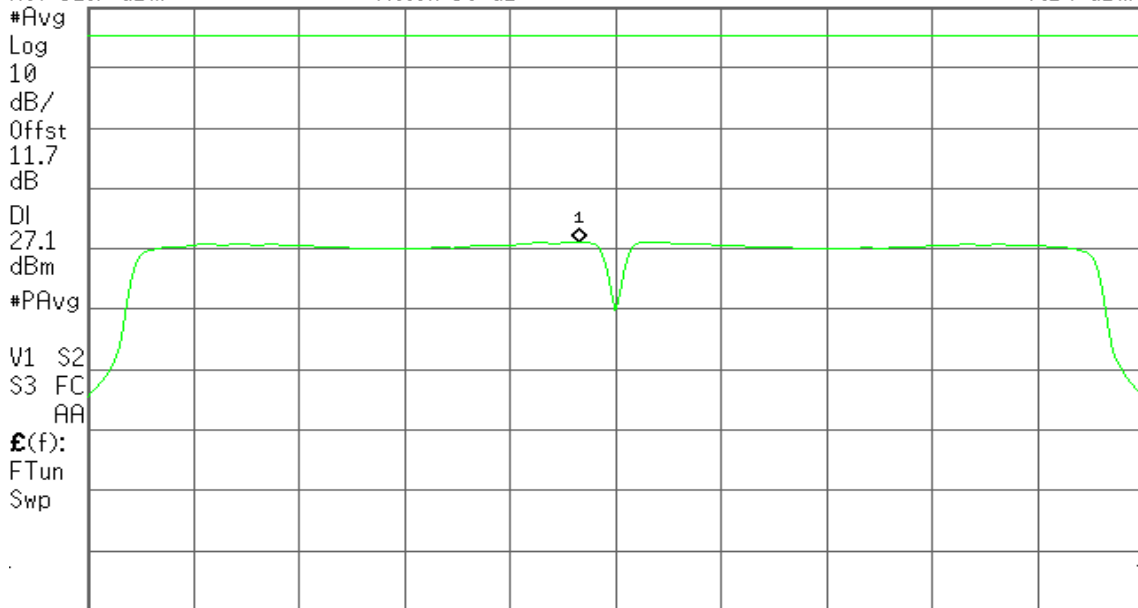

Center 5.795 00 GHz

#Res BW 510 kHz

#VBW 1.6 MHz

Span 40 MHz

#Sweep 6 s (601 pts)



IEEE 802.11n HT 40 mode / 5755 ~ 5795MHz / Chain 1

CH Low

Agilent

R T

Mkr1 5.756 53 GHz
-8.05 dBm

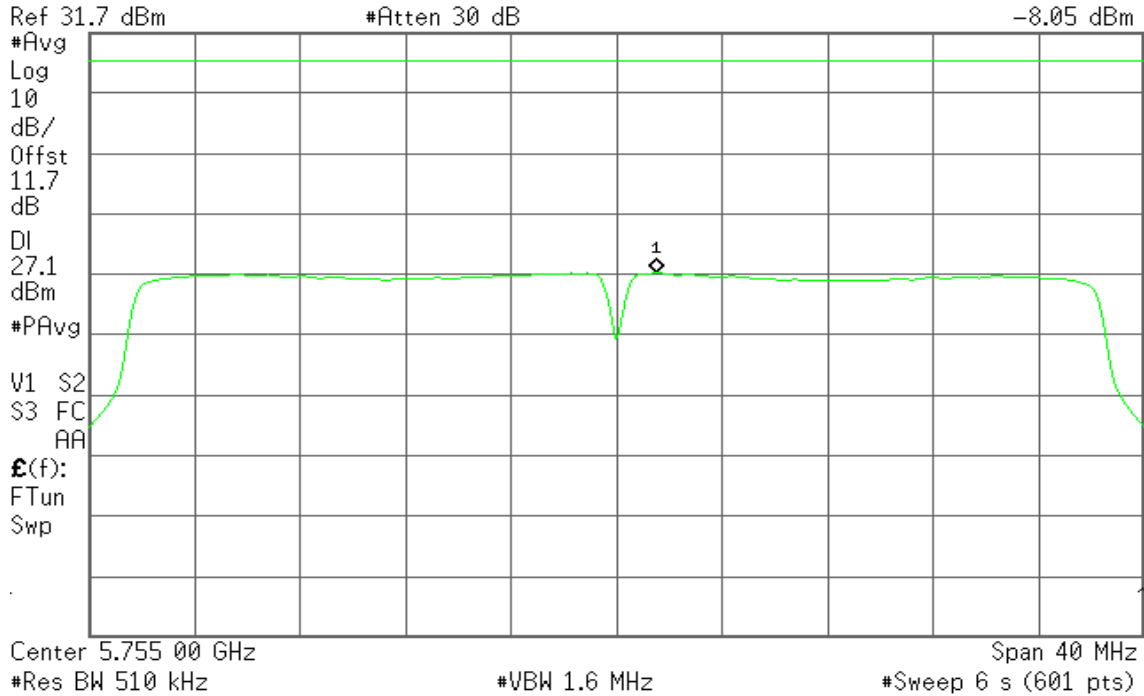

CH High

Agilent

R T

Mkr1 5.796 60 GHz
-7.53 dBm

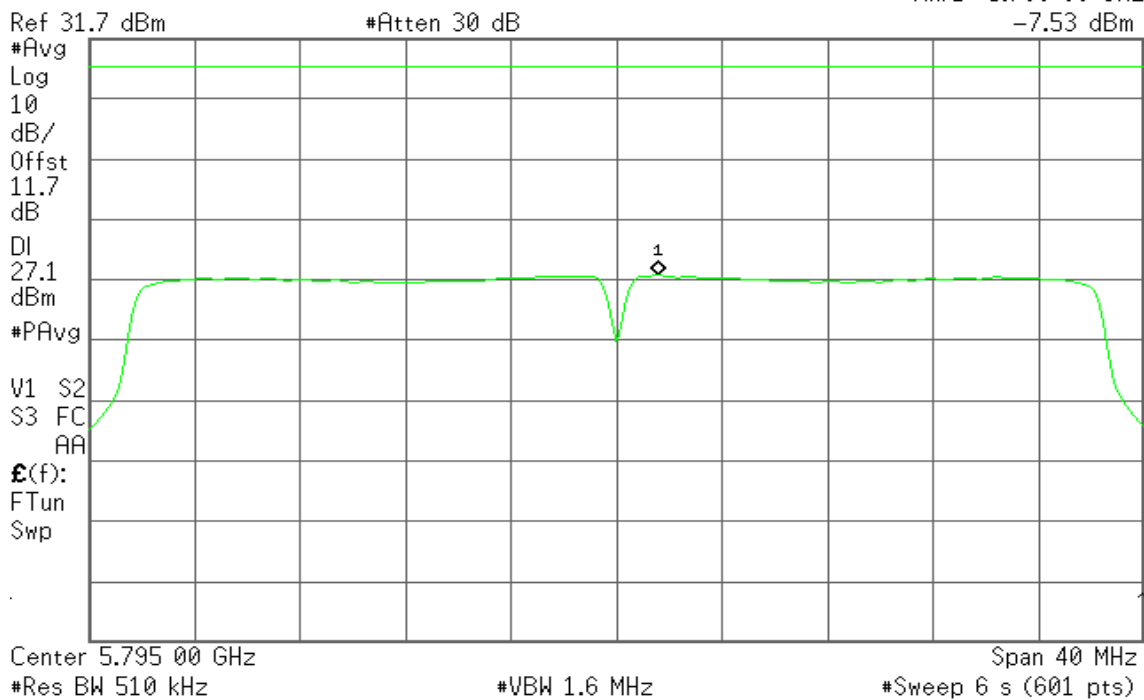



IEEE 802.11n HT 80 MHz mode / 5775MHz / Chain 0

CH Mid

Agilent

R T

Mkr1 5.748 07 GHz
-10.20 dBm

Ref 31.7 dBm

#Atten 30 dB

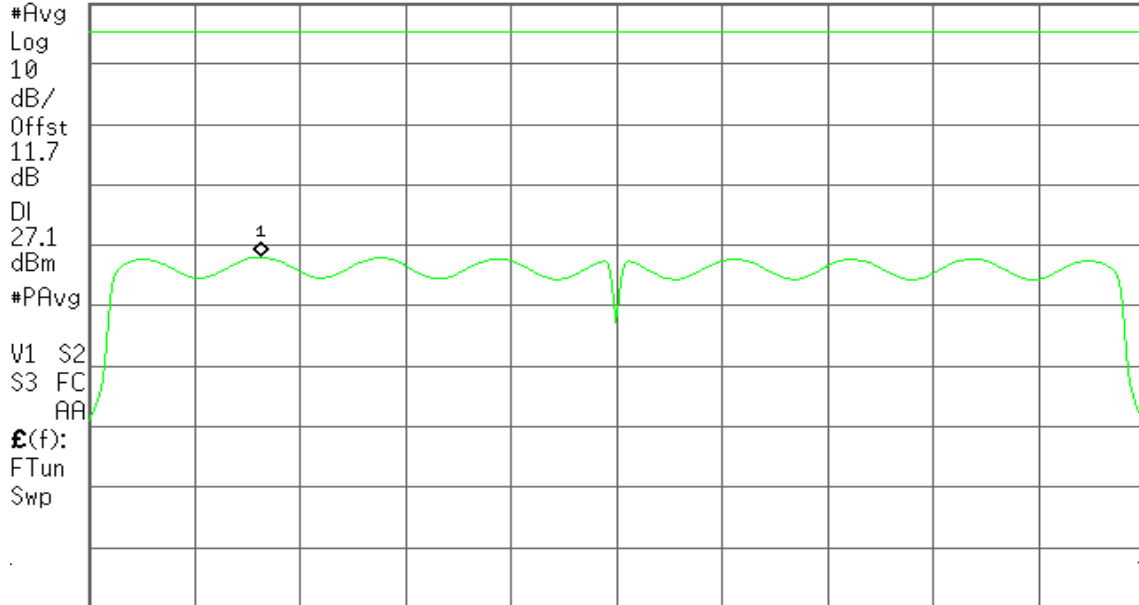

Center 5.775 00 GHz

Span 80 MHz

#Res BW 510 kHz

#VBW 1.6 MHz

#Sweep 6 s (601 pts)

IEEE 802.11n HT 80 MHz mode / 5775MHz / Chain 1

CH Mid

Agilent

R T

Mkr1 5.748 07 GHz
-10.96 dBm

Ref 31.7 dBm

#Atten 30 dB

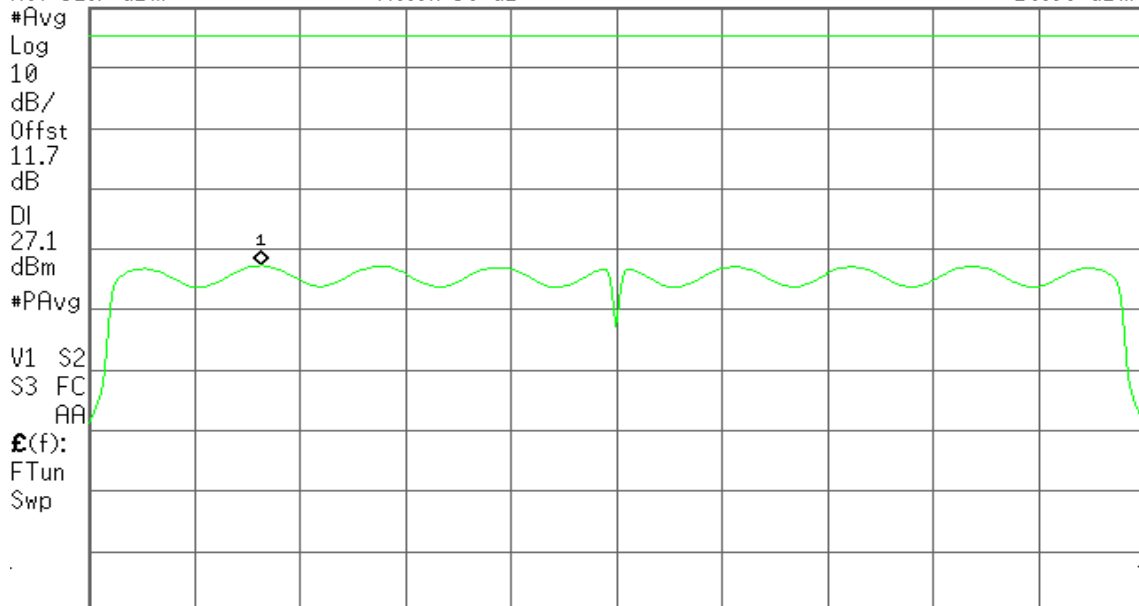

Center 5.775 00 GHz

Span 80 MHz

#Res BW 510 kHz

#VBW 1.6 MHz

#Sweep 6 s (601 pts)



7.6 RADIATED UNDESIRABLE EMISSION

1. According to §15.209(a), except as provided elsewhere in this Subpart, the emissions from an intentional radiator shall not exceed the field strength levels specified in the following table:

Frequency (MHz)	Field Strength ($\mu\text{V/m}$)	Measurement Distance (m)
0.009 - 0.490	2400/F(kHz)	300
0.490 - 1.705	24000/F(kHz)	30
1.705 – 30.0	30	30
30-88	100	3
88-216	150	3
216-960	200	3
Above 960	500	3

Remark: Except as provided in paragraph (g), fundamental emissions from intentional radiators operating under this Section shall not be located in the frequency bands 54-72 MHz, 76-88 MHz, 174-216 MHz or 470-806 MHz. However, operation within these frequency bands is permitted under other sections of this Part, e.g., Sections 15.231 and 15.241.

2. In the emission table above, the tighter limit applies at the band edges.

Frequency (MHz)	Field Strength ($\mu\text{V/m}$ at 3-meter)	Field Strength (dB $\mu\text{V/m}$ at 3-meter)
0.009 - 0.490	2400/F(kHz) +80	20LOG((2400/F(kHz))+80)
0.490 - 1.705	24000/F(kHz) +40	20LOG((24000/F(kHz))+40)
1.705 – 30.0	30	69.54
30-88	100	40
88-216	150	43.5
216-960	200	46
Above 960	500	54



Test Configuration

9kHz ~ 30MHz

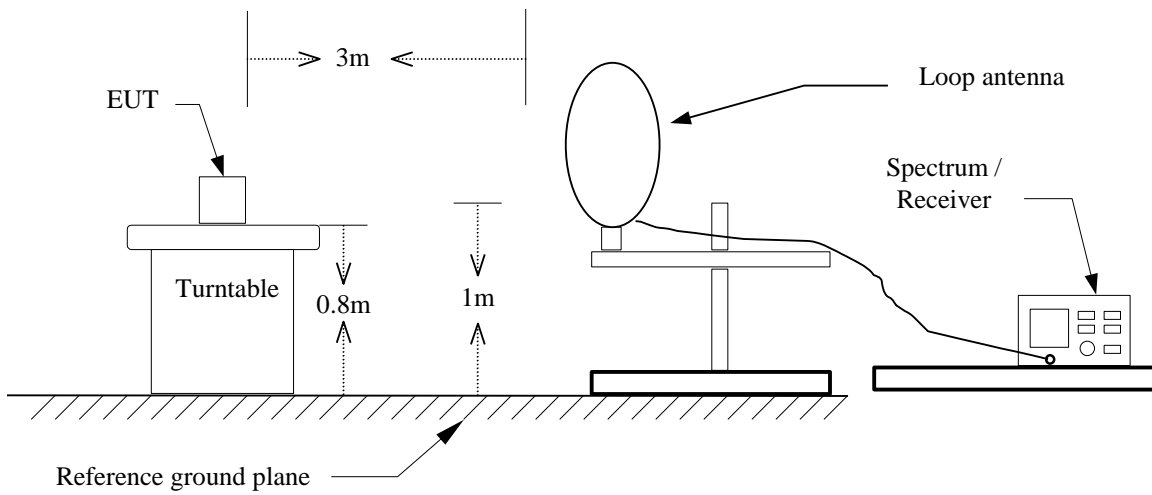

30MHz ~ 1GHz

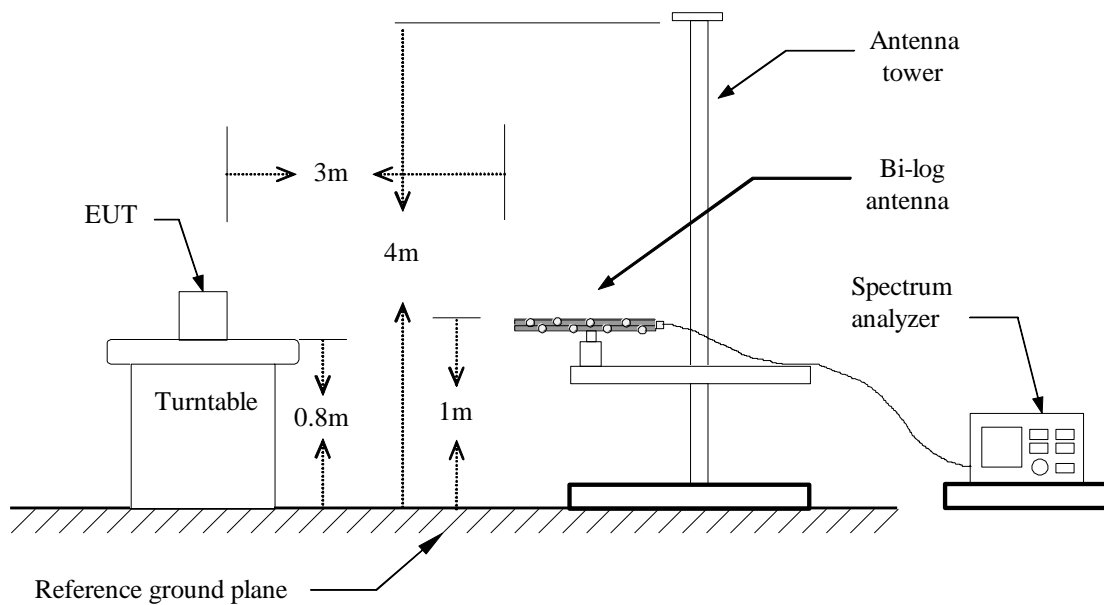



Above 1 GHz

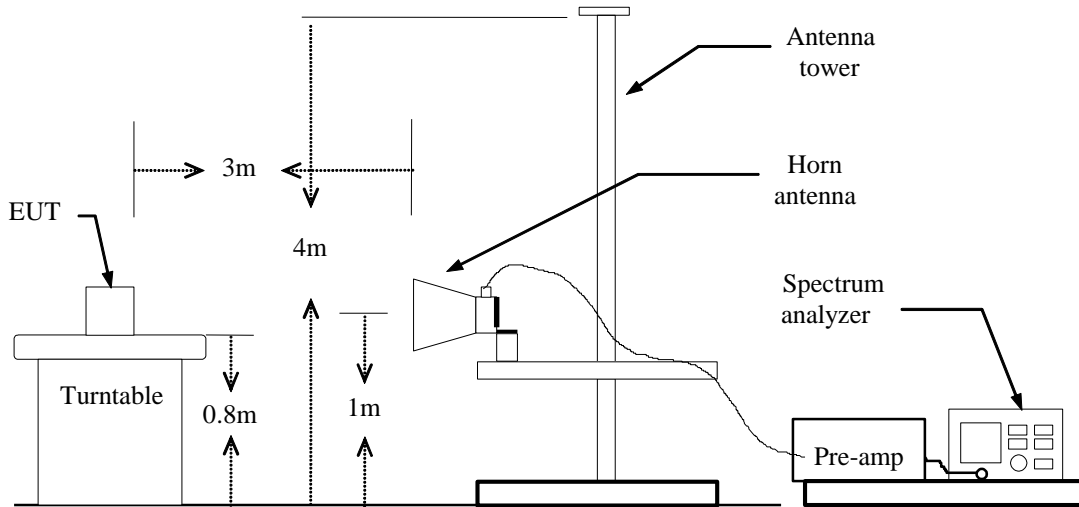



TEST PROCEDURE

1. The EUT is placed on a turntable, which is 0.8m above ground plane.
2. The turntable shall be rotated for 360 degrees to determine the position of maximum emission level.
3. EUT is set 3m away from the receiving antenna, which is varied from 1m to 4m to find out the highest emissions.
4. Maximum procedure was performed on the six highest emissions to ensure EUT compliance.
5. And also, each emission was to be maximized by changing the polarization of receiving antenna both horizontal and vertical.
6. Set the spectrum analyzer in the following setting as:

Below 1GHz:

RBW=100kHz / VBW=300kHz / Sweep=AUTO

Above 1GHz:

(a) PEAK: RBW=VBW=1MHz / Sweep=AUTO

(b) AVERAGE: RBW=1MHz / VBW=300Hz / Sweep=AUTO

7. Repeat above procedures until the measurements for all frequencies are complete.



Below 1 GHz

Operation Mode: Normal Link

Test Date: June 4, 2014

Temperature: 27°C

Tested by: David Shu

Humidity: 53% RH

Polarity: Ver. / Hor.

Frequency (MHz)	Reading (dBuV)	Correction Factor (dB/m)	Result (dBuV/m)	Limit (dBuV/m)	Margin (dB)	Remark	Ant.Pol. (H/V)
57.1600	54.58	-23.64	30.94	40.00	-9.06	peak	V
80.4400	50.59	-23.09	27.50	40.00	-12.50	peak	V
166.7700	44.75	-18.64	26.11	43.50	-17.39	peak	V
232.7300	51.24	-18.75	32.49	46.00	-13.51	peak	V
499.4800	45.75	-11.84	33.91	46.00	-12.09	peak	V
911.7300	41.81	-6.00	35.81	46.00	-10.19	peak	V
50.3700	53.82	-22.94	30.88	40.00	-9.12	peak	H
129.9100	48.65	-17.53	31.12	43.50	-12.38	peak	H
166.7700	52.82	-18.64	34.18	43.50	-9.32	peak	H
240.4900	54.41	-18.60	35.81	46.00	-10.19	peak	H
431.5800	46.53	-13.16	33.37	46.00	-12.63	peak	H
766.2300	43.44	-7.72	35.72	46.00	-10.28	peak	H

Remark:

1. No emission found between lowest internal used/generated frequency to 30MHz (9kHz~30MHz)
2. Radiated emissions measured in frequency range from 30 MHz to 1000MHz were made with an instrument using peak/quasi-peak detector mode.
3. Quasi-peak test would be performed if the peak result were greater than the quasi-peak limit.
4. Data of measurement within this frequency range shown “ --- ” in the table above means the reading of emissions are attenuated more than 20dB below the permissible limits or the field strength is too small to be measured.
5. Measurements above show only up to 6 maximum emissions noted, or would be lesser, with “ N/A ” remark, if no specific emissions from the EUT are recorded (ie: margin>20dB from the applicable limit) and considered that's already beyond the background noise floor.
6. Margin (dB) = Remark result (dBuV/m) – Quasi-peak limit (dBuV/m).



Above 1 GHz

Operation Mode: Tx / IEEE 802.11a mode / 5180 ~ 5240MHz / CH Low **Test Date:** May 30, 2014

Temperature: 27°C **Tested by:** David Shu

Humidity: 53% RH **Polarity:** Ver. / Hor.

Frequency (MHz)	Reading (dBuV)	Correction (dB/m)	Result (dBuV/m)	Limit (dBuV/m)	Margin (dB)	Remark	Ant.Pol. (H/V)
3107.000	53.05	-1.86	51.19	74.00	-22.81	peak	V
N/A							
3226.000	52.83	-1.48	51.35	74.00	-22.65	peak	H
N/A							

Remark:

1. Measuring frequencies from 1 GHz to the 10th harmonic of highest fundamental frequency.
2. Radiated emissions measured in frequency above 1000MHz were made with an instrument using peak/average detector mode.
3. Average test would be performed if the peak result were greater than the average limit.
4. Data of measurement within this frequency range shown " --- " in the table above means the reading of emissions are attenuated more than 20dB below the permissible limits or the field strength is too small to be measured.
5. Measurements above show only up to 6 maximum emissions noted, or would be lesser, with " N/A " remark, if no specific emissions from the EUT are recorded (ie: margin>20dB from the applicable limit) and considered that's already beyond the background noise floor.
6. $Margin (dB) = Remark\ result (dBuV/m) - Average\ limit (dBuV/m).$



Operation Mode: Tx / IEEE 802.11a mode / 5180 ~ 5240MHz /CH Mid **Test Date:** May 30, 2014
Temperature: 27°C **Tested by:** David Shu
Humidity: 53% RH **Polarity:** Ver. / Hor.

Frequency (MHz)	Reading (dBuV)	Correction (dB/m)	Result (dBuV/m)	Limit (dBuV/m)	Margin (dB)	Remark	Ant.Pol. (H/V)
2876.000	51.47	-2.47	49.00	74.00	-25.00	peak	V
N/A							
3324.000	52.26	-1.16	51.10	74.00	-22.90	peak	H
N/A							

Remark:

1. Measuring frequencies from 1 GHz to the 10th harmonic of highest fundamental frequency.
2. Radiated emissions measured in frequency above 1000MHz were made with an instrument using peak/average detector mode.
3. Average test would be performed if the peak result were greater than the average limit.
4. Data of measurement within this frequency range shown “ --- ” in the table above means the reading of emissions are attenuated more than 20dB below the permissible limits or the field strength is too small to be measured.
5. Measurements above show only up to 6 maximum emissions noted, or would be lesser, with “ N/A ” remark, if no specific emissions from the EUT are recorded (ie: margin>20dB from the applicable limit) and considered that's already beyond the background noise floor.
6. Margin (dB) = Remark result (dBuV/m) – Average limit (dBuV/m).



Operation Mode: Tx / IEEE 802.11a mode / 5180 ~ 5240MHz /CH High

Test Date: May 30, 2014

Temperature: 27°C

Tested by: David Shu

Humidity: 53% RH

Polarity: Ver. / Hor.

Frequency (MHz)	Reading (dBuV)	Correction (dB/m)	Result (dBuV/m)	Limit (dBuV/m)	Margin (dB)	Remark	Ant.Pol. (H/V)
3366.000	52.57	-1.02	51.55	74.00	-22.45	peak	V
N/A							
3275.000	52.00	-1.32	50.68	74.00	-23.32	peak	H
N/A							

Remark:

1. Measuring frequencies from 1 GHz to the 10th harmonic of highest fundamental frequency.
2. Radiated emissions measured in frequency above 1000MHz were made with an instrument using peak/average detector mode.
3. Average test would be performed if the peak result were greater than the average limit.
4. Data of measurement within this frequency range shown “ --- ” in the table above means the reading of emissions are attenuated more than 20dB below the permissible limits or the field strength is too small to be measured.
5. Measurements above show only up to 6 maximum emissions noted, or would be lesser, with “ N/A ” remark, if no specific emissions from the EUT are recorded (ie: margin>20dB from the applicable limit) and considered that's already beyond the background noise floor.
6. Margin (dB) = Remark result (dBuV/m) – Average limit (dBuV/m).



Operation Mode: Tx / IEEE 802.11n HT 20 mode / 5180 ~ 5240MHz / CH Low

Test Date: May 30, 2014

Temperature: 27°C

Tested by: David Shu

Humidity: 53% RH

Polarity: Ver. / Hor.

Frequency (MHz)	Reading (dBuV)	Correction (dB/m)	Result (dBuV/m)	Limit (dBuV/m)	Margin (dB)	Remark	Ant.Pol. (H/V)
3072.000	51.37	-1.98	49.39	74.00	-24.61	peak	V
N/A							
3093.000	52.15	-1.91	50.24	74.00	-23.76	peak	H
N/A							

Remark:

1. Measuring frequencies from 1 GHz to the 10th harmonic of highest fundamental frequency.
2. Radiated emissions measured in frequency above 1000MHz were made with an instrument using peak/average detector mode.
3. Average test would be performed if the peak result were greater than the average limit.
4. Data of measurement within this frequency range shown “ --- ” in the table above means the reading of emissions are attenuated more than 20dB below the permissible limits or the field strength is too small to be measured.
5. Measurements above show only up to 6 maximum emissions noted, or would be lesser, with “ N/A ” remark, if no specific emissions from the EUT are recorded (ie: margin>20dB from the applicable limit) and considered that's already beyond the background noise floor.
6. Margin (dB) = Remark result (dBuV/m) – Average limit (dBuV/m).



Operation Mode: Tx / IEEE 802.11n HT 20 mode / 5180 ~ 5240MHz / CH Mid

Test Date: May 30, 2014

Temperature: 27°C

Tested by: David Shu

Humidity: 53% RH

Polarity: Ver. / Hor.

Frequency (MHz)	Reading (dBuV)	Correction (dB/m)	Result (dBuV/m)	Limit (dBuV/m)	Margin (dB)	Remark	Ant.Pol. (H/V)
3821.000	50.45	1.39	51.84	74.00	-22.16	peak	V
N/A							
3156.000	52.21	-1.70	50.51	74.00	-23.49	peak	H
N/A							

Remark:

1. Measuring frequencies from 1 GHz to the 10th harmonic of highest fundamental frequency.
2. Radiated emissions measured in frequency above 1000MHz were made with an instrument using peak/average detector mode.
3. Average test would be performed if the peak result were greater than the average limit.
4. Data of measurement within this frequency range shown “ --- ” in the table above means the reading of emissions are attenuated more than 20dB below the permissible limits or the field strength is too small to be measured.
5. Measurements above show only up to 6 maximum emissions noted, or would be lesser, with “ N/A ” remark, if no specific emissions from the EUT are recorded (ie: margin>20dB from the applicable limit) and considered that's already beyond the background noise floor.
6. Margin (dB) = Remark result (dBuV/m) – Average limit (dBuV/m).



Operation Mode: Tx / IEEE 802.11n HT 20 mode / 5180 ~ 5240MHz / CH High

Test Date: May 30, 2014

Temperature: 27°C

Tested by: David Shu

Humidity: 53% RH

Polarity: Ver. / Hor.

Frequency (MHz)	Reading (dBuV)	Correction (dB/m)	Result (dBuV/m)	Limit (dBuV/m)	Margin (dB)	Remark	Ant.Pol. (H/V)
3184.000	52.37	-1.61	50.76	74.00	-23.24	peak	V
N/A							
3604.000	51.37	0.05	51.42	74.00	-22.58	peak	H
N/A							

Remark:

1. Measuring frequencies from 1 GHz to the 10th harmonic of highest fundamental frequency.
2. Radiated emissions measured in frequency above 1000MHz were made with an instrument using peak/average detector mode.
3. Average test would be performed if the peak result were greater than the average limit.
4. Data of measurement within this frequency range shown “ --- ” in the table above means the reading of emissions are attenuated more than 20dB below the permissible limits or the field strength is too small to be measured.
5. Measurements above show only up to 6 maximum emissions noted, or would be lesser, with “ N/A ” remark, if no specific emissions from the EUT are recorded (ie: margin>20dB from the applicable limit) and considered that's already beyond the background noise floor.
6. Margin (dB) = Remark result (dBuV/m) – Average limit (dBuV/m).



Operation Mode: Tx / IEEE 802.11n HT 40 mode / 5190 ~ 5230MHz / CH Low

Test Date: May 30, 2014

Temperature: 27°C

Tested by: David Shu

Humidity: 53% RH

Polarity: Ver. / Hor.

Frequency (MHz)	Reading (dBuV)	Correction (dB/m)	Result (dBuV/m)	Limit (dBuV/m)	Margin (dB)	Remark	Ant.Pol. (H/V)
3254.000	52.32	-1.39	50.93	74.00	-23.07	peak	V
N/A							
3373.000	51.87	-1.00	50.87	74.00	-23.13	peak	H
N/A							

Remark:

1. Measuring frequencies from 1 GHz to the 10th harmonic of highest fundamental frequency.
2. Radiated emissions measured in frequency above 1000MHz were made with an instrument using peak/average detector mode.
3. Average test would be performed if the peak result were greater than the average limit.
4. Data of measurement within this frequency range shown “ --- ” in the table above means the reading of emissions are attenuated more than 20dB below the permissible limits or the field strength is too small to be measured.
5. Measurements above show only up to 6 maximum emissions noted, or would be lesser, with “ N/A ” remark, if no specific emissions from the EUT are recorded (ie: margin>20dB from the applicable limit) and considered that's already beyond the background noise floor.
6. Margin (dB) = Remark result (dBuV/m) – Average limit (dBuV/m).



Operation Mode: Tx / IEEE 802.11n HT 40 mode / 5190 ~ 5230MHz / CH High

Test Date: May 30, 2014

Temperature: 27°C

Tested by: David Shu

Humidity: 53% RH

Polarity: Ver. / Hor.

Frequency (MHz)	Reading (dBuV)	Correction (dB/m)	Result (dBuV/m)	Limit (dBuV/m)	Margin (dB)	Remark	Ant.Pol. (H/V)
3345.000	52.05	-1.09	50.96	74.00	-23.04	peak	V
N/A							
3373.000	52.21	-1.00	51.21	74.00	-22.79	peak	H
N/A							

Remark:

1. Measuring frequencies from 1 GHz to the 10th harmonic of highest fundamental frequency.
2. Radiated emissions measured in frequency above 1000MHz were made with an instrument using peak/average detector mode.
3. Average test would be performed if the peak result were greater than the average limit.
4. Data of measurement within this frequency range shown “ --- ” in the table above means the reading of emissions are attenuated more than 20dB below the permissible limits or the field strength is too small to be measured.
5. Measurements above show only up to 6 maximum emissions noted, or would be lesser, with “ N/A ” remark, if no specific emissions from the EUT are recorded (ie: margin>20dB from the applicable limit) and considered that's already beyond the background noise floor.
6. Margin (dB) = Remark result (dBuV/m) – Average limit (dBuV/m).



Operation Mode: Tx / IEEE 802.11n HT 80 mode / 5210MHz

Test Date: May 30, 2014

Temperature: 27°C

Tested by: David Shu

Humidity: 53% RH

Polarity: Ver. / Hor.

Frequency (MHz)	Reading (dBuV)	Correction (dB/m)	Result (dBuV/m)	Limit (dBuV/m)	Margin (dB)	Remark	Ant.Pol. (H/V)
3128.000	53.25	-1.80	51.45	74.00	-22.55	peak	V
N/A							
3219.000	52.05	-1.50	50.55	74.00	-23.45	peak	H
N/A							

Remark:

1. Measuring frequencies from 1 GHz to the 10th harmonic of highest fundamental frequency.
2. Radiated emissions measured in frequency above 1000MHz were made with an instrument using peak/average detector mode.
3. Average test would be performed if the peak result were greater than the average limit.
4. Data of measurement within this frequency range shown “ --- ” in the table above means the reading of emissions are attenuated more than 20dB below the permissible limits or the field strength is too small to be measured.
5. Measurements above show only up to 6 maximum emissions noted, or would be lesser, with “ N/A ” remark, if no specific emissions from the EUT are recorded (ie: margin>20dB from the applicable limit) and considered that's already beyond the background noise floor.
6. Margin (dB) = Remark result (dBuV/m) – Average limit (dBuV/m).



Operation Mode: Tx / IEEE 802.11a mode / 5745 ~ 5825MHz / CH Low **Test Date:** May 30, 2014
Temperature: 27°C **Tested by:** David Shu
Humidity: 53% RH **Polarity:** Ver. / Hor.

Frequency (MHz)	Reading (dBuV)	Correction (dB/m)	Result (dBuV/m)	Limit (dBuV/m)	Margin (dB)	Remark	Ant.Pol. (H/V)
4010.000	51.42	2.50	53.92	74.00	-20.08	peak	V
N/A							
4423.000	49.58	3.08	52.66	74.00	-21.34	peak	H
N/A							

Remark:

1. Measuring frequencies from 1 GHz to the 10th harmonic of highest fundamental frequency.
2. Radiated emissions measured in frequency above 1000MHz were made with an instrument using peak/average detector mode.
3. Average test would be performed if the peak result were greater than the average limit.
4. Data of measurement within this frequency range shown “ --- ” in the table above means the reading of emissions are attenuated more than 20dB below the permissible limits or the field strength is too small to be measured.
5. Measurements above show only up to 6 maximum emissions noted, or would be lesser, with “ N/A ” remark, if no specific emissions from the EUT are recorded (ie: margin>20dB from the applicable limit) and considered that's already beyond the background noise floor.
6. Margin (dB) = Remark result (dBuV/m) – Average limit (dBuV/m).



Operation Mode: Tx / IEEE 802.11a mode / 5745 ~ 5825MHz /CH Mid **Test Date:** May 30, 2014
Temperature: 27°C **Tested by:** David Shu
Humidity: 53% RH **Polarity:** Ver. / Hor.

Frequency (MHz)	Reading (dBuV)	Correction (dB/m)	Result (dBuV/m)	Limit (dBuV/m)	Margin (dB)	Remark	Ant.Pol. (H/V)
4059.000	51.38	2.57	53.95	74.00	-20.05	peak	V
N/A							
3632.000	50.79	0.22	51.01	74.00	-22.99	peak	H
N/A							

Remark:

1. Measuring frequencies from 1 GHz to the 10th harmonic of highest fundamental frequency.
2. Radiated emissions measured in frequency above 1000MHz were made with an instrument using peak/average detector mode.
3. Average test would be performed if the peak result were greater than the average limit.
4. Data of measurement within this frequency range shown “ --- ” in the table above means the reading of emissions are attenuated more than 20dB below the permissible limits or the field strength is too small to be measured.
5. Measurements above show only up to 6 maximum emissions noted, or would be lesser, with “ N/A ” remark, if no specific emissions from the EUT are recorded (ie: margin>20dB from the applicable limit) and considered that's already beyond the background noise floor.
6. Margin (dB) = Remark result (dBuV/m) – Average limit (dBuV/m).



Operation Mode: Tx / IEEE 802.11a mode / 5745 ~ 5825MHz /CH High

Test Date: May 30, 2014

Temperature: 27°C

Tested by: David Shu

Humidity: 53% RH

Polarity: Ver. / Hor.

Frequency (MHz)	Reading (dBuV)	Correction (dB/m)	Result (dBuV/m)	Limit (dBuV/m)	Margin (dB)	Remark	Ant.Pol. (H/V)
4507.000	49.28	3.19	52.47	74.00	-21.53	peak	V
N/A							
3891.000	50.01	1.82	51.83	74.00	-22.17	peak	H
N/A							

Remark:

1. Measuring frequencies from 1 GHz to the 10th harmonic of highest fundamental frequency.
2. Radiated emissions measured in frequency above 1000MHz were made with an instrument using peak/average detector mode.
3. Average test would be performed if the peak result were greater than the average limit.
4. Data of measurement within this frequency range shown “ --- ” in the table above means the reading of emissions are attenuated more than 20dB below the permissible limits or the field strength is too small to be measured.
5. Measurements above show only up to 6 maximum emissions noted, or would be lesser, with “ N/A ” remark, if no specific emissions from the EUT are recorded (ie: margin>20dB from the applicable limit) and considered that's already beyond the background noise floor.
6. Margin (dB) = Remark result (dBuV/m) – Average limit (dBuV/m).



Operation Mode: Tx / IEEE 802.11n HT 20 mode / 5745 ~ 5825MHz / CH Low

Test Date: May 30, 2014

Temperature: 27°C

Tested by: David Shu

Humidity: 53% RH

Polarity: Ver. / Hor.

Frequency (MHz)	Reading (dBuV)	Correction (dB/m)	Result (dBuV/m)	Limit (dBuV/m)	Margin (dB)	Remark	Ant.Pol. (H/V)
3618.000	51.55	0.14	51.69	74.00	-22.31	peak	V
N/A							
3324.000	51.86	-1.16	50.70	74.00	-23.30	peak	H
N/A							

Remark:

1. Measuring frequencies from 1 GHz to the 10th harmonic of highest fundamental frequency.
2. Radiated emissions measured in frequency above 1000MHz were made with an instrument using peak/average detector mode.
3. Average test would be performed if the peak result were greater than the average limit.
4. Data of measurement within this frequency range shown “ --- ” in the table above means the reading of emissions are attenuated more than 20dB below the permissible limits or the field strength is too small to be measured.
5. Measurements above show only up to 6 maximum emissions noted, or would be lesser, with “ N/A ” remark, if no specific emissions from the EUT are recorded (ie: margin>20dB from the applicable limit) and considered that's already beyond the background noise floor.
6. Margin (dB) = Remark result (dBuV/m) – Average limit (dBuV/m).



Operation Mode: Tx / IEEE 802.11n HT 20 mode / 5745 ~ 5825MHz / CH Mid

Test Date: May 30, 2014

Temperature: 27°C

Tested by: David Shu

Humidity: 53% RH

Polarity: Ver. / Hor.

Frequency (MHz)	Reading (dBuV)	Correction (dB/m)	Result (dBuV/m)	Limit (dBuV/m)	Margin (dB)	Remark	Ant.Pol. (H/V)
3919.000	49.88	1.99	51.87	74.00	-22.13	peak	V
N/A							
4073.000	50.42	2.59	53.01	74.00	-20.99	peak	H
N/A							

Remark:

1. Measuring frequencies from 1 GHz to the 10th harmonic of highest fundamental frequency.
2. Radiated emissions measured in frequency above 1000MHz were made with an instrument using peak/average detector mode.
3. Average test would be performed if the peak result were greater than the average limit.
4. Data of measurement within this frequency range shown “ --- ” in the table above means the reading of emissions are attenuated more than 20dB below the permissible limits or the field strength is too small to be measured.
5. Measurements above show only up to 6 maximum emissions noted, or would be lesser, with “ N/A ” remark, if no specific emissions from the EUT are recorded (ie: margin>20dB from the applicable limit) and considered that's already beyond the background noise floor.
6. Margin (dB) = Remark result (dBuV/m) – Average limit (dBuV/m).



Operation Mode: Tx / IEEE 802.11n HT 20 mode / 5745 ~ 5825MHz / CH High

Test Date: May 30, 2014

Temperature: 27°C

Tested by: David Shu

Humidity: 53% RH

Polarity: Ver. / Hor.

Frequency (MHz)	Reading (dBuV)	Correction (dB/m)	Result (dBuV/m)	Limit (dBuV/m)	Margin (dB)	Remark	Ant.Pol. (H/V)
2960.000	50.11	-2.29	47.82	74.00	-26.18	peak	V
N/A							
4150.000	50.35	2.70	53.05	74.00	-20.95	peak	H
N/A							

Remark:

1. Measuring frequencies from 1 GHz to the 10th harmonic of highest fundamental frequency.
2. Radiated emissions measured in frequency above 1000MHz were made with an instrument using peak/average detector mode.
3. Average test would be performed if the peak result were greater than the average limit.
4. Data of measurement within this frequency range shown “ --- ” in the table above means the reading of emissions are attenuated more than 20dB below the permissible limits or the field strength is too small to be measured.
5. Measurements above show only up to 6 maximum emissions noted, or would be lesser, with “ N/A ” remark, if no specific emissions from the EUT are recorded (ie: margin>20dB from the applicable limit) and considered that's already beyond the background noise floor.
6. Margin (dB) = Remark result (dBuV/m) – Average limit (dBuV/m).



Operation Mode: Tx / IEEE 802.11n HT 40 mode / 5755 ~ 5795MHz / CH Low

Test Date: May 30, 2014

Temperature: 27°C

Tested by: David Shu

Humidity: 53% RH

Polarity: Ver. / Hor.

Frequency (MHz)	Reading (dBuV)	Correction (dB/m)	Result (dBuV/m)	Limit (dBuV/m)	Margin (dB)	Remark	Ant.Pol. (H/V)
4059.000	50.17	2.57	52.74	74.00	-21.26	peak	V
N/A							
3226.000	51.88	-1.48	50.40	74.00	-23.60	peak	H
N/A							

Remark:

1. Measuring frequencies from 1 GHz to the 10th harmonic of highest fundamental frequency.
2. Radiated emissions measured in frequency above 1000MHz were made with an instrument using peak/average detector mode.
3. Average test would be performed if the peak result were greater than the average limit.
4. Data of measurement within this frequency range shown “ --- ” in the table above means the reading of emissions are attenuated more than 20dB below the permissible limits or the field strength is too small to be measured.
5. Measurements above show only up to 6 maximum emissions noted, or would be lesser, with “ N/A ” remark, if no specific emissions from the EUT are recorded (ie: margin>20dB from the applicable limit) and considered that's already beyond the background noise floor.
6. Margin (dB) = Remark result (dBuV/m) – Average limit (dBuV/m).



Operation Mode: Tx / IEEE 802.11n HT 40 mode / 5755 ~ 5795MHz / CH High

Test Date: May 30, 2014

Temperature: 27°C

Tested by: David Shu

Humidity: 53% RH

Polarity: Ver. / Hor.

Frequency (MHz)	Reading (dBuV)	Correction (dB/m)	Result (dBuV/m)	Limit (dBuV/m)	Margin (dB)	Remark	Ant.Pol. (H/V)
3835.000	50.86	1.47	52.33	74.00	-21.67	peak	V
N/A							
3996.000	50.16	2.47	52.63	74.00	-21.37	peak	H
N/A							

Remark:

1. Measuring frequencies from 1 GHz to the 10th harmonic of highest fundamental frequency.
2. Radiated emissions measured in frequency above 1000MHz were made with an instrument using peak/average detector mode.
3. Average test would be performed if the peak result were greater than the average limit.
4. Data of measurement within this frequency range shown “ --- ” in the table above means the reading of emissions are attenuated more than 20dB below the permissible limits or the field strength is too small to be measured.
5. Measurements above show only up to 6 maximum emissions noted, or would be lesser, with “ N/A ” remark, if no specific emissions from the EUT are recorded (ie: margin>20dB from the applicable limit) and considered that's already beyond the background noise floor.
6. Margin (dB) = Remark result (dBuV/m) – Average limit (dBuV/m).



Operation Mode: Tx / IEEE 802.11n HT 80 mode / 5755MHz

Test Date: May 30, 2014

Temperature: 27°C

Tested by: David Shu

Humidity: 53% RH

Polarity: Ver. / Hor.

Frequency (MHz)	Reading (dBuV)	Correction (dB/m)	Result (dBuV/m)	Limit (dBuV/m)	Margin (dB)	Remark	Ant.Pol. (H/V)
3884.000	50.25	1.78	52.03	74.00	-21.97	peak	V
N/A							
2862.000	50.55	-2.50	48.05	74.00	-25.95	peak	H
N/A							

Remark:

1. Measuring frequencies from 1 GHz to the 10th harmonic of highest fundamental frequency.
2. Radiated emissions measured in frequency above 1000MHz were made with an instrument using peak/average detector mode.
3. Average test would be performed if the peak result were greater than the average limit.
4. Data of measurement within this frequency range shown “ --- ” in the table above means the reading of emissions are attenuated more than 20dB below the permissible limits or the field strength is too small to be measured.
5. Measurements above show only up to 6 maximum emissions noted, or would be lesser, with “ N/A ” remark, if no specific emissions from the EUT are recorded (ie: margin>20dB from the applicable limit) and considered that's already beyond the background noise floor.
6. $Margin (dB) = Remark\ result (dBuV/m) - Average\ limit (dBuV/m)$.



7.7 POWERLINE CONDUCTED EMISSIONS

LIMIT

According to §15.207(a), except as shown in paragraphs (b) and (c) of this section, for an intentional radiator that is designed to be connected to the public utility (AC) power line, the radio frequency voltage that is conducted back onto the AC power line on any frequency or frequencies within the band 150 kHz to 30 MHz shall not exceed the limits in the following table, as measured using a 50 μ H/50 ohms line impedance stabilization network (LISN). Compliance with the provisions of this paragraph shall be based on the measurement of the radio frequency voltage between each power line and ground at the power terminal. The lower limit applies at the boundary between the frequency ranges.

Frequency Range (MHz)	Limits (dB μ V)	
	Quasi-peak	Average
0.15 to 0.50	66 to 56*	56 to 46*
0.50 to 5	56	46
5 to 30	60	50

* Decreases with the logarithm of the frequency.

TEST CONFIGURATION

See test photographs attached in Appendix 1 for the actual connections between EUT and support equipment.

TEST PROCEDURE

1. The EUT was placed on a table, which is 0.8m above ground plane.
2. Maximum procedure was performed on the six highest emissions to ensure EUT compliance.
3. Repeat above procedures until all frequency measured were complete.



TEST RESULTS

The initial step in collecting conducted data is a spectrum analyzer peak scan of the measurement range. Significant peaks are then marked as shown on the following data page, and these signals are then quasi-peaked.

Test Data

Operation Mode: Normal Link **Test Date:** May 26, 2014
Temperature: 26°C **Tested by:** David Shu
Humidity: 60% RH

Freq. (MHz)	QP Reading (dBuV)	AV Reading (dBuV)	Corr. factor (dB)	QP Result (dBuV)	AV Result (dBuV)	QP Limit (dBuV)	AV Limit (dBuV)	QP Margin (dB)	AV Margin (dB)	Note
0.1700	42.15	27.02	0.19	42.34	27.21	64.96	54.96	-22.62	-27.75	L1
0.2020	43.05	37.62	0.19	43.24	37.81	63.53	53.53	-20.29	-15.72	L1
0.3740	42.87	28.60	0.20	43.07	28.80	58.41	48.41	-15.34	-19.61	L1
0.7100	36.53	23.98	0.21	36.74	24.19	56.00	46.00	-19.26	-21.81	L1
0.8980	34.34	20.86	0.21	34.55	21.07	56.00	46.00	-21.45	-24.93	L1
1.2020	34.75	19.51	0.20	34.95	19.71	56.00	46.00	-21.05	-26.29	L1
0.1620	47.64	26.39	0.10	47.74	26.49	65.36	55.36	-17.62	-28.87	L2
0.1780	41.86	25.81	0.10	41.96	25.91	64.58	54.58	-22.62	-28.67	L2
0.3180	38.05	20.70	0.10	38.15	20.80	59.76	49.76	-21.61	-28.96	L2
0.3940	39.73	29.75	0.10	39.83	29.85	57.98	47.98	-18.15	-18.13	L2
0.6060	35.36	23.66	0.10	35.46	23.76	56.00	46.00	-20.54	-22.24	L2
0.8180	32.96	22.16	0.10	33.06	22.26	56.00	46.00	-22.94	-23.74	L2

Remark:

1. Measuring frequencies from 0.15 MHz to 30MHz.
2. The emissions measured in frequency range from 0.15 MHz to 30MHz were made with an instrument using Quasi-peak detector and average detector.
3. The IF bandwidth of SPA between 0.15MHz to 30MHz was 10kHz; the IF bandwidth of Test Receiver between 0.15MHz to 30MHz was 9kHz;
4. L1 = Line One (Live Line) / L2 = Line Two (Neutral Line)



Test Plots

Conducted emissions (Line 1)

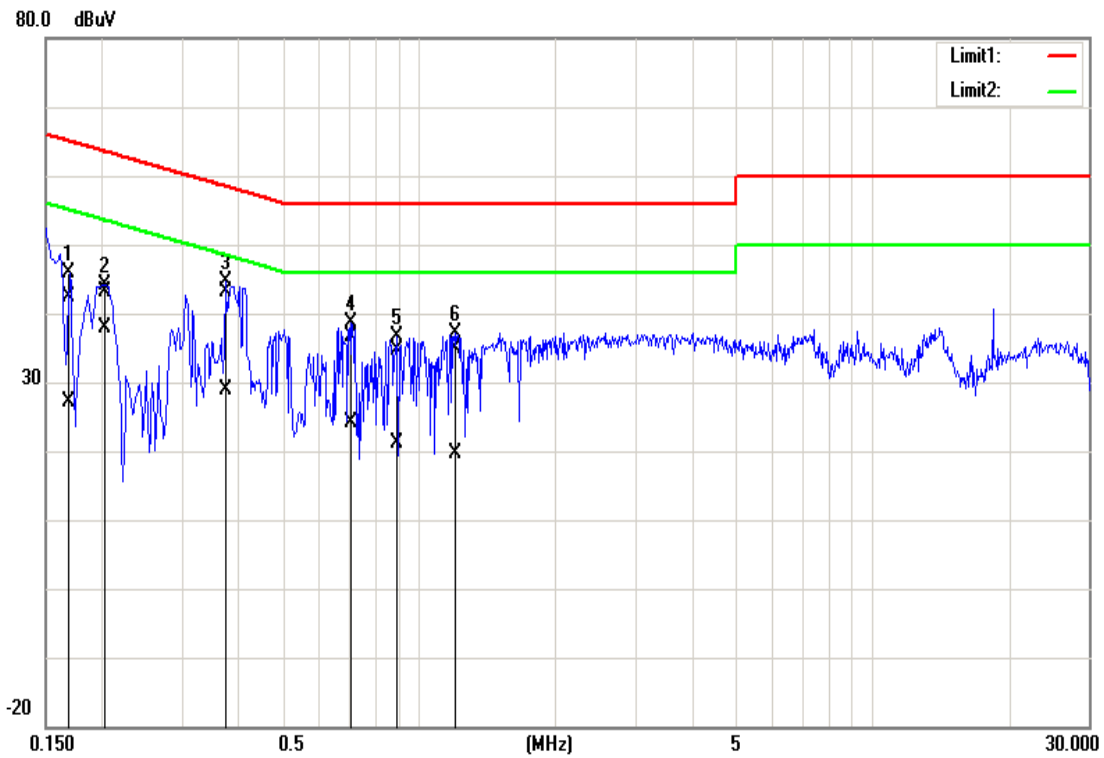

Conducted emissions (Line 2)

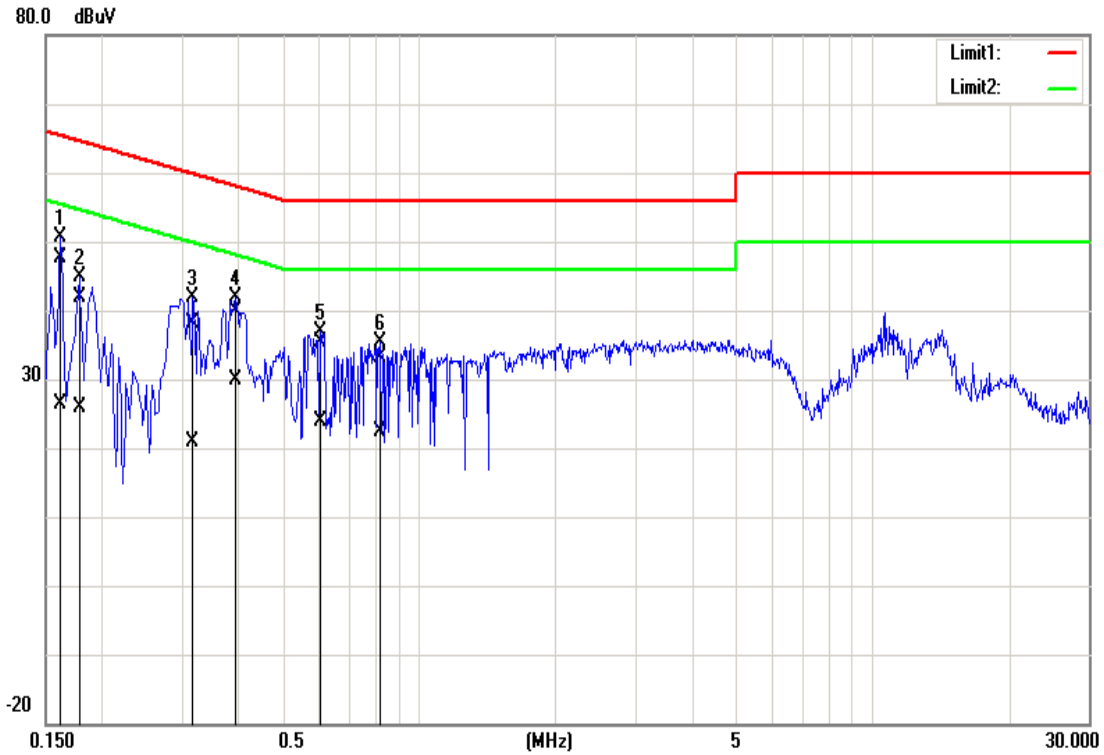



7.8 FREQUENCY STABILITY

LIMIT

According to §15.407(g), manufacturers of U-NII devices are responsible for ensuring frequency stability such that an emission is maintained within the band of operation under all conditions of normal operation as specified in the user's manual.

Test Configuration

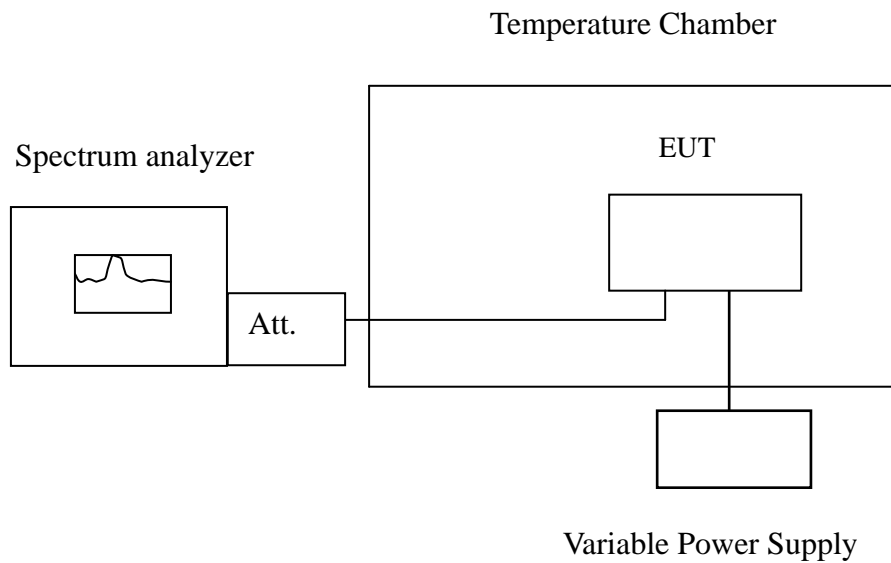

Remark: Measurement setup for testing on Antenna connector



TEST PROCEDURE

The equipment under test was connected to an external AC or DC power supply and input rated voltage. RF output was connected to a frequency counter or spectrum analyzer via feed through attenuators. The EUT was placed inside the temperature chamber. Set the spectrum analyzer RBW low enough to obtain the desired frequency resolution and measure EUT 20°C operating frequency as reference frequency. Turn EUT off and set the chamber temperature to -20°C. After the temperature stabilized for approximately 30 minutes recorded the frequency. Repeat step measure with 10°C increased per stage until the highest temperature of +50°C reached.

TEST RESULTS

No non-compliance noted.

IEEE 802.11a mode / 5180 ~ 5240 MHz:

CH Low

Operating Frequency: 5180 MHz				
Environment Temperature (°C)	Voltage (V)	Measured Frequency (MHz)	Limit Range	Test Result
50	110	5179.981450	5150~5250	Pass
40	110	5179.978690	5150~5250	Pass
30	110	5180.004357	5150~5250	Pass
20	110	5179.987110	5150~5250	Pass
10	110	5180.016432	5150~5250	Pass
0	110	5179.993661	5150~5250	Pass
-10	110	5179.978570	5150~5250	Pass
-20	110	5180.008421	5150~5250	Pass

Operating Frequency: 5180 MHz				
Environment Temperature (°C)	Voltage (V)	Measured Frequency (MHz)	Limit Range	Test Result
20	99	5179.980649	5150~5250	Pass
	110	5179.988902	5150~5250	Pass
	121	5180.01945	5150~5250	Pass



CH Mid

Operating Frequency: 5220 MHz				
Environment Temperature (°C)	Voltage (V)	Measured Frequency (MHz)	Limit Range	Test Result
50	110	5219.992215	5150~5250	Pass
40	110	5219.992502	5150~5250	Pass
30	110	5219.976308	5150~5250	Pass
20	110	5219.990965	5150~5250	Pass
10	110	5220.014747	5150~5250	Pass
0	110	5220.017104	5150~5250	Pass
-10	110	5219.983516	5150~5250	Pass
-20	110	5219.977970	5150~5250	Pass

Operating Frequency: 5220 MHz				
Environment Temperature (°C)	Voltage (V)	Measured Frequency (MHz)	Limit Range	Test Result
20	99	5219.994529	5150~5250	Pass
	110	5219.99491	5150~5250	Pass
	121	5219.990519	5150~5250	Pass



CH High

Operating Frequency: 5240 MHz				
Environment Temperature (°C)	Voltage (V)	Measured Frequency (MHz)	Limit Range	Test Result
50	110	5239.988492	5150~5250	Pass
40	110	5239.989069	5150~5250	Pass
30	110	5239.977121	5150~5250	Pass
20	110	5240.008775	5150~5250	Pass
10	110	5240.019077	5150~5250	Pass
0	110	5239.996633	5150~5250	Pass
-10	110	5240.017787	5150~5250	Pass
-20	110	5240.009597	5150~5250	Pass

Operating Frequency: 5240 MHz				
Environment Temperature (°C)	Voltage (V)	Measured Frequency (MHz)	Limit Range	Test Result
20	99	5240.006745	5150~5250	Pass
	110	5239.970727	5150~5250	Pass
	121	5239.972046	5150~5250	Pass



IEEE 802.11n HT 20 mode / 5180 ~ 5240 MHz:

CH Low

Operating Frequency: 5180 MHz				
Environment Temperature (°C)	Voltage (V)	Measured Frequency (MHz)	Limit Range	Test Result
50	110	5180.000072	5150~5250	Pass
40	110	5179.981050	5150~5250	Pass
30	110	5180.014957	5150~5250	Pass
20	110	5179.999174	5150~5250	Pass
10	110	5180.019347	5150~5250	Pass
0	110	5179.980320	5150~5250	Pass
-10	110	5179.976214	5150~5250	Pass
-20	110	5180.017323	5150~5250	Pass

Operating Frequency: 5180 MHz				
Environment Temperature (°C)	Voltage (V)	Measured Frequency (MHz)	Limit Range	Test Result
20	99	5180.010624	5150~5250	Pass
	110	5180.014849	5150~5250	Pass
	121	5180.005514	5150~5250	Pass



CH Mid

Operating Frequency: 5220 MHz				
Environment Temperature (°C)	Voltage (V)	Measured Frequency (MHz)	Limit Range	Test Result
50	110	5220.006315	5150~5250	Pass
40	110	5219.990811	5150~5250	Pass
30	110	5219.996802	5150~5250	Pass
20	110	5220.012932	5150~5250	Pass
10	110	5220.020637	5150~5250	Pass
0	110	5219.991825	5150~5250	Pass
-10	110	5220.002753	5150~5250	Pass
-20	110	5219.994132	5150~5250	Pass

Operating Frequency: 5220 MHz				
Environment Temperature (°C)	Voltage (V)	Measured Frequency (MHz)	Limit Range	Test Result
20	99	5219.992709	5150~5250	Pass
	110	5219.977733	5150~5250	Pass
	121	5220.011265	5150~5250	Pass



CH High

Operating Frequency: 5240 MHz				
Environment Temperature (°C)	Voltage (V)	Measured Frequency (MHz)	Limit Range	Test Result
50	110	5239.989196	5150~5250	Pass
40	110	5240.003257	5150~5250	Pass
30	110	5239.975549	5150~5250	Pass
20	110	5240.019603	5150~5250	Pass
10	110	5239.998817	5150~5250	Pass
0	110	5239.975169	5150~5250	Pass
-10	110	5240.012373	5150~5250	Pass
-20	110	5239.996965	5150~5250	Pass

Operating Frequency: 5240 MHz				
Environment Temperature (°C)	Voltage (V)	Measured Frequency (MHz)	Limit Range	Test Result
20	99	5240.010854	5150~5250	Pass
	110	5239.999058	5150~5250	Pass
	121	5240.019521	5150~5250	Pass



IEEE 802.11n HT 40 mode / 5190 ~ 5230 MHz:

CH Low

Operating Frequency: 5190 MHz				
Environment Temperature (°C)	Voltage (V)	Measured Frequency (MHz)	Limit Range	Test Result
50	110	5190.017017	5150~5250	Pass
40	110	5189.998198	5150~5250	Pass
30	110	5189.995910	5150~5250	Pass
20	110	5190.002070	5150~5250	Pass
10	110	5189.990015	5150~5250	Pass
0	110	5189.984642	5150~5250	Pass
-10	110	5189.998189	5150~5250	Pass
-20	110	5189.971752	5150~5250	Pass

Operating Frequency: 5190 MHz				
Environment Temperature (°C)	Voltage (V)	Measured Frequency (MHz)	Limit Range	Test Result
20	99	5189.978226	5150~5250	Pass
	110	5189.971248	5150~5250	Pass
	121	5189.984508	5150~5250	Pass



CH High

Operating Frequency: 5230 MHz				
Environment Temperature (°C)	Voltage (V)	Measured Frequency (MHz)	Limit Range	Test Result
50	110	5229.979336	5150~5250	Pass
40	110	5230.000979	5150~5250	Pass
30	110	5229.979209	5150~5250	Pass
20	110	5230.014820	5150~5250	Pass
10	110	5229.986334	5150~5250	Pass
0	110	5229.997468	5150~5250	Pass
-10	110	5229.983901	5150~5250	Pass
-20	110	5229.978789	5150~5250	Pass

Operating Frequency: 5230 MHz				
Environment Temperature (°C)	Voltage (V)	Measured Frequency (MHz)	Limit Range	Test Result
20	99	5229.99699	5150~5250	Pass
	110	5230.012403	5150~5250	Pass
	121	5229.986062	5150~5250	Pass



IEEE 802.11n HT 80 mode / 5210 MHz:

Operating Frequency: 5210 MHz				
Environment Temperature (°C)	Voltage (V)	Measured Frequency (MHz)	Limit Range	Test Result
50	110	5210.012855	5150~5250	Pass
40	110	5209.976713	5150~5250	Pass
30	110	5210.012729	5150~5250	Pass
20	110	5210.011735	5150~5250	Pass
10	110	5209.996500	5150~5250	Pass
0	110	5210.017408	5150~5250	Pass
-10	110	5209.998413	5150~5250	Pass
-20	110	5210.019921	5150~5250	Pass

Operating Frequency: 5210 MHz				
Environment Temperature (°C)	Voltage (V)	Measured Frequency (MHz)	Limit Range	Test Result
20	99	5209.972598	5150~5250	Pass
	110	5209.997937	5150~5250	Pass
	121	5210.009257	5150~5250	Pass