

Dynamic Frequency Selection (DFS)

Test Report

Product Name	Long Range Wireless 5 x 2 HD Matrix Pro -Transmitter
Model No	GWHDMS52MB - T
FCC ID	QLEGWHDMS52MB

Applicant	ATEN Technology, Inc., dba IOGEAR
Address	19641 Da Vinci Foothill Ranch, CA 92610 United States

Date of Receipt	Feb. 13, 2014
Issued Date	Mar. 12, 2014
Report No.	1420159R-RFUSP06V00-A
Report Version	V1.0



The test results relate only to the samples tested.
 The test report shall not be reproduced except in full without the written approval of Quietek Corporation.
 This report must not be used to claim product endorsement by TAF any agency of the U.S. Government

DFS Test Report

Issued Date: Mar. 12, 2014

Report No.: 1420159R-RFUSP06V00-A



Product Name	Long Range Wireless 5 x 2 HD Matrix Pro -Transmitter
Applicant	ATEN Technology, Inc., dba IOGEAR
Address	19641 Da Vinci Foothill Ranch, CA 92610 United States
Manufacturer	ZINWELL CORPORATION
Model No.	GWHDMS52MB - T
FCC ID.	QLEGWHDMS52MB
EUT Rated Voltage	AC 100-240V, 50-60Hz
EUT Test Voltage	AC 120V/60Hz
Trade Name	IOGEAR / ATEN
Applicable Standard	FCC CFR Title 47 Part 15 Subpart E 15.407 (h): 2012 FCC 06-96
Test Result	Complied

The Test Results relate only to the samples tested.

The test report shall not be reproduced except in full without the written approval of Quietek Corporation.

This report must not be used to claim product endorsement by TAF any agency of the U.S. Government

Documented By : Genie Chang
(Senior Adm. Specialist / Genie Chang)

Tested By : Tom Hsieh
(Vice Supervisor / Tom Hsieh)

Approved By : [Signature]
(Director / Vincent Lin)

TABLE OF CONTENTS

Description	Page
1. GENERAL INFORMATION	4
1.1. Standard Requirement.....	6
1.2. EUT Description.....	4
1.3. UNII Device Description.....	6
1.4. Test Equipment.....	7
1.5. Test Setup.....	8
1.6. DFS Detection Thresholds.....	9
1.7. Radar Test Waveforms.....	10
1.8. Radar Waveform Calibration.....	14
1.9. Radar Waveform Calibration Result.....	15
1.10. Master Data Traffic Plot Result.....	17
2. IN-SERVICE MONITORING FOR CHANNEL MOVE TIME AND CHANNEL CLOSING	
TRANSMISSION TIME AND NON-OCCUPANCY PERIOD	18
2.1. Test Procedure.....	18
2.2. Test Requirement.....	18
2.3. Uncertainty.....	18
2.4. Test Result of Channel Move Time and Channel Closing Transmission Time and Non-Occupancy Period.....	19
3. DFS TEST SETUP PHOTO.....	29

Attachment 1: EUT Test Photographs

1. GENERAL INFORMATION

1.1. EUT Description

Product Name	Long Range Wireless 5 x 2 HD Matrix Pro -Transmitter
Trade Name	IOGEAR / ATEN
FCC ID.	QLEGWHDMS52MB
Model No.	GWHDMS52MB - T
Frequency Range	5190-5310MHz, 5510-5670MHz
Number of Channels	7CH
Channel Control	Auto
Type of Modulation	OFDM
Channel Bandwidth	40MHz
DFS Function	<input type="checkbox"/> Master <input checked="" type="checkbox"/> Slave
TPC Function	<input checked="" type="checkbox"/> <500mW not required <input type="checkbox"/> \geq 500mW employ a TPC
Communication Mode	<input type="checkbox"/> IP Based Systems <input type="checkbox"/> Frame Based System <input checked="" type="checkbox"/> *Other System
Antenna type	PIFA
Antenna Gain	Refer to the table "Antenna List"
IR Blaster Cable	Non-Shielded, 3.0m
USB to mini Cable	Shielded, 0.2m
YPbPr Adapter Cable	Shielded, 0.3m
HDMI Cable	Shielded, 1.5m
Power Adapter	MFR: SINO-AMERICAN, M/N: SA110C-05S-A Input: AC 100-240V, 50-60Hz, 0.3A Output: DC 5V, 2A, 10W Cable Out: Non-Shielded, 1.5m, with one ferrite core bonded.

*Note: The EUT is a Long Range Wireless 5 x 2 HD Matrix Pro -Transmitter with a built-in 5GHz transceiver.

Antenna List

Manufacturer	Model No.	Peak Gain
ZINWELL	N/A (2TX, 1RX)	2.1dBi for 5.150~5.250GHz 2.2dBi for 5.250~5.350GHz 2.6dBi for 5.470~5.725GHz

Center Working Frequency of Each Channel:

Channel	Frequency	Channel	Frequency	Channel	Frequency	Channel	Frequency
Channel 38:	5190 MHz	Channel 46:	5230 MHz	Channel 54:	5270 MHz	Channel 62:	5310 MHz
Channel 102:	5510 MHz	Channel 110:	5550 MHz	Channel 134:	5670 MHz		

Test Mode	Mode 1: Transmit
-----------	------------------

1.2. Standard Requirement

FCC Part 15.407:

U-NII devices operating in the 5.25-5.35 GHz band and the 5.47-5.725 GHz band shall employ a TPC mechanism. The U-NII device is required to have the capability to operate at least 6 dB below the mean EIRP value of 30dBm. A TPC mechanism is not required for systems with an E.I.R.P. of less than 500mW.

U-NII devices operating in the 5.25-5.35 GHz and 5.47-5.725 GHz bands shall employ a DFS radar detection mechanism to detect the presence of radar systems and to avoid co-channel operation with radar systems.

1.3. UNII Device Description

(1) The EUT operates in the following DFS band:

1. 5250-5350 MHz
2. 5470-5725 MHz

(2) The maximum EIRP of the 5GHz equipment is 20.71dBm.

(3) Below are the available 50 ohm antenna assemblies and their corresponding gains. 0dBi gain was used to set the -63 dBm threshold level (-64dBm +1 dB) during calibration of the test setup.

Manufacturer	Model No.	Peak Gain
ZINWELL	N/A (2TX, 1RX)	2.1dBi for 5.150~5.250GHz 2.2dBi for 5.250~5.350GHz 2.6dBi for 5.470~5.725GHz

(4) DFS operation description:

The EUT confronts the interference of radar signal during the period of transmitting the video signal, " Wireless 5 x 2 HD Matrix Receiver " will notify " Wireless 5 x 2 HD Matrix Transmitter " to stop transmitting the video signal.

(5) This device does not exceed 27dBm eirp, so no transmit power control is implemented.

(6) The master device is a "Wireless 5 x 2 HD Matrix Receiver". The "Wireless 5 x 2 HD Matrix Receiver " FCC ID: YG7ZRF32200

1.4. Test Equipment

Dynamic Frequency Selection (DFS) / CTR

Instrument	Manufacturer	Type No.	Serial No	Cal. Date
Spectrum Analyzer	Agilent	E4440A	MY46185846	Oct, 21, 2013
Vector Signal Generator	Agilent	E4438C	MY49070137	July, 10, 2013

Instrument	Manufacturer	Type No.	Serial No
Notebook Pc	Hp	HSTNN-155C	CNU8476RVZ
DVD Player	Sony	BDP-S470	3201179
8-WAY Power Divider	JFW	50PD-647-SMA	526770 0916
8-WAY Power Divider	JFW	50PD-647-SMA	526771 0916
RF Cable	SUHNER	SUCOFLEX 104	309180/4
RF Cable	SUHNER	SUCOFLEX 106	3474516
RF Cable (Qty: 10)	GORE	C86	N/A
LCD Monitor	Dell	2409Wb	CN-0W570D-74 261-89C-2AUU
Full HD Video Wireless Receiver	ZINWELL	ZWD-xy22R (x can be 0~9 , y can be 0~9), 27771,AR1875R	N/A

Software	Manufacturer	Function
Agilent Signal Studio for Pulse Building V1.3.13.0	Agilent	Radar Signal Generation Software
Agilent DFS_TEST V1.0.0.73	Agilent	Radar Signal Generation Software

1.5. Test Setup

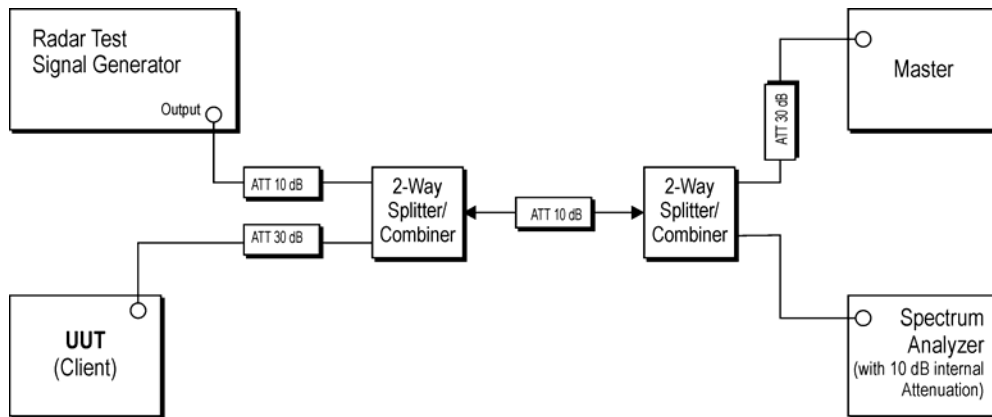

1.6. DFS Requirements Prior to Use of a Channel

Requirement	Operational Mode		
	Master	Client Without Radar Detection	Client With Radar Detection
<i>Non-Occupancy Period</i>	Yes	Not required	Yes
<i>DFS Detection Threshold</i>	Yes	Not required	Yes
<i>Channel Availability Check Time</i>	Yes	Not required	Not required
<i>Uniform Spreading</i>	Yes	Not required	Not required
<i>U-NII Detection Bandwidth</i>	Yes	Not required	Yes

1.7. DFS requirements during normal operation

Requirement	Operational Mode		
	Master	Client Without Radar Detection	Client With Radar Detection
<i>DFS Detection Threshold</i>	Yes	Not required	Yes
<i>Channel Closing Transmission Time</i>	Yes	Yes	Yes
<i>Channel Move Time</i>	Yes	Yes	Yes
<i>U-NII Detection Bandwidth</i>	Yes	Not required	Yes

1.8. DFS Detection Thresholds

(1) Interference Threshold value, Master or Client incorporating In-Service Monitoring

Maximum Transmit Power	Value (see note)
≥ 200 milliwatt	-64 dBm
< 200 milliwatt	-62 dBm

Note 1:
This is the level at the input of the receiver assuming a 0 dBi receive antenna.

Note 2:
Throughout these test procedures an additional 1 dB has been added to the amplitude of the test transmission waveforms to account for variations in measurement equipment. This will ensure that the test signal is at or above the detection threshold level to trigger a DFS response.

(2) DFS Response requirement values

Parameter	Value
Non-Occupancy Period	30 Minutes
Channel Availability Check Time	60 Seconds
Channel Move Time	10 Seconds
Channel Closing Transmission Time	200 milliseconds + approx. 60 milliseconds over remaining 10 seconds period (See Notes 1 and 2)
U-NII Detection Bandwidth	Minimum 80% of the 99% power bandwidth See Note 3.
<p>Note 1:</p> <p>The instant that the Channel Move Time and the Channel Closing Transmission Time begins is as follows:</p> <ul style="list-style-type: none"> •For the short pulse radar test signals this instant is the end of the burst. •For the frequency hopping radar test signal, this instant is the end of the last radar burst generated •For the long pulse radar test signal this instant is the end of the 12 seconds period defining the radar transmission. <p>Note 2:</p> <p>The channel closing transmission time is comprised of 200 milliseconds starting at the beginning of the channel move time plus any additional intermittent control signals required facilitating channel changes (an aggregate of approximately 60 milliseconds) during the remainder of the 10 seconds period. The aggregate duration of control signals will not count quiet periods in between transmissions.</p> <p>Note 3:</p> <p>During the <i>U-NII Detection Bandwidth</i> detection test, radar type 1 is used and for each frequency step the minimum percentage of detection is 90%. Measurements are performed with no data traffic.</p>	

1.9. Radar Test Waveforms

This section provides the parameters for required test waveforms, minimum percentage of successful detections, and the minimum number of trials that must be used for determining DFS conformance. Step intervals of 0.1 microsecond for Pulse Width, 1 microsecond for PRI, 1 MHz for chirp width and 1 for the number of pulses will be utilized for the random determination of specific test waveforms.

(1) Short Pulse Radar Test Waveforms

Radar Type	Pulse Width (usec)	PRI (usec)	Pulses	Minimum Percentage of Successful Detection	Minimum Trials
1	1	1428	18	60%	30
2	1-5	150-230	23-29	60%	30
3	6-10	200-500	16-18	60%	30
4	11-20	200-500	12-16	60%	30
Aggregate (radar types 1-4)				80%	120

A minimum of 30 unique waveforms is required for each of the short pulse radar type 2 through 4. For short pulse radar type 1, then same waveform is used a minimum of 30 times. If more than 30 waveforms are used for short pulse radar type 2 through 4, then each additional waveform must also be unique and not repeated from the previous waveforms. The aggregate is the average of the percentage of successful detections of short pulse radar type 1-4.

(2) Long Pulse Radar Test Signal

Radar Waveform	Bursts	Pulses Per Burst	Pulse Width (usec)	Chirp Width (MHz)	PRI (usec)	Minimum Percentage of Successful Detection	Minimum Trials
5	8-20	1-3	50-100	5-20	1000-2000	80%	30

The parameters for this waveform are randomly chosen. Thirty unique waveforms are required for the long pulse radar test signal. If more than 30 waveforms are used for the long pulse radar test signal, then each additional waveform must also be unique and not repeated from the previous waveforms.

Each waveform is defined as follows:

- 1) The transmission period for the Long Pulse Radar test signal is 12 seconds.
- 2) There are a total of 8 to 20 Bursts in the 12 second period, with the number of Bursts being randomly chosen. This number is Burst Count.
- 3) Each Burst consists of 1 to 3 pulses, with the number of pulses being randomly chosen. Each Burst within the 12 second sequence may have a different number of pulses.
- 4) The pulse width is between 50 and 100 microseconds, with the pulse width being randomly chosen. Each pulse within a Burst will have the same pulse width. Pulses in different Bursts may have different pulse widths.
- 5) Each pulse has a linear FM chirp between 5 and 20 MHz, with the chirp width being randomly chosen. Each pulse within a Burst will have the same chirp width. Pulses in different Bursts may have different chirp widths. The chirp is centered on the pulse. For example, with radar frequency of 5310 MHz and a 20 MHz chirped signal, the chirp starts at 5300 MHz and ends at 5320 MHz.
- 6) If more than one pulse is present in a Burst, the time between the pulses will be between 1000 and 2000 microseconds, with the time being randomly chosen. If three pulses are present in a Burst, the time between the first and second pulses is chosen independently of the time between the second and third pulses.
- 7) The 12 second transmission period is divided into even intervals. The number of intervals is equal to Burst_Count. Each interval is of length $(12,000,000 / \text{Burst_Count})$ microseconds. Each interval contains one Burst. The start time for the Burst, relative to the beginning of the interval, is between 1 and $[(12,000,000 / \text{Burst_Count}) - (\text{Total Burst Length}) + (\text{One Random PRI Interval})]$ microseconds, with the start time being randomly chosen. The step interval for the start time is 1 microsecond. The start time for each Burst is chosen independently.

A representative example of a Long Pulse radar test waveform:

- 1) The total test signal length is 12 seconds.
- 2) 8 Bursts are randomly generated for the Burst Count.
- 3) Burst 1 has 2 randomly generated pulses.
- 4) The pulse width (for both pulses) is randomly selected to be 75 microseconds.
- 5) The PRI is randomly selected to be at 1213 microseconds.
- 6) Bursts 2 through 8 are generated using steps 3 – 5.
- 7) Each Burst is contained in even intervals of 1,500,000 microseconds. The starting location for Pulse 1, Burst 1 is randomly generated (1 to 1,500,000 minus the total Burst 1 length + 1 random PRI interval) at the 325,001 microsecond step. Bursts 2 through 8 randomly fall in successive 1,500,000 microsecond intervals (i.e. Burst 2 falls in the 1,500,001 – 3,000,000 microsecond range).

Graphical Representation of a Long Pulse radar Test Waveform

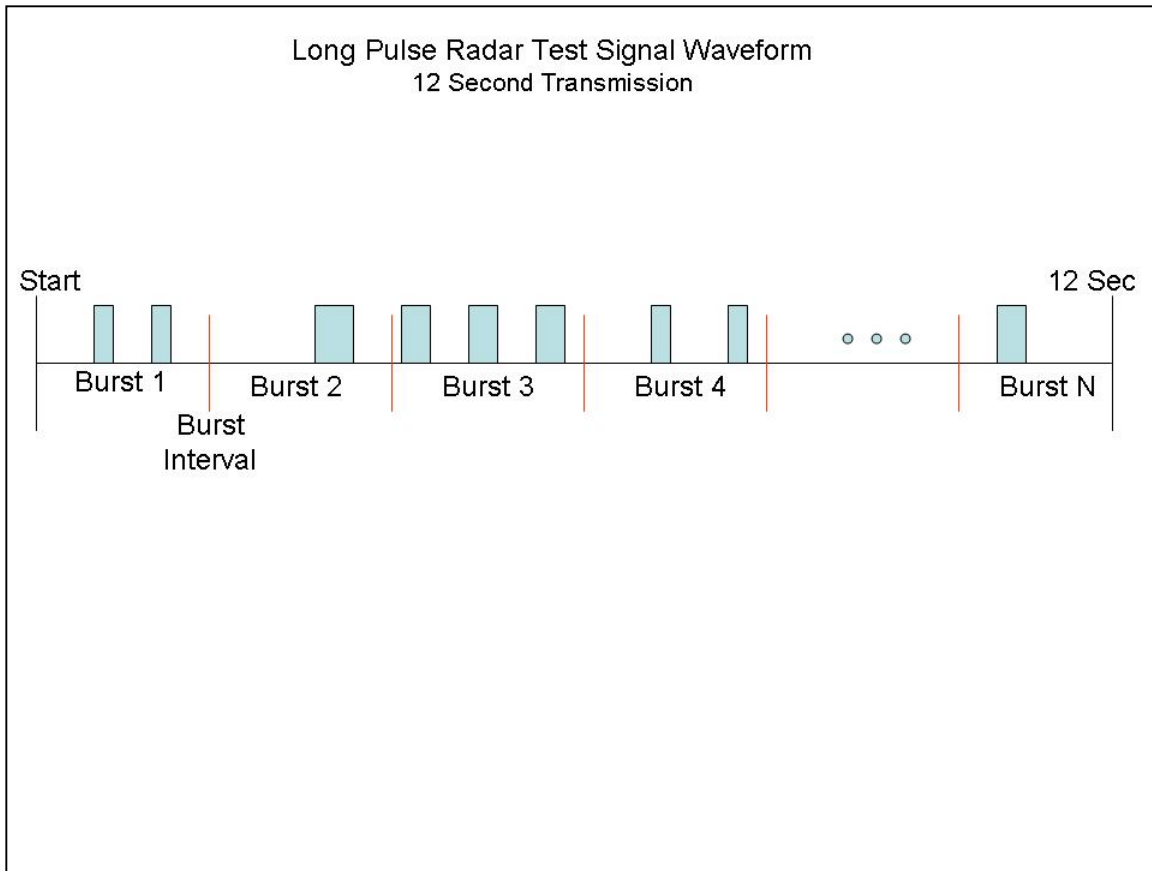

(3) Frequency Hopping Radar Test Signal

Radars Waveform	Pulse Width (μsec)	PRI (μsec)	Hopping Sequence Length (msec)	Pulses Per Hop	Hopping Rate (kHz)	Minimum Percentage of Successful Detection	Minimum Trials
6	1	333	300	9	0.333	70%	30

For the Frequency Hopping Radar Type, the same *Burst* parameters are used for each waveform. The hopping sequence is different for each waveform and a 100-length segment is selected from the hopping sequence defined by the following algorithm:

The first frequency in a hopping sequence is selected randomly from the group of 475 integer frequencies from 5250 – 5724 MHz. Next, the frequency that was just chosen is removed from the group and a frequency is randomly selected from the remaining 474 frequencies in the group. This process continues until all 475 frequencies are chosen for the set. For selection of a random frequency, the frequencies remaining within the group are always treated as equally likely.

1.10. Radar Waveform Calibration

The following equipment setup was used to calibrate the conducted radar waveform. A spectrum analyzer was used to establish the test signal level for each radar type. During this process there were replace 50ohm terminal from master and client device and no transmissions by either the master or client device. The spectrum analyzer was switched to the zero span (time domain) at the frequency of the radar waveform generator. Peak detection was utilized. The spectrum analyzer resolution bandwidth (RBW) and video bandwidth (VBW) were set to 3MHz and 3 MHz.

The signal generator amplitude was set so that the power level measured at the spectrum analyzer was -63 $(-64+1)$ dBm due to the interference threshold level is not required.

Conducted Calibration Setup

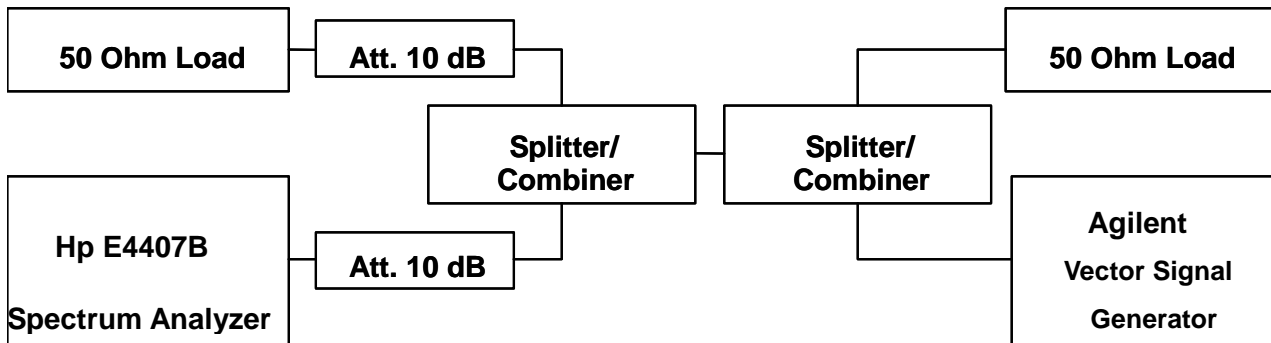

1.11. Radar Waveform Calibration Result

Radar Type 1 Calibration Plot (5310MHz)

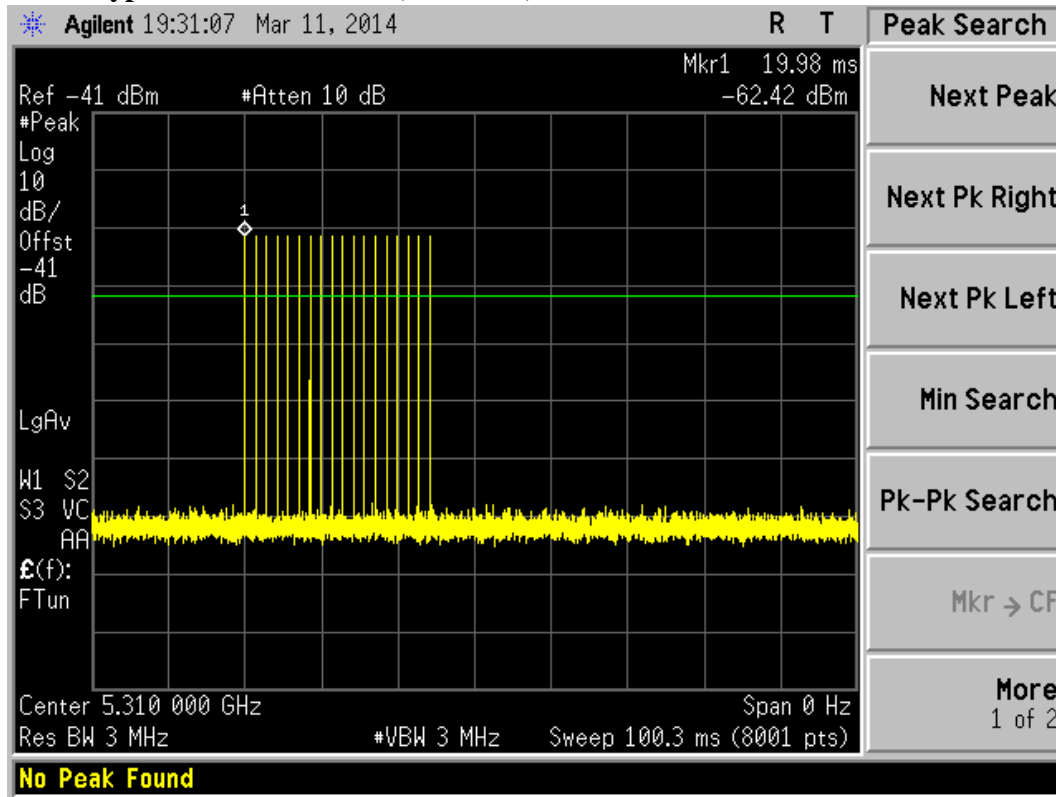

Radar Type 1 Calibration Plot (5510MHz)

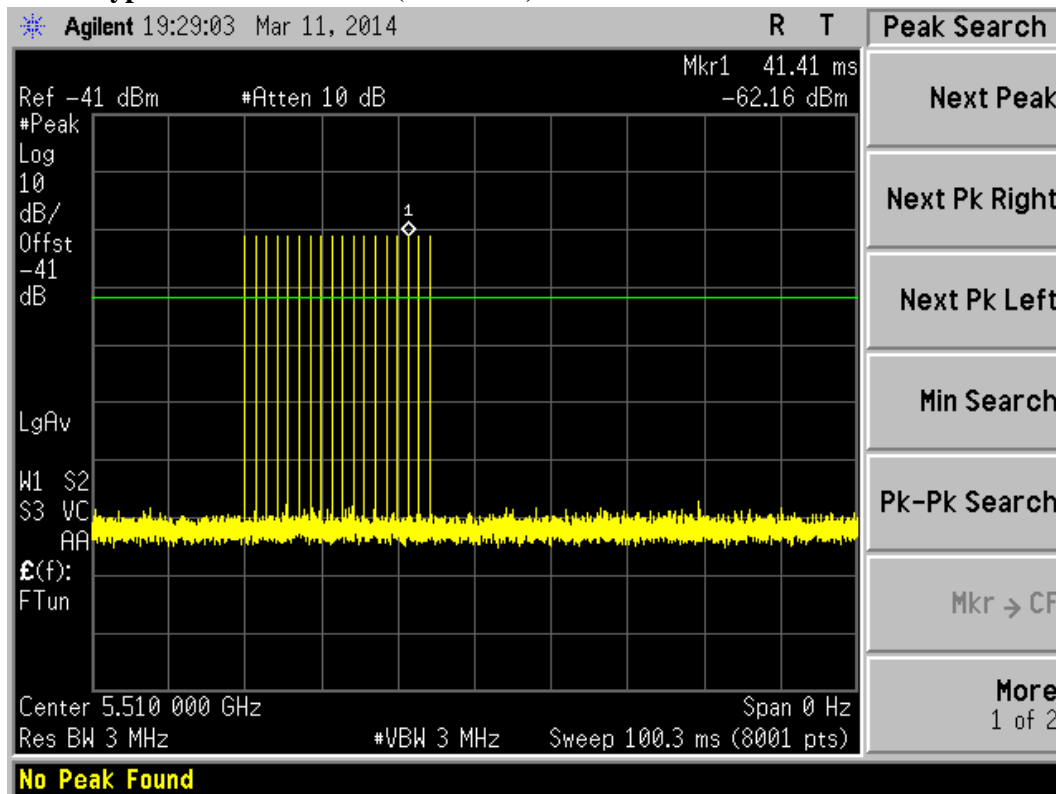

Radar Type 5 Calibration Plot (5310MHz)

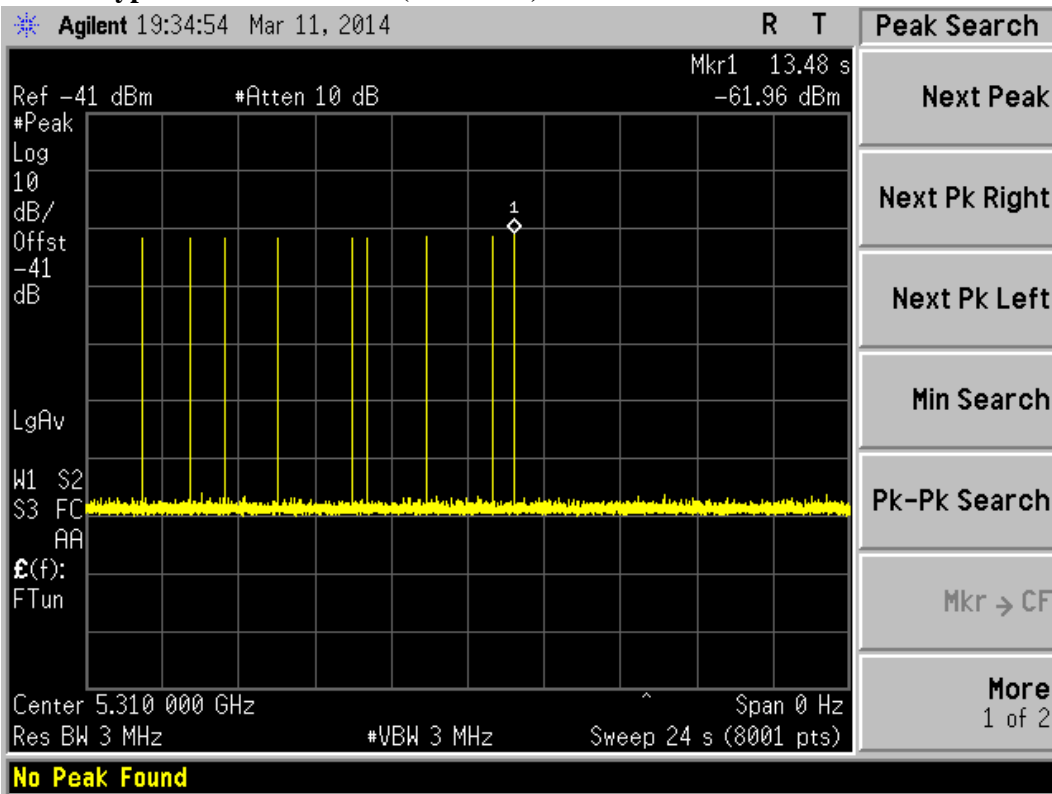

Radar Type 5 Calibration Plot (5510MHz)

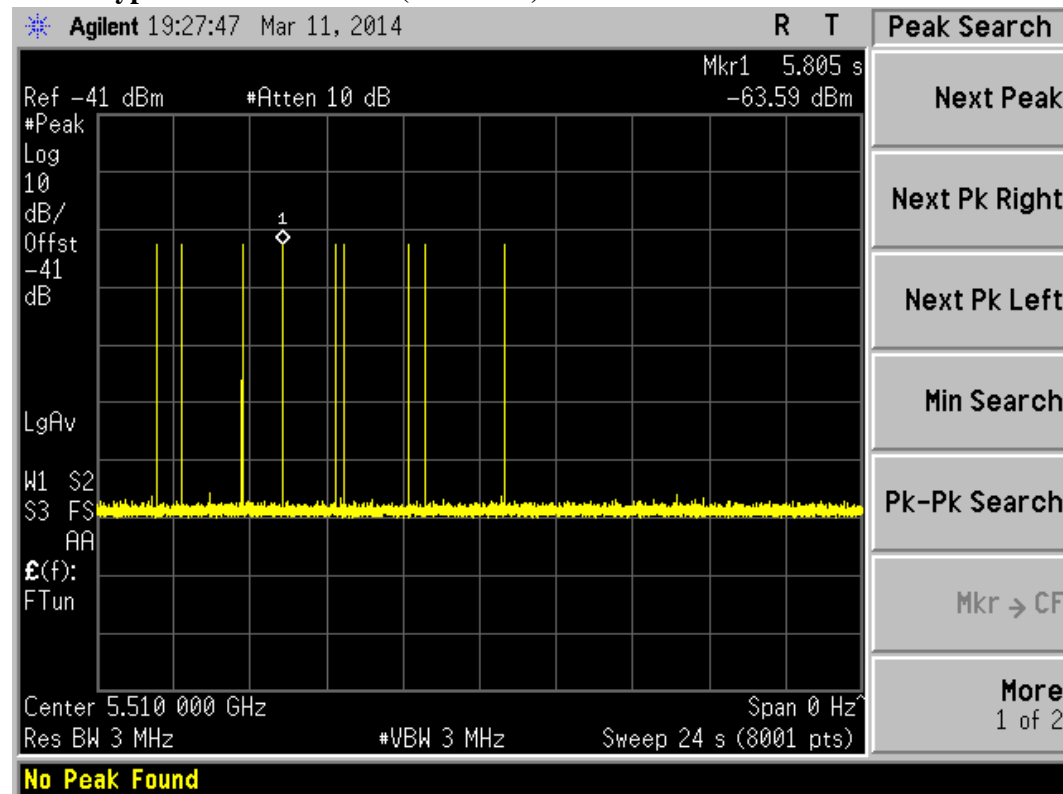

1.12. Master Data Traffic Plot Result

Plot of Master Traffic at 5310MHz

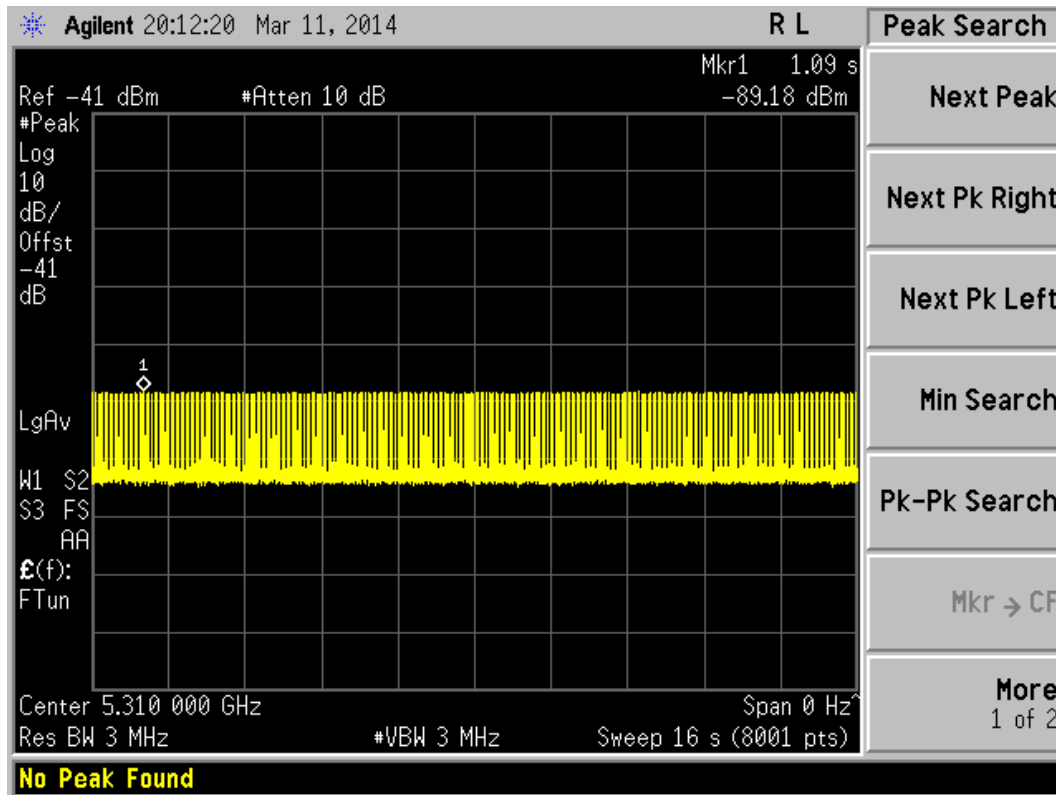

Plot of Master Traffic at 5510MHz

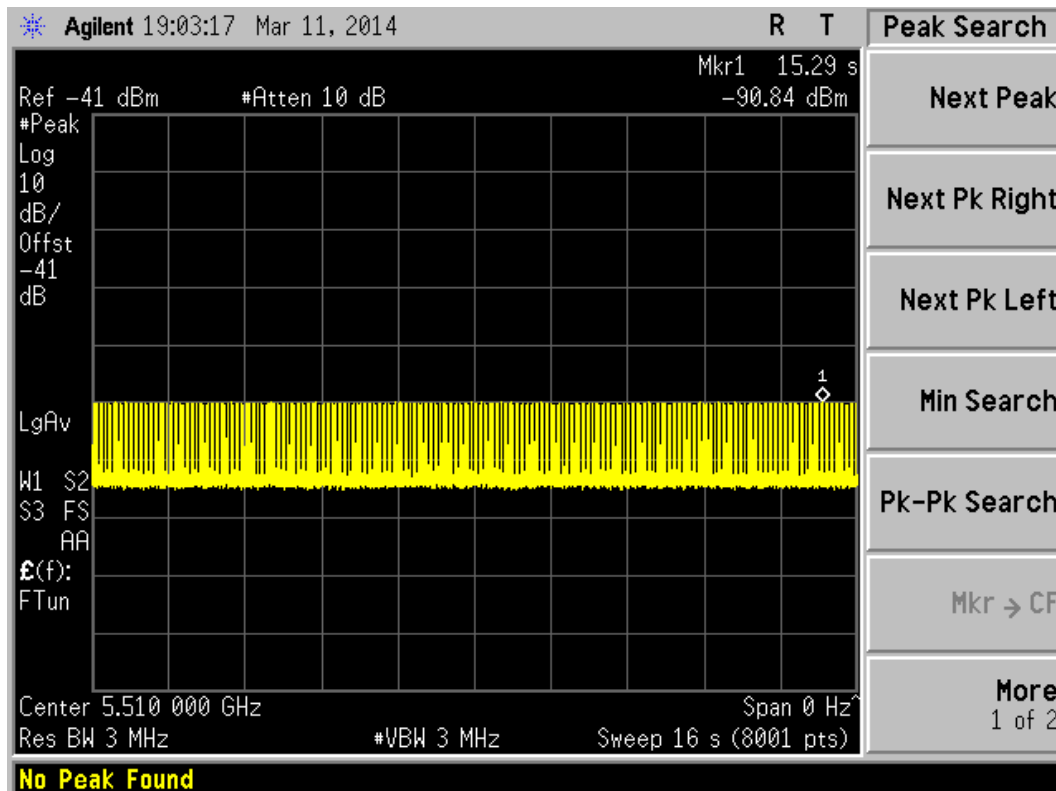

2. In-Service Monitoring for Channel Move Time and Channel Closing Transmission Time and Non-Occupancy Period

2.1. Test Procedure

These tests define how the following DFS parameters are verified during In-Service Monitoring;

Channel Closing Transmission Time, Channel Move Time, and Non-Occupancy Period.. The steps below define the procedure to determine the above mentioned parameters when a radar Burst with a level equal to the DFS Detection Threshold + 1dB (-63dBm) is generated on the Operating Channel of the U-NII device.

A U-NII device operating as a Master Device will associate with the UUT (Client) at 5310 MHz and 5510MHz.

Stream the MPEG test file from the Client (TX) Device to the Master (RX) Device on the selected Channel for the entire period of the test.

At time T0 the Radar Waveform generator sends a Burst of pulses for each of the radar types at -63dBm.

Observe the transmissions of the UUT at the end of the radar Burst on the Operating Channel for duration greater than 10 seconds. Measure and record the transmissions from the UUT during the observation time (Channel Move Time). Compare the Channel Move Time and Channel Closing

Transmission Time results to the limits defined in the DFS Response requirement values table.

Measure the UUT for more than 30 minutes following the channel close/move time to verify that the UUT does not resume any transmissions on this Channel.

2.2. Test Requirement

Parameter	Value
Channel Move Time	10 Seconds
Channel Closing Transmission Time	200 milliseconds + approx. 60 milliseconds over remaining 10 seconds period
Non-Occupancy Period	Minimum 30 minutes

2.3. Uncertainty

± 1ms.

2.4. Test Result of Channel Move Time and Channel Closing Transmission Time and Non-Occupancy Period

Product : Long Range Wireless 5 x 2 HD Matrix Pro -Transmitter
 Test Item : Channel Move Time Test
 Radar Type : Type 1
 Test Mode : Mode 1: Transmit

Channel Move Time for Radar Test Type 1 at 5310MHz

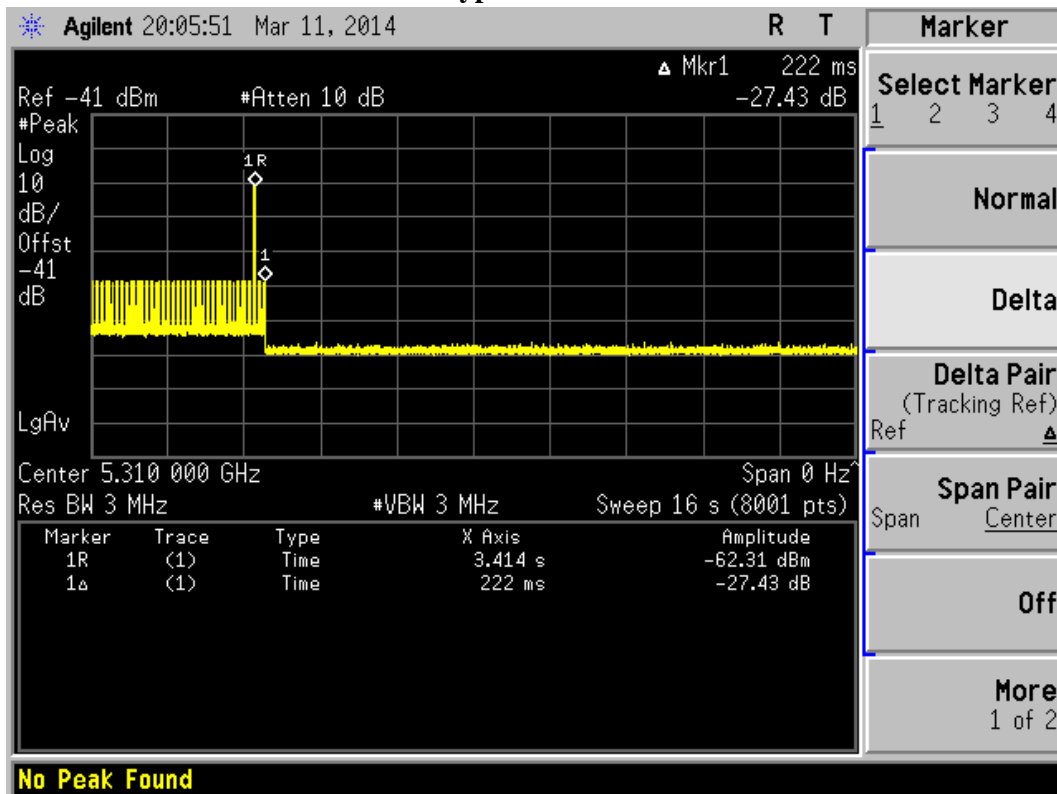

Test Item	Test Result (Sec)	Limit (Sec)
Channel Move Time	0.222	10

The results showed that after radar signal injected the channel move time was less than 10 seconds.

Channel Move Time for Radar Test Type 1 at 5510MHz

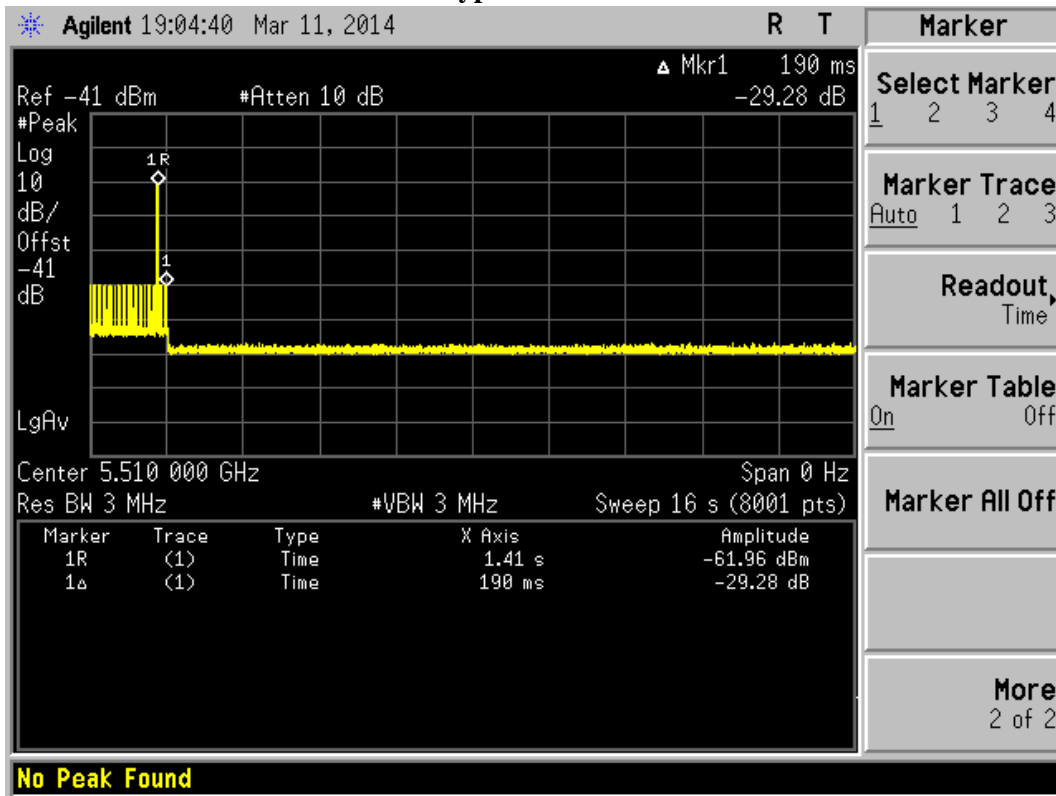

Test Item	Test Result (Sec)	Limit (Sec)
Channel Move Time	0.190	10

The results showed that after radar signal injected the channel move time was less than 10 seconds.

Product : Long Range Wireless 5 x 2 HD Matrix Pro -Transmitter
 Test Item : Channel Move Time Test
 Radar Type : Type 5
 Test Mode : Mode 1: Transmit

Channel Move Time for Radar Test Type 5 at 5310MHz

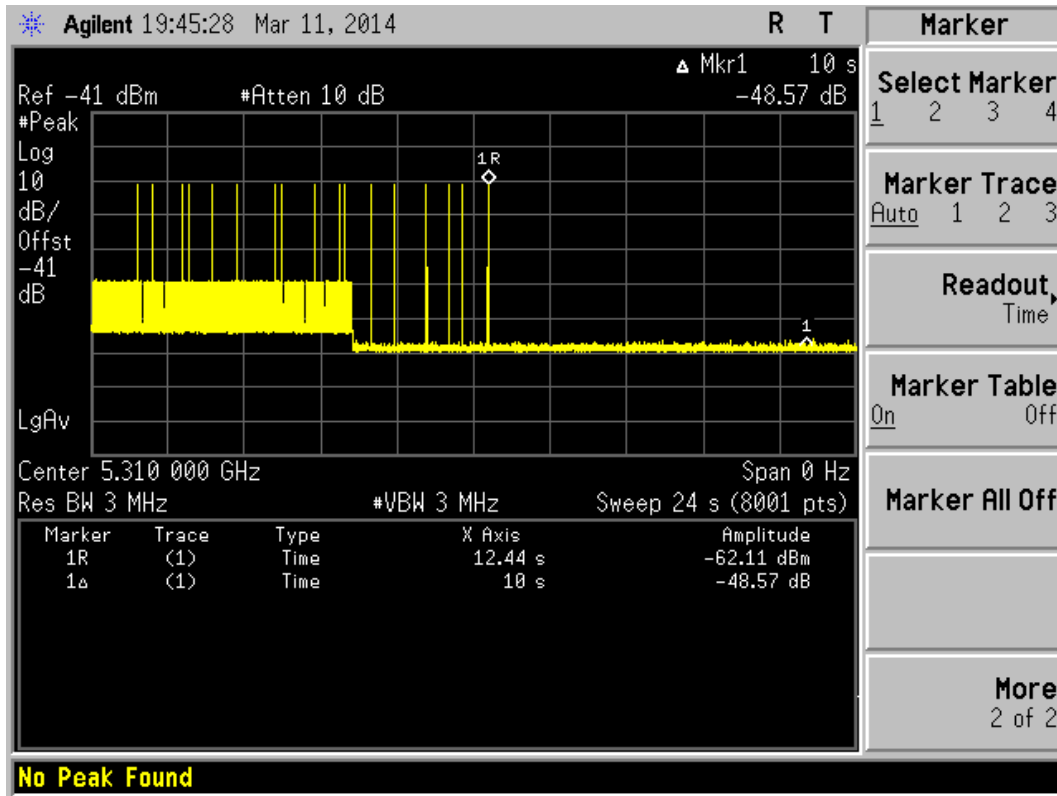

Test Item	Test Result (Sec)	Limit (Sec)
Channel Move Time	0	10

The results showed that after radar signal injected the channel move time was less than 10 seconds.

Channel Move Time for Radar Test Type 5 at 5510MHz

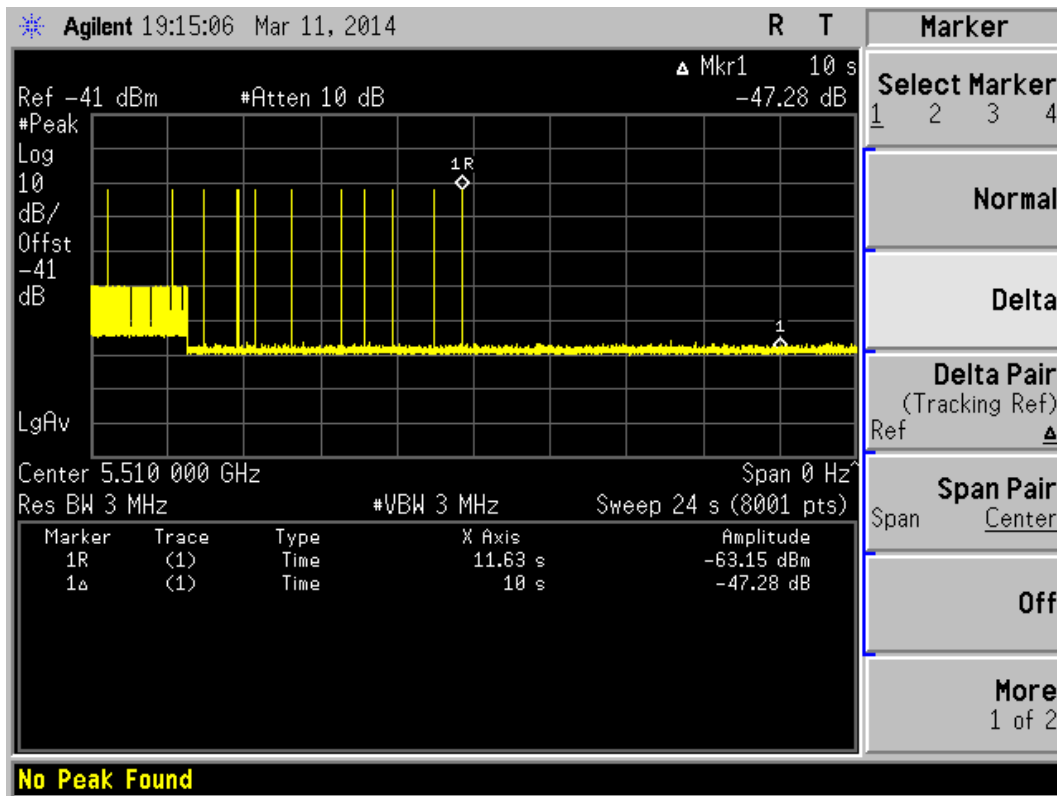

Test Item	Test Result (Sec)	Limit (Sec)
Channel Move Time	0	10

The results showed that after radar signal injected the channel move time was less than 10 seconds.

Product : Long Range Wireless 5 x 2 HD Matrix Pro -Transmitter
 Test Item : Channel Closing Transmission Time Test
 Radar Type : Type 1
 Test Mode : Mode 1: Transmit

Channel Closing Transmission Time for Radar Test Type 1 at 5310 MHz

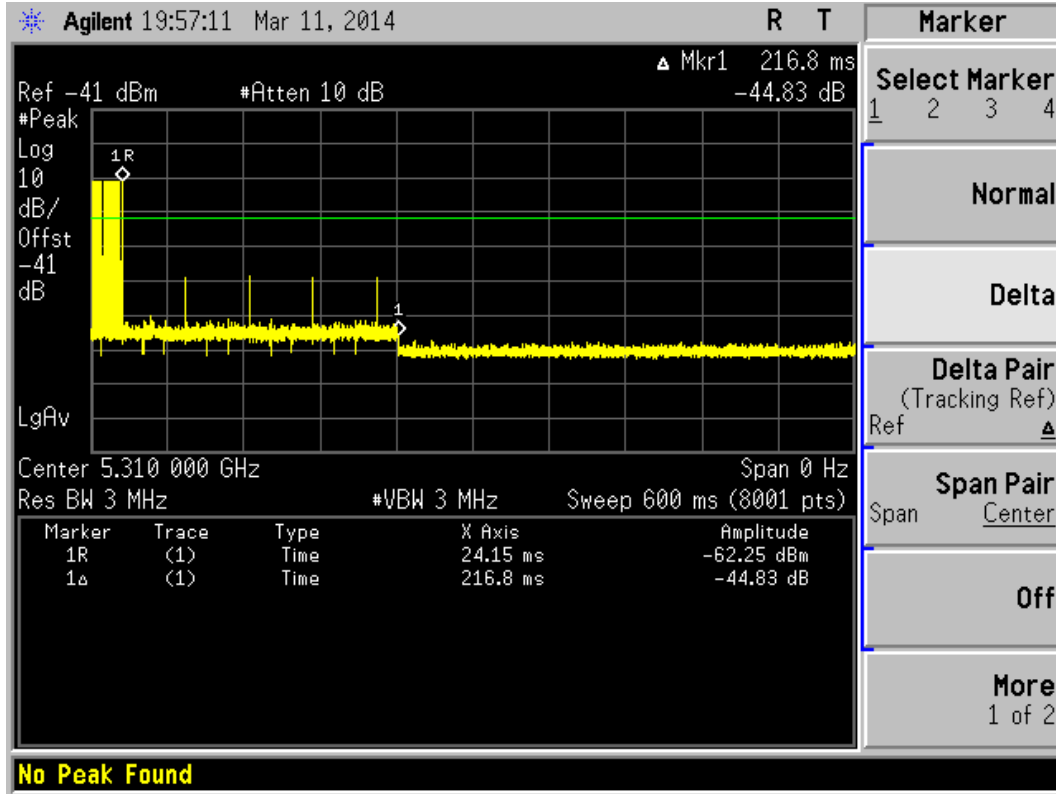

Test Item	Test Result (ms)	Limit (ms)
Channel Closing Transmission	16.8	200 milliseconds + approx. 60 milliseconds over remaining 10 seconds period

*Note: The results showed that after radar signal injected the channel transmission closing time less than 200 milliseconds and an aggregate of no more than 60 milliseconds.

Channel Closing Transmission Time for Radar Test Type 1 at 5510 MHz

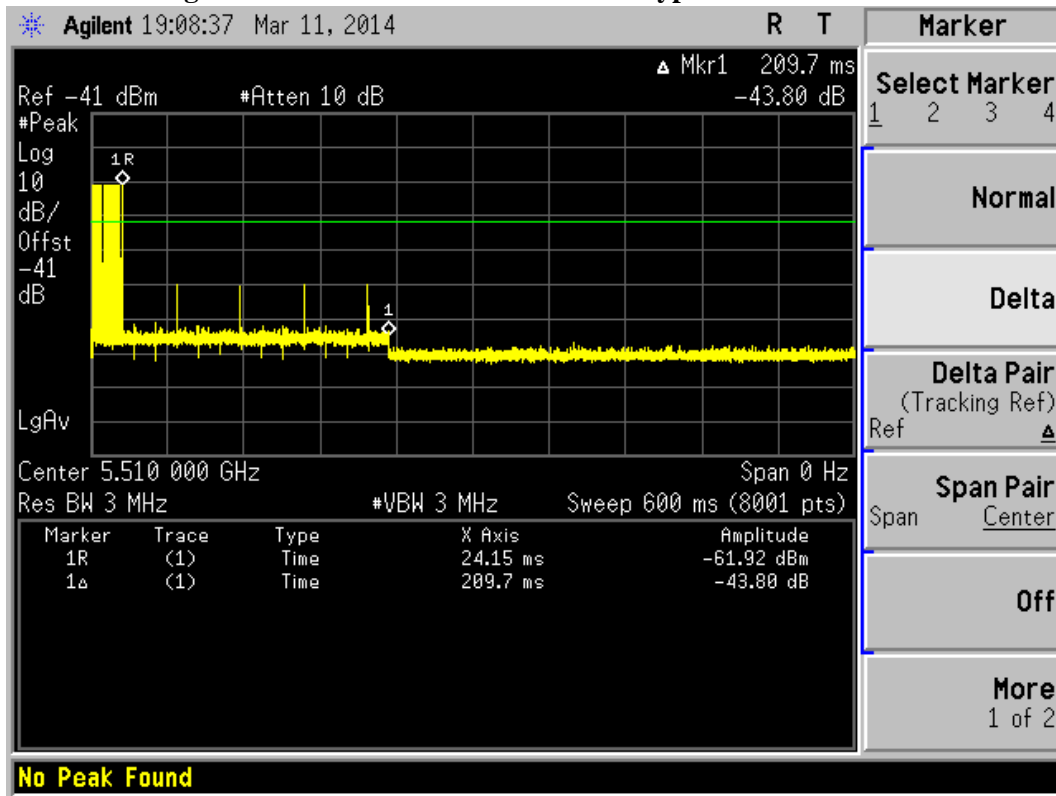

Test Item	Test Result (ms)	Limit (ms)
Channel Closing Transmission	9.7	200 milliseconds + approx. 60 milliseconds over remaining 10 seconds period

*Note: The results showed that after radar signal injected the channel transmission closing time less than 200 milliseconds and an aggregate of no more than 60 milliseconds.

Product : Long Range Wireless 5 x 2 HD Matrix Pro -Transmitter
 Test Item : Channel Closing Transmission Time Test
 Radar Type : Type 5
 Test Mode : Mode 1: Transmit

Channel Closing Transmission Time for Radar Test Type 5 at 5310 MHz

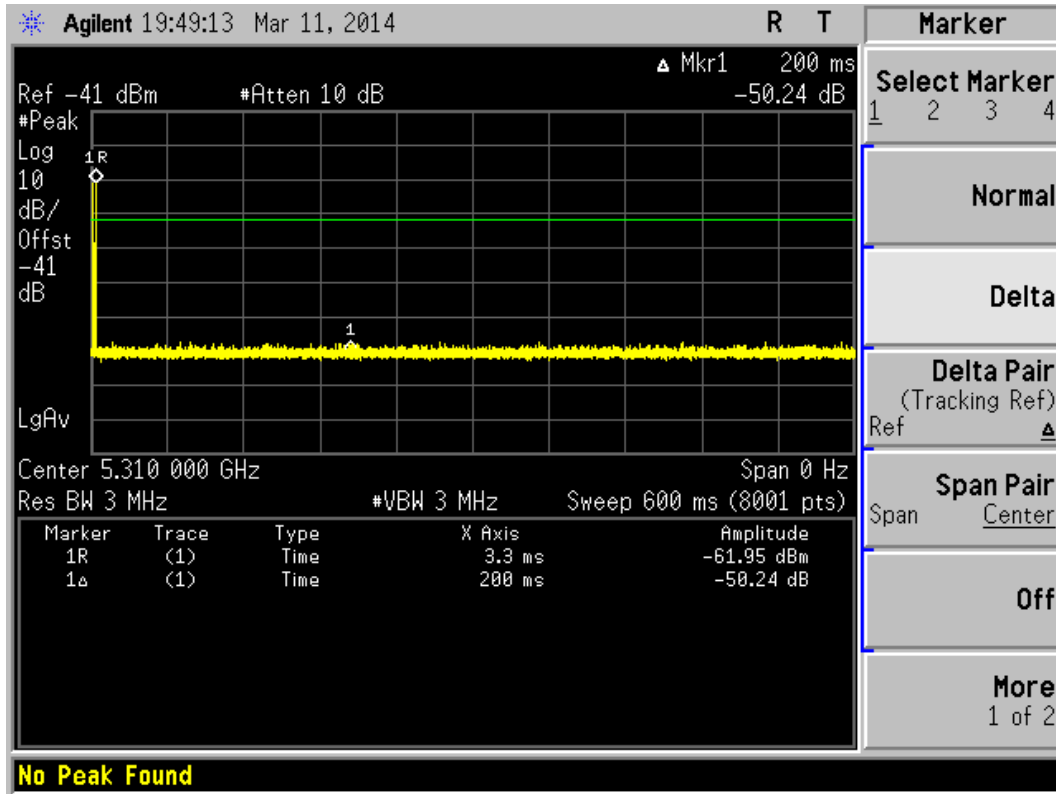

Test Item	Test Result (ms)	Limit (ms)
Channel Closing Transmission	*0	200 milliseconds + approx. 60 milliseconds over remaining 10 seconds period

*Note: The test result is “bin number X time per bin (600 ms / 8000)”

The results showed that after radar signal injected the channel transmission closing time less than 200 milliseconds and an aggregate of no more than 60 milliseconds.

Channel Closing Transmission Time for Radar Test Type 5 at 5510 MHz

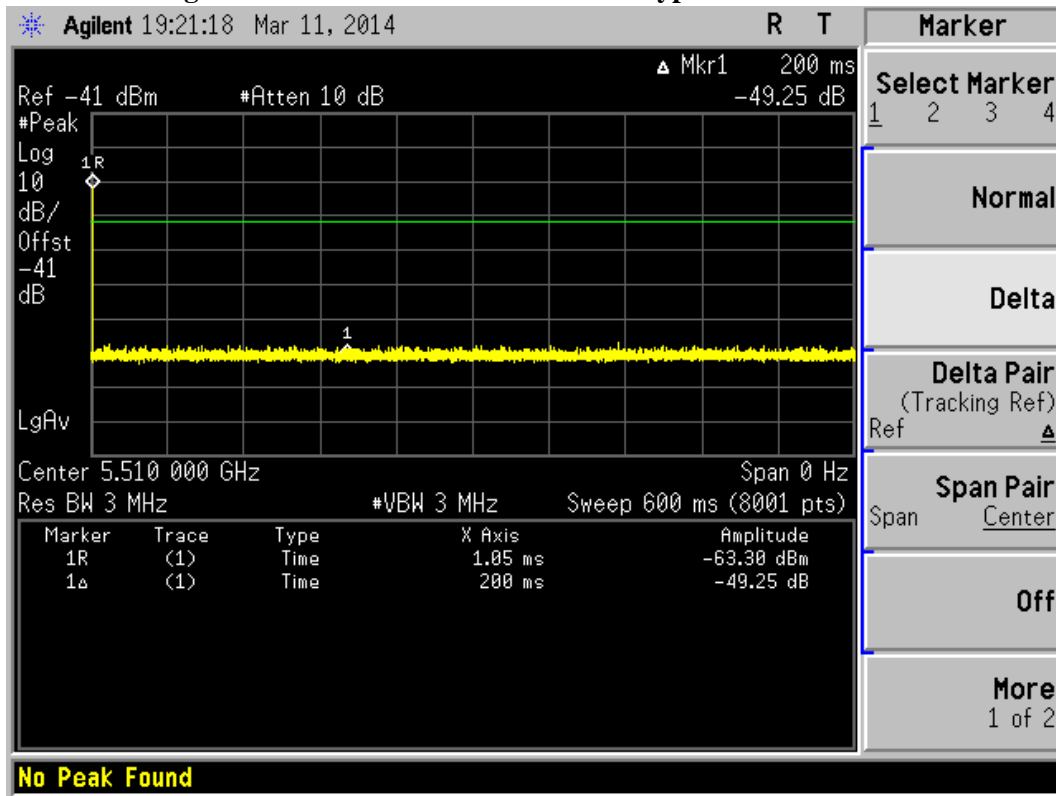

Test Item	Test Result (ms)	Limit (ms)
Channel Closing Transmission	*0	200 milliseconds + approx. 60 milliseconds over remaining 10 seconds period

*Note: The test result is “bin number X time per bin (600 ms / 8000)”

The results showed that after radar signal injected the channel transmission closing time less than 200 milliseconds and an aggregate of no more than 60 milliseconds.

Product : Long Range Wireless 5 x 2 HD Matrix Pro -Transmitter
 Test Item : Non-Occupancy Period
 Radar Type : Type 1
 Test Mode : Mode 1: Transmit

Non-Occupancy Period at 5310 MHz

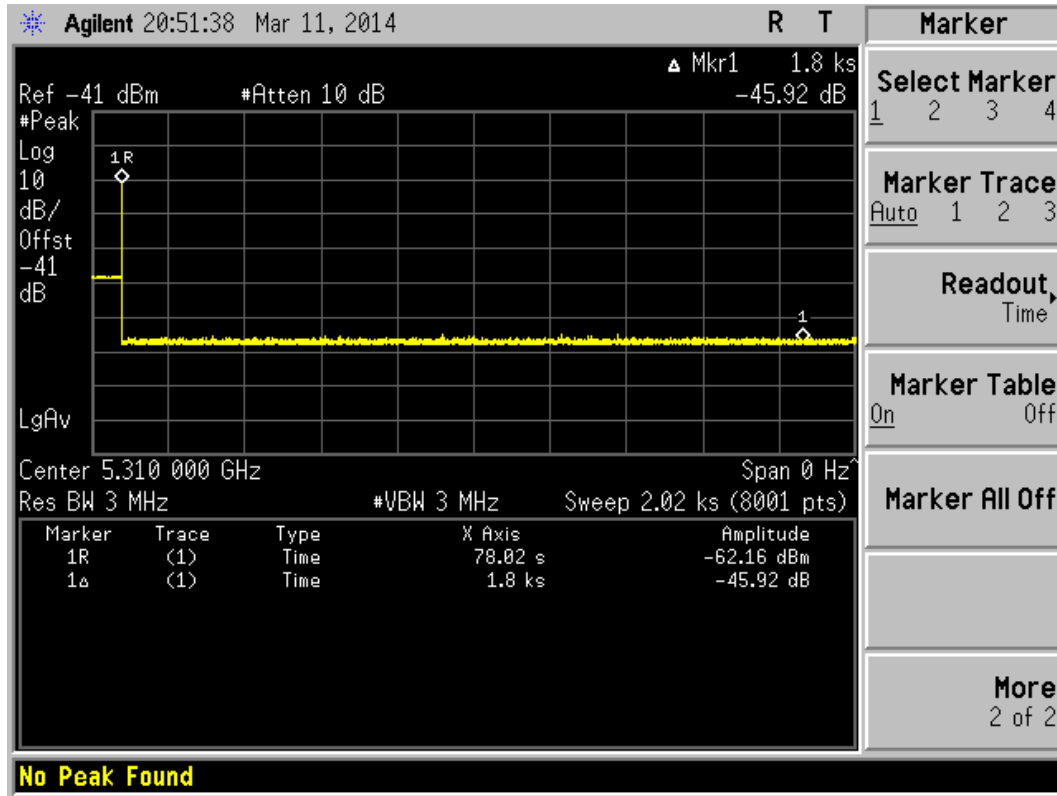

Test Item	Test Result (Minutes)	Limit (Minutes)
Non-Occupancy Period	>30	≥ 30

No EUT transmissions were observed on the test channel during 30 minutes observation time.

Non-Occupancy Period at 5510 MHz

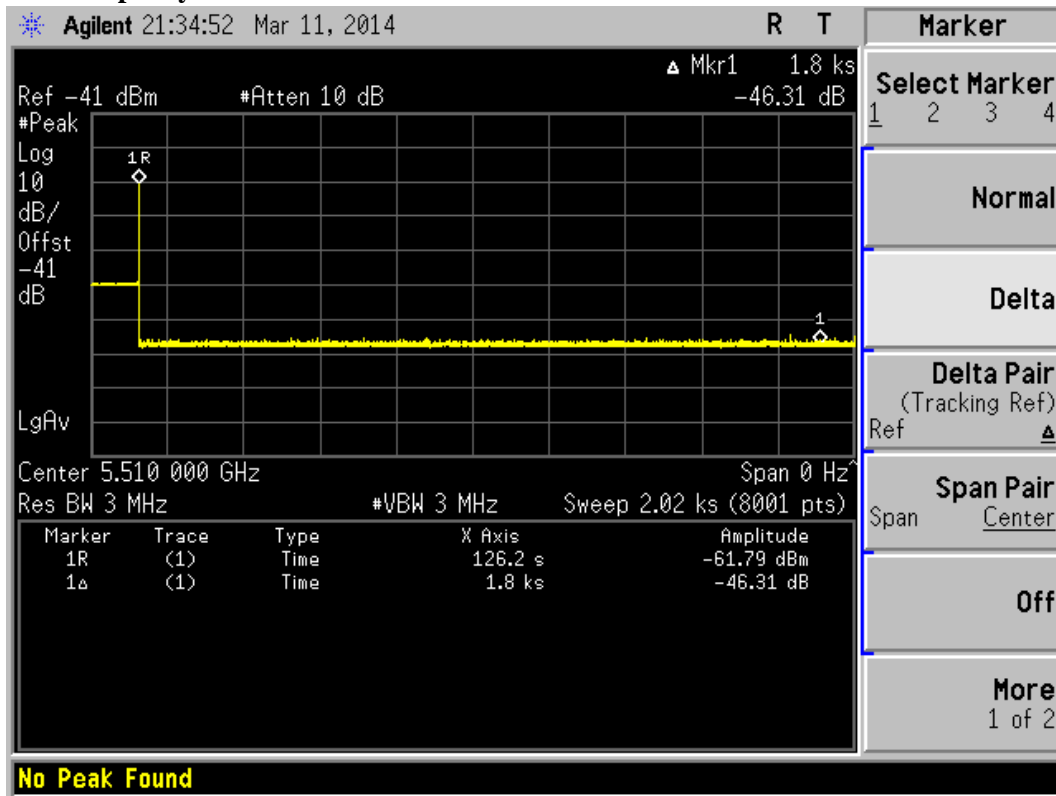

Test Item	Test Result (Minutes)	Limit (Minutes)
Non-Occupancy Period	>30	\geq 30

No EUT transmissions were observed on the test channel during 30 minutes observation time.

3. DFS Test Setup Photo

Full DFS Test Setup Photo

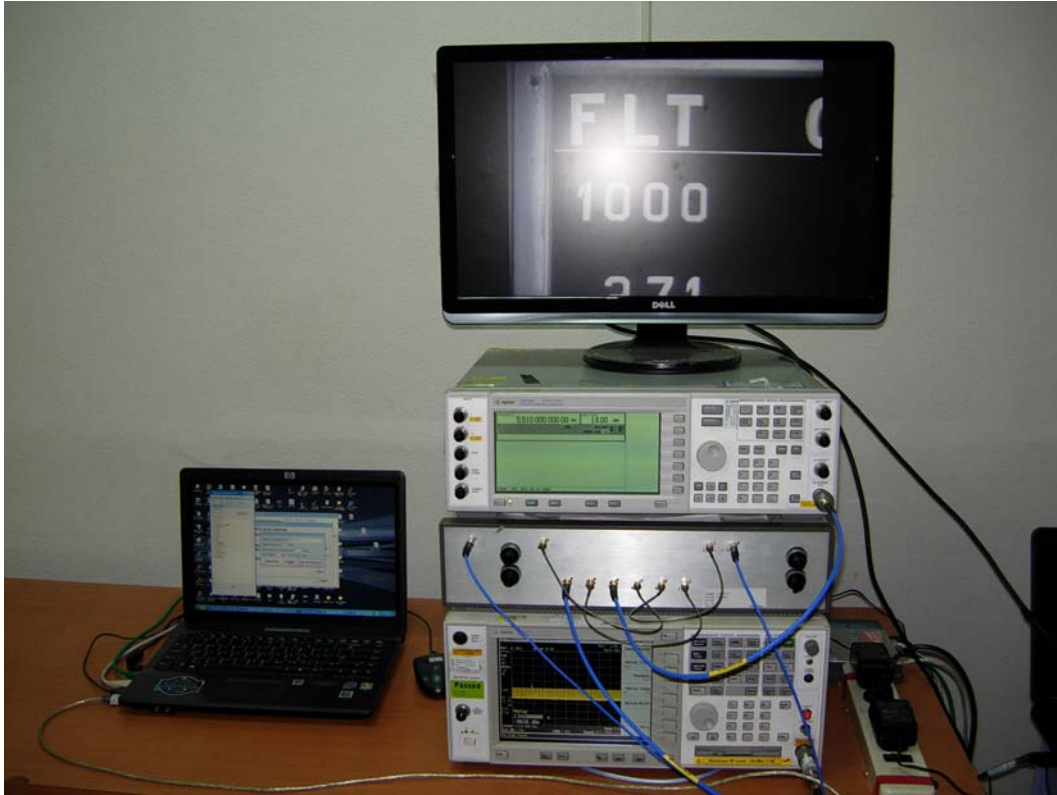

DFS Set-up Photo: Spectrum Analyzer, EUT and Radar Generator

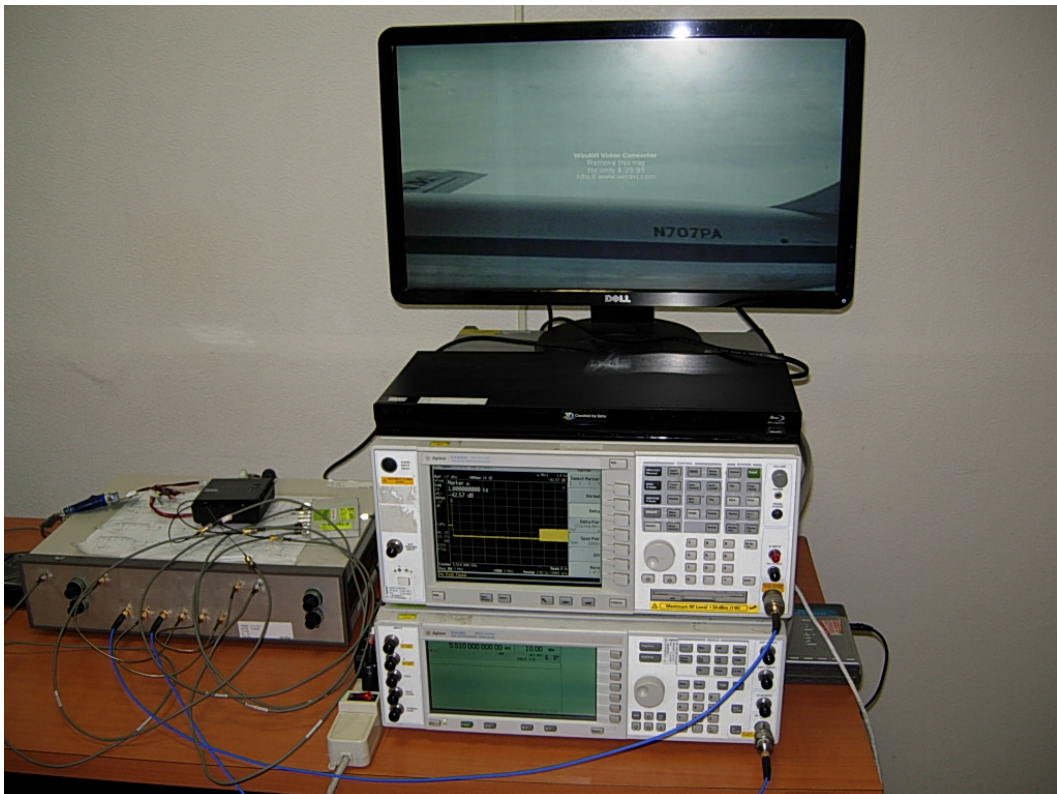

DFS Set-up Photo: Master and Slave(DUT)

