



FCC ID: QLEGME557RR

FCC PART 15C TEST REPORT FOR CERTIFICATION
On Behalf of

ATEN Technology Inc.

E7 Wireless Receiver

Model Number: GME557R, GME557RW1, GME557RW3, GME557RW4,
GME557RW5, GME557RW6, GME557RWM

FCC ID: QLEGME557RR

Prepared for : ATEN Technology Inc.
19641 Da Vinci Foothill Ranch, CA 92610 USA

Prepared By : Audix Technology (Shenzhen) Co., Ltd.
No. 6, Ke Feng Rd., 52 Block,
Shenzhen Science & Industrial Park,
Nantou, Shenzhen, Guangdong, China

Tel: (0755) 26639496

Report Number : ACS-F12190
Date of Test : Aug.03~08, 2012
Date of Report : Sep.15, 2012

TABLE OF CONTENTS

<u>Description</u>	<u>Page</u>
1. SUMMARY OF STANDARDS AND RESULTS.....	1-1
1.1. Description of Standards and Results	1-1
2. GENERAL INFORMATION	2-1
2.1. Description of Device (EUT)	2-1
2.2. EUT Configuration and operation conditions for test.....	2-1
2.3. Test Facility	2-2
2.4. Measurement Uncertainty (95% confidence levels, k=2)	2-2
3. POWER LINE CONDUCTED EMISSION TEST	3-1
3.1. Test Equipment	3-1
3.2. Block Diagram of Test Setup.....	3-1
3.3. Power Line Conducted Emission Test Limits.....	3-1
3.4. Configuration of EUT on Test	3-1
3.5. Operating Condition of EUT.....	3-2
3.6. Test Procedure.....	3-2
3.7. Conducted Disturbance at Mains Terminals Test Results.....	3-2
4. RADIATED EMISSION TEST	4-1
4.1. Test Equipment	4-1
4.2. Block Diagram of Test Setup.....	4-1
4.3. Radiated Emission Limit Standard: FCC 15.209 and 15.249	4-2
4.4. EUT Configuration on Test.....	4-3
4.5. Operating Condition of EUT.....	4-3
4.6. Test Procedure.....	4-3
4.7. Radiated Emission Test Results	4-3
5. 20 DB BANDWIDTH TEST	5-1
5.1. Test Equipment	5-1
5.2. Limit.....	5-1
5.3. Test Results	5-1
6. BAND EDGE COMPLIANCE TEST	6-1
6.1. Test Equipment	6-1
6.2. Limit.....	6-1
6.3. Test Produce	6-1
6.4. Test Results	6-2
7. ANTENNA REQUIREMENT	7-1
8. RADIO FRREQUENCY EXPOSURE COMPLIANCE.....	8-1
9. TEST SOFTWARE.....	9-1
10. DEVIATION TO TEST SPECIFICATIONS.....	10-1
11. PHOTOGRAPH OF TEST	11-1
11.1. Photos of Radiated Emission Test (30-1000MHz)	11-1
12. PHOTOGRAPH OF EUT	12-1

FCC ID: QLEGME557RR

TEST REPORT CERTIFICATION

Applicant : ATEN Technology Inc.
Manufacturer : G. tech Technology Ltd.
EUT Description : E7 Wireless Receiver
FCC ID : QLEGME557RR

(A) MODEL NO. : GME557R, GME557RW1, GME557RW3,
GME557RW4, GME557RW5,
GME557RW6, GME557RWM
(B) SERIAL NO. : N/A
(C) POWER SUPPLY : DC 5V
(D) TEST VOLTAGE : DC 5V From PC Input AC230V/50Hz

Tested for comply with:
FCC Rules and Regulations Part 15 Subpart C: 2008

Test procedure used:
ANSI C63.10:2009

The device described above is tested by AUDIX TECHNOLOGY (SHENZHEN) CO., LTD. to confirm comply with all the FCC Part 15 Subpart C requirements.

The test results are contained in this test report and AUDIX TECHNOLOGY (SHENZHEN) CO., LTD. is assumed full responsibility for the accuracy and completeness of these tests. This report contains data that are not covered by the NVLAP accreditation. Also, this report shows that the Equipment Under Test (EUT) is to be technically compliant with the FCC requirements.

This Report is made under FCC Part 2.1075. No modifications were required during testing to bring this product into compliance.

This report applies to above tested sample only. This report shall not be reproduced in part without written approval of AUDIX TECHNOLOGY (SHENZHEN) CO., LTD.

The report must not be used by the client to claim product certification, approval, or endorsement by NVLAP, NIST, or any agency of the federal government.

Date of Test : Aug.03~08, 2012 Report of date: Sep.15, 2012

Prepared by : Selina Liu / Supervisor
Reviewed by : Sunny Lu / Assistant Manager

 信華科技 (深圳) 有限公司
Audix Technology (Shenzhen) Co., Ltd.
EMC 部門報告專用章
Stamp only for EMC Dept. Report
Signature: Ken Lu 9/15/12

Approved & Authorized Signer : Ken Lu / Manager

1. SUMMARY OF STANDARDS AND RESULTS

1.1. Description of Standards and Results

The EUT have been tested according to the applicable standards as referenced below.

EMISSION		
Description of Test Item	Standard	Results
Power Line Conducted Emission Test	FCC Part 15C: 15.207 ANSI C63.10-2009	PASS
Radiated Emission Test	FCC Part 15C: 15.209 FCC Part 15C: 15.249 ANSI C63.10-2009	PASS
Band Edge Compliance Test	FCC Part 15: 15.249 ANSI C63.10-2009	PASS
20dB Bandwidth Test	FCC Part 15: 15.215 ANSI C63.10-2009	PASS

2. GENERAL INFORMATION

2.1. Description of Device (EUT)

Product Name	: E7 Wireless Receiver
Model Number	: GME557R, GME557RW1, GME557RW3, GME557RW4, GME557RW5, GME557RW6, GME557RWM
FCC ID	: QLEGME557RR
Operation frequency	: 2402MHz-2479MHz
Antenna	: Integrated PCB antenna, 0dBi gain
Modulation	: GFSK
Power Supply	: DC5V
Applicant	: ATEN Technology Inc. 19641 Da Vinci Foothill Ranch, CA 92610 USA
Manufacturer	: G. tech Technology Ltd. No.21, Jinding Industrial Park, West Jinfeng Road, Tangjiawan Town, Xiangzhou District Zhuhai Guangdong China
Date of Test	: Aug.03~08, 2012
Date of Receipt	: Aug.01, 2012
Sample Type	: Prototype production

2.2. EUT Configuration and operation conditions for test.

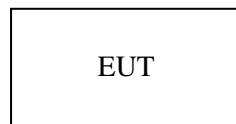

Notebook run test software to control EUT work in test mode

2.3. Test Facility

Site Description

Name of Firm : Audix Technology (Shenzhen) Co., Ltd.
No. 6, Ke Feng Rd., 52 Block, Shenzhen
Science & Industrial Park, Nantou,
Shenzhen, Guangdong, China

3m Anechoic Chamber : Certificated by FCC, USA
Registration Number: 90454
Valid Date: Feb.22, 2015

3m & 10m Anechoic Chamber : Certificated by FCC, USA
Registration Number: 794232
Valid Date: Dec.30, 2012

EMC Lab. : Certificated by Industry Canada
Registration Number: IC 5183A-1
Valid Date: Jun.13, 2014

Certificated by DAkkS, Germany
Registration No: D-PL-12151-01-01
Valid Date: Feb.01, 2014

Accredited by NVLAP, USA
NVLAP Code: 200372-0
Valid Date: Mar.31, 2013

2.4. Measurement Uncertainty (95% confidence levels, k=2)

Test Item	Uncertainty
Uncertainty for Radiation Emission test in 3m chamber	3.6 dB(30~200MHz, Polarize: H)
	3.8 dB(30~200MHz, Polarize: V)
	4.2 dB(200M~1GHz, Polarize: H)
	3.8 dB(200M~1GHz, Polarize: V)
Uncertainty for Radiated Spurious Emission test in RF chamber	3.57dB
Uncertainty for Conduction Spurious emission test	2.00 dB
Uncertainty for Output power test	0.73 dB
Uncertainty for Power density test	2.00 dB
Uncertainty for Frequency range test	7×10^{-8}
Uncertainty for Bandwidth test	83 kHz
Uncertainty for DC power test	0.038 %
Uncertainty for test site temperature and humidity	0.6°C
	3%

3. POWER LINE CONDUCTED EMISSION TEST

3.1. Test Equipment

Item	Equipment	Manufacturer	Model No.	Serial No.	Last Cal.	Cal. Interval
1.	Test Receiver	Rohde & Schwarz	ESHS10	838693/001	Oct.31, 11	1 Year
2.	L.I.S.N.#1	Rohde & Schwarz	ESH2-Z5	834066/011	Oct.31, 11	1 Year
3.	L.I.S.N.#3	Kyoritsu	KNW-242C	8-1920-1	May.08, 12	1 Year
4.	Terminator	Hubersuhner	50Ω	No. 1	May.08, 12	1 Year
5.	Terminator	Hubersuhner	50Ω	No. 2	May.08, 12	1 Year
6.	RF Cable	Fujikura	3D-2W	No.1	May.08, 12	1Year
7.	Coaxial Switch	Anritsu	MP59B	M50564	May.08, 12	1 Year
8.	Pulse Limiter	Rohde & Schwarz	ESH3-Z2	100341	May.08, 12	1 Year

3.2. Block Diagram of Test Setup

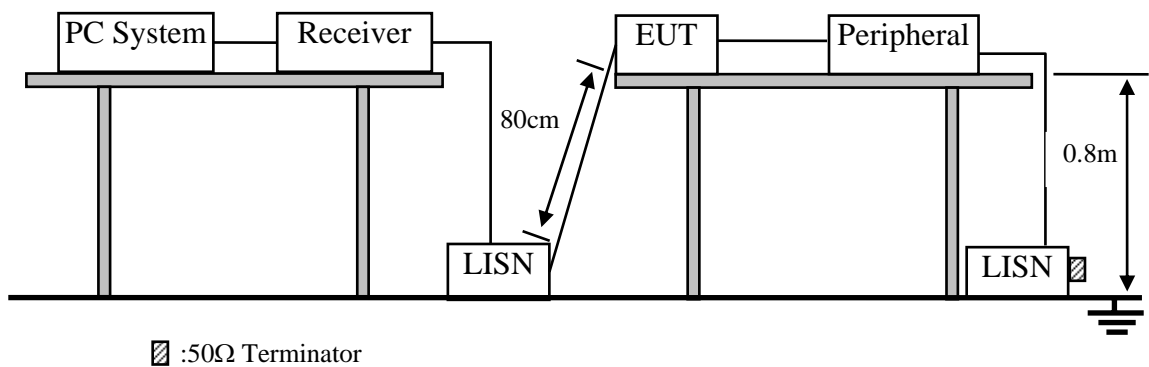

3.3. Power Line Conducted Emission Test Limits

Frequency	Maximum RF Line Voltage	
	Quasi-Peak Level dB(μV)	Average Level dB(μV)
150kHz ~ 500kHz	66 ~ 56*	56 ~ 46*
500kHz ~ 5MHz	56	46
5MHz ~ 30MHz	60	50

Notes: 1. * Decreasing linearly with logarithm of frequency.

2. The lower limit shall apply at the transition frequencies.

3.4. Configuration of EUT on Test

The following equipment are installed on Power Line Conducted Emission Test to meet the commission requirement and operating regulations in a manner which tends to maximize its emission characteristics in a normal application.

3.4.1. E7 Wireless Receiver (EUT)

Model Number : GME557R
Serial Number : N/A

3.5. Operating Condition of EUT

3.5.1. Setup the EUT and simulator as shown as Section 3.2.

3.5.2. Turn on the power of all equipment.

3.5.3. Let the EUT work in test mode (TX Mode) and measure it.

3.6. Test Procedure

The EUT was placed on a non-metallic table, 80cm above the ground plane. The EUT Power connected to the power mains through a line impedance stabilization network (L.I.S.N. 1#). The other peripheral devices power cord connected to the power mains through a line impedance stabilization network (L.I.S.N.#3). this provided a 50-ohm coupling impedance for the EUT (Please refer to the block diagram of the test setup and photographs). Both sides of power line were checked for maximum conducted interference. In order to find the maximum emission, the relative positions of equipments and all of the interface cables were changed according to ANSI C63.4-2009 on conducted Emission test.

The bandwidth of test receiver (R&S TEST RECEIVER ESHS10) is set at 9kHz.

The frequency range from 150kHz to 30MHz is checked. The test result are reported on Section 3.7.

3.7. Conducted Disturbance at Mains Terminals Test Results

PASS. (All emissions not reported below are too low against the prescribed limits.)

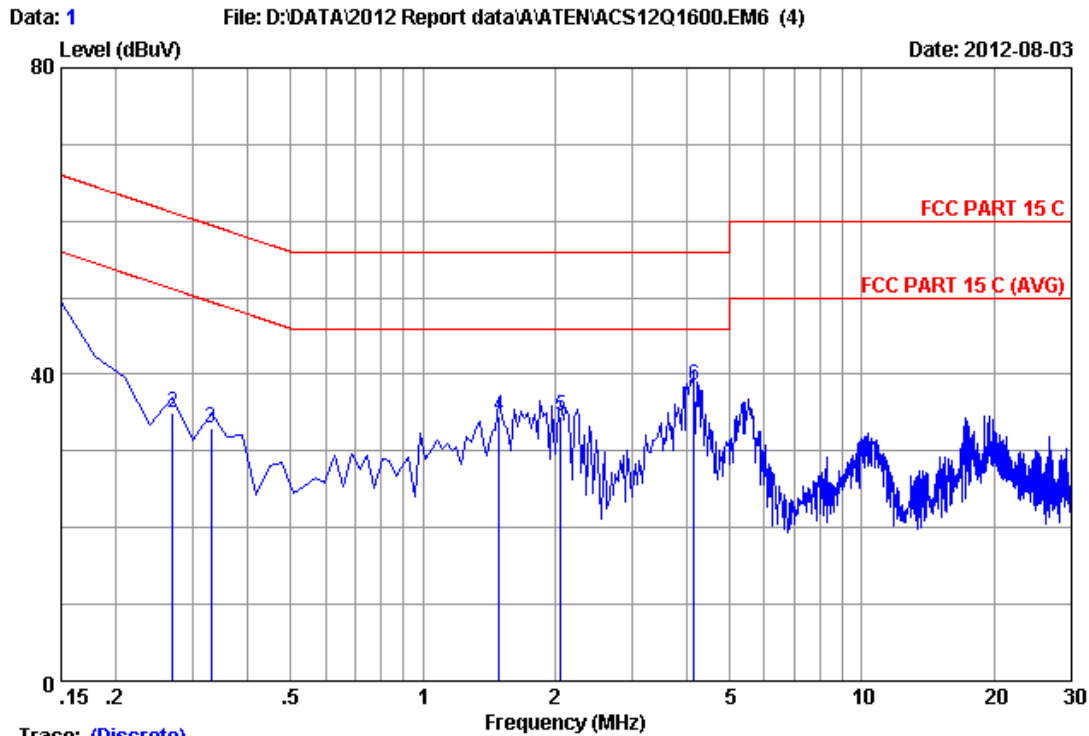

Trace: (Discrete)

Site no :1#conduction Data No :1
 Dis./Ant. :** 2012 ESH2-Z5 LINE
 Limit :FCC PART 15 C
 Env./Ins. :22.9*C/45% Engineer :Leo-Li
 EUT :E7 Wireless Receiver M/N:GME557R
 Power Rating :DC 5V From PC Input AC 120V/60Hz
 Test Mode :Tx Mode
 :

No	Freq (MHz)	LISN Factor (dB)	Cable Loss (dB)	Reading (dBuV)	Emission Level (dBuV)	Limits (dBuV)	Margin (dB)	Remark
1	0.15000	0.17	9.94	37.44	47.55	66.00	18.45	QP
2	0.26940	0.15	9.95	24.90	35.00	61.14	26.14	QP
3	0.32910	0.16	9.95	22.95	33.06	59.47	26.41	QP
4	1.493	0.19	9.94	24.35	34.48	56.00	21.52	QP
5	2.060	0.20	9.94	24.38	34.52	56.00	21.48	QP
6	4.150	0.24	9.94	28.42	38.60	56.00	17.40	QP

Remarks: 1.Emission Level=LISN Factor+Cable Loss(Include 10dB pulse limit)+Reading.
 2.If the average limit is met when using a quasi-peak detector. the EUT shall be deemed to meet both limits and measurement with average detector is unnecessary.

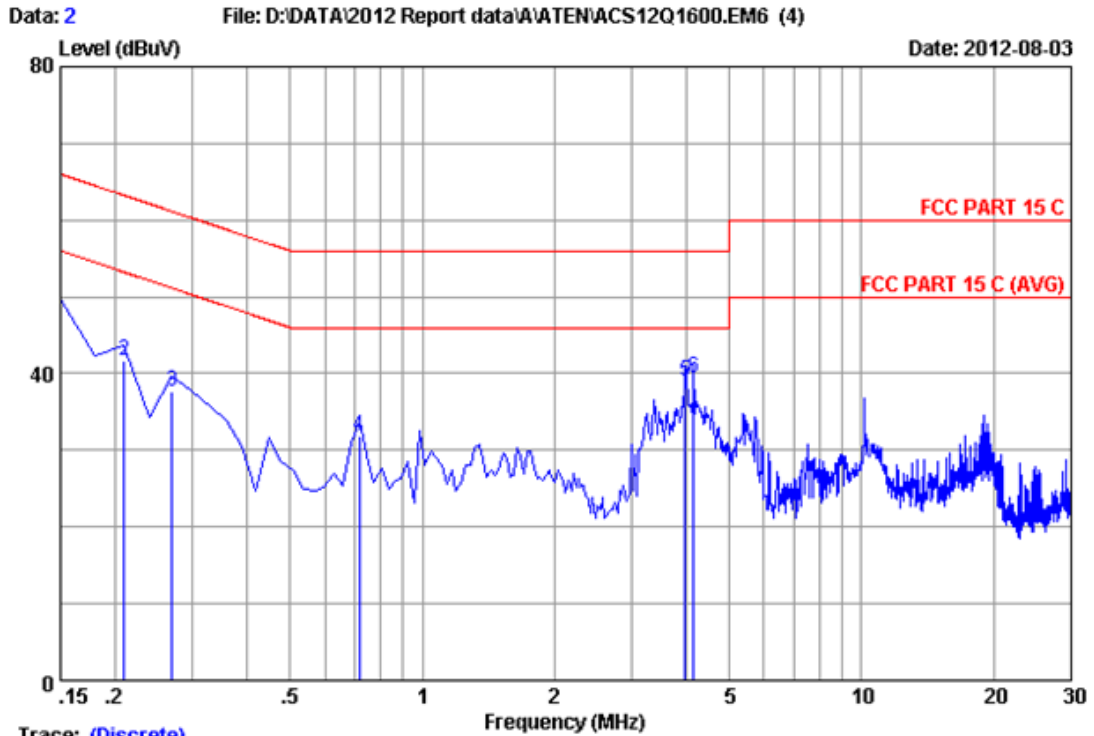

Trace: (Discrete)

Site no :1#conduction Data No :2
 Dis./Ant. **: 2012 ESH2-25 NEUTRAL
 Limit :FCC PART 15 C
 Env./Ins. :22.9°C/45% Engineer :Leo-Li
 EUT :E7 Wireless Receiver M/N:GME557R
 Power Rating :DC 5V From PC Input AC 120V/60Hz
 Test Mode :Tx Mode
 :

No	Freq (MHz)	LISN Factor (dB)	Cable Loss (dB)	Reading (dBUV)	Emission Level (dBUV)	Limits (dBUV)	Margin (dB)	Remark
1	0.15000	0.14	9.94	37.67	47.75	66.00	18.25	QP
2	0.20970	0.14	9.95	31.65	41.74	63.22	21.48	QP
3	0.26940	0.14	9.95	27.48	37.57	61.14	23.57	QP
4	0.71715	0.16	9.95	21.82	31.93	56.00	24.07	QP
5	3.971	0.24	9.94	28.77	38.95	56.00	17.05	QP
6	4.150	0.24	9.94	29.28	39.46	56.00	16.54	QP

Remarks: 1. Emission Level=LISN Factor+Cable Loss(Include 10dB pulse limit)+Reading.
 2. If the average limit is met when using a quasi-peak detector, the EUT shall be deemed to meet both limits and measurement with average detector is unnecessary.

4. RADIATED EMISSION TEST

4.1. Test Equipment

Frequency rang: 30~1000MHz

Item	Equipment	Manufacturer	Model No.	Serial No.	Last Cal.	Cal. Interval
1	3#Chamber	AUDIX	N/A	N/A	Nov.28,11	1 Year
2	EMI Spectrum	Agilent	E4407B	MY41440292	May.08, 12	1 Year
3	Test Receiver	Rohde & Schwarz	ESVS10	834468/011	May.08, 12	1 Year
4	Amplifier	HP	8447D	2648A04738	May.08, 12	1 Year
5	Bilog Antenna	Schaffner	CBL6111C	2598	Oct.26, 10	2.0 Year
6	RF Cable	MIYAZAKI	CFD400-NL	3# Chamber No.1	May.08, 12	1 Year
7	Coaxial Switch	Anritsu	MP59B	M74389	May.08, 12	1 Year

Frequency rang: above 1000MHz

Item	Equipment	Manufacturer	Model No.	Serial No.	Last Cal.	Cal. Interval
1	Spectrum Analyzer	Agilent	E4407B	MY41440292	May.08, 12	1 Year
2	Horn Antenna	EMCO	3115	9510-4580	June.05, 12	1 Year
3	Amplifier	Agilent	8449B	3008A00863	May.08, 12	1 Year
4	RF Cable	Hubersuhner	SUCOFLEX106	77980/6	May.08, 12	1 Year
5	RF Cable	Hubersuhner	SUCOFLEX106	77977/6	May.08, 12	1 Year
6	Horn Antenna	EMCO	3116	00060089	Nov.25,11	1.5 Year

4.2. Block Diagram of Test Setup

For frequency range 30MHz-1000MHz

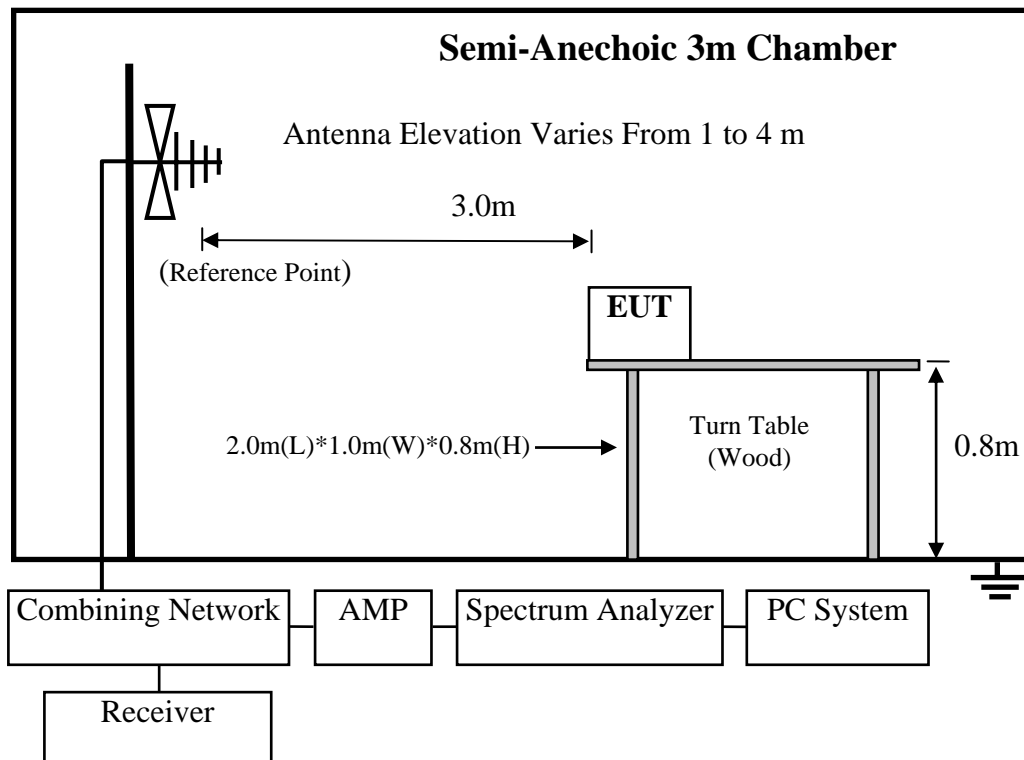

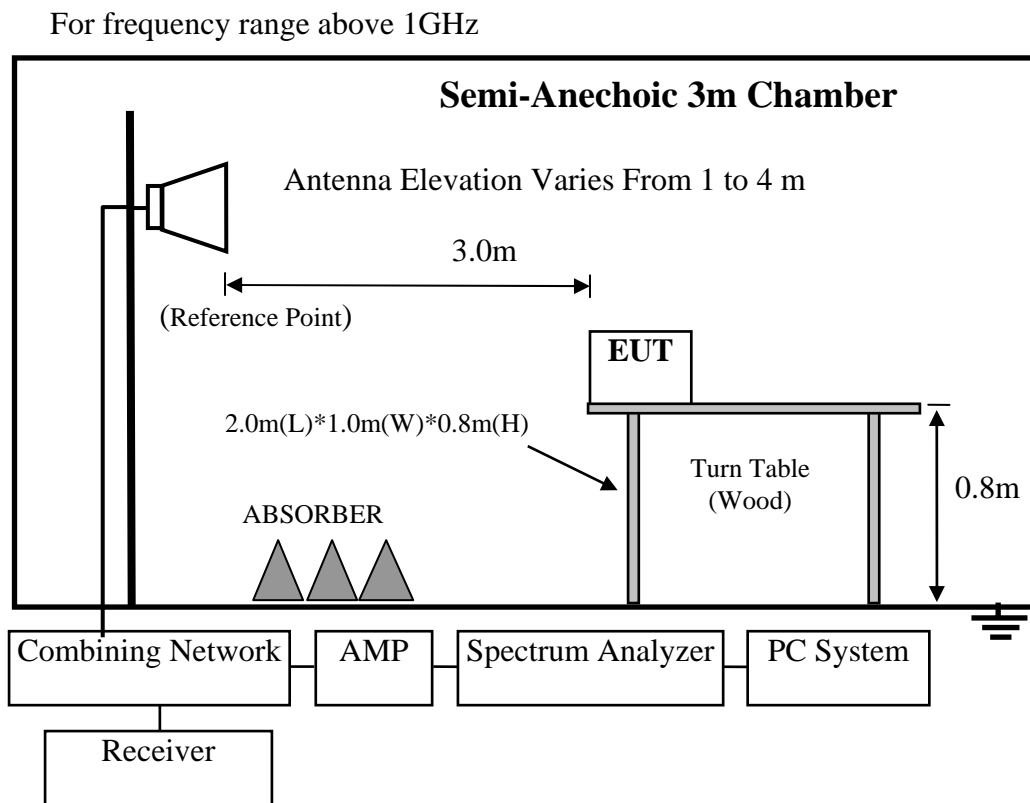

4.3. Radiated Emission Limit Standard: FCC 15.209 and 15.249

FREQUENCY MHz	DISTANCE Meters	FIELD STRENGTHS LIMIT	
		μV/m	dB(μV)/m
30 ~ 88	3	100	40.0
88 ~ 216	3	150	43.5
216 ~ 960	3	200	46.0
960 ~ 1000	3	500	54.0
Above 1000MHz	3	74.0 dB(μV)/m (Peak) 54.0 dB(μV)/m (Average)	
Field Strength of fundamental emissions for 2.4GHz-2.4835GHz	3	114.0 dB(μV)/m (Peak) 94.0 dB(μV)/m (Average)	

- Remark :
- (1) Emission level $dB\mu V = 20 \log$ Emission level $\mu V/m$
 - (2) The smaller limit shall apply at the cross point between two frequency bands.
 - (3) Distance is the distance in meters between the measuring instrument, antenna and the closest point of any part of the device or system.
 - (4) The emission limits shown in the above table are based on measurements employing a CISPR quasi-peak detector except for the frequency bands 9-90 kHz, 110-490 kHz and above 1000 MHz. Radiated emission limits in these three bands are based on measurements employing an average detector.

4.4.EUT Configuration on Test

The following equipment are installed on Radiated Emission Test to meet the commission requirements and operating regulations in a manner which tends to maximize its emission characteristics in normal application.

4.5.Operating Condition of EUT

- 4.5.1. Setup the EUT and simulator as shown as Section 4.2.
- 4.5.2. Turned on the power of all equipment.
- 4.5.3. Let EUT work in Tx mode.

4.6.Test Procedure

The EUT and its simulators are placed on a turn table, which is 0.8 meter high above ground. The turn table can rotate 360 degrees to determine the position of the maximum emission level. The EUT is set 3 meters away from the receiving antenna, which is mounted on a antenna tower. The antenna can be moved up and down between 1 meter and 4 meters to find out the maximum emission level. Broadband antenna (calibrated bilog antenna) is used as receiving antenna. Both horizontal and vertical polarization of the antenna is set on Test. In order to find the maximum emission levels, all of the interface cables must be manipulated according to ANSI C63.10-2009 on radiated emission Test.

During the pretest the EUT was rotated through three orthogonal axes to determine the attitude that maximizes the emissions.

After that the EUT was manually handled to find the orientation that has the maximum emission, which is the orientation show in the test setup photos.

The bandwidth of the EMI test receiver (R&S ESVS10) is set at 120kHz for frequency range from 30MHz to 1000 MHz.

The bandwidth of the Spectrum's RBW is set at 1MHz and VBW is set at 3MHz for peak emissions measurement above 1GHz

This device is pulse modulated, a duty cycle factor was used to calculate average level based measured peak level.

The frequency range from 30MHz to 10th harmonic (25GHz) are checked. and no any emissions were found from 18GHz to 25 GHz, So the radiated emissions from 18GHz to 25GHz were not record.

4.7.Radiated Emission Test Results

PASS.

All the emissions from 30MHz to 25GHz were comply with the 15.209 Limit.

Note: The duty cycle factor for calculate average level is 20.23dB, and average limit is 20dB below peak limit, so if peak measured level comply with peak limit, the average level was deemed to comply with average limit.

Duty cycle: $0.2167\text{ms} \times 4\text{times} / 8.9\text{ms} \times 100\% = 9.74\%$
 Duty cycle factor = $20\log(1/\text{duty cycle}) = 20.23\text{dB}$

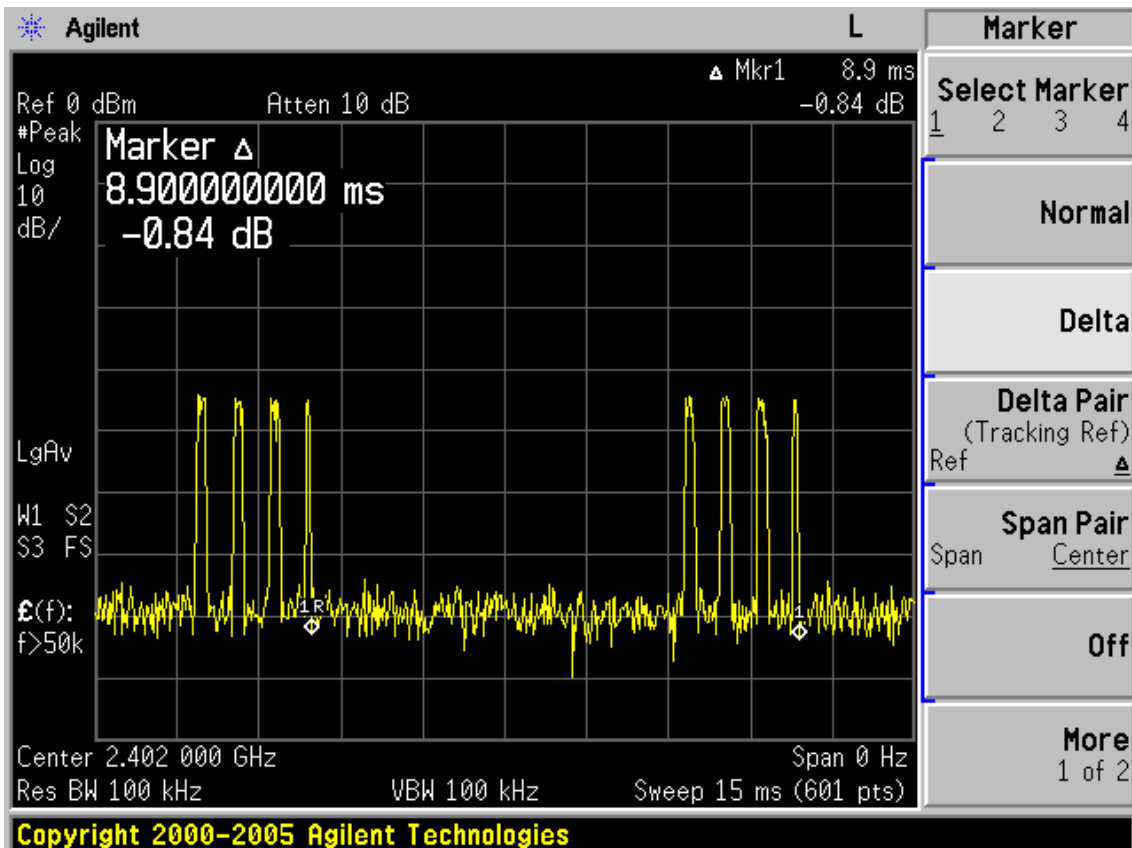
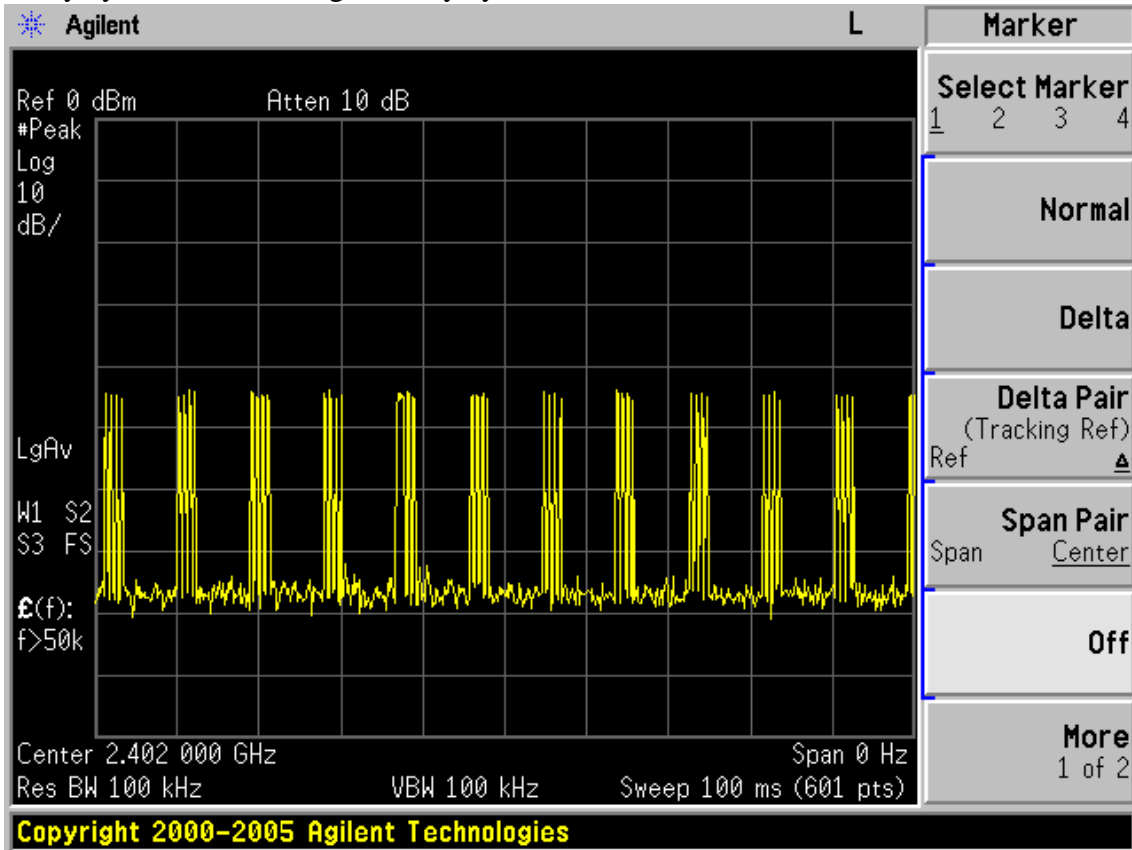

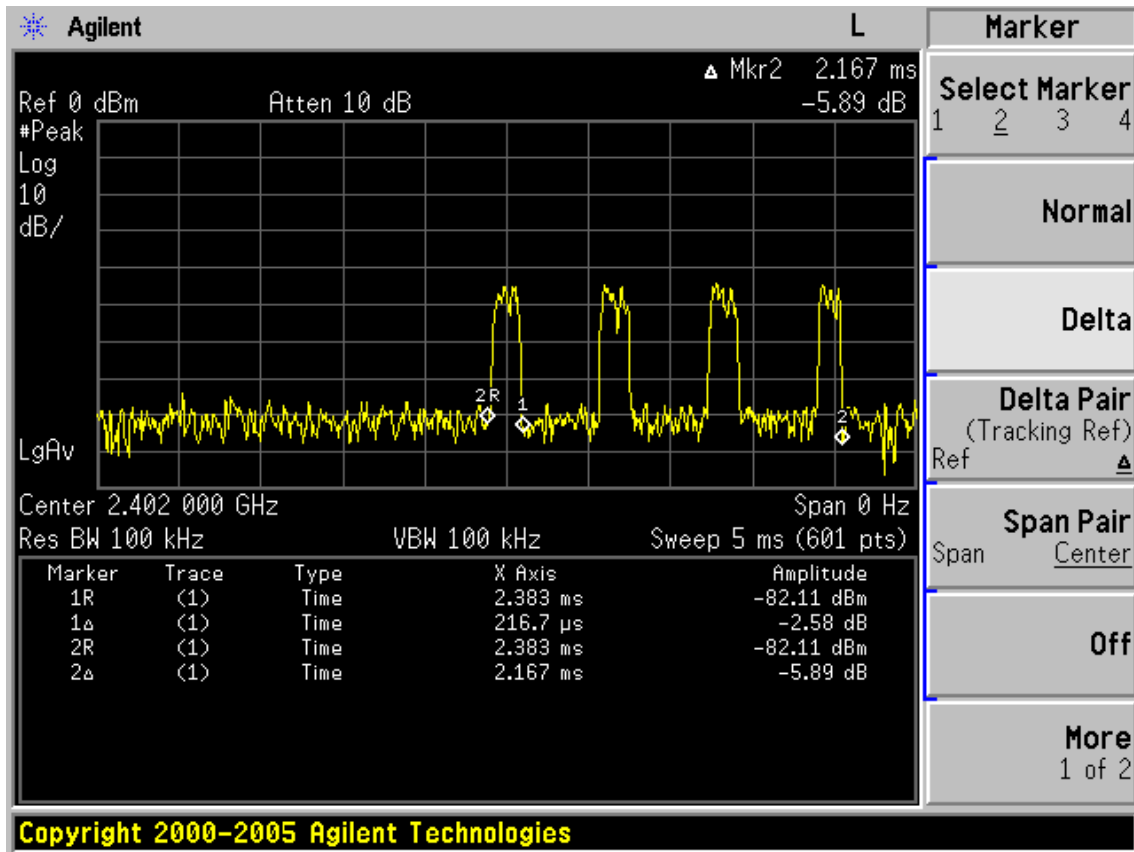

Frequency: 30MHz~1GHz

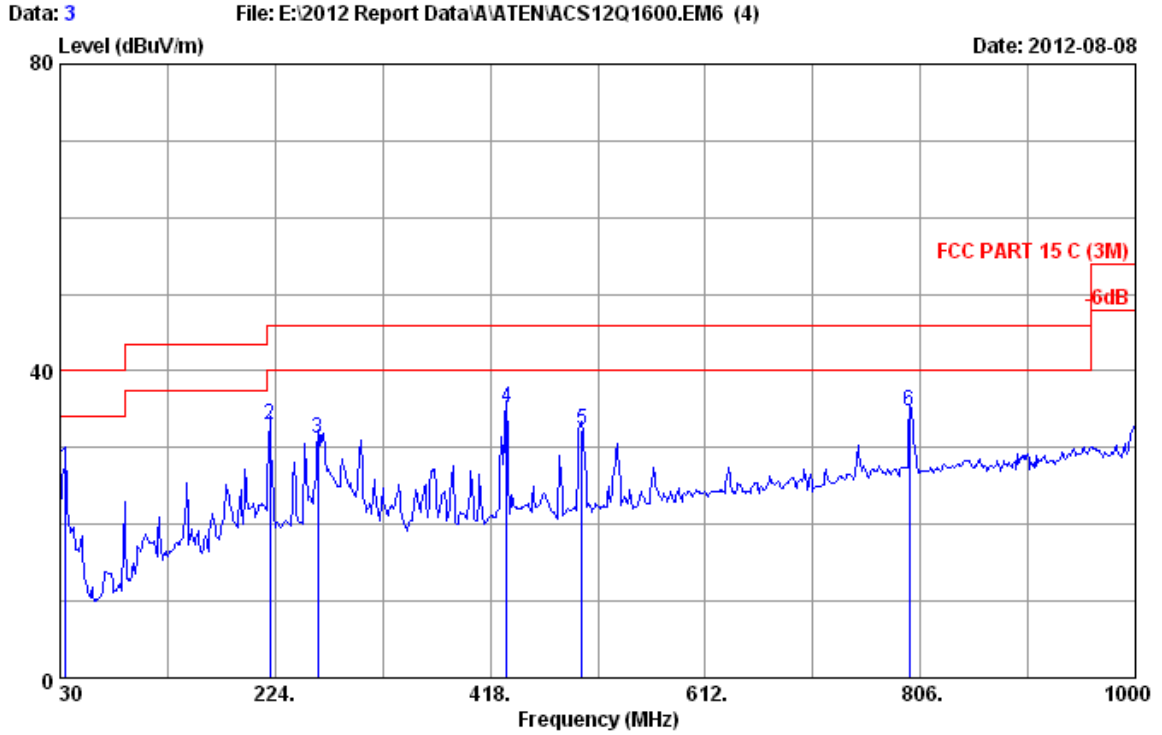

Site no. : 3m Chamber Data no. : 3
 Dis. / Ant. : 3m 2012 CBL6111C 2598 Ant. pol. : HORIZONTAL
 Limit : FCC PART 15 C (3M)
 Env. / Ins. : 24°C/56% Engineer : Leo_Li
 EUT : E7 Wireless Receiver
 Power rating : DC 5V From PC Input AC 120V/50Hz
 Test Mode : Tx Mode
 : M/N:GME557R
 :

No.	Freq. (MHz)	Ant. Factor (dB/m)	Cable Loss (dB)	Reading (dBuV)	Emission Level (dBuV/m)	Limits (dBuV/m)	Margin (dB)	Remark
1	34.850	16.01	0.51	10.91	27.43	40.00	12.57	QP
2	219.150	9.97	1.11	21.98	33.06	46.00	12.94	QP
3	262.800	13.91	1.19	16.16	31.26	46.00	14.74	QP
4	432.550	17.58	1.64	15.94	35.16	46.00	10.84	QP
5	500.450	19.09	1.83	11.49	32.41	46.00	13.59	QP
6	796.300	22.75	2.68	9.33	34.76	46.00	11.24	QP

Remarks: 1. Emission Level= Antenna Factor + Cable Loss + Reading.
 2. The emission levels that are 20dB below the official limit are not reported.

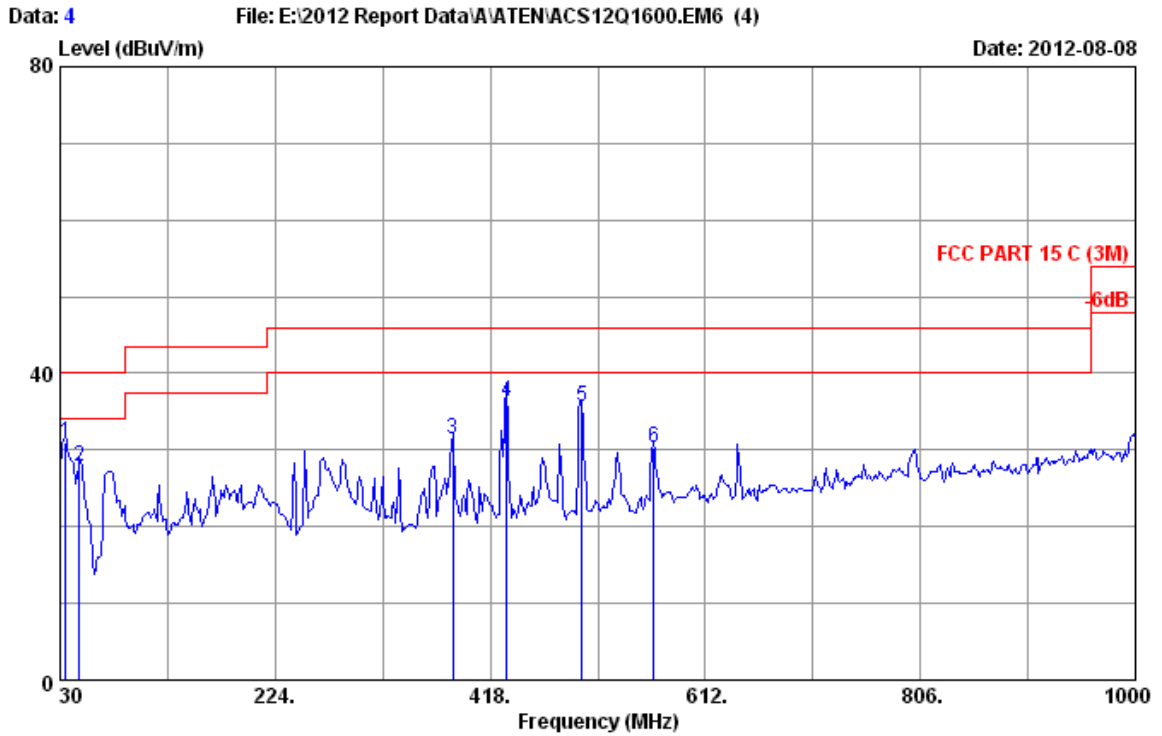

Site no. : 3m Chamber Data no. : 4
 Dis. / Ant. : 3m 2012 CBL6111C 2598 Ant. pol. : VERTICAL
 Limit : FCC PART 15 C (3M)
 Env. / Ins. : 24°C/56% Engineer : Leo_Li
 EUT : E7 Wireless Receiver
 Power rating : DC 5V From PC Input AC 120V/50Hz
 Test Mode : Tx Mode
 : M/N:GME557R
 :

No.	Freq. (MHz)	Ant. Factor (dB/m)	Cable Loss (dB)	Reading (dBuV)	Emission Level (dBuV/m)	Limits (dBuV/m)	Margin (dB)	Remark
1	34.850	16.01	0.51	14.47	30.99	40.00	9.01	QP
2	47.460	9.64	0.57	17.73	27.94	40.00	12.06	QP
3	384.050	16.08	1.52	13.74	31.34	46.00	14.66	QP
4	432.550	17.58	1.64	17.14	36.36	46.00	9.64	QP
5	500.450	19.09	1.83	14.65	35.57	46.00	10.43	QP
6	565.440	19.91	2.01	8.33	30.25	46.00	15.75	QP

Remarks: 1. Emission Level= Antenna Factor + Cable Loss + Reading.
 2. The emission levels that are 20dB below the official limit are not reported.

Frequency: 1GHz~18GHz

Data: 27

File: E:\2012 Report\A\ATEN\ACS12Q1600.EM6 (42)

Date: 2012-08-07

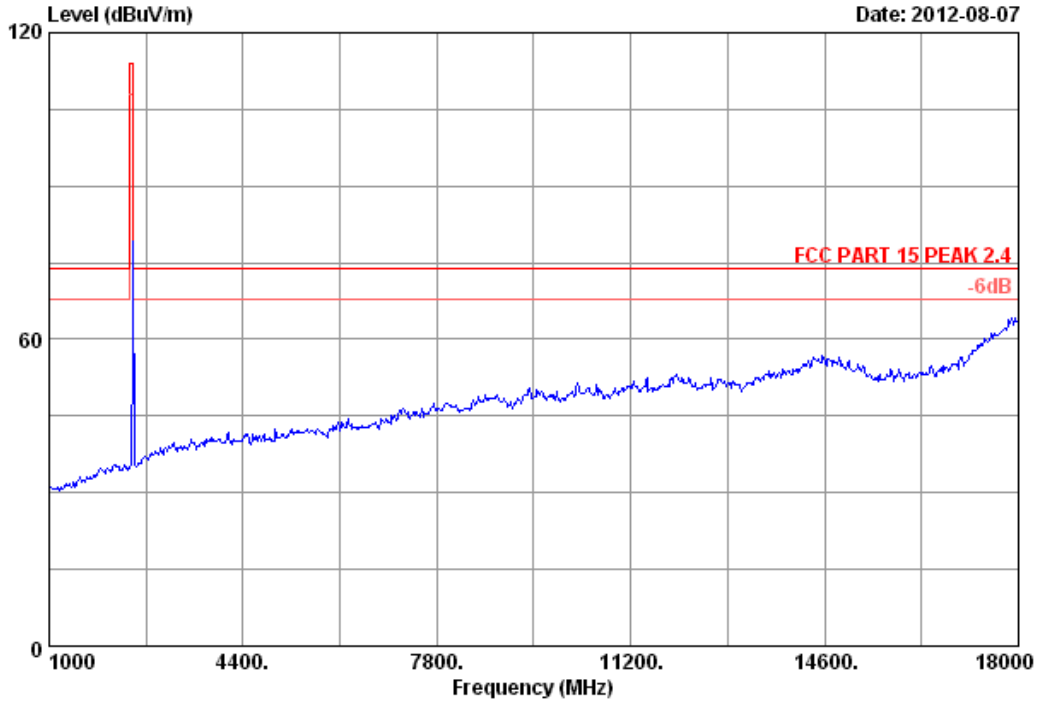

Site no.	: 3m Chamber	Data no.	: 27
Dis. / Ant.	: 3m 2011 3115 4580	Ant. pol.	: HORIZONTAL
Limit	: FCC PART 15 PEAK 2.4		
Env. / Ins.	: 23°C/54%	Engineer	: Leo-Li
EUT	: E7 Wireless Receiver		
Power supply	: DC 5V From PC Input AC 230V/50Hz		
Test mode	: GFSK 2479MHz Tx Mode		
M/N	: GME557R		

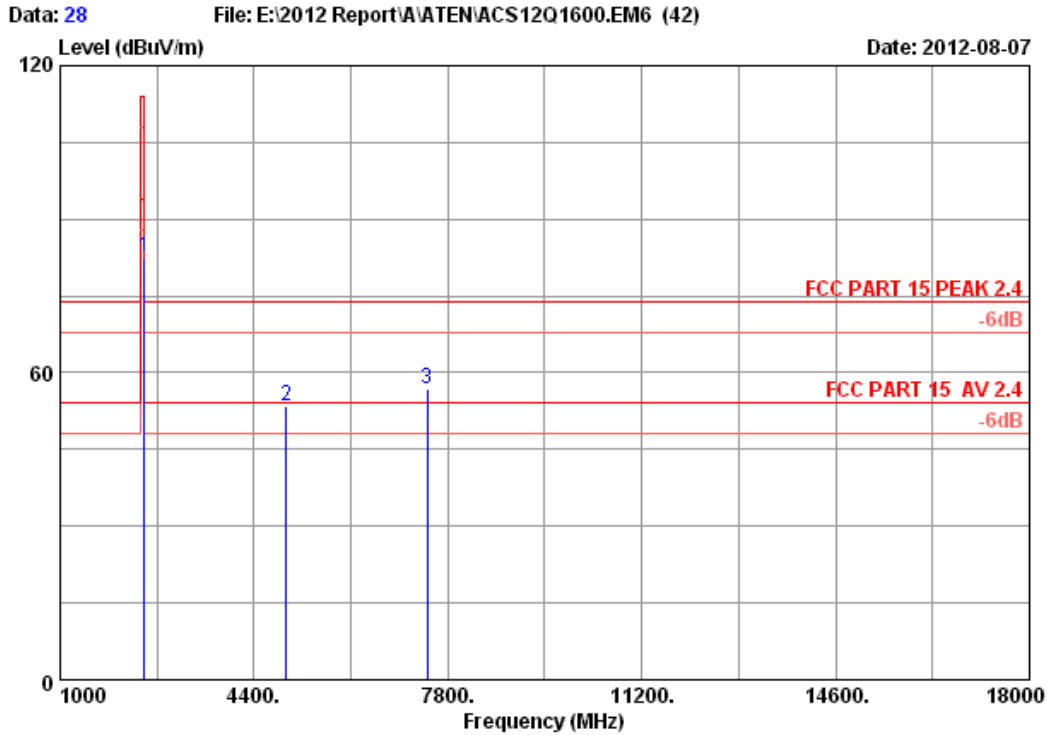

Site no. : 3m Chamber Data no. : 28
 Dis. / Ant. : 3m 2011 3115 4580 Ant. pol. : HORIZONTAL
 Limit : FCC PART 15 PEAK 2.4
 Env. / Ins. : 23*C/54% Engineer : Leo-Li
 EUT : E7 Wireless Receiver
 Power supply : DC 5V From PC Input AC 230V/50Hz
 Test mode : GFSK 2479MHz Tx Mode
 M/N : GME557R

	Ant. Factor (dB/m)	Cable loss (dB)	Amp. Factor (dB)	Reading (dBuV)	Emission Level (dBuV/m)	Limits (dBuV/m)	Margin (dB)	Remark
1 2479.000	28.08	6.15	34.45	82.74	82.52	114.00	31.48	Peak
2 4958.000	33.14	8.65	34.60	46.20	53.39	74.00	20.61	Peak
3 7437.000	36.37	10.51	34.74	44.68	56.82	74.00	17.18	Peak

Remarks:

1. Emission Level= Antenna Factor + Cable Loss -Amp Factor + Reading.
2. The emission levels that are 20dB below the official limit are not reported.

Frequency (MHz)	Peak level (dBuV/m)	Duty cycle factor (dB)	AV level (dBuV/m)	Limit(dBuV/m)	Conclusion
7437	56.82	20.23	36.59	54	Pass

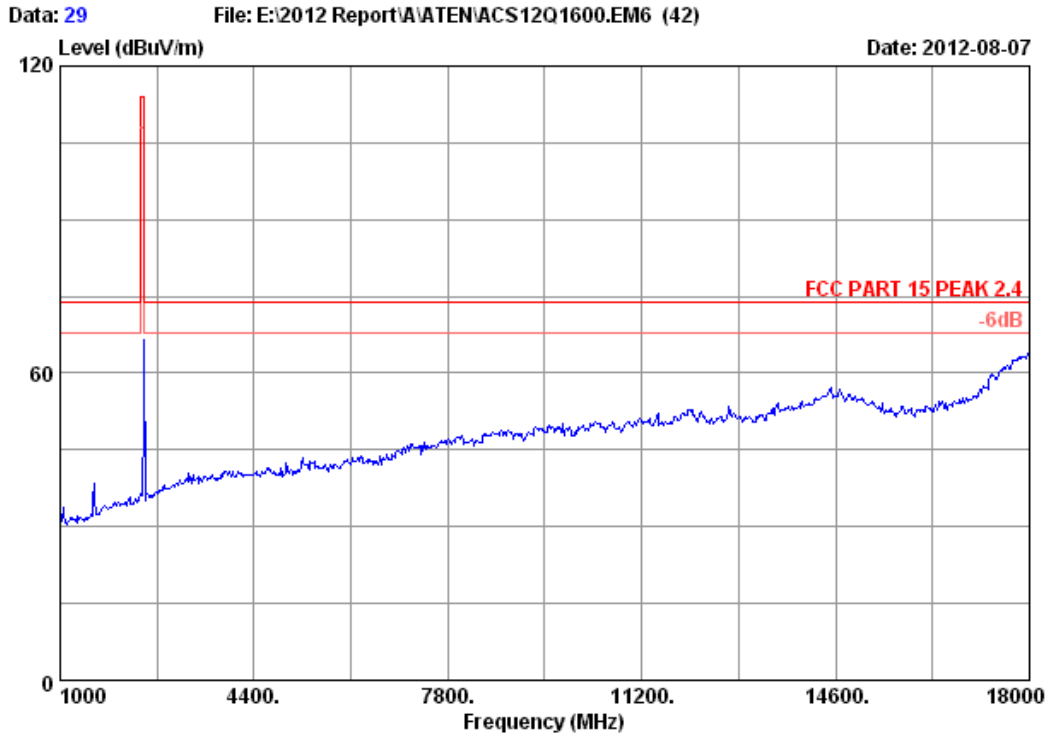

Site no.	: 3m Chamber	Data no.	: 29
Dis. / Ant.	: 3m 2011 3115 4580	Ant. pol.	: VERTICAL
Limit	: FCC PART 15 PEAK 2.4		
Env. / Ins.	: 23°C/54%	Engineer	: Leo-Li
EUT	: E7 Wireless Receiver		
Power supply	: DC 5V From PC Input AC 230V/50Hz		
Test mode	: GFSK 2479MHz Tx Mode		
M/N	: GME557R		

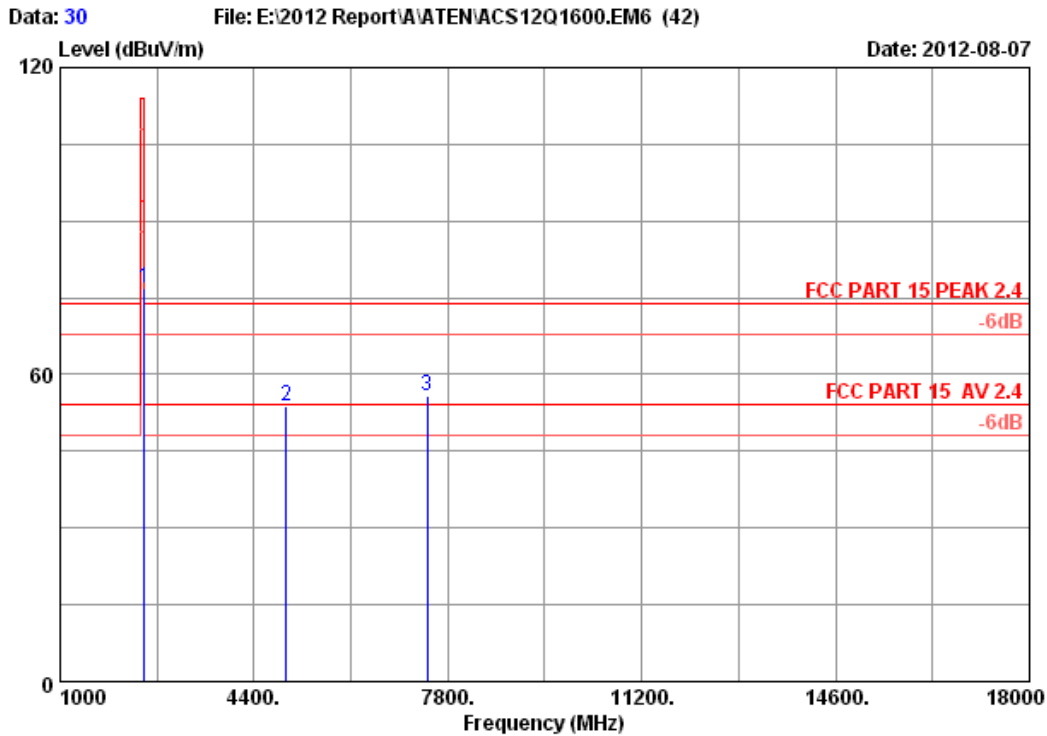

Site no. : 3m Chamber Data no. : 30
 Dis. / Ant. : 3m 2011 3115 4580 Ant. pol. : VERTICAL
 Limit : FCC PART 15 PEAK 2.4
 Env. / Ins. : 23°C/54% Engineer : Leo-Li
 EUT : E7 Wireless Receiver
 Power supply : DC 5V From PC Input AC 230V/50Hz
 Test mode : GFSK 2479MHz Tx Mode
 M/N : GME557R

	Freq. (MHz)	Ant. Factor (dB/m)	Cable loss (dB)	Amp. Factor (dB)	Reading (dBuV)	Emission Level (dBuV/m)	Limits (dBuV/m)	Margin (dB)	Remark
1	2479.000	28.08	6.15	34.45	77.03	76.81	114.00	37.19	Peak
2	4958.000	33.14	8.65	34.60	46.56	53.75	74.00	20.25	Peak
3	7437.000	36.37	10.51	34.74	43.65	55.79	74.00	18.21	Peak

Remarks:

1. Emission Level= Antenna Factor + Cable Loss -Amp Factor + Reading.
2. The emission levels that are 20dB below the official limit are not reported.

Frequency (MHz)	Peak level (dBuV/m)	Duty cycle factor (dB)	AV level (dBuV/m)	Limit(dBuV/m)	Conclusion
7437	55.79	20.23	35.56	54	Pass

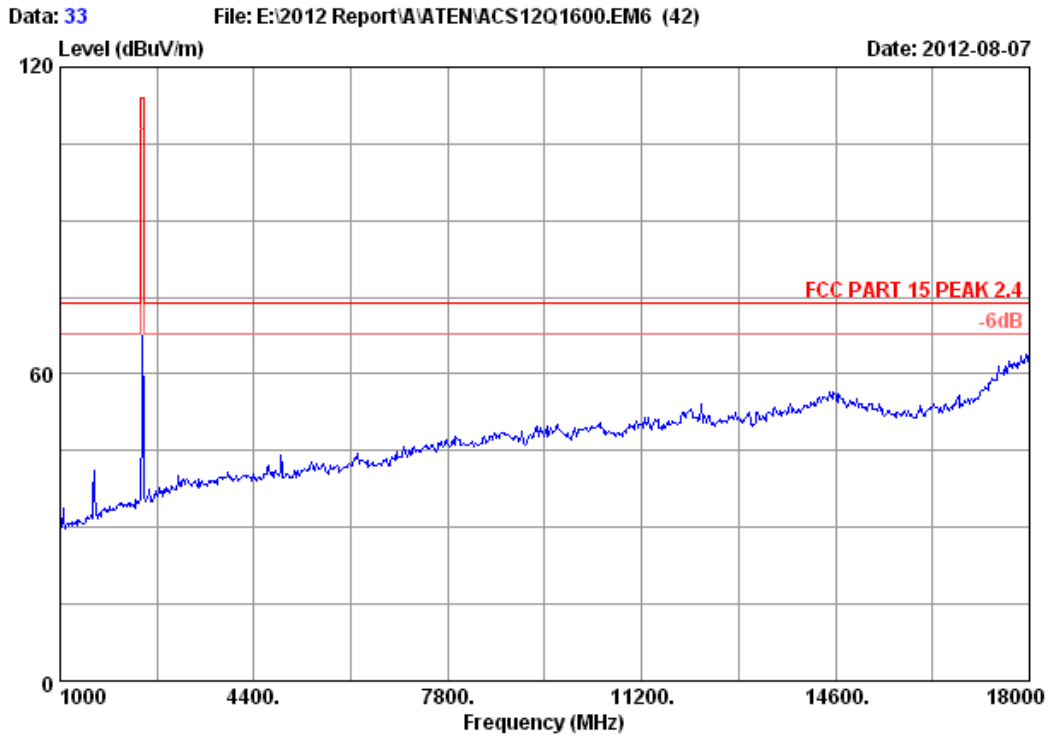

Site no.	: 3m Chamber	Data no.	: 33
Dis. / Ant.	: 3m 2011 3115 4580	Ant. pol.	: VERTICAL
Limit	: FCC PART 15 PEAK 2.4		
Env. / Ins.	: 23°C/54%	Engineer	: Leo-Li
EUT	: E7 Wireless Receiver		
Power supply	: DC 5V From PC Input AC 230V/50Hz		
Test mode	: GFSK 2439MHz Tx Mode		
M/N	: GME557R		

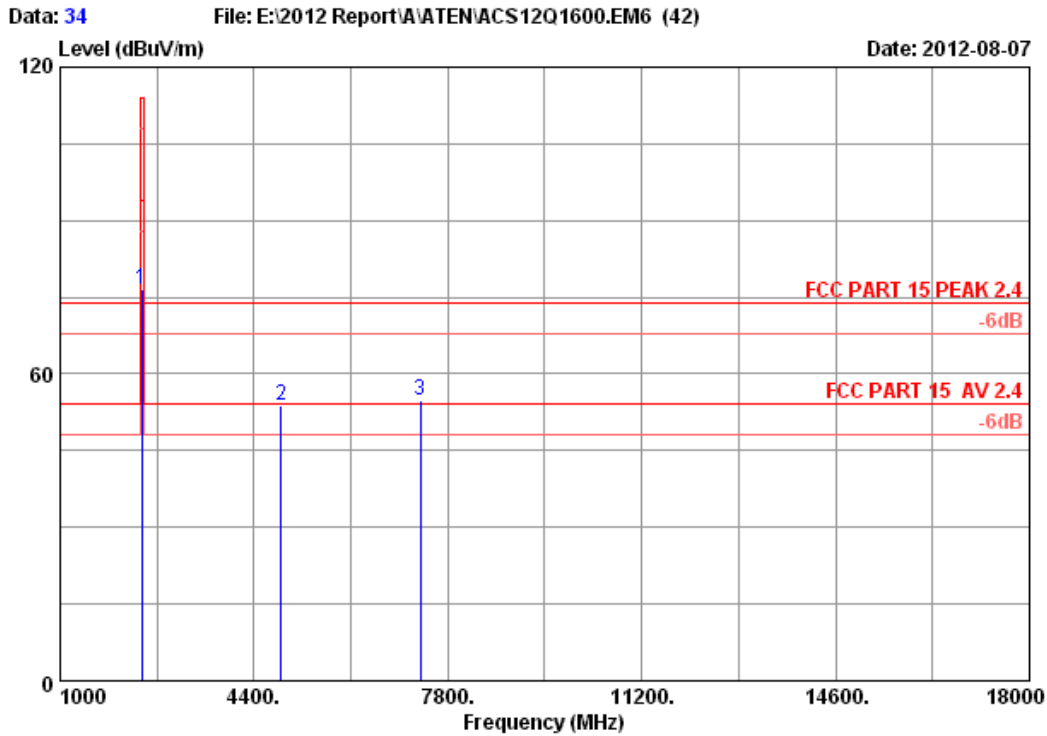

Site no. : 3m Chamber Data no. : 34
 Dis. / Ant. : 3m 2011 3115 4580 Ant. pol. : VERTICAL
 Limit : FCC PART 15 PEAK 2.4
 Env. / Ins. : 23°C/54% Engineer : Leo-Li
 EUT : E7 Wireless Receiver
 Power supply : DC 5V From PC Input AC 230V/50Hz
 Test mode : GFSK 2439MHz Tx Mode
 M/N : GME557R

	Freq. (MHz)	Ant. Factor (dB/m)	Cable loss (dB)	Amp. Factor (dB)	Reading (dBUV)	Emission Level (dBUV/m)	Limits (dBUV/m)	Margin (dB)	Remark
1	2439.000	28.03	6.09	34.44	76.86	76.54	114.00	37.46	Peak
2	4878.000	32.98	8.58	34.60	47.00	53.96	74.00	20.04	Peak
3	7317.000	36.05	10.48	34.73	42.90	54.70	74.00	19.30	Peak

Remarks:

1. Emission Level= Antenna Factor + Cable Loss -Amp Factor + Reading.
2. The emission levels that are 20dB below the official limit are not reported.

Frequency (MHz)	Peak level (dBUV/m)	Duty cycle factor (dB)	AV level (dBUV/m)	Limit(dBUV/m)	Conclusion
7317	54.70	20.23	34.47	54	Pass

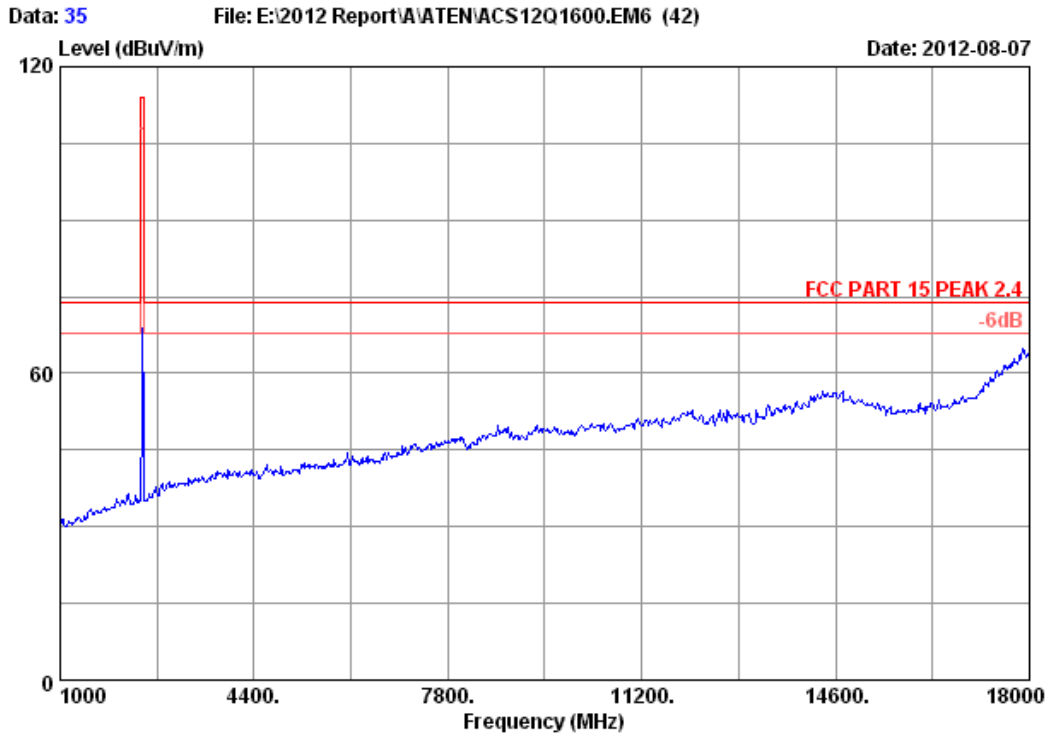

Site no.	: 3m Chamber	Data no.	: 35
Dis. / Ant.	: 3m 2011 3115 4580	Ant. pol.	: HORIZONTAL
Limit	: FCC PART 15 PEAK 2.4		
Env. / Ins.	: 23°C/54%	Engineer	: Leo-Li
EUT	: E7 Wireless Receiver		
Power supply	: DC 5V From PC Input AC 230V/50Hz		
Test mode	: GFSK 2439MHz Tx Mode		
M/N	: GME557R		

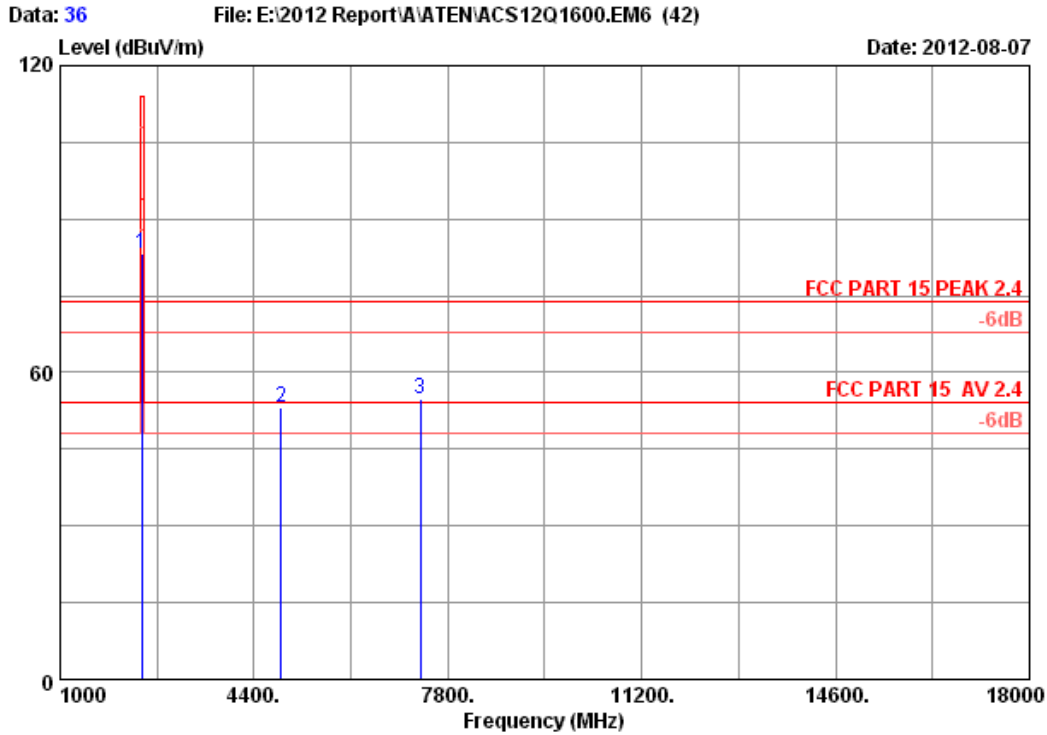

Site no. : 3m Chamber Data no. : 36
 Dis. / Ant. : 3m 2011 3115 4580 Ant. pol. : HORIZONTAL
 Limit : FCC PART 15 PEAK 2.4
 Env. / Ins. : 23*C/54% Engineer : Leo-Li
 EUT : E7 Wireless Receiver
 Power supply : DC 5V From PC Input AC 230V/50Hz
 Test mode : GFSK 2439MHz Tx Mode
 M/N : GME557R

	Freq. (MHz)	Ant. Factor (dB/m)	Cable loss (dB)	Amp. Factor (dB)	Reading (dBuV)	Emission Level (dBuV/m)	Limits (dBuV/m)	Margin (dB)	Remark
1	2439.000	28.03	6.09	34.44	83.47	83.15	114.00	30.85	Peak
2	4878.000	32.98	8.58	34.60	46.28	53.24	74.00	20.76	Peak
3	7317.000	36.05	10.48	34.73	42.86	54.66	74.00	19.34	Peak

Remarks:

1. Emission Level= Antenna Factor + Cable Loss -Amp Factor + Reading.
2. The emission levels that are 20dB below the official limit are not reported.

Frequency (MHz)	Peak level (dBuV/m)	Duty cycle factor (dB)	AV level (dBuV/m)	Limit(dBuV/m)	Conclusion
7317	54.66	20.23	34.43	54	Pass

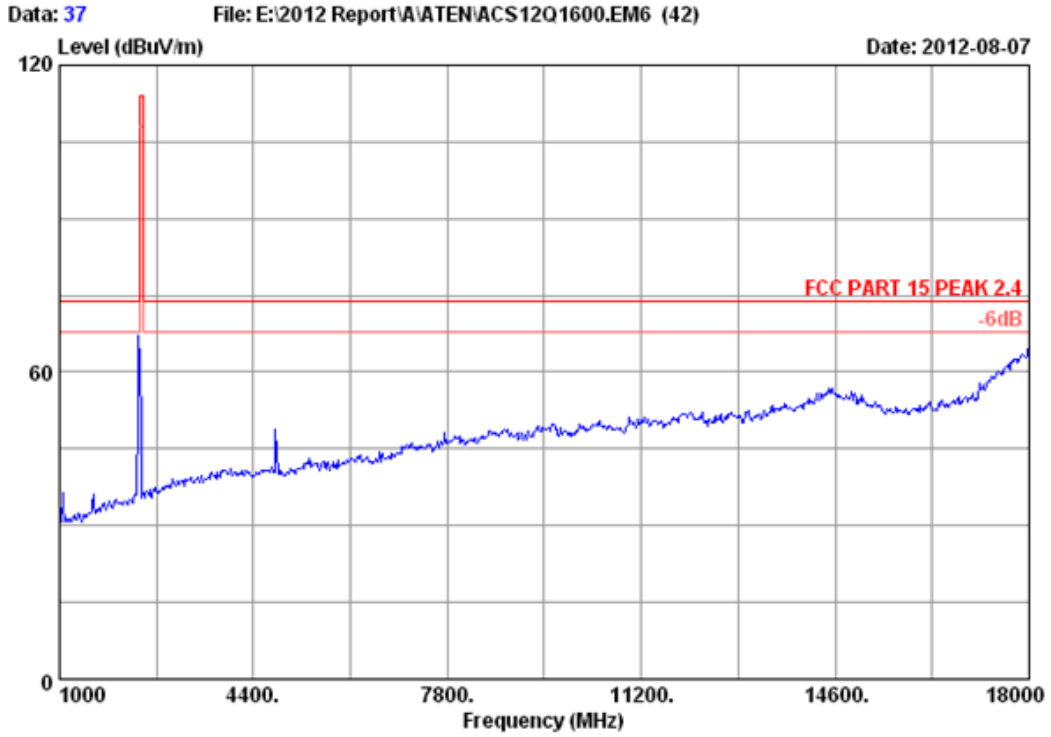

Site no.	: 3m Chamber	Data no.	: 37
Dis. / Ant.	: 3m 2011 3115 4580	Ant. pol.	: VERTICAL
Limit	: FCC PART 15 PEAK 2.4		
Env. / Ins.	: 23°C/54%	Engineer	: Leo-Li
EUT	: E7 Wireless Receiver		
Power supply	: DC 5V From PC Input AC 230V/50Hz		
Test mode	: GFSK 2402MHz Tx Mode		
M/N	: GME557R		

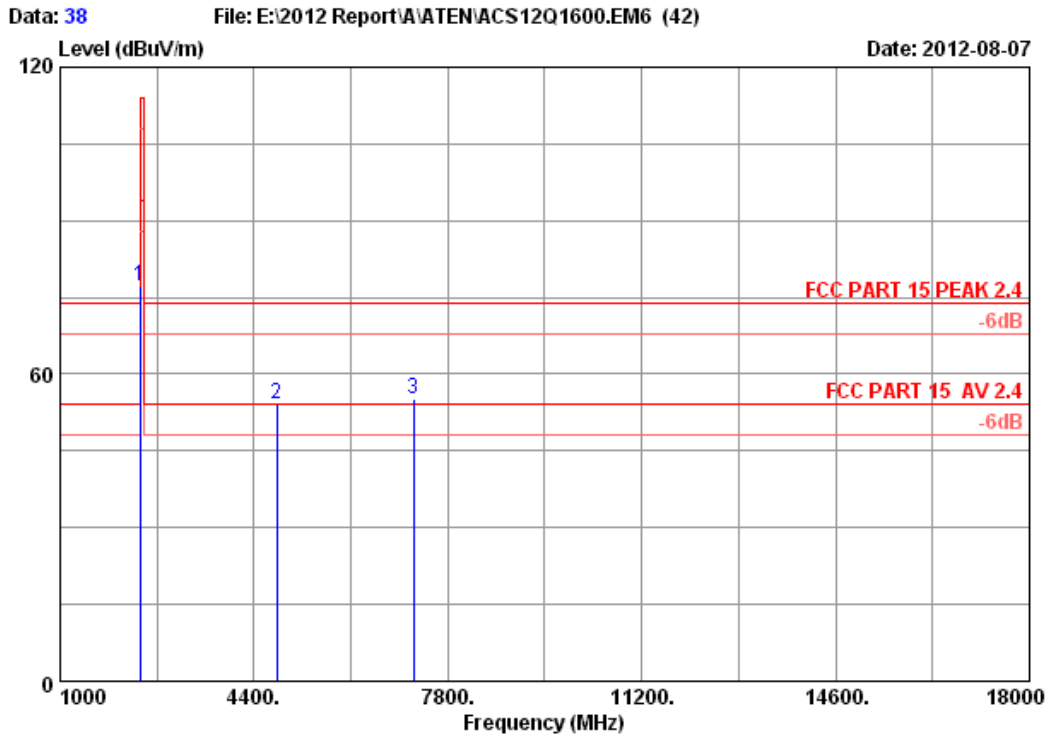

Site no. : 3m Chamber Data no. : 38
 Dis. / Ant. : 3m 2011 3115 4580 Ant. pol. : VERTICAL
 Limit : FCC PART 15 PEAK 2.4
 Env. / Ins. : 23°C/54% Engineer : Leo-Li
 EUT : E7 Wireless Receiver
 Power supply : DC 5V From PC Input AC 230V/50Hz
 Test mode : GFSK 2402MHz Tx Mode
 M/N : GME557R

	Freq. (MHz)	Ant. Factor (dB/m)	Cable loss (dB)	Amp. Factor (dB)	Reading (dBUV)	Emission Level (dBUV/m)	Limits (dBUV/m)	Margin (dB)	Remark
1	2402.000	27.96	6.01	34.44	77.72	77.25	114.00	36.75	Peak
2	4804.000	32.86	8.52	34.60	47.25	54.03	74.00	19.97	Peak
3	7206.000	35.74	10.45	34.72	43.78	55.25	74.00	18.75	Peak

Remarks:

1. Emission Level= Antenna Factor + Cable Loss -Amp Factor + Reading.
2. The emission levels that are 20dB below the official limit are not reported.

Frequency (MHz)	Peak level (dBUV/m)	Duty cycle factor (dB)	AV level (dBUV/m)	Limit(dBUV/m)	Conclusion
7206	55.25	20.23	35.02	54	Pass

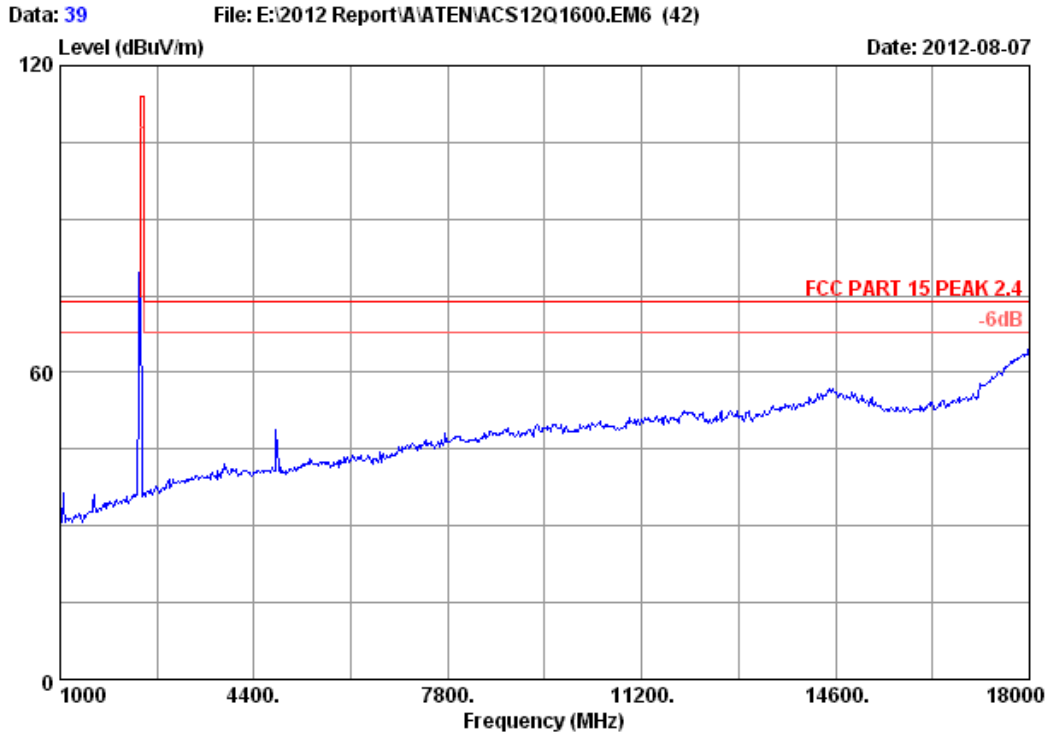

Site no.	: 3m Chamber	Data no.	: 39
Dis. / Ant.	: 3m 2011 3115 4580	Ant. pol.	: HORIZONTAL
Limit	: FCC PART 15 PEAK 2.4		
Env. / Ins.	: 23°C/54%	Engineer	: Leo-Li
EUT	: E7 Wireless Receiver		
Power supply	: DC 5V From PC Input AC 230V/50Hz		
Test mode	: GFSK 2402MHz Tx Mode		
M/N	: GME557R		

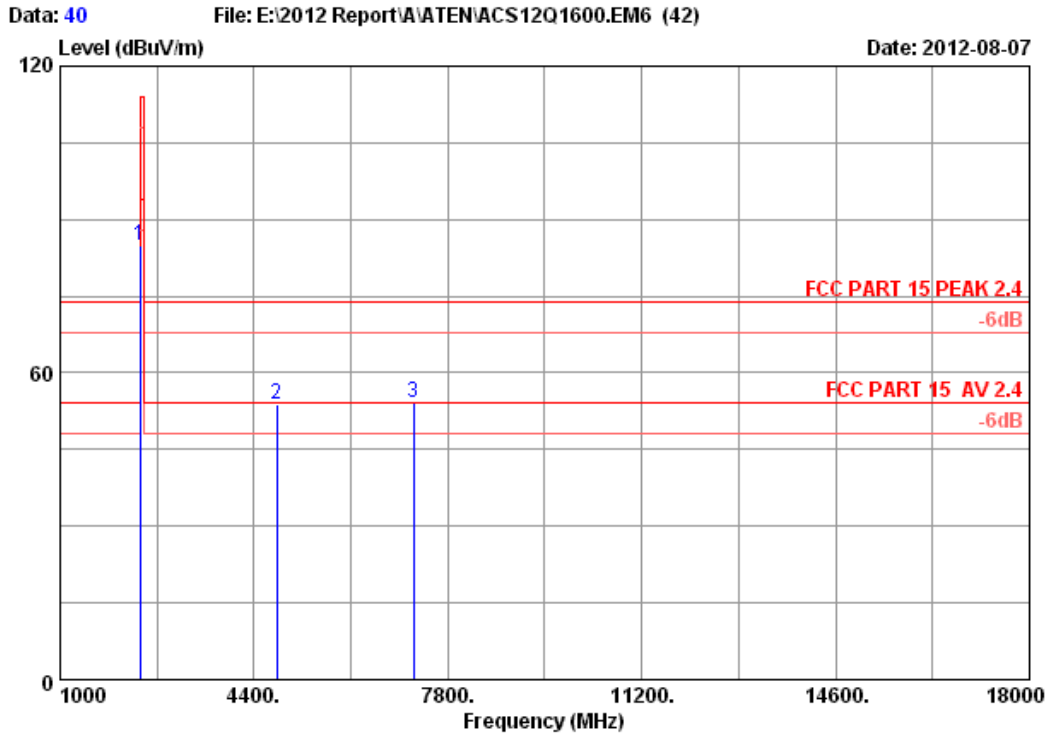

Site no. : 3m Chamber Data no. : 40
 Dis. / Ant. : 3m 2011 3115 4580 Ant. pol. : HORIZONTAL
 Limit : FCC PART 15 PEAK 2.4
 Env. / Ins. : 23°C/54% Engineer : Leo-Li
 EUT : E7 Wireless Receiver
 Power supply : DC 5V From PC Input AC 230V/50Hz
 Test mode : GFSK 2402MHz Tx Mode
 M/N : GME557R

	Freq. (MHz)	Ant. Factor (dB/m)	Cable loss (dB)	Amp. Factor (dB)	Reading (dBUV)	Emission Level (dBUV/m)	Limits (dBUV/m)	Margin (dB)	Remark
1	2402.000	27.96	6.01	34.44	85.22	84.75	114.00	29.25	Peak
2	4804.000	32.86	8.52	34.60	47.06	53.84	74.00	20.16	Peak
3	7206.000	35.74	10.45	34.72	42.68	54.15	74.00	19.85	Peak

Remarks:

1. Emission Level= Antenna Factor + Cable Loss -Amp Factor + Reading.
2. The emission levels that are 20dB below the official limit are not reported.

Frequency (MHz)	Peak level (dBUV/m)	Duty cycle factor (dB)	AV level (dBUV/m)	Limit(dBUV/m)	Conclusion
7206	54.15	20.23	33.92	54	Pass

5. 20 DB BANDWIDTH TEST

5.1. Test Equipment

Item	Equipment	Manufacturer	Model No.	Serial No.	Last Cal.	Cal. Interval
1.	Spectrum	Agilent	E4446A	US44300459	May.08, 12	1 Year

5.2. Limit

Intentional radiators operating under the alternative provisions to the general emission limits, as contained in §§ 15.217 through 15.257 and in Subpart E of this part, must be designed to ensure that the 20 dB bandwidth of the emission, or whatever bandwidth may otherwise be specified in the specific rule section under which the equipment operates, is contained within the frequency band designated in the rule section under which the equipment is operated.

5.3. Test Results

EUT: E7 Wireless Receiver		
M/N: GEM557R		
Test date: 2012-08-06	Pressure: 101.2 kpa	Humidity: 53.4 %
Tested by: Leo-Li	Test site: RF site	Temperature: 24.1 °C

Frequency	20dB bandwidth (MHz)	Limit (MHz)
2402MHz	3.635	N/A
2439MHz	3.869	N/A
2479MHz	3.478	N/A
Conclusion : PASS		

Test Frequency: 2402MHz

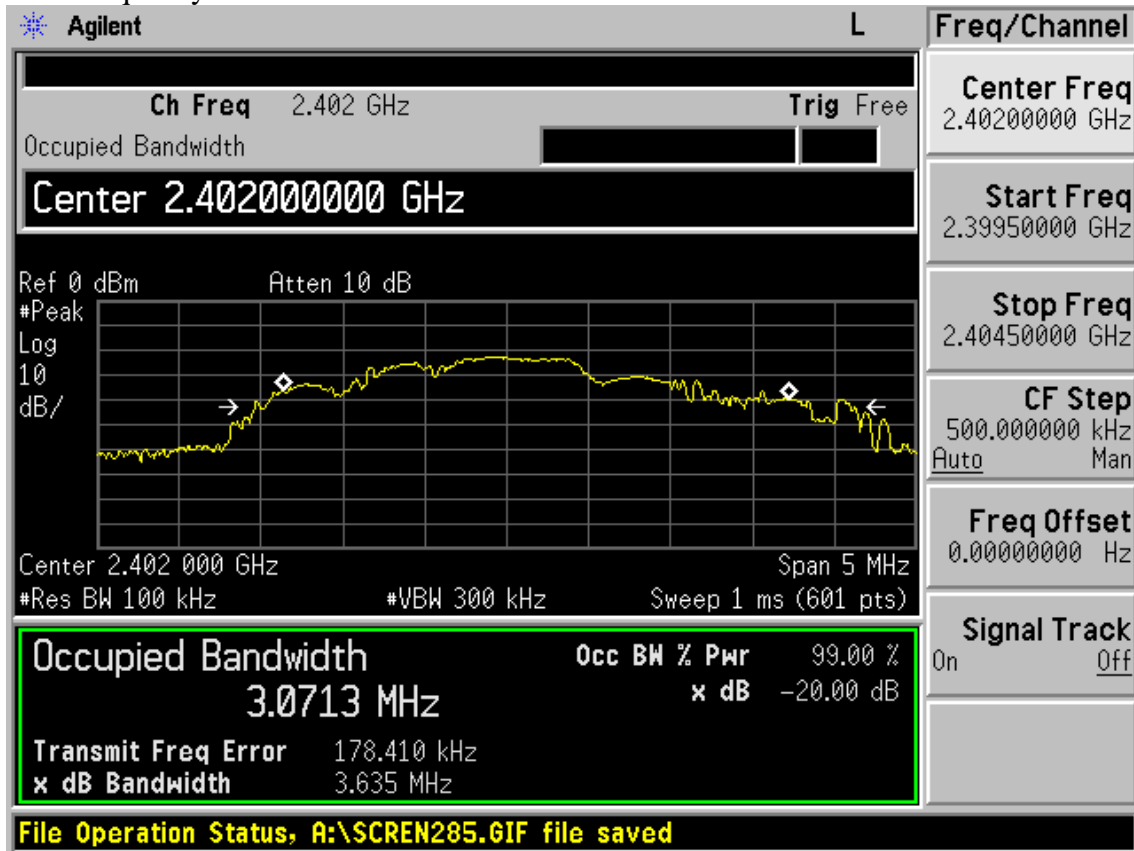

Test Frequency: 2439MHz

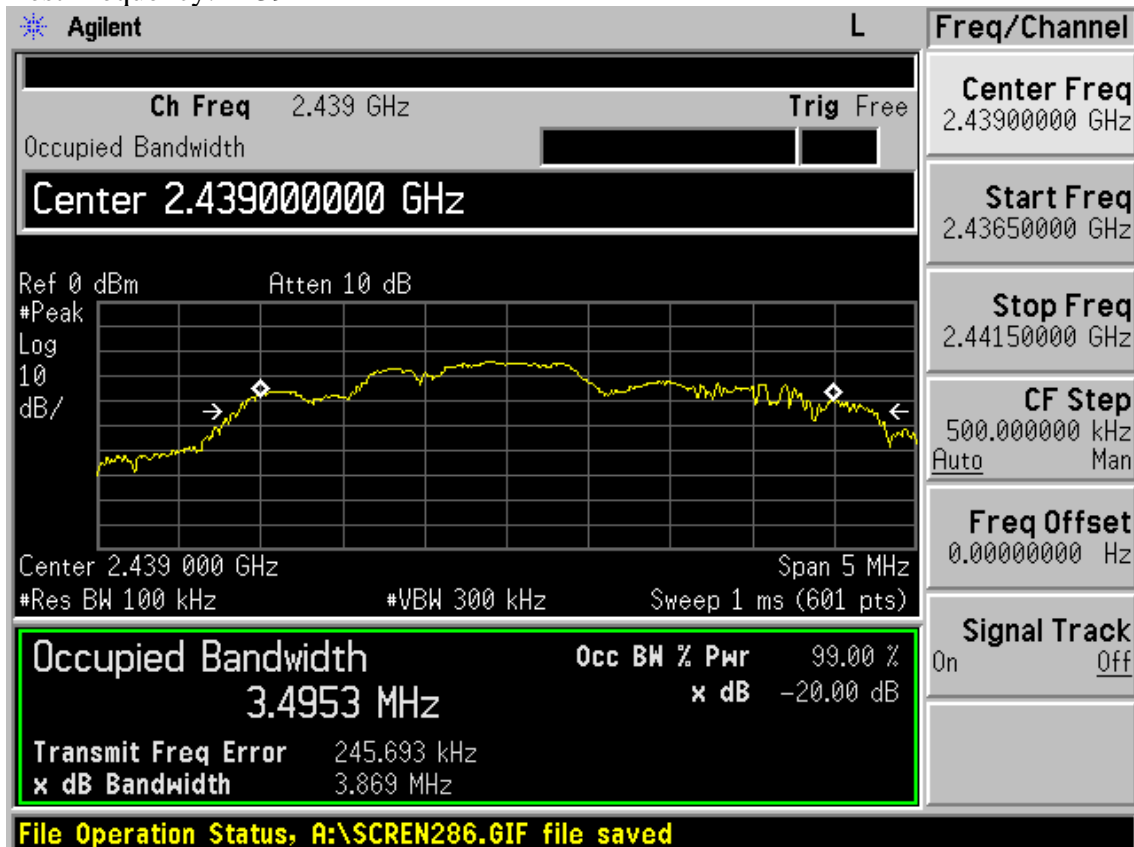

Test Frequency: 2479MHz

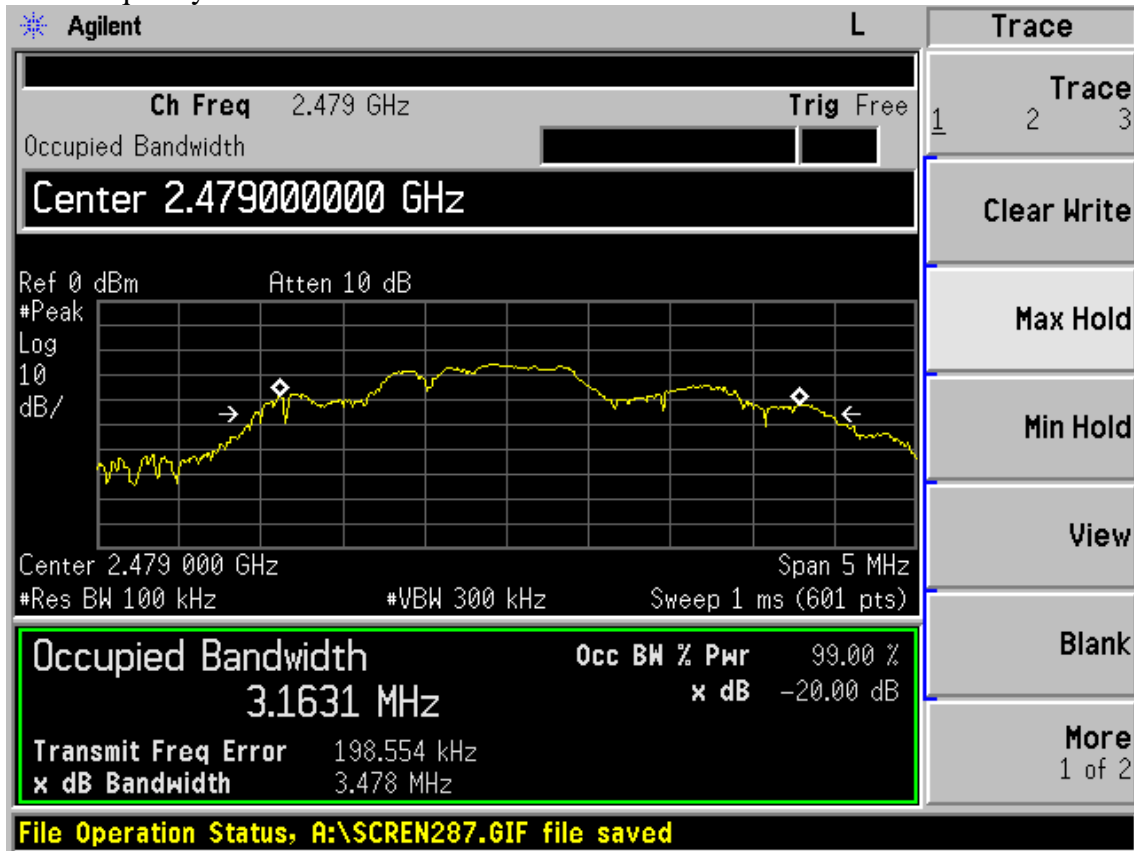

6. BAND EDGE COMPLIANCE TEST

6.1. Test Equipment

Item	Equipment	Manufacturer	Model No.	Serial No.	Last Cal.	Cal. Interval
1.	Spectrum	Agilent	E4446A	US44300459	May.08, 12	1 Year
2.	Amp	HP	8449B	3008A08495	May.08, 12	1 Year
3.	Antenna	EMCO	3115	9510-4580	May.31, 11	1Year
4.	HF Cable	Hubersuhne	Sucoflex104	-	May.08, 12	1 Year

6.2. Limit

All the lower and upper band-edges emissions appearing within 2310MHz to 2390MHz and 2483.5MHz to 2500MHz restricted frequency bands shall not exceed the limits shown in 15.209, all the other emissions outside operation frequency band 2400MHz to 2483.5MHz shall be at least 20dB below the fundamental emissions, or comply with 15.209 limits.

6.3. Test Produce

1. The EUT is placed on a turntable, which is 0.8m above the ground plane and worked at highest radiated power.
2. The turntable was rotated for 360 degrees to determine the position of maximum emission level.
3. EUT is set 3m away from the receiving antenna, which is varied from 1m to 4m to find out the highest emission.
4. Set the spectrum analyzer in the following setting in order to capture the lower and upperband-edges of the emission:
 - (a) PEAK: RBW=1MHz ;VBW=3MHz, PK detector, Sweep=AUTO
 - (b)This device is pulse modulated, a duty cycle factor was used to calculate average level based measured peak level

6.4. Test Results

Pass (The testing data was attached in the next pages.)

Note: If the PK measured levels comply with average limit, then the average level were deemed to comply with average limit.

Note: The duty cycle factor for calculate average level is 20.23dB, and average limit is 20dB below peak limit, so if peak measured level comply with peak limit, the average level was deemed to comply with average limit.

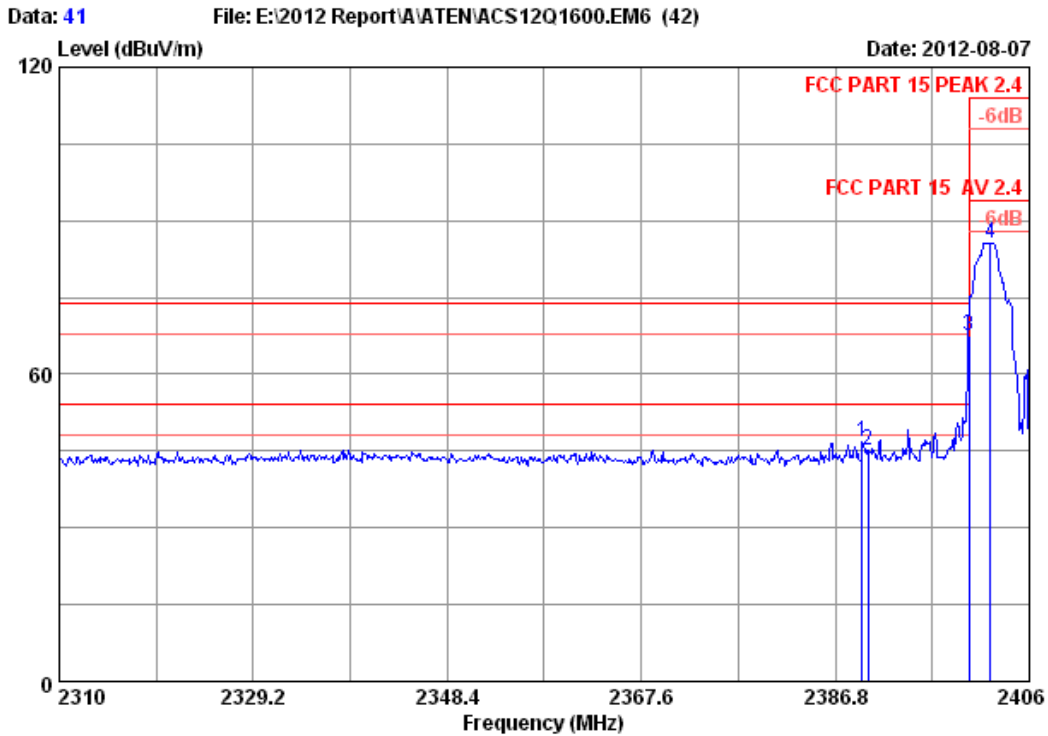

Site no. : 3m Chamber Data no. : 41
 Dis. / Ant. : 3m 2011 3115 4580 Ant. pol. : HORIZONTAL
 Limit : FCC PART 15 PEAK 2.4
 Env. / Ins. : 23°C/54% Engineer : Leo-Li
 EUT : E7 Wireless Receiver
 Power supply : DC 5V From PC Input AC 230V/50Hz
 Test mode : GFSK 2402MHz Tx Mode
 M/N : GME557R

	Freq. (MHz)	Ant. Factor (dB/m)	Cable loss (dB)	Amp. Factor (dB)	Reading (dBuV)	Emission Level (dBuV/m)	Limits (dBuV/m)	Margin (dB)	Remark
1	2389.488	27.96	6.01	34.44	47.39	46.92	74.00	27.08	Peak
2	2390.000	27.96	6.01	34.44	45.63	45.16	74.00	28.84	Peak
3	2400.000	27.96	6.01	34.44	67.87	67.40	74.00	6.60	Peak
4	2402.160	27.96	6.01	34.44	86.18	85.71	114.00	28.29	Peak

Remarks:

1. Emission Level= Antenna Factor + Cable Loss -Amp Factor + Reading.
2. The emission levels that are 20dB below the official limit are not reported.

Frequency (MHz)	Peak level (dBuV/m)	Duty cycle factor (dB)	AV level (dBuV/m)	Limit(dBuV/m)	Conclusion
2400	67.40	20.23	47.17	54	Pass

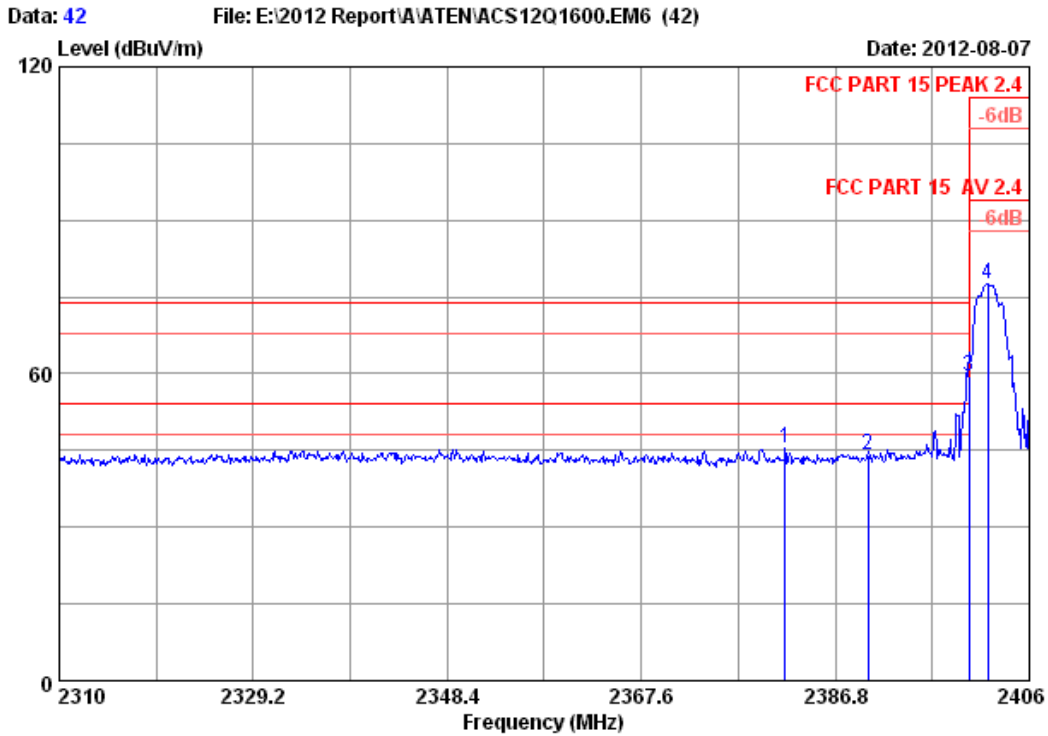

Site no. : 3m Chamber Data no. : 42
 Dis. / Ant. : 3m 2011 3115 4580 Ant. pol. : VERTICAL
 Limit : FCC PART 15 PEAK 2.4
 Env. / Ins. : 23°C/54% Engineer : Leo-Li
 EUT : E7 Wireless Receiver
 Power supply : DC 5V From PC Input AC 230V/50Hz
 Test mode : GFSK 2402MHz Tx Mode
 M/N : GME557R

	Ant. Factor (dB/m)	Cable loss (dB)	Amp. Factor (dB)	Reading (dBuV)	Emission Level (dBuV/m)	Limits (dBuV/m)	Margin (dB)	Remark
1 2381.808	27.93	5.98	34.44	45.96	45.43	74.00	28.57	Peak
2 2390.000	27.96	6.01	34.44	44.54	44.07	74.00	29.93	Peak
3 2400.000	27.96	6.01	34.44	60.10	59.63	74.00	14.37	Peak
4 2401.872	27.96	6.01	34.44	77.88	77.41	114.00	36.59	Peak

Remarks:

1. Emission Level= Antenna Factor + Cable Loss -Amp Factor + Reading.
2. The emission levels that are 20dB below the official limit are not reported.

Frequency (MHz)	Peak level (dBuV/m)	Duty cycle factor (dB)	AV level (dBuV/m)	Limit(dBuV/m)	Conclusion
2400	59.63	20.23	39.40	54	Pass

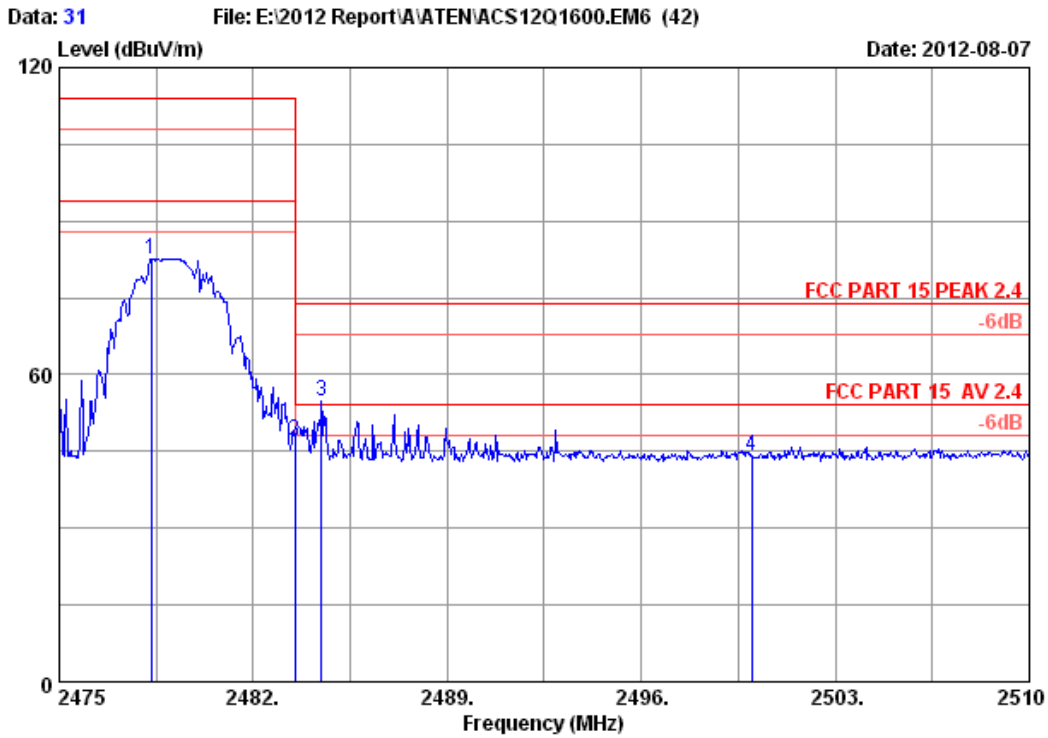

Site no. : 3m Chamber Data no. : 31
 Dis. / Ant. : 3m 2011 3115 4580 Ant. pol. : HORIZONTAL
 Limit : FCC PART 15 PEAK 2.4
 Env. / Ins. : 23°C/54% Engineer : Leo-Li
 EUT : E7 Wireless Receiver
 Power supply : DC 5V From PC Input AC 230V/50Hz
 Test mode : GFSK 2479MHz Tx Mode
 M/N : GME557R

	Freq. (MHz)	Ant. Factor (dB/m)	Cable loss (dB)	Amp. Factor (dB)	Emission Reading (dBuV)	Emission Level (dBuV/m)	Limits (dBuV/m)	Margin (dB)	Remark
1	2478.325	28.08	6.15	34.45	82.81	82.59	114.00	31.41	Peak
2	2483.500	28.08	6.15	34.45	47.24	47.02	74.00	26.98	Peak
3	2484.450	28.08	6.15	34.45	55.01	54.79	74.00	19.21	Peak
4	2500.000	28.10	6.18	34.45	44.32	44.15	74.00	29.85	Peak

Remarks:

- Emission Level= Antenna Factor + Cable Loss -Amp Factor + Reading.
- The emission levels that are 20dB below the official limit are not reported.

Frequency (MHz)	Peak level (dBuV/m)	Duty cycle factor (dB)	AV level (dBuV/m)	Limit(dBuV/m)	Conclusion
2484.450	54.79	20.23	34.56	54	Pass

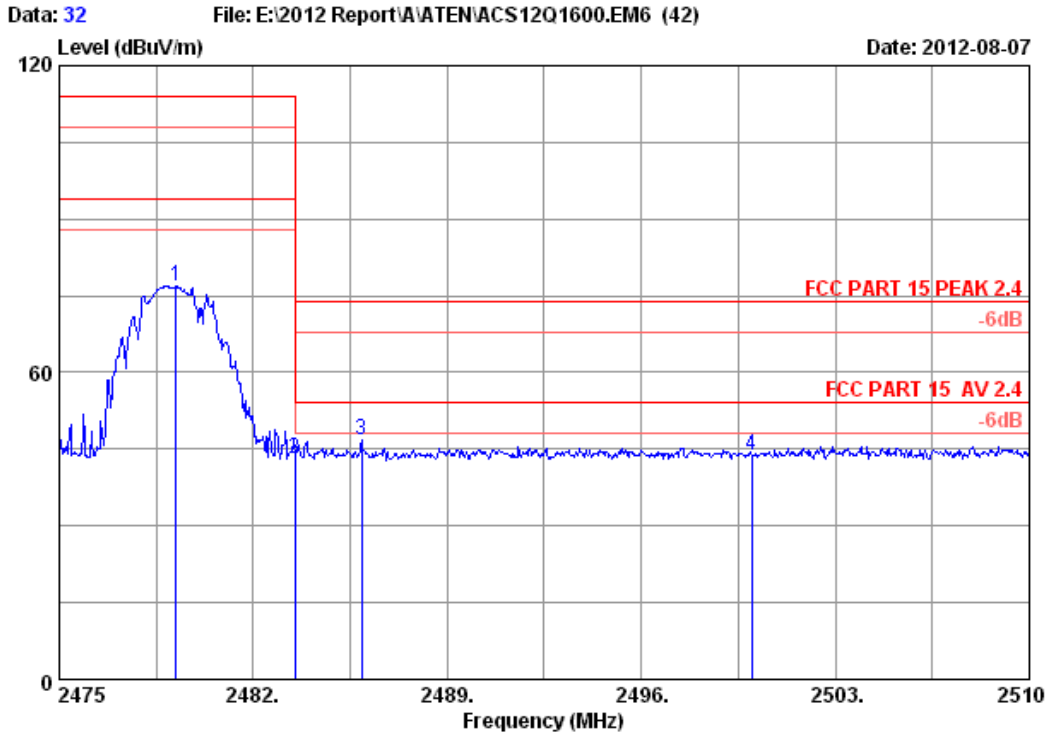

Site no. : 3m Chamber Data no. : 32
 Dis. / Ant. : 3m 2011 3115 4580 Ant. pol. : VERTICAL
 Limit : FCC PART 15 PEAK 2.4
 Env. / Ins. : 23°C/54% Engineer : Leo-Li
 EUT : E7 Wireless Receiver
 Power supply : DC 5V From PC Input AC 230V/50Hz
 Test mode : GFSK 2479MHz Tx Mode
 M/N : GME557R

	Freq. (MHz)	Ant. Factor (dB/m)	Cable loss (dB)	Amp. Factor (dB)	Reading (dBuV)	Emission Level (dBuV/m)	Limits (dBuV/m)	Margin (dB)	Remark
1	2479.200	28.08	6.15	34.45	77.01	76.79	114.00	37.21	Peak
2	2483.500	28.08	6.15	34.45	43.50	43.28	74.00	30.72	Peak
3	2485.920	28.08	6.15	34.45	47.07	46.85	74.00	27.15	Peak
4	2500.000	28.10	6.18	34.45	44.05	43.88	74.00	30.12	Peak

Remarks:

1. Emission Level= Antenna Factor + Cable Loss -Amp Factor + Reading.
2. The emission levels that are 20dB below the official limit are not reported.

7. ANTENNA REQUIREMENT

RESULT : **PASS**

Test Date : Aug.06, 2012

Test standard : FCC Part 15.203

Limit : the use of antennas with directional gains that do not exceed 6 dBi

According to the manufacturer declared, the EUT has an internal antenna, the directional gain of antenna is 0dBi, and the antenna connector is designed with permanent attachment and no consideration of replacement. Therefore the EUT is considered sufficient to comply the provision.

8. RADIO FRREQUENCY EXPOSURE COMPLIANCE

RESULT : **PASS**

Test standard : FCC KDB Publication 447498

Since maximum peak output power of the transmitter is $<60/f(\text{GHz})\text{mW}$,
i.e. $0.009346\text{mW} < 25(=60/2.4)\text{mW}$, hence the EUT is excluded from SAR evaluation according
to FCC KDB Publication 447498 D01:Mobile Portable RF Exposure.

9. TEST SOFTWARE

Manufacturer : G. tech Technology Ltd.

Version : Fuhlen Bind V1.1

The test software is used to control EUT work in TX mode and to change the test channel.

10.DEVIATION TO TEST SPECIFICATIONS

[NONE]