



Spectrum Research & Testing Lab., Inc.
No. 101-10, Ling 8,
Shan-Tong Li, Chung-Li
City, Taoyuan, Taiwan

TEST REPORT

Reference No.: A06122211
Report No.: FCCA06122211
FCC ID: QLEGBU241
Page: 1 of 52
Date: Jan. 03, 2007

Product Name: Bluetooth 2.0 EDR Enhanced Data Rate
USB Adapter, class 2

Model Number: GBU241, GBU241WM, GBU241W1, GBU241W2,
GBU241W3, GBU241W4, GBU241W5, GBU241W6,
GBU241W7, GBU241W8, GBU241W9, GBU241P

Applicant: IOGEAR, Inc. / 23 Hubble, Irvine, CA 92618, USA
Manufacturer: ATake Co. Ltd. / No.365-2, Chung Shan
Rd., Shan-Hsia Town, Taipei Hsien, Taiwan 237.

Date of Receipt: Dec. 22, 2006

Finished date of Test: Jan. 03, 2007

Applicable Standards: 47 CFR Part 15, Subpart C
ANSI C63.4:2003

We, **Spectrum Research & Testing Laboratory Inc.**, hereby certify that one sample of the above was tested in our laboratory with positive results according to the above-mentioned standards. The records in the report are an accurate account of the results. Details of the results are given in the subsequent pages of this report.

Tested By : Roger Horng , **Date:** Jan. 03, 2007
(Roger Horng)

Approved By : Johnson Ho , **Date:** 1/3/2007
(Johnson Ho, Director)

NVLAQ®

Lab Code: 200099-0



TABLE OF CONTENTS

1. DOCUMENT POLICY AND TEST STATEMENT.....	4
1.1 DOCUMENT POLICY.....	4
1.2 TEST STATEMENT	4
1.3 EUT MODIFICATION	4
2. DESCRIPTION OF EUT AND TEST MODE.....	5
2.1 GENERAL DESCRIPTION OF EUT.....	5
2.2 DESCRIPTION OF SUPPORT UNIT.....	6
2.3 DESCRIPTION OF TEST MODE	6
3. DESCRIPTION OF APPLIED STANDARDS.....	7
4. TECHNICAL CHARACTERISTICS TEST.....	8
4.1 CHANNEL SEPARATION TEST	8
4.1.1 LIMIT	8
4.1.2 TEST EQUIPMENT	8
4.1.3 TEST SET-UP.....	8
4.1.4 TEST PROCEDURE.....	8
4.1.5 EUT OPERATING CONDITION	9
4.1.6 TEST RESULT	9
4.2 20dB BANDWIDTH.....	13
4.2.1 LIMIT	13
4.2.2 TEST EQUIPMENT	13
4.2.3 TEST SET-UP.....	13
4.2.4 TEST PROCEDURE.....	13
4.2.5 EUT OPERATING CONDITION	13
4.2.6 TEST RESULT	14
4.3 QUANTITY OF HOPPING CHANNEL TEST	18
4.3.1 LIMIT	18
4.3.2 TEST EQUIPMENT	18
4.3.3 TEST SET-UP.....	18
4.3.4 TEST PROCEDURE.....	18
4.3.5 EUT OPERATING CONDITION	18
4.3.6 TEST RESULT	19
4.4 TIME OF OCCUPANCY (DWELL TIME).....	20
4.4.1 LIMIT	20
4.4.2 TEST EQUIPMENT	20
4.4.3 TEST SET-UP.....	20
4.4.4 TEST PROCEDURE.....	20
4.4.5 EUT OPERATING CONDITION	20
4.4.6 TEST RESULT	21
4.5 PEAK POWER TEST	25
4.5.1 LIMIT	25



TEST REPORT

4.5.2	TEST EQUIPMENT	25
4.5.3	TEST SET-UP.....	26
4.5.4	TEST PROCEDURE.....	26
4.5.5	EUT OPERATING CONDITION	26
4.5.6	TEST RESULT	26
4.6	BAND EDGE TEST	30
4.6.1	LIMIT	30
4.6.2	TEST EQUIPMENT	31
4.6.3	TEST SET-UP.....	32
4.6.4	TEST PROCEDURE.....	33
4.6.5	EUT OPERATING CONDITION	33
4.6.6	TEST RESULT	33
4.7	SPURIOUS RADIATED EMISSION TEST	36
4.7.1	LIMIT	36
4.7.2	TEST EQUIPMENT	37
4.7.3	TEST SET-UP.....	38
4.7.4	TEST PROCEDURE.....	39
4.7.5	EUT OPERATING CONDITION	39
4.7.6	TEST RESULT	40
4.8	CONDUCTED EMISSION TEST	45
4.8.1	CONDUCTED EMISSION LIMIT	45
4.8.2	TEST EQUIPMENT	45
4.8.3	TEST SETUP.....	46
4.8.4	TEST PROCEDURE.....	46
4.8.5	TEST RESULT	47
5.	ANTENNA APPLICATION	48
5.1	ANTENNA REQUIREMENT	48
5.2	RESULT.....	48
6.	PHOTOS OF TESTING	49
7.	TERMS OF ABBREVIATION	52



**Spectrum Research &
Testing Lab., Inc.**
No. 101-10, Ling 8,
Shan-Tong Li, Chung-Li
City, Taoyuan, Taiwan

TEST REPORT

Reference No.: A06122211
Report No.: FCCA06122211
FCC ID: QLEGBU241
Page:4 of 52
Date: Jan. 03, 2007

1. DOCUMENT POLICY AND TEST STATEMENT

1.1 DOCUMENT POLICY

- The report shall not be reproduced except in full, without the written approval of SRT Lab, Inc.

1.2 TEST STATEMENT

- The test results in the report apply only to the unit tested by SRT Lab.
- There was no deviation from the requirements of test standards during the test.
- AC power source, 120 VAC/60 Hz, was used during the test.

1.3 EUT MODIFICATION

- No modification in SRT Lab.



2. DESCRIPTION OF EUT AND TEST MODE

2.1 GENERAL DESCRIPTION OF EUT

Product	Bluetooth 2.0 EDR Enhanced Data Rate USB Adapter, class 2
Model No.	GBU241, GBU241WM, GBU241W1, GBU241W2, GBU241W3, GBU241W4, GBU241W5, GBU241W6, GBU241W7, GBU241W8, GBU241W9, GBU241P
Power Supply	DC 3.3 V, 70 mA
Cable	N/A
Frequency Band	2.402~2.480 GHz
Carrier Frequency	2.441 GHz
Number of Channel	79
Channel Spacing	1 MHz
Rated RF Output Power	0 dBm(1mW)
I.F. & L.O.	I.F.:1.5 MHz ,L.O.:16 MHz
Modulation Type	DQPSK
Duty Cycle	50%
Bit Rate of Transmission	3 Mbps
Operation Temperature Range	-25~75°C
Mode of Operation	Duplex
Antenna Type	Micro-strip Line
Antenna Gain	2 dBi

NOTE :

For more detailed information, please refer to the EUT's specification or user's manual provided by manufacturer.

Difference : Difference in housing only.



2.2 DESCRIPTION OF SUPPORT UNIT

The transmitter part of EUT was tested with a PC system and configured by the requirement of ANSI C63.4. All interface ports were connected to the appropriate support units via specific cables. The support units and cables are listed below.

No	Device	Brand	Model #	FCC ID/DoC	Cable
1	Notebook	Compaq	Presario B2000	DOC	1.6m unshielded power cord
2	Printer	HP	Deskjet 3420	DOC	1.5m unshielded power cord 1.5m shielded data cable
3	Monitor	Samsung	700IFT	DOC	1.6m unshielded DC power cable 1.5m shielded data cable
4	Bluetooth Headset	Sony Ericsson	HBH-610A	DOC	N/A
5	Mouse	Dell	M056UOA	DOC	1.5m shielded data cable

NOTE : For the actual test configuration, please refer to the photos of testing.

2.3 DESCRIPTION OF TEST MODE

This EUT is a FHSS system, we use CSR's(Cambridge Silicon Radio) BlueTest software to control the EUT through USB interface, let frequency hopping transmitter hopping on a single channel (or every channel) with the highest power level available. Spurious emission was measured with radiated method and other tests were measured with conducted methods. The EUT(Bluetooth system) is operating in the 2.4GHz ISM(Industrial Scientific Medicine) band with specific 79 hopping channels. Three channels of lower, medium and higher frequency were chosen for test.

Channel	Frequency(MHz)
0	2402
39	2441
78	2480

NOTE :

1. Below 1 GHz, the channel 0, 39 and 78 were pre-tested in chamber. The channel 78, worst case one, was chosen for conducted and radiated emission test.
2. Above 1 GHz, the channel 0, 39 and 78 were tested individually.



**Spectrum Research &
Testing Lab., Inc.**
No. 101-10, Ling 8,
Shan-Tong Li, Chung-Li
City, Taoyuan, Taiwan

TEST REPORT

Reference No.: A06122211
Report No.: FCCA06122211
FCC ID: QLEGBU241
Page:7 of 52
Date: Jan. 03, 2007

3. DESCRIPTION OF APPLIED STANDARDS

The EUT is a kind of wireless product and to be connected with a PC system for normal use. According to the specifications provided by the applicant, it must comply with the requirements of the following standards:

47 CFR Part 15, Subpart C

ANSI C63.4: 2003

Public DA00-705 (March 2000)

All tests have been performed and recorded as the above standards.



4. TECHNICAL CHARACTERISTICS TEST

4.1 CHANNEL SEPARATION TEST

4.1.1 LIMIT

FCC Part15, Subpart C Section 15.247(a)(1). Frequency hopping systems shall have hopping channel carrier frequencies separated by a minimum of 25 kHz or the 20 dB bandwidth of the hopping channel, whichever is greater.

Frequency Range (MHz)	Limit(kHz)
902-928	>25kHz
2400-2483.5	>25kHz
5725-5850	>25kHz

4.1.2 TEST EQUIPMENT

The following test equipment was used during the radiated emission test :

Equipment/ Facilities	Specifications	Manufacturer	Model#/ Serial#	Due Date of Cal. & Cal. Center
SPECTRUM	9kHz-7GHz	ROHDE & SCHWARZ	FSP7/ 839511/010	MAR. 2007 ETC

NOTE: The calibration interval of the above test equipment is one year and the calibrations are traceable to NML/ROC and NIST/USA.

4.1.3 TEST SET-UP

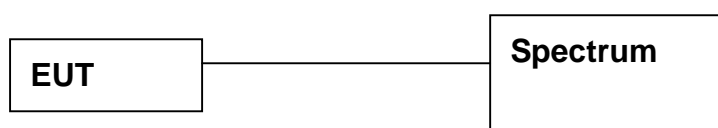

The EUT was connected to a spectrum through a 50Ω RF cable.

4.1.4 TEST PROCEDURE

The EUT was operating in hopping mode or could be controlled its channel. Printed out the test result from the spectrum by hard copy function.



Spectrum Research & Testing Lab., Inc.
No. 101-10, Ling 8,
Shan-Tong Li, Chung-Li
City, Taoyuan, Taiwan

TEST REPORT

Reference No.: A06122211
Report No.: FCCA06122211
FCC ID: QLEGBU241
Page:9 of 52
Date: Jan. 03, 2007

4.1.5 EUT OPERATING CONDITION

1. Set the EUT under transmission condition continuously at a specific channel frequency.
2. The EUT was set to the highest available power level.

4.1.6 TEST RESULT

Temperature:	<u>25°C</u>	Humidity:	<u>65%RH</u>
Spectrum Detector:	<u>PK</u>	Tested by:	<u>Roger Horng</u>
Test Result:	<u>PASS</u>	Tested Date:	<u>Jan.02,2007</u>

Channel Number	Channel Frequency (MHz)	Separation Read Value (kHz)	Minimum Limit(20dB Bandwidth) (kHz)
0	2402	1000.000	832
39	2441	1000.000	824
78	2480	1000.000	824



Spectrum Research & Testing Lab., Inc.
No. 101-10, Ling 8,
Shan-Tong Li, Chung-Li
City, Taoyuan, Taiwan

TEST REPORT

Reference No.: A06122211
Report No.: FCCA06122211
FCC ID: QLEGBU241
Page:10 of 52
Date: Jan. 03, 2007

CH0:

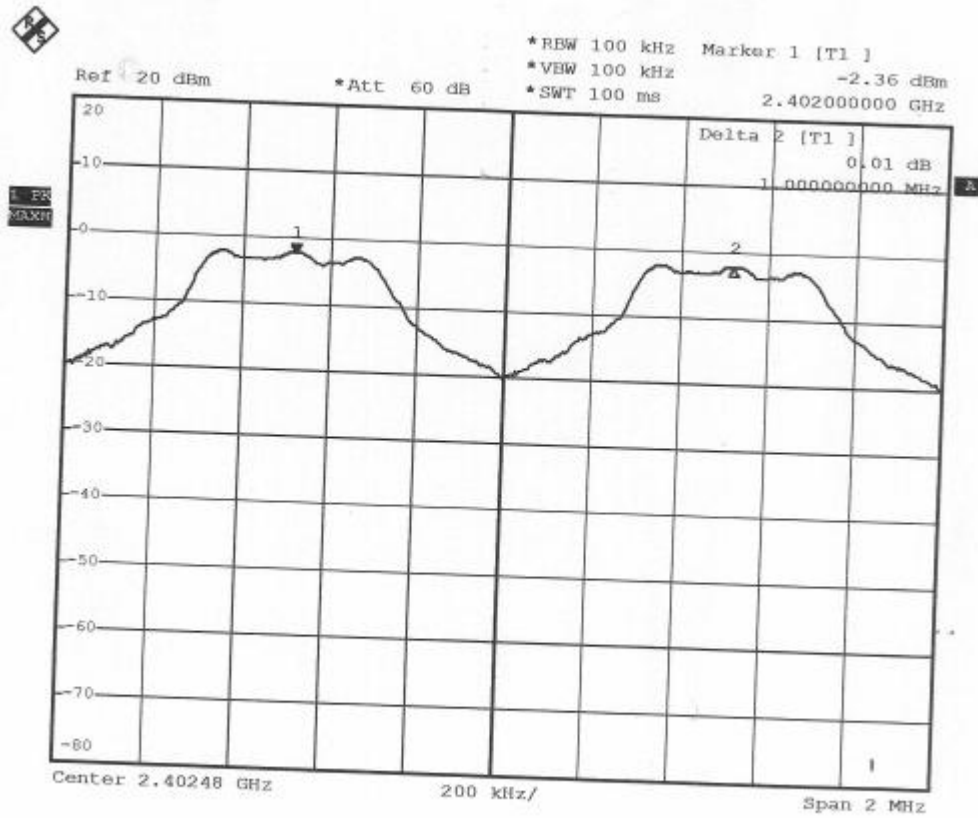

Date: 2.JAN.2007 08:11:04



Spectrum Research & Testing Lab., Inc.
No. 101-10, Ling 8,
Shan-Tong Li, Chung-Li
City, Taoyuan, Taiwan

TEST REPORT

Reference No.: A06122211
Report No.: FCCA06122211
FCC ID: QLEGBU241
Page:11 of 52
Date: Jan. 03, 2007

CH39:

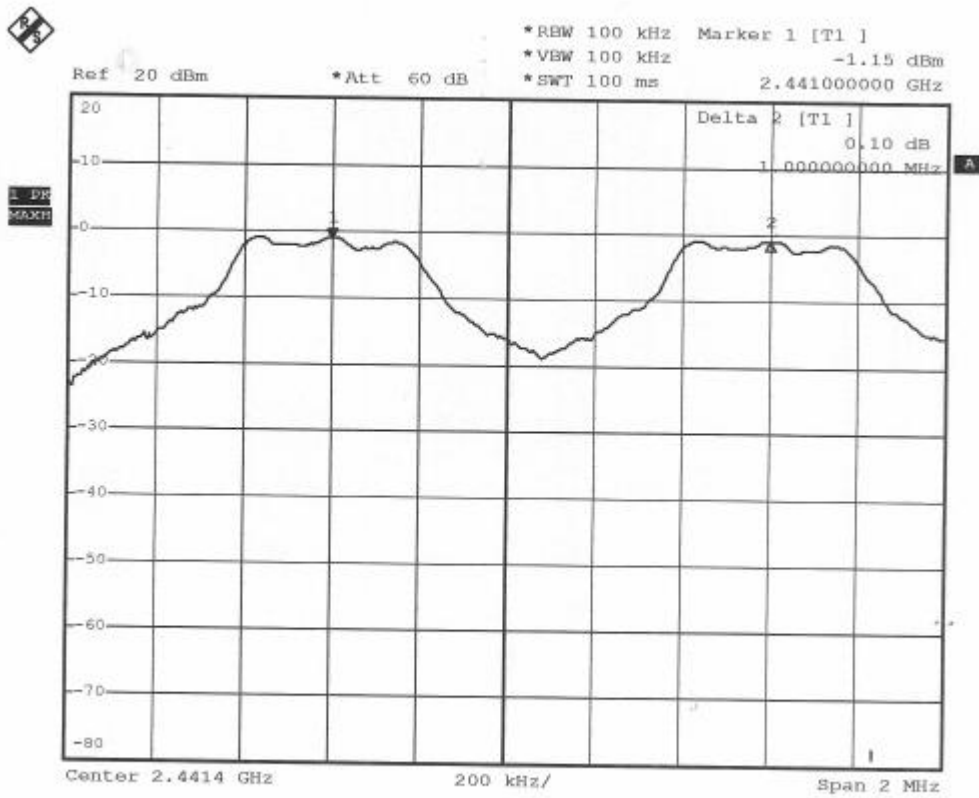

Date: 2.JAN.2007 08:09:24



Spectrum Research & Testing Lab., Inc.
No. 101-10, Ling 8,
Shan-Tong Li, Chung-Li
City, Taoyuan, Taiwan

TEST REPORT

Reference No.: A06122211
Report No.: FCCA06122211
FCC ID: QLEGBU241
Page:12 of 52
Date: Jan. 03, 2007

CH78:

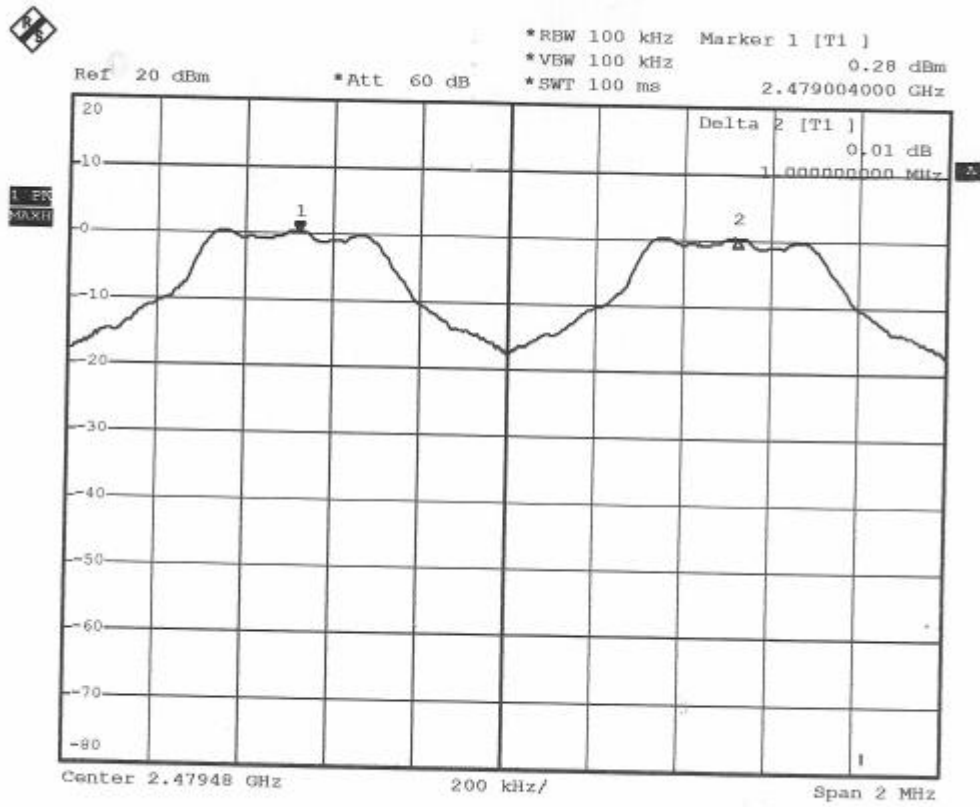

Date: 2.JAN.2007 08:12:38



4.2 20dB Bandwidth

4.2.1 LIMIT

Frequency Range (MHz)	Quantity of Hopping Channel	Limit(kHz)			
		50	25	15	75
902-928		<250	>250	NA	NA
2400-2483.5		NA	NA	>1000	<1000

4.2.2 TEST EQUIPMENT

The following test equipment was used during the test:

Equipment/Facilities	Specifications	Manufacturer	Model#/Serial#	Due Date of Cal. & Cal. Center
SPECTRUM	9kHz-7GHz	ROHDE & SCHWARZ	FSP7/ 839511/010	MAR. 2007 ETC

NOTE: The calibration interval of the above test equipment is one year and the calibrations are traceable to NML/ROC and NIST/USA.

4.2.3 TEST SET-UP

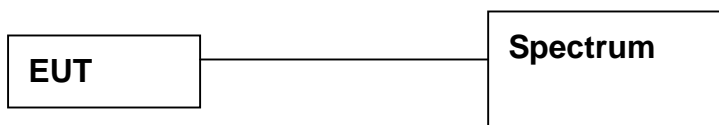

The EUT was connected to a spectrum through a 50Ω RF cable.

4.2.4 TEST PROCEDURE

The EUT was operating in hopping mode or could be controlled its channel. Printed out the test result from the spectrum by hard copy function.

4.2.5 EUT OPERATING CONDITION

Same as section 4.1.5 of this report.



Spectrum Research & Testing Lab., Inc.
No. 101-10, Ling 8,
Shan-Tong Li, Chung-Li
City, Taoyuan, Taiwan

TEST REPORT

Reference No.: A06122211
Report No.: FCCA06122211
FCC ID: QLEGBU241
Page:14 of 52
Date: Jan. 03, 2007

4.2.6 TEST RESULT

Temperature: 25°C Humidity: 65%RH
Spectrum Detector: PK Tested by: Roger Horng
Test Result: PASS

Channel Number	Channel Frequency (MHz)	20dB Bandwidth (kHz)
0	2402	832
39	2441	824
78	2480	828



Spectrum Research & Testing Lab., Inc.
No. 101-10, Ling 8,
Shan-Tong Li, Chung-Li
City, Taoyuan, Taiwan

TEST REPORT

Reference No.: A06122211
Report No.: FCCA06122211
FCC ID: QLEGBU241
Page:15 of 52
Date: Jan. 03, 2007

CH0:

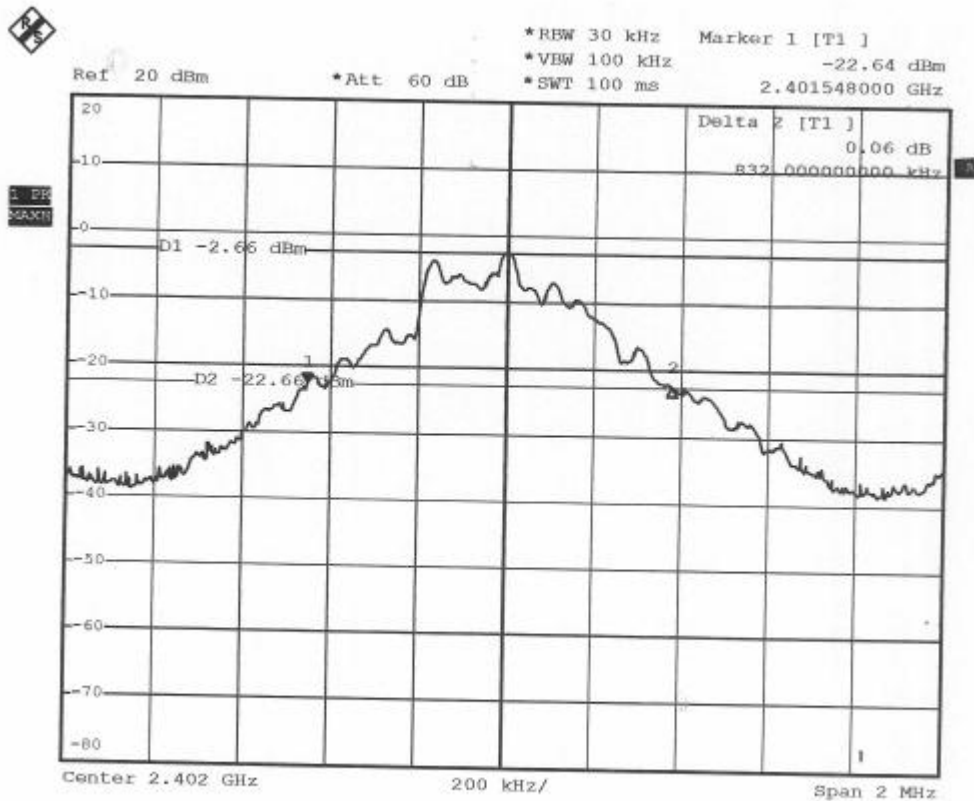

Date: 2.JAN.2007 08:25:04



Ch39:

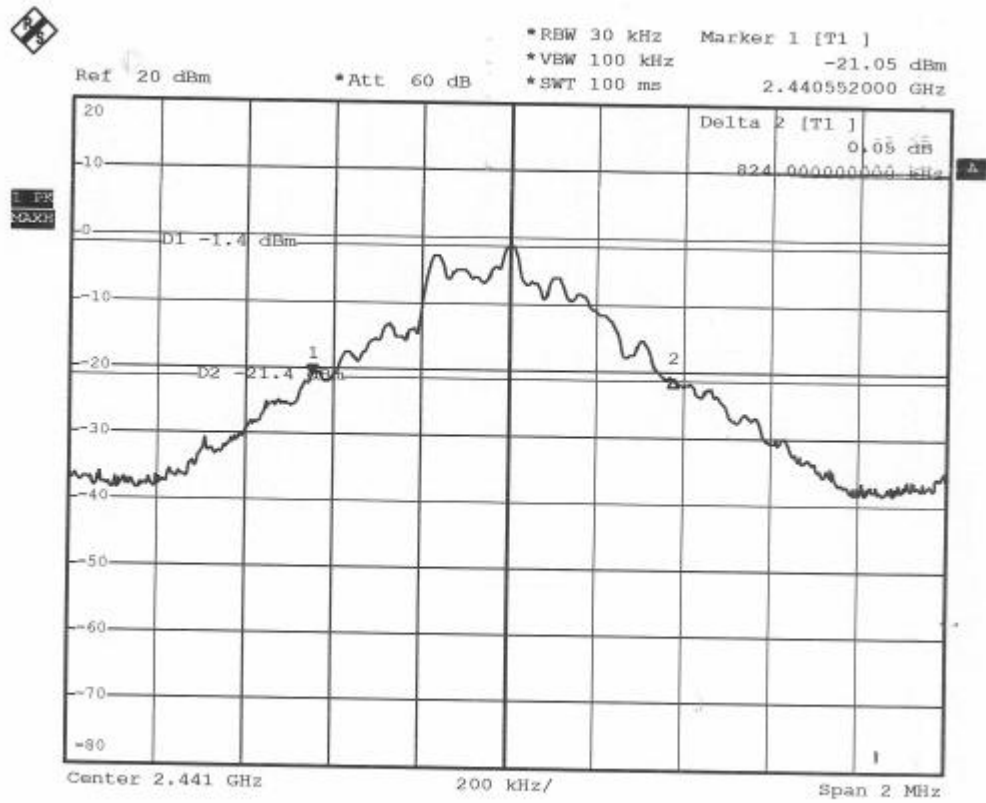

Date: 2.JAN.2007 08:22:11



CH78:

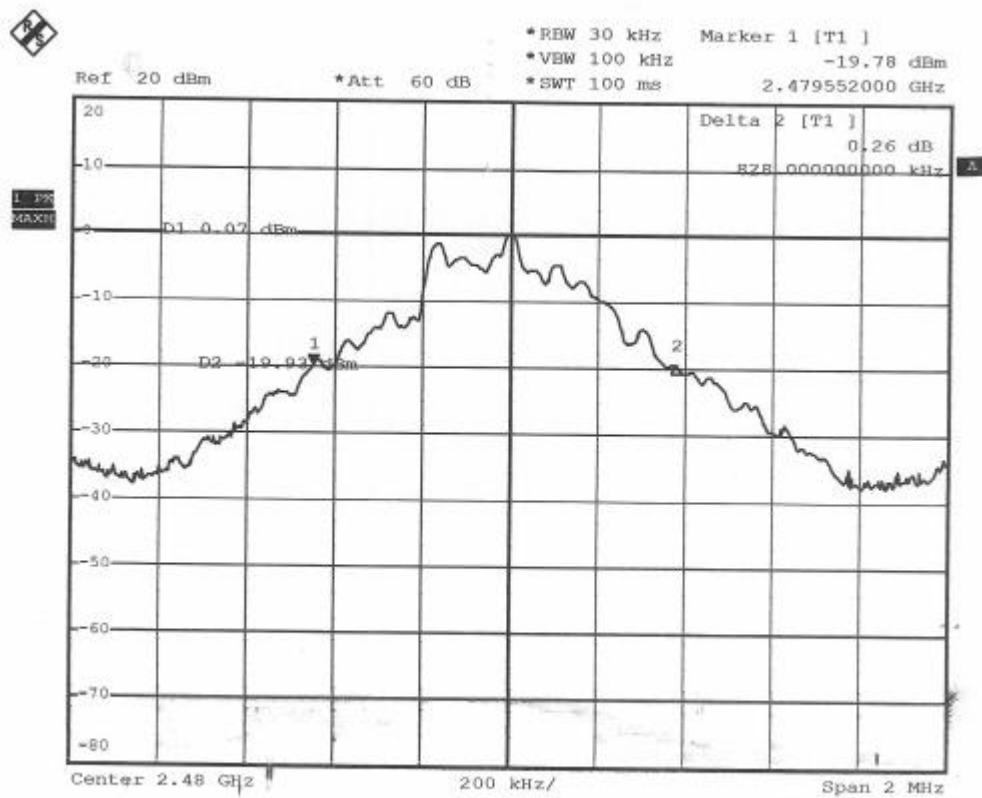

Date: 2.JAN.2007 08:19:23



4.3 QUANTITY OF HOPPING CHANNEL TEST

4.3.1 LIMIT

FCC Part15, Subpart C Section 15.247.

Frequency Range (MHz)	Limit (Quantity of Hopping Channel)			
	20dB Bandwidth <250kHz	20dB Bandwidth >250kHz	20dB Bandwidth <1MHz	20dB Bandwidth >1MHz
902-928	50	25	N/A	N/A
2400-2483.5	N/A	N/A	75	15
5725-5850	N/A	N/A	75	N/A

4.3.2 TEST EQUIPMENT

The following test equipment was used during the test:

Equipment/Facilities	Specifications	Manufacturer	Model#/Serial#	Due Date of Cal. & Cal. Center
SPECTRUM	9kHz-7GHz	ROHDE & SCHWARZ	FSP7/ 839511/010	MAR. 2007 ETC

NOTE: The calibration interval of the above test equipment is one year and the calibrations are traceable to NML/ROC and NIST/USA.

4.3.3 TEST SET-UP

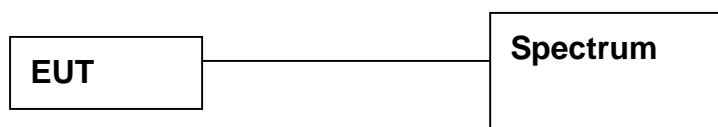

The EUT was connected to a spectrum through a 50Ω RF cable.

4.3.4 TEST PROCEDURE

The EUT was operating in hopping mode or could be controlled its channel. Printed out the test result from the spectrum by hard copy function.

4.3.5 EUT OPERATING CONDITION

1. Set the EUT under frequency hopping transmission condition.
2. The EUT was set to the highest available power level.



Spectrum Research & Testing Lab., Inc.
 No. 101-10, Ling 8,
 Shan-Tong Li, Chung-Li
 City, Taoyuan, Taiwan

TEST REPORT

Reference No.: A06122211
 Report No.: FCCA06122211
 FCC ID: QLEGBU241
 Page:19 of 52
 Date: Jan. 03, 2007

4.3.6 TEST RESULT

Temperature:	<u>25°C</u>	Humidity:	<u>65%RH</u>
Spectrum Detector:	<u>PK</u>	Tested by:	<u>Roger Horng</u>
Test Result:	<u>PASS</u>	Tested Date:	<u>Jan.02,2007</u>

Hopping Channel Frequency Range(MHz)	Quantity of Hopping Channel Read Value	Quantity of Hopping Channel Limit
2402~2480	79	75

CH0-CH78

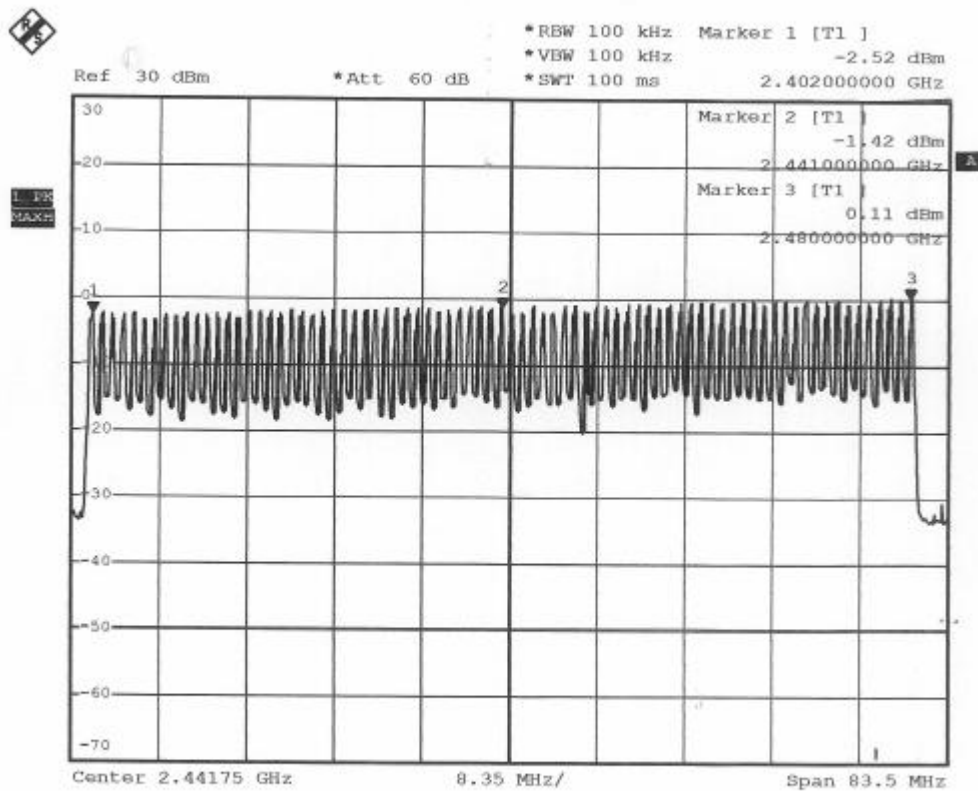

Date: 2.JAN.2007 08:29:56



4.4 TIME OF OCCUPANCY (Dwell Time)

4.4.1 LIMIT

FCC Part15, Subpart C Section 15.247.

Frequency Range (MHz)	Limit (ms)		
	20dB Bandwidth <250kHz(50Channel)	20dB Bandwidth >250kHz(25Channel)	20dB Bandwidth <1MHz(75Channel)
902-928	400(20s)	400(10s)	NA
2400-2483.5	NA	NA	400(30s)
5725-5850	NA	NA	400(30s)

NOTE: The “()” is all channel’s average time of occupancy.

4.4.2 TEST EQUIPMENT

The following test equipment was used during the test:

Equipment/Facilities	Specifications	Manufacturer	Model#/Serial#	Due Date of Cal. & Cal. Center
SPECTRUM	9kHz-7GHz	ROHDE & SCHWARZ	FSP7/ 839511/010	MAR. 2007 ETC

NOTE: The calibration interval of the above test equipment is one year and the calibrations are traceable to NML/ROC and NIST/USA.

4.4.3 TEST SET-UP

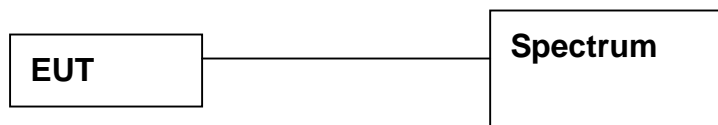

The EUT was connected to a spectrum through a 50Ω RF cable.

4.4.4 TEST PROCEDURE

The EUT was operating in hopping mode or could be controlled its channel. Printed out the test result from the spectrum by hard copy function.

4.4.5 EUT OPERATING CONDITION

Same as section 4.1.5 of this report.



Spectrum Research & Testing Lab., Inc.
No. 101-10, Ling 8,
Shan-Tong Li, Chung-Li
City, Taoyuan, Taiwan

TEST REPORT

Reference No.: A06122211
Report No.: FCCA06122211
FCC ID: QLEGBU241
Page:21 of 52
Date: Jan. 03, 2007

4.4.6 TEST RESULT

Temperature: 25°C Humidity: 65%RH
Spectrum Detector: PK Tested by: Roger Horng
Test Result: PASS Tested Date: Jan.02,2007

Channel Number	Channel Frequency (MHz)	Pulse Time (µs)	Burts (in 1 sec.)	Time of Occupancy (Dwell Time) (ms)	Average Time of Occupancy Limit (ms)
0	2402.00	418	10	132.0	400
39	2441.00	418	10	132.0	400
78	2480.00	418	10	132.0	400



CH0:

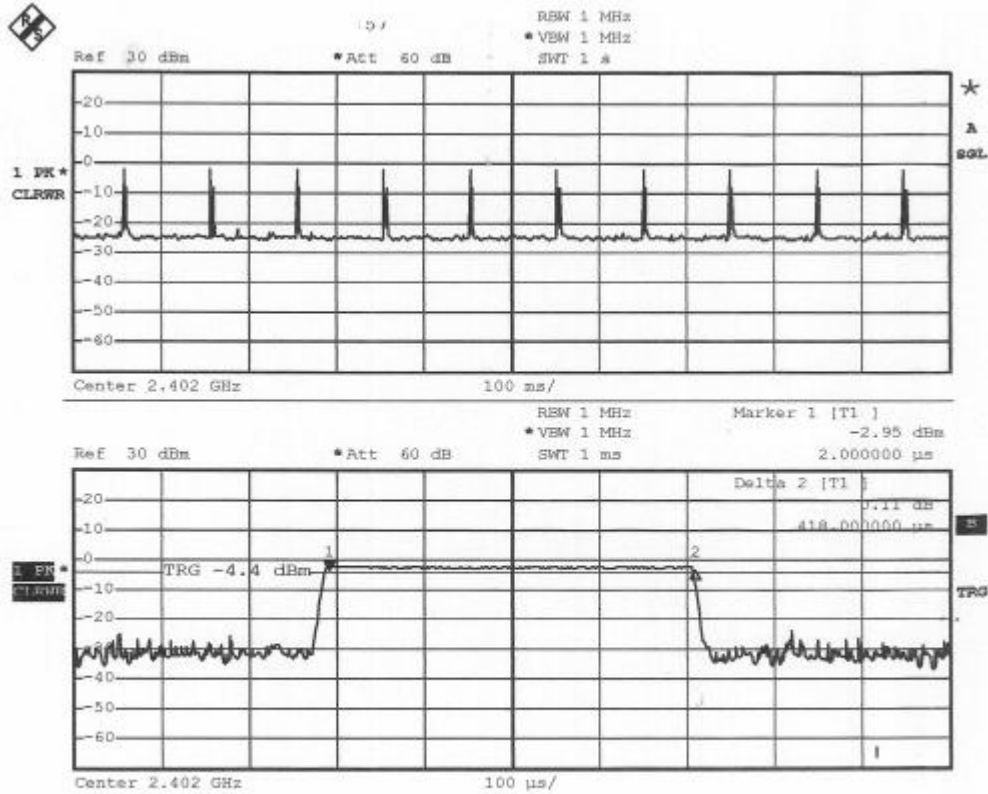

Date: 2.JAN.2007 09:05:56



Ch39:

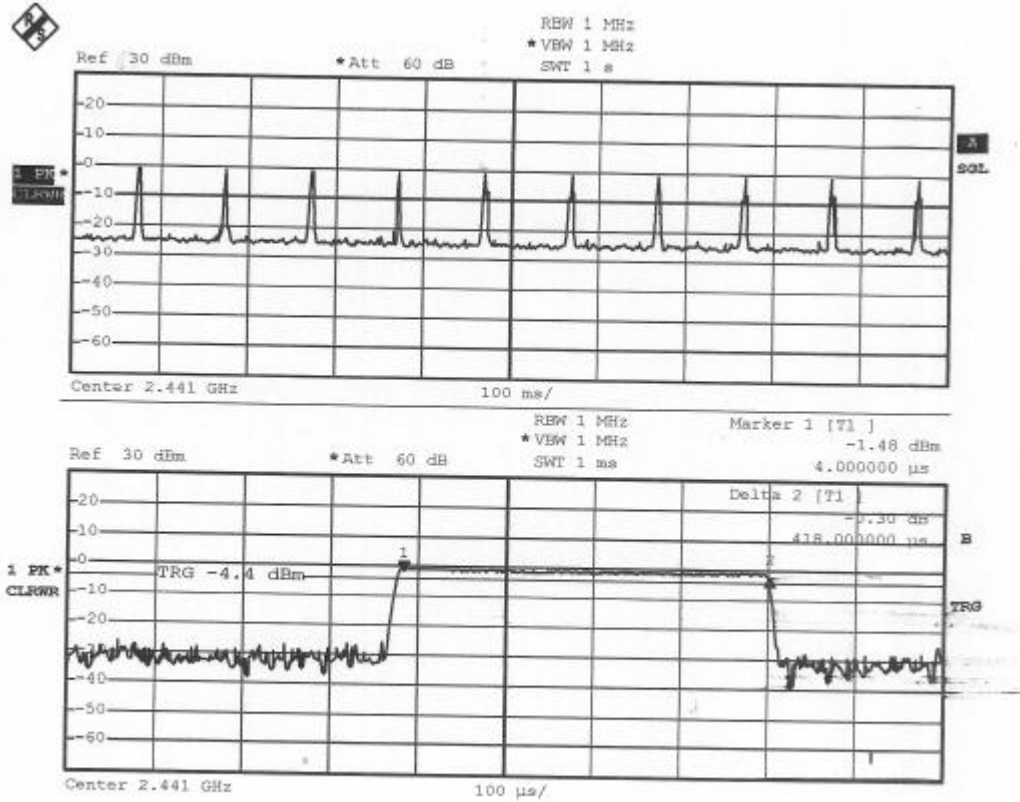

Date: 2.JAN.2007 09:10:03



TEST REPORT

CH78:

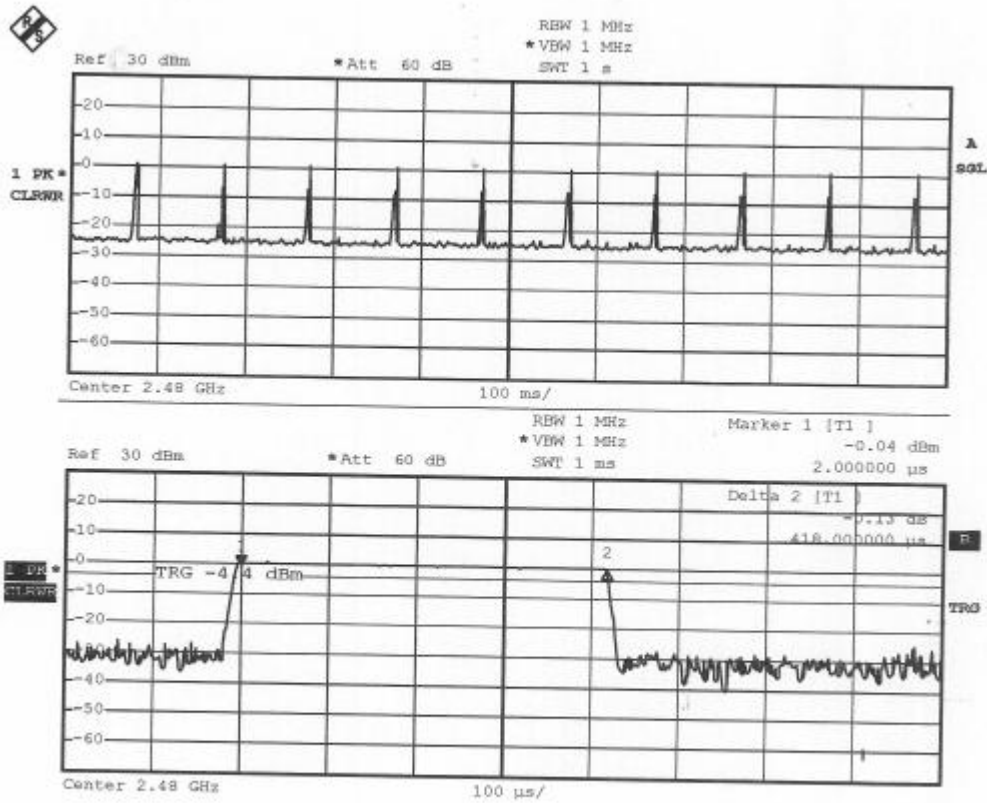

Date: 2.JAN.2007 09:11:48



4.5 PEAK POWER TEST

4.5.1 LIMIT

FCC Part15, Subpart C Section 15.247.

Frequency Range (MHz)	Quantity of Hopping Channel	Limit(w)			
		50	25	15	75
902-928		1(30dBm)	0.125(21dBm)	NA	NA
2400-2483.5		NA	NA	0.125(21dBm)	1(30dBm)
5725-5850		NA	NA	NA	1(30dBm)

4.5.2 TEST EQUIPMENT

The following test equipment was used during the test :

Equipment/Facilities	Specifications	Manufacturer	Model#/Serial#	Due Date of Cal. & Cal. Center
SPECTRUM	9kHz-7GHz	ROHDE & SCHWARZ	FSP7/ 839511/010	MAR. 2007 ETC
POWER METER	N/A	BOONTON	4232A/ 29001	MAY 2007 ETC
POWER SENSOR	DC-18GHz 0.3 μ W-100mW 50 Ω	BOONTON	51011-EMC/ 31184	JUN. 2007 ETC

NOTE: The calibration interval of the above test equipment is one year and the calibrations are traceable to NML/ROC and NIST/USA.



4.5.3 TEST SET-UP

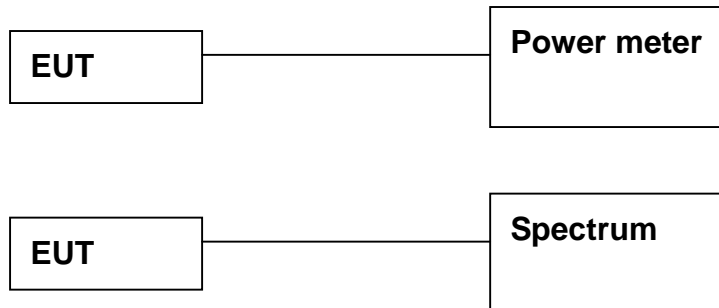

The EUT was connected to a spectrum through a 50 Ω RF cable.

4.5.4 TEST PROCEDURE

The EUT was operating in hopping mode or could control its channel.
Printed out the test result from the spectrum by hard copy function.
Recorded the read value of the power meter.

4.5.5 EUT OPERATING CONDITION

Same as section 4.1.5 of this report.

4.5.6 TEST RESULT

Temperature:	<u>25°C</u>	Humidity:	<u>65%RH</u>
Spectrum Detector:	<u>PK</u>	Tested by:	<u>Roger Horng</u>
Test Result:	<u>PASS</u>	Tested Date:	<u>Jan. 02, 2007</u>

Channel Number	Channel Frequency (MHz)	Peak Output Power (dBm)	Peak Power Limit (dBm)
0	2402.0000	-2.03	30
39	2441.0000	-0.89	30
78	2480.0000	0.48	30



TEST REPORT

CH0:

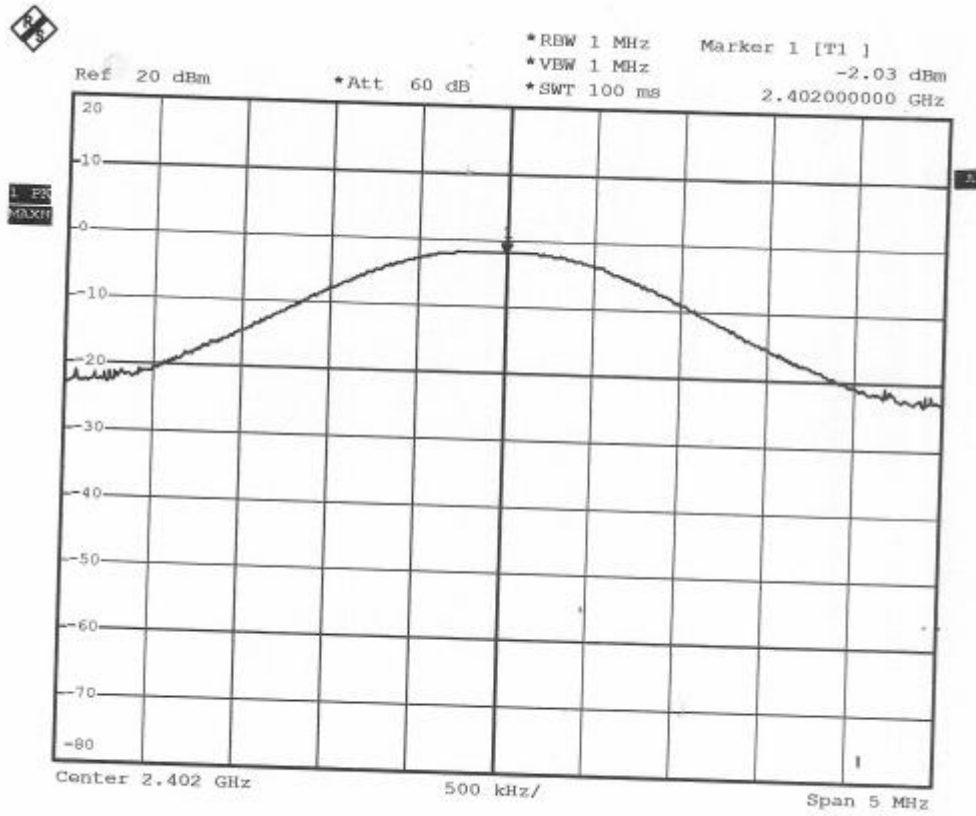

Date: 2.JAN.2007 08:32:24



CH39:

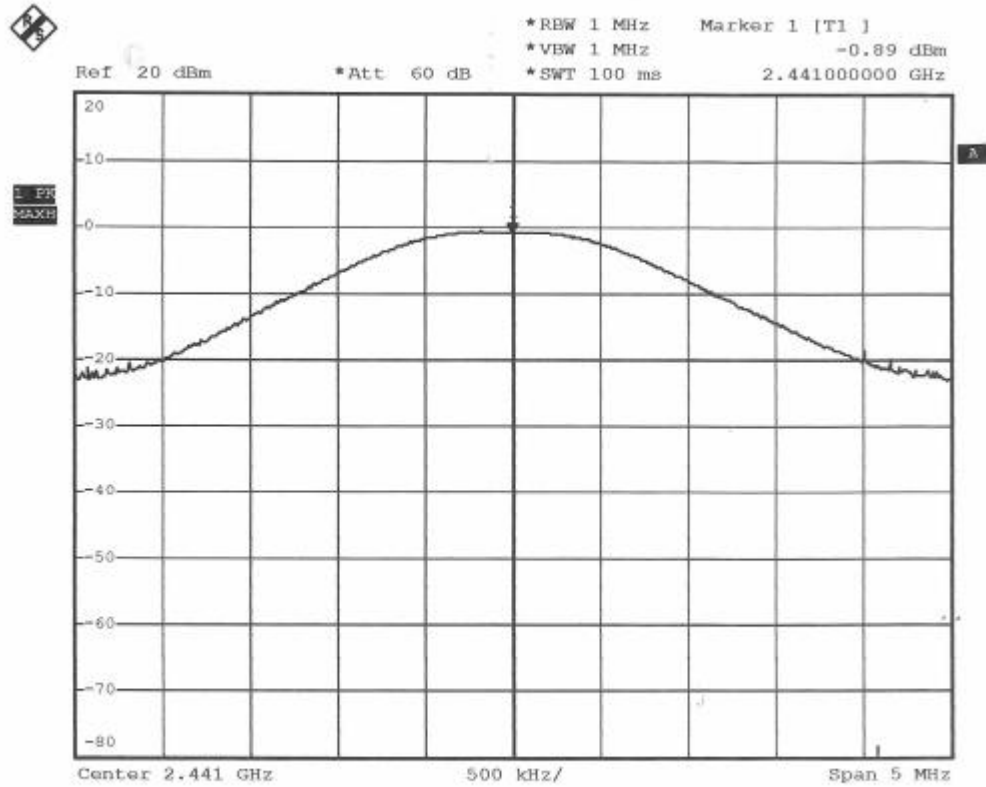

Date: 2.JAN.2007 08:34:06



Spectrum Research & Testing Lab., Inc.
No. 101-10, Ling 8,
Shan-Tong Li, Chung-Li
City, Taoyuan, Taiwan

TEST REPORT

Reference No.: A06122211
Report No.: FCCA06122211
FCC ID: QLEGBU241
Page:29 of 52
Date: Jan. 03, 2007

CH78:

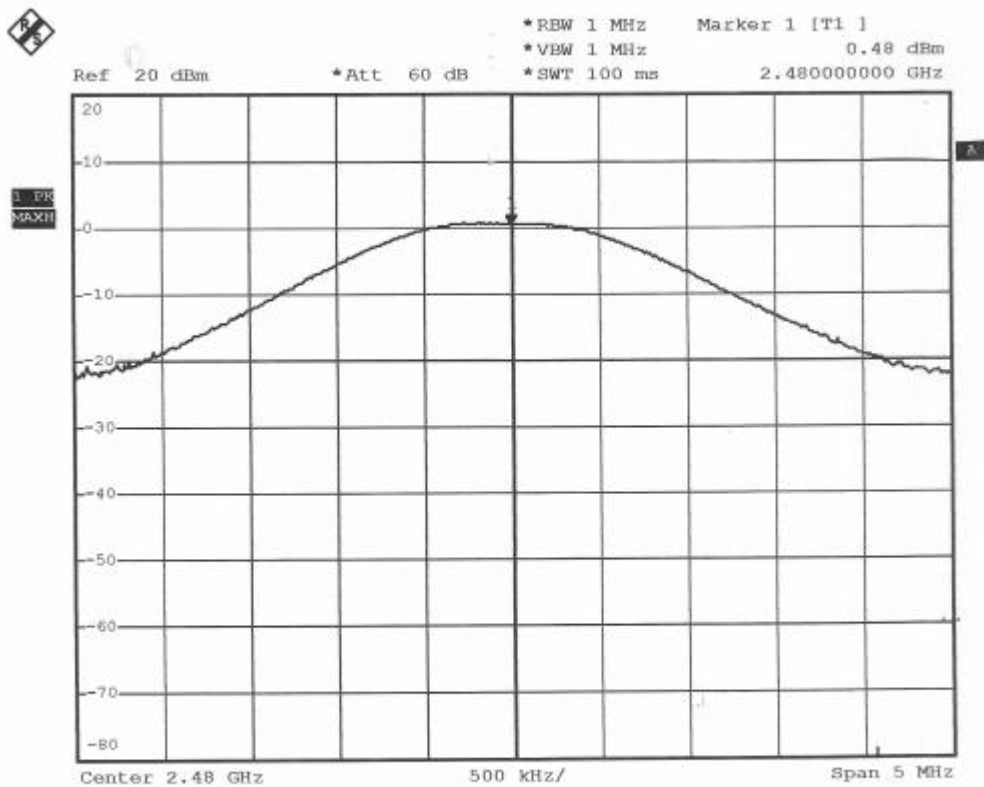

Date: 2.JAN.2007 08:35:44



4.6 BAND EDGE TEST

4.6.1 LIMIT

FCC Part15, Subpart C Section 15.247. In any 100 kHz bandwidth outside the frequency band in which the spread spectrum intentional radiator is operating, the radio frequency power that is produced by the intentional radiator shall be at least 20 dB below that in the 100 kHz bandwidth within the band that contains the highest level of the desired power, based on either an RF conducted or a radiated measurement. Attenuation below the general limits specified in Section 15.209(a) is not required. In addition, radiated emissions which fall in the restricted bands, as defined in Section 15.205(a), must also comply with the radiated emission limits specified in Section 15.209(a) (see Section 15.205(c)).

Operating Frequency Range (MHz)	Spurious Emission Frequency (MHz)	Limit	
		Peak Power Ratio to Emission(dBc)	Emission Level(dBuV/m)
902-928	<902	>20	NA
	>928	>20	NA
	960-1240	NA	54
2400-2483.5	<2400	>20	NA
	>2483.5-2500	NA	54
5725-5850	<5350-5460	NA	54
	<5725	>20	NA
	>5850	>20	NA



Spectrum Research & Testing Lab., Inc.
No. 101-10, Ling 8,
Shan-Tong Li, Chung-Li
City, Taoyuan, Taiwan

TEST REPORT

Reference No.: A06122211
Report No.: FCCA06122211
FCC ID: QLEGBU241
Page:31 of 52
Date: Jan. 03, 2007

4.6.2 TEST EQUIPMENT

The following test equipment was used during the test :

Equipment/ Facilities	Specifications	Manufacturers	Model#/ Serial#	Due Date of Cal. & Cal. Center
SPECTRUM	9kHz-7GHz	ROHDE & SCHWARZ	FSP7/ 839511/010	MAR. 2007 ETC
EMI TEST RECEIVER	9 kHz TO 2750 MHz	ROHDE & SCHWARZ	ESCS30/ 830245/012	OCT. 2007 ETC
SPECTRUM	9KHz-26.5GHz	HP	8953E/ 3710A03220	MAY 2007 ETC
PRE-AMPLIFIER	1GHz-26.5GHz Gain:30dB	HP	8449B/ 3008A01019	NOV. 2007 ETC
BI-LOG ANTENNA	25 MHz TO 2 GHz	EMCO	3142/ 9701-1124	APR. 2007 SRT
HORN ANTENNA	1GHz to 18GHz	EMCO	3115/ 9602-4681	DEC. 2007 ETC
OATS	3 - 10 M measurement	SRT	SRT-1	APR. 2007 SRT

NOTE: The calibration interval of the above test equipment is one year and the calibrations are traceable to NML/ROC and NIST/USA.



4.6.3 TEST SET-UP

FOR RF CONDUCTED TEST

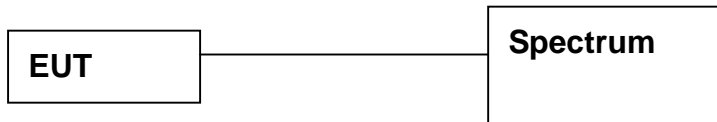

The EUT was connected to the spectrum through a 50Ω RF cable.

FOR RADIATED EMISSION TEST

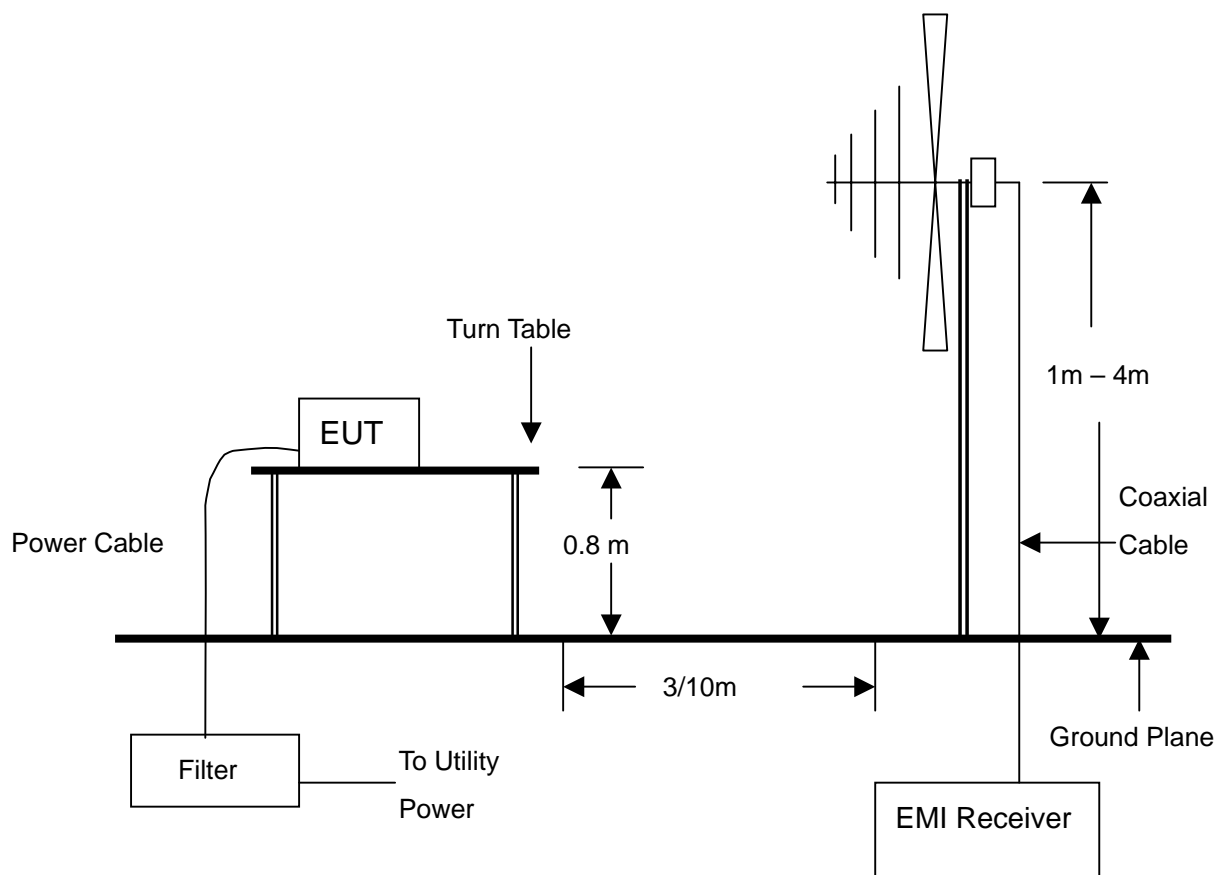

NOTE :

1. The EUT system was put on a wooden table with 0.8m heights above a ground plane.
2. For the actual test configuration, please refer to the photos of testing.



4.6.4 TEST PROCEDURE

1. The EUT was operating in hopping mode or could be controlled its channel.
 Printed out the test result from the spectrum by hard copy function.
2. The EUT was tested according to the requirement of ANSI C63.4 and CISPR 22.
 The measurements were made at an open area test site with 10 meter measurement distance under 1 GHz and with 3m distance above 1GHz. The frequency spectrum measured started from 30 MHz. Under 1 GHz. All readings were quasi-peak values with 120 kHz resolution bandwidth of the test receiver. Above 1 GHz, the measurements were made at an open area test site with 3 meter measurement distance and all readings were peak and average values with 1 MHz resolution bandwidth of the test receiver. The EUT system was operated in all typical methods by users. The cables connected to EUT and support units were moved to find the maximum emission levels for each frequency.

4.6.5 EUT OPERATING CONDITION

Same as section 4.1.5 of this report.

4.6.6 TEST RESULT

Temperature:	<u>26°C</u>	Humidity:	<u>55%RH</u>
Spectrum Detector:	<u>PK & AV</u>	Tested by:	<u>Roger Horng</u>
Test Result:	<u>PASS</u>	Tested Date:	<u>Dec. 28, 2006</u>

1. Conducted test

Frequency (MHz)	Peak Output Power (dBm)	Emission Read Value(dBm)	Result of Band Edge (dBc)	Band Edge Limit (dBc)
<2400	-2.72	-38.93	36.21	>20dBc
>2483.5	0.15	-40.55	40.70	>20dBc

2. Radiated emission test

Frequency (MHz)	Antenna Polarization (H/V)	Reading (dBuV)		Emission (dBuV/m)		Band Edge Limit (dBuV/m)	
		PK	AV	PK	AV	PK	AV
<2400	H	31.7	*	34.9	*	74.0	54.0
>2483.5	H	31.3	*	32.0	*	74.0	54.0



Spectrum Research & Testing Lab., Inc.
No. 101-10, Ling 8,
Shan-Tong Li, Chung-Li
City, Taoyuan, Taiwan

TEST REPORT

Reference No.: A06122211
Report No.: FCCA06122211
FCC ID: QLEGBU241
Page:34 of 52
Date: Jan. 03, 2007

<2400MHz:

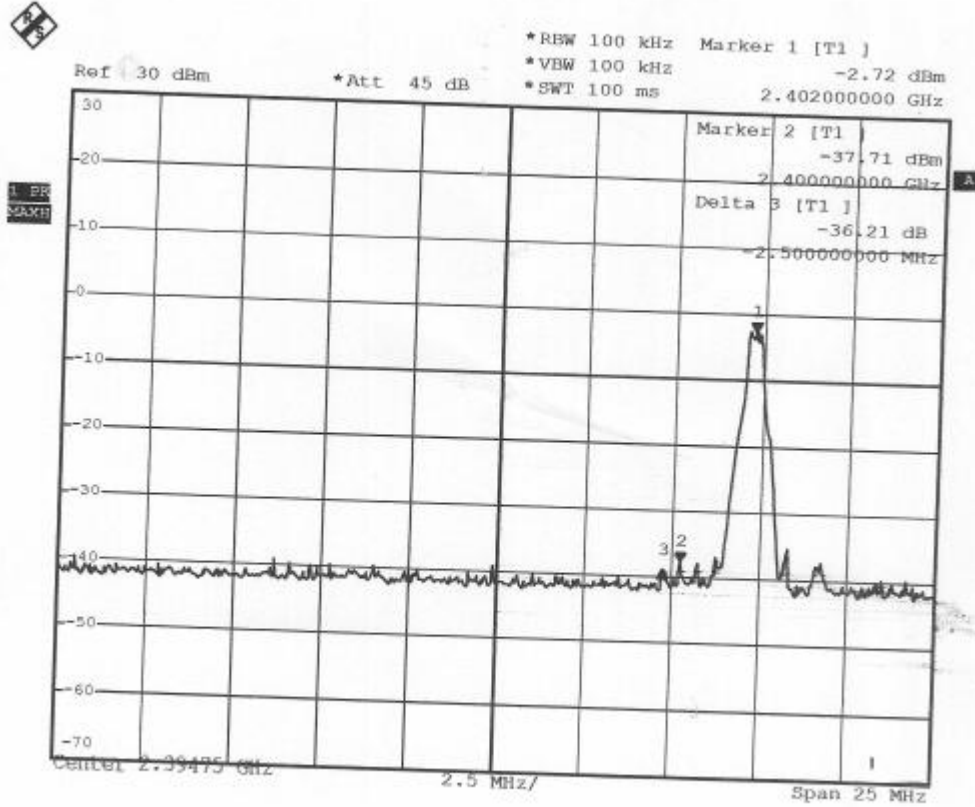

Date: 2.JAN.2007 08:57:



TEST REPORT

>2483.5MHz

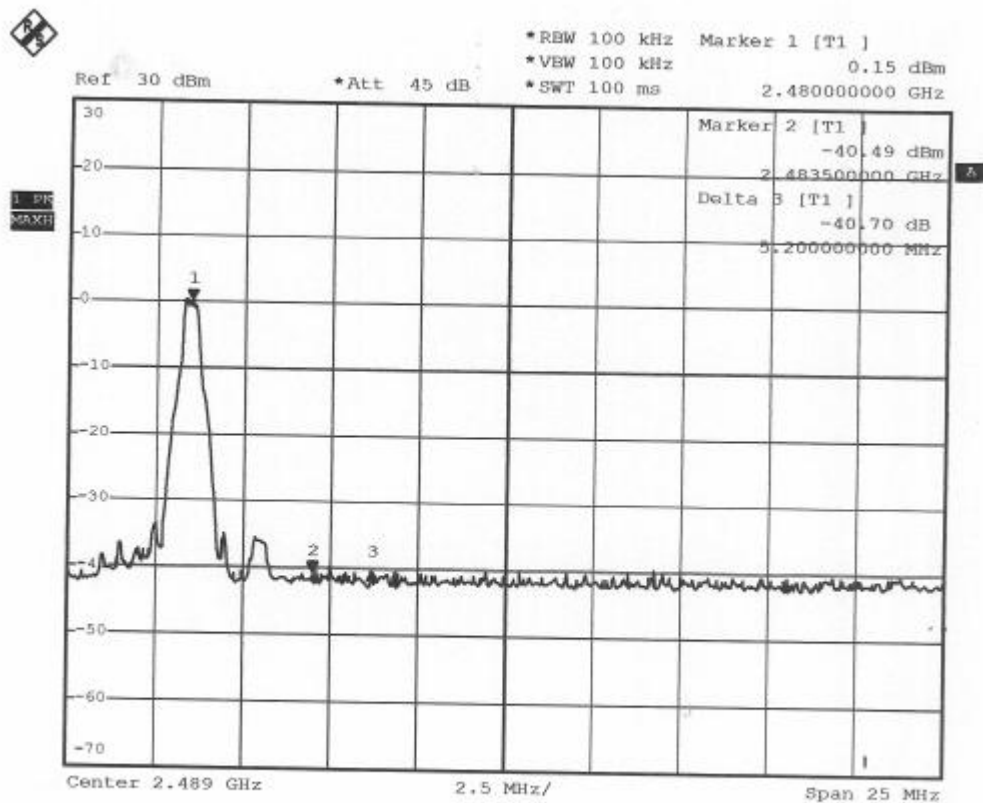

Date: 2.JAN.2007 08:55:00



4.7 SPURIOUS RADIATED EMISSION TEST

4.7.1 LIMIT

FCC Part15, Subpart C Section 15.209 limit of radiated emission for frequency below1000MHz. The emissions from an intentional radiator shall not exceed the field strength levels specified in the following table:

Frequency (MHz)	Distance (m)	Field Strength (dB μ V/m)
30 - 88	3	40.0
88 - 216	3	43.5
216 - 960	3	46.0
ABOVE 960	3	54.0

- NOTE** :
1. In the emission tables above , the tighter limit applies at the band edges.
 2. Distance refers to the distance between measuring instrument , antenna , and the closest point of any part of the device or system.

FCC Part 15, Section15.35(b) limit of radiated emission for frequency above 1000 MHz

Frequency (MHz)	Class A (dBuV/m) (at 3m)		Class B (dBuV/m) (at 3m)	
	Peak	Average	Peak	Average
Above 1000	80.0	60.0	74.0	54.0

FCC Part 15, Subpart C Section 15.249. The field strength of emissions from intentional radiators operated within these frequency bands shall comply with the following:

Fundamental Frequency (MHz)	Filed Strength of Fundamental (dBuV/m) (at 3m)		Field Strength of Harmonics (dBuV/m) (at 3m)	
	Peak	Average	Peak	Average
902-928	114	94	74.0	54.0
2400-2483.5	114	94	74.0	54.0
5725-5875	114	94	74.0	54.0
24000-24250	128	108	88.0	68.0



Spectrum Research & Testing Lab., Inc.
No. 101-10, Ling 8,
Shan-Tong Li, Chung-Li
City, Taoyuan, Taiwan

TEST REPORT

Reference No.: A06122211
Report No.: FCCA06122211
FCC ID: QLEGBU241
Page:37 of 52
Date: Jan. 03, 2007

4.7.2 TEST EQUIPMENT

The following test equipment was used during the radiated emission test :

Equipment/ Facilities	Specifications	Manufacturer	Model#/ Serial#	Due Date of Cal. & Cal. Center
EMI TEST RECEIVER	20 kHz TO 1 GHz	ROHDE & SCHWARZ	ESVS30/ 841977/003	SEP. 2007 ETC
BI-LOG ANTENNA	25 MHz TO 2 GHz	EMCO	3142/ 9701-1124	APR. 2007 SRT
OATS	3 – 10 M MEASUREMENT	SRT	SRT-1	APR. 2007 SRT
COAXIAL CABLE	25M	SUNCITY	J400/ 25M	AUG. 2007 SRT
FILTER	2 LINE, 30A	FIL.COIL	FC-943/ 869	N/A
FREQUENCY CONVERTER	N/A	APC	AFC-2KBB/ F100030031	AUG. 2007 SRT

NOTE:

1. The calibration interval of the above test equipment is one year and the calibrations are traceable to NML/ROC and NIST/USA.
2. The Open Area Test Site (SRT-1) is registered by FCC with No. 90957 and VCCI with No. R-1081.
3. The Open Area Test Site (SRT-2) is registered by FCC with No. 98458 and VCCI with No. R-1168.



4.7.3 TEST SET-UP

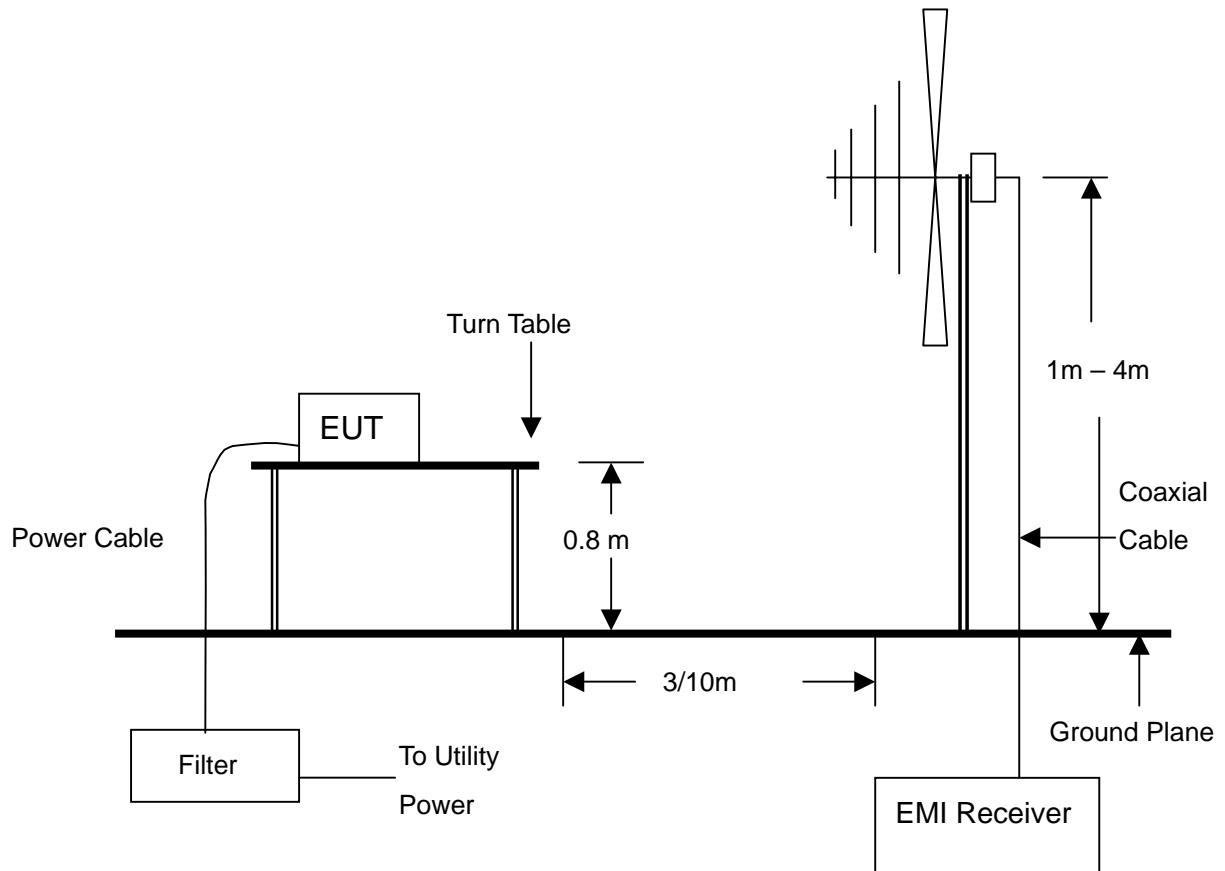

NOTE :

1. The EUT system was put on a wooden table with 0.8m heights above a ground plane.
2. For the actual test configuration, please refer to the photos of testing.



**Spectrum Research &
Testing Lab., Inc.**
No. 101-10, Ling 8,
Shan-Tong Li, Chung-Li
City, Taoyuan, Taiwan

TEST REPORT

Reference No.: A06122211
Report No.: FCCA06122211
FCC ID: QLEGBU241
Page:39 of 52
Date: Jan. 03, 2007

4.7.4 TEST PROCEDURE

The EUT was tested according to the requirement of ANSI C63.4 and CISPR 22. The measurements were made at an open area test site with 10 meter measurement distance under 1 GHz and with 3m distance above 1GHz. The frequency spectrum measured started from 30 MHz. Under 1 GHz. All readings were quasi-peak values with 120 kHz resolution bandwidth of the test receiver. Above 1 GHz, the measurements were made at an open area test site with 3 meter measurement distance and all readings were peak and average values with 1 MHz resolution bandwidth of the test receiver. The EUT system was operated in all typical methods by users. The cables connected to EUT and support units were moved to find the maximum emission levels for each frequency.

4.7.5 EUT OPERATING CONDITION

Same as section 4.1.5 of this report.



4.7.6 TEST RESULT

Temperature:	<u>22°C</u>	Humidity:	<u>70%RH</u>
Ferquency Range:	<u>30 – 1000 MHz</u>	Test mode:	<u>RX</u>
Receiver Detector:	<u>Q.P. or AV.</u>	Measured Distance:	<u>3m</u>
Tested by:	<u>Roger Horng</u>	Tested Date:	<u>Dec. 28, 2006</u>

Antenna Polarization : Horizontal

Frequency (MHz)	Cable Loss (dB)	Antenna Factor (dB/m)	Reading Data (dBμV)	Emission Level (dBμV/m)	Limit (dBμV/m)	Margin (dB)	AZ(°)	EL(m)
166.7210	2.68	9.96	19.3	31.9	43.5	-11.6	350	1.0
241.3600	3.09	11.23	20.7	35.0	46.0	-11.0	320	1.0
432.6100	4.84	15.96	9.6	30.4	46.0	-15.6	5	1.0
497.4300	6.46	16.09	2.2	24.8	46.0	-21.2	309	1.0
566.1500	6.29	16.96	3.3	26.5	46.0	-19.5	20	1.0
801.1200	8.14	21.91	2.2	32.2	46.0	-13.8	285	1.0

Antenna Polarization : Vertical

Frequency (MHz)	Cable Loss (dB)	Antenna Factor (dB/m)	Reading Data (dBμV)	Emission Level (dBμV/m)	Limit (dBμV/m)	Margin (dB)	AZ(°)	EL(m)
221.9500	2.88	10.44	20.8	34.1	46.0	-11.9	85	1.0
365.3100	4.55	15.13	2.6	22.3	46.0	-23.7	340	1.1
431.5100	4.81	15.96	7.8	28.6	46.0	-17.4	80	1.0
497.3200	6.46	16.09	2.3	24.9	46.0	-21.1	340	1.0
599.2900	6.96	17.39	2.5	26.8	46.0	-19.2	350	1.0
719.9400	7.19	21.17	4.9	33.3	46.0	-12.7	5	1.0

- NOTE :**
1. Measurement uncertainty is less than +/-2dB
 2. "*": Measurement does not apply for this frequency.
 3. Emission Level = Reading Value + Ant. Factor + Cable Loss
 4. The field strength of other emission frequencies were very low against the limit.



TEST REPORT

Temperature:	22°C	Humidity:	70%RH
Ferquency Range:	30 – 1000 MHz	Test mode:	TX
Receiver Detector:	Q.P. or AV.	Measured Distance:	3m
Tested by:	Roger Horng	Tested Date:	Dec. 28, 2006

Antenna Polarization : Horizontal

Frequency (MHz)	Cable Loss (dB)	Antenna Factor (dB/m)	Reading Data (dBμV)	Emission Level (dBμV/m)	Limit (dBμV/m)	Margin (dB)	AZ(°)	EL(m)
166.7110	2.68	9.96	25.7	38.3	43.5	-5.2	300	3.7
210.0360	2.66	10.00	23.1	35.8	43.5	-7.7	299	1.0
236.6000	2.99	11.04	18.2	32.2	46.0	-13.8	330	1.0
242.4400	3.16	11.26	20.8	35.2	46.0	-10.8	320	1.0
432.6020	4.84	15.96	9.7	30.5	46.0	-15.5	5	1.0
599.3640	6.96	17.39	4.8	29.1	46.0	-16.9	85	1.1

Antenna Polarization : Vertical

Frequency (MHz)	Cable Loss (dB)	Antenna Factor (dB/m)	Reading Data (dBμV)	Emission Level (dBμV/m)	Limit (dBμV/m)	Margin (dB)	AZ(°)	EL(m)
217.9200	2.81	10.28	21.5	34.6	46.0	-11.4	320	1.0
249.1950	3.69	11.47	23.3	38.5	46.0	-7.5	5	1.2
286.9800	3.91	13.08	18.7	35.7	46.0	-10.3	355	1.0
335.9850	4.05	14.47	8.6	27.1	46.0	-18.9	85	1.2
431.5100	4.81	15.96	7.8	28.6	46.0	-17.4	80	1.0
719.9500	7.19	21.17	4.9	33.3	46.0	-12.7	5	1.0

- NOTE :**
1. Measurement uncertainty is less than +/-2dB
 2. "**": Measurement does not apply for this frequency.
 3. Emission Level = Reading Value + Ant. Factor + Cable Loss
 4. The field strength of other emission frequencies were very low against the limit.



Spectrum Research & Testing Lab., Inc.
No. 101-10, Ling 8,
Shan-Tong Li, Chung-Li
City, Taoyuan, Taiwan

TEST REPORT

Reference No.: A06122211
Report No.: FCCA06122211
FCC ID: QLEGBU241
Page:42 of 52
Date: Jan. 03, 2007

Temperature:	25°C	Humidity:	60%RH
Ferquency Range:	1 – 25 GHz	Test mode:	Ch0
Receiver Detector:	PK. or AV.	Measured Distance:	3m
Tested by:	Roger Horng	Tested Date:	Dec. 28, 2006

Antenna Polarization : Horizontal

Freq./MHz	Cable Loss (dB)	Ant. Fact. (dB)	Reading (dBuV)		Emission (dBuV/m)		Limit Line (dBuV/m)		Margin (dBuV/m)		AZ (o)	EL (m)
			PK	AV	PK	AV	PK	AV	PK	AV		
2402.00(F)	-32.16	28.54	93.2	84.2	89.6	80.6	N/A	N/A	N/A	N/A	15	1.4
4803.90	-30.47	33.64	31.7	*	34.9	*	74.0	54.0	-39.1	*	20	1.2
7206.04	-28.90	36.26	29.8	*	37.2	*	74.0	54.0	-36.8	*	20	1.1
9607.90	-28.55	37.84	31.1	*	40.4	*	74.0	54.0	-33.6	*	25	1.3
1043.92	-34.58	24.29	43.8	*	33.5	*	74.0	54.0	-40.5	*	350	1.1
2683.80	-32.12	29.22	43.4	*	40.5	*	74.0	54.0	-33.5	*	10	1.2

Antenna Polarization : Vertical

Freq./MHz	Cable Loss (dB)	Ant. Fact. (dB)	Reading (dBuV)		Emission (dBuV/m)		Limit Line (dBuV/m)		Margin (dBuV/m)		AZ (o)	EL (m)
			PK	AV	PK	AV	PK	AV	PK	AV		
2402.00(F)	-32.16	28.00	92.6	84.9	88.4	80.7	N/A	N/A	N/A	N/A	15	1.4
4839.00	-30.37	33.67	30.2	*	33.5	*	74.0	54.0	-40.5	*	20	1.3
7206.09	-28.90	36.26	30.0	*	37.4	*	74.0	54.0	-36.6	*	25	1.2
9607.90	-28.55	37.84	31.0	*	40.3	*	74.0	54.0	-33.7	*	20	1.3
1457.50	-29.86	25.21	30.9	*	26.2	*	74.0	54.0	-47.8	*	5	1.2
3231.90	-31.78	31.69	31.1	*	31.0	*	74.0	54.0	-43.0	*	25	1.4

- NOTE :**
1. Measurement uncertainty is less than +/-2dB
 2. "*": Measurement does not apply for this frequency.
 3. Emission Level = Reading Value + Ant. Factor + Cable Loss
 4. The field strength of other emission frequencies were very low against the limit.
 - 5.(F):The field strength of fundamental frequency.



TEST REPORT

Temperature:	<u>25°C</u>	Humidity:	<u>60%RH</u>
Ferquency Range:	<u>1 – 25 GHz</u>	Test mode:	<u>Ch39</u>
Receiver Detector:	<u>PK. or AV.</u>	Measured Distance:	<u>3m</u>
Tested by:	<u>Roger Horng</u>	Tested Date:	<u>Dec. 28, 2006</u>

Antenna Polarization : Horizontal

Freq./MHz	Cable Loss (dB)	Ant. Fact. (dB)	Reading (dBuV)		Emission (dBuV/m)		Limit Line (dBuV/m)		Margin (dBuV/m)		AZ (o)	EL (m)
			PK	AV	PK	AV	PK	AV	PK	AV		
2441.00(F)	-32.23	28.62	90.8	83.0	87.2	79.4	N/A	N/A	N/A	N/A	20	1.3
4881.99	-30.27	33.70	33.3	*	36.7	*	74.0	54.0	-37.3	*	15	1.2
7323.20	-29.04	36.36	30.9	*	38.2	*	74.0	54.0	-35.8	*	20	1.1
9761.60	-28.49	37.90	31.0	*	40.4	*	74.0	54.0	-33.6	*	355	1.3
1084.16	-34.67	24.38	31.1	*	20.8	*	74.0	54.0	-53.2	*	210	1.1
3204.20	-31.88	31.61	31.8	*	31.5	*	74.0	54.0	-42.5	*	10	1.2

Antenna Polarization : Vertical

Freq./MHz	Cable Loss (dB)	Ant. Fact. (dB)	Reading (dBuV)		Emission (dBuV/m)		Limit Line (dBuV/m)		Margin (dBuV/m)		AZ (o)	EL (m)
			PK	AV	PK	AV	PK	AV	PK	AV		
2441.00(F)	-32.23	28.08	89.9	81.9	85.8	77.8	N/A	N/A	N/A	N/A	20	1.4
4881.99	-30.27	33.70	31.6	*	35.0	*	74.0	54.0	-39.0	*	15	1.1
7323.20	-29.04	36.36	29.5	*	36.9	*	74.0	54.0	-37.1	*	20	1.5
9761.60	-28.49	37.90	31.2	*	40.6	*	74.0	54.0	-33.4	*	1	1
1731.74	-32.99	26.18	30.8	*	24.0	*	74.0	54.0	-50.0	*	15	1.4
3515.50	-31.21	32.49	29.1	*	30.4	*	74.0	54.0	-43.6	*	35	1.3

- NOTE :**
1. Measurement uncertainty is less than +/-2dB
 2. "*": Measurement does not apply for this frequency.
 3. Emission Level = Reading Value + Ant. Factor + Cable Loss
 4. The field strength of other emission frequencies were very low against the limit.
 - 5.(F):The field strength of fundamental frequency.



TEST REPORT

Temperature:	<u>25°C</u>	Humidity:	<u>60%RH</u>
Ferquency Range:	<u>1 – 25GHz</u>	Test mode:	<u>Ch78</u>
Receiver Detector:	<u>PK. or AV.</u>	Measured Distance:	<u>3m</u>
Tested by:	<u>Roger Horng</u>	Tested Date:	<u>Dec. 28, 2006</u>

Antenna Polarization : Horizontal

Freq./MHz	Cable Loss (dB)	Ant. Fact. (dB)	Reading (dBuV)		Emission (dBuV/m)		Limit Line (dBuV/m)		Margin (dBuV/m)		AZ (o)	EL (m)
			PK	AV	PK	AV	PK	AV	PK	AV		
2480.00(F)	-32.19	28.73	87.3	84.4	83.8	81.0	N/A	N/A	N/A	N/A	20	1.4
4959.99	-30.26	33.77	35.9	*	39.4	*	74.0	54.0	-34.6	*	20	1.3
7441.04	-28.95	36.45	29.6	*	37.1	*	74.0	54.0	-36.9	*	14	1.4
9919.96	-28.65	37.97	31.0	*	40.3	*	74.0	54.0	-33.7	*	10	1.2
1338.00	-33.03	24.94	30.0	*	21.9	*	74.0	54.0	-52.1	*	310	1.3
3402.60	-31.47	32.21	31.3	*	32.0	*	74.0	54.0	-42.0	*	30	1.1

Antenna Polarization : Vertical

Freq./MHz	Cable Loss (dB)	Ant. Fact. (dB)	Reading (dBuV)		Emission (dBuV/m)		Limit Line (dBuV/m)		Margin (dBuV/m)		AZ (o)	EL (m)
			PK	AV	PK	AV	PK	AV	PK	AV		
2480.00(F)	-32.19	28.16	87.4	84.4	83.4	80.4	N/A	N/A	N/A	N/A	20	1.4
4959.99	-30.26	33.77	29.9	*	33.4	*	74.0	54.0	-40.6	*	15	1.3
7441.04	-28.95	36.45	29.9	*	37.4	*	74.0	54.0	-36.6	*	10	1.1
9919.96	-28.65	37.97	29.8	*	39.1	*	74.0	54.0	-34.9	*	15	1.4
1132.00	-34.64	24.49	30.0	*	19.8	*	74.0	54.0	-54.2	*	25	1.1
3003.36	-32.16	31.01	31.0	*	29.8	*	74.0	54.0	-44.2	*	40	1.2

- NOTE :**
1. Measurement uncertainty is less than +/- 2dB
 2. "*": Measurement does not apply for this frequency.
 3. Emission Level = Reading Value + Ant. Factor + Cable Loss
 4. The field strength of other emission frequencies were very low against the limit.
 - 5.(F):The field strength of fundamental frequency.



4.8 CONDUCTED EMISSION TEST

4.8.1 CONDUCTED EMISSION LIMIT

Frequency (MHz)	Class A (dB μ V)		Class B (dB μ V)	
	Quasi-peak	Average	Quasi-peak	Average
0.15 - 0.5	79	66	66 - 56	56 - 46
0.5 - 5.0	73	60	56	46
5.0 - 30.0	73	60	60	50

NOTE:

1. The lower limit shall apply at the transition frequencies.
2. The limit decreases in line with the logarithm of the frequency in the range of 0.15 to 0.50 MHz.

4.8.2 TEST EQUIPMENT

The following test equipment was used for the test:

Equipment/ Facilities	Specifications	Manufactruer	Model#/ Serial#	Due Date of Cal. & Cal. Center
EMI TEST RECEIVER	9 kHz TO 30 MHz	ROHDE & SCHWARZ	ESHS30/ 826003/008	AUG. 2007 ETC
LISN (for EUT)	50 μ H, 50 ohm	FCC	FCC-LISN-50-25-2/ 01017	NOV. 2007 ETC
LISN (for Peripheral)	50 μ H, 50 ohm	FCC	FCC-LISN-50-25-2/ 01018	NOV. 2007 ETC
50 ohm TERMINATOR	50 ohm	HP	11593A/ 2	OCT. 2007 ETC
COAXIAL CABLE	3m	SUNCITY	J400/ 3M	JUL. 2007 SRT
ISOLATION TRANSFORMER	N/A	APC	AFC-11015/ F102040016	N/A
FILTER	2 LINE, 30A	FIL.COIL	FC-943/ 771	N/A
GROUND PLANE	2.3M (H) x 2.4M (W)	SRT	N/A	N/A
GROUND PLANE	2.4M (H) x 2.4M (W)	SRT	N/A	N/A

NOTE: The calibration interval of the above test equipment is one year and the calibrations are traceable to NML/ROC and NIST/USA.



4.8.3 TEST SETUP

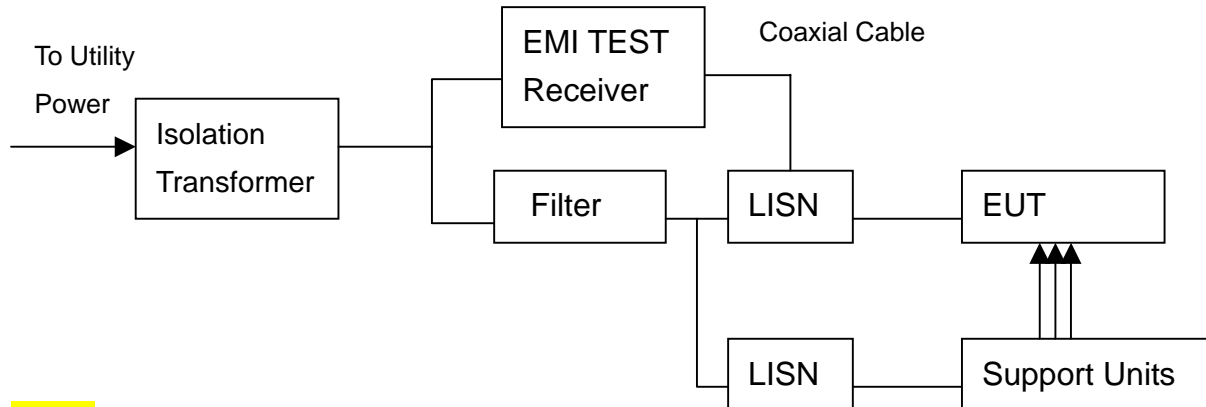

NOTE:

1. The EUT was put on a wooden table with 0.8m heights above ground plane, and 0.4m away from reference ground plane (> 2mx2m).
2. For the actual test configuration, please refer to the photos of testing.
3. The serial no. of the LISN connected to EUT is 01017.
4. The serial no. of the LISN connected to support units is 01018.

4.8.4 TEST PROCEDURE

The EUT was tested according to the requirement of ANSI C63.4:2003 and CISPR22:2003. The frequency spectrum from 0.15 MHz to 30 MHz was investigated. The LISN used was 50 ohm/50 μ H as specified. All readings were quasi-peak and average values with 10 kHz resolution bandwidth of the test receiver. The EUT system was operated in all typical methods by users. Both lines of the power mains of EUT were measured and the cables connected to EUT and support units were moved to find the maximum emission levels for each frequency. First, find the margin or higher points at least 6 points by software, then use manual to find the maximum data. The procedure is referred on the test procedure of SRT LAB.



TEST REPORT

4.8.5 TEST RESULT

Temperature:	24 °C	Humidity:	68 %RH
Ferquency Range:	0.15 – 30 MHz	Test Mode:	Link
Receiver Detector:	Q.P. and AV.	Tested By:	Roger Horng
		Tested Date:	Dec. 27, 2006

Power Line Measured : Line

Freq. (MHz)	Correct. Factor (dB)	Reading Value (dB μ V)		Emission Level (dB μ V)		Limit (dB μ V)		Margin (dB)	
		Q.P.	AV.	Q.P.	AV.	Q.P.	AV.	Q.P.	AV.
0.168	0.30	47.10	26.10	47.40	26.40	65.04	55.04	-17.64	-28.64
0.177	0.30	49.28	40.60	49.58	40.90	64.61	54.61	-15.03	-13.71
0.524	0.24	34.66	31.29	34.90	31.53	56.00	46.00	-21.10	-14.47
2.893	0.18	30.96	22.49	31.14	22.67	56.00	46.00	-24.86	-23.33
3.121	0.18	33.10	24.43	33.28	24.61	56.00	46.00	-22.72	-21.39
5.264	0.22	21.36	13.09	21.58	13.31	60.00	50.00	-38.42	-36.69

Power Line Measured : Neutral

Freq. (MHz)	Correct. Factor (dB)	Reading Value (dB μ V)		Emission Level (dB μ V)		Limit (dB μ V)		Margin (dB)	
		Q.P.	AV.	Q.P.	AV.	Q.P.	AV.	Q.P.	AV.
0.171	0.30	51.30	42.58	51.60	42.88	64.89	54.89	-13.29	-12.01
0.174	0.30	52.56	43.36	52.86	43.66	64.75	54.75	-11.89	-11.09
0.984	0.17	37.10	35.46	37.27	35.63	56.00	46.00	-18.73	-10.37
1.269	0.14	34.86	32.06	35.00	32.20	56.00	46.00	-21.00	-13.80
1.329	0.15	35.10	32.78	35.25	32.93	56.00	46.00	-20.75	-13.07
17.327	0.27	25.30	20.14	25.57	20.41	60.00	50.00	-34.43	-29.59

NOTE :

1. Measurement uncertainty is +/-1.32dB
2. Emission level = Reading value + Correction factor
3. Correction Factor = Cable loss + Insertion loss of LISN
4. Margin value = Emission level - Limit
5. The emission of other frequencies were very low against the limit.
6. "-": The Quasi-peak reading value also meets average limit and measurement with the average detector is unnecessary.



**Spectrum Research &
Testing Lab., Inc.**
No. 101-10, Ling 8,
Shan-Tong Li, Chung-Li
City, Taoyuan, Taiwan

TEST REPORT

Reference No.: A06122211
Report No.: FCCA06122211
FCC ID: QLEGBU241
Page:48 of 52
Date: Jan. 03, 2007

5. Antenna application

5.1 Antenna requirement

The EUT's antenna is met the requirement of FCC part15C section15.203 and 15.204.

FCC part15C section15.247 requirement:

Systems operating in the 2400-2483.5 MHz band that are used exclusively for fixed, point-to-point operations may employ transmitting antennas with directional gain greater than 6 dBi provided the maximum peak output power of the intentional radiator is reduced by 1 dB for every 3 dB that the directional gain of the antenna exceeds 6 dBi.

5.2 Result

The EUT's antenna used a dipole antenna and integrated on PCB. The antenna's gain is 0dBi and meets the requirement.



Spectrum Research & Testing Lab., Inc.
No. 101-10, Ling 8,
Shan-Tong Li, Chung-Li
City, Taoyuan, Taiwan

TEST REPORT

Reference No.: A06122211
Report No.: FCCA06122211
FCC ID: QLEGBU241
Page:52 of 52
Date: Jan. 03, 2007

7. TERMS OF ABBREVIATION

AV.	Average detection
AZ(°)	Turn table azimuth
Correct.	Correction
EL(m)	Antenna height (meter)
EUT	Equipment Under Test
Horiz.	Horizontal direction
LISN	Line Impedance Stabilization Network
NSA	Normalized Site Attenuation
Q.P.	Quasi-peak detection
SRT Lab	Spectrum Research & Testing Laboratory, Inc.
Vert.	Vertical direction