



FCC TEST REPORT

REPORT NO.: RF970529H02

MODEL NO.: GUWA200

RECEIVED: May 29, 2008

TESTED: Jun. 12 ~ Jun. 18, 2008

ISSUED: Jun. 23, 2008

APPLICANT: IOGEAR, Inc.

ADDRESS: 23 Hubble, Irvine, CA 92618, U.S.A.

ISSUED BY: Advance Data Technology Corporation

LAB ADDRESS: 47 14th Lin, Chiapau Tsun, Linko, Taipei,
Taiwan, R.O.C.

TEST LOCATION: No. 19, Hwa Ya 2nd Rd., Kueishan, Taoyuan,
Taiwan, R.O.C.

This test report consists of 46 pages in total. It may be duplicated completely for legal use with the approval of the applicant. It should not be reproduced except in full, without the written approval of our laboratory. The client should not use it to claim product endorsement by TAF or any government agencies. The test results in the report only apply to the tested sample.





Table of Contents

1	CERTIFICATION	4
2	SUMMARY OF TEST RESULTS	5
2.1	MEASUREMENT UNCERTAINTY	5
3	GENERAL INFORMATION.....	6
3.1	GENERAL DESCRIPTION OF EUT.....	6
3.2	DESCRIPTION OF TEST MODES.....	7
3.2.1	CONFIGURATION OF SYSTEM UNDER TEST.....	7
3.2.2	TEST MODE APPLICABILITY AND TESTED CHANNEL DETAIL.....	8
3.3	GENERAL DESCRIPTION OF APPLIED STANDARDS	9
3.4	DESCRIPTION OF SUPPORT UNITS	10
3.5	OPERATIONAL LIMITATIONS	11
4	TEST TYPES AND RESULTS	12
4.1	CONDUCTED EMISSION MEASUREMENT	12
4.1.1	LIMITS OF CONDUCTED EMISSION MEASUREMENT	12
4.1.2	TEST INSTRUMENTS	12
4.1.3	TEST PROCEDURES.....	13
4.1.4	DEVIATION FROM TEST STANDARD	13
4.1.5	TEST SETUP	14
4.1.6	EUT OPERATING CONDITIONS.....	14
4.1.7	TEST RESULTS	15
4.2	RADIATED EMISSION MEASUREMENT (FOR 15.519 (c)).....	17
4.2.1	LIMITS OF RADIATED EMISSION MEASUREMENT	17
4.2.2	INSTRUMENT SETUP VALUE AND MEASUREMENT DISTANCE	18
4.2.3	TEST INSTRUMENTS	19
4.2.4	TEST PROCEDURES.....	20
4.2.5	DEVIATION FROM TEST STANDARD	20
4.2.6	TEST SETUP	21
4.2.7	EUT OPERATING CONDITIONS.....	21
4.2.8	TEST RESULTS	22
4.3	RADIATED EMISSION MEASUREMENT (FOR 15.519 (d)).....	29
4.3.1	LIMITS OF RADIATED EMISSION MEASUREMENT	29
4.3.2	INSTRUMENT SETUP VALUE AND MEASUREMENT DISTANCE	30
4.3.3	TEST INSTRUMENTS	31
4.3.4	TEST PROCEDURES.....	32
4.3.5	DEVIATION FROM TEST STANDARD	32
4.3.6	TEST SETUP	33
4.3.7	EUT OPERATING CONDITIONS.....	33
4.3.8	TEST RESULTS	34
4.4	UWB BANDWIDTH MEASUREMENT	37
4.4.1	LIMITS OF UWB BANDWIDTH MEASUREMENT	37
4.4.2	INSTRUMENT SETUP VALUE AND MEASUREMENT DISTANCE	37
4.4.3	TEST INSTRUMENT	37



4.4.4	TEST PROCEDURE	37
4.4.5	DEVIATION FROM TEST STANDARD	37
4.4.6	TEST SETUP	38
4.4.7	EUT OPERATING CONDITIONS	38
4.4.8	TEST RESULTS	39
4.5	PEAK EMISSION WITHIN A 50MHz BANDWIDTH	40
4.5.1	LIMITS OF PEAK EMISSION	40
4.5.2	INSTRUMENT SETUP VALUE AND MEASUREMENT DISTANCE	40
4.5.3	TEST INSTRUMENTS	41
4.5.4	TEST PROCEDURE	41
4.5.5	DEVIATION FROM TEST STANDARD	41
4.5.6	TEST SETUP	41
4.5.7	EUT OPERATING CONDITIONS	41
4.5.8	TEST RESULTS	42
4.6	ANTENNA REQUIREMENT	43
4.6.1	STANDARD APPLICABLE	43
4.6.2	ANTENNA CONNECTED CONSTRUCTION	43
5	PHOTOGRAPHS OF THE TEST CONFIGURATION	44
6	INFORMATION ON THE TESTING LABORATORIES	45
7	APPENDIX A - MODIFICATIONS RECORDERS FOR ENGINEERING CHANGES TO THE EUT BY THE LAB	46



1 CERTIFICATION

PRODUCT: Wireless USB Host Adapter
MODEL: GUWA200
BRAND: IOGEAR
APPLICANT: IOGEAR, Inc.
TESTED: Jun. 12 ~ Jun. 18, 2008
TEST SAMPLE: ENGINEERING SAMPLE
STANDARDS: **FCC Part 15, Subpart F (Section 15.519)**
ANSI C63.4-2003

The above equipment (model: GUWA200) have been tested by **Advance Data Technology Corporation**, and found compliance with the requirement of the above standards. The test record, data evaluation & Equipment Under Test (EUT) configurations represented herein are true and accurate accounts of the measurements of the sample's EMC characteristics under the conditions specified in this report.

PREPARED BY : Rennie Wang , **DATE:** Jun. 23, 2008
Rennie Wang / Senior Specialist

TECHNICAL ACCEPTANCE : Long Chen , **DATE:** Jun. 23, 2008
Responsible for RF Long Chen / Senior Engineer

APPROVED BY : Gary Chang , **DATE:** Jun. 23, 2008
Gary Chang / Assistant Manager

2 SUMMARY OF TEST RESULTS

The EUT has been tested according to the following specifications:

APPLIED STANDARD: FCC Part 15, Subpart F			
Standard Section	Test Type and Limit	Result	REMARK
15.207	AC Power Conducted Emission	PASS	Meet the requirement of limit. Minimum passing margin is -22.99dB at 2.402MHz.
15.519(b)	UWB Bandwidth	PASS	Meet the requirement of limit.
15.209 15.519(c)	Radiated Emissions	PASS	Meet the requirement of limit. Minimum passing margin is -1.17dB at 52.36MHz.
15.209 15.519(d)	Radiated Emissions in GPS Band	PASS	Meet the requirement of limit. Minimum passing margin is -34.03dB at 1584.00MHz.
15.519(e)	Peak Emissions within a 50MHz Bandwidth	PASS	Meet the requirement of limit. Minimum passing margin is -1.12dB at 3664.00MHz.

2.1 MEASUREMENT UNCERTAINTY

Where relevant, the following measurement uncertainty levels have been estimated for tests performed on the EUT as specified in CISPR 16-4-2:

MEASUREMENT	FREQUENCY	UNCERTAINTY
Conducted emissions	9kHz~30MHz	2.44 dB
Radiated emissions	30MHz ~ 200MHz	3.34 dB
	200MHz ~1000MHz	3.35 dB
	1GHz ~ 18GHz	2.26 dB
	18GHz ~ 40GHz	1.94 dB

This uncertainty represents an expanded uncertainty expressed at approximately the 95% confidence level using a coverage factor of k=2.

3 GENERAL INFORMATION

3.1 GENERAL DESCRIPTION OF EUT

PRODUCT	Wireless USB Host Adapter
MODEL NO.	GUWA200
FCC ID	QLE-GUWA200
POWER SUPPLY	5.0Vdc from host equipment
MODULATION TECHNOLOGY	MOFDM
FREQUENCY RANGE	3.1 to 4.8GHz (Supporting up to 3 MBOA sub-bands, 528MHz each)
MAXIMUM OUTPUT POWER	-25.56dBm (69.64dBuV/m)
ANTENNA TYPE	Dipole antenna with 1.00dBi gain Dipole antenna with 1.68dBi gain
I/O PORTS	USB
DATA CABLE	NA
ACCESSORY DEVICES	NA

NOTE:

1. There are two antennas provided for the test. After pre-testing both antennas, dipole antenna with 1.68dBi gain was the worst case and only the data was recorded in the report.
2. The above EUT information was declared by manufacturer and for more detailed features description, please refer to the manufacturer's specifications or User's Manual.

3.2 DESCRIPTION OF TEST MODES

Four transmission modes are provided to this EUT.

MODE	SUB-BAND	FREQUENCY (MHz)
1	1	3432
2	2	3960
3	3	4488
4	1 + 2 + 3	3432, 3960, 4488

NOTE: After pre-testing each mode, the mode 4 (TCF3, 53.3Mbps) was the worst situation and only the data was presented in the following sections.

3.2.1 CONFIGURATION OF SYSTEM UNDER TEST

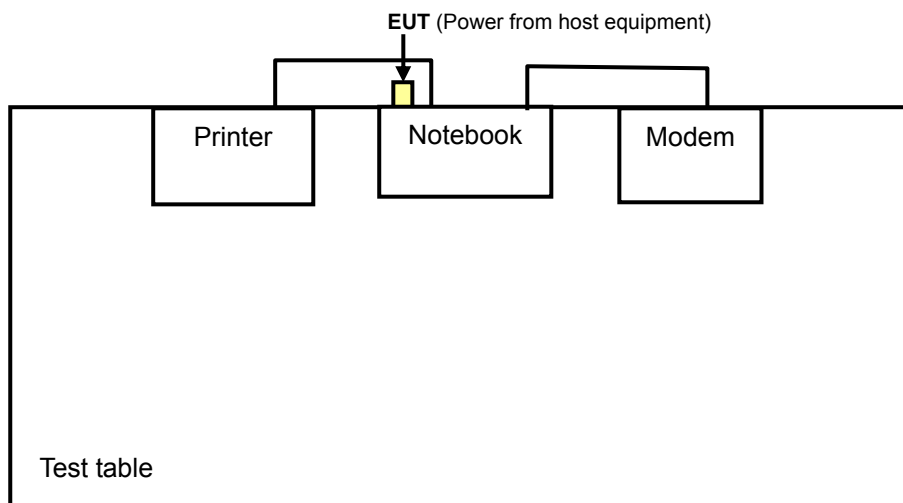

3.2.2 TEST MODE APPLICABILITY AND TESTED CHANNEL DETAIL

EUT configure mode	Applicable to					Description
	PLC	RE<1G	RE≥1G	UB	PE	
4	√	√	√	√	√	Sub-band 1 + 2 + 3

Where **PLC**: Power Line Conducted Emission **RE<1G**: Radiated Emission below 1GHz
RE≥1G: Radiated Emission above 1GHz **UB**:UBW Bandwidth
PE: Peak Emission

POWER LINE CONDUCTED EMISSION TEST:

- Pre-Scan has been conducted to determine the worst-case mode from all possible combinations between available modulations and antenna ports (if EUT with antenna diversity architecture).
- Following channel(s) was (were) selected for the final test as listed below.

EUT configure mode	Tested Sub-band	Modulation Technology
4	1 + 2 + 3	OFDM

RADIATED EMISSION TEST (BELOW 960 MHz):

- Pre-Scan has been conducted to determine the worst-case mode from all possible combinations between available modulations and antenna ports (if EUT with antenna diversity architecture).
- Following channel(s) was (were) selected for the final test as listed below.

EUT configure mode	Tested Sub-band	Modulation Technology
4	1 + 2 + 3	OFDM

RADIATED EMISSION TEST (ABOVE 960 MHz):

- Pre-Scan has been conducted to determine the worst-case mode from all possible combinations between available modulations and antenna ports (if EUT with antenna diversity architecture).
- Following channel(s) was (were) selected for the final test as listed below.

EUT configure mode	Tested Sub-band	Modulation Technology
4	1 + 2 + 3	OFDM

UWB BANDWIDTH MEASUREMENT:

- Pre-Scan has been conducted to determine the worst-case mode from all possible combinations between available modulations and antenna ports (if EUT with antenna diversity architecture).
- Following channel(s) was (were) selected for the final test as listed below.

EUT configure mode	Tested Sub-band	Modulation Technology
4	1 + 2 + 3	OFDM

PEAK EMISSION MEASUREMENT

- Pre-Scan has been conducted to determine the worst-case mode from all possible combinations between available modulations and antenna ports (if EUT with antenna diversity architecture).
- Following channel(s) was (were) selected for the final test as listed below.

EUT configure mode	Tested Sub-band	Modulation Technology
4	1 + 2 + 3	OFDM

3.3 GENERAL DESCRIPTION OF APPLIED STANDARDS

The EUT is a UWB product. According to the specifications of the manufacturer, it must comply with the requirements of the following standards:

FCC Part 15, Subpart F. (15.519)

ANSI C63.4-2003

THE EVOLUTION OF MODERN UWB TECHNOLOGY

All test items have been performed and recorded as per the above standards.

NOTE: The EUT is also considered as a kind of computer peripheral, because the connection to computer is necessary for typical use. It has been verified to comply with the requirements of FCC Part 15, Subpart B, Class B (DoC). The test report has been issued separately.



3.4 DESCRIPTION OF SUPPORT UNITS

The EUT has been tested as an independent unit together with other necessary accessories or support units. The following support units or accessories were used to form a representative test configuration during the tests.

NO.	PRODUCT	BRAND	MODEL NO.	SERIAL NO.	FCC ID
1	NOTEBOOK COMPUTER	HP	nc6000	CNTWM3B2200 BGA	FCC DoC Approved
2	PRINTER	EPSON	LQ-300+	DCGY047265	FCC DoC Approved
3	MODEM	ACEEX	1414V/3	0401008269	IFAXDM1414

NO.	SIGNAL CABLE DESCRIPTION OF THE ABOVE SUPPORT UNITS
1	NA
	1.8m braid shielded wire , DB25 connector , w/o core.
	1.2m braid shielded wire , DB25 & DB9 connector , w/o core.

NOTE: All power cords of the above support units are non-shielded (1.8m).



3.5 OPEARTIONAL LIMATIIONS

FCC 47 CFR Section 15.519(a)(1)

- (1) A UWB device operating under the provisions of this section shall transmit only when it is sending information to an associated receiver. The UWB intentional radiator shall cease transmission within 10 seconds unless it receives an acknowledgement from the associated receiver that its transmission is being received. An acknowledgment of reception must continue to be received by the UWB intentional radiator at least every 10 seconds or the UWB device must cease transmitting.

Client has been advised and showed on users manual.

FCC 47 CFR Section 15.519(a)(2)

- (2) The use of antennas mounted on outdoor structures, *e.g.*, antennas mounted on the outside of a building or on a telephone pole, or any fixed outdoors infrastructure is prohibited. Antennas may be mounted only on the hand held UWB device.

The antenna used in this product is Dipole antenna.

FCC 47 CFR Section 15.519(a)(3)

- (3) UWB devices operating under the provisions of this section may operate indoors or outdoors.

4 TEST TYPES AND RESULTS

4.1 CONDUCTED EMISSION MEASUREMENT

4.1.1 LIMITS OF CONDUCTED EMISSION MEASUREMENT

FREQUENCY OF EMISSION (MHz)	CONDUCTED LIMIT (dB μ V)	
	Quasi-peak	Average
0.15-0.5	66 to 56	56 to 46
0.5-5	56	46
5-30	60	50

- NOTE:**
1. The lower limit shall apply at the transition frequencies.
 2. The limit decreases in line with the logarithm of the frequency in the range of 0.15 to 0.50 MHz.
 3. All emanations from a class A/B digital device or system, including any network of conductors and apparatus connected thereto, shall not exceed the level of field strengths specified above.

4.1.2 TEST INSTRUMENTS

DESCRIPTION & MANUFACTURER	MODEL NO.	SERIAL NO.	CALIBRATED UNTIL
Test Receiver ROHDE & SCHWARZ	ESCS30	100289	Dec. 06, 2008
RF signal cable Woken	5D-FB	Cable-HYC01-01	Jan. 06, 2009
LISN ROHDE & SCHWARZ	ESH3-Z5	100312	Jan. 30, 2009
LISN ROHDE & SCHWARZ	ESH2-Z5	100104	Sep. 11, 2008
Software ADT	ADT_Cond_V3	NA	NA

- NOTE:**
1. The calibration interval of the above test instruments is 12 months and the calibrations are traceable to NML/ROC and NIST/USA.
 2. The test was performed in HwaYa Shielded Room 1.
 3. The VCCI Site Registration No. is C-2040.



4.1.3 TEST PROCEDURES

- a. The EUT was placed 0.4 meters from the conducting wall of the shielded room with EUT being connected to the power mains through a line impedance stabilization network (LISN). Other support units were connected to the power mains through another LISN. The two LISNs provide 50 ohm/ 50uH of coupling impedance for the measuring instrument.
- b. Both lines of the power mains connected to the EUT were checked for maximum conducted interference.
- c. The frequency range from 150kHz to 30MHz was searched. Emission levels under Limit - 20dB was not recorded.

4.1.4 DEVIATION FROM TEST STANDARD

No deviation

4.1.5 TEST SETUP

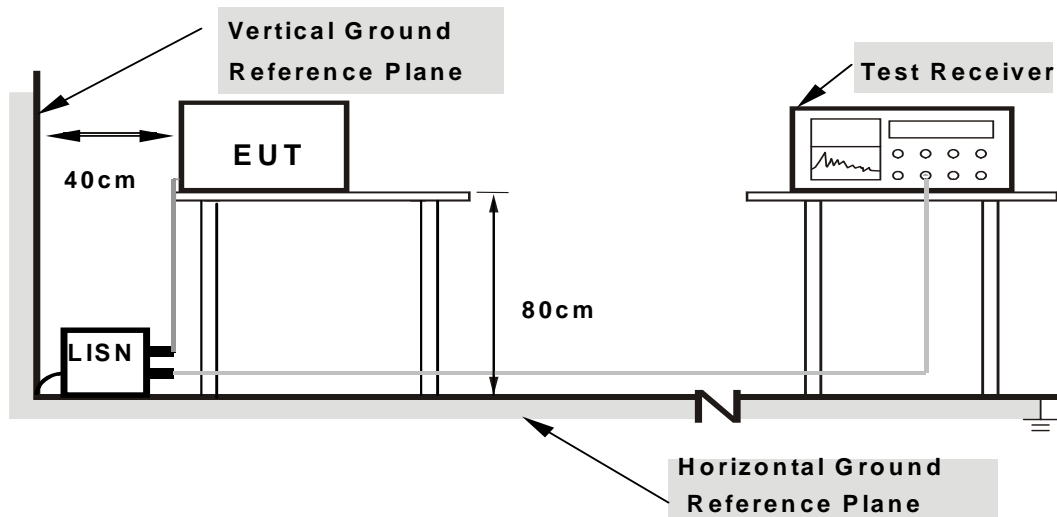

- Note:**
- 1.Support units were connected to second LISN.
 - 2.Both of LISNs (AMN) are 80 cm from EUT and at least 80 from other units and other metal planes

For the actual test configuration, please refer to the attached file (Test Setup Photo).

4.1.6 EUT OPERATING CONDITIONS

- a. Connected the EUT to notebook and placed on a testing table.
- b. The notebook ran a test program (provided by manufacturer) to enable EUT under transmission condition continuously at specific channel frequency.
- c. The necessary accessories enable the system in full functions.

4.1.7 TEST RESULTS

CONDUCTED WORST-CASE DATA

EUT TEST CONDITION		MEASUREMENT DETAIL	
SUB-BAND	1 + 2 + 3	PHASE	Line 1
MODULATION TECHNOLOGY	MOFDM	6dB BANDWIDTH	9 kHz
ENVIRONMENTAL CONDITIONS	25deg. C, 65%RH, 991hPa	INPUT POWER (SYSTEM)	120Vac, 60 Hz
TESTED BY	Kevin Liang		

No	Freq. [MHz]	Corr.	Reading Value		Emission Level		Limit		Margin	
		Factor	[dB (uV)]		[dB (uV)]		[dB (uV)]		(dB)	
		(dB)	Q.P.	AV.	Q.P.	AV.	Q.P.	AV.	Q.P.	AV.
1	0.150	0.20	42.27	-	42.47	-	66.00	56.00	-23.53	-
2	0.201	0.20	38.71	-	38.91	-	63.58	53.58	-24.67	-
3	0.334	0.20	33.98	-	34.18	-	59.36	49.36	-25.18	-
4	2.402	0.24	32.77	-	33.01	-	56.00	46.00	-22.99	-
5	5.184	0.43	25.47	-	25.90	-	60.00	50.00	-34.10	-
6	16.294	0.85	26.27	-	27.12	-	60.00	50.00	-32.88	-

- REMARKS:**
1. Q.P. and AV. are abbreviations of quasi-peak and average individually.
 2. "-": The Quasi-peak reading value also meets average limit and measurement with the average detector is unnecessary.
 3. The emission levels of other frequencies were very low against the limit.
 4. Margin value = Emission level - Limit value
 5. Correction factor = Insertion loss + Cable loss
 6. Emission Level = Correction Factor + Reading Value.

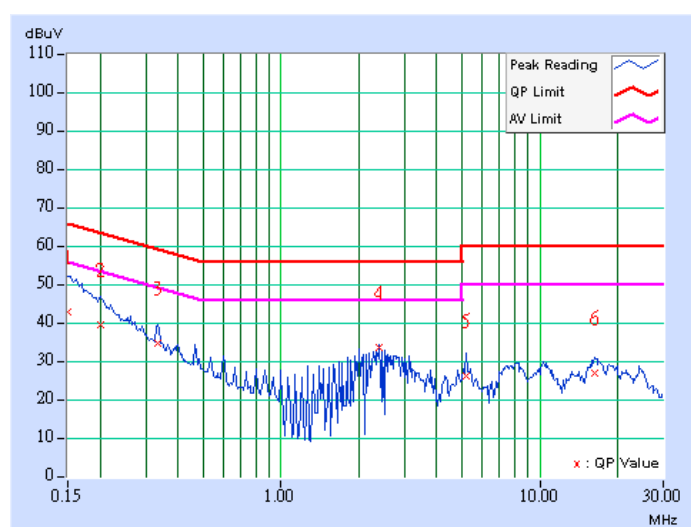

EUT TEST CONDITION		MEASUREMENT DETAIL	
SUB-BAND	1 + 2 + 3	PHASE	Line 2
MODULATION TECHNOLOGY	MOFDM	6dB BANDWIDTH	9 kHz
ENVIRONMENTAL CONDITIONS	25deg. C, 65%RH, 991hPa	INPUT POWER (SYSTEM)	120Vac, 60 Hz
TESTED BY	Kevin Liang		

No	Freq. [MHz]	Corr. Factor (dB)	Reading Value [dB (uV)]		Emission Level [dB (uV)]		Limit [dB (uV)]		Margin (dB)	
			Q.P.	AV.	Q.P.	AV.	Q.P.	AV.	Q.P.	AV.
1	0.150	0.20	42.33	-	42.53	-	66.00	56.00	-23.47	-
2	0.201	0.20	36.62	-	36.82	-	63.57	53.57	-26.75	-
3	0.469	0.20	26.63	-	26.83	-	56.53	46.53	-29.70	-
4	2.273	0.23	31.09	-	31.32	-	56.00	46.00	-24.68	-
5	7.694	0.48	27.70	-	28.18	-	60.00	50.00	-31.82	-
6	16.597	0.50	26.36	-	26.86	-	60.00	50.00	-33.14	-

- REMARKS:**
1. Q.P. and AV. are abbreviations of quasi-peak and average individually.
 2. "-": The Quasi-peak reading value also meets average limit and measurement with the average detector is unnecessary.
 3. The emission levels of other frequencies were very low against the limit.
 4. Margin value = Emission level - Limit value
 5. Correction factor = Insertion loss + Cable loss
 6. Emission Level = Correction Factor + Reading Value.

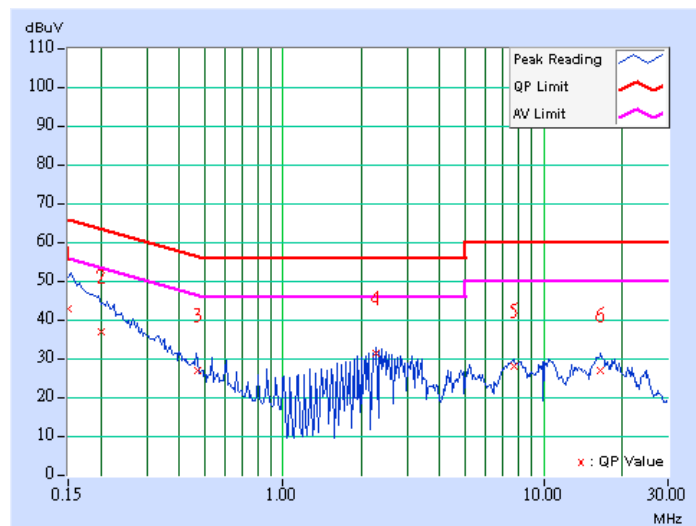

4.2 RADIATED EMISSION MEASUREMENT (FOR 15.519 (c))

4.2.1 LIMITS OF RADIATED EMISSION MEASUREMENT

The radiated emissions at or below 960MHz from a device operating under the provisions of this section shall not exceed the emission levels in Section 15.209.

FREQUENCIES (MHz)	FIELD STRENGTH (mV/m)	MEASUREMENT DISTANCE (m)
0.009 ~ 0.490	2400/F(kHz)	300
0.490 ~ 1.705	24000/F(kHz)	30
1.705 ~ 30.0	30	30
30 ~ 88	100	3
88 ~ 216	150	3
216 ~ 960	200	3

NOTE: 1. The lower limit shall apply at the transition frequencies.

2. Emission level (dBuV/m) = 20 log Emission level (uV/m).

The radiated emissions above 960MHz from a device operating under the provisions of this section shall not exceed the following average limits when measured using a resolution bandwidth of 1MHz:

FREQUENCY IN MHz	EIRP IN dBm	dBuV/m@3m	dBuV/m@1m
960 ~ 1,610	-75.3	19.9	29.44
1,610 ~ 1,990	-63.3	31.9	41.44
1,990 ~ 3,100	-61.3	33.9	43.44
3,100 ~ 10,600	-41.3	53.9	63.44
Above 10600	-51.3	43.9	53.44

Transfer rules follow 15.521(g),15.31(f)(1).

15.521(c) Emissions from digital circuitry used to enable the operation of the UWB transmitter shall comply with the limits in Section 15.209 of this chapter, rather than the limits specified in this subpart.

NOTE: Use conducted measurement to determine emissions is from digital circuitry or not.
Emissions from digital circuitry follow 15.209.

The radiated emissions from a device operating under the provisions of this section shall not exceed the emission levels in Section 15.209.

FREQUENCY IN MHz	dBuV/m@3m	dBuV/m@1m
	Quasi Peak	Quasi Peak
216 ~ 960	46.00	55.54
960 ~ 1000	54.00	63.54

FREQUENCY IN MHz	dBuV/m@3m		dBuV/m@1m	
Above 1000	Peak	Average	Peak	Average
	74.00	54.00	83.54	63.54

4.2.2 INSTRUMENT SETUP VALUE AND MEASUREMENT DISTANCE

FREQUENCY RANGE	RESOLUTION BANDWIDTH	VIDEO BANDWIDTH	DETECTOR	MEASUREMENT DISTANCE
Below 960MHz	120kHz	120kHz	Quasi Peak	3 meters
Above 960MHz	1MHz	3MHz	RMS	1 meter



4.2.3 TEST INSTRUMENTS

DESCRIPTION & MANUFACTURER	MODEL NO.	SERIAL NO.	CALIBRATED UNTIL
Test Receiver ROHDE & SCHWARZ	ESCI	100424	Jul. 27, 2008
Spectrum Analyzer Agilent	E4446A	MY44360128	Dec. 06, 2008
BILOG Antenna SCHWARZBECK	VULB9168	9168-160	May 01, 2009
HORN Antenna SCHWARZBECK	9120D	9120D-209	Jun. 28, 2008
HORN Antenna SCHWARZBECK	BBHA 9170	BBHA9170243	Dec. 24, 2008
Preamplifier Agilent	8447D	2944A10633	Oct. 28, 2008
Preamplifier Agilent	8449B	3008A01964	Oct. 23, 2008
RF signal cable HUBER+SUHNNER	SUCOFLEX 104	283402/4	Dec. 06, 2008
RF signal cable HUBER+SUHNNER	SUCOFLEX 104	251644/4	Dec. 06, 2008
Software ADT.	ADT_Radiated_V7.6	NA	NA
Antenna Tower inn-co GmbH	MA 4000	013303	NA
Antenna Tower Controller inn-co GmbH	CO2000	017303	NA
Turn Table ADT.	TT100.	TT93021703	NA
Turn Table Controller ADT.	SC100.	SC93021703	NA

- NOTE:**
1. The calibration interval of the above test instruments is 12 months and the calibrations are traceable to NML/ROC and NIST/USA.
 2. The test was performed in HwaYa Chamber 3.
 3. The horn antenna and HP preamplifier (model: 8449B) are used only for the measurement of emission frequency above 1GHz if tested.
 4. The FCC Site Registration No. is 988962.
 5. The IC Site Registration No. is IC3789B-3.



4.2.4 TEST PROCEDURES

- a. The EUT was placed on the top of a rotating table 0.8 meters above the ground at a 3 meters semi-anechoic chamber. The table was rotated 360 degrees to determine the position of the highest radiation.
- b. The EUT was set 1, 3 meters away from the interference-receiving antenna, which was mounted on the top of a variable-height antenna tower.
- c. The antenna is a broadband antenna, and its height is varied from one meter to four meters above the ground to determine the maximum value of the field strength. Both horizontal and vertical polarizations of the antenna are set to make the measurement.
- d. For each suspected emission, the EUT was arranged to its worst case and then the antenna was tuned to heights from 1 meter to 4 meters and the rotatable table was turned from 0 degrees to 360 degrees to find the maximum reading.

4.2.5 DEVIATION FROM TEST STANDARD

No deviation

4.2.6 TEST SETUP

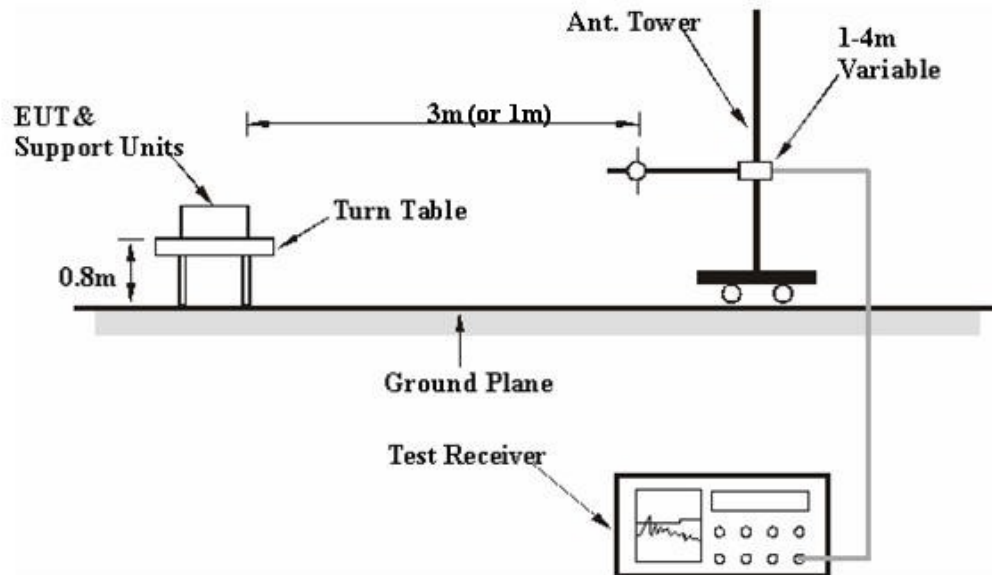

For the actual test configuration, please refer to the attached file (Test Setup Photo).

4.2.7 EUT OPERATING CONDITIONS

Same as 4.1.6

4.2.8 TEST RESULTS

RADIATED BELOW 960MHz WORST-CASE DATA

EUT TEST CONDITION		MEASUREMENT DETAIL	
SUB-BAND	1 + 2 + 3	FREQUENCY RANGE	Below 960MHz
MODULATION TECHNOLOGY	MOFDM	DETECTOR FUNCTION	Quasi-Peak
ENVIRONMENTAL CONDITIONS	25deg. C, 65%RH, 985hPa	INPUT POWER (SYSTEM)	120Vac, 60 Hz
TESTED BY	Brad Wu		

ANTENNA POLARITY & TEST DISTANCE: HORIZONTAL AT 3 M								
No.	Freq. (MHz)	Emission Level (dBuV/m)	Limit (dBuV/m)	Margin (dB)	Antenna Height (m)	Table Angle (Degree)	Raw Value (dBuV)	Correction Factor (dB/m)
1	389.70	41.27 QP	46.00	-4.73	1.00 H	100	23.87	17.40
2	430.70	42.00 QP	46.00	-4.00	1.00 H	127	23.28	18.72
3	466.11	42.88 QP	46.00	-3.12	2.00 H	52	23.20	19.69
4	479.16	42.21 QP	46.00	-3.79	2.00 H	283	22.29	19.92
5	520.16	41.33 QP	46.00	-4.67	1.50 H	70	20.65	20.68
6	540.66	40.64 QP	46.00	-5.36	1.50 H	79	19.57	21.07
7	721.44	40.40 QP	46.00	-5.60	1.00 H	322	15.58	24.82
8	831.40	44.05 QP	46.00	-1.95	1.00 H	241	17.49	26.56

ANTENNA POLARITY & TEST DISTANCE: VERTICAL AT 3 M								
No.	Freq. (MHz)	Emission Level (dBuV/m)	Limit (dBuV/m)	Margin (dB)	Antenna Height (m)	Table Angle (Degree)	Raw Value (dBuV)	Correction Factor (dB/m)
1	52.36	38.83 QP	40.00	-1.17	1.00 V	349	24.14	14.69
2	67.27	38.65 QP	40.00	-1.35	1.00 V	10	25.60	13.05
3	125.05	39.80 QP	43.50	-3.70	1.00 V	37	26.88	12.92
4	426.97	41.16 QP	46.00	-4.84	1.00 V	10	22.57	18.59
5	458.66	44.36 QP	46.00	-1.64	1.00 V	1	24.81	19.55
6	479.16	44.22 QP	46.00	-1.78	1.00 V	10	24.30	19.92
7	520.16	42.72 QP	46.00	-3.28	1.00 V	346	22.04	20.68
8	540.66	40.01 QP	46.00	-5.99	1.00 V	346	18.94	21.07
9	719.58	40.36 QP	46.00	-5.64	1.50 V	10	15.60	24.77

- REMARKS:**
1. Emission level(dBuV/m)=Raw Value(dBuV) + Correction Factor(dB/m)
 2. Correction Factor(dB/m) = Antenna Factor (dB/m) + Cable Factor (dB)
 3. The other emission levels were very low against the limit.
 4. Margin value = Emission level – Limit value.

RADIATED ABOVE 960MHz DATA

EUT TEST CONDITION		MEASUREMENT DETAIL	
SUB-BAND	1 + 2 + 3	FREQUENCY RANGE	960MHz ~ 40GHz
MODULATION TECHNOLOGY	MOFDM	DETECTOR FUNCTION	RMS
INPUT POWER (SYSTEM)	120Vac, 60 Hz	ENVIRONMENTAL CONDITIONS	19deg. C, 66%RH, 985hPa
TESTED BY	Dean Wang		

ANTENNA POLARITY & TEST DISTANCE: HORIZONTAL AT 1m								
No.	Freq. (MHz)	Emission Level (dBuV/m)	Limit (dBuV/m)	Margin (dB)	Antenna Height (m)	Table Angle (Degree)	Raw Value (dBuV)	Correction Factor (dB/m)
1	2904.00	35.22	43.44	-8.22	1.00 H	19	1.28	33.94
2	3596.00	44.31	63.44	-19.13	1.00 H	245	9.42	34.89
3	4044.00	46.63	63.44	-16.81	1.00 H	183	10.49	36.14
4	4628.00	44.36	63.44	-19.08	1.00 H	245	6.63	37.73
5	6864.00	43.81	63.44	-19.63	1.00 H	19	0.75	43.06
6	7920.00	45.32	63.44	-18.12	1.00 H	195	-0.20	45.52
7	8976.00	46.23	63.44	-17.21	1.00 H	162	-0.48	46.71

ANTENNA POLARITY & TEST DISTANCE: VERTICAL AT 1m								
No.	Freq. (MHz)	Emission Level (dBuV/m)	Limit (dBuV/m)	Margin (dB)	Antenna Height (m)	Table Angle (Degree)	Raw Value (dBuV)	Correction Factor (dB/m)
1	2904.00	41.95	43.44	-1.49	1.00 V	6	8.01	33.94
2	3660.00	57.72	63.44	-5.72	1.02 V	317	22.65	35.07
3	3764.00	57.16	63.44	-6.28	1.00 V	319	21.83	35.33
4	4616.00	54.85	63.44	-8.59	1.00 V	149	17.15	37.70
5	6864.00	44.12	63.44	-19.32	1.00 V	12	1.06	43.06
6	7920.00	45.67	63.44	-17.77	1.00 V	162	0.16	45.52
7	8976.00	46.49	63.44	-16.95	1.00 V	219	-0.22	46.71

- REMARKS:**
1. Emission level(dBuV/m)=Raw Value(dBuV) + Correction Factor(dB/m)
 2. Correction Factor(dB/m) = Antenna Factor (dB/m) + Cable Factor (dB)
 3. The other emission levels were very low against the limit.
 4. Margin value = Emission level – Limit value.

EMISSIONS FROM DIGITAL CIRCUITRY

EUT TEST CONDITION		MEASUREMENT DETAIL	
SUB-BAND	1 + 2 + 3	FREQUENCY RANGE	Above 1GHz
MODULATION TECHNOLOGY	MOFDM	DETECTOR FUNCTION	Peak / Average
INPUT POWER (SYSTEM)	120Vac, 60 Hz	ENVIRONMENTAL CONDITIONS	25deg. C, 65%RH, 985hPa
TESTED BY	Brad Wu		

ANTENNA POLARITY & TEST DISTANCE: HORIZONTAL AT 1 M								
No.	Freq. (MHz)	Emission Level (dBuV/m)	Limit (dBuV/m)	Margin (dB)	Antenna Height (m)	Table Angle (Degree)	Raw Value (dBuV)	Correction Factor (dB/m)
1	1056.00	29.56 PK	83.54	-53.98	1.01 H	233	0.35	29.21
2	1056.00	21.48 AV	63.54	-42.06	1.01 H	233	-7.73	29.21

REMARKS:

1. Emission source for each frequency.

Emission source	Frequency (MHz)	Possible corresponding spurious CW tones (MHz) (X times harmonic)
PLL	1056.00	1056 (x1)
PLL	528.00	1056 (x2)
PLL	264.00	1056 (x4)
XTAL of PHY	66.00	1056 (x16)

2. Emission level(dBuV/m)=Raw Value(dBuV) + Correction Factor(dB/m)

3. Correction Factor(dB/m) = Antenna Factor (dB/m) + Cable Factor (dB)

4. The other emission levels were very low against the limit.

5. Margin value = Emission level – Limit value.

EUT TEST CONDITION		MEASUREMENT DETAIL	
SUB-BAND	1 + 2 + 3	FREQUENCY RANGE	Above 1GHz
MODULATION TECHNOLOGY	MOFDM	DETECTOR FUNCTION	Peak / Average
INPUT POWER (SYSTEM)	120Vac, 60 Hz	ENVIRONMENTAL CONDITIONS	25deg. C, 65%RH, 985hPa
TESTED BY	Brad Wu		

ANTENNA POLARITY & TEST DISTANCE: VERTICAL AT 1 M								
No.	Freq. (MHz)	Emission Level (dBuV/m)	Limit (dBuV/m)	Margin (dB)	Antenna Height (m)	Table Angle (Degree)	Raw Value (dBuV)	Correction Factor (dB/m)
1	1056.00	36.06 PK	83.54	-47.48	1.03 V	241	6.85	29.21
2	1056.00	27.92 AV	63.54	-35.62	1.03 V	241	-1.29	29.21

REMARKS:

1. Emission source for each frequency.

Emission source	Frequency (MHz)	Possible corresponding spurious CW tones (MHz) (X times harmonic)
PLL	1056.00	1056 (x1)
PLL	528.00	1056 (x2)
PLL	264.00	1056 (x4)
XTAL of PHY	66.00	1056 (x16)

2. Emission level(dBuV/m)=Raw Value(dBuV) + Correction Factor(dB/m)
3. Correction Factor(dB/m) = Antenna Factor (dB/m) + Cable Factor (dB)
4. The other emission levels were very low against the limit.
5. Margin value = Emission level – Limit value.



EMISSIONS FROM NOTEBOOK

INPUT POWER (SYSTEM)	120Vac, 60 Hz	FREQUENCY RANGE	30MHz ~ 1GHz
ENVIRONMENTAL CONDITIONS	25deg. C, 65%RH, 985hPa	DETECTOR FUNCTION	Quasi - Peak
TESTED BY	Brad Wu		

ANTENNA POLARITY & TEST DISTANCE: HORIZONTAL AT 1m								
No.	Freq. (MHz)	Emission Level (dBuV/m)	Limit (dBuV/m)	Margin (dB)	Antenna Height (m)	Table Angle (Degree)	Raw Value (dBuV)	Correction Factor (dB/m)
1	994.00	35.28 QP	63.54	-28.26	1.50 H	175	6.66	28.62

ANTENNA POLARITY & TEST DISTANCE: VERTICAL AT 1m								
No.	Freq. (MHz)	Emission Level (dBuV/m)	Limit (dBuV/m)	Margin (dB)	Antenna Height (m)	Table Angle (Degree)	Raw Value (dBuV)	Correction Factor (dB/m)
1	994.00	41.12 QP	63.54	-22.42	1.00 V	25	12.50	28.62

- REMARKS:**
1. Emission level(dBuV/m)=Raw Value(dBuV) + Correction Factor(dB/m)
 2. Correction Factor(dB/m) = Antenna Factor (dB/m) + Cable Factor (dB)
 3. The other emission levels were very low against the limit.
 4. Margin value = Emission level – Limit value.



INPUT POWER (SYSTEM)	120Vac, 60 Hz	FREQUENCY RANGE	Above 1GHz
ENVIRONMENTAL CONDITIONS	25deg. C, 65%RH, 985hPa	DETECTOR FUNCTION	Peak / Average
TESTED BY	Brad Wu		

ANTENNA POLARITY & TEST DISTANCE: HORIZONTAL AT 1m								
No.	Freq. (MHz)	Emission Level (dBuV/m)	Limit (dBuV/m)	Margin (dB)	Antenna Height (m)	Table Angle (Degree)	Raw Value (dBuV)	Correction Factor (dB/m)
1	1172.00	39.85 PK	83.54	-43.69	1.00 H	208	10.35	29.5
2	1172.00	28.80 AV	63.54	-34.74	1.00 H	208	-0.70	29.5
3	1195.00	38.58 PK	83.54	-44.96	1.00 H	236	9.03	29.55
4	1195.00	27.52 AV	63.54	-36.02	1.00 H	236	-2.03	29.55
5	1218.00	38.21 PK	83.54	-45.33	1.00 H	112	8.61	29.6
6	1218.00	27.06 AV	63.54	-36.48	1.00 H	112	-2.54	29.6
7	1578.00	40.28 PK	83.54	-43.26	1.00 H	19	9.88	30.4
8	1578.00	28.00 AV	63.54	-35.54	1.00 H	19	-2.40	30.4
9	1605.00	40.21 PK	83.54	-43.33	1.00 H	324	9.80	30.41
10	1605.00	28.90 AV	63.54	-34.64	1.00 H	324	-1.51	30.41

ANTENNA POLARITY & TEST DISTANCE: VERTICAL AT 1m								
No.	Freq. (MHz)	Emission Level (dBuV/m)	Limit (dBuV/m)	Margin (dB)	Antenna Height (m)	Table Angle (Degree)	Raw Value (dBuV)	Correction Factor (dB/m)
1	1172.00	40.36 PK	83.54	-43.18	1.00 V	166	10.86	29.5
2	1172.00	29.31 AV	63.54	-34.23	1.00 V	166	-0.19	29.5
3	1195.00	39.02 PK	83.54	-44.52	1.00 V	335	9.47	29.55
4	1195.00	28.06 AV	63.54	-35.48	1.00 V	335	-1.49	29.55
5	1218.00	38.66 PK	83.54	-44.88	1.00 V	139	9.06	29.6
6	1218.00	27.51 AV	63.54	-36.03	1.00 V	139	-2.09	29.6
7	1578.00	40.62 PK	83.54	-42.92	1.00 V	24	10.22	30.4
8	1578.00	28.39 AV	63.54	-35.15	1.00 V	24	-2.01	30.4
9	1605.00	40.58 PK	83.54	-42.96	1.00 V	348	10.17	30.41
10	1605.00	29.24 AV	63.54	-34.30	1.00 V	348	-1.17	30.41

- REMARKS:**
1. Emission level(dBuV/m)=Raw Value(dBuV) + Correction Factor(dB/m)
 2. Correction Factor(dB/m) = Antenna Factor (dB/m) + Cable Factor (dB)
 3. The other emission levels were very low against the limit.
 4. Margin value = Emission level – Limit value.

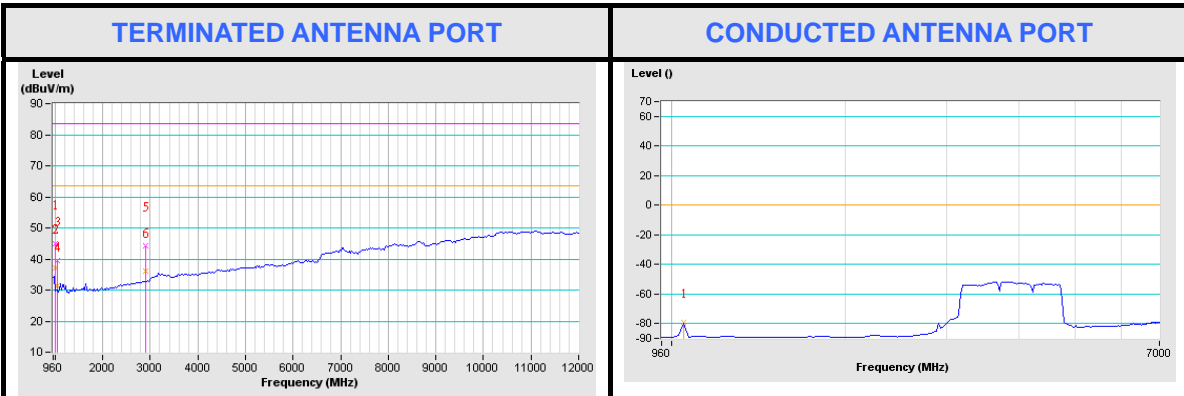

4.3 RADIATED EMISSION MEASUREMENT (FOR 15.519 (d))

4.3.1 LIMITS OF RADIATED EMISSION MEASUREMENT

FREQUENCY IN MHz	EIRP IN dBm	dBuV/m@3m	dBuV/m@1m
1,164 ~ 1,240	-85.3	9.9	19.44
1,559 ~ 1,610	-85.3	9.9	19.44

Transfer rules follow 15.521(g), 15.31(f)(1).

- NOTE:**
- 15.521(g) converted to a peak field strength level at 3 meters using $E(\text{dBuV/m}) = P(\text{dBmEIRP}) + 95.2$.
 - 15.31(f)(1) When performing measurements at a distance other than that specified, the results shall be extrapolated to the specified distance using an extrapolation factor of 20 dB/decade, Measurement distance moves from 3m to 1m, Limit (1m) = Limit (3m) + $20\text{Log}(3/1) = \text{Limit}(3\text{m}) + 9.54$.

Instrument Noise Floor

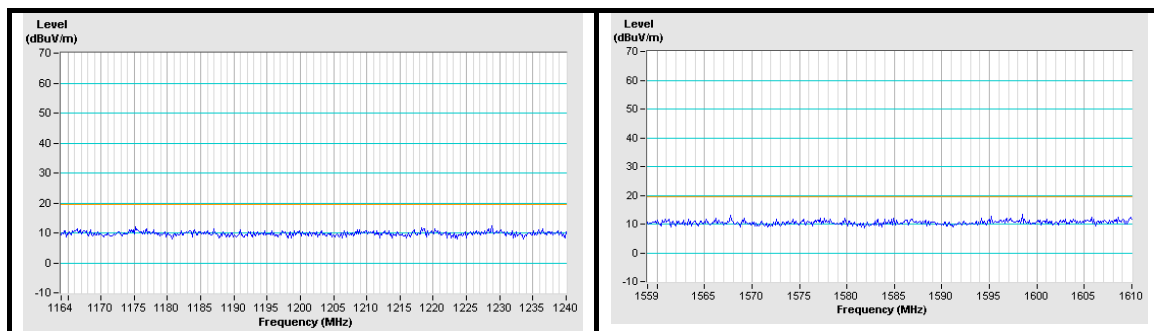

15.521(c) Emissions from digital circuitry used to enable the operation of the UWB transmitter shall comply with the limits in Section 15.209 of this chapter, rather than the limits specified in this subpart.

- NOTE:** Use conducted measurement to determine emissions is from digital circuitry or not. Emissions from digital circuitry follow 15.209 else 15.517

The radiated emissions above 1000MHz from a device operating under the provisions of this section shall not exceed the emission levels in Section 15.209.

FREQUENCY IN MHz	dBuV/m@3m		dBuV/m@1m	
	Peak	Average	Peak	Average
Above 1000	74.00	54.00	83.54	63.54

4.3.2 INSTRUMENT SETUP VALUE AND MEASUREMENT DISTANCE

UWB transmitters operating under the provisions of this section shall not exceed the following average limits when measured using a resolution bandwidth of no less than 1kHz:

FREQUENCY RANGE	RESOLUTION BANDWIDTH	VIDEO BANDWIDTH	DETECTOR	MEASUREMENT DISTANCE
1,164 ~ 1,240	*10kHz	30kHz	RMS	1 meter
1,559 ~ 1,610	*10kHz	30kHz	RMS	1 meter

NOTE: *reference The Evolution of Modern UWB Technology.



4.3.3 TEST INSTRUMENTS

DESCRIPTION & MANUFACTURER	MODEL NO.	SERIAL NO.	CALIBRATED UNTIL
Test Receiver ROHDE & SCHWARZ	ESCI	100424	Jul. 27, 2008
Spectrum Analyzer Agilent	E4446A	MY44360128	Dec. 06, 2008
BILOG Antenna SCHWARZBECK	VULB9168	9168-160	May 01, 2009
HORN Antenna SCHWARZBECK	9120D	9120D-209	Jun. 28, 2008
HORN Antenna SCHWARZBECK	BBHA 9170	BBHA9170243	Dec. 24, 2008
Preamplifier Agilent	8447D	2944A10633	Oct. 28, 2008
Preamplifier Agilent	8449B	3008A01964	Oct. 23, 2008
RF signal cable HUBER+SUHNNER	SUCOFLEX 104	283402/4	Dec. 06, 2008
RF signal cable HUBER+SUHNNER	SUCOFLEX 104	251644/4	Dec. 06, 2008
Software ADT.	ADT_Radiated_V7.6	NA	NA
Antenna Tower inn-co GmbH	MA 4000	013303	NA
Antenna Tower Controller inn-co GmbH	CO2000	017303	NA
Turn Table ADT.	TT100.	TT93021703	NA
Turn Table Controller ADT.	SC100.	SC93021703	NA

- NOTE:**
1. The calibration interval of the above test instruments is 12 months and the calibrations are traceable to NML/ROC and NIST/USA.
 2. The test was performed in HwaYa Chamber 3.
 3. The horn antenna and HP preamplifier (model: 8449B) are used only for the measurement of emission frequency above 1GHz if tested.
 4. The FCC Site Registration No. is 988962.
 5. The IC Site Registration No. is IC3789B-3.



4.3.4 TEST PROCEDURES

- e. The EUT was placed on the top of a rotating table 0.8 meters above the ground at a 1 meters semi-anechoic chamber. The table was rotated 360 degrees to determine the position of the highest radiation.
- f. The EUT was set 1 meters away from the interference-receiving antenna, which was mounted on the top of a variable-height antenna tower.
- g. The antenna is a broadband antenna, and its height is varied from one meter to four meters above the ground to determine the maximum value of the field strength. Both horizontal and vertical polarizations of the antenna are set to make the measurement.
- h. For each suspected emission, the EUT was arranged to its worst case and then the antenna was tuned to heights from 1 meter to 4 meters and the rotatable table was turned from 0 degrees to 360 degrees to find the maximum reading.

4.3.5 DEVIATION FROM TEST STANDARD

No deviation

4.3.6 TEST SETUP

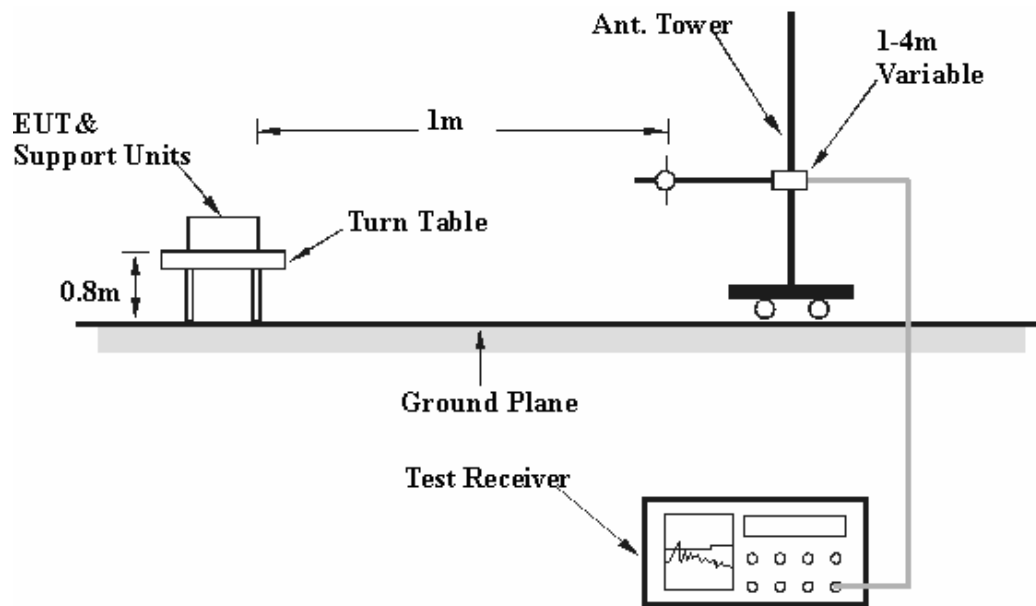

For the actual test configuration, please refer to the attached file (Test Setup Photo).

4.3.7 EUT OPERATING CONDITIONS

Same as 4.1.6

4.3.8 TEST RESULTS

EMISSIONS FROM GPS CIRCUITRY

EUT TEST CONDITION		MEASUREMENT DETAIL	
SUB-BAND	1 + 2 + 3	FREQUENCY RANGE	Above 1GHz
MODULATION TECHNOLOGY	MOFDM	DETECTOR FUNCTION	Peak / Average
INPUT POWER (SYSTEM)	120Vac, 60 Hz	ENVIRONMENTAL CONDITIONS	21deg. C, 66%RH, 985hPa
TESTED BY	Dean Wang		

ANTENNA POLARITY & TEST DISTANCE: HORIZONTAL AT 1m								
No.	Freq. (MHz)	Emission Level (dBuV/m)	Limit (dBuV/m)	Margin (dB)	Antenna Height (m)	Table Angle (Degree)	Raw Value (dBuV)	Correction Factor (dB/m)
1	1200.00	38.64 PK	83.54	-44.90	1.00 H	245	9.08	29.56
2	1200.00	27.29 AV	63.54	-36.25	1.00 H	245	-2.27	29.56
3	1584.00	40.17 PK	83.54	-43.37	1.00 H	26	9.77	30.40
4	1584.00	29.04 AV	63.54	-34.50	1.00 H	26	-1.36	30.40

REMARKS:

1. Emission source for each frequency.

Emission source	Frequency (MHz)	Possible corresponding spurious CW tones (MHz) (X times harmonic)
PLL	528.00	1584 (x3)
XTAL of MAC	12.00	1200 (x100)

2. Emission level(dBuV/m)=Raw Value(dBuV) + Correction Factor(dB/m)

3. Correction Factor(dB/m) = Antenna Factor (dB/m) + Cable Factor (dB)

4. The other emission levels were very low against the limit.

5. Margin value = Emission level – Limit value.

EUT TEST CONDITION		MEASUREMENT DETAIL	
SUB-BAND	1 + 2 + 3	FREQUENCY RANGE	Above 1GHz
MODULATION TECHNOLOGY	MOFDM	DETECTOR FUNCTION	Peak / Average
INPUT POWER (SYSTEM)	120Vac, 60 Hz	ENVIRONMENTAL CONDITIONS	21deg. C, 66%RH, 985hPa
TESTED BY	Dean Wang		

ANTENNA POLARITY & TEST DISTANCE: VERTICAL AT 1m								
No.	Freq. (MHz)	Emission Level (dBuV/m)	Limit (dBuV/m)	Margin (dB)	Antenna Height (m)	Table Angle (Degree)	Raw Value (dBuV)	Correction Factor (dB/m)
1	1200.00	39.13 PK	83.54	-44.41	1.00 V	266	9.57	29.56
2	1200.00	27.81 AV	63.54	-35.73	1.00 V	266	-1.75	29.56
3	1584.00	40.65 PK	83.54	-42.89	1.00 V	0	10.25	30.40
4	1584.00	29.51 AV	63.54	-34.03	1.00 V	0	-0.89	30.40

REMARKS:

1. Emission source for each frequency.

Emission source	Frequency (MHz)	Possible corresponding spurious CW tones (MHz) (X times harmonic)
PLL	528.00	1584 (x3)
XTAL of MAC	12.00	1200 (x100)

2. Emission level(dBuV/m)=Raw Value(dBuV) + Correction Factor(dB/m)

3. Correction Factor(dB/m) = Antenna Factor (dB/m) + Cable Factor (dB)

4. The other emission levels were very low against the limit.

5. Margin value = Emission level – Limit value.

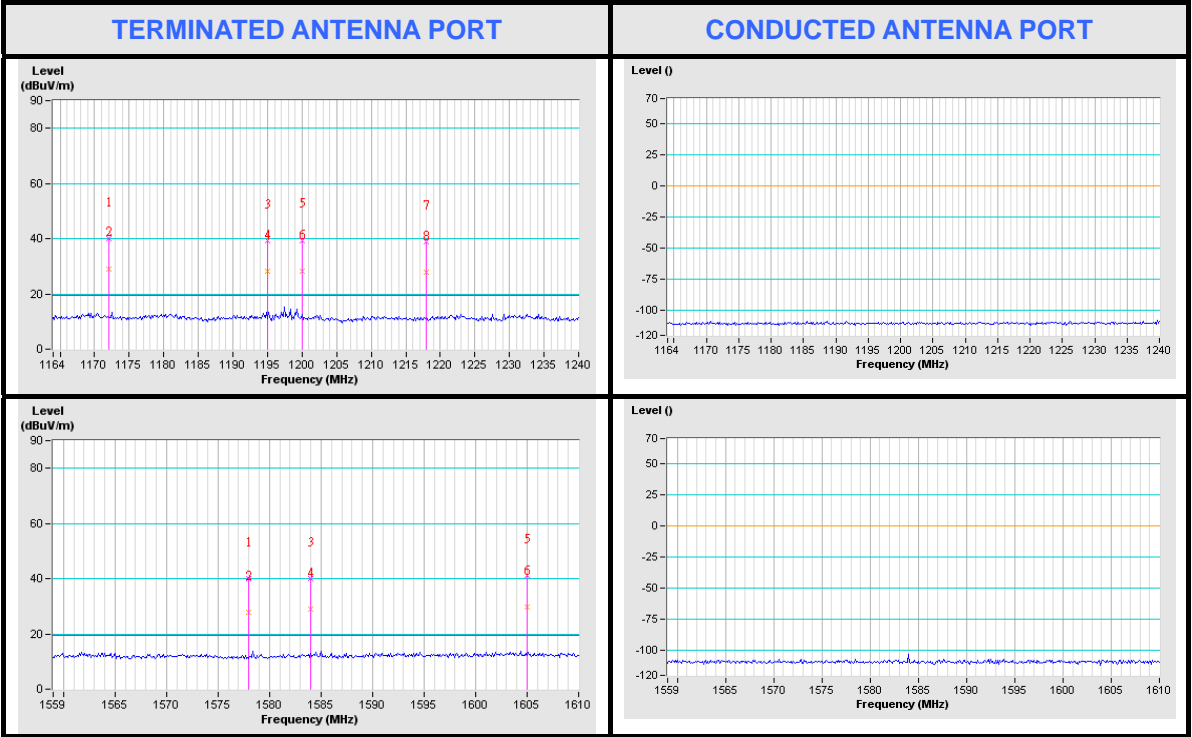

4.4 UWB BANDWIDTH MEASUREMENT

4.4.1 LIMITS OF UWB BANDWIDTH MEASUREMENT

The UWB bandwidth of a UWB system operating under the provisions of this section must be contained between 3100MHz and 10,600MHz.

4.4.2 INSTRUMENT SETUP VALUE AND MEASUREMENT DISTANCE

FREQUENCY RANGE	RESOLUTION BANDWIDTH	VIDEO BANDWIDTH	DETECTOR	MEASUREMENT DISTANCE
3,100 ~ 10,600	3MHz	10MHz	Peak	3 meters

4.4.3 TEST INSTRUMENT

Same as Item 4.2.3

4.4.4 TEST PROCEDURE

- The EUT was placed on the top of a rotating table 0.8 meters above the ground at a 3 meters semi-anechoic chamber. The table was rotated 360 degrees to determine the position of the highest radiation.
- The EUT was set 3 meters away from the interference-receiving antenna, which was mounted on the top of a variable-height antenna tower.
- The antenna is a broadband antenna, and its height is varied from one meter to four meters above the ground to determine the maximum value of the field strength. Both horizontal and vertical polarizations of the antenna are set to make the measurement.
- For each suspected emission, the EUT was arranged to its worst case and then the antenna was tuned to heights from 1 meter to 4 meters and the rotatable table was turned from 0 degrees to 360 degrees to find the maximum reading.
- The Spectrum Analyzer system was set to Peak Detect Function and Specified Bandwidth with Maximum Hold Mode.
- The UWB Bandwidth is measured at the 10dB point (F_L , F_H).

4.4.5 DEVIATION FROM TEST STANDARD

No deviation

4.4.6 TEST SETUP

Same as Item 4.2.6

4.4.7 EUT OPERATING CONDITIONS

The software provided by client to enable the EUT under transmission condition continuously.

4.4.8 TEST RESULTS

SUB-BAND	1 + 2 + 3	INPUT POWER (SYSTEM)	120Vac, 60 Hz
MODULATION TECHNOLOGY	MOFDM	ENVIRONMENTAL CONDITIONS	26deg.C, 66%RH, 991hPa
TESTED BY	Dean Wang		

F_L (MHz)	F_H (MHz)	$F_C=(F_L+F_H)/2$ (MHz)	LIMIT (MHz)	PASS/FAIL
3172.00	4728.00	3950.00	Between 3100.00 ~ 10600.00	PASS

UWB Bandwidth = $F_H - F_L = 1556\text{MHz}$

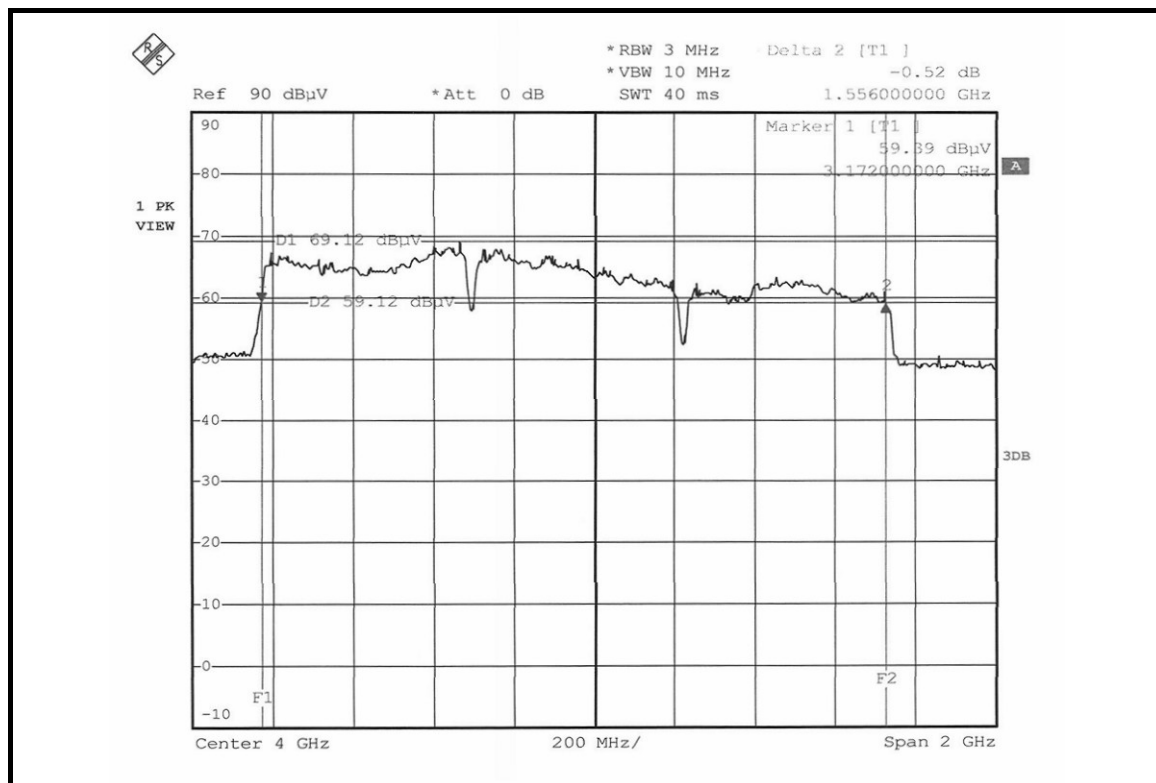



4.5 PEAK EMISSION WITHIN A 50MHz BANDWIDTH

4.5.1 LIMITS OF PEAK EMISSION

The Maximum Peak Output Power Measurement is 0dBm(RBW=50MHz)

If a resolution bandwidth other than 50 MHz is Employed, the peak EIRP limit shall be $20 \log (RBW/50)$ dBm where RBW is the resolution bandwidth in megahertz that is employed. The resolution bandwidth used to make the peak measurement was 3 MHz, resulting in a limit of -24.44 dBm

This may be converted to a peak field strength level at 3 meters using

$$E(\text{dBuV/m}) = P(\text{dBm EIRP}) + 95.2 = -24.44 + 95.2 = 70.76.$$

4.5.2 INSTRUMENT SETUP VALUE AND MEASUREMENT DISTANCE

RADIATED EMISSIONS 15.519 (e):

FREQUENCY RANGE	RESOLUTION BANDWIDTH	VIDEO BANDWIDTH	DETECTOR	MEASUREMENT DISTANCE
3,100 ~ 10,600	3MHz	10MHz	*Peak	3 meters

NOTE: *reference The Evolution of Modern UWB Technology

4.5.3 TEST INSTRUMENTS

Same as 4.2.3

4.5.4 TEST PROCEDURE

Same as 4.2.4

4.5.5 DEVIATION FROM TEST STANDARD

No deviation

4.5.6 TEST SETUP

Same as Item 4.2.6

4.5.7 EUT OPERATING CONDITIONS

Same as 4.1.6



4.5.8 TEST RESULTS

MODULATION TECHNOLOGY	MOFDM	ENVIRONMENTAL CONDITIONS	25deg. C, 65%RH, 985hPa
INPUT POWER (SYSTEM)	120Vac, 60 Hz	TESTED BY	Brad Wu

ANTENNA POLARITY & TEST DISTANCE AT 3 M (HORIZONTAL)								
No.	Freq. (MHz)	Emission Level (dBuV/m)	Limit (dBuV/m)	Margin (dB)	Antenna Height (m)	Table Angle (Degree)	Raw Value (dBuV)	Correction Factor (Db/m)
1	3668.00	56.34 PK	70.76	-14.42	1.50 H	112	21.25	35.09
2	3824.00	57.87 PK	70.76	-12.89	1.25 H	52	22.38	35.49
3	4488.00	60.56 PK	70.76	-10.20	1.00 H	139	23.06	37.50
ANTENNA POLARITY & TEST DISTANCE AT 3 M (VERTICAL)								
No.	Freq. (MHz)	Emission Level (dBuV/m)	Limit (dBuV/m)	Margin (dB)	Antenna Height (m)	Table Angle (Degree)	Raw Value (dBuV)	Correction Factor (dB/m)
1	3664.00	69.64 PK	70.76	-1.12	1.03 V	146	34.56	35.08
2	3724.00	68.18 PK	70.76	-2.58	1.01 V	58	32.94	35.24
3	4552.00	65.63 PK	70.76	-5.13	1.01 V	126	28.02	37.61



4.6 ANTENNA REQUIREMENT

4.6.1 STANDARD APPLICABLE

For intentional device, according to FCC 47 CFR Section 15.203, an intentional radiator shall be designed to ensure that no antenna other than that furnished by the responsible party shall be used with the device.

4.6.2 ANTENNA CONNECTED CONSTRUCTION

The antenna used in this product is Dipole antenna with R-SMA antenna connector. The maximum Gain of the antenna is 1.68dBi.



5 PHOTOGRAPHS OF THE TEST CONFIGURATION

Please refer to the attached file (Test Setup Photo).



6 INFORMATION ON THE TESTING LABORATORIES

We, ADT Corp., were founded in 1988 to provide our best service in EMC, Radio, Telecom and Safety consultation. Our laboratories are accredited and approved by the following approval agencies according to ISO/IEC 17025

USA	FCC, UL
Germany	TUV Rheinland
Japan	VCCI
Norway	NEMKO
Canada	INDUSTRY CANADA , CSA
R.O.C.	TAF, BSMI, NCC
Netherlands	Telefication
Singapore	GOST-ASIA(MOU)
Russia	CERTIS(MOU)

Copies of accreditation certificates of our laboratories obtained from approval agencies can be downloaded from our web site: www.adt.com.tw/index.5/phtml.
If you have any comments, please feel free to contact us at the following:

Linko EMC/RF Lab:
Tel: 886-2-26052180
Fax: 886-2-26051924

Hsin Chu EMC/RF Lab:
Tel: 886-3-5935343
Fax: 886-3-5935342

Hwa Ya EMC/RF/Safety/Telecom Lab:
Tel: 886-3-3183232
Fax: 886-3-3185050

Web Site: www.adt.com.tw

The address and road map of all our labs can be found in our web site also.



7 APPENDIX A - MODIFICATIONS RECORDERS FOR ENGINEERING CHANGES TO THE EUT BY THE LAB

No any modifications are made to the EUT by the lab during the test.

---END---