



FCC RADIO TEST REPORT

FCC ID: QLE-GME430R

Product : 2.4GHz Gyroscopic Presentation Mouse with Red Laser Pointer

Trade Name : N/A

Model Name : GME430R

Serial Model : N/A

Report No. : NTEK-2014NT0517730F

Prepared for

ATEN Technology, Inc., dba IOGEAR.

19641 Da Vinci Foothill Ranch, CA 92610 United States

Prepared by

Shenzhen NTEK Testing Technology Co., Ltd.

1/F, Building E, Fenda Science Park, Sanwei Community, Xixiang Street
Bao'an District, Shenzhen P.R. China

Tel.: +86-0755-61156588 Fax.: +86-0755-61156599

Website: www.ntek.org.cn

TEST RESULT CERTIFICATION

Applicant's name : ATEN Technology, Inc., dba IOGEAR.
Address : 19641 Da Vinci Foothill Ranch, CA 92610 United States
Manufacturer's Name..... : ATEN Technology, Inc., dba IOGEAR.
Address : 19641 Da Vinci Foothill Ranch, CA 92610 United States

Product description

Product name : 2.4GHz Gyroscopic Presentation Mouse with Red Laser Pointer
Model and/or type reference : GME430R
Serial Model : N/A
Rating(s) : DC 3V

Standards : FCC Part15.249

Test procedure ANSI C63.4-2003

This device described above has been tested by NTEK, and the test results show that the equipment under test (EUT) is in compliance with the FCC requirements. And it is applicable only to the tested sample identified in the report.

This report shall not be reproduced except in full, without the written approval of NTEK, this document may be altered or revised by NTEK, personal only, and shall be noted in the revision of the document.

Date of Test :
Date (s) of performance of tests : 17 May 2014 ~23 May 2014
Date of Issue..... : 23 May 2014
Test Result..... : **Pass**

Testing Engineer : Apple Huang
(Apple Huang)

Technical Manager : Brown Lu
(Brown Lu)

Authorized Signatory : Bill Yao
(Bill Yao)

Table of Contents

Page

1 . SUMMARY OF TEST RESULTS	4
1.1 TEST FACILITY	5
1.2 MEASUREMENT UNCERTAINTY	5
2 . GENERAL INFORMATION	6
2.1 GENERAL DESCRIPTION OF EUT	6
2.2 DESCRIPTION OF TEST MODES	8
2.3 BLOCK DIGRAM SHOWING THE CONFIGURATION OF SYSTEM TESTED	9
2.4 DESCRIPTION OF SUPPORT UNITS(CONDUCTED MODE)	10
2.5 EQUIPMENTS LIST FOR ALL TEST ITEMS	11
3 . ANTENNA REQUIREMENT	12
3.1 STANDARD REQUIREMENT	12
3.2 EUT ANTENNA	12
3.3 CONDUCTED EMISSION MEASUREMENT	13
3.3.1 POWER LINE CONDUCTED EMISSION LIMITS	13
3.3.2 TEST PROCEDURE	14
3.3.3 DEVIATION FROM TEST STANDARD	14
3.3.4 TEST SETUP	14
3.2.5 TEST RESULT	15
3.4 RADIATED EMISSION MEASUREMENT	16
3.4.1 RADIATED EMISSION LIMITS	16
3.4.2 TEST PROCEDURE	17
3.4.3 DEVIATION FROM TEST STANDARD	17
3.4.4 TEST SETUP	18
3.4.5 TEST RESULTS (BLOW 30MHZ)	20
3.4.6 TEST RESULTS (BETWEEN 30 – 1000 MHZ)	21
3.4.7 TEST RESULTS (ABOVE 1000 MHZ)	23
3.4.8 TEST RESULTS (RESTRICTED BANDS REQUIREMENTS)	29
4 . BANDWIDTH TEST	33
4.1 TEST PROCEDURE	33
4.2 DEVIATION FROM STANDARD	33
4.3 TEST SETUP	33
4.4 TEST RESULTS	34
5 . EUT TEST PHOTO	36
APPENDIX-PHOTOGRAPHS OF EUT CONSTRUCTIONAL DETAILS	

1. SUMMARY OF TEST RESULTS

Test procedures according to the technical standards:

FCC Part15, Subpart C (15.249)			
Standard Section	Test Item	Judgment	Remark
15.207	Conducted Emission	N/A	
15.203	Antenna Requirement	Pass	
15.249	Radiated Spurious Emission	Pass	
15.205	Band Edge Emission	Pass	
15.249	Occupied Bandwidth	Pass	

1.1 TEST FACILITY

NTEK Testing Technology Co., Ltd

Add. : 1/F, Building E, Fenda Science Park, Sanwei Community, Xixiang Street, Bao'an District, Shenzhen P.R. China.

FCC FRN Registration No.:238937; IC Registration No.:9270A-1

CNAS Registration No.:L5516

1.2 MEASUREMENT UNCERTAINTY

The reported uncertainty of measurement $y \pm U$, where expanded uncertainty U is based on a standard uncertainty multiplied by a coverage factor of $k=2$, providing a level of confidence of approximately **95 %**.

No.	Item	Uncertainty
1	Conducted Emission Test	$\pm 1.38\text{dB}$
2	RF power,conducted	$\pm 0.16\text{dB}$
3	Spurious emissions,conducted	$\pm 0.21\text{dB}$
4	All emissions,radiated(<1G)	$\pm 4.68\text{dB}$
5	All emissions,radiated(>1G)	$\pm 4.89\text{dB}$
6	Temperature	$\pm 0.5^\circ\text{C}$
7	Humidity	$\pm 2\%$

2. GENERAL INFORMATION

2.1 GENERAL DESCRIPTION OF EUT

Equipment	2.4GHz Gyroscopic Presentation Mouse with Red Laser Pointer	
Trade Name	N/A	
Model Name	GME430R	
Serial Model	N/A	
Model Difference	N/A	
Product Description	The EUT is a 2.4GHz Gyroscopic Presentation Mouse with Red Laser Pointer	
	Operation Frequency:	2401MHz-2480MHz
	Modulation Type:	GFSK
	Antenna Designation:	PCB Antenna
	Antenna Gain(Peak)	0 dBi
	EIRP	79.97dBuv/m@3m
Based on the application, features, or specification exhibited in User's Manual, the EUT is considered as an ITE/Computing Device. More details of EUT technical specification, please refer to the User's Manual.		
Channel List	Please refer to the Note 2.	
Adapter	N/A	

Note:

1. For a more detailed features description, please refer to the manufacturer's specifications or the User's Manual.

2.

Channel	Frequency (MHz)	Channel	Frequency (MHz)	Channel	Frequency (MHz)
01	2401	12	2422	23	2440
02	2410	13	2424	24	2441
03	2412	14	2425	25	2442
04	2413	15	2427	26	2443
05	2414	16	2428	27	2444
06	2415	17	2430	28	2445
07	2416	18	2432	29	2447
08	2417	19	2433	30	2450
09	2418	20	2434	31	2480
10	2419	21	2436		
11	2420	22	2439		

3.

Table for Filed Antenna

Ant	Brand	Model Name	Antenna Type	Connector	Gain (dBi)	NOTE
1	N/A	N/A	PCB Antenna	N/A	0	Antenna

2.2 DESCRIPTION OF TEST MODES

To investigate the maximum EMI emission characteristics generates from EUT, the test system was pre-scanning tested base on the consideration of following EUT operation mode or test configuration mode which possible have effect on EMI emission level. Each of these EUT operation mode(s) or test configuration mode(s) mentioned above was evaluated respectively.

Pretest Mode	Description
Mode 1	Link Mode

For Radiated Emission	
Final Test Mode	Description
Mode 1	Link Mode

Note:

- (1) The measurements are performed at the highest, middle, lowest available channels.
- (2) The EUT use new battery.

2.3 BLOCK DIGRAM SHOWING THE CONFIGURATION OF SYSTEM TESTED

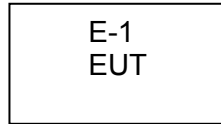

2.4 DESCRIPTION OF SUPPORT UNITS(CONDUCTED MODE)

The EUT has been tested as an independent unit together with other necessary accessories or support units. The following support units or accessories were used to form a representative test configuration during the tests.

Item	Equipment	Mfr/Brand	Model/Type No.	Series No.	Note
E-1	2.4GHz Gyroscopic Presentation Mouse with Red Laser Pointer	N/A	GME430R	N/A	EUT

Item	Shielded Type	Ferrite Core	Length	Note

Note:

- (1) The support equipment was authorized by Declaration of Confirmation.
- (2) For detachable type I/O cable should be specified the length in cm in 『Length』 column.

2.5 EQUIPMENTS LIST FOR ALL TEST ITEMS**Radiation Test equipment**

Item	Kind of Equipment	Manufacturer	Type No.	Serial No.	Calibrated until
1	Spectrum Analyzer	Agilent	E4407B	160400005	Jul. 06. 2014
2	Test Receiver	R&S	ESPI	101318	Jul. 06. 2014
3	Bilog Antenna	TESEQ	CBL6111D	31216	Jul. 06. 2014
4	50Ω Coaxial Switch	Anritsu	MP59B	6200264416	Jul. 06. 2014
5	Spectrum Analyzer	ADVANTEST	R3132	150900201	Jul. 06. 2014
6	Horn Antenna	EM	EM-AH-10180	2011071402	Jul. 06. 2014
7	Horn Ant	Schwarzbeck	BBHA 9170	9170-181	Jul. 06. 2014
8	Amplifier	EM	EM-30180	060538	Jul. 06. 2014
9	Loop Antenna	ARA	PLA-1030/B	1029	Jul. 06. 2014
10	Power Meter	R&S	NRVS	100696	Jul. 06. 2014

Conduction Test equipment

Item	Kind of Equipment	Manufacturer	Type No.	Serial No.	Calibrated until
1	Test Receiver	R&S	ESCI	101160	Jul. 06. 2014
2	LISN	R&S	ENV216	101313	Jul. 06. 2014
3	LISN	EMCO	3816/2	00042990	Jul. 06. 2014
4	50Ω Coaxial Switch	Anritsu	MP59B	6200264417	Jul. 06. 2014
5	Passive Voltage Probe	R&S	ESH2-Z3	100196	Jul. 06. 2014
6	Absorbing clamp	R&S	MOS-21	100423	Jul. 06. 2014

3. ANTENNA REQUIREMENT

3.1 STANDARD REQUIREMENT

15.203 requirement: For intentional device, according to 15.203: an intentional radiator shall be designed to ensure that no antenna other than that furnished by the responsible party shall be used with the device.

3.2 EUT ANTENNA

The EUT antenna is PCB Antenna. It comply with the standard requirement.

3.3 CONDUCTED EMISSION MEASUREMENT

3.3.1 POWER LINE CONDUCTED EMISSION Limits (Frequency Range 150KHz-30MHz)

FREQUENCY (MHz)	Class A (dBuV)		Class B (dBuV)		Standard
	Quasi-peak	Average	Quasi-peak	Average	
0.15 -0.5			66 - 56 *	56 - 46 *	CISPR
0.50 -5.0			56.00	46.00	CISPR
5.0 -30.0			60.00	50.00	CISPR

0.15 -0.5			66 - 56 *	56 - 46 *	LP002.
0.50 -5.0			56.00	46.00	LP002.
5.0 -30.0			60.00	50.00	LP002.

Note:

- (1) The tighter limit applies at the band edges.
- (2) The limit of " * " marked band means the limitation decreases linearly with the logarithm of the frequency in the range.

The following table is the setting of the receiver

Receiver Parameters	Setting
Attenuation	10 dB
Start Frequency	0.15 MHz
Stop Frequency	30 MHz
IF Bandwidth	9 kHz

3.3.2 TEST PROCEDURE

- a. The EUT was placed 0.4 meters from the horizontal ground plane with EUT being connected to the power mains through a line impedance stabilization network (LISN). All other support equipments powered from additional LISN(s). The LISN provide 50 Ohm/ 50uH of coupling impedance for the measuring instrument.
- b. Interconnecting cables that hang closer than 40 cm to the ground plane shall be folded back and forth in the center forming a bundle 30 to 40 cm long.
- c. I/O cables that are not connected to a peripheral shall be bundled in the center. The end of the cable may be terminated, if required, using the correct terminating impedance. The overall length shall not exceed 1 m.
- d. LISN at least 80 cm from nearest part of EUT chassis.
- e. For the actual test configuration, please refer to the related Item –EUT Test Photos.

3.3.3 DEVIATION FROM TEST STANDARD

No deviation

3.3.4 TEST SETUP

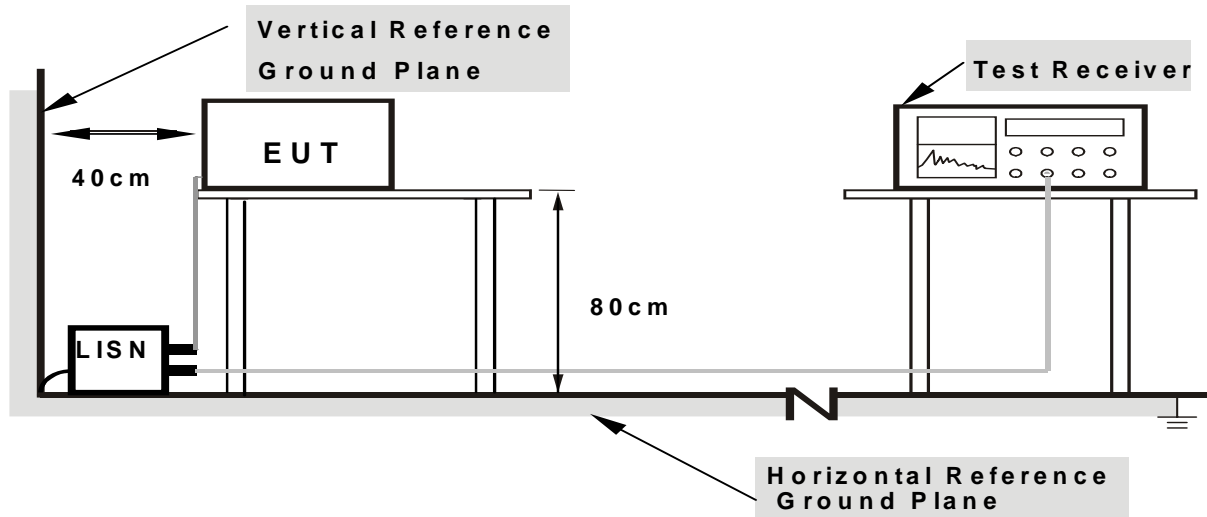

Note: 1. Support units were connected to second LISN.

2. Both of LISNs (AMN) are 80 cm from EUT and at least 80 cm from other units and other metal planes

3.2.5 TEST RESULT

EUT :	2.4GHz Gyroscopic Presentation Mouse with Red Laser Pointer	Model Name. :	GME430R
Temperature :	26 °C	Relative Humidity :	54%
Pressure :	1010hPa	Phase :	N/A
Test Voltage :	N/A	Test Mode :	N/A

3.4 RADIATED EMISSION MEASUREMENT

3.4.1 Radiated Emission Limits (FCC 15.209)

Frequencies (MHz)	Field Strength (micorvolts/meter)	Measurement Distance (meters)
0.009~0.490	2400/F(KHz)	300
0.490~1.705	24000/F(KHz)	30
1.705~30.0	30	30
Frequency (MHz)	Limit (dBuV)	
30~88	40	3
88~216	43.5	3
216~960	46	3
960 -10000	54.00	3
*902 - 928	94.00	3

Note:

- (1) The tighter limit applies at the band edges.
- (2) Emission level (dBuV/m)=20log Emission level (uV/m).
- (3) *Note: This is the limit for the fundamental frequency.

LIMITS OF RADIATED EMISSION MEASUREMENT (FCC 15.249)

Frequency of Emission (MHz)	Field Strength of fundamental ((millivolts /meter)	Field Strength of Harmonics (microvolts/meter)
902-928	50	500

Notes:

- (1) Emissions radiated outside of the specified frequency bands, except for harmonics, shall be attenuated by at least 50 dB below the level of the fundamental or to the general radiated emission limits in Section 15.209, whichever is the lesser attenuation.

Spectrum Parameter	Setting
Attenuation	Auto
Start Frequency	1000 MHz
Stop Frequency	10th carrier harmonic
RB / VB (emission in restricted band)	1MHz / 1MHz for Peak

Receiver Parameter	Setting
Attenuation	Auto
Start ~ Stop Frequency	9kHz~150kHz / RB 200Hz for QP
Start ~ Stop Frequency	150kHz~30MHz / RB 9kHz for QP
Start ~ Stop Frequency	30MHz~1000MHz / RB 120kHz for QP

3.4.2 TEST PROCEDURE

- a. The measuring distance of at 3 m shall be used for measurements at frequency up to 1GHz. For frequencies above 1GHz, any suitable measuring distance may be used.
- b. The EUT was placed on the top of a rotating table 0.8 meters above the ground at a 3m meter open area test site. The table was rotated 360 degrees to determine the position of the highest radiation.
- c. The height of the equipment or of the substitution antenna shall be 0.8 m; the height of the test antenna shall vary between 1 m to 4 m.
- d. The initial step in collecting conducted emission data is a spectrum analyzer peak detector mode pre-scanning the measurement frequency range. Significant peaks are then marked and then Quasi Peak detector mode re-measured.
- e. If the Peak Mode measured value compliance with and lower than Quasi Peak Mode Limit, the EUT shall be deemed to meet QP Limits and then no additional QP Mode measurement performed.
- f. For the actual test configuration, please refer to the related Item –EUT Test Photos.

Note:

Both horizontal and vertical antenna polarities were tested and performed pretest to three orthogonal axis. The worst case emissions were reported

3.4.3 DEVIATION FROM TEST STANDARD

No deviation

3.4.4 TEST SETUP

(A) Radiated Emission Test-Up Frequency Below 30MHz

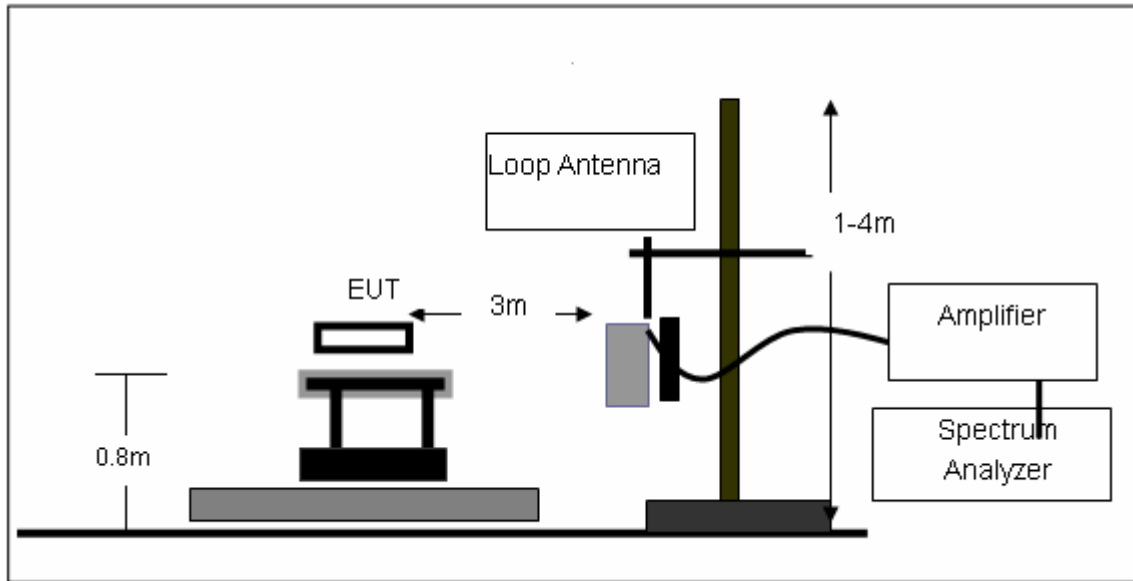

(B) Radiated Emission Test-Up Frequency 30MHz~1GHz

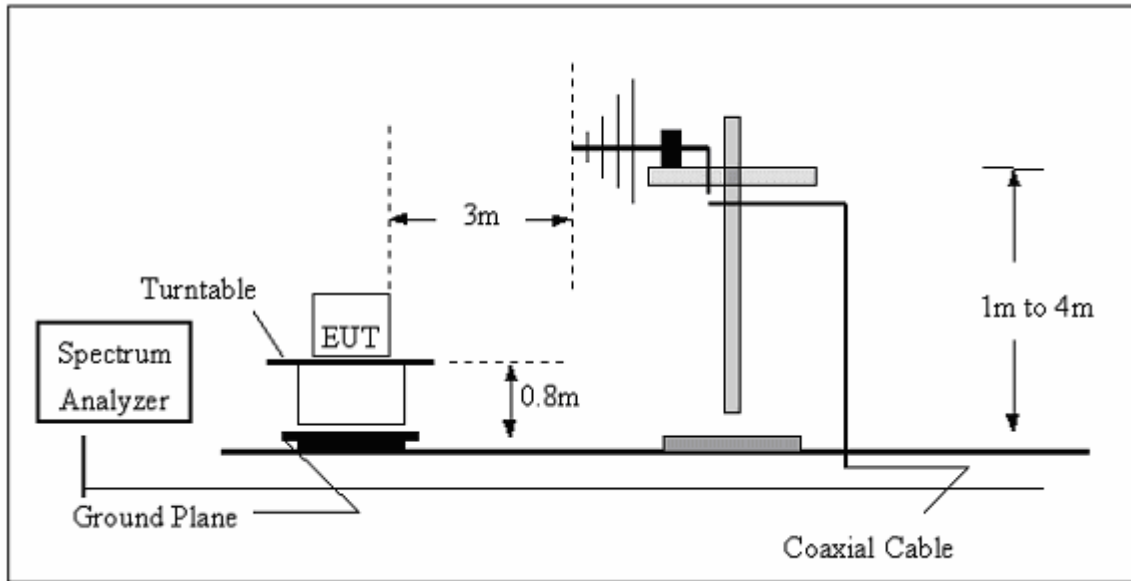

(C) Radiated Emission Test-Setup Frequency Above 1GHz

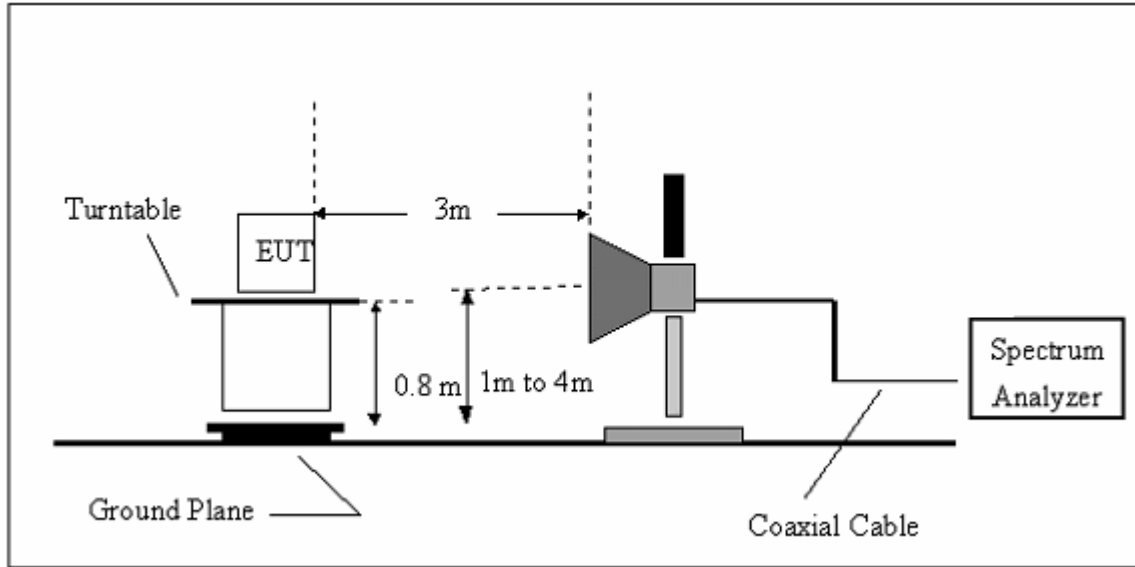

3.4.5 TEST RESULTS (BLOW 30MHz)

EUT :	2.4GHz Gyroscopic Presentation Mouse with Red Laser Pointer	Model Name. :	GME430R
Temperature :	20 °C	Relative Humidity :	48%
Pressure :	1010 hPa	Test Voltage :	DC 3V
Test Mode :	TX	Polarization :	--

Freq.	Reading	Limit	Margin	State
(MHz)	(dBuV/m)	(dBuV/m)	(dB)	P/F
--	--	--	--	PASS
--	--	--	--	PASS

NOTE:

The amplitude of spurious emissions which are attenuated by more than 20dB below the permissible value has no need to be reported.

Distance extrapolation factor = $20 \log (\text{specific distance}/\text{test distance})(\text{dB})$;

Limit line = specific limits(dBuv) + distance extrapolation factor.

3.4.6 TEST RESULTS (BETWEEN 30 – 1000 MHZ)

EUT :	2.4GHz Gyroscopic Presentation Mouse with Red Laser Pointer	Model Name :	GME430R
Temperature :	20 °C	Relative Humidity :	48%
Pressure :	1010 hPa	Test Voltage :	DC 3V
Test Mode :	TX	Polarization :	Vertical

Frequency (MHz)	Meter Reading (dBµV)	Factor (dB)	Emission Level (dBµV/m)	Limits (dBµV/m)	Margin (dB)	Detector Type
30.5305	2.69	18.07	20.76	40.00	-19.24	QP
68.6310	5.75	5.76	11.51	40.00	-28.49	QP
134.0882	3.93	11.97	15.90	43.50	-27.60	QP
259.2338	2.48	14.24	16.72	46.00	-29.28	QP
303.5437	3.61	14.58	18.19	46.00	-27.81	QP
550.9479	4.34	21.92	26.26	46.00	-19.74	QP

Remark:

- Factor = Antenna Factor + Cable Loss – Pre-amplifier.

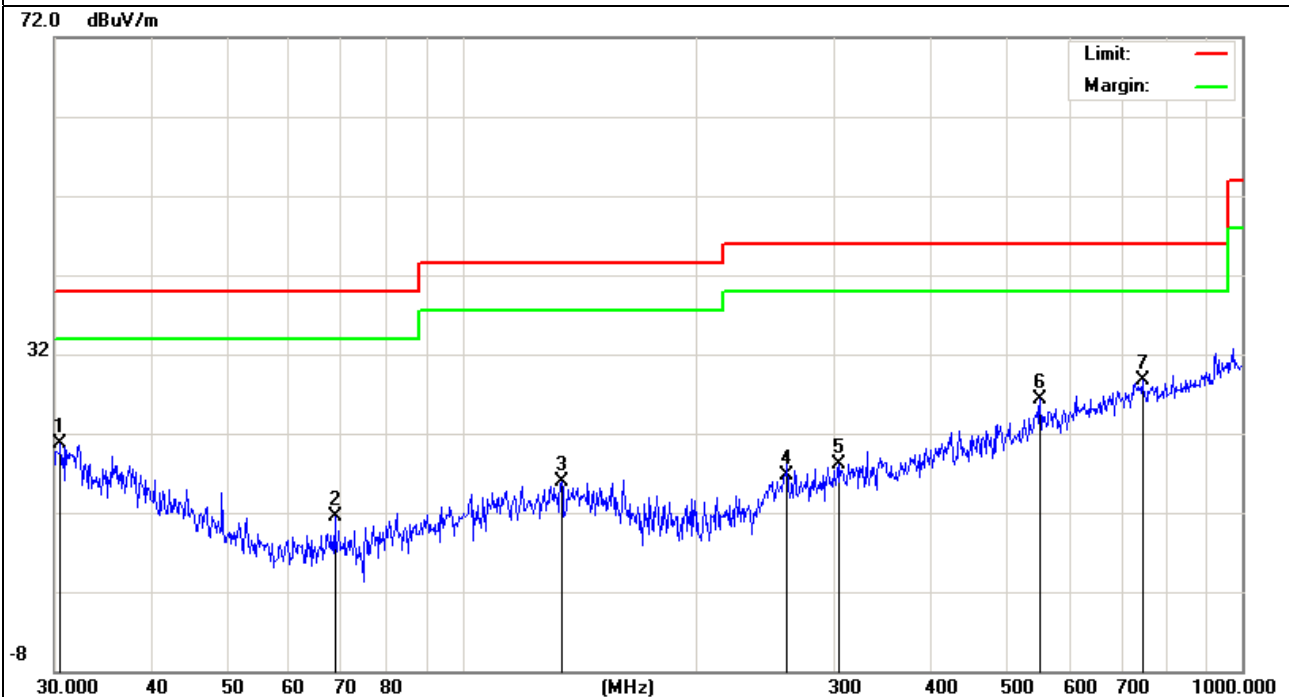

EUT :	2.4GHz Gyroscopic Presentation Mouse with Red Laser Pointer	Model Name :	GME430R
Temperature :	20 °C	Relative Humidity :	48%
Pressure :	1010 hPa	Test Voltage :	DC 3V
Test Mode :	TX	Polarization :	Horizontal

Frequency (MHz)	Meter Reading (dBµV)	Factor (dB)	Emission Level (dBµV/m)	Limits (dBµV/m)	Margin (dB)	Detector Type
30.8535	5.61	17.92	23.53	40.00	-16.47	QP
119.0180	5.87	11.75	17.62	43.50	-25.88	QP
146.8876	6.14	11.87	18.01	43.50	-25.49	QP
261.9753	6.44	14.15	20.59	46.00	-25.41	QP
550.9480	6.23	21.92	28.15	46.00	-17.85	QP
774.1584	8.48	24.10	32.58	46.00	-13.42	QP

Remark:

1. Factor = Antenna Factor + Cable Loss – Pre-amplifier.

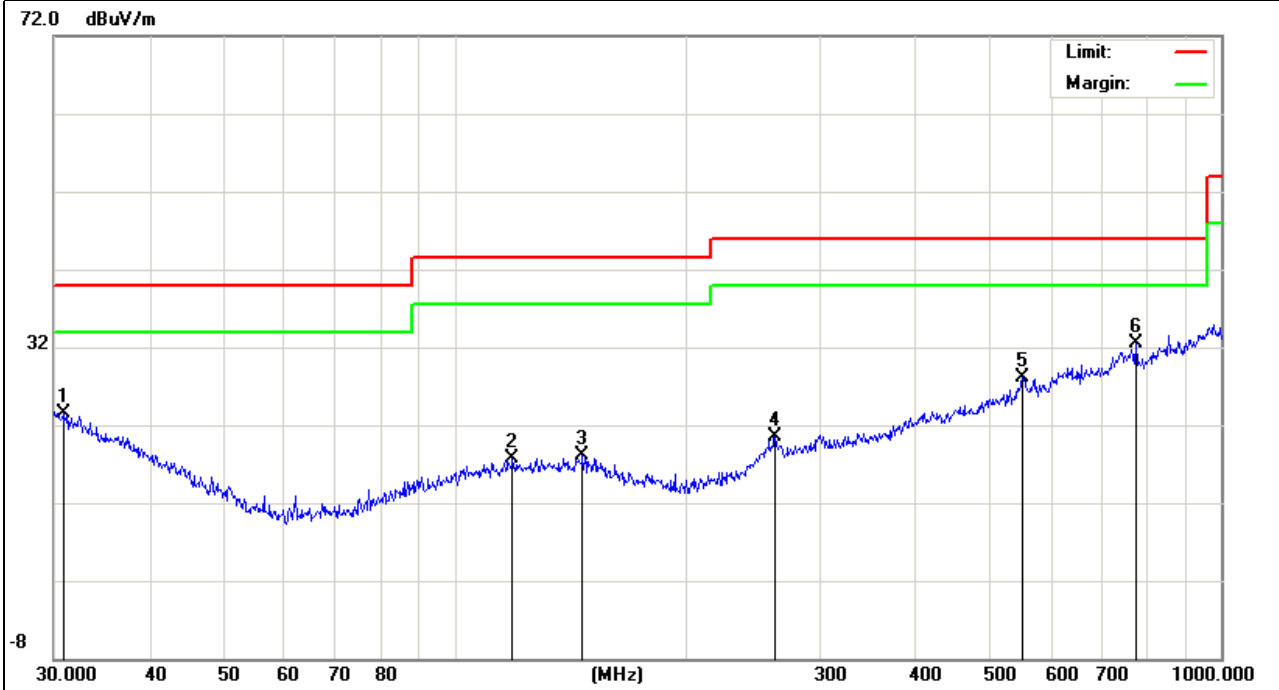

3.4.7 TEST RESULTS (ABOVE 1000 MHZ)

EUT :	2.4GHz Gyroscopic Presentation Mouse with Red Laser Pointer	Model Name :	GME430R
Temperature :	20 °C	Relative Humidity :	48%
Pressure :	1010 hPa	Test Voltage :	DC 3V
Test Mode :	TX-2401MHz	Polarization :	Horizontal

Frequency (MHz)	Meter Reading (dBμV)	Factor (dB)	Emission Level (dBμV/m)	Limits (dBμV/m)	Margin (dB)	Detector Type
2401.000	92.88	-12.99	79.89	114.0	-34.11	PK
2401.000	78.47	-12.99	65.48	94.0	-8.52	AV
4802.000	45.38	-3.65	41.73	74.0	-52.27	PK
4802.000	40.76	-3.65	37.11	54.0	-16.89	AV

Remark:
Factor = Antenna Factor + Cable Loss – Pre-amplifier.

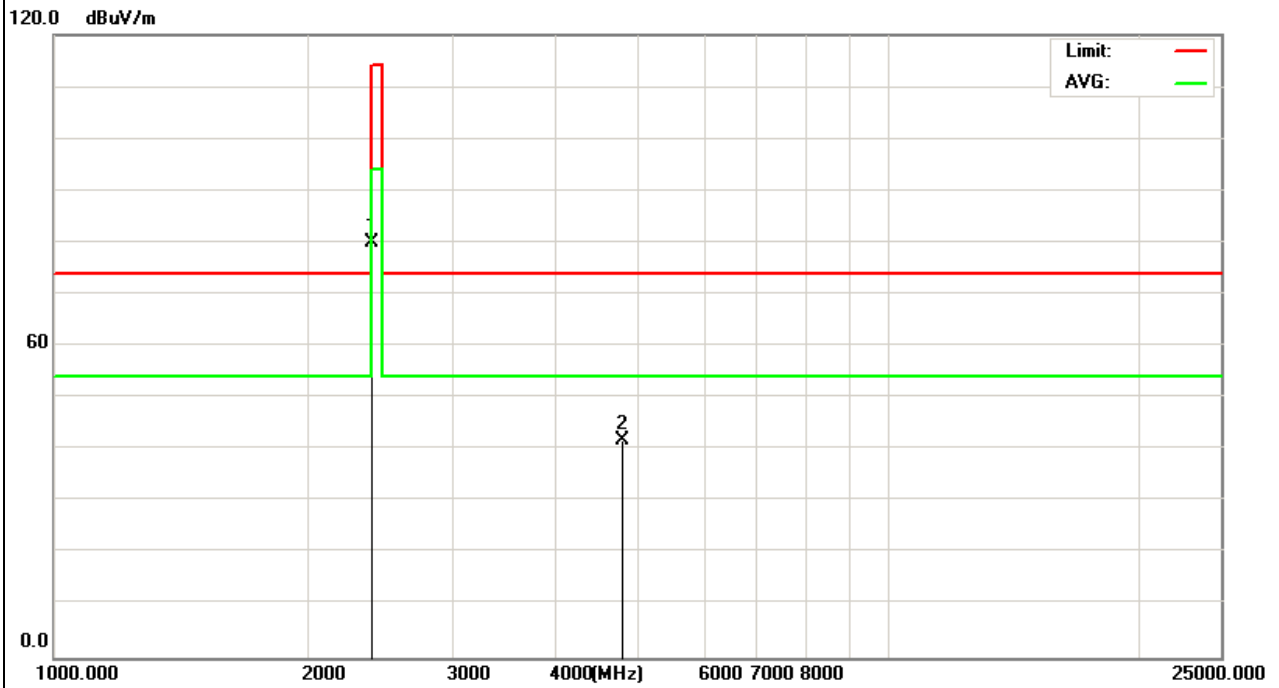

EUT :	2.4GHz Gyroscopic Presentation Mouse with Red Laser Pointer	Model Name :	GME430R
Temperature :	20 °C	Relative Humidity :	48%
Pressure :	1010 hPa	Test Voltage :	DC 3V
Test Mode :	TX-2401MHz	Polarization :	Vertical

Frequency (MHz)	Meter Reading (dBμV)	Factor (dB)	Emission Level (dBμV/m)	Limits (dBμV/m)	Margin (dB)	Detector Type
2401.000	91.52	-12.99	78.53	114.0	-35.47	PK
2401.000	80.75	-12.99	67.76	94.0	-6.24	AV
4804.500	45.27	-3.64	41.63	74.0	-52.37	PK
4804.500	41.76	-3.64	38.12	54.0	-15.88	AV

Remark:
 Factor = Antenna Factor + Cable Loss – Pre-amplifier.

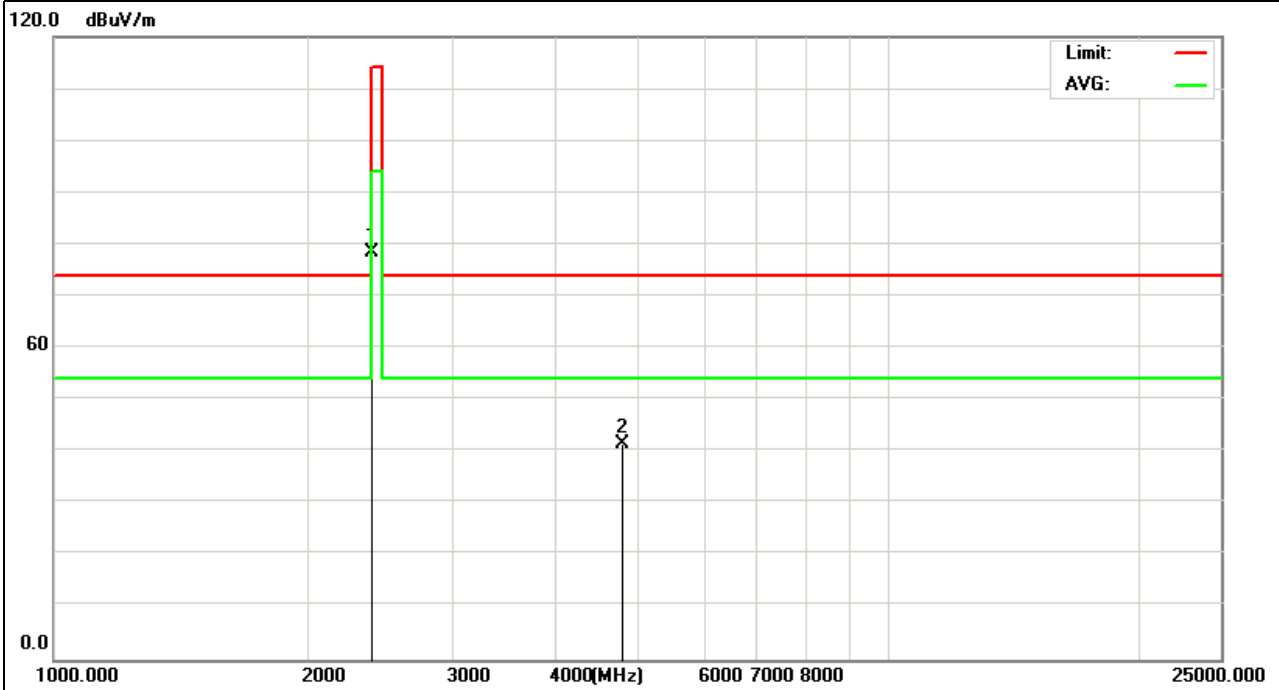

EUT :	2.4GHz Gyroscopic Presentation Mouse with Red Laser Pointer	Model Name :	GME430R
Temperature :	20 °C	Relative Humidity :	48%
Pressure :	1010 hPa	Test Voltage :	DC 3V
Test Mode :	TX-2440MHz	Polarization :	Horizontal

Frequency (MHz)	Meter Reading (dBμV)	Factor (dB)	Emission Level (dBμV/m)	Limits (dBμV/m)	Margin (dB)	Detector Type
2440.000	92.35	-12.94	79.41	114.0	-34.59	PK
2440.000	77.96	-12.99	64.97	94.0	-9.03	AV
4880.000	46.27	-3.67	42.60	74.0	-31.40	PK
4880.000	42.74	-3.64	39.1	54.0	-14.9	AV

Remark:
Factor = Antenna Factor + Cable Loss – Pre-amplifier.

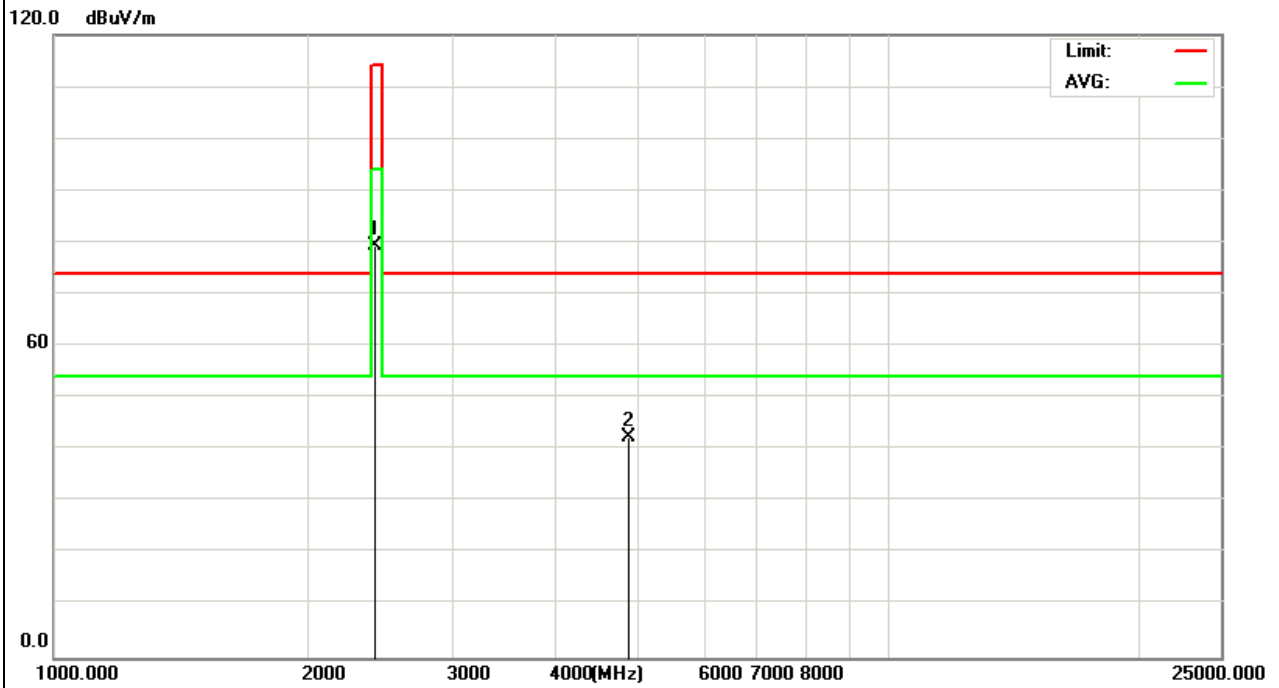

EUT :	2.4GHz Gyroscopic Presentation Mouse with Red Laser Pointer	Model Name :	GME430R
Temperature :	20 °C	Relative Humidity :	48%
Pressure :	1010 hPa	Test Voltage :	DC 3V
Test Mode :	TX-2440MHz	Polarization :	Vertical

Frequency (MHz)	Meter Reading (dBμV)	Factor (dB)	Emission Level (dBμV/m)	Limits (dBμV/m)	Margin (dB)	Detector Type
2440.000	92.18	-12.94	79.24	114.0	-34.76	PK
2440.000	79.74	-12.94	66.8	94.0	-7.2	AV
4880.000	44.76	-3.67	41.09	74.0	-52.91	PK
4880.000	38.86	-3.67	35.19	54.0	-18.81	AV

Remark:
 Factor = Antenna Factor + Cable Loss – Pre-amplifier.

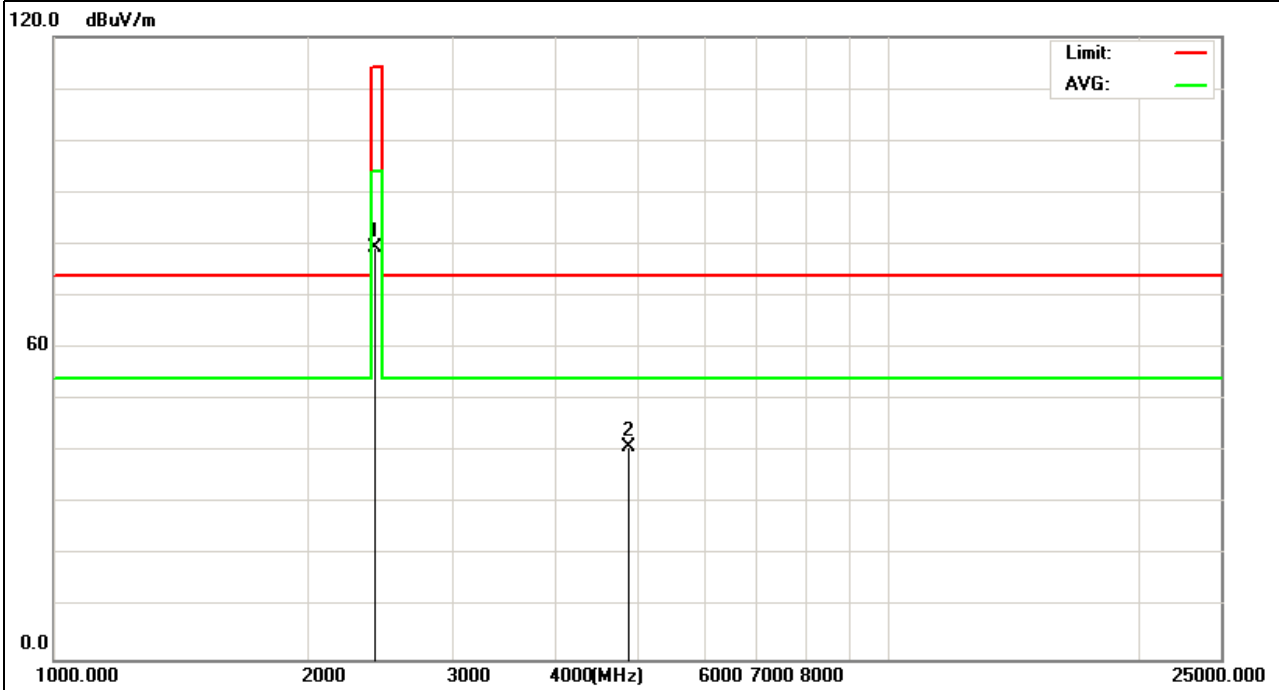

EUT :	2.4GHz Gyroscopic Presentation Mouse with Red Laser Pointer	Model Name :	GME430R
Temperature :	20 °C	Relative Humidity :	48%
Pressure :	1010 hPa	Test Voltage :	DC 3V
Test Mode :	TX-2480MHz	Polarization :	Horizontal

Frequency (MHz)	Meter Reading (dBμV)	Factor (dB)	Emission Level (dBμV/m)	Limits (dBμV/m)	Margin (dB)	Detector Type
2480.000	92.76	-12.79	79.97	114.0	-34.03	PK
2480.000	88.75	-12.79	75.96	94.0	1.96	AV
4960.000	43.58	-3.59	39.99	74.0	-54.01	PK
4960.000	39.76	-3.59	36.17	54.0	-17.83	AV

Remark:
 Factor = Antenna Factor + Cable Loss – Pre-amplifier.

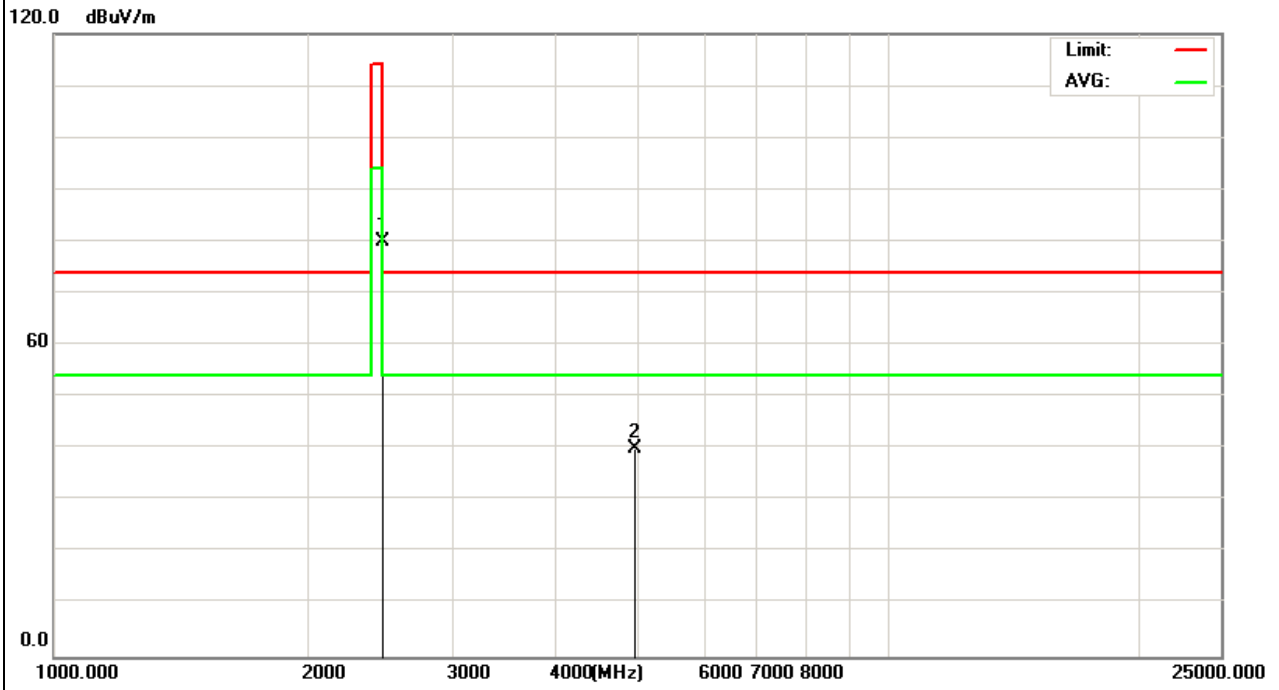

EUT :	2.4GHz Gyroscopic Presentation Mouse with Red Laser Pointer	Model Name :	GME430R
Temperature :	20 °C	Relative Humidity :	48%
Pressure :	1010 hPa	Test Voltage :	DC 3V
Test Mode :	TX-2480MHz	Polarization :	Vertical

Frequency (MHz)	Meter Reading (dBμV)	Factor (dB)	Emission Level (dBμV/m)	Limits (dBμV/m)	Margin (dB)	Detector Type
2480.000	91.34	-12.79	78.55	114.0	-35.45	PK
2480.000	76.86	-12.79	64.07	94.0	-9.93	AV
4960.000	43.0	-3.59	39.41	74.0	-54.59	PK
4960.000	38.87	-3.59	35.28	54.0	-18.72	AV

Remark:
 Factor = Antenna Factor + Cable Loss – Pre-amplifier.

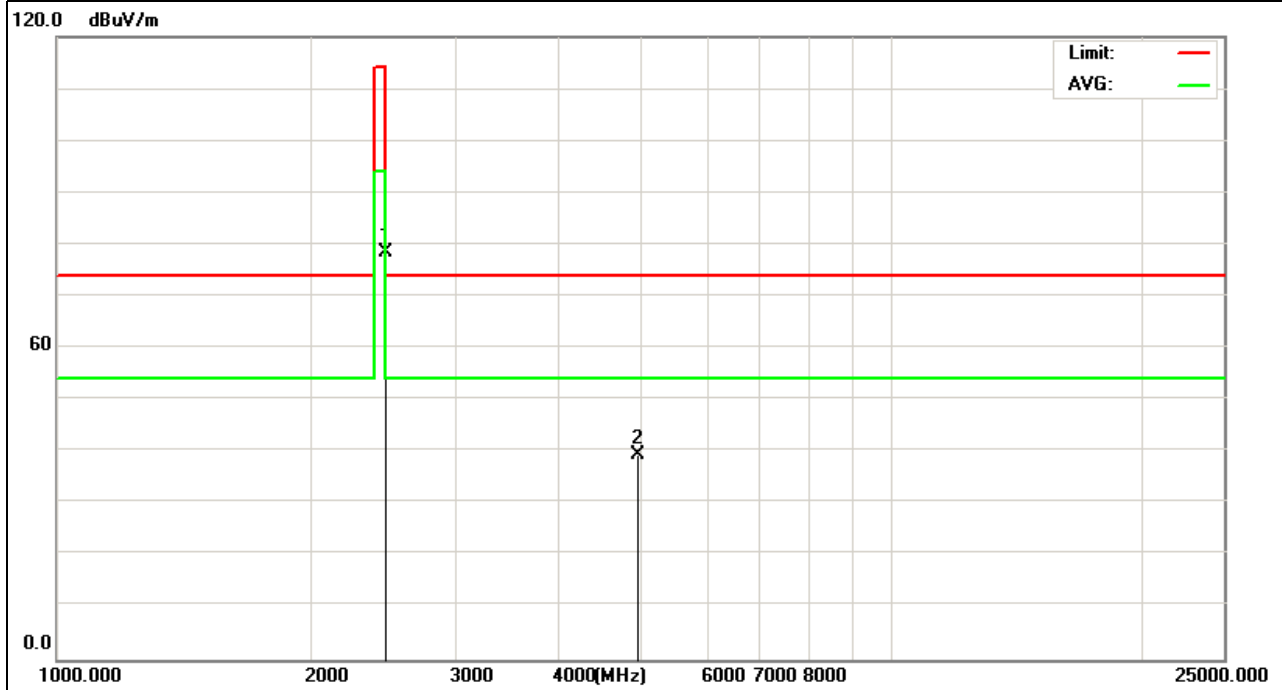

3.4.8 TEST RESULTS (RESTRICTED BANDS REQUIREMENTS)

EUT :	2.4GHz Gyroscopic Presentation Mouse with Red Laser Pointer	Model Name :	GME430R
Temperature :	20 °C	Relative Humidity :	48%
Pressure :	1010 hPa	Test Voltage :	DC 3V
Test Mode :	TX-2401MHz	Polarization :	Horizontal

Frequency (MHz)	Meter Reading (dBµV)	Factor (dB)	Emission Level (dBµV/m)	Limits (dBµV/m)	Margin (dB)	Detector Type
2400.00	29.99	-12.99	17.00	74.00	-57.00	peak

Remark:
Factor = Antenna Factor + Cable Loss – Pre-amplifier.

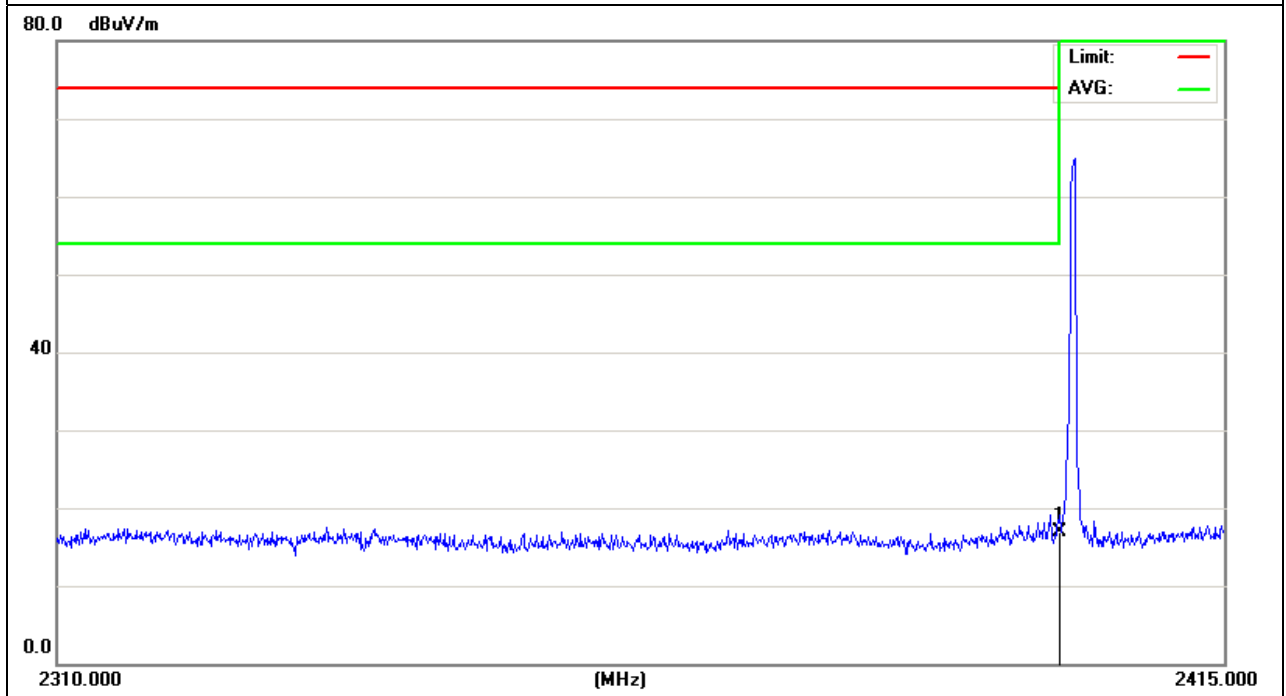

EUT :	2.4GHz Gyroscopic Presentation Mouse with Red Laser Pointer	Model Name :	GME430R
Temperature :	20 °C	Relative Humidity :	48%
Pressure :	1010 hPa	Test Voltage :	DC 3V
Test Mode :	TX-2401MHz	Polarization :	Vertical

Frequency (MHz)	Meter Reading (dBμV)	Factor (dB)	Emission Level (dBμV/m)	Limits (dBμV/m)	Margin (dB)	Detector Type
2400.00	35.29	-12.99	22.30	74.00	-51.70	peak

Remark:
 Factor = Antenna Factor + Cable Loss – Pre-amplifier.

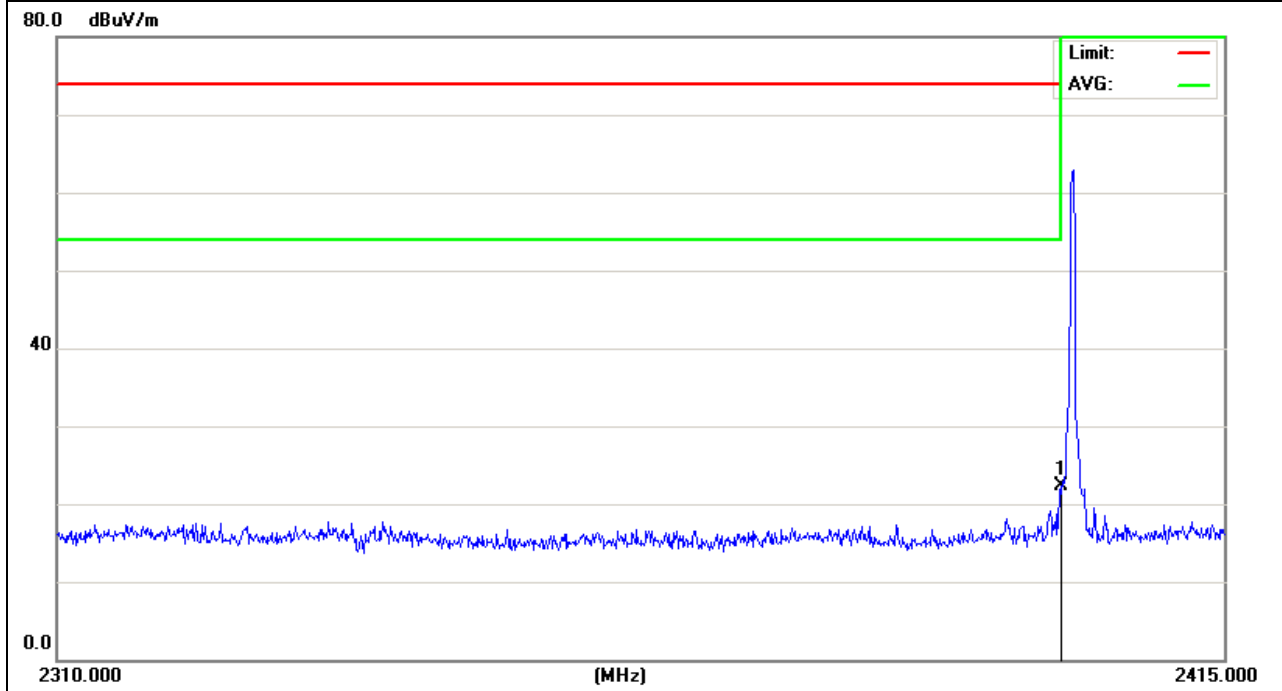

EUT :	2.4GHz Gyroscopic Presentation Mouse with Red Laser Pointer	Model Name :	GME430R
Temperature :	20 °C	Relative Humidity :	48%
Pressure :	1010 hPa	Test Voltage :	DC 3V
Test Mode :	TX-2480MHz	Polarization :	Horizontal

Frequency (MHz)	Meter Reading (dBμV)	Factor (dB)	Emission Level (dBμV/m)	Limits (dBμV/m)	Margin (dB)	Detector Type
2483.50	29.08	-12.78	16.30	74.00	-57.70	peak

Remark:
Factor = Antenna Factor + Cable Loss – Pre-amplifier.

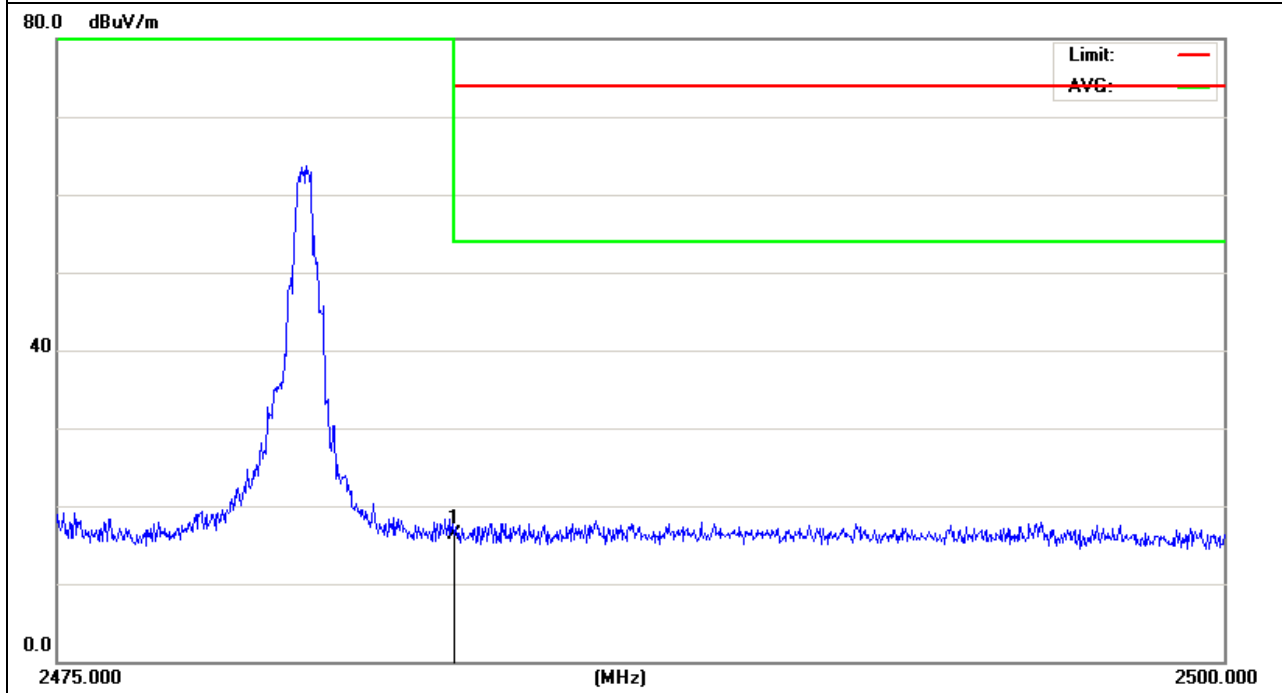

EUT :	2.4GHz Gyroscopic Presentation Mouse with Red Laser Pointer	Model Name :	GME430R
Temperature :	20 °C	Relative Humidity :	48%
Pressure :	1010 hPa	Test Voltage :	DC 3V
Test Mode :	TX-2480MHz	Polarization :	Vertical

Frequency (MHz)	Meter Reading (dBμV)	Factor (dB)	Emission Level (dBμV/m)	Limits (dBμV/m)	Margin (dB)	Detector Type
2483.50	28.72	-12.78	15.94	74.00	-58.06	peak

Remark:
 Factor = Antenna Factor + Cable Loss – Pre-amplifier.

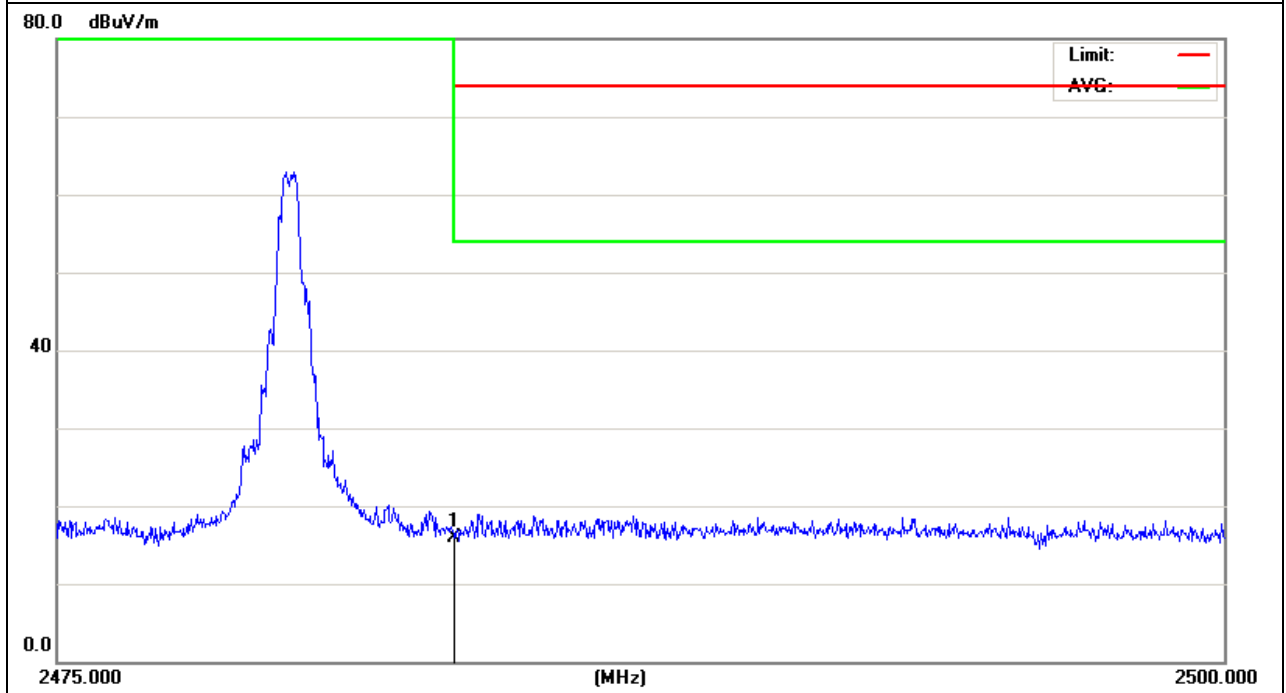

4. BANDWIDTH TEST

4.1 TEST PROCEDURE

- a. The EUT was directly connected to the spectrum analyzer and antenna output port as show in the block diagram below,
- b. Spectrum Setting : RBW= 100KHz, VBW \geq RBW, Sweep time = Auto.

4.2 DEVIATION FROM STANDARD

No deviation.

4.3 TEST SETUP



4.4 TEST RESULTS

EUT :	2.4GHz Gyroscopic Presentation Mouse with Red Laser Pointer	Model Name :	GME430R
Temperature :	26 °C	Relative Humidity :	53%
Pressure :	1020 hPa	Test Power :	DC 3V
Test Mode :	TX		

Frequency (MHz)	20 dBc Bandwidth (MHz)	99% Bandwidth (MHz)
2401	0.492	0.435
2440	0.433	0.405
2480	0.444	0.405

The Lowest Channel:2401MHz

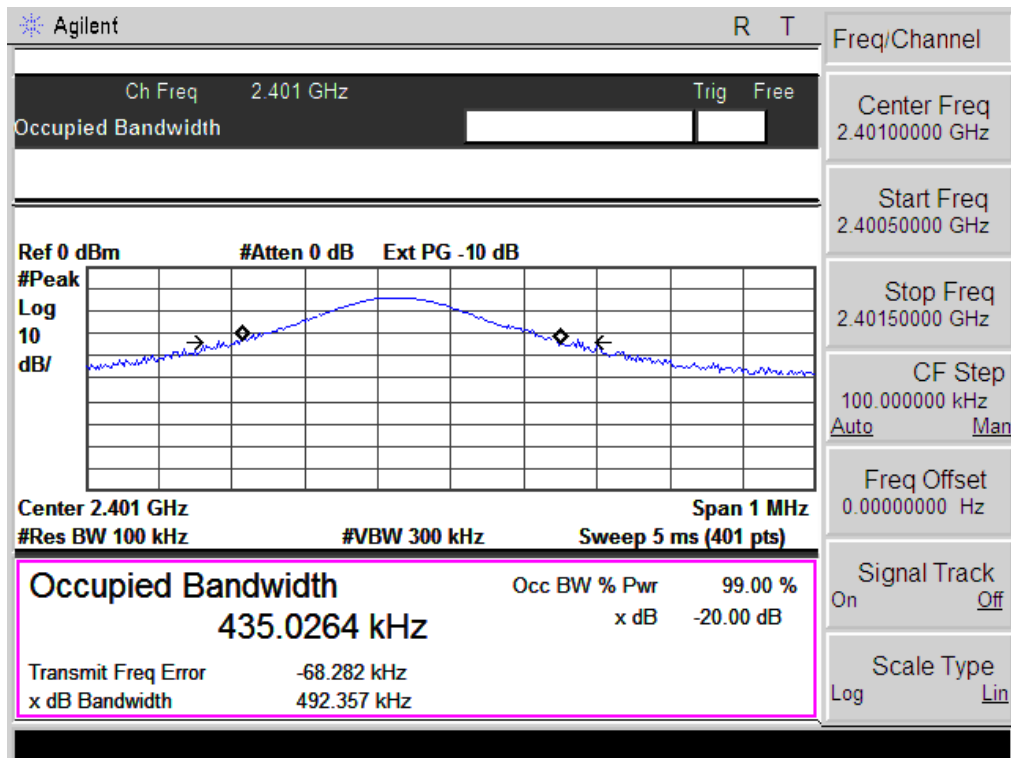

The Middle Channel: 2440MHz

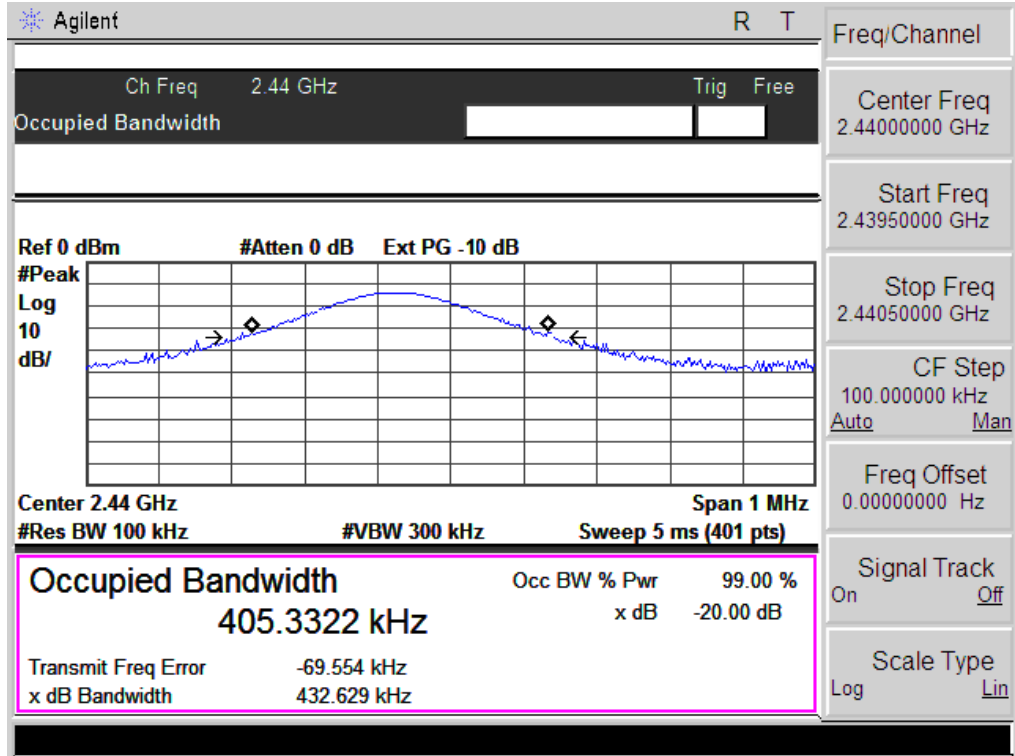

The HIGH Channel: 2480MHz

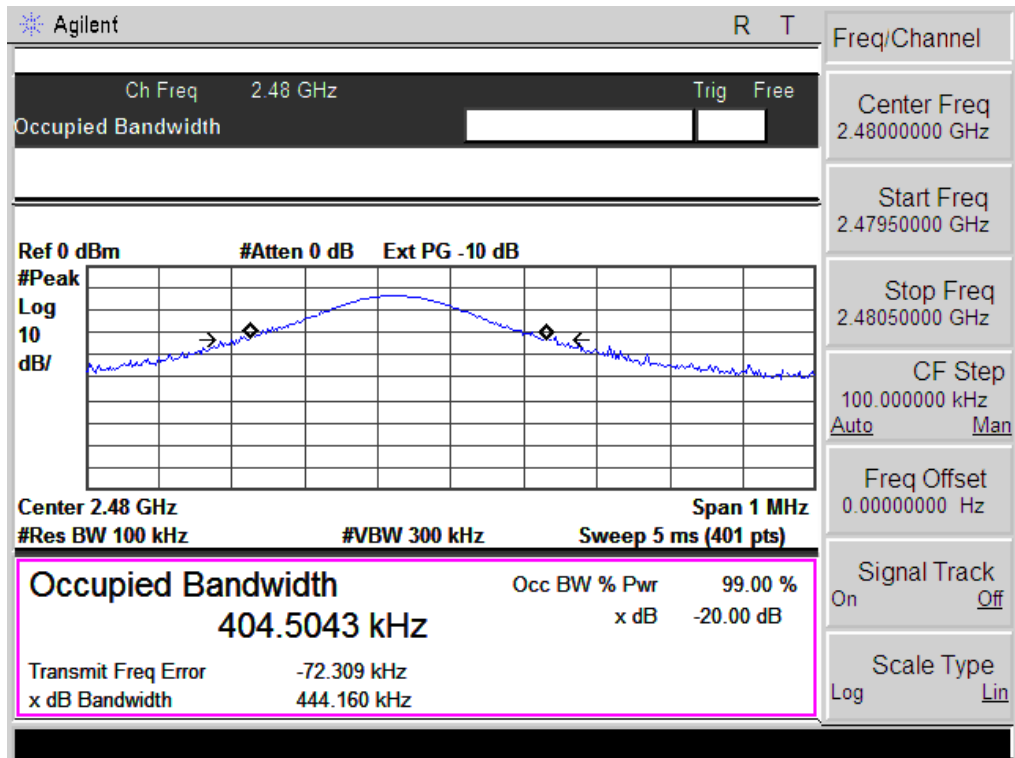

5. EUT TEST PHOTO

Radiated Measurement Photos

